

Multimedia Projector

MODEL **PLC-SU22N**

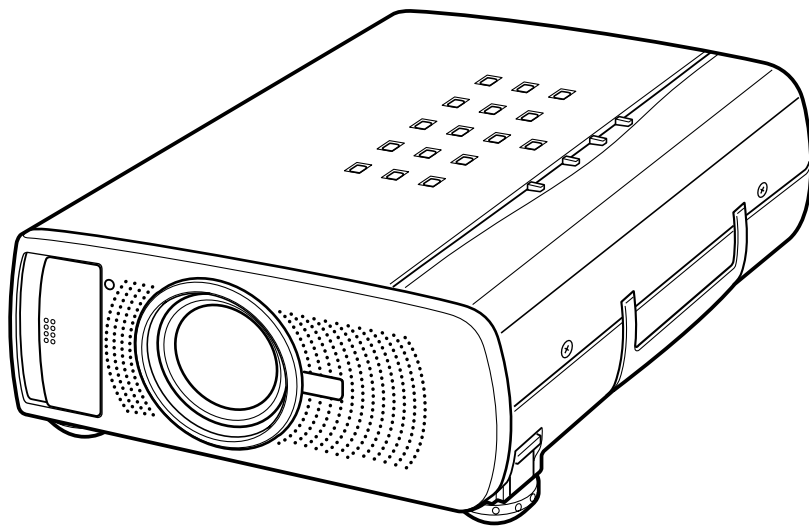

Owner's Manual

INFORMATION TO THE USER

NOTE : This equipment has been tested and found to comply with the limits for a Class A digital device, pursuant to Part 15 of FCC Rules. These limits are designed to provide reasonable protection against harmful interference when the equipment is operated in a commercial environment. This equipment generates, uses, and can radiate radio frequency energy and, if not installed and used in accordance with the instruction manual, may cause harmful interference to radio communications. Operation of this equipment in a residential area is likely to cause harmful interference in which case the user will be required to correct the interference at his own expense.

TO THE OWNER

As the owner of a new Multimedia Projector, you are probably eager to try out your new projector. Before you do, we suggest that you spend a little time reading this manual to familiarize yourself with the operating procedures so that you will receive maximum satisfaction from the many features included in your new projector. This owner's manual will acquaint you with your projector's features. Reading it will help us too. Through the years, we have found that many service requests were not caused by problems with our projectors. They were caused by problems that could have been prevented, if the owner had followed the instructions in the manual. You can often correct operating problems yourself. If your projector fails to work properly, see "TROUBLESHOOTING" section on pages 44 ~ 45 and try the solution marked for each problem.

SAFETY PRECAUTIONS

WARNING:

TO REDUCE THE RISK OF FIRE OR ELECTRIC SHOCK, DO NOT EXPOSE THIS APPLIANCE TO RAIN OR MOISTURE.

This Projector has a grounding-type AC line plug. This is a safety feature to be sure that the plug will fit into the power outlet. Do not try to defeat this safety feature.

This projector produces intense light from the projection lens. Do not stare directly into the lens as possible eye damage could result. Be especially careful that children do not stare directly into the beam.

The Remote Control Unit, supplied to this projector, emits the laser beam as the Laser Pointer function from the Laser Light Window while pressing the LASER button (for 1 minute). Do not look into the Laser Light Window or shine the laser beam on yourself or other people. Eye damage may result.

This projector should be set in the way indicated. If not, it may result in fire hazard.

If the projector will not be used for an extended time, unplug the projector from the power outlet.

READ AND KEEP THIS OWNER'S MANUAL FOR LATER USE.



CAUTION
RISK OF ELECTRIC SHOCK
DO NOT OPEN



CAUTION : TO REDUCE THE RISK OF ELECTRIC SHOCK, DO NOT REMOVE COVER (OR BACK). NO USER-SERVICEABLE PARTS INSIDE EXCEPT LAMP REPLACEMENT. REFER SERVICING TO QUALIFIED SERVICE PERSONNEL.



THIS SYMBOL INDICATES THAT DANGEROUS VOLTAGE CONSTITUTING A RISK OF ELECTRIC SHOCK IS PRESENT WITHIN THIS UNIT.



THIS SYMBOL INDICATES THAT THERE ARE IMPORTANT OPERATING AND MAINTENANCE INSTRUCTIONS IN THE OWNER'S MANUAL WITH THIS UNIT.

IMPORTANT SAFETY INSTRUCTIONS

All the safety and operating instructions should be read before the product is operated.

Read all of the instructions given here and retain them for later use. Unplug this projector from AC power supply before cleaning. Do not use liquid or aerosol cleaners. Use a damp cloth for cleaning.

Do not use attachments not recommended by the manufacturer as they may cause hazards.

Do not place this projector on an unstable cart, stand, or table. The projector may fall, causing serious injury to a child or adult, and serious damage to the projector. Use only with a cart or stand recommended by the manufacturer, or sold with the projector. Wall or shelf mounting should follow the manufacturer's instructions, and should use a mounting kit approved by the manufacturer.

Do not expose this unit to rain or use near water... for example, in a wet basement, near a swimming pool, etc...

Slots and openings in the back and bottom of the cabinet are provided for ventilation, to insure reliable operation of the equipment and to protect it from overheating.

The openings should never be covered with cloth or other materials, and the bottom opening should not be blocked by placing the projector on a bed, sofa, rug, or other similar surface. This projector should never be placed near or over a radiator or heat register.

This projector should not be placed in a built-in installation such as a book case unless proper ventilation is provided.

This projector should be operated only from the type of power source indicated on the marking label. If you are not sure of the type of power supplied, consult your authorized dealer or local power company.

Do not overload wall outlets and extension cords as this can result in fire or electric shock. Do not allow anything to rest on the power cord. Do not locate this projector where the cord may be damaged by persons walking on it.

Never push objects of any kind into this projector through cabinet slots as they may touch dangerous voltage points or short out parts that could result in a fire or electric shock. Never spill liquid of any kind on the projector.

Do not attempt to service this projector yourself as opening or removing covers may expose you to dangerous voltage or other hazards. Refer all servicing to qualified service personnel.

Unplug this projector from wall outlet and refer servicing to qualified service personnel under the following conditions:

- When the power cord or plug is damaged or frayed.
- If liquid has been spilled into the projector.
- If the projector has been exposed to rain or water.

- If the projector does not operate normally by following the operating instructions. Adjust only those controls that are covered by the operating instructions as improper adjustment of other controls may result in damage and will often require extensive work by a qualified technician to restore the projector to normal operation.
- If the projector has been dropped or the cabinet has been damaged.
- When the projector exhibits a distinct change in performance-this indicates a need for service.

When replacement parts are required, be sure the service technician has used replacement parts specified by the manufacturer that have the same characteristics as the original part. Unauthorized substitutions may result in fire, electric shock, or injury to persons.

Upon completion of any service or repairs to this projector, ask the service technician to perform routine safety checks to determine that the projector is in safe operating condition.

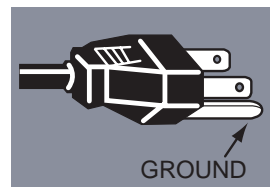

This projector is equipped with a grounding type AC line plug. Should you be unable to insert the plug into the outlet, contact your electrician. Do not defeat the safety purpose of this grounding type plug.

Follow all warnings and instructions marked on the projectors.

For added protection to the projector during a lightning storm, or when it is left unattended and unused for long periods of time, unplug it from the wall outlet. This will prevent damage due to lightning and power line surges.



An appliance and cart combination should be moved with care. Quick stops, excessive force, and uneven surfaces may cause the appliance and cart combination to overturn.

If the projector is to be built into a compartment or similarly enclosed, the minimum distances must be maintained. Do not cover the ventilation slot on the projector. Heat build-up can reduce the service life of your projector, and can also be dangerous.

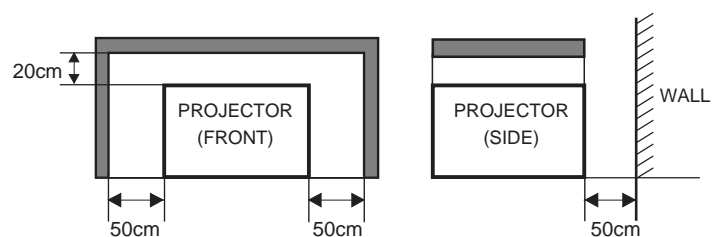

TABLE OF CONTENTS

FEATURES AND DESIGN	5	COMPUTER MODE	23
PREPARATION	6	SELECTING COMPUTER MODE	23
NAME OF EACH PART OF THE PROJECTOR	6	SELECTING COMPUTER SYSTEM	23
SETTING-UP THE PROJECTOR	7	PC ADJUSTMENT	24
POSITIONING THE PROJECTOR	7	COMPATIBLE COMPUTER SPECIFICATION	26
ADJUSTABLE FEET	7	PICTURE IMAGE ADJUSTMENT	27
CONNECTING THE AC POWER CORD	8	PICTURE POSITION ADJUSTMENT	28
VENTILATION	8	PICTURE SCREEN ADJUSTMENT	29
MOVING THE PROJECTOR	9	VIDEO MODE	30
CONNECTING THE PROJECTOR	10	SELECTING VIDEO MODE	30
TERMINALS OF THE PROJECTOR	10	SELECTING COLOR SYSTEM	30
CONNECTING TO THE VIDEO EQUIPMENT	11	PICTURE SCREEN ADJUSTMENT	30
CONNECTING TO THE COMPUTER	12	PICTURE IMAGE ADJUSTMENT	31
BEFORE OPERATION	14	MCI MODE	32
OPERATION OF THE REMOTE CONTROL	14	OPERATING THE PC CARD SLOT	32
LASER POINTER FUNCTION	14	SELECTING MCI MODE	33
REMOTE CONTROL BATTERIES INSTALLATION	15	SHOW THE DATA IN THE MEMORY CARD	34
TOP CONTROLS AND INDICATORS	16	WRITE DATA INTO THE MEMORY CARD	35
OPERATING ON-SCREEN MENU	17	PICTURE IMAGE ADJUSTMENT	36
HOW TO OPERATE THE ON-SCREEN MENU	17	PICTURE POSITION ADJUSTMENT	36
FLOW OF ON-SCREEN MENU	17	PICTURE SCREEN ADJUSTMENT	37
MENU BAR	18	SMART MEDIA AND PC CARD ADAPTER	38
BASIC OPERATION	20	SETTING	40
TURNING ON / OFF THE PROJECTOR	20	SETTING MENU	40
ADJUSTING THE IMAGE	21	SETTING LANGUAGE	40
ZOOM ADJUSTMENT	21	APPENDIX	41
FOCUS ADJUSTMENT	21	OPERATING WIRELESS MOUSE	41
KEYSTONE ADJUSTMENT	21	MAINTENANCE	42
NO SHOW FUNCTION	22	TEMPERATURE WARNING INDICATOR	42
PICTURE FREEZE FUNCTION	22	AIR FILTER CARE AND CLEANING	42
SOUND ADJUSTMENT	22	CLEANING THE PROJECTION LENS	42
SOUND VOLUME ADJUSTMENT	22	LAMP REPLACEMENT	43
SOUND MUTE ADJUSTMENT	22	LAMP REPLACEMENT MONITOR TIMER	43
		TROUBLESHOOTING	44
		TECHNICAL SPECIFICATIONS	46

TRADEMARKS

- Apple, Macintosh, and PowerBook are trademarks or registered trademarks of Apple Computer, Inc.
- IBM and PS/2 are trademarks or registered trademarks of International Business Machines, Inc.
- Windows and PowerPoint are registered trademarks of Microsoft Corporation.
- Each name of corporations or products in the owner's manual is a trademark or a registered trademark of its respective corporation.

FEATURES AND DESIGN

This Multimedia Projector is designed with the most advanced technology for portability, durability, and ease of use. The projector utilizes built-in multimedia features, a palette of 16.77 million colors, and matrix liquid crystal display (LCD) technology.

◆ Compatibility

This projector is compatible with many different types of personal computers and video devices, including;

- IBM-compatible computers, including laptops, up to 1024 x 768 resolution.
- Apple Macintosh and PowerBook computers up to 1024 x 768 resolution.
- Various video equipment using any of the world wide video standards, including NTSC, NTSC4.43, SECAM, PAL, PAL-M and PAL-N.

◆ Image Resolution

Picture Image of the computer is projected in the resolution of 800 x 600 and it is provided just as appearing on your computer's monitor. Screen resolutions between 800 x 600 and 1024 x 768 are compressed to 800 x 600, and this projector cannot display screen resolutions above 1024 x 768. If your computer's screen resolution is higher than 1024 x 768, reset it to a lower resolution before you connect the projector.

◆ Portability

This projector is quite compact in size and weight. Having a sophisticated shape like an attaché case with a retractable carrying handle, the projector will help you make powerful presentation wherever you go.

◆ Automatic Multiscanning System

This projector automatically tune to the most personal computers currently distributed by simply connecting. It is free from complicated adjustments to project picture images from Computer.

◆ Multilanguage Menu Display

Operation menu is displayed in; English, Deutsch, Français, Italiano, Español, or Japanese

◆ PC CARD SLOT

This projector has the PC CARD SLOT for easier presentation. Pictures can be projected just by inserting a memory card including image data and the presentation data can be edited by the software "Media Card Imager" (supplied) easily. Refer to the pages 32 ~ 39 and the Owner's Manual for Media Card imager for operations.

◆ Laser Pointer Function

The Remote Control Unit of this projector has the Laser Pointer function providing convenience and smartness for your presentations.

◆ Other Features

This projector has Motor Zoom/Focus, No Show, Picture Freeze, Keystone and Mute functions. And the Air Pad Remote Control is equipped.

◆ Accessories

This projector comes with the parts listed below. Check to make sure all are included. If any parts are missing, contact to a sales dealer.

- Owner's Manual.
- AC Power Cord.
- Wireless Remote Control Unit.
- Batteries for Remote Control Unit.
- VGA Cable.
- Control Cable for PS/2 Port.
- Media Card Imager for Windows 95 (CD-ROM) and Owner's Manual for this software.
- SmartMedia and PC Card Adapter.
- Lens Cover.
- Dust Cover.

PREPARATION

NAME OF EACH PART OF THE PROJECTOR

FRONT OF THE CABINET

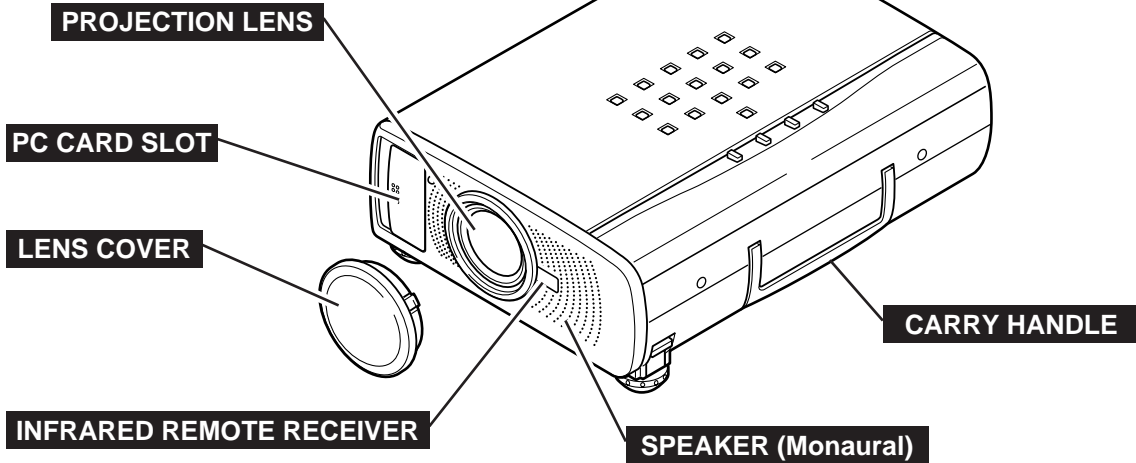

BACK OF THE CABINET

EXHAUST VENT



HOT AIR EXHAUSTED !

Air blown from the exhaust vent is hot. When using or installing the projector, following attention should be taken.

- Do not put a flammable object near this part.
- Keep heat-sensitive objects away from the exhaust vent.
- Do not touch this part especially screws and metallic parts. This part will become hot while the projector is used.

POWER CORD CONNECTOR

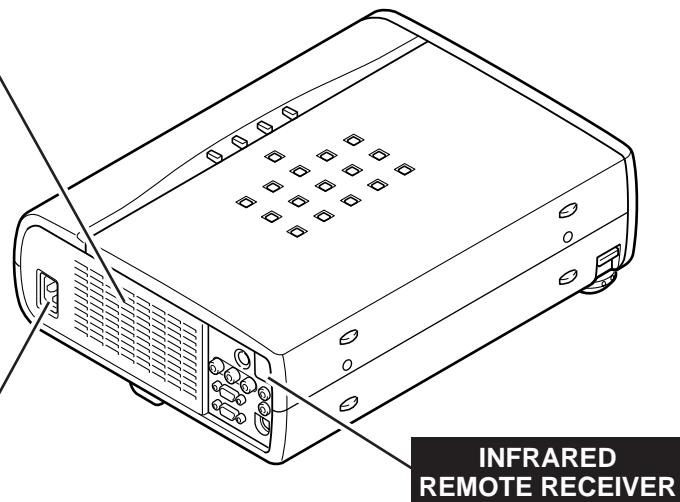

BOTTOM OF THE CABINET

AIR INTAKE VENTS

These Air Intake Vents should not be blocked.

LAMP COVER

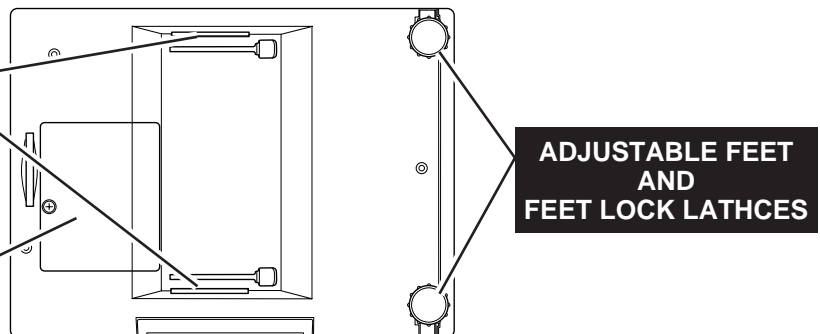

SETTING-UP THE PROJECTOR

POSITIONING THE PROJECTOR

- This projector is basically designed to project on a flat projection surface.
- The projector can be focused from 4.6'(1.4m) ~ 35.4'(10.8m).
- Refer to the figure below to adjust the screen size.

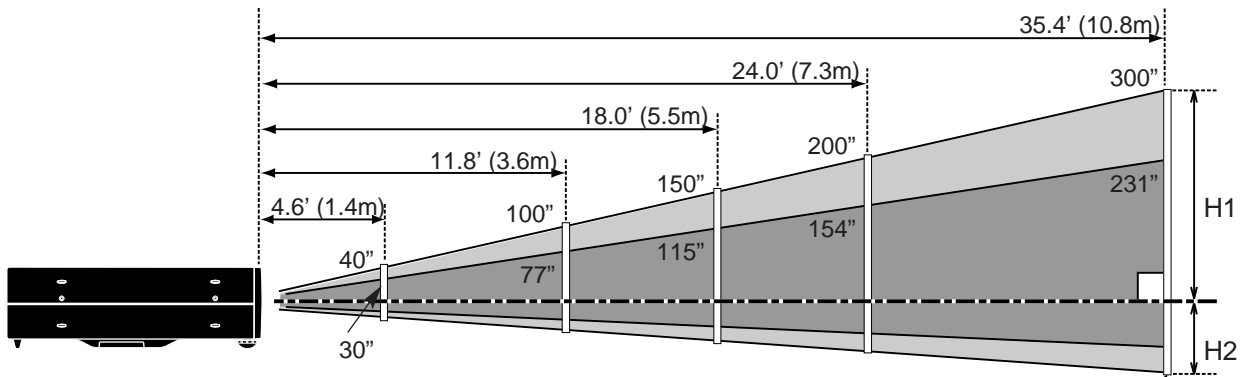

Screen Size (W x H) mm	30"	60"	100"	150"	200"	300"
Height (H1)	17.1"(435mm)	34.3"(870mm)	57.1"(1451mm)	85.7"(2177mm)	114.3"(2903mm)	171.4"(4354mm)
Height (H2)	0.9"(22mm)	1.7"(44mm)	2.9"(73mm)	4.3"(109mm)	5.7"(145mm)	8.6"(218mm)

ROOM LIGHT

The brightness in the room has a great influence on the picture quality. It is recommended to limit ambient lighting in order to provide the best image.

ADJUSTABLE FEET

Picture tilt and projection angle can be adjusted by rotating the ADJUSTABLE FEET. Projection angle can be adjusted to 10 degrees.

- 1 Lift the front of the projector and pull the FEET LOCK LATCHES on both sides of the projector.
- 2 Release the FEET LOCK LATCHES to lock the ADJUSTABLE FEET and rotate the ADJUSTABLE FEET for fine tune of the position and the tilt.
- 3 To shorten the ADJUSTABLE FEET, lift the front of the projector and pull and undo the FEET LOCK LATCHES.

The position and the keystone distortion of the image can be also adjusted with the Menu Operation. (Refer to P 21, 29, 30 and 37.)

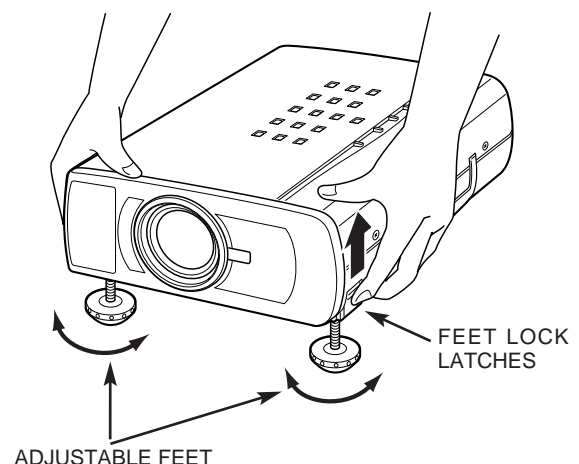

CONNECTING THE AC POWER CORD

This projector uses nominal input voltages of 100-120 V AC. The projector automatically selects the correct input voltage. It is designed to work with single-phase power systems having a grounded neutral conductor. To reduce the risk of electrical shock, do not plug into any other type of power system.

Consult your authorized dealer or service station if you are not sure of the type of power supply in use.

Connect the projector with the peripheral equipment before turning the projector on. (Refer to pages 10 ~ 13 for connection.)



CAUTION

For safety, unplug the AC Power Cord when the appliance is not used.

When this projector is connected to the outlet with the AC Power Cord, the appliance is in Stand-by Mode and consumes a little electric power.

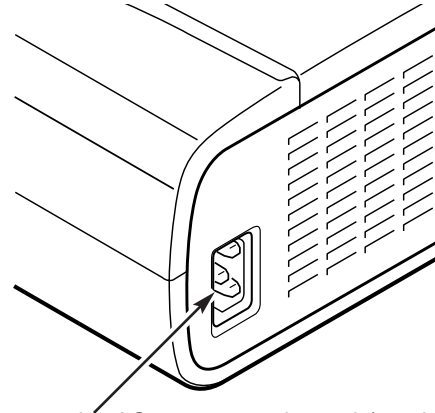

Connect the AC power supply cord (provided) to the projector.

The socket-outlet must be near this equipment and must be easily accessible.

Projector side (Female)

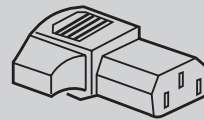

AC outlet side (Male)

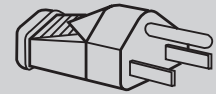

VENTILATION

This projector is equipped cooling fans for protection from overheating. Pay attention to the following to ensure the ventilation and avoid a possible risk of fire and malfunction.

- Do not cover the vent slot.
- Keep the rear grill at least one meter away from any object.
- Make sure that there is no object on both sides of the projector. Those obstacles may prevent the projector from taking the cooling air through the side Air Intake Vent Slots.

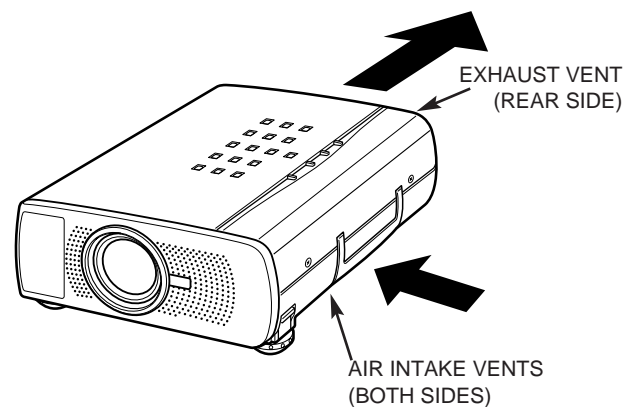

MOVING THE PROJECTOR

Use the Carry Handle when moving the Projector.
When moving the projector, replace the lens cover and rotate the feet fully clockwise (to shorten the feet) to prevent from damage to the lens and the cabinet.

When this projector is not used for the extended period, replace the lens cover, tuck the Adjustable Feet and apply the dust cover supplied to this projector.

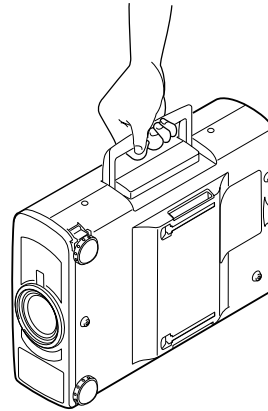

CAUTION IN CARRYING OR TRANSPORTING THE PROJECTOR

- Do not drop or give a shock to the projector, otherwise damages or malfunctions may result.
- When carrying the projector, use a carrying case recommended by Sanyo.
- Do not transport the projector by using a courier or transport service in an unsuitable transport case. This may cause damage to the projector. To transport the projector through a courier or transport service, use a case recommended by Sanyo.
- For carrying or transportation cases, contact a Sanyo authorized dealer.

CONNECTING THE PROJECTOR

TERMINALS OF THE PROJECTOR

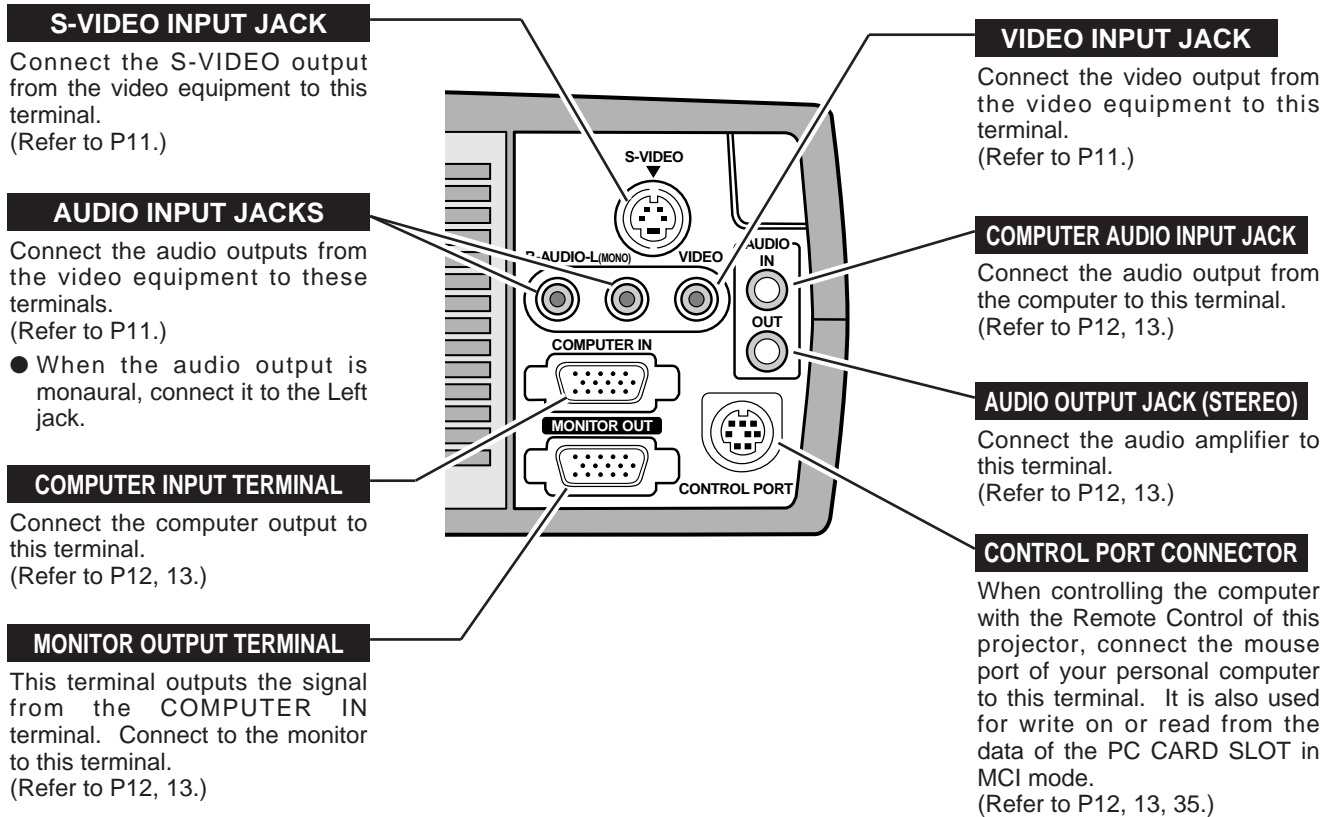

COMPUTER INPUT / MONITOR OUTPUT TERMINAL

Terminal : HDB15-PIN

Connect the display output terminal of the computer to COMPUTER INPUT with the VGA Cable (supplied). And connect the monitor to MONITOR OUTPUT with the monitor cable (not supplied). When connecting the Macintosh computer, the MAC/VGA Adapter (not supplied) is required.

Pin Configuration

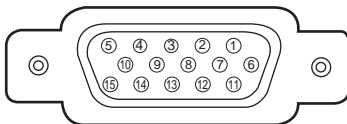

1	Red Input	9	Non Connect
2	Green Input	10	Ground (Vert.sync.)
3	Blue Input	11	Sense 0
4	Sense 2	12	Sense 1
5	Ground (Horiz.sync.)	13	Horiz. sync.
6	Ground (Red)	14	Vert. sync.
7	Ground (Green)	15	Reserved
8	Ground (Blue)		

CONTROL PORT CONNECTOR

Terminal : Mini DIN 8-PIN

Connect control port (PS/2, Serial or ADB port) on your computer to this terminal with the Control Cable (the Control Cable for PS/2 port is supplied).

Pin Configuration

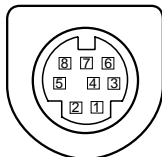

	PS/2	Serial	ADB
1	----	R X D	----
2	CLK	----	ADB
3	DATA	----	----
4	GND	GND	GND
5	----	RTS	----
6	----	T X D	----
7	GND	GND	----
8	----	GND	GND

CONNECTING TO THE VIDEO EQUIPMENT



Used cables for connection

- VIDEO CABLE *
- S-VIDEO CABLE *
- AUDIO CABLE (stereo) *

* These cables are not supplied with this projector.

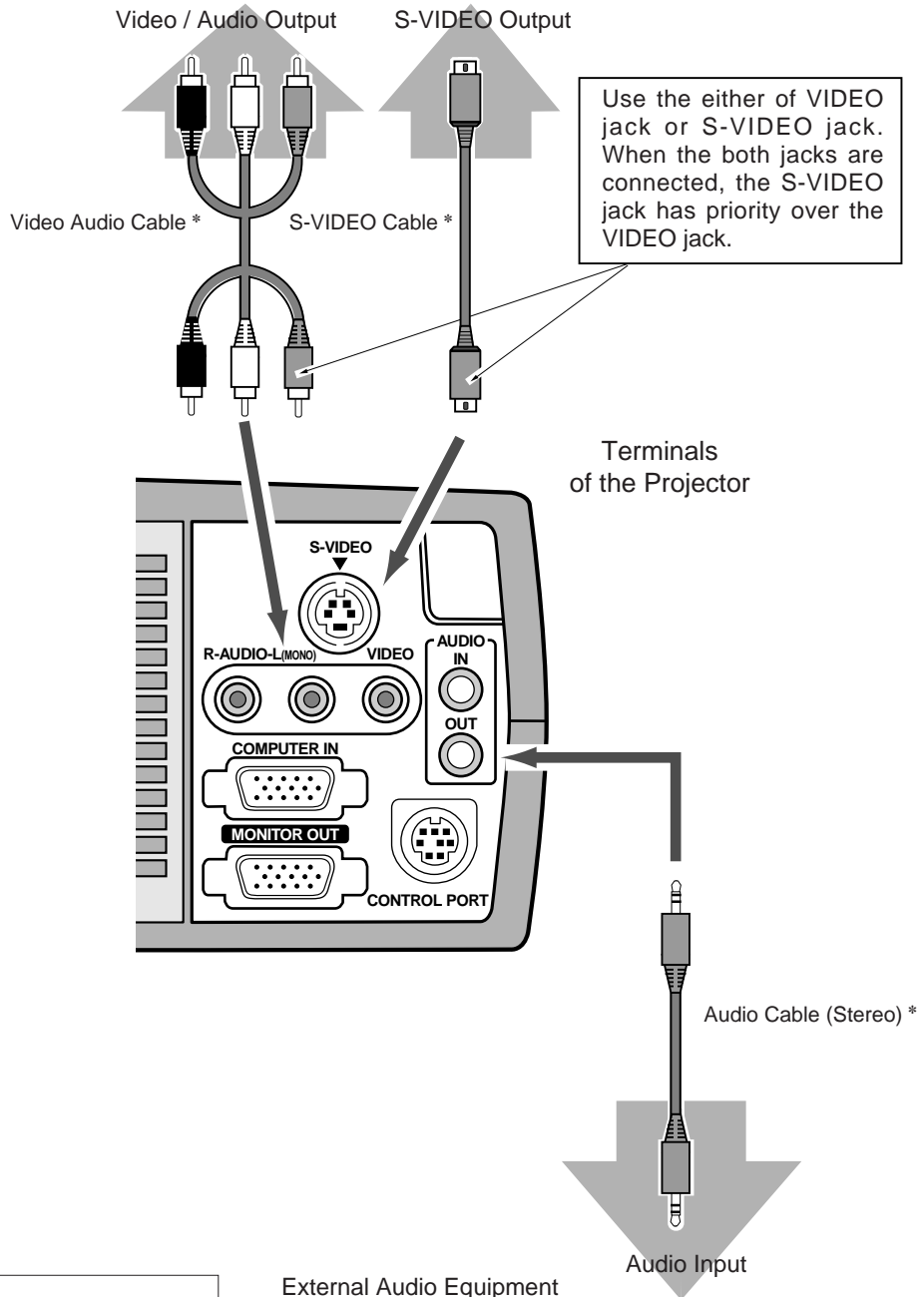

NOTE :
 When connecting the cable, the power cords of both the projector and the external equipment should be disconnected from AC outlet. Turn the projector and peripheral equipment on before the computer is switched on.

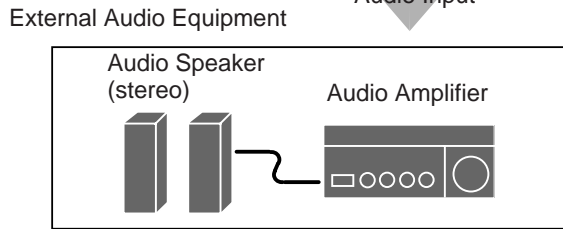

CONNECTING TO THE COMPUTER

To connect with the computer, refer to the figure below.

Used cables for connection

- VGA CABLE
- CONTROL CABLE FOR PS/2 PORT
- CONTROL CABLE FOR SERIAL PORT, or ADB PORT *
- MAC ADAPTER *
- MONITOR CABLE *
- PC AUDIO CABLE (stereo) *

* These cables are not supplied with this projector.

IBM-compatible computers or Macintosh computers (VGA / SVGA / XGA)

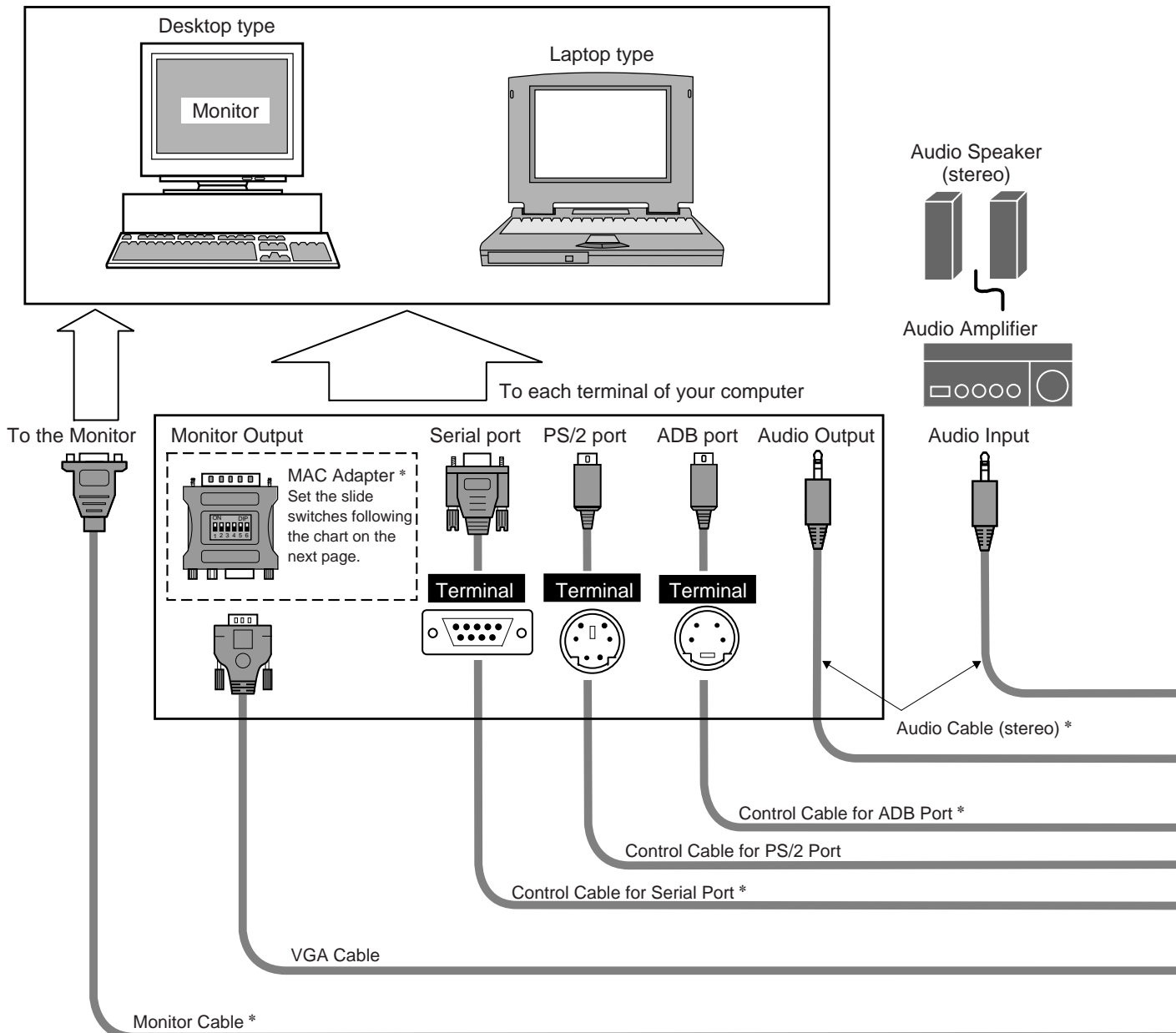

NOTE :

When connecting the cable, the power cords of both the projector and the external equipment should be disconnected from AC outlet. Turn the projector and peripheral equipment on before the computer is switched on.

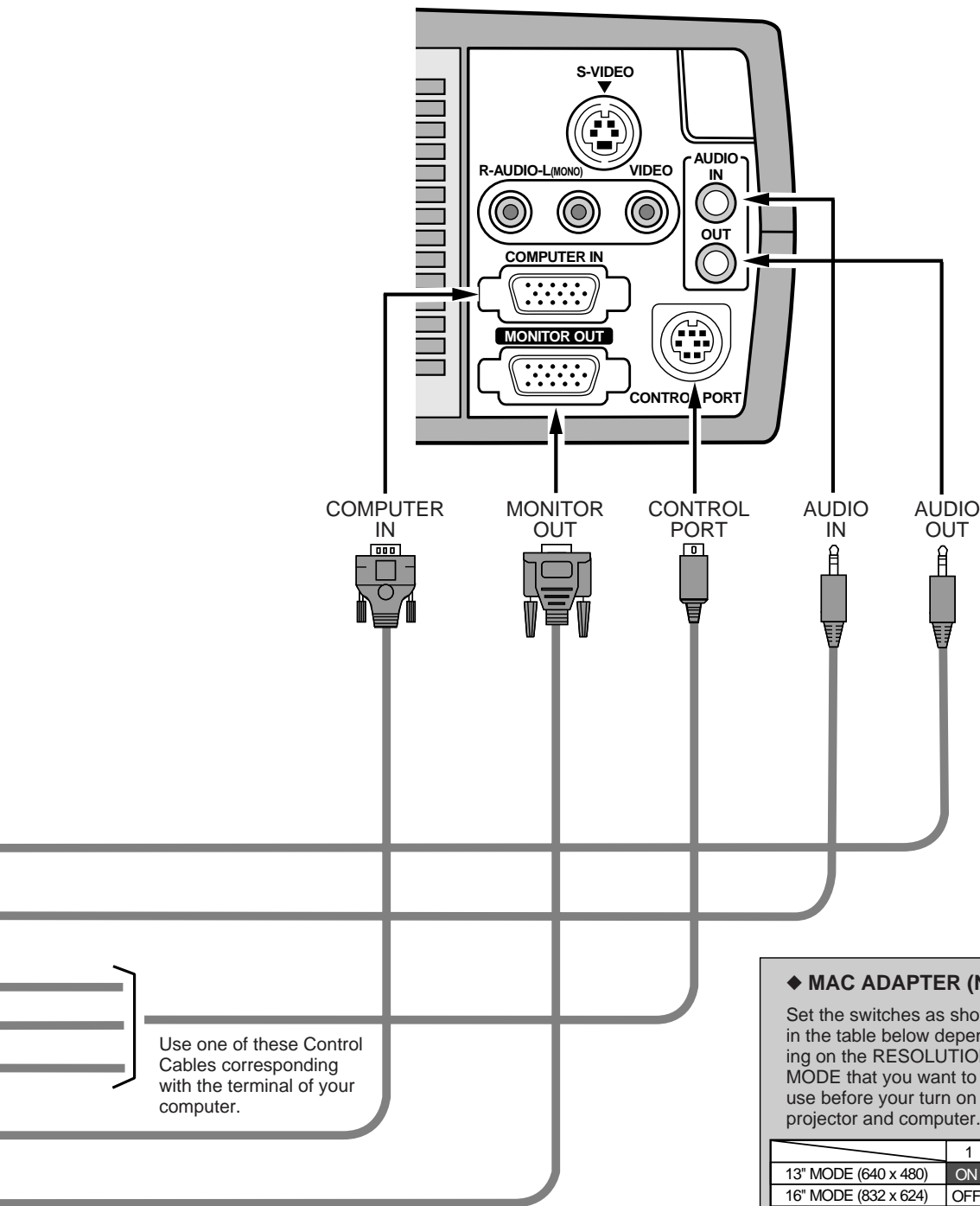

Use one of these Control Cables corresponding with the terminal of your computer.

◆ MAC ADAPTER (Not supplied)

Set the switches as shown in the table below depending on the RESOLUTION MODE that you want to use before your turn on the projector and computer.

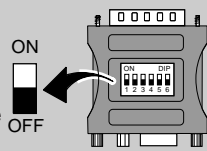

	1	2	3	4	5	6
13" MODE (640 x 480)	ON	ON	OFF	OFF	OFF	OFF
16" MODE (832 x 624)	OFF	ON	OFF	ON	OFF	OFF
19" MODE (1024 x 768)	OFF	ON	ON	OFF	OFF	OFF

BEFORE OPERATION

OPERATION OF THE REMOTE CONTROL

Left Side

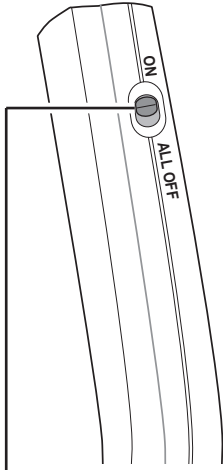

ALL-OFF SWITCH

When using the Remote Control Unit, turn this switch to "ON" and turn it "ALL OFF" when it is not used.

VIDEO BUTTON

Used to select VIDEO source. (P30)

COMPUTER / MCI BUTTON

Used to select source either COMPUTER or MCI mode. (P23)

MENU BUTTON

Used to call MENU operation. (P17-19)

SELECT BUTTON

Used to execute the item selected or to expand the image in DIGITAL ZOOM mode. (P29, 37)
It is also used as a PC mouse in Wireless Mouse Operation. (P41)

LASER BUTTON

Used to operate laser pointer function. The laser beam is emitted while pressing this button within 1 minute. When using the laser pointer for more than 1 minute, release the button and press it again.

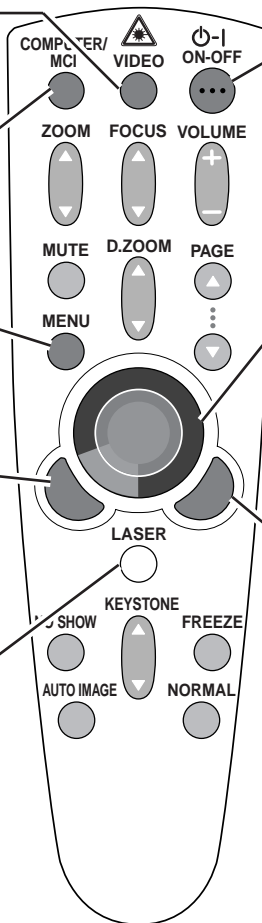

POWER ON-OFF BUTTON

Used to turn the projector on or off. (P20)

POINT BUTTON

Used to move the pointer on the MENU, to adjust the item, or to pan the image in DIGITAL ZOOM mode. (P29, 37)
It is also used as a PC mouse in Wireless Mouse Operation. (P41)

* When pressing the center of this button, it works as the SELECT button.

RIGHT CLICK BUTTON

Used to compress the image in DIGITAL ZOOM mode. (P29, 30, 37)
It is also used as a PC mouse in Wireless Mouse Operation. (P41)

LASER POINTER FUNCTION

This remote control emits a laser beam as the Laser Pointer from the Laser Light Window. When the LASER button is pressed, the laser light goes on. And when the button is pressed more than 1 minute or the button is released, light goes off. Laser light is emitted with the RED light which tells the laser beam being emitted.

The laser emitted is a class II laser; therefore, do not look into the Laser Light Window or shine the laser beam on yourself or other people. The three marks below are the caution labels for the laser beam.

CAUTION : Use of controls or adjustments or performance of procedures other than those specified herein may result in hazardous radiation exposure.

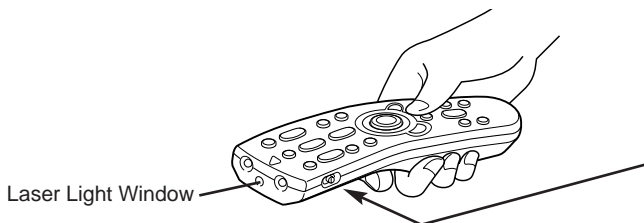

These caution labels are put on the remote control.

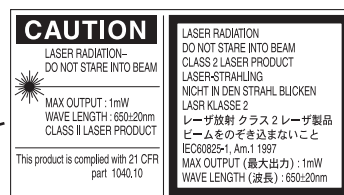

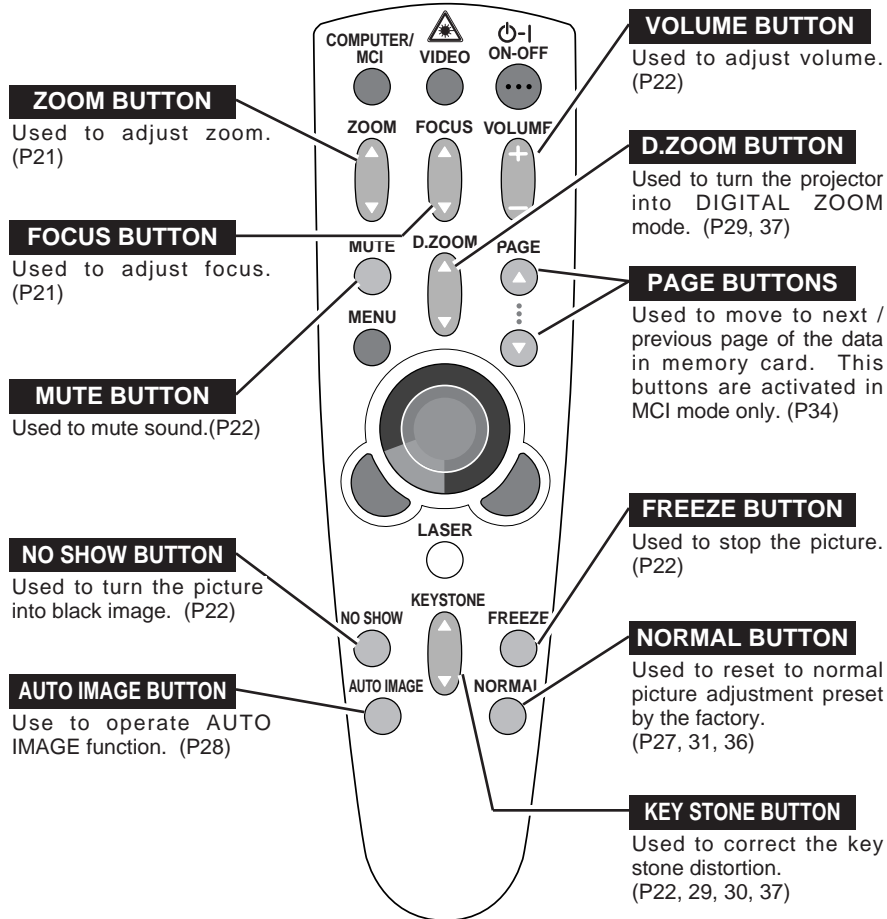

Operating Range

Point the remote control toward the projector (Receiver Window) when pressing the buttons. Maximum operating range for the remote control is about 16.4' (5m) and 60° front and rear of the projector

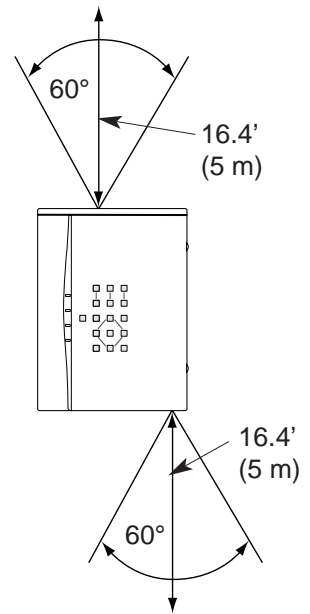

REMOTE CONTROL BATTERIES INSTALLATION

1 Remove the battery compartment lid.

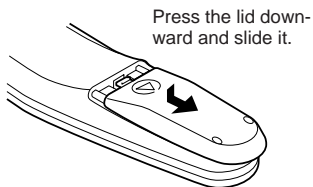

2 Slide the batteries into the compartment.

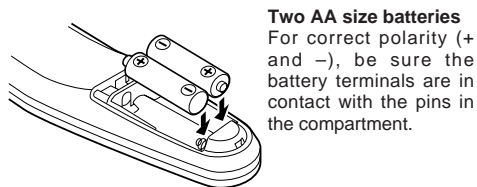

3 Replace the compartment lid.

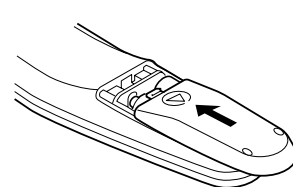

To insure safe operation, please observe the following precautions :

- Use (2) AA type alkaline batteries.
- Replace two batteries at the same time.
- Do not use a new battery with a used battery.
- Avoid contact with water or liquid.
- Do not expose the Remote Control Unit to moisture, or heat.
- Do not drop the remote control unit.
- If batteries have leaked on the remote control, carefully wipe the case clean and load new batteries.

TOP CONTROLS AND INDICATORS

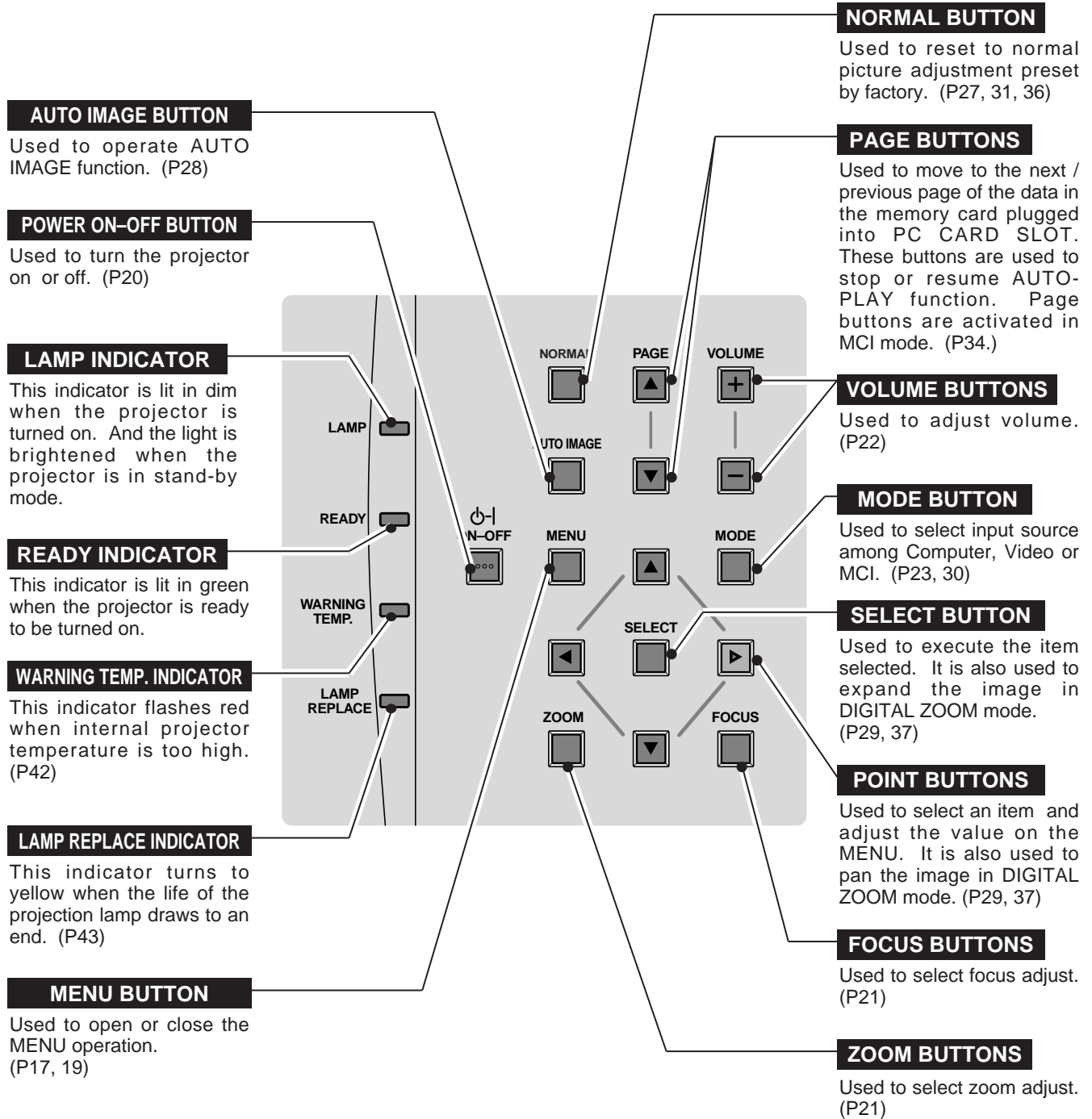

OPERATING ON-SCREEN MENU

HOW TO OPERATE ON-SCREEN MENU

You can control and adjust this projector through ON-SCREEN MENU. Refer to the following pages to operate each adjustment on the ON-SCREEN MENU.

1 MOVING THE POINTER

Move the pointer (see the NOTE below) by pressing POINT button(s) on the TOP CONTROL or the REMOTE CONTROL.

2 SELECT THE ITEM

Select the item by pressing SELECT button.

NOTE : Pointer is the icon on the ON-SCREEN Menu to select the item. See the figures on the section "FLOW OF ON-SCREEN MENU" below.

WIRELESS REMOTE CONTROL

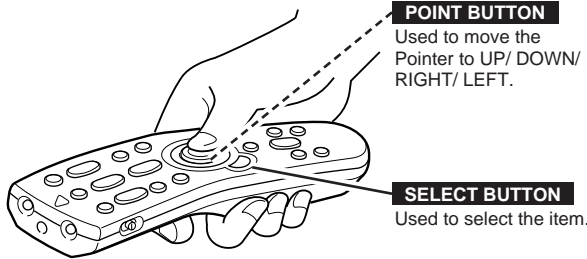

TOP CONTROL

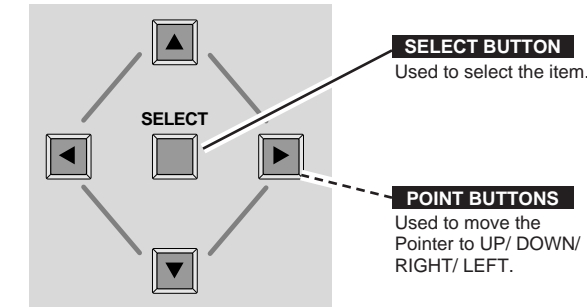

FLOW OF ON-SCREEN MENU

Display ON-SCREEN MENU

1 Press MENU button to display the ON-SCREEN MENU (MENU BAR). The red frame is the POINTER.

Select the Item

2 Move the POINTER (red frame) to the ITEM ICON that you want to select by pressing POINT RIGHT/ LEFT buttons.

3 Select the ITEM by pressing SELECT button. The dialog box of the ITEM appears.

Control and adjust through ON-SCREEN MENU

4 Move the POINTER downward by pressing POINT DOWN button. (The shape of POINTER become an arrow.)

5 Move the POINTER to the ITEM that you want to adjust and adjust the ITEM by pressing SELECT button. Refer to the following pages for details of respective adjustments.

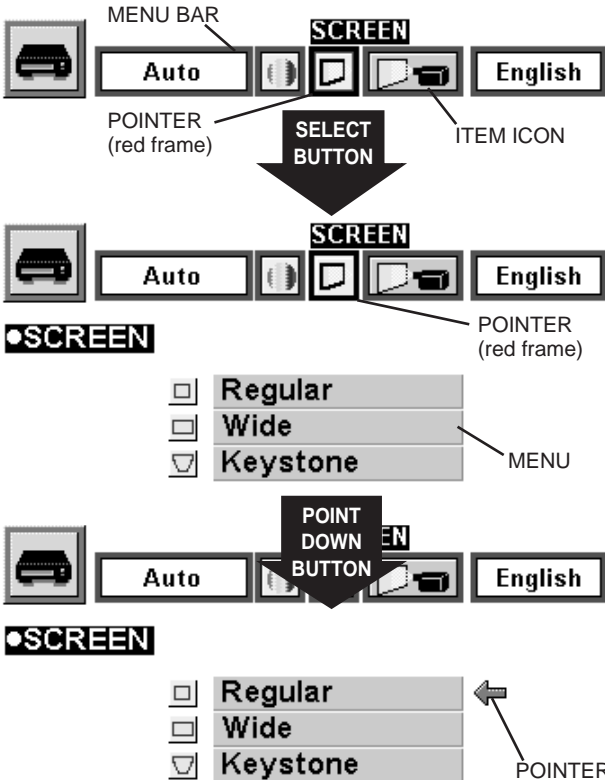

MENU BAR

MENU BAR IN COMPUTER MODE

Press MENU BUTTON while being in Computer mode.

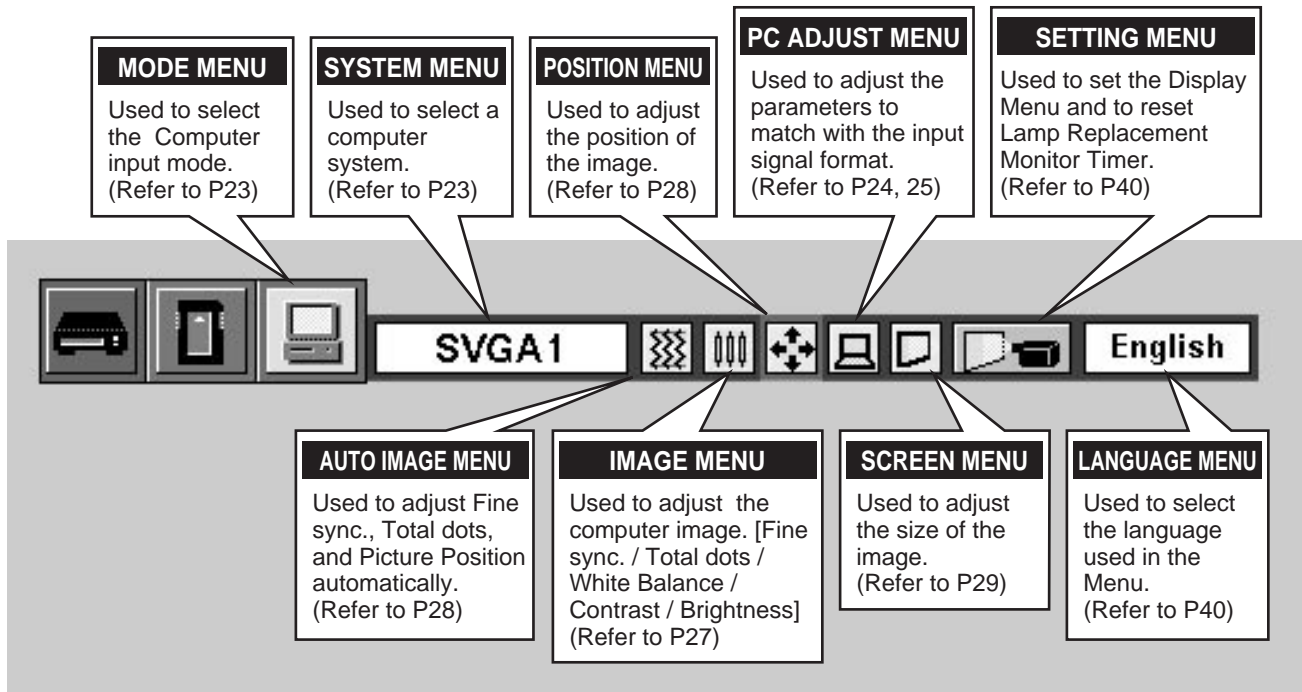

MENU BAR IN VIDEO MODE

Press MENU BUTTON while being in Video mode.

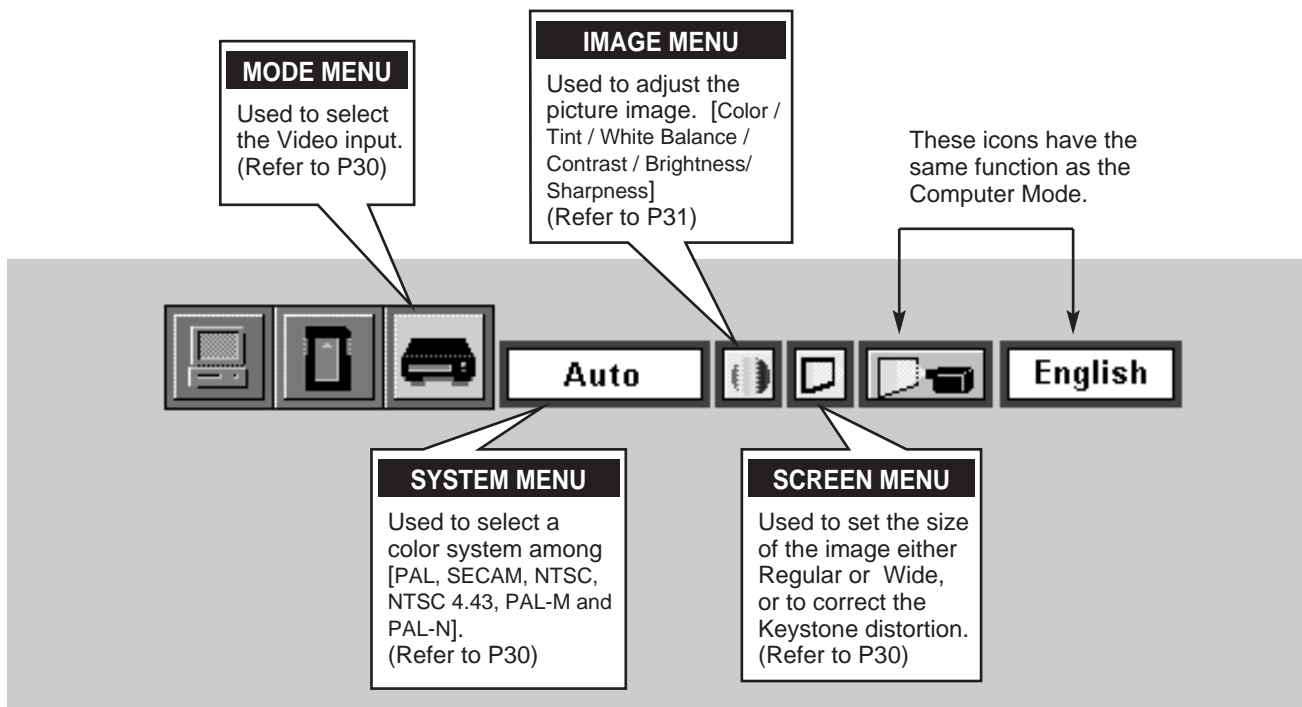

MENU BAR IN MCI MODE

Press MENU BUTTON while being in MCI mode.

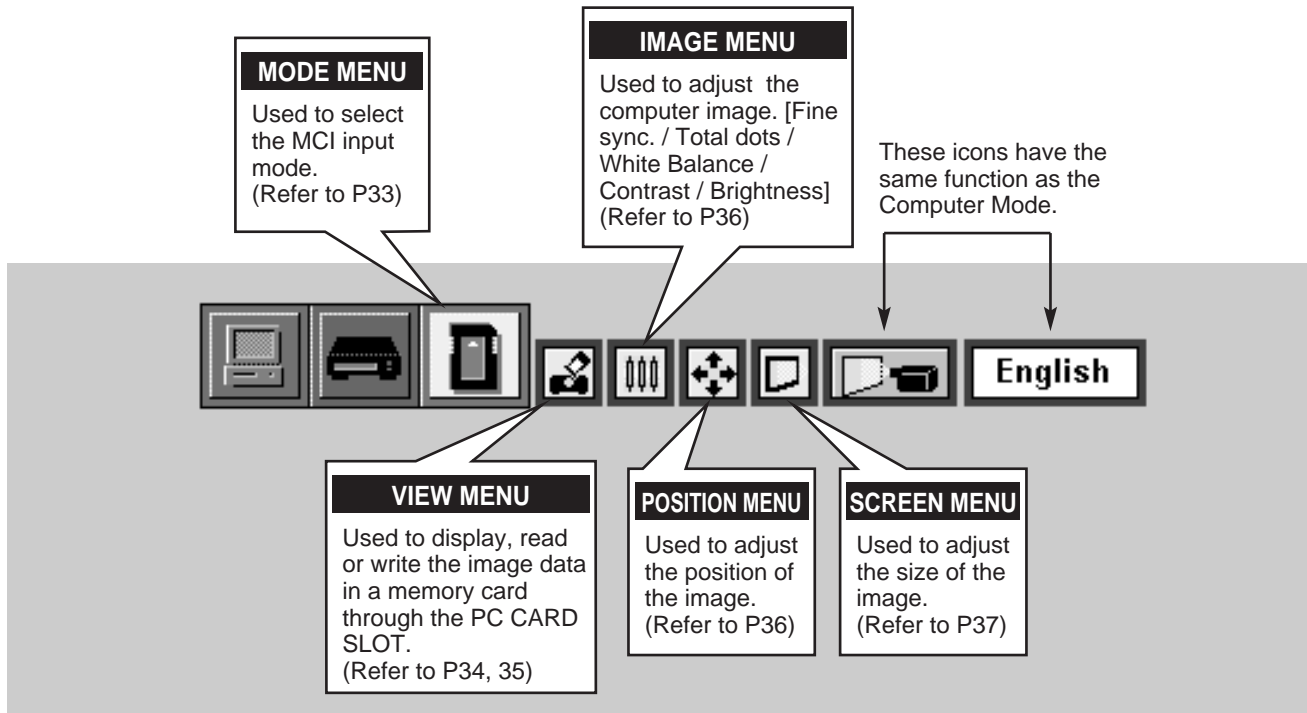

BASIC OPERATIONS

TURNING ON / OFF THE PROJECTOR

TURNING ON THE PROJECTOR

- 1 Complete the peripheral connections (with Computer, VCR, and etc.) before turning on the projector. (Refer to "CONNECTING TO THE PROJECTOR" on Pages 10-13 for connecting the equipment.
- 2 Connect the projector's AC power cord into a wall outlet. The LAMP indicator lights RED, and the READY indicator lights GREEN.
- 3 Press the power ON-OFF button on the Remote Control Unit or on the Top Control to ON. The LAMP POWER indicator dims, and the Cooling Fans start to operate. The Preparation Display appears on the screen and the count-down starts. The signal from the source appears after 30 seconds.

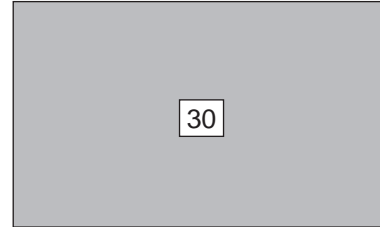

The Preparation Display disappears after 30 seconds.

TURNING OFF THE PROJECTOR

- 1 Press the power ON-OFF button on the Remote Control Unit or on the Top Control, and the message "Power off?" appears on the screen.
- 2 Press again the power ON-OFF button to turn off the projector. The LAMP indicator lights bright and the READY indicator turns off. The Cooling Fans operate for 90 seconds after the projector is turned off. (During this "Cooling Down" period, this appliance cannot be turned on.)
- 3 When cooling the projector has finished, the READY indicator turns to green again and you can turn the projector on. After cooling down completely, disconnect the AC power cord.

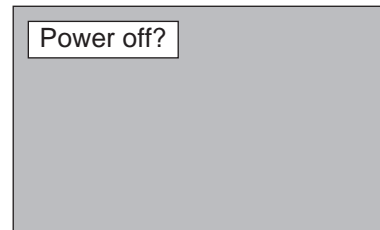

The message disappears after 4 seconds.



TO MAINTAIN THE LIFE OF THE LAMP, ONCE YOU TURN IT ON, WAIT AT LEAST 5 MINUTES BEFORE TURNING IT OFF.

When the TEMPERATURE WARNING indicator flashes red, the projector is automatically turned off. Wait at least 5 minutes before turning the projector on again.

If the TEMPERATURE WARNING indicator continues to flash, follow procedures below:

1. Disconnect the AC power cord from the AC outlet.
2. Check the air filters for dust accumulation.
3. Clean the Air Filter. (See "AIR FILTER CARE AND CLEANING" section on page 42.)
4. Press the power ON-OFF button to ON.

If the TEMPERATURE WARNING indicator still continues to flash, call your authorized dealer or service station.

NOTE: The Cooling Fan may work for cooling while the projector is turned off. When the Cooling Fan is working, TEMPERATURE WARNING INDICATOR flashes red.

ADJUSTING THE IMAGE

ZOOM ADJUSTMENT

- 1 Press the ZOOM button on the Top Control or the ZOOM ▲/▼ button on the Remote Control Unit to turn into the ZOOM mode.
- 2 Press the POINT UP button or the ZOOM ▲ button to have the image larger, and press the POINT UP button or the ZOOM ▼ button to have the smaller.

In the Computer mode, the image can be expanded, compressed, and panned with the Digital Zoom function. Refer to page 29, 37 for the Digital Zoom operation.

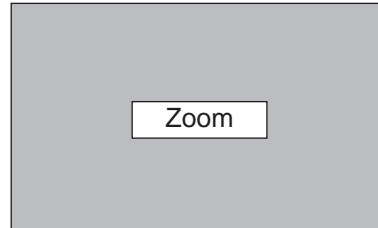

The message disappears after 4 seconds.

FOCUS ADJUSTMENT

- 1 Press the FOCUS button on the Top Control or the FOCUS ▲/▼ button on the Remote Control Unit to turn into the FOCUS mode.
- 2 Adjust the focus of the image by pressing the POINT UP/DOWN button or the FOCUS ▲/▼ button.

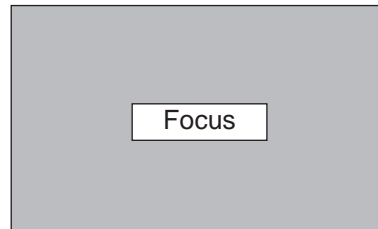

The message disappears after 4 seconds.

KEYSTONE ADJUSTMENT

If the picture obtained keystone distortion, correct screen with KEYSTONE adjustment.

- 1 Press the KEYSTONE ▲/▼ button on the Remote Control Unit or select the Keystone on the SCREEN menu. (Refer to page 29, 30, 37.) The message "Keystone" is displayed.
- 2 Correct the Keystone distortion by pressing the KEYSTONE ▲/▼ button or the POINT UP/DOWN button(s). Press the KEYSTONE ▲ button or the POINT UP button to reduce the upper part of the image, and press the KEYSTONE ▼ button or the POINT DOWN button to reduce the lower part.

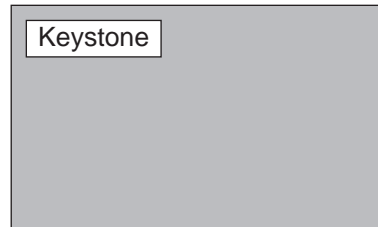

The message disappears after 4 seconds.

Reduce the upper width with the KEY STONE ▲ button or the POINT UP button.

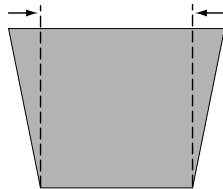

Reduce the lower width with the KEY STONE ▼ button or the POINT DOWN button.

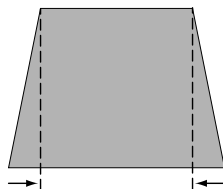

NO SHOW FUNCTION

Press the NO SHOW button on the Remote Control Unit to turn the picture into black image. This function is cancelled when the NO SHOW button is pressed again or any other function button is pressed.

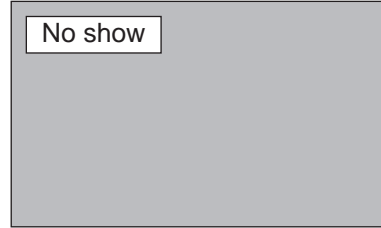

The message disappears after 4 seconds.

PICTURE FREEZE FUNCTION

Press the FREEZE button on the Remote Control Unit to turn the picture remained on-screen. This function is cancelled when the FREEZE button is pressed again or any other function button is pressed.

SOUND ADJUSTMENT

SOUND VOLUME ADJUSTMENT

Press the VOLUME (+/-) button(s) on the Top Control or on the Remote Control Unit to adjust the volume. The Volume dialog box appears on the screen for a few seconds.

The VOLUME (+) button to increase the volume, and The VOLUME (-) button for decreasing.

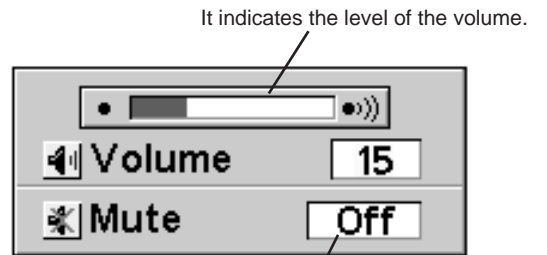

Press the MUTE button to set the Mute function On or Off.

SOUND MUTE ADJUSTMENT

Press the MUTE button on the Remote Control Unit to cut off the sound. To restore the sound to its previous level, press again or press Volume button(s).

The display disappears after 4 seconds.

COMPUTER MODE

SELECTING COMPUTER MODE

DIRECT OPERATION

Select COMPUTER mode by pressing the MODE button on the Top Control or the COMPUTER / MCI button on the Remote Control Unit.

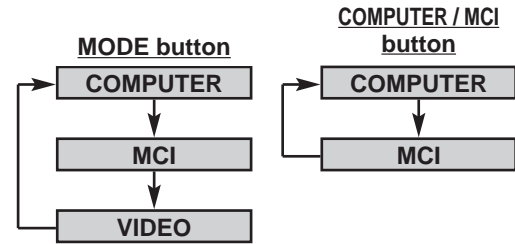

MENU OPERATION

Press the MENU button and the ON-SCREEN MENU will appear. Press the POINT LEFT/RIGHT buttons to select Computer  and press the SELECT button.

CURRENT MODE DISPLAY

When selecting the Computer Mode, the Current Mode display appears. It shows the information of the computer of the mode selected.

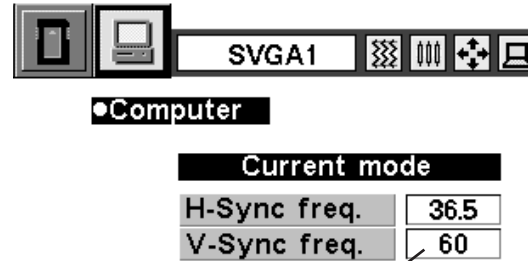

Providing the information of the computer detected by the projector.

SELECTING COMPUTER SYSTEM

AUTOMATIC MULTISCANNING SYSTEM

This projector automatically tunes to most different types of computer based on VGA, SVGA or XGA (refer to "COMPATIBLE COMPUTER SPECIFICATION" on page 26). When selecting Computer, this projector automatically tunes to the incoming signal and projects the proper image without any special setting. (Setting of the Computer System may be required when connecting some computers.)

Note : The projector may provides the messages below.

Go to PC adj. The projector cannot discriminate or detect the input signal from the computer. Adjust and set the computer system manually. (Refer to page 24.)

No signal There is no signal input from the computer. Make sure the connection of the computer and the projector is set correctly. (Refer to TROUBLESHOOTING on page 44.)

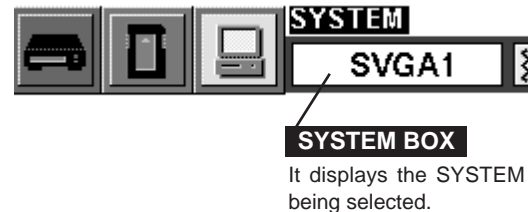

It displays the SYSTEM being selected.

SELECT COMPUTER SYSTEM MANUALLY

To set the Computer system manually, select the mode on the ON-SCREEN MENU.

- 1 Press the MENU button and the ON-SCREEN MENU will appear. Press the POINT LEFT/RIGHT buttons to select SYSTEM and press the SELECT button. Another dialog box COMPUTER MODE Menu will appear.
- 2 Press the POINT DOWN button and a red-arrow icon will appear. Move the arrow to the system that you want to set, and then press SELECT button.

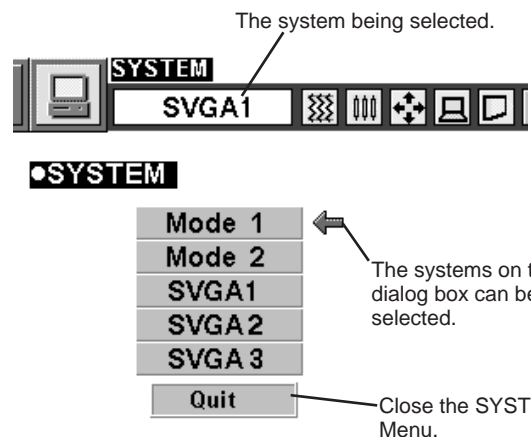

The system being selected.

The systems on this dialog box can be selected.

Close the SYSTEM Menu.

PC ADJUSTMENT

This Projector can automatically tune to the display signals from most personal computers currently distributed. However, some computers employ the special signal formats which are different from the standard ones and may not be tuned by Multiscanning of this projector. If this happens, the projector cannot reproduce a proper image and the image is recognized as a flickering picture, a non-synchronized picture, a non-centered picture or a skewed picture.

This projector has PC ADJUSTMENT function, to enable you to precisely adjust several parameters to match with those exceptional signal formats and the projector has five independent memory areas to memorize those parameters manually adjusted. This enables you to recall the setting for a specific computer whenever you use it.

- 1 Press the MENU button and the ON-SCREEN MENU will appear. Press the POINT RIGHT/LEFT buttons to select PC ADJUST  and press the SELECT button. Another dialog box "Where to reserve" Menu will appear.
- 2 In this dialog box, you can store the parameter into the area from "Mode 1" to "Mode 5." When memorizing the new computer parameter, select the Mode with the message of "Free" by pressing the POINT UP/DOWN buttons and the SELECT button. To change the parameters of the Mode previously set, select the Mode with "Stored."
- 3 When the Mode is selected, Parameter adjustment dialog box appears. Move the arrow to the item that you want to change by pressing the POINT UP/DOWN buttons, and adjust the each item to match your computer. To change the value, press either the POINT RIGHT button or the POINT LEFT button. Refer to the next page for adjusting each item.
- 4 Move the arrow to "Stored" and press the SELECT button. The parameter is memorized in the selected Mode.
- 5 To activate the Mode manually adjusted in this PC ADJUSTMENT Menu, select the Mode at the SYSTEM SELECT Menu. (Refer to page 23.)



PC ADJUST

Where to reserve

Mode 1	Stored	▶
Mode 2	Stored	▶
Mode 3	Free	▶
Mode 4	Free	▶
Mode 5	Free	▶

Quit

Annotations:
 - This Mode has parameters being stored. (points to Mode 1)
 - The Vacant Mode. (points to Mode 3)
 - Manual set Computer Mode (1 to 5). (points to Mode 4)
 - Close the PC ADJUSTMENT Menu. (points to Quit)



PC ADJUST

Mode 4 Free

Total lines	630	◀▶
Total dots	1056	◀▶
Horizontal	47	◀▶
Vertical	4	◀▶
Clamp	300	◀▶
Display area		▶
H	600	◀▶
V	800	◀▶
Full screen	On	▶

Reset Stored
 Mode Free Quit

Annotations:
 - Press the POINT RIGHT/LEFT button(s) to adjust the value. (points to Total lines)
 - Press the SELECT button to set Full screen function on/off. (points to Full screen)

Total lines

The number of the total vertical lines. Adjust the number to match the image of your personal computer.

Total dots

The number of the total dots in one horizontal period. Adjust the number to match the image of your personal computer.

Horizontal / Vertical

Adjustment of the horizontal or vertical picture position. When the image is not centered on the screen, adjust each of those items.

Clamp

Adjustment of the clamp level. When the image has a dark bar(s), try this adjustment.

Display area

Adjustment of the area displayed with this projector. Select the resolution at the Display area dialog box, or adjust the number at the column of "H" or "V" to match the resolution of the image.

Full Screen

Set "On" to resize the image with 4 x 3 aspect ratio to fit the screen.

Each of the keys operates as follow.

Reset

.... Recalls the parameter data that previously adjusted.

Mode free

.... Clears the parameter data previously set in the selected Mode.

Stored

.... Stores the parameters in the memory.

Quit

.... Closes the PC ADJUST Menu.

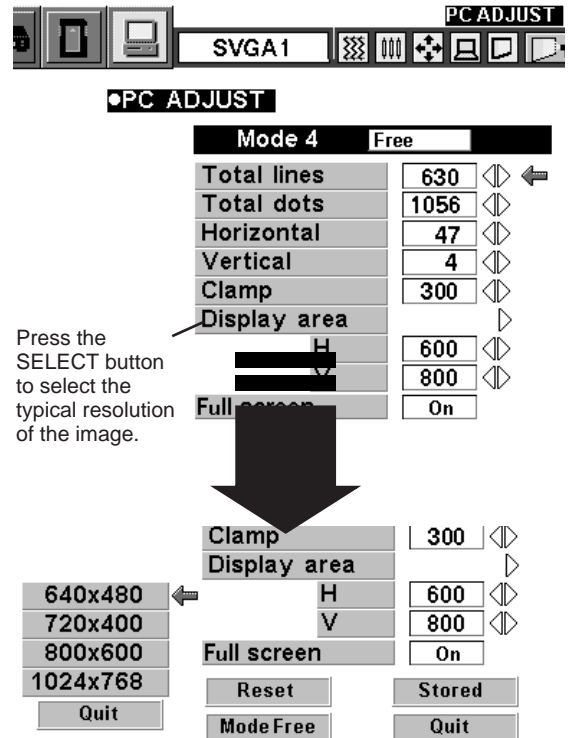

COMPATIBLE COMPUTER SPECIFICATIONS

Basically this projector can accept the signal from all computers with the V, H-Frequency below mentioned and less than 135 MHz of Dot Clock.

ON-SCREEN DISPLAY	RESOLUTION	H-Freq. (kHz)	V-Freq. (Hz)	ON-SCREEN DISPLAY	RESOLUTION	H-Freq. (kHz)	V-Freq. (Hz)
VGA 1	640 x 480	31.47	59.88	SVGA 10	800 x 600	47.90	71.92
VGA 2	720 x 400	31.47	70.09	SVGA 11	800 x 600	32.70	51.09
VGA 3	640 x 400	31.47	70.09	SVGA 12	800 x 600	38.00	60.51
VGA 4	640 x 480	37.86	74.38	MAC1 6	832 x 624	49.72	74.55
VGA 5	640 x 480	37.86	72.81	XGA 1	1024 x 768	48.36	60.00
VGA 6	640 x 480	37.50	75.00	XGA 2	1024 x 768	68.677	84.997
MAC LC13	640 x 480	34.97	66.60	XGA 3	1024 x 768	60.023	75.03
MAC 13	640 x 480	35.00	66.67	XGA 4	1024 x 768	56.476	70.07
RGB	640 x 480 (Interlace)	15.734	30	XGA 5	1024 x 768	60.31	74.92
RGB	768 x 576 (Interlace)	15.625	25	XGA 6	1024 x 768	48.50	60.02
SVGA 1	800 x 600	35.156	56.25	XGA 7	1024 x 768	44.00	54.58
SVGA 2	800 x 600	37.88	60.32	XGA 8	1024 x 768	63.48	79.35
SVGA 3	800 x 600	46.875	75.00	XGA 9	1024 x 768 (Interlace)	36.00	43.59
SVGA 4	800 x 600	53.674	85.06	XGA 10	1024 x 768	62.04	77.07
SVGA 5	800 x 600	48.08	72.19	XGA 11	1024 x 768	61.00	75.70
SVGA 6	800 x 600	37.90	61.03	XGA 12	1024 x 768 (Interlace)	35.522	43.48
SVGA 7	800 x 600	34.50	55.38	XGA 13	1024 x 768	46.90	58.20
SVGA 8	800 x 600	38.00	60.51	XGA 14	1024 x 768	47.00	58.30
SVGA 9	800 x 600	38.60	60.31	MAC 19	1024 x 768	60.24	75.08

NOTE : Specifications are subject to change without notice.

PICTURE IMAGE ADJUSTMENT

ADJUST PICTURE IMAGE MANUALLY

- 1 Press the MENU button and the ON-SCREEN MENU will appear. Press the POINT LEFT/RIGHT buttons to select IMAGE  and press the SELECT button. Another dialog box PICTURE IMAGE ADJUSTMENT Menu will appear.
- 2 Press the POINT DOWN button and a red-arrow icon will appear. Move the arrow to the item that you want to change by pressing the POINT UP/DOWN buttons. To change the value, press either the POINT RIGHT button or the POINT LEFT button.

Fine sync.

Adjust the picture as necessary to eliminate flicker from the display. (From 0 to 127.)

Total dots

The number of the total dots in one horizontal period. Adjust the number to match your PC image.

White balance (Red / Green / Blue)

Move the arrow to Red, Green, or Blue that you want to adjust. Press POINT LEFT button to adjust the color of image lighter, and press POINT RIGHT button to adjust deeper. (From 0 to 63.)

Contrast

Press POINT LEFT button to adjust the image lighter, and press POINT RIGHT button to adjust deeper. (From 0 to 63.)

Brightness

Press POINT LEFT button to adjust the image darker, and press POINT RIGHT button to adjust brighter. (From 0 to 63.)

Each of the keys operates as follow.

- Reset** Recalls the data previously adjusted.
- Stored** Stores the adjusted data in the memory.
- Quit** Closes the PICTURE IMAGE ADJUSTMENT Menu.

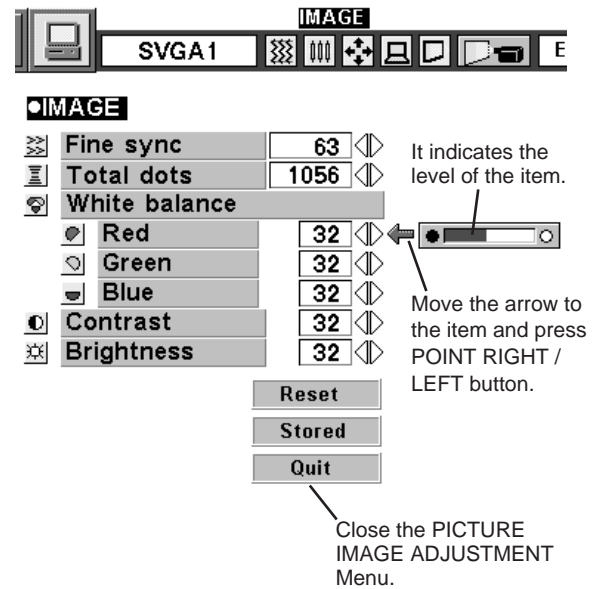

NORMAL FUNCTION

The normal picture level is preset on this projector at the factory and can be restored anytime you press the NORMAL button (located on the Top Control or on the Remote Control Unit). The "Normal" display will be displayed on the screen for a few seconds.

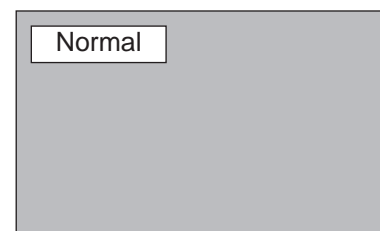

AUTO IMAGE FUNCTION

The Auto Image function is provided to automatically adjust Fine sync., Total dots, and Picture Position for most computers.

- 1 Press the MENU button and the ON-SCREEN MENU will appear. Press the POINT LEFT/RIGHT buttons to select AUTO IMAGE  and press the SELECT button. Another dialog box AUTO IMAGE Menu will appear.
- 2 Move the arrow to an item that you want to adjust by pressing the POINT UP/DOWN button. Change the setting On or Off by pressing the SELECT button.

Fine sync.

Adjust the picture as necessary to eliminate flicker from the display. This item can be adjusted manually. (Refer to page 27.)

Total dots

The number of the total dots in one horizontal period. This item can be adjusted manually. (Refer to page 27.)

Position

Adjustment of the position of the image. This item can be adjusted manually. (Refer to page 28.)

- 3 Move the arrow to "Go!" and press the SELECT button to start the Auto Image function. This adjustment can be executed by pressing AUTO IMAGE button on the Top Control and the Remote Control Unit.

Stored Stores the On/Off setting of each item.

Go! Starts the Auto Image Adjustment.

Quit Closes the AUTO IMAGE ADJUSTMENT Menu.

NOTE : The Fine sync., Total dots, and Picture Position of some computers may not be fully adjusted with the Auto Image Function. In that case, manual adjustment is required to make fine image. (Refer to page 27 to adjust "Fine sync." or "Total dots" and page 28 to adjust Picture Position.)

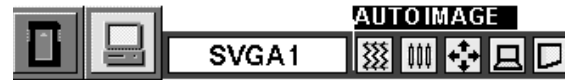

●AUTO IMAGE

Fine sync	On
Total dots	On
Position	On

Stored

Go!

Quit

Starts the adjustment on the item set to "On".

Close the PICTURE IMAGE ADJUSTMENT Menu.

Move the arrow to the item and then press the SELECT button.

PICTURE POSITION ADJUSTMENT

The position of the image can be adjusted vertically and horizontally through PICTURE POSITION ADJUSTMENT.

- 1 Press the MENU button and the ON-SCREEN MENU will appear. Press the POINT LEFT/RIGHT buttons to select POSITION  and press the SELECT button. The PICTURE POSITION dialog box will appear.
- 2 Move the image by pressing the POINT UP / DOWN / RIGHT / LEFT buttons.

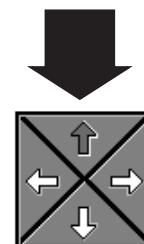

PICTURE POSITION dialog box

Press the POINT UP / DOWN / RIGHT / LEFT buttons to move the image

PICTURE SCREEN ADJUSTMENT

This projector has a picture screen resize function, which enables you to display the image in desirable size.

- 1 Press the MENU button and the ON-SCREEN MENU will appear. Press the POINT LEFT/RIGHT buttons to select SCREEN  and press the SELECT button. Another dialog box PICTURE SCREEN Menu will appear.
- 2 Press the POINT DOWN button and a red-arrow icon will appear. Move the arrow to the function that you want to select and then press SELECT button.

True

To turn the image into its original size select True in the dialog box. When the original image size is larger than the screen size (800 x 600), this projector becomes Digital Zoom mode automatically.

Key Stone

When the image is distorted vertically, select Keystone in the dialog box. The ON-SCREEN menu and SCREEN ADJUST menu disappears and the message "Keystone" is displayed. Correct the Keystone distortion by pressing the KEYSTONE ▲/▼ button or the POINT UP/DOWN button(s). Refer to KEYSTONE ADJUSTMENT on page 21.

Digital Zoom

To adjust the image size or pan the image, select Digital zoom in the dialog box. The ON-SCREEN menu and SCREEN ADJUST menu disappears and the message "D. Zoom" is displayed.

This projector is also turned into Digital Zoom mode by pressing the D.ZOOM ▲/▼ button on the Remote Control Unit.

Refer to the following for operation.

Expand function

To expand the image size, press the D.ZOOM ▲ button or the SELECT button. The image is magnified by degrees. The maximum size of the projected image in expand mode is 4 times as large as the screen size (800 x 600).

Compress function

To compress the image size, press the D.ZOOM ▼ button or the RIGHT CLICK button. The size of image is reduced by degrees. The minimum size of the projected image in compress mode is 640 x 480 in VGA or 800 x 600 in SVGA / XGA.

Panning function

To pan the image, press the POINT UP/DOWN/LEFT/RIGHT buttons. Panning function can work only when the image is larger than the screen size.

To cancel Digital Zoom mode, press the any buttons except D.ZOOM ▲/▼, SELECT, RIGHT CLICK, POINT, PAGE ▲/▼ or LASER button. To adjust the image to the screen size (800 x 600), press NORMAL button.

- This projector cannot display in the resolution higher than 1024 X 768. If your computer's screen resolution is higher than 1024 X 768, reset the resolution to the lower before connecting the projector.
- The image data in other than SVGA (800 x 600) is modified to fit the screen size in the initial mode.
- The normal "Panning Operation" may not function properly if the computer system prepared with the "PC Adjust" is used.

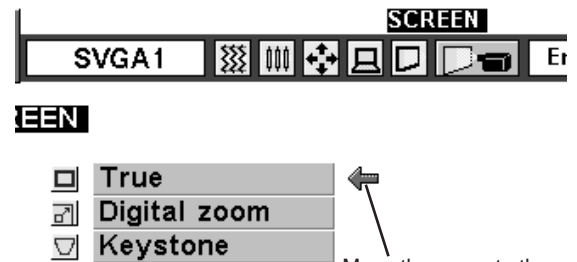

Move the arrow to the function and press the SELECT button.

SELECTING VIDEO MODE

DIRECT OPERATION

Select VIDEO mode by pressing the MODE button on the Top Control or the VIDEO button on the Remote Control Unit.

MENU OPERATION

Press the MENU button and the ON-SCREEN MENU will appear. Press the POINT LEFT/RIGHT buttons to select Video  and press the SELECT button.

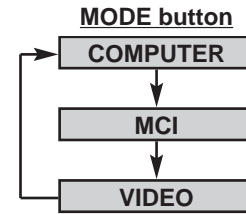

SELECTING COLOR SYSTEM

- 1 Press the MENU button and the ON-SCREEN MENU will appear. Press the POINT LEFT/RIGHT buttons to select SYSTEM and press the SELECT button. Another dialog box VIDEO SYSTEM Menu will appear.
- 2 Press the POINT DOWN button and a red-arrow icon will appear. Move the arrow to "Auto", and then press the SELECT button.

Auto

The projector automatically detects the incoming Video system, and adjusts itself to optimize its performance. When the Video System is PAL-M or PAL-N, select the system manually.

PAL / SECAM / NTSC / NTSC4.43 / PAL-M / PAL-N

If the projector cannot reproduce the proper video image, it is required to select a specific broadcast signal format among PAL, SECAM, NTSC, NTSC 4.43, PAL-M, or PAL-N.

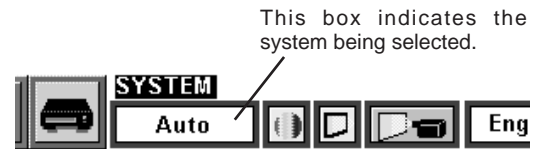

SYSTEM

- Auto
- PAL
- SECAM
- NTSC
- NTSC4.43
- PAL-M
- PAL-N

Move the arrow to the Mode and press the SELECT button.

PICTURE SCREEN ADJUSTMENT

This projector has a picture screen resize function, which enables you to display the image in desirable size.

- 1 Press the MENU button and the ON-SCREEN MENU will appear. Press the POINT LEFT/RIGHT buttons to select SCREEN  and press the SELECT button. Another dialog box PICTURE SCREEN ADJUSTMENT DISPLAY will appear.
- 2 Press the POINT DOWN button and a red-arrow icon will appear. Move the arrow to the screen size that you want to set, and then press the SELECT button.

Regular

Normal Video Image size with 4 x 3 aspect ratio.

Wide

Resizes the image for wide screen size with 16 x 9 aspect ratio.

Key Stone

When the image is distorted vertically, select Keystone in the dialog box. Correct the Keystone distortion by pressing KEYSTONE ▲/▼ button or POINT UP/DOWN button(s). Refer to KEYSTONE ADJUSTMENT on page 21.



SCREEN

- Regular
- Wide
- Keystone

Move the pointer to the function that and press the SELECT button.

PICTURE IMAGE ADJUSTMENT

ADJUSTING THE PICTURE IMAGE

- 1 Press the MENU button and the ON-SCREEN MENU will appear. Press the POINT LEFT/RIGHT buttons to select IMAGE  and press the SELECT button. Another dialog box PICTURE IMAGE ADJUSTMENT Menu will appear.
- 2 Press the POINT DOWN button and a red-arrow icon will appear. Move the arrow to the item that you want to adjust by pressing the POINT UP/DOWN buttons. To change the value, press either the POINT RIGHT button or the POINT LEFT button.

Color

Press POINT LEFT button to adjust the image lighter, and press POINT RIGHT button to adjust deeper. (From 0 to 63.)

Tint

Press POINT LEFT button to adjust the color more purple, and press POINT RIGHT button to adjust more green. (From 0 to 63.)

White balance (Red / Green / Blue)

Move the arrow to Red, Green, or Blue that you want to adjust. Press POINT LEFT button to adjust the color of image lighter, and press POINT RIGHT button to adjust deeper. (From 0 to 63.)

Contrast

Press POINT LEFT button to adjust the image lighter, and press POINT RIGHT button to adjust deeper. (From 0 to 63.)

Brightness

Press POINT LEFT button to adjust the image darker, and press POINT RIGHT button to adjust brighter. (From 0 to 63.)

Sharpness

Press POINT LEFT button to adjust the image softer, and press POINT RIGHT button to adjust sharper. (From 0 to 63.)

Each of the keys operates as follow.

Reset

.... Recalls the data previously adjusted.

Stored

.... Stores the data in the memory.

Quit

.... Closes the PICTURE IMAGE ADJUSTMENT Menu.

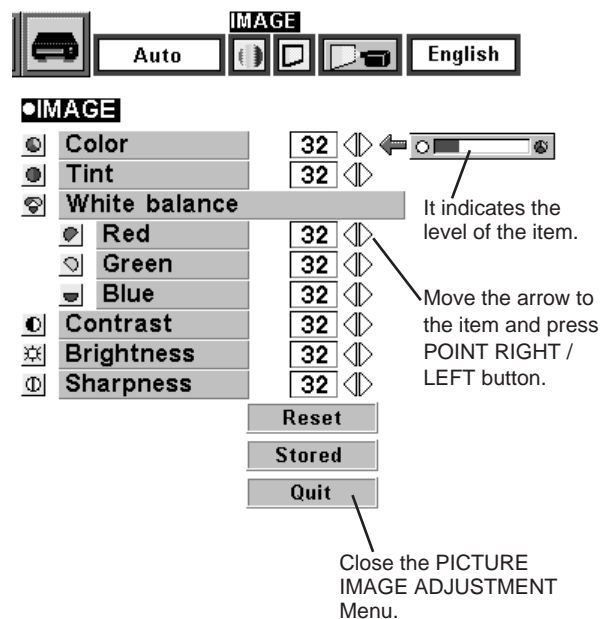

NORMAL FUNCTION

The normal picture level is preset on this projector at the factory and can be restored anytime you press the NORMAL button (located on the Top Control or on the Remote Control Unit). The "Normal" display will be displayed on the screen for a few seconds.

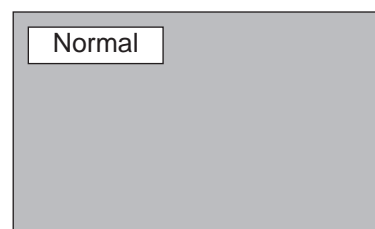

OPERATING THE PC CARD SLOT

This projector has PC CARD SLOT and the pictures in a memory card (SmartMedia with PC Card Adapter or PC card) can be displayed just by inserting the card into it. It is unnecessary to connect with other input equipment. Media Card Imager (supplied with CD-ROM) can edit the image data and record it into a memory card for projecting with the projector.

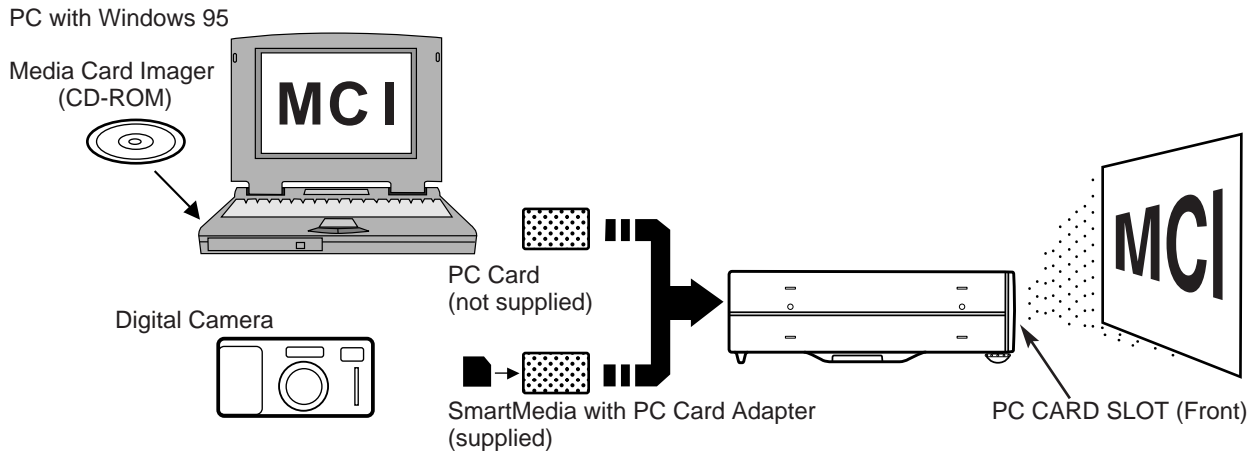

HOW TO LOAD THE MEMORY CARD INTO THE PROJECTOR

LOAD

Insert PC Card Adapter (with SmartMedia) or PC card into PC CARD SLOT. Make sure EJECT button pops out.

NOTE : Be sure to insert the memory card with the front side to the left side of the projector. Do not insert the card in the reverse. The card may be damaged.

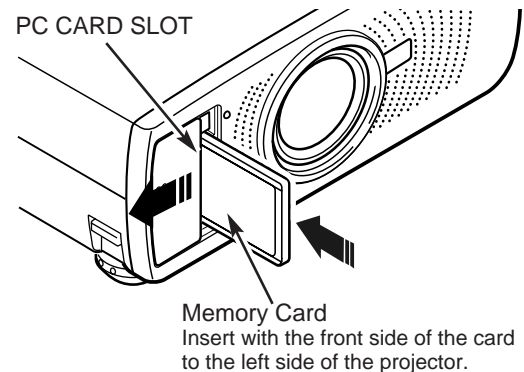

UNLOAD

Press EJECT button, and the memory card pops out.

NOTE : Do not take the card out while the PC CARD SLOT loading. Data and the card can be damaged.

PC CARD INDICATOR
WHEN THIS INDICATOR IS LIGHTING, THE PROJECTOR IS READING OR WRITING THE DATA INTO THE MEMORY CARD. DO NOT REMOVE THE MEMORY CARD. DATA IN THE MEMORY CARD MAY BE DAMAGED.

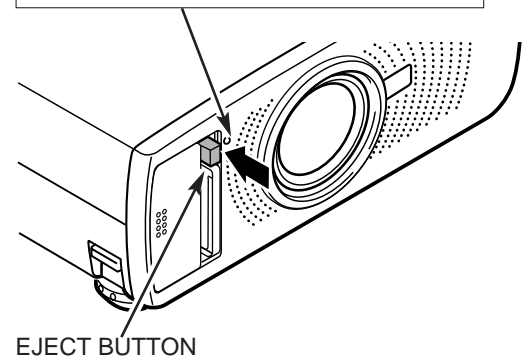

AVAILABLE DATA

This projector can project the image data as follow through PC CARD SLOT.

- The data edited by "Media Card Imager."
- The data of the resolution between VGA (640 X 480) and XGA (1024 X 768) in Bit Map type (BMP) or JPEG type (JPG), such as Digital Camera data, can be also displayed.
(Some image data in XGA size may not be displayed properly. In that case, reset the resolution to the lower.)

Refer to "SHOW THE DATA IN THE MEMORY CARD" on page 34 to display the image data.

Media Card Imager

Media Card Imager (CD-ROM) is attached to this projector to edit the image data for projecting. Installation of Media Card Imager is recommended. Refer to Owner's Manual of Media Card Imager for installation and operation.

AVAILABLE CARD

SmartMedia (with PC Card Adapter) or Type II PCMCIA-ATA Card can be used with this projector. (Those memory cards are supplied with this projector.)

Refer to SMARTMEDIA AND PC CARD ADAPTER on pages 38 and 39 for operation.

NOTE : Some PCMCIA Adapter or PC Card is not available for this projector and cannot provide the image data. In that case, use our SmartMedia and PC Card Adapter.

SELECTING MCI MODE

When the memory card is inserted into PC CARD SLOT, mode is automatically set to MCI mode and the first Page of the latest Index is projected on the screen. To turn Video/Computer mode to MCI mode manually, operate as follows.

DIRECT OPERATION

Select MCI mode by pressing the MODE button on the Top Control or the COMPUTER / MCI button on the Remote Control Unit.

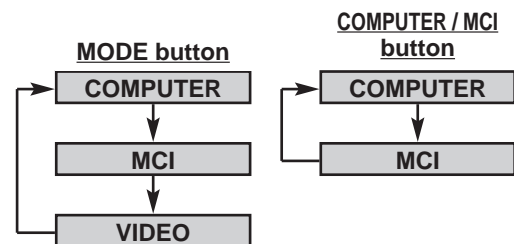

MENU OPERATION

Press the MENU button and the ON-SCREEN MENU will appear. Press the POINT LEFT/RIGHT buttons to select MCI  and press the SELECT button.



SHOW THE DATA IN THE MEMORY CARD

BASIC OPERATION

- 1 Insert the memory card and turn the projector into MCI mode. The image in the memory card is displayed.
- 2 To change the image to others, press the PAGE ▲ or ▼ button. (When the "Display Timer" is set in the image with the Media Card Imager, the image is changed to another automatically.)
To select Index or Page in the table, follow the instructions of INDEX SELECTION and PAGE SELECTION.

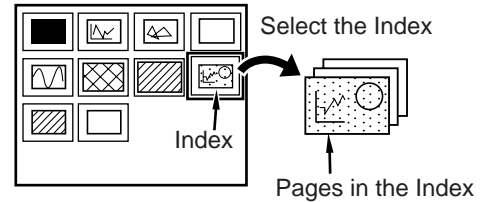

Index and Page

The data edited with Media Card Imager is the **Index** format consisting of several **Pages**. To project the desirable image, select the Index and then select the Page in the Index.

- This projector can project only the image data in Bit Map type or in JPEG type or the data edited by Media Card Imager (supplied) through the PC CARD SLOT. Other data is not available and should be edited and written in a memory card with Media Card Imager before loading PC CARD SLOT.
(The data in Bit Map type or in JPEG type, such as the data captured with a digital camera, can be projected directly through PC CARD SLOT.)
- If there are the data edited by Media Card Imager and other data (such as in Bit Map type or JPEG type) together in one memory card, the data edited by Media Card Imager has a priority to be projected with the LCD projector. The other image data in Bit Map type or JPEG type is not projected. In that case, edit those data and write in the memory card with the Media Card Imager.

INDEX SELECTION

- 1 Press the MENU button and the ON-SCREEN MENU will appear. Press the POINT LEFT/RIGHT buttons to select VIEW and press the SELECT button. Another dialog box VIEW SETTING menu will appear.
- 2 Press the POINT DOWN button and a red-arrow icon will appear. Move the arrow to "Index", and then press the SELECT button. The table of Indexes in the memory card will appear.
- 3 Press the POINT UP/DOWN/LEFT/RIGHT buttons to move to the Index that you want to project and press the SELECT button. The first Page of the Index selected is displayed.
(Press SELECT button again to display the table of Pages.)



VIEW

- Index
- Page
- Card access

Move the arrow to each operation and press the SELECT button.

PAGE SELECTION

- 1 Press the MENU button and the ON-SCREEN MENU will appear. Press the POINT LEFT/RIGHT buttons to select VIEW and press the SELECT button. Another dialog box VIEW SETTING menu will appear.
- 2 Press the POINT DOWN button and a red-arrow icon will appear. Move the arrow to "Page", and then press the SELECT button. The table of pages of the index card will appear.
- 3 Press the POINT UP/DOWN/LEFT/RIGHT buttons to move to the Page that you want to project and press the SELECT button. The page selected is displayed on the screen.
The table of Pages can be displayed by pressing the SELECT button when the page is displayed on full screen.

WRITE DATA INTO THE MEMORY CARD

The data edited by Media Card Imager in the computer can be written in or read from the memory card with the PC Card drive of your Personal Computer or the PC CARD Slot of this projector.

The data edited by Media Card Imager is written in Bit Map type (BMP) or JPEG type (JPG).

ACCESS TO THE MEMORY CARD THROUGH THE PROJECTOR

If your computer doesn't have the PC card writing equipment, the data can be written or read by connecting with this projector.

NOTE : This operation can be made only by Media Card Imager in the Personal Computer.

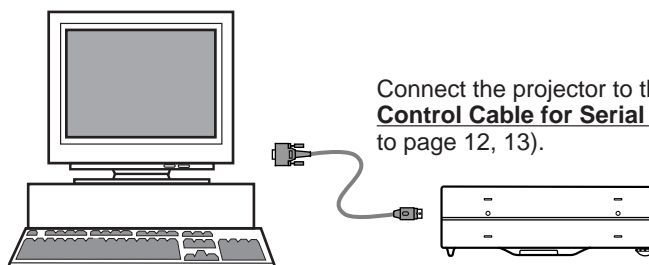

Connect the projector to the Personal Computer with the **Control Cable for Serial Port** (optionally supplied / refer to page 12, 13).

- 1 Connect the projector to your computer with the Control Cable for Serial Port (optionally supplied). (Refer to "CONNECTING COMPUTER" on Page 12, 13.)

Insert the memory card into PC CARD SLOT of the projector. And then, turn on the projector first and the computer.

- 2 Press the MENU button and the ON-SCREEN MENU will appear. Press the POINT LEFT/RIGHT buttons to select View and press the SELECT button. Another dialog box VIEW SETTING Menu will appear.

- 3 Press POINT DOWN button and a red arrow appear. Move the arrow to Card access by pressing POINT UP/DOWN button. And then press SELECT button. "Ready to access" is displayed.

Operate Media Card Imager of your computer to write/read the data in the PC card. (Refer to Owner's Manual of Media Card Imager for operation.)

NOTE : Connect the projector to the computer with Control Cable before turning those appliances on.

Do not press any button while read/write the data through PC CARD Slot of the projector. Those operations are canceled and the data in the memory card may be damaged.



VIEW

Index
Page
Card access

Move the arrow to each operation and press the SELECT button.

PICTURE IMAGE ADJUSTMENT

ADJUST THE PICTURE IMAGE MANUALLY

- 1 Press the MENU button and the ON-SCREEN MENU will appear. Press the POINT LEFT/RIGHT buttons to select IMAGE  and press the SELECT button. Another dialog box PICTURE IMAGE ADJUSTMENT Menu will appear.
- 2 Press the POINT DOWN button and a red-arrow icon will appear. Move the arrow to the item by pressing the POINT UP/DOWN buttons. To change the value press either the POINT RIGHT button or the POINT LEFT button.

White balance (Red / Green / Blue)

Move the arrow to Red, Green, or Blue that you want to adjust. Press POINT LEFT button to adjust the color of image lighter, and press POINT RIGHT button to adjust deeper. (From 0 to 63.)

Contrast

Press POINT LEFT button to adjust the image lighter, and press POINT RIGHT button to adjust deeper. (From 0 to 63.)

Brightness

Press POINT LEFT button to adjust the image darker, and press POINT RIGHT button to adjust brighter. (From 0 to 63.)

Each of the keys operates as follow.

- Reset** Recalls the data previously adjusted.
- Stored** Stores the adjusted data in the memory.
- Quit** Closes the PICTURE IMAGE ADJUSTMENT Menu.

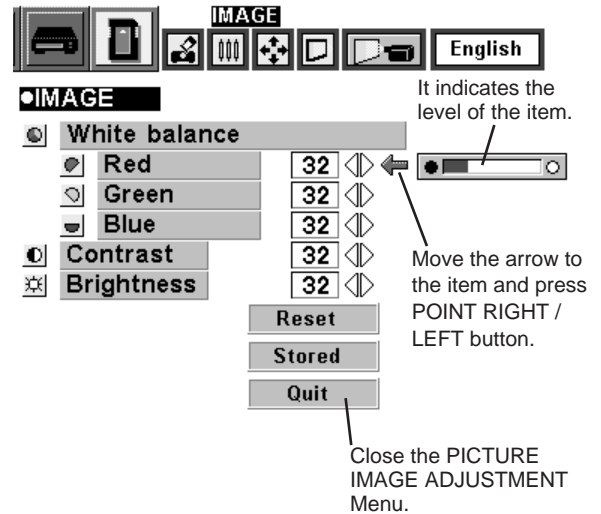

NORMAL FUNCTION

The normal picture level is preset on this projector at the factory and can be restored anytime you press the NORMAL button (located on the Top Control or on the Remote Control Unit). The "Normal" display will be displayed on the screen for a few seconds.

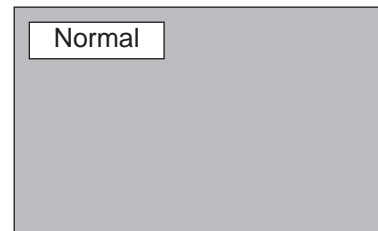

PICTURE POSITION ADJUSTMENT

The position of the image can be adjusted vertically and horizontally through PICTURE POSITION ADJUSTMENT.

- 1 Press the MENU button and the ON-SCREEN MENU will appear. Press the POINT LEFT/RIGHT buttons to select POSITION  and press the SELECT button. The PICTURE POSITION dialog box will appear.
- 2 Move the image by pressing the POINT UP / DOWN / RIGHT / LEFT buttons.

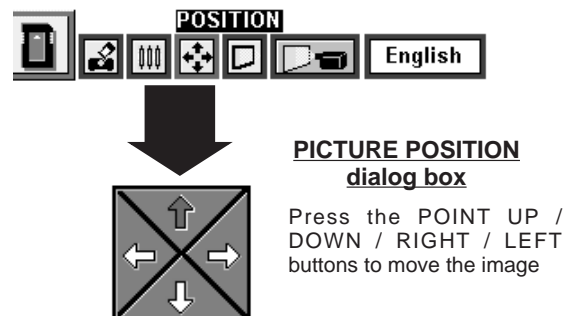

PICTURE SCREEN ADJUSTMENT

This projector has a picture screen resize function, which enables you to display the image in desirable size.

- 1 Press the MENU button and the ON-SCREEN MENU will appear. Press the POINT LEFT/RIGHT buttons to select SCREEN  and press the SELECT button. Another dialog box PICTURE SCREEN Menu will appear.
- 2 Press the POINT DOWN button and a red-arrow icon will appear. Move the arrow to the function that you want to select and then press SELECT button.



●SCREEN

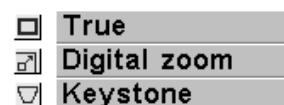

Move the arrow to the function and press the SELECT button.

True

To turn the image into its original size select True in the dialog box. When the original image size is larger than the screen size (800 x 600), this projector becomes Digital Zoom mode automatically.

Key Stone

When the image is distorted vertically, select Keystone in the dialog box. The ON-SCREEN menu and SCREEN ADJUST menu disappears and the message "Keystone" is displayed. Correct the Keystone distortion by pressing KEYSTONE ▲/▼ button or POINT UP/DOWN button(s). Refer to KEYSTONE ADJUSTMENT on page 21.

Digital Zoom

To adjust the image size or pan the image, select Digital zoom in the dialog box. The ON-SCREEN menu and SCREEN ADJUST menu disappears and the message "D. Zoom" is displayed.

This projector is also turned into Digital Zoom mode by pressing D.ZOOM ▲/▼ button on the Remote Control Unit. Refer to the following for operation.

Expand function

To expand the image size, press D.ZOOM ▲ button or SELECT button. The image is magnified by degrees. The maximum size of the projected image in expand mode is 4 times as large as the screen size (800 x 600).

Compress function

To compress the image size, press D.ZOOM ▼ button or RIGHT CLICK button. The size of image is reduced by degrees. The minimum size of the projected image in compress mode is 640 x 480 in VGA or 800 x 600 in SVGA / XGA.

Panning function

To pan the image, press POINT UP/DOWN/LEFT/RIGHT buttons. Panning function can work only when the image is larger than the screen size.

To cancel Digital Zoom mode, press the any buttons except D.ZOOM ▲/▼, SELECT, RIGHT CLICK, POINT, PAGE ▲/▼, AUTO IMAGE, or LASER button. To adjust the image to the screen size (800 x 600), press NORMAL button.

- This projector cannot display in the resolution higher than 1024 X 768. If your computer's screen resolution is higher than 1024 X 768, reset the resolution to the lower before connecting the projector.
- The image data in other than SVGA (800 x 600) is modified to fit the screen size in the initial mode.

SMARTMEDIA AND PC CARD ADAPTER

SmartMedia and PC Card Adapter are provided with this LCD projector. SmartMedia can be used as a PC card conforming to the PC Card Standard-ATA by combining with PC Card Adapter.

INSTALL / REMOVE THE SMARTMEDIA

INSTALL

Insert SmartMedia fully into PC Card Adapter. Make sure EJECT button pops out.

NOTE : The front side of SmartMedia has Contact Area on its surface.

The front side of PC Card Adapter has Eject button on the left side of the slot.

Do not insert SmartMedia in the reverse. The card and the data can be damaged.

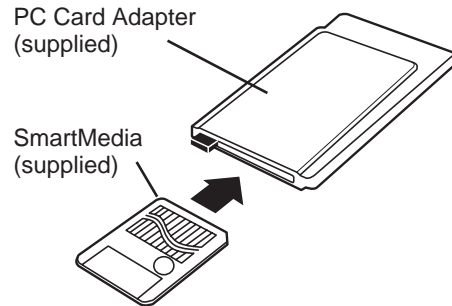

REMOVE

To remove SmartMedia, fully press in the EJECT button. The card pops out, then take out the card.

NOTE : Do not pull SmartMedia by force. It may damage SmartMedia or PC Card Adapter.

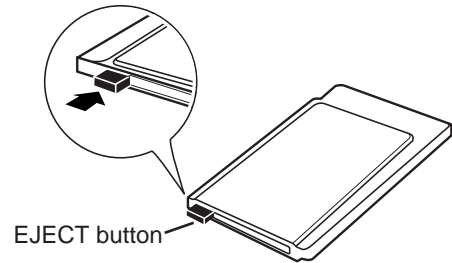

IMPORTANT NOTE

THE DATA STORED ON THE MEMORY CARD (SMARTMEDIA OR PC CARD) MAY BE DAMAGED OR LOST BECAUSE OF THE DAMAGE OF THE MEMORY CARD OR THE ACCIDENTAL ERASURE. IT IS RECOMMENDED THAT ANY IMPORTANT DATA SHOULD BE COPIED ONTO SEPARATE MEDIA, SUCH AS A FLOPPY DISK, A HARD DISK, OR A MO DISK. WE SHALL NOT BE LIABLE FOR ANY DAMAGE OR LOSS OF PROFITS ARISING FROM THE LOSS OF DATA BECAUSE OF THE ACCIDENTAL OPERATION AND THE DAMAGE OF A MEMORY CARD OR APPLIANCES. REFER TO OWNER'S MANUAL OF MEDIA CARD IMAGER FOR OPERATING THE SOFTWARE.

PRECAUTIONS AND SPECIFICATIONS OF THE SMARTMEDIA

- SmartMedia is a precision device. Do not bend it, drop it, subject it to strong forces or shocks or place where strong static electrical charge can be generated.
- Do not touch the surface of the Contact Area with fingers or allow it to be stained with foreign materials. Store SmartMedia inside its protective case when it is not used.
- SmartMedia is a consumable item. The data may not be written in or read from SmartMedia by using for a long time. In that case, replace SmartMedia with new one.
 - Memory capacity : 8MB
 - Operating voltage : 3.3 V DC
 - Usage environment
 - Temperature : 0~55 °C (during use)
 - 20~65 °C (during storage)
 - Humidity : less than 95% (during use, during storage)

CAUTION

Write Protect Sticker is not available for PC. When PC attempts to read the data from SmartMedia with Write Protect Sticker, it provides the error messages or the control of PC becomes insecure because of the property of the interface. When the error messages are displayed, press any key to return to the normal display. It is recommended, however, SmartMedia should be used on PC without Write Protect Sticker.

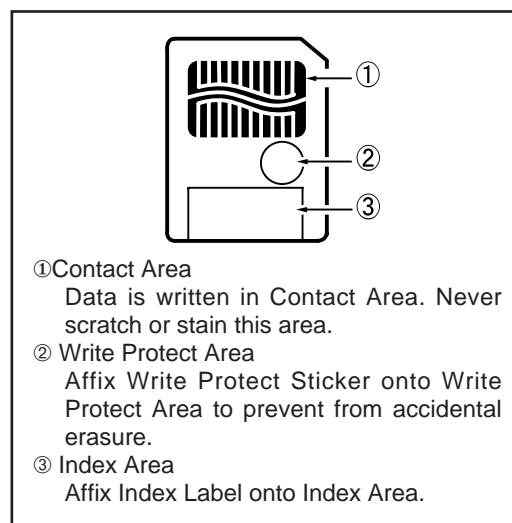

- ① Contact Area
Data is written in Contact Area. Never scratch or stain this area.
- ② Write Protect Area
Affix Write Protect Sticker onto Write Protect Area to prevent from accidental erasure.
- ③ Index Area
Affix Index Label onto Index Area.

PRECAUTIONS AND SPECIFICATIONS OF THE PC CARD ADAPTER

- Do not bend it, drop it, subject it to strong forces or shocks or place where strong static electrical charge can be generated.
- Do not insert materials other than SmartMedia. The adapter may be damaged. Store PC Card Adapter inside its protective case when it is not used.
- Do not shake the adapter, turn off the appliances, or remove SmartMedia from the PC Card Adapter during writing or reading data. It may damage the data in SmartMedia.
 - Operating voltage : 5 V DC
 - Usage environment
 - Temperature : 0~55 °C (during use)
 - 20~65 °C (during storage)
 - Humidity : less than 95%
 - (during use, during storage)

This adapter can be adapted to only our SmartMedia indicated below.

Available SmartMedia : 3.3V / 5V, 2MB / 4MB / 8MB / 16MB

SETTING MENU

- 1 Press the MENU button and the ON-SCREEN MENU will appear. Press the POINT LEFT/RIGHT buttons to select SETTING  and press the SELECT button. Another dialog box SETTING Menu will appear.
- 2 Press the POINT DOWN button and a red-arrow icon will appear. Move the arrow to the item that you want to set, and then press the SELECT button to set it "On" or "Off".

Blue back When this function is in the "On" position, this projector will produce a blue image instead of the video noise on the screen when all the input source is unplugged or turned off.

Display When this function is in the "On" position, the On-Screen Displays always appear when adjustments are made. (The following displays disappear by switching this function "Off.")

- Preparation Display
(The Number-counting-down Display)
- Mode Display
- Volume/Mute Display
- Zoom Display
- Focus Display
- Normal Display
- No show Display
- Keystone Display
- D.Zoom Display

Ceiling When this function is in the "On" position, the top / bottom and the left / right reversed picture is provided to project the image from a ceiling mounted projector.

Rear When this function is in the "On" position, the left / right reversed picture is provided to project the image to a rear projection screen.

Split wipe Turn this function "On" position in the SETTING menu. The picture will change into next one by sliding black image side ways like drawing the black curtains when the input source is turned into another one.

Lamp age The Lamp age function is designed to reset the lamp replacement monitor timer. When replacing the lamp, reset the lamp replacement monitor timer by using this function. (Refer to page 43.)



SETTING

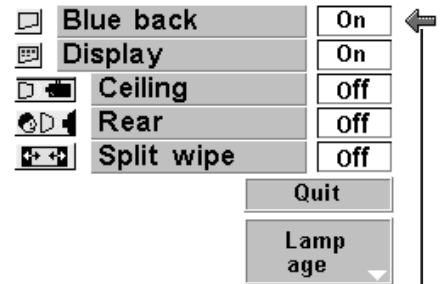

Set the Pointer to the item, and then press the SELECT button.

Ceiling function

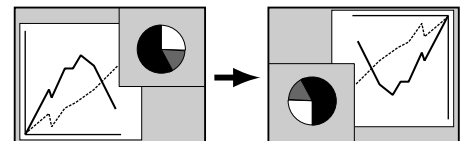

Rear function

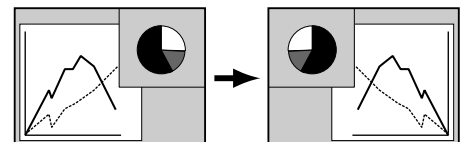

SELECTING LANGUAGE

The language used in the ON-SCREEN MENU is selectable from among English, German, French, Italian, Spanish and Japanese.

- 1 Press the MENU button and the ON-SCREEN MENU will appear. Press POINT LEFT/RIGHT buttons to select LANGUAGE  and press the SELECT button. Another dialog box LANGUAGE Menu will appear.
- 2 Press the POINT DOWN button and a red-arrow icon will appear. Move the arrow to the language that you want to set, and then press the SELECT button.



Move the Pointer to the language that you want to set, and then press the SELECT button.

OPERATING WIRELESS MOUSE

The Wireless Remote Control Unit is not only able to operate the projector but also usable as a wireless mouse for most Personal Computers. The POINT buttons and the two CLICK buttons are used for the wireless mouse operation.

The wireless mouse is usable when PC mouse pointer is displayed on the screen. When the menu or the indicator of the projector is displayed on the screen instead of the PC mouse pointer, the wireless mouse cannot be used.

INSTALLATION

To use the Wireless Remote Control Unit as the Wireless Mouse for a Personal Computer, installation of the mouse driver (not supplied) is required. Make sure that the mouse driver is properly installed in your computer. And make sure that the mouse port of the computer connected to Control Port is activated.

- 1 Connect the mouse port of your computer to the Control Port of the projector with the Control Cable. (Refer to page 10 to 13 for connection.)
- 2 Turn the projector on first, and then turn on your computer. When the computer is switched on first, the Wireless Mouse may not work properly.

Note : When the computer has no mouse port, connect the Serial Port of the computer to Control Port of the projector with the Control Cable for Serial Port.

OPERATING WIRELESS MOUSE

When controlling the pointer of the computer, operate the Wireless Mouse with POINT button, SELECT button, and RIGHT CLICK button on the Wireless Remote Control Unit.

POINT button

Used to move the pointer. The pointer is moved corresponding with the direction you are pressing.

SELECT (LEFT CLICK) button

This button has the same function as the left button in a PC mouse.

RIGHT CLICK button

This button has the same function as the right button in a PC mouse. Pressing this button does not affect any operation when in Menu mode.

POINT button (Move the pointer)

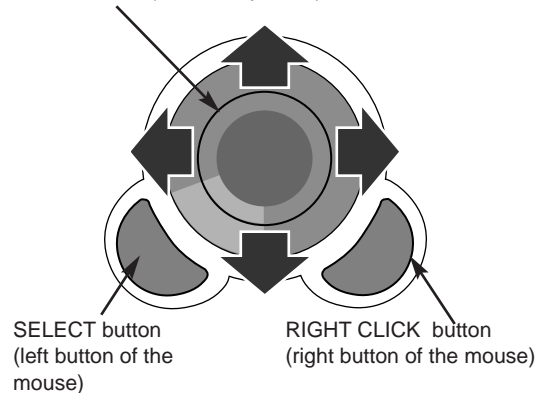

MAINTENANCE

TEMPERATURE WARNING INDICATOR

The TEMPERATURE WARNING Indicator flashes red when the internal temperature of the projector exceeds the normal temperature. The Indicator stops flashing when the temperature of the projector become normal. When the TEMPERATURE WARNING Indicator continues to flash, check the item listed below.

- 1 The Ventilation slots of the projector may be blocked. In such an event, reposition the appliance so that the ventilation slots are not obstructed.
- 2 Air filters are clogged with dust particles. Clean the air filters by following AIR FILTER CARE AND CLEANING below.
- 3 If the TEMPERATURE WARNING Indicator remains on after performing the above checks, the Cooling Fans or the Internal Circuits may be malfunctioning. Request service from an authorized dealer or service station.

AIR FILTER CARE AND CLEANING

The Removable Air Filters prevent dust from accumulating on the surface of the Projection Lens and the Projection Mirror. Should the Air Filters become clogged with dust particles, it will reduce the Cooling Fans' effectiveness and may result in internal heat build up and adversely affect on the life of the projector. Clean the Air Filters following the steps below:

- 1 Turn the power off, and disconnect the AC power cord from the AC outlet.
- 2 Turn the projector upside down and remove 2 Air Filters by pulling the latches of them upward.
- 3 Clean the Air Filters with brush or wash out the dust and particles.
- 4 Replace the Air Filter. Make sure that the Air Filters are fully inserted.

AIR FILTERS

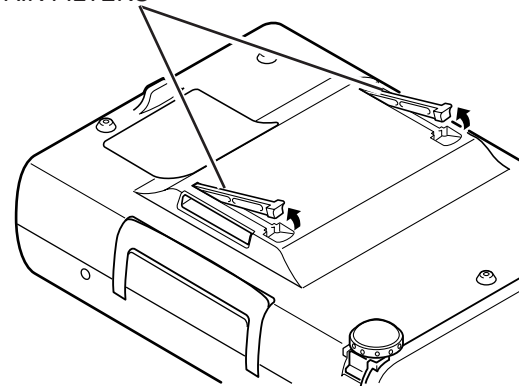

CAUTION

Do not operate the projector with the Air Filter removed. The dust is stuck on the LCD Panel and the Mirror, and it may spoil the fine picture image.
Do not put the small parts into the Air Intake Vents. It result in the malfunction of the projector.
The Air Filter is small part. Take care that children don't eat or swallow it.

RECOMMENDATION

We recommend to avoid dusty/smoky place for operating the projector. Using in dusty place may cause the picture of poor quality.

When using under the dusty or smoky conditions, dust may accumulate on the liquid crystal panel and lens inside it, and may resultantly be projected on the screen together with the picture.
When the above symptoms are noticed, contact your authorized dealer or service station for the cleaning.

CLEANING THE PROJECTION LENS

Follow these steps to clean the projection lens:

- 1 Apply a non-abrasive camera lens cleaner to a soft, dry cleaning cloth. Avoid using an excessive amount of cleaner. Abrasive cleaners, solvents or other harsh chemicals might scratch the lens.
- 2 Lightly wipe the cleaning cloth over the lens.
- 3 When you don't use the projector, replace the lens cover.

LAMP REPLACEMENT INDICATOR

When the life of the Lamp of this projector draws to an end, the LAMP REPLACEMENT indicator lights yellow. When the image becomes dark or the color of the image become unnatural, replacement of the Lamp is required.

LAMP REPLACEMENT



CAUTION

- For continued safety, replace with a lamp assembly of the same type.
- Allow the projector to cool for at least 45 minutes before you open the lamp cover. The inside of the projector can become very hot.
- Do not drop the lamp assembly or touch the glass bulb! The glass can shatter and may cause injury.

Follow these steps to replace the lamp assembly.

- 1 Turn off the projector and disconnect the AC plug. Allow the projector to cool for at least 45 minutes.
- 2 Remove a screw with a screwdriver and remove the Lamp Cover.
- 3 Remove 2 screws with a screwdriver and pull out the Lamp Assembly by grasping the handle.
- 4 Replace the Lamp Assembly with new one and tighten 2 screws. Make sure that the Lamp Assembly is set properly. And replace the Lamp Cover and tighten a screw.
- 5 Connect the AC Power Cord to the projector and turn the projector on.
- 6 Reset the Lamp Replacement Monitor Timer (refer to the section "Lamp Replacement Monitor Timer" below).

NOTE : Do not reset the LAMP REPLACEMENT MONITOR TIMER, when the lamp is not replaced.

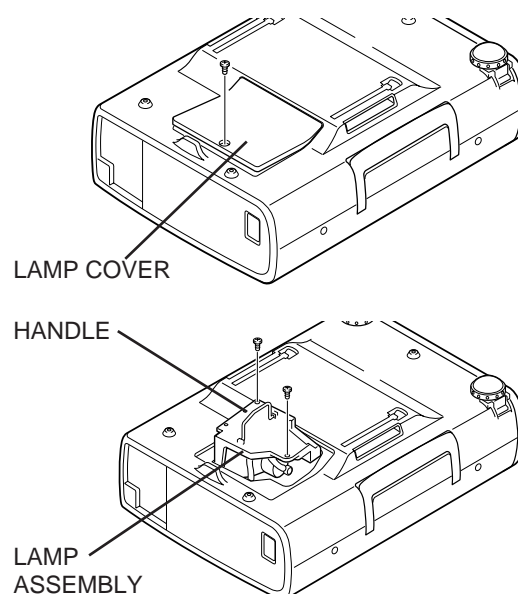

ORDER REPLACEMENT LAMP

Replacement Lamp can be ordered through your dealer. When ordering the Lamp, give the following information to the dealer.

- Model No. of your projector : PLC-SU22N
- Replacement Lamp Type No. : POA-LMP21J
(Service Parts No. 610 280 6939)

LAMP REPLACEMENT MONITOR TIMER

Be sure to reset the Lamp Replacement Monitor Timer when the Lamp Assembly is replaced. When the Lamp Replacement Monitor Timer is reset, the LAMP REPLACEMENT indicator stops lighting.

- 1 Turn the projector on, and press the MENU button and the ON-SCREEN MENU will appear. Press the POINT LEFT/RIGHT buttons to select SETTING  and press the SELECT button (refer to the page 40). Another dialog box SETTING MENU will appear.
- 2 Press the POINT DOWN button and a red-arrow icon will appear. Move the arrow to "Lamp age", and then press the SELECT button. The message "Lamp replace monitor Reset?" is displayed.
- 3 Select [Yes] to reset the Timer.

Do not reset the Lamp Replacement Monitor Timer, except after the lamp is replaced.

TROUBLESHOOTING

Before calling your dealer or service station for assistance, check the matters below once again.

1. Make sure you have connected the projector to your equipment as described in section "CONNECTING THE PROJECTOR" on pages 10 ~ 13.
2. Check cable connection. Verify that all computer, video and power cord are properly connected.
3. Verify that all power is switched on.
4. If the projector still does not produce the image, re-start the computer.
5. If the image still does not appear, unplug the projector from the computer and check the computer monitor's display. The problem may be with your graphics controller rather than with the projector. (When you reconnect the projector, remember to turn the computer and monitor off before you power up the projector. Power the equipment back in order of : Projector and computer.)
6. If the problem still exists, check with following chart.

Problem:	Try these Solution
No power.	<ul style="list-style-type: none"> ● Plug the projector into the AC outlet. ● Be sure READY Indicator light is On. ● Wait 90 seconds after the projector is turned OFF before turning the projector back on. <p>NOTE : After pressing the power ON-OFF switch to OFF, make sure the projector works as follow.</p> <ol style="list-style-type: none"> 1. The LAMP indicator will light and the READY indicator will turn off. 2. After 90 seconds, the READY indicator will light green again and the projector may be turned on by pressing the power ON-OFF button. <ul style="list-style-type: none"> ● Check the TEMPERATURE WARNING indicator. If the indicator flashes red, the projector cannot be turned on. (See "TURNING ON/OFF THE PROJECTOR" section on page 20.) ● Check the Projection Lamp. (Refer to the page 43.)
Image is out of focus.	<ul style="list-style-type: none"> ● Adjust the focus ● Make sure the projection screen is at least 4.6' (1.4m) from the projector. ● Check the projection lens to see if it needs cleaning. <p>NOTE : Moving the projector from a cool temperature location to a warm temperature location may result in moisture condensation on the lens. In such an event, leave the projector OFF and wait until condensation disappears.</p>
Picture is Left/Right reversed.	<ul style="list-style-type: none"> ● Check Ceiling / Rear feature. (See "SETTING" section on page 40.)
Picture is Top/Bottom reversed.	<ul style="list-style-type: none"> ● Check Ceiling feature. (See "SETTING" section on page 40.)
Some displays are not seen during the Operation.	<ul style="list-style-type: none"> ● Check Display feature.(See "SETTING" section on page 40.)
No image.	<ul style="list-style-type: none"> ● Check the connection between the computer or video equipment and the projector. ● When turning the projector on, it is about 30 seconds to display the image. ● Check the system that you select is corresponding with the computer or the video equipment. ● Make sure the temperature is not out of the Operating Temperature (5° ~ 35°).
No sound.	<ul style="list-style-type: none"> ● Check audio cable connection from audio input source. ● Adjust the audio source. ● Press VOLUME (+) button. ● Press MUTE button.

Problem:	Try these Solution
Remote Control Unit does not work.	<ul style="list-style-type: none"> ● Check the batteries. ● Check the ALL-OFF switch on the Remote Control Unit is set to "ON." ● Make sure anything is blocking between the Remote Receiver and the Remote Control Unit. ● Make sure you are not too far from the projector when using the Remote Control Unit. Maximum operating range is 16.4' (5m).
Wireless Mouse function does not work.	<ul style="list-style-type: none"> ● Check the cable connection between the projector and the computer. ● Check the mouse setting on your computer. ● Turn the projector before your turn on the computer.
The image data in memory card isn't displayed.	<ul style="list-style-type: none"> ● Check the memory card is inserted properly into PC CARD SLOT. ● Check SmartMedia or PC Card Adapter is set properly. ● Check MCI mode is selected. ● Check the image data is recorded in the memory card properly. ● Start the projector again.
The image data can't be written in, read from the memory card.	<ul style="list-style-type: none"> ● Check the projector is turned on. ● Check "Card access" in VIEW menu is selected. ● Check Control Cable for Serial Port (optional) is connected properly. ● Check the memory card is inserted properly into PC CARD SLOT. ● Check Media Card Imager (supplied) is installed in your computer properly. ● Check the setting in Media Card Imager (like Serial Port Setting) is set properly.

WARNING :

High voltages are used to operate this projector. Do not attempt to open the cabinet.

Sanyo Service is easily obtained. If after following all operating instructions, you find that service is necessary, contact the SFS Corporation in Los Angeles, or the store where you purchased the unit. Give the model number and explain the difficulty. We will advise you how to obtain service.

TECHNICAL SPECIFICATIONS

Projector Type	Multi-media Projector
Dimensions (W x H x D)	9.41" x 3.54" x 12.72"(239mm x 90mm x 323mm) (not including Adjustable Feet)
Net Weight	8.82 lbs (4.0 kg)
LCD Panel System	0.9" TFT Active Matrix type, 3 panels
Panel Resolution	800 x 600 dots
Number of Pixels	1,440,000 (800 x 600 x 3 panels)
Color System	PAL, SECAM, NTSC, NTSC4.43, PAL-M and PAL-N
Scanning Frequency	H-sync. 15 ~ 80 KHz, V-sync. 50 ~ 100 Hz
Projection Image size (Diagonal)	Adjustable from 30" to 300"
Horizontal Resolution	750 TV lines
Projection Lens	F 1.7 ~ 2.0 lens with f 33.2mm ~ 43.1mm Motor zoom and focus
Throw Distance	4.6' ~ 35.4' (1.4 m ~ 10.8 m)
Projection Lamp	150 W
AV Input Jacks	RCA Type x 1 (Video, Audio R and L) and DIN 4 pin (S-Video) x 1
Computer Input Jacks	(VGA) HDB 15 Terminal x 1
Control Port Jack	DIN 8 pin x 1
Monitor Output Jack	(VGA) HDB 15 Terminal x 1
Computer Audio Input Jack	Mini Jack (stereo)
Audio Output Jack	Mini Jack (stereo)
Internal Audio Amp	1W RMS (Monaural)
Built-in Speaker	1 speaker, 1.57" x 1.18" (40mm x 30mm)
Feet Adjustment	0° to 10°
Voltage	AC 100 ~ 120 V, 50 / 60 Hz
Power Consumption	2.5 A (Max. Ampere)
Operating Temperature	41 °F ~ 95 °F (5 °C ~ 35 °C)
Storage Temperature	14 °F ~ 140 °F (-10 °C ~ 60 °C)
Remote Control Transmitter	Power Source : AA Type x 2 Operating Range : 16.4' (5m) / ±30° Dimensions : 2.2" x 1.3" x 7.6" (55mm x 34mm x 192mm) Net Weight : 0.35 lbs (160 g) (including batteries) Laser Pointer : Class II Laser (Max. Output : 1mW / Wave length : 650±20nm)
Accessories	Owner's Manual AC Power Cord Remote Control Transmitter and Batteries VGA Cable Control Cable for PS/2 port Media Card Imager for Windows 95 (CD-ROM) and Owner's Manual for this software SmartMedia and PC Card Adapter Dust Cover Lens Cover

- The specifications are subject to change without notice.



This symbol on the nameplate means the product is Listed by Underwriters Laboratories Inc. It is designed and manufactured to meet rigid U.L. safety standards against risk of fire, casualty and electrical hazards.

OPTIONAL PARTS

The parts listed below are optionally supplied. When ordering those parts, give the name and the Type No. of it to the sales dealer.

- Control Cable for Serial Port Type No. : POA-MCSRL
- Control Cable for ADB Port Type No. : POA-MCMAC
- MAC Adapter Type No. : POA-MACAP

**SANYO INDUSTRIAL VIDEO
LCD PROJECTOR LIMITED WARRANTY**

OBLIGATIONS

In order to obtain warranty service, the product must be delivered to and picked up from and Authorized Sanyo Factory Service Center at the user's expense, unless specifically stated otherwise in this warranty. The names and addresses of authorized Sanyo Service Centers may be obtained by calling the toll-free number listed below.

For product operation, authorized service center referral, service assistance or problem resolution, call

**CUSTOMER INFORMATION 1-800-421-5013
Weekdays 8:00 AM - 5:00 PM Pacific Time**

For accessories and/or parts not available from an authorized dealer, call

**PARTS ORDER INFORMATION 1-800-726-9662
Weekdays 8:00 AM - 5:00 PM Pacific Time**

THIS WARRANTY IS VALID ONLY ON SANYO PRODUCTS PURCHASED OR RENTED AND USED IN THE UNITED STATES OF AMERICA, EXCLUDING ALL U.S. TERRITORIES AND PROTECTORATES, FOR INDUSTRIAL PROFESSIONAL OR COMMERCIAL PURPOSES. THIS WARRANTY APPLIES ONLY TO THE ORIGINAL RETAIL USER. THE ORIGINAL DATED BILL OF SALE, SALES SLIP OR RENTAL AGREEMENT MUST BE SUBMITTED TO THE AUTHORIZED SANYO SERVICE CENTER AT THE TIME WARRANTY SERVICE IS REQUESTED.

Subject to the OBLIGATIONS above and EXCLUSIONS below, SANYO FISHER COMPANY (SFC) warrants this SANYO product against defects in materials and workmanship for the periods of LABOR and PARTS specified below. SFC will repair or replace (at its option) the product and any of its parts which fail to conform to this warranty. The warranty period commences on the date the product was first purchased or rented at retail.

LABOR	PARTS	LAMP
1YEAR	1YEAR	90DAYS

EXCLUSIONS

This warranty does not cover (A) the adjustment of customer-operated controls as explained in the appropriate model's instruction manual, or (B) the repair of any product whose serial number has been altered, defaced or removed.

This warranty shall not apply to the cabinet or cosmetic parts, knobs or batteries or routine maintenance.

This warranty does not apply to uncrating, setup, installation, removal of the product for repair or reinstallation of the product after repair.

This warranty does not apply to repairs or replacements necessitated by any cause beyond the control of SFC including, but not limited to, any malfunction, defect or failure caused by or resulting from unauthorized service or parts, improper maintenance, operation contrary to furnished instructions, shipping or transit accidents, modification or repair by the user, abuse, misuse, neglect, accident, incorrect power line voltage, fire, flood or other Acts of God, or normal wear and tear.

The foregoing is in lieu of all other expressed warranties and SFC does not assume or authorize any party to assume for it any other obligation or liability.

SFC DISCLAIMS ALL WARRANTIES WHICH MAY BE IMPLIED BY LAW (INCLUDING THE WARRANTIES OF MERCHANTABILITY AND FITNESS), SFC'S LIABILITY FOR ANY AND ALL LOSSES AND DAMAGES RESULTING FROM ANY CAUSE WHATSOEVER, INCLUDING WARRANTOR'S NEGLIGENCE, ALLEGED DAMAGED OR DEFECTIVE GOODS, WHETHER SUCH DEFECTS ARE DISCOVERABLE OR LATENT, SHALL IN NO EVENT EXCEED THE PURCHASE PRICE OF THE EQUIPMENT.

ATTENTION

For your protection in the event of theft or loss of this product, please fill in the information below for your own personal records.

Model No. _____

Serial No. _____

(Located on back or bottom side of unit.)

Date of Purchase _____ Purchase Price _____

Where Purchased _____



21605 Plummer Street,
Chatsworth, California 91311