

Portable Projector

***NP610/NP510/NP410/NP405/
NP310/NP305/NP510W/NP410W
NP610S/NP510WS***

User's Manual



NP610/NP510/NP410/NP405/NP310/NP305/NP510W/NP410W



NP610S/NP510WS

- IBM is a trademark or registered trademark of International Business Machines Corporation.
- Macintosh, Mac OS X and PowerBook are trademarks of Apple Inc. registered in the U.S. and other countries.
- Microsoft, Windows, Windows Vista, Internet Explorer, .NET Framework and PowerPoint are either a registered trademark or trademark of Microsoft Corporation in the United States and/or other countries.
- MicroSaver is a registered trademark of Kensington Computer Products Group, a division of ACCO Brands.
- Virtual Remote Tool uses WinI2C/DDC library, © Nicomsoft Ltd.
- Other product and company names mentioned in this user's manual may be the trademarks or registered trademarks of their respective holders.

NOTES

- (1) The contents of this user's manual may not be reprinted in part or whole without permission.
- (2) The contents of this user's manual are subject to change without notice.
- (3) Great care has been taken in the preparation of this user's manual; however, should you notice any questionable points, errors or omissions, please contact us.
- (4) Notwithstanding article (3), NEC will not be responsible for any claims on loss of profit or other matters deemed to result from using the Projector.

Important Information

Safety Cautions

Precautions

Please read this manual carefully before using your NEC NP610, NP510, NP410, NP405, NP310, NP305, NP510W, NP410W, NP610S, and NP510WS projector and keep the manual handy for future reference.

CAUTION



To turn off main power, be sure to remove the plug from power outlet.
The power outlet socket should be installed as near to the equipment as possible, and should be easily accessible.

CAUTION



TO PREVENT SHOCK, DO NOT OPEN THE CABINET.
THERE ARE HIGH-VOLTAGE COMPONENTS INSIDE.
REFER SERVICING TO QUALIFIED SERVICE PERSONNEL.



This symbol warns the user that uninsulated voltage within the unit may be sufficient to cause electrical shock. Therefore, it is dangerous to make any kind of contact with any part inside of the unit.



This symbol alerts the user that important information concerning the operation and maintenance of this unit has been provided.
The information should be read carefully to avoid problems.

WARNING: TO PREVENT FIRE OR SHOCK, DO NOT EXPOSE THIS UNIT TO RAIN OR MOISTURE. DO NOT USE THIS UNIT'S PLUG WITH AN EXTENSION CORD OR IN AN OUTLET UNLESS ALL THE PRONGS CAN BE FULLY INSERTED.

DOC Compliance Notice (for Canada only)

This Class B digital apparatus meets all requirements of the Canadian Interference-Causing Equipment Regulations.

Machine Noise Information Regulation - 3. GPSGV,

The highest sound pressure level is less than 70 dB (A) in accordance with EN ISO 7779.

CAUTION



Avoid displaying stationary images for a prolonged period of time.
Doing so can result in these images being temporarily sustained on the surface of the LCD panel.
If this should happen, continue to use your projector. The static background from previous images will disappear.

Disposing of your used product



EU-wide legislation as implemented in each Member State requires that used electrical and electronic products carrying the mark (left) must be disposed of separately from normal household waste. This includes projectors and their electrical accessories or lamps. When you dispose of such products, please follow the guidance of your local authority and/or ask the shop where you purchased the product.

After collecting the used products, they are reused and recycled in a proper way. This effort will help us reduce the wastes as well as the negative impact such as mercury contained in a lamp to the human health and the environment at the minimum level.

The mark on the electrical and electronic products only applies to the current European Union Member States.

WARNING TO CALIFORNIA RESIDENTS:

Handling the cables supplied with this product will expose you to lead, a chemical known to the State of California to cause birth defects or other reproductive harm. *WASH HANDS AFTER HANDLING.*

RF Interference (for USA only)

WARNING

The Federal Communications Commission does not allow any modifications or changes to the unit EXCEPT those specified by NEC Display Solutions of America, Inc. in this manual. Failure to comply with this government regulation could void your right to operate this equipment. This equipment has been tested and found to comply with the limits for a Class B digital device, pursuant to Part 15 of the FCC Rules. These limits are designed to provide reasonable protection against harmful interference in a residential installation. This equipment generates, uses, and can radiate radio frequency energy and, if not installed and used in accordance with the instructions, may cause harmful interference to radio communications. However, there is no guarantee that interference will not occur in a particular installation.

If this equipment does cause harmful interference to radio or television reception, which can be determined by turning the equipment off and on, the user is encouraged to try to correct the interference by one or more of the following measures:

- Reorient or relocate the receiving antenna.
- Increase the separation between the equipment and receiver.
- Connect the equipment into an outlet on a circuit different from that to which the receiver is connected.
- Consult the dealer or an experienced radio / TV technician for help.

For UK only: In UK, a BS approved power cable with moulded plug has a Black (five Amps) fuse installed for use with this equipment. If a power cable is not supplied with this equipment please contact your supplier.

Important Safeguards

These safety instructions are to ensure the long life of your projector and to prevent fire and shock. Please read them carefully and heed all warnings.

Installation

- Do not place the projector in the following conditions:
 - on an unstable cart, stand, or table.
 - near water, baths, or damp rooms.
 - in direct sunlight, near heaters, or heat radiating appliances.
 - in a dusty, smoky or steamy environment.
 - on a sheet of paper or cloth, rugs or carpets.
- If you wish to have the projector installed on the ceiling:
 - Do not attempt to install the projector yourself.
 - The projector must be installed by qualified technicians in order to ensure proper operation and reduce the risk of bodily injury.
 - In addition, the ceiling must be strong enough to support the projector and the installation must be in accordance with any local building codes.
 - Please consult your dealer for more information.

WARNING

- Do not cover the lens with the lens cap or equivalent while the projector is on. Doing so can lead to melting of the cap due to the heat emitted from the light output.
- Do not place any objects, which are easily affected by heat, in front of the projector lens. Doing so could lead to the object melting from the heat that is emitted from the light output.



Place the projector in a horizontal position

The tilt angle of the projector should not exceed 10 degrees, nor should the projector be installed in any way other than the desktop and ceiling mount, otherwise lamp life could decrease dramatically.

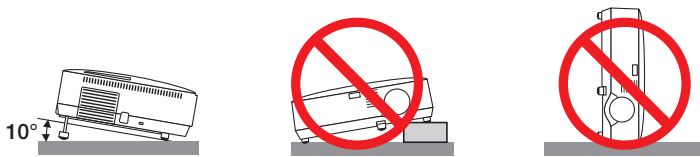

⚠ Fire and Shock Precautions ⚡

- Ensure that there is sufficient ventilation and that vents are unobstructed to prevent the build-up of heat inside your projector. Allow at least 4 inches (10cm) of space between your projector and a wall.
- Do not try to touch the ventilation outlet on the left front (when seen from the front) as it can become heated while the projector is turned on and immediately after the projector is turned off.



- Prevent foreign objects such as paper clips and bits of paper from falling into your projector. Do not attempt to retrieve any objects that might fall into your projector. Do not insert any metal objects such as a wire or screwdriver into your projector. If something should fall into your projector, disconnect it immediately and have the object removed by a qualified service personnel.
- Do not place any objects on top of the projector.
- Do not touch the power plug during a thunderstorm. Doing so can cause electrical shock or fire.
- The projector is designed to operate on a power supply of 100-240V AC 50/60 Hz (NP610/NP510/NP410/NP405/NP310/NP305/NP510W/NP410W/NP610S/NP510WS) or 200-240V AC 50/60 Hz (NP610G/NP510G/NP410G/NP405G/NP310G/NP305G/NP510WG/ NP410WG/NP610SG/NP510WSG). Ensure that your power supply fits this requirement before attempting to use your projector.
- Do not look into the lens while the projector is on. Serious damage to your eyes could result.



- Keep any items such as magnifying glass out of the light path of the projector. The light being projected from the lens is extensive, therefore any kind of abnormal objects that can redirect light coming out of the lens, can cause unpredictable outcome such as fire or injury to the eyes.
- Do not place any objects, which are easily affected by heat, in front of a projector exhaust vent. Doing so could lead to the object melting or getting your hands burned from the heat that is emitted from the exhaust.

- Handle the power cable carefully. A damaged or frayed power cable can cause electric shock or fire.
 - Do not use any power cables than the supplied one.
 - Do not bend or tug the power cable excessively.
 - Do not place the power cable under the projector, or any heavy object.
 - Do not cover the power cable with other soft materials such as rugs.
 - Do not heat the power cable.
 - Do not handle the power plug with wet hands.
- Turn off the projector, unplug the power cable and have the projector serviced by a qualified service personnel under the following conditions:
 - When the power cable or plug is damaged or frayed.
 - If liquid has been spilled into the projector, or if it has been exposed to rain or water.
 - If the projector does not operate normally when you follow the instructions described in this user's manual.
 - If the projector has been dropped or the cabinet has been damaged.
 - If the projector exhibits a distinct change in performance, indicating a need for service.
- Disconnect the power cable and any other cables before carrying the projector.
- Turn off the projector and unplug the power cable before cleaning the cabinet or replacing the lamp.
- Turn off the projector and unplug the power cable if the projector is not to be used for an extended period of time.
- When using a LAN cable (only models with the RJ-45 LAN port):
For safety, do not connect to the connector for peripheral device wiring that might have excessive voltage.

CAUTION

- Do not use the tilt-foot for purposes other than originally intended. Misuses such as gripping the tilt-foot or hanging on the wall can cause damage to the projector.
- Do not send the projector in the soft case by parcel delivery service or cargo shipment. The projector inside the soft case could be damaged.
- Select [HIGH] in Fan mode if you continue to use the projector for consecutive days. (From the menu, select [SETUP] → [OPTIONS(1)] → [FAN MODE] → [HIGH].)
- Do not try to touch the ventilation outlet on the left front (when seen from the front) as it can become heated while the projector is turned on and immediately after the projector is turned off.
- Do not turn off the AC power for 60 seconds after the lamp is turned on and while the POWER indicator is blinking green. Doing so could cause premature lamp failure.

Remote Control Precautions

- Handle the remote control carefully.
- If the remote control gets wet, wipe it dry immediately.
- Avoid excessive heat and humidity.
- Do not heat, take apart, or throw batteries into fire.
- If you will not be using the remote control for a long time, remove the batteries.
- Ensure that you have the batteries' polarity (+/-) aligned correctly.
- Do not use new and old batteries together, or use different types of batteries together.
- Dispose of used batteries according to your local regulations.

Note for US Residents

The lamp in this product contains mercury. Please dispose according to Local, State or Federal Laws.

Lamp Replacement

- To replace the lamp, follow all instructions provided on page 84.
- Be sure to replace the lamp when the message **[THE LAMP HAS REACHED THE END OF ITS USABLE LIFE. PLEASE REPLACE THE LAMP.]** appears. If you continue to use the lamp after the lamp has reached the end of its usable life, the lamp bulb may shatter, and pieces of glass may be scattered in the lamp case. Do not touch them as the pieces of glass may cause injury.
If this happens, contact your dealer for lamp replacement.

A Lamp Characteristic

The projector has a high-pressure mercury lamp as a light source.

A lamp has a characteristic that its brightness gradually decreases with age. Also repeatedly turning the lamp on and off will increase the possibility of its lower brightness.

CAUTION:

- DO NOT TOUCH THE LAMP immediately after it has been used. It will be extremely hot. Turn the projector off and then disconnect the power cable. Allow at least one hour for the lamp to cool before handling.
- When removing the lamp from a ceiling-mounted projector, make sure that no one is under the projector. Glass fragments could fall if the lamp has been burned out.

About High Altitude mode

- Set [FAN MODE] to [HIGH ALTITUDE] when using the projector at altitudes approximately 5500 feet/1600 meters or higher.
Using the projector at altitudes approximately 5500 feet/1600 meters or higher without setting to [HIGH ALTITUDE] can cause the projector to overheat and the projector could shut down. If this happens, wait a couple minutes and turn on the projector.
- Using the projector at altitudes less than approximately 5500 feet/1600 meters and setting to [HIGH ALTITUDE] can cause the lamp to overcool, causing the image to flicker. Switch [FAN MODE] to [AUTO].
- Using the projector at altitudes approximately 5500 feet/1600 meters or higher can shorten the life of optical components such as the lamp.

About Copyright of original projected pictures:

Please note that using this projector for the purpose of commercial gain or the attraction of public attention in a venue such as a coffee shop or hotel and employing compression or expansion of the screen image with the following functions may raise concern about the infringement of copyrights which are protected by copyright law.

[ASPECT RATIO], [KEYSTONE], Magnifying feature and other similar features.

Table of Contents

Important Information	i
1. Introduction	1
1 What's in the Box?.....	1
2 Introduction to the Projector.....	2
Congratulations on Your Purchase of the Projector.....	2
Features you'll enjoy:.....	2
About this user's manual.....	3
3 Part Names of the Projector.....	5
Front/Top.....	5
Rear.....	6
Top Features.....	7
Terminal Panel Features.....	8
4 Part Names of the Remote Control.....	9
Battery Installation.....	10
Remote Control Precautions.....	10
Operating Range for Wireless Remote Control.....	10
2. Installation and Connections	11
1 Setting Up the Screen and the Projector.....	11
Selecting a Location.....	11
Throw Distance and Screen Size.....	15
2 Making Connections.....	17
Enabling the computer's external display.....	17
Connecting Your PC or Macintosh Computer.....	17
When Viewing a DVI Digital Signal (except NP405 and NP305).....	19
Using Two Analog COMPUTER Inputs Simultaneously.....	20
Connecting an External Monitor.....	21
Connecting Your DVD Player with Component Output.....	22
Connecting Your VCR.....	23
Connecting to a Network (except NP405 and NP305).....	24
Connecting the Supplied Power Cable.....	25
3. Projecting an Image (Basic Operation)	26
1 Turning on the Projector.....	26
Note on Startup screen (Menu Language Select screen).....	28
2 Selecting a Source.....	29
Selecting the computer or video source.....	29
3 Adjusting the Picture Size and Position.....	30
Adjust the Tilt Foot.....	31
Zoom.....	32
Adjusting from the menu.....	32
Focus.....	33
4 Correcting Keystone Distortion.....	34
Correcting Keystone Distortion.....	34
Adjusting with buttons on the cabinet.....	34
Adjusting from the menu.....	35
Adjusting with the Auto Keystone Function.....	36

5	Optimizing Computer Signal Automatically	37
	Adjusting the Image Using Auto Adjust.....	37
6	Turning Up or Down Volume	37
7	Turning off the Projector	38
8	After Use.....	39
4.	Convenient Features	40
1	Turning off the Image and Sound	40
2	Freezing a Picture	40
3	Enlarging a Picture	40
4	Changing Eco Mode.....	41
5	Checking Energy-Saving Effect [CARBON METER].....	42
6	Preventing the Unauthorized Use of the Projector [SECURITY]	43
7	Using the Optional Remote Mouse Receiver (NP01MR)	46
8	Network Setting by Using an HTTP Browser (except NP405 and NP305).....	48
9	Using the VGA Signal Cable to Operate the Projector (Virtual Remote).....	51
5.	Using On-Screen Menu	56
1	Using the Menus.....	56
2	Menu Elements.....	57
3	List of Menu Items	58
4	Menu Descriptions & Functions [SOURCE]	60
5	Menu Descriptions & Functions [ADJUST].....	61
6	Menu Descriptions & Functions [SETUP].....	68
7	Menu Descriptions & Functions [INFO.]	78
8	Menu Descriptions & Functions [RESET].....	80
6.	Maintenance	81
1	Cleaning or Replacing the Filters	81
2	Cleaning the Cabinet and the Lens	83
3	Replacing the Lamp.....	84
7.	Appendix	87
1	Troubleshooting	87
	Indicator Messages.....	87
2	Specifications	90
3	Cabinet Dimensions	94
4	Pin Assignments of D-Sub COMPUTER Input Connector	96
	Mini D-Sub 15 Pin Connector	96
5	Compatible Input Signal List.....	97
6	PC Control Codes and Cable Connection	98
	PC Control Codes.....	98
	Cable Connection	98
	PC Control Connector (D-SUB 9P).....	98
7	Troubleshooting Check List.....	99
8	TravelCare Guide.....	101

1. Introduction

① What's in the Box?

Make sure your box contains everything listed. If any pieces are missing, contact your dealer. Please save the original box and packing materials if you ever need to ship your projector.

Projector

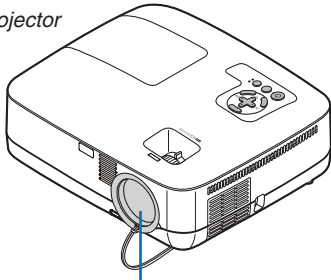

Lens cap
(24F44681)

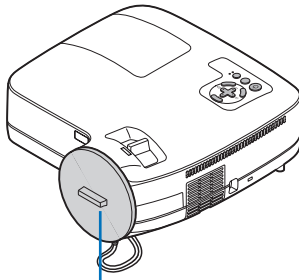

Lens cap
(24FU0691)

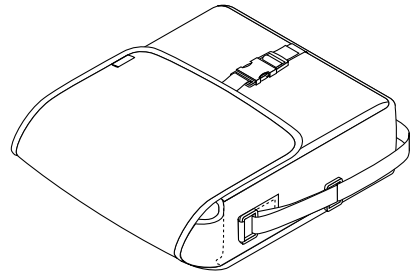

Soft case
(24BS7582)

NP610/NP510/NP410/
NP405/NP310/NP305/
NP510W/NP410W

NP610S/NP510WS

NP610/NP510/NP410/
NP310/NP510W/
NP410W

The NP405, NP305,
NP610S, and NP510WS
do not come with a soft
case.

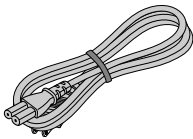

Power cable
(US: 7N080235)
(EU: 7N080021)

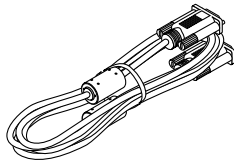

VGA signal cable
(7N520073/7N520052)

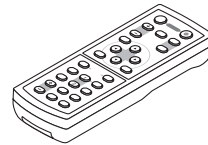

Remote control
(7N900901)

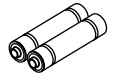

Batteries (AAA x 2)

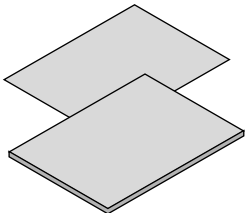

- Important Information (For North America: 7N8P9731) (For Other countries than North America: 7N8P9731 and 7N8P9741)
- Quick Setup Guide (7N8P9721)

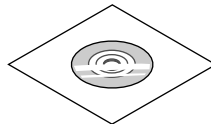

NEC Projector CD-ROM
User's manual (PDF) and
the utility software "Virtual
Remote Tool"
(7N951361)

For North America only
Registration card
Limited warranty

For customers in Europe:
You will find our current valid Guar-
antee Policy on our Web Site:
www.nec-display-solutions.com



DVI to VGA adapter (7N960234)
The NP405 and NP305 do not
come with the DVI to VGA adapter.

Unless otherwise described in the user's manual, the drawings for the projector cabinet show examples of the NP610.

② Introduction to the Projector

This section introduces you to your new projector and describes the features and controls.

Congratulations on Your Purchase of the Projector

This projector is one of the very best projectors available today. The projector enables you to project precise images up to 300 inches (110 inches on NP610S; 104 inches on NP510WS) across (measured diagonally) from your PC or Macintosh computer (desktop or notebook), VCR, DVD player, or document camera.

You can use the projector on a tabletop or cart, you can use the projector to project images from behind the screen, and the projector can be permanently mounted on a ceiling*¹. The remote control can be used wirelessly.

*¹ Do not attempt to mount the projector on a ceiling yourself.

The projector must be installed by qualified technicians in order to ensure proper operation and reduce the risk of bodily injury.

In addition, the ceiling must be strong enough to support the projector and the installation must be in accordance with any local building codes. Please consult your dealer for more information.

Features you'll enjoy:

- **Quick start & Quick Power Off**

Less than 4 seconds* after turning on the power, the projector is ready to display PC or video images.

* The quick start time is only when [STANDBY MODE] is set to [NORMAL] in the on-screen message.

The projector can be put away immediately after the projector is powered down. No cool down period is required after the projector is turned off from the remote control or cabinet control panel.

- **Direct Power Off**

The projector has a feature called "Direct Power Off". This feature allows the projector to be turned off (even when projecting an image) by using the Main Power Switch or disconnecting the AC power supply.

To turn off the AC power supply when the projector is powered on, use a power strip equipped with a switch and a breaker.

- **Less than 1W in standby condition with energy saving technology**

Selecting [POWER-SAVING] for [STANDBY MODE] from the menu can put the projector in power-saving mode that consumes only 0.6W (100-130V AC)/0.7W (200-240V AC).

- **Carbon Meter**

This feature will show energy-saving effect in terms of CO₂ emission reduction (kg) when the projector's [ECO MODE] is set to [ON].

The amount of CO₂ emission reduction will be displayed in the confirmation message at the time of power-off and in the INFO of the on-screen menu.

- **7W built-in speaker for an integrated audio solution**

Powerful 7 watt speaker provides volume need for large rooms.

- **Virtual Remote function**

The Virtual Remote function allows power On/Off and source selection of the projector from your PC by using the supplied VGA signal cable. The utility software "Virtual Remote Tool" exclusively for the projector is required to be installed from the accompanying NEC Projector CD-ROM onto your computer.

An accompanying NEC Projector CD-ROM includes the utility software "Virtual Remote Tool" exclusively for the projector and user's manuals in PDF format.

- **Short throw distances (NP610S/NP510WS)**

Short focal lenses provide for a larger image using a shorter throw distance when compared to a typical projector lens.

- **A variety of input ports and a comprehensive array of system control interfaces**

This projector supports input signals on the following ports: DVI-I connector (DVI-I 29 Pin) with HDCP compatible, 15pin D-Sub, composite and S-video.

- **AUTO POWER ON and AUTO POWER OFF features**

The AUTO POWER ON(AC), AUTO POWER ON(COMP1), AUTO POWER OFF, and OFF TIMER features eliminate the need to always use the POWER button on the remote control or projector cabinet.

- **Preventing unauthorized use of the projector**

Enhanced smart security settings for keyword protection, cabinet control panel lock, security slot, and security chain opening to help prevent unauthorized access, adjustments and theft deterrence.

- **The optional remote control (NP02RC) allows you to assign a CONTROL ID to the projector**

Multiple projectors can be operated separately and independently with the same single remote control by assigning an ID number to each projector.

- **Integrated RJ-45 connector for wired networking capability (except NP405/NP305)**

An RJ-45 connector is equipped as standard feature.

- **Auto vertical keystone correction**

Auto Keystone feature allows the projector to detect its tilt and correct vertical distortion automatically.

- **LCD projector with high resolution and high brightness**

High resolution display - up to UXGA compatible, XGA (NP610/NP510/NP410/NP405/NP310/NP305/NP610S)/ WXGA (NP510W/NP410W/NP510WS) native resolution.

- **Six picture preset modes for user adjustable picture and color settings**

Each picture preset mode can be customized and memorized according to your preference.

- **PC Control Port**

You can control the projector with a PC or control system using the PC Control port.

- **Optional remote mouse receiver**

You can use the supplied wireless remote control and the optional remote mouse receiver to operate your PC mouse from across the room. The optional remote mouse receiver (NP01MR) supports almost any PC using a USB connection.

About this user's manual

The fastest way to get started is to take your time and do everything right the first time. Take a few minutes now to review the user's manual. This may save you time later on. At the beginning of each section of the manual you'll find an overview. If the section doesn't apply, you can skip it.

Comparative Table of Main Features

The main features vary depending on the model as follows.

	Standard Models						Wide Panel Model		Short-Throw Model	Wide Panel & Short-Throw Model
	NP610	NP510	NP410	NP405	NP310	NP305	NP510W	NP410W	NP610S	NP510WS
Native Aspect Ratio (→ page 90, 92)	<div style="border: 1px solid black; padding: 5px; display: inline-block;">4 : 3</div> Standard						<div style="border: 1px solid black; padding: 5px; display: inline-block;">16 : 10</div> Wide		<div style="border: 1px solid black; padding: 5px; display: inline-block;">4 : 3</div> Standard	<div style="border: 1px solid black; padding: 5px; display: inline-block;">16 : 10</div> Wide
Native Resolution (dots x lines*1) (→ page 90, 92)	XGA (1024 x 768)						WXGA (1280 x 800)		XGA (1024 x 768)	WXGA (1280 x 800)
Screen Size (→ page 90, 92)	21"–300"								60"–110"	57"–104"
Throw Distance (→ page 90, 92)	30–444 inches/0.7–11.3 m						31–470 inches/ 0.8–11.9 m		35"–66"/ 0.9 m–1.7 m	36"–66"/ 0.9 m–1.7 m
Light output*2*3 in OFF for ECO MODE (→ page 90, 92)	3500 lumens	3000 lumens	2600 lumens		2200 lumens		3000 lumens	2600 lumens	2600 lumens	2100 lumens
Wired LAN (→ page 24, 48)	RJ-45		—		RJ-45	—		RJ-45		
Zoom (→ page 32)	Using the manual zoom lever								Using the [DIGITAL ZOOM] function from the menu	
Focus (→ page 33)	Using the manual focus ring								Using the manual focus lever	
Lamp Replacement Time (average) (→ page 78)	4000 (H) in OFF for ECO MODE /5000 (H) in ON for ECO MODE									

For further details on the specifications, see page 90.

*1 Effective pixels are more than 99.99%.

*2 This is the light output value (lumens) when the [PRESET] mode is set to [HIGH-BRIGHT]. If any other mode is selected as the [PRESET] mode, the light output value may drop slightly.

*3 Compliance with ISO21118-2005

TIP: The model name is located on the cabinet.

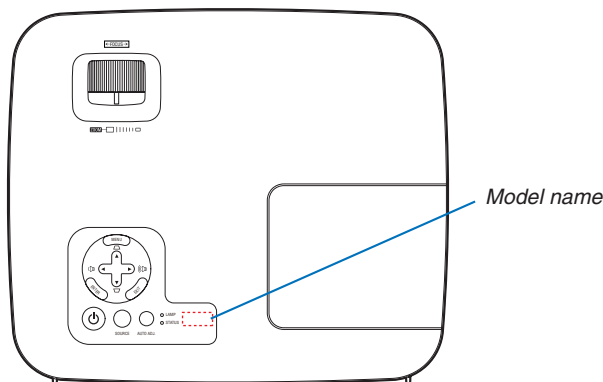

3 Part Names of the Projector

Front/Top

NP610/NP510/NP410/NP405/NP310/NP305/NP510W/NP410W

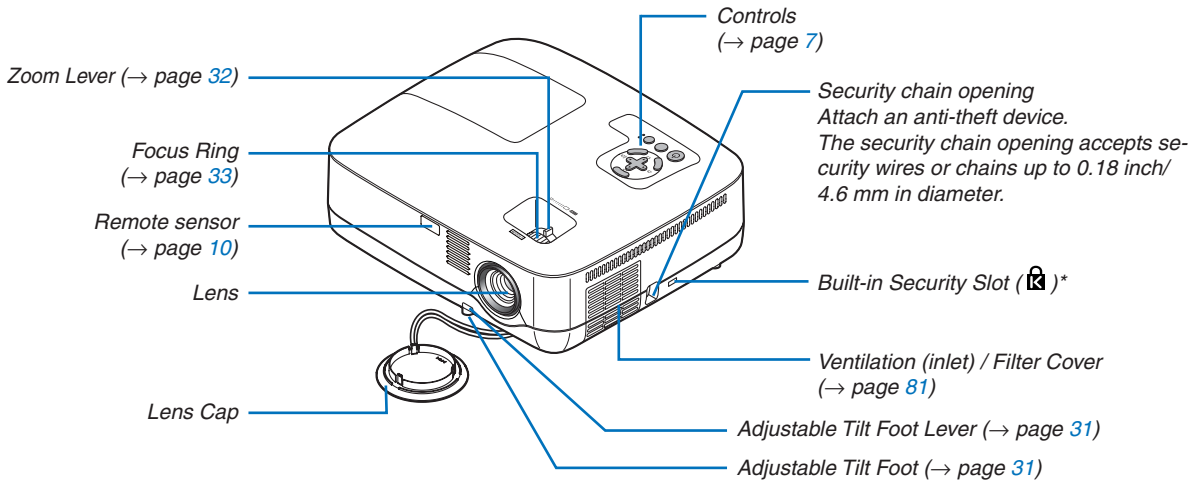

* This security slot supports the MicroSaver® Security System.

NP610S/NP510WS

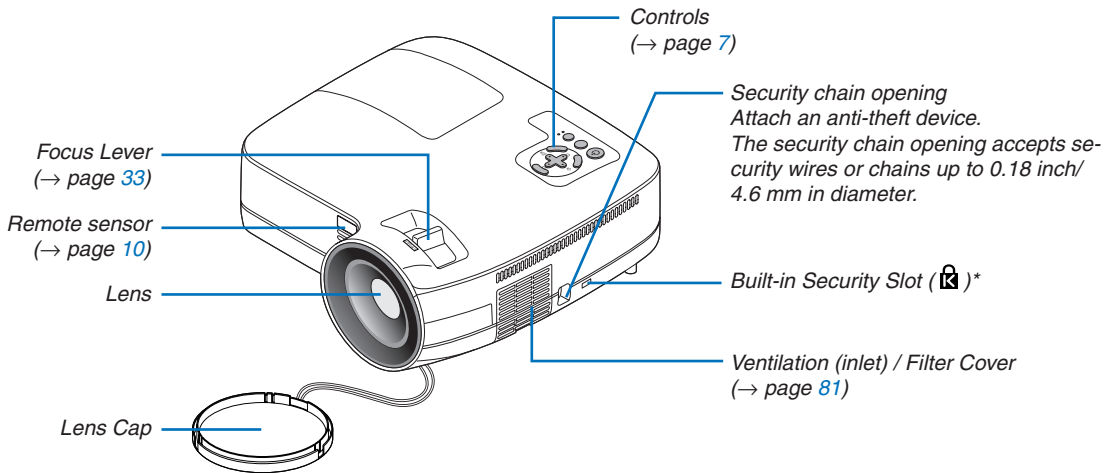

* This security slot supports the MicroSaver® Security System.

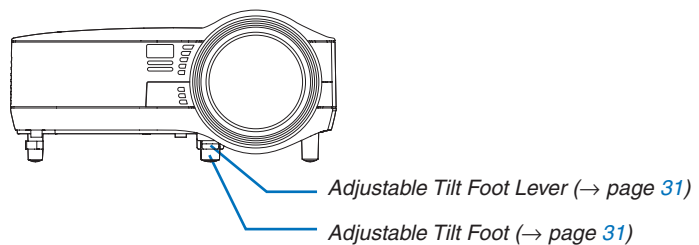

Rear

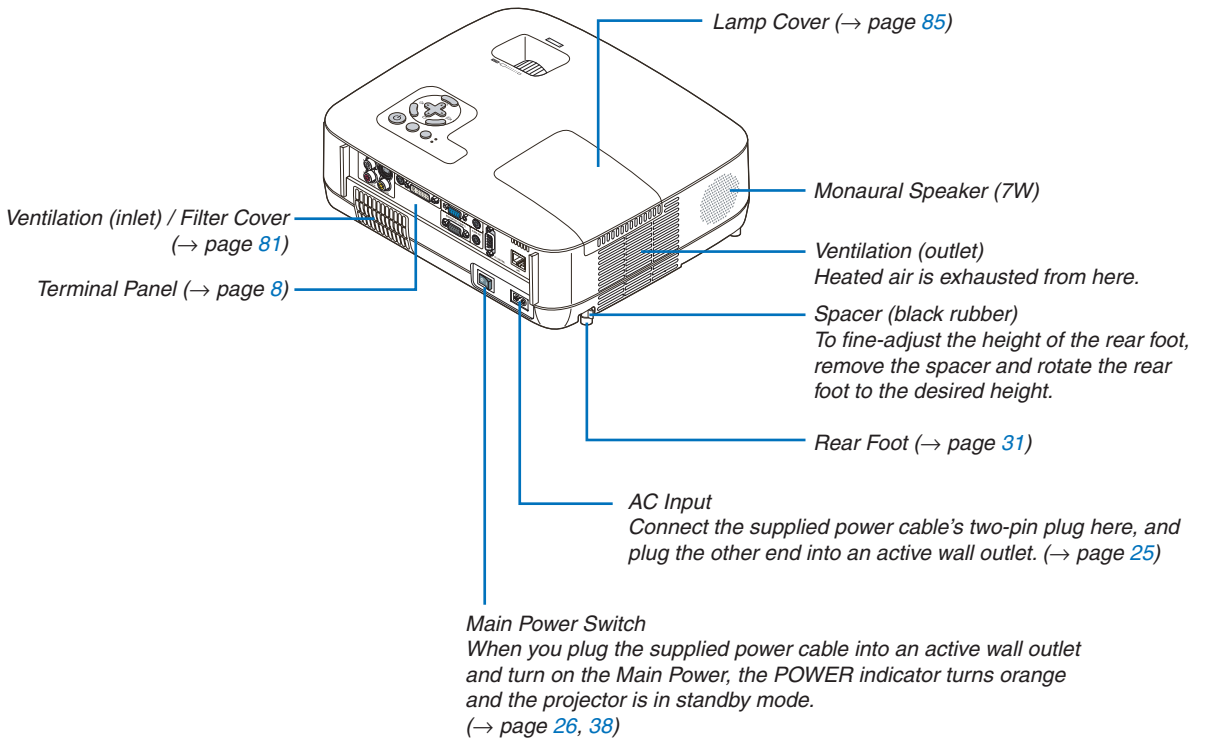

Top Features

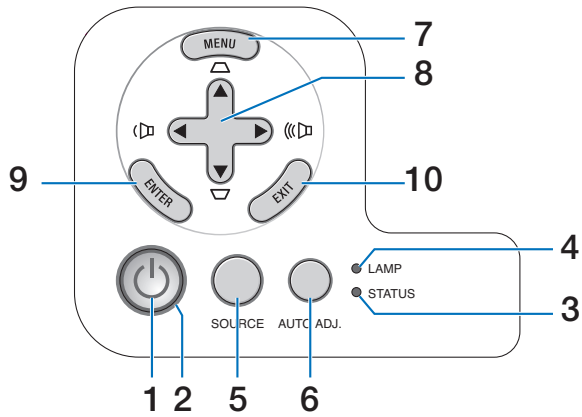

1. **⏻ (POWER) Button** (→ page 27, 38)
2. **POWER Indicator** (→ page 26, 38, 87)
3. **STATUS Indicator** (→ page 87)
4. **LAMP Indicator** (→ page 84, 87)
5. **SOURCE Button** (→ page 29)
6. **AUTO ADJ. Button** (→ page 37)
7. **MENU Button** (→ page 56)
8. **▲▼◀▶ / Volume Buttons ◀▶ / Keystone Buttons ▲▼** (→ page 34, 37)
9. **ENTER Button** (→ page 56)
10. **EXIT Button** (→ page 56)

Terminal Panel Features

NP610/NP510/NP410/NP310/NP510W/NP410W/NP610S/NP510WS

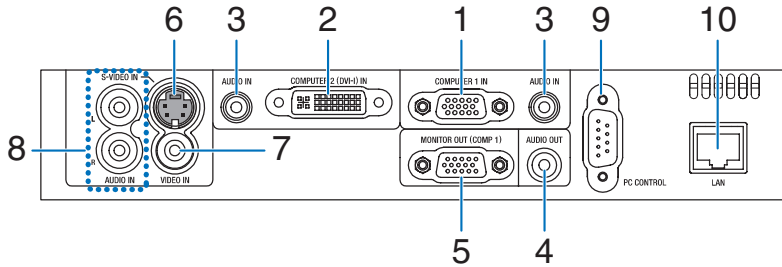

NP405/NP305

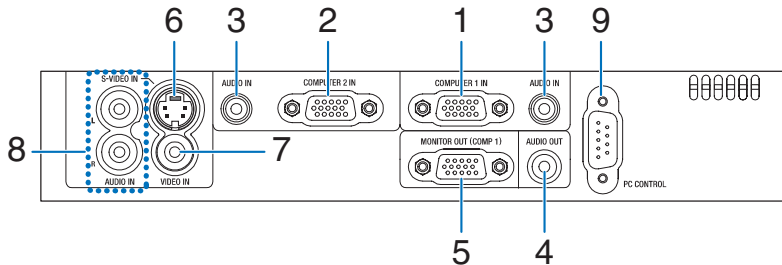

1. **COMPUTER 1 IN/ Component Input Connector (Mini D-Sub 15 Pin)** (→ page 17, 20, 22)
2. **COMPUTER 2 (DVI-I) IN Connector (29 Pin) (HDCP compatible)** (→ page 19, 20)
(NP610/NP510/NP410/NP310/NP510W/NP410W/ NP610S/NP510WS)
COMPUTER 2 IN / Component Input Connector (Mini D-Sub 15 Pin) (→ page 17, 20, 22)
(NP405/NP305)
3. **AUDIO IN Mini Jack (Stereo Mini)** (→ page 17, 19, 22)
4. **AUDIO OUT Mini Jack (Stereo Mini)** (→ page 21)
5. **MONITOR OUT (COMP 1) Connector (Mini D-Sub 15 Pin)** (→ page 21)
6. **S-VIDEO IN Connector (Mini DIN 4 Pin)** (→ page 23)
7. **VIDEO IN Connector (RCA)** (→ page 23)
8. **AUDIO Input Jacks L/R (RCA)** (→ page 23)
9. **PC CONTROL [PC CONTROL] Port (D-Sub 9 Pin)** (→ page 98)
Use this port to connect a PC or control system. This enables you to control the projector using serial communication protocol. If you are writing your own program, typical PC control codes are on page 98.
10. **LAN Port (RJ-45)** (→ page 24)
(not available on NP405/NP305)

4 Part Names of the Remote Control

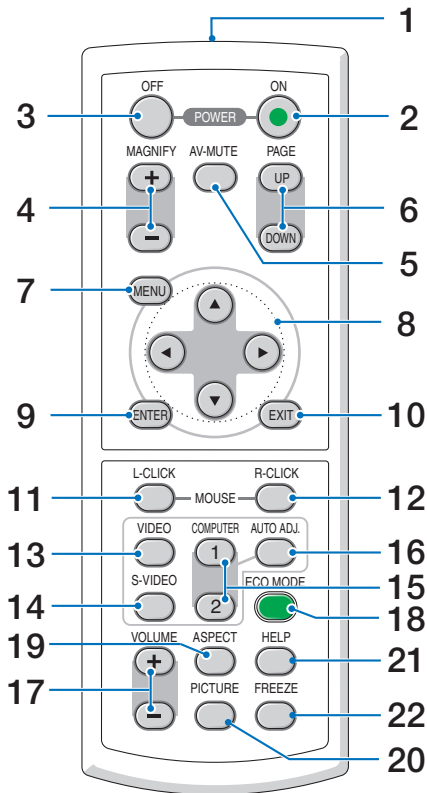

1. Infrared Transmitter

(→ page 10)

2. POWER ON Button

(→ page 27)

3. POWER OFF Button

(→ page 38)

4. MAGNIFY (+)(-) Button

(→ page 40)

5. AV-MUTE Button

(→ page 40)

6. PAGE UP/DOWN Button*

(→ page 46, 47)

7. MENU Button

(→ page 56)

8. SELECT ▲▼◀▶ Button (→ page 56)

9. ENTER Button (→ page 56)

10. EXIT Button (→ page 56)

11. MOUSE L-CLICK Button*

(→ page 46, 47)

12. MOUSE R-CLICK Button*

(→ page 46, 47)

13. VIDEO Button

(→ page 29)

14. S-VIDEO Button

(→ page 29)

15. COMPUTER 1/2 Button

(→ page 29)

16. AUTO ADJ. Button

(→ page 37)

17. VOLUME (+)(-) Button

(→ page 37)

18. ECO MODE Button (→ page 41)

19. ASPECT Button

(→ page 66)

20. PICTURE Button

(→ page 61, 62)

21. HELP Button

(→ page 78)

22. FREEZE Button

(→ page 40)

* The PAGE UP/DOWN, MOUSE L-CLICK and MOUSE R-CLICK buttons work only when the optional remote mouse receiver is connected with your computer.

Battery Installation

- 1 Press firmly and slide the battery cover off.
- 2 Install new batteries (AAA). Ensure that you have the batteries' polarity (+/-) aligned correctly.
- 3 Slip the cover back over the batteries until it snaps into place. Do not mix different types of batteries or new and old batteries.

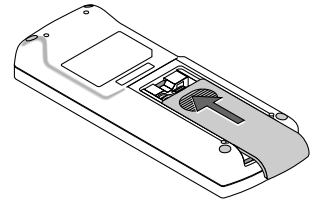
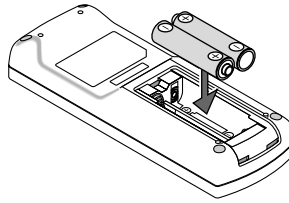
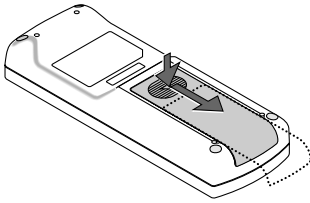

Remote Control Precautions

- Handle the remote control carefully.
- If the remote control gets wet, wipe it dry immediately.
- Avoid excessive heat and humidity.
- Do not heat, take apart, or throw batteries into fire.
- If you will not be using the remote control for a long time, remove the batteries.
- Ensure that you have the batteries' polarity (+/-) aligned correctly.
- Do not use new and old batteries together, or use different types of batteries together.
- Dispose of used batteries according to your local regulations.

Operating Range for Wireless Remote Control

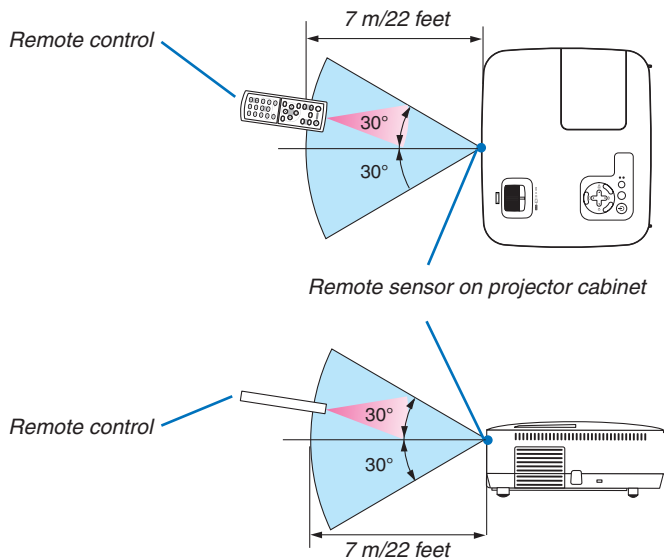

- The infrared signal operates by line-of-sight up to a distance of about 22 feet/7 m and within a 60-degree angle of the remote sensor on the projector cabinet.
- The projector will not respond if there are objects between the remote control and the sensor, or if strong light falls on the sensor. Weak batteries will also prevent the remote control from properly operating the projector.

2. Installation and Connections

This section describes how to set up your projector and how to connect video and audio sources. Your projector is simple to set up and use. But before you get started, you must first:

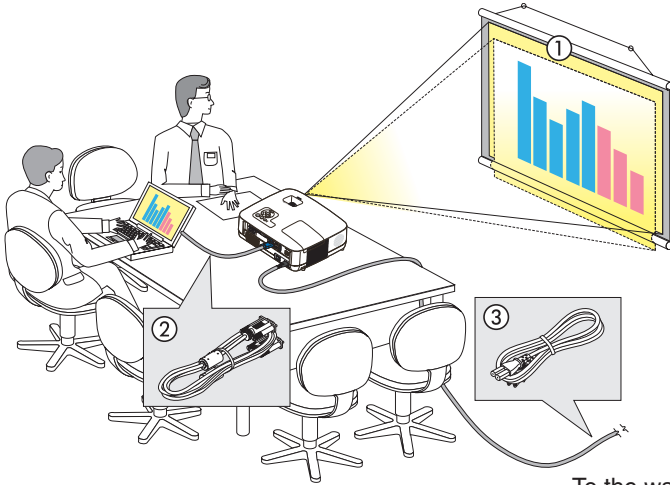

- 1 Set up a screen and the projector.
- 2 Connect your computer or video equipment to the projector.
(→ page 17, 19, 20, 21, 22, 23, 24)
- 3 Connect the supplied power cable.
(→ page 25)

NOTE: Ensure that the power cable and any other cables are disconnected before moving the projector. When moving the projector or when it is not in use, cover the lens with the lens cap.

To the wall outlet.

1 Setting Up the Screen and the Projector

Selecting a Location

NOTE: Throw distances vary depending on the model.

[NP610/NP510/NP410/NP405/NP310/NP305]

The further your projector is from the screen or wall, the larger the image. The minimum size the image can be is approximately 21" (0.53 m) measured diagonally when the projector is roughly 30 inches (0.8 m) from the wall or screen. The largest the image can be is 300" (7.6 m) when the projector is about 407 inches (10.3 m) from the wall or screen.

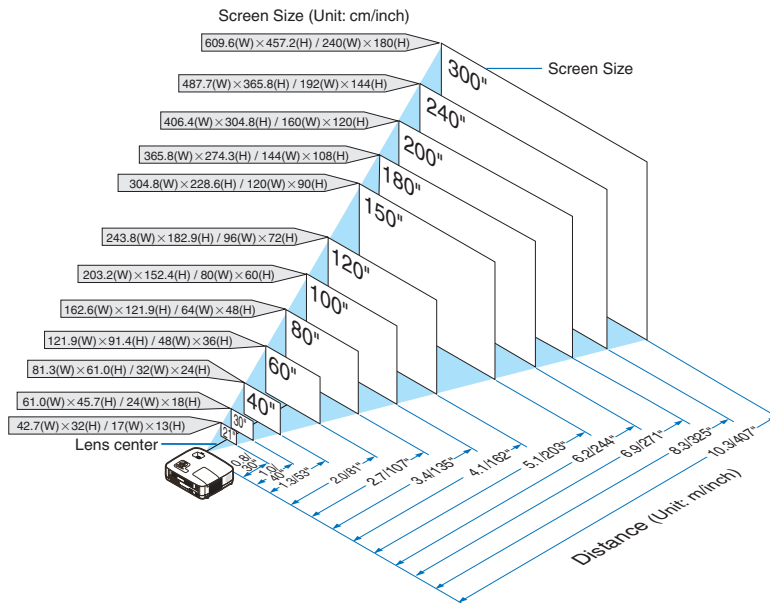

TIP:

- The distances are indicated by intermediate values between tele and wide. Use as a rule of thumb.
- The Zoom lever adjusts the image size by up to +/-10%.
- For more details on throw distance, see page 15.

2. Installation and Connections

[NP510W/NP410W]

The further your projector is from the screen or wall, the larger the image. The minimum size the image can be is approximately 21" (0.53 m) measured diagonally when the projector is roughly 31 inches (0.8 m) from the wall or screen. The largest the image can be is 300" (7.6 m) when the projector is about 431 inches (11.0 m) from the wall or screen.

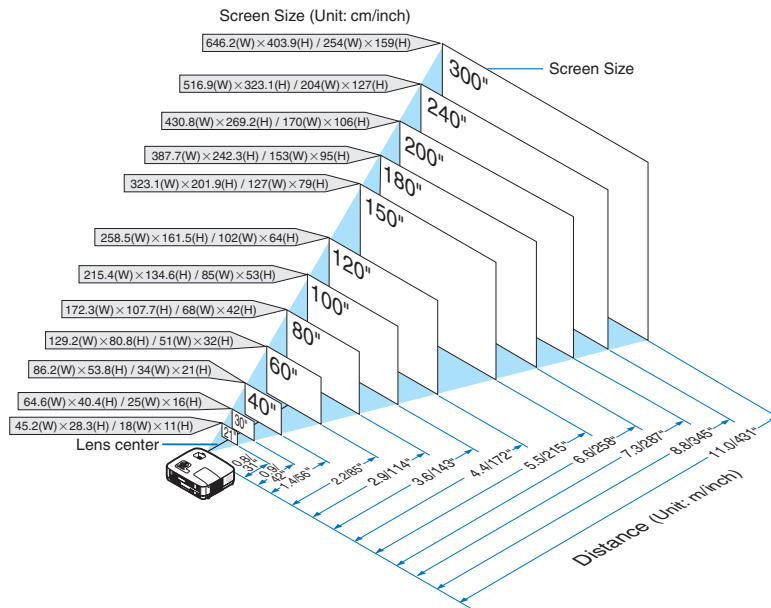

TIP:

- The distances are indicated by intermediate values between tele and wide. Use as a rule of thumb.
- The Zoom lever adjusts the image size by up to +/-10%.
- For more details on throw distance, see page 15.

2. Installation and Connections

[NP610S]

The further your projector is from the screen or wall, the larger the image. The minimum size the image can be is approximately 60" (1.52 m) measured diagonally when the projector is roughly 35 inches (0.9 m) from the wall or screen. The largest the image can be is 110" (2.8 m) when the projector is about 66 inches (1.7 m) from the wall or screen.

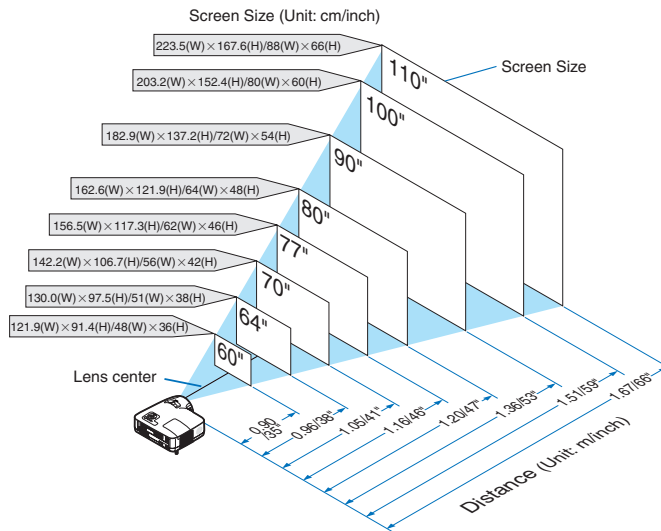

TIP:

- Digital Zoom can result in a blurry image due to the electronic zoom.
- The Digital Zoom function adjusts the image size by up to -20%. (→ page 32)
- For more details on throw distance, see page 16.

2. Installation and Connections

[NP510WS]

The further your projector is from the screen or wall, the larger the image. The minimum size the image can be is approximately 57" (1.45 m) measured diagonally when the projector is roughly 36 inches (0.9 m) from the wall or screen. The largest the image can be is 104" (2.6 m) when the projector is about 66 inches (1.7 m) from the wall or screen.

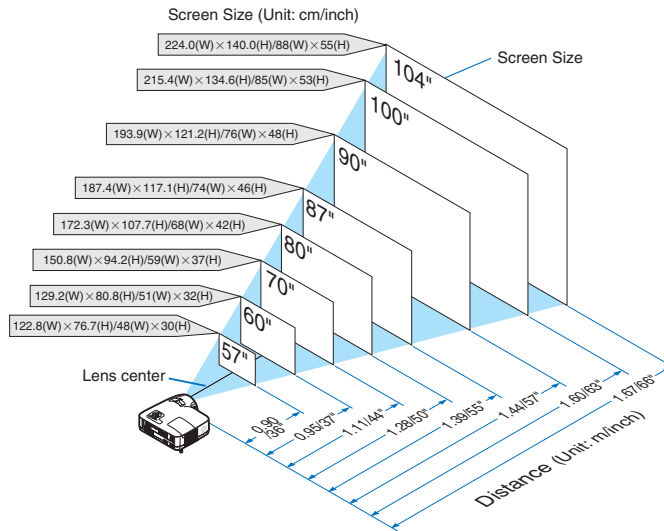

TIP:

- Digital Zoom can result in a blurry image due to the electronic zoom.
- The Digital Zoom function adjusts the image size by up to -20%. (→ page 32)
- For more details on throw distance, see page 16.

2. Installation and Connections

Throw Distance and Screen Size

The following shows the proper relative positions of the projector and screen. Refer to the table to determine the position of installation.

Distance Chart [NP610/NP510/NP410/NP405/NP310/NP305/NP510W/NP410W]

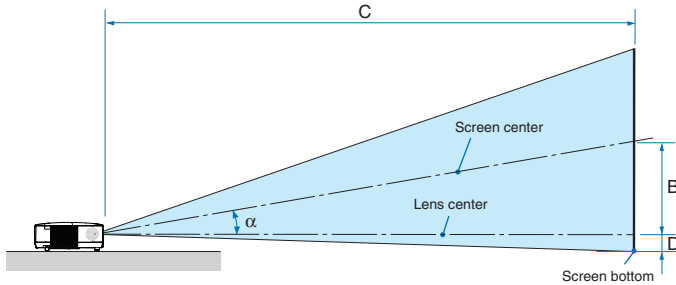

B = Vertical distance between lens center and screen center

C = Throw distance

D = Vertical distance between lens center and screen bottom (top of screen for ceiling application)

α = Throw angle

NOTE: The values in the tables are design values and may vary.

[NP610/NP510/NP410/NP405/NP310/NP305]

Diagonal		Screen Size				B		C				D		α			
		Width		Height				wide		tele				wide	-	tele	
inch	mm	inch	mm	inch	mm	inch	mm	inch	mm	-	inch	mm	inch	mm	degree	-	degree
21	533	17	427	13	320	4	110	-	-	-	30	753	-2	-50	-	-	8.3
25	635	20	508	15	381	5	131	29	746	-	36	903	-2	-60	10.0	-	8.3
30	762	24	610	18	457	6	157	36	903	-	43	1092	-3	-71	9.9	-	8.2
40	1016	32	813	24	610	8	210	48	1217	-	58	1469	-4	-95	9.8	-	8.1
60	1524	48	1219	36	914	12	314	73	1845	-	88	2223	-6	-143	9.7	-	8.0
72	1829	58	1463	43	1097	15	377	87	2221	-	105	2675	-7	-171	9.6	-	8.0
80	2032	64	1626	48	1219	17	419	97	2473	-	117	2977	-8	-191	9.6	-	8.0
84	2134	67	1707	50	1280	17	440	102	2598	-	123	3128	-8	-200	9.6	-	8.0
90	2286	72	1829	54	1372	19	471	110	2787	-	132	3354	-8	-214	9.6	-	8.0
100	2540	80	2032	60	1524	21	524	122	3101	-	147	3731	-9	-238	9.6	-	8.0
120	3048	96	2438	72	1829	25	629	147	3729	-	177	4485	-11	-286	9.6	-	8.0
150	3810	120	3048	90	2286	31	786	184	4671	-	221	5616	-14	-357	9.5	-	8.0
180	4572	144	3658	108	2743	37	943	221	5613	-	266	6747	-17	-429	9.5	-	8.0
200	5080	160	4064	120	3048	41	1048	246	6241	-	295	7501	-19	-476	9.5	-	8.0
210	5334	168	4267	126	3200	43	1100	258	6555	-	310	7878	-20	-500	9.5	-	7.9
240	6096	192	4877	144	3658	50	1257	295	7497	-	355	9009	-23	-572	9.5	-	7.9
270	6858	216	5486	162	4115	56	1414	332	8439	-	399	10140	-25	-643	9.5	-	7.9
300	7620	240	6096	180	4572	62	1572	369	9381	-	444	11271	-28	-714	9.5	-	7.9

[NP510W/NP410W]

Diagonal		Screen Size				B		C				D		α			
		Width		Height				wide		tele				wide	-	tele	
inch	mm	inch	mm	inch	mm	inch	mm	inch	mm	-	inch	mm	inch	mm	degree	-	degree
21	533	18	452	11	283	5	117	-	-	-	31	798	-1	-25	-	-	8.3
25	635	21	538	13	337	5	139	31	791	-	38	957	-1	-29	10.0	-	8.3
30	762	25	646	16	404	7	167	38	957	-	46	1158	-1	-35	9.9	-	8.2
40	1016	34	862	21	538	9	222	51	1290	-	61	1557	-2	-47	9.8	-	8.1
60	1524	51	1292	32	808	13	333	77	1956	-	93	2356	-3	-71	9.7	-	8.0
72	1829	61	1551	38	969	16	400	93	2354	-	112	2835	-3	-85	9.6	-	8.0
80	2032	68	1723	42	1077	17	444	103	2621	-	124	3156	-4	-94	9.6	-	8.0
84	2134	71	1809	45	1131	18	466	108	2754	-	131	3316	-4	-99	9.6	-	8.0
90	2286	76	1939	48	1212	20	500	116	2954	-	140	3555	-4	-106	9.6	-	8.0
100	2540	85	2154	53	1346	22	555	129	3287	-	156	3955	-5	-118	9.6	-	8.0
120	3048	102	2585	64	1615	26	666	156	3953	-	187	4754	-6	-141	9.6	-	8.0
150	3810	127	3231	79	2019	33	833	195	4951	-	234	5953	-7	-177	9.5	-	8.0
180	4572	153	3877	95	2423	39	1000	234	5950	-	282	7152	-8	-212	9.5	-	8.0
200	5080	170	4308	106	2692	44	1111	260	6615	-	313	7951	-9	-236	9.5	-	8.0
210	5334	178	4523	111	2827	46	1166	274	6948	-	329	8351	-10	-247	9.5	-	7.9
240	6096	204	5169	127	3231	52	1333	313	7947	-	376	9550	-11	-283	9.5	-	7.9
270	6858	229	5816	143	3635	59	1499	352	8945	-	423	10748	-13	-318	9.5	-	7.9
300	7620	254	6462	159	4039	66	1666	391	9944	-	470	11947	-14	-353	9.5	-	7.9

2. Installation and Connections

Distance Chart [NP610S/NP510WS]

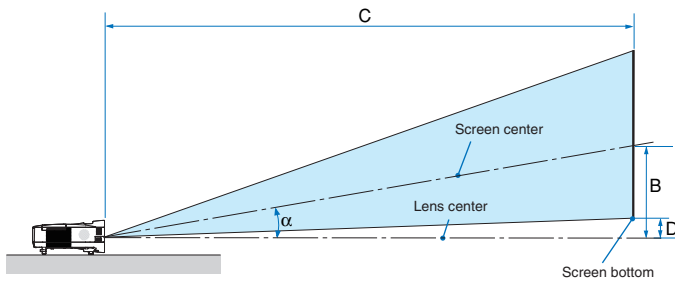

- B = Vertical distance between lens center and screen center
- C = Throw distance
- D = Vertical distance between lens center and screen bottom (top of screen for ceiling application)
- α = Throw angle

NOTE: The values in the tables are design values and may vary.

[NP610S]

Screen Size						B		C		D		α
Diagonal		Width		Height				wide				degree
inch	mm	inch	mm	inch	mm	inch	mm	inch	mm	inch	mm	degree
60	1524	48	1219	36	914	20	505	35	895	2	48	29.4
64	1626	51	1300	38	975	21	538	38	956	2	51	29.4
70	1778	56	1422	42	1067	23	589	41	1049	2	56	29.3
77	1956	62	1565	46	1173	26	648	46	1156	2	61	29.3
80	2032	64	1626	48	1219	27	673	47	1203	3	64	29.2
90	2286	72	1829	54	1372	30	757	53	1357	3	71	29.2
100	2540	80	2032	60	1524	33	841	59	1511	3	79	29.1
110	2794	88	2235	66	1676	36	926	66	1665	3	87	29.1

[NP510WS]

Screen Size						B		C		D		α
Diagonal		Width		Height				wide				degree
inch	mm	inch	mm	inch	mm	inch	mm	inch	mm	inch	mm	degree
57	1448	48	1228	30	767	20	508	36	902	5	125	29.4
60	1524	51	1292	32	808	21	535	37	951	5	131	29.4
70	1778	59	1508	37	942	25	624	44	1114	6	153	29.3
80	2032	68	1723	42	1077	28	713	50	1277	7	175	29.2
87	2210	74	1874	46	1171	31	776	55	1392	7	190	29.1
90	2286	76	1939	48	1212	32	803	57	1441	8	197	29.1
94	2388	80	2025	50	1265	33	838	59	1506	8	206	29.1
104	2642	88	2240	55	1400	37	928	66	1669	9	228	29.1

WARNING

- * Installing your projector on the ceiling must be done by a qualified technician. Contact your NEC dealer for more information.
- * Do not attempt to install the projector yourself.
- Only use your projector on a solid, level surface. If the projector falls to the ground, you can be injured and the projector severely damaged.
- Do not use the projector where temperatures vary greatly. The projector must be used at temperatures between 41°F (5°C) and 104°F (40°C) (Eco mode selected automatically at 95°F to 104°F/35°C to 40°C).
- Do not expose the projector to moisture, dust, or smoke. This will harm the screen image.
- Ensure that you have adequate ventilation around your projector so heat can dissipate. Do not cover the vents on the side or the front of the projector.

Reflecting the Image

Using a mirror to reflect your projector's image enables you to enjoy a much larger image when a smaller space is required. Contact your NEC dealer if you need a mirror system. If you're using a mirror system and your image is inverted, use the MENU and ▲▼◀▶ buttons on your projector cabinet or your remote control to correct the orientation. (→ page 72)

② Making Connections

NOTE: When using with a notebook PC, be sure to connect the projector and notebook PC while the projector is in standby mode and before turning on the power to the notebook PC.

In most cases the output signal from the notebook PC is not turned on unless connected to the projector before being powered up.

** If the screen goes blank while using your remote control, it may be the result of the computer's screen-saver or power management software.*

Enabling the computer's external display

Displaying an image on the notebook PC's screen does not necessarily mean it outputs a signal to the projector. When using a PC compatible laptop, a combination of function keys will enable/disable the external display. Usually, the combination of the "Fn" key along with one of the 12 function keys gets the external display to come on or off. For example, NEC laptops use Fn + F3, while Dell laptops use Fn + F8 key combinations to toggle through external display selections.

Connecting Your PC or Macintosh Computer

NOTE: Signals supported by Plug & Play (DDC2)

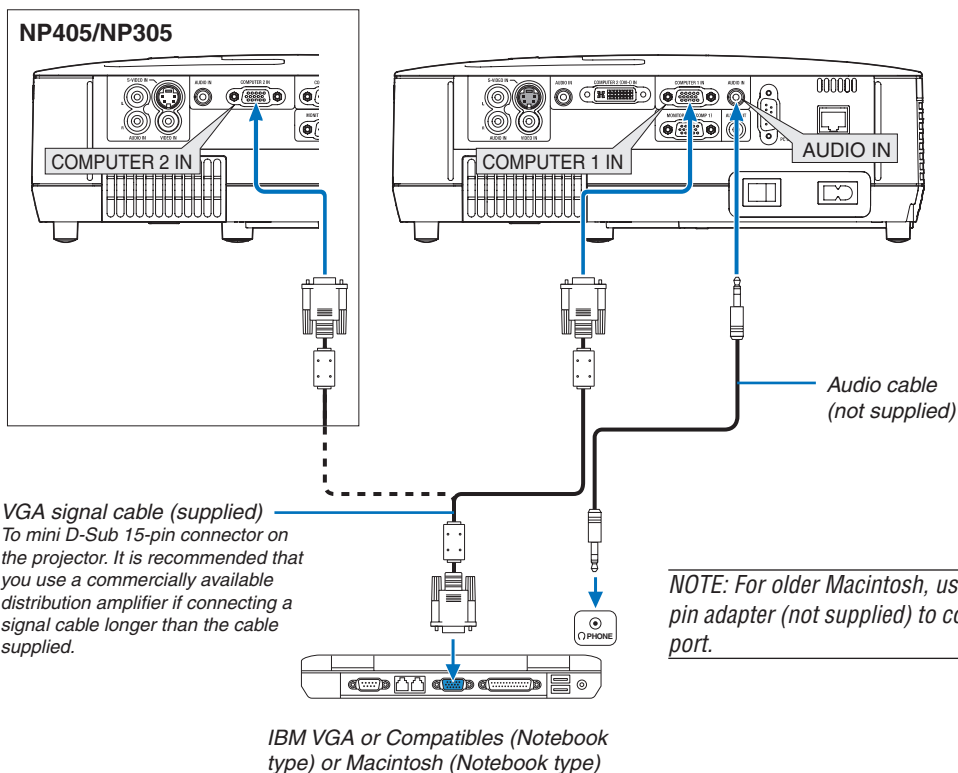

Model	INPUT		
	COMPUTER 1 IN	COMPUTER 2 IN	
	analog	analog	digital
NP610/NP510/NP410/NP310/ NP510W/NP410W/NP610S/NP510WS	Yes	Yes	Yes
NP405/NP305	Yes	Yes	—





2. Installation and Connections

- Select the source name for its appropriate input connector after turning on the projector.

[NP610/NP510/NP410/NP310/NP510W/NP410W/NP610S/NP510WS]

Input connector	SOURCE button on the projector cabinet	Button on the remote control
COMPUTER 1 IN	 COMPUTER1	(COMPUTER 1)
COMPUTER 2(DVI-I)IN	 COMPUTER 2(DIGITAL) or  COMPUTER 2(ANALOG)	(COMPUTER 2)

[NP405/NP305]

Input connector	SOURCE button on the projector cabinet	Button on the remote control
COMPUTER 1 IN	 COMPUTER 1	(COMPUTER 1)
COMPUTER 2 IN	 COMPUTER 2	(COMPUTER 2)

NOTE: The projector is not compatible with video decoded outputs of the NEC ISS-6020 switcher.

NOTE: An image may not be displayed correctly when a Video or S-Video source is played back via a commercially available scan converter.

This is because the projector will process a video signal as a computer signal at the default setting. In that case, do the following.

** When an image is displayed with the lower and upper black portion of the screen or a dark image is not displayed correctly:*

Project an image to fill the screen and then press the AUTO ADJ. button on the remote control or the projector cabinet.

2. Installation and Connections

When Viewing a DVI Digital Signal (except NP405 and NP305)

To project a DVI digital signal, be sure to connect the PC and the projector using a DVI cable (not supplied) before turning on your PC or projector. Turn on the projector first and select Computer 2 (Digital) from the source menu before turning on your PC.

Failure to do so may not activate the digital output of the graphics card resulting in no picture being displayed. Should this happen, restart your PC.

Do not disconnect the DVI cable while the projector is running. If the signal cable has been disconnected and then re-connected, an image may not be correctly displayed. Should this happen, restart your PC.

NOTE:

- Use a DVI cable or the one compliant with the DDWG (Digital Display Working Group) DVI (Digital Visual Interface) revision 1.0 standard. The DVI cable should be within 5 m (196") long. Both single and dual types of DVI cable can be used.
- The DVI (DIGITAL) connector accepts VGA (640 x 480), SVGA (800 x 600), 1152 x 864, XGA (1024 x 768), WXGA (1280 x 800 @ up to 60Hz), and SXGA (1280 x 1024 @ up to 60Hz).

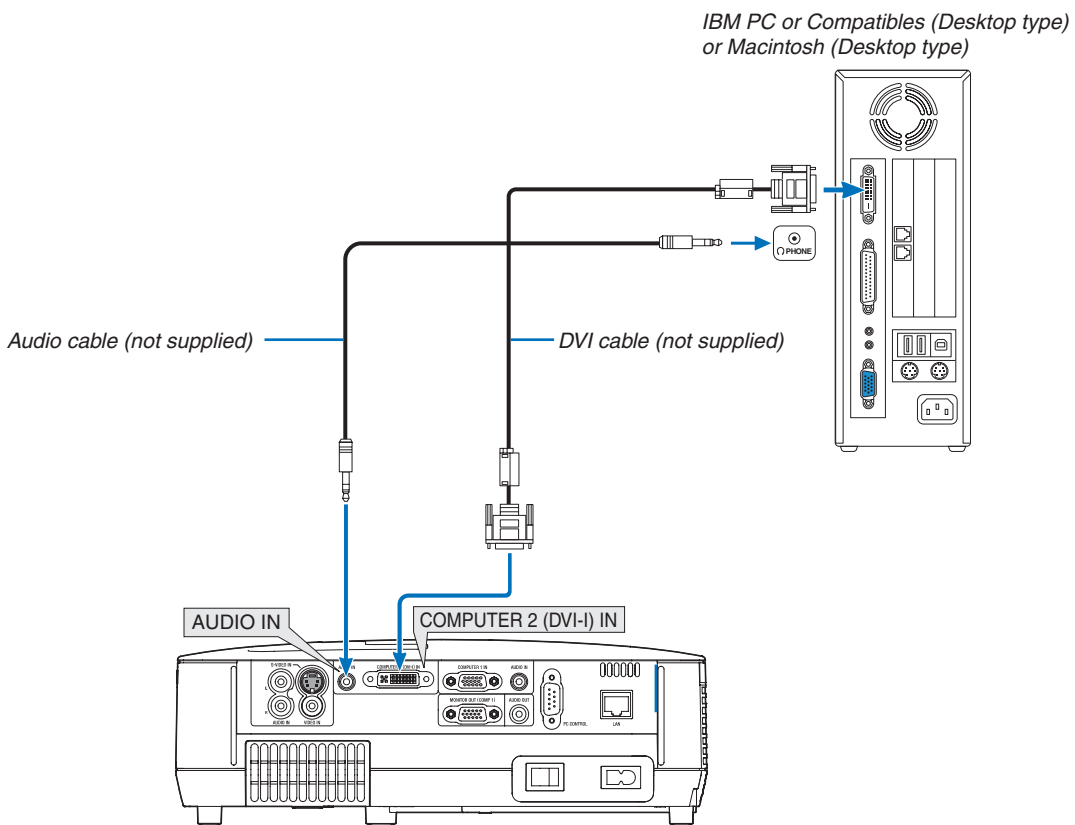

2. Installation and Connections

Using Two Analog COMPUTER Inputs Simultaneously

If you need to use two analog COMPUTER inputs simultaneously, connect a VGA signal cable as shown below.

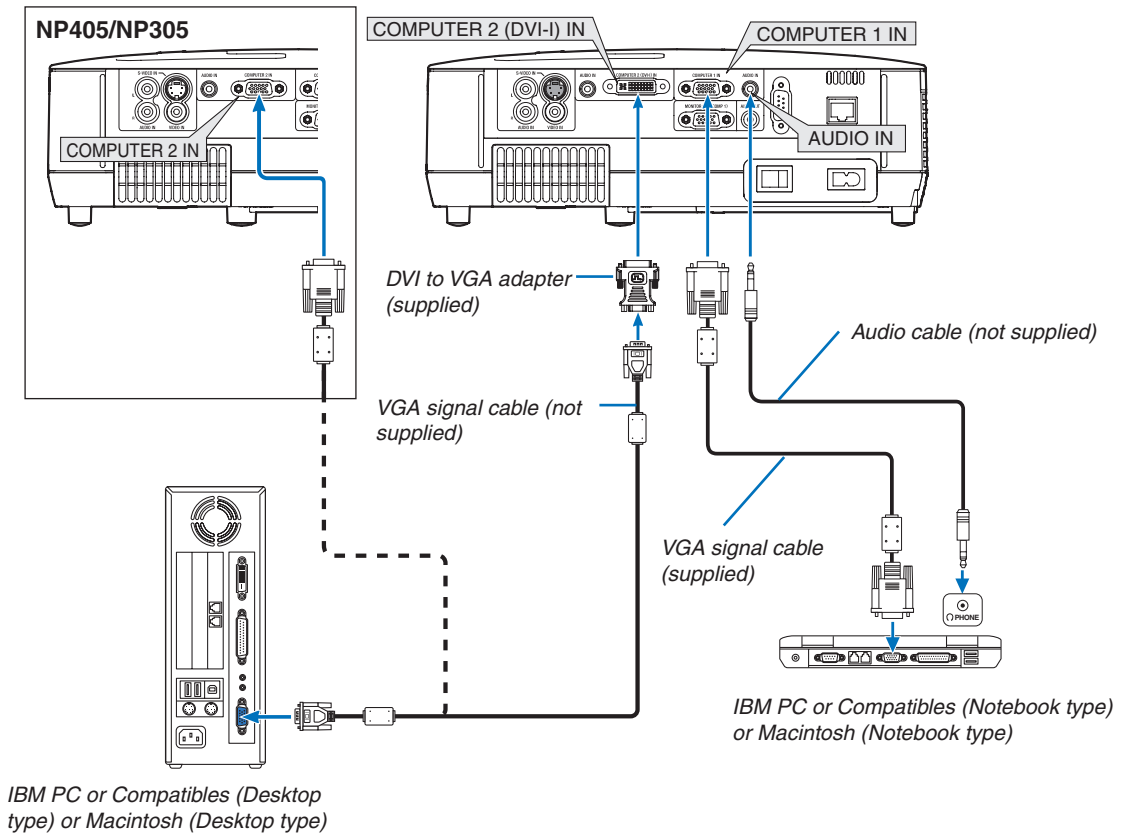

NOTE: When the DVI to VGA adapter is not to be used for an extended period of time, remove it from the projector. Failure to do so may cause damage to the connector of the projector.

Connecting an External Monitor

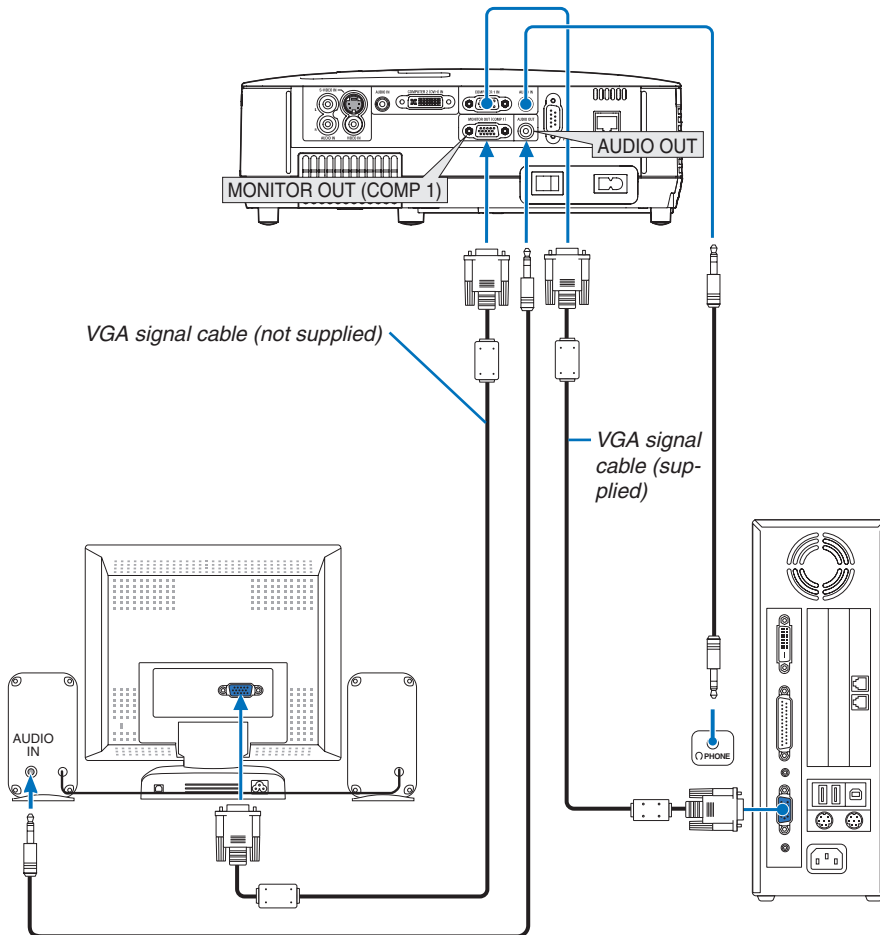

You can connect a separate, external monitor to your projector to simultaneously view on a monitor the computer analog image you're projecting.

NOTE:

- *Daisy chain connection is not possible.*
- *When audio equipment is connected, the projector speaker is disabled.*

Connecting Your DVD Player with Component Output

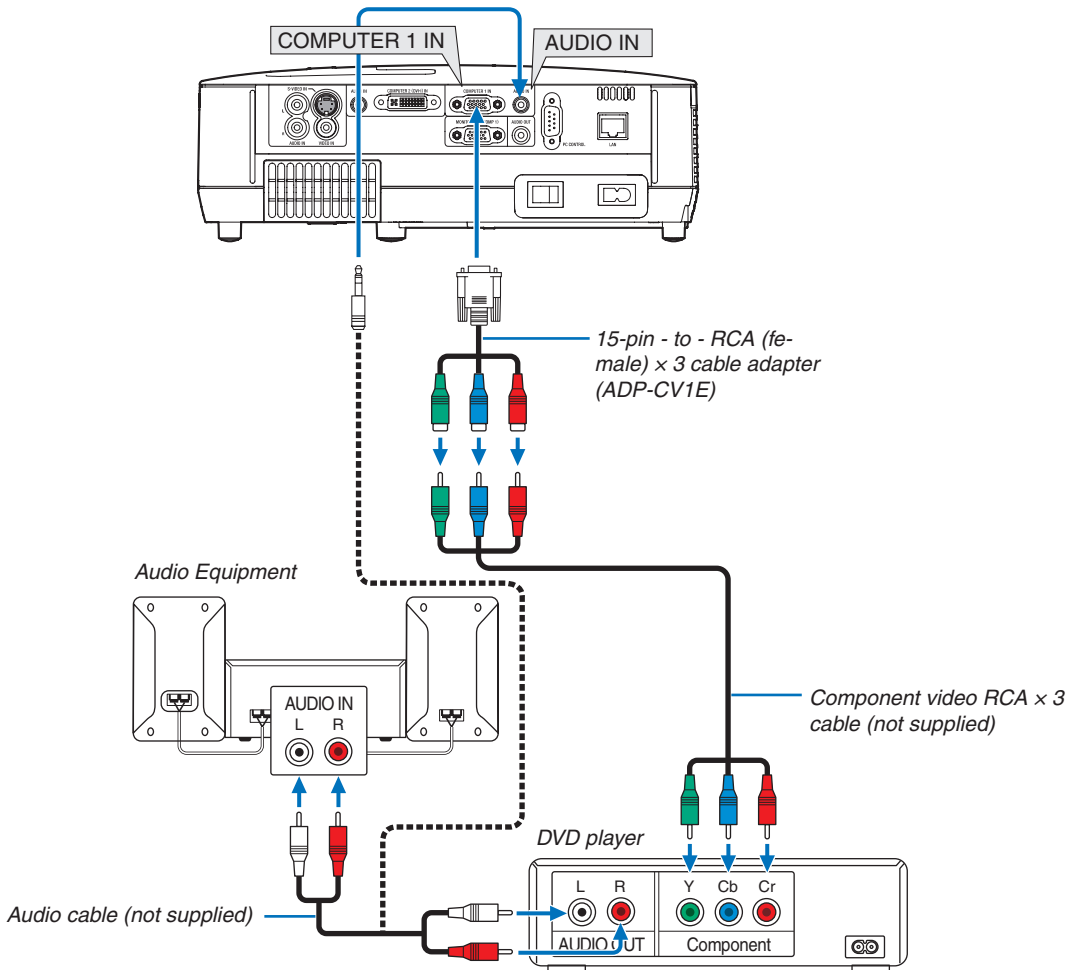

A component signal will be automatically displayed. If not, from the menu, select [SETUP] → [OPTIONS(1)] → [SIGNAL SELECT] → [COMPUTER1], and then place a check mark in the Component radio button.

- Select the source name for its appropriate input connector after turning on the projector.

[NP610/NP510/NP410/NP310/NP510W/NP410W/NP610S/NP510WS]

Input connector	SOURCE button on the projector cabinet	Button on the remote control
COMPUTER 1 IN	COMPUTER1	(COMPUTER 1)
COMPUTER 2 (DVI-I) IN	COMPUTER 2(ANALOG)	(COMPUTER 2)

[NP405/NP305]



Input connector	SOURCE button on the projector cabinet	Button on the remote control
COMPUTER 1 IN	COMPUTER 1	(COMPUTER 1)
COMPUTER 2 IN	COMPUTER 2	(COMPUTER 2)

NOTE: Refer to your DVD player's owner's manual for more information about your DVD player's video output requirements.

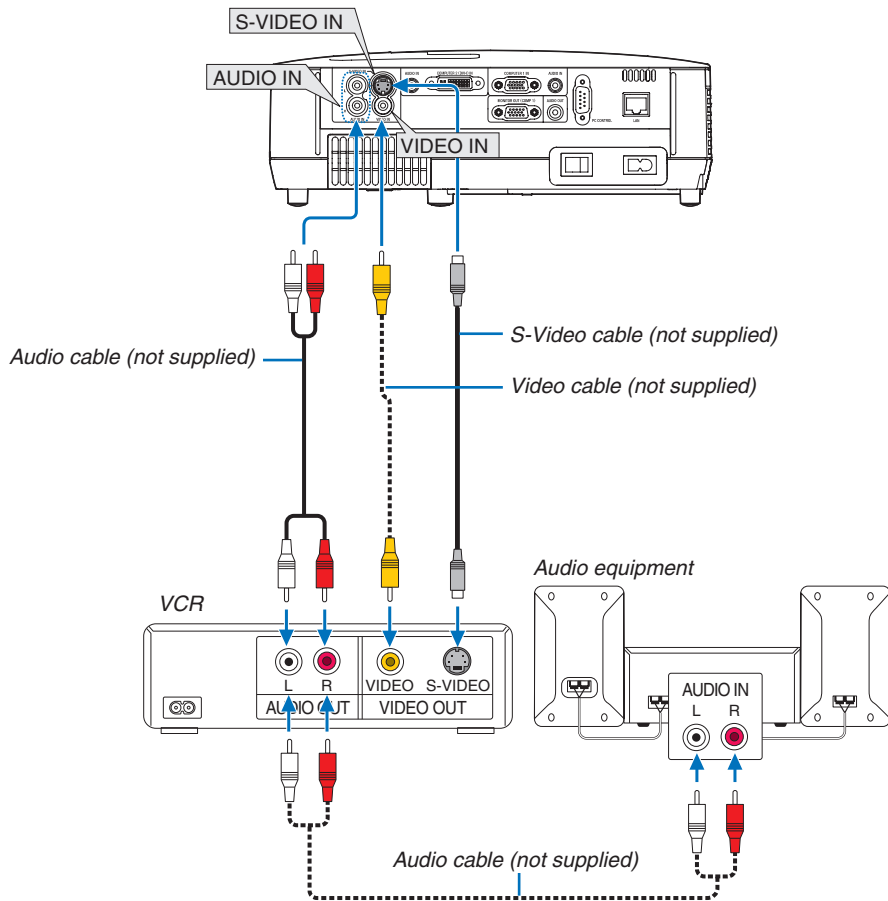
Connecting Your VCR



- Select the source name for its appropriate input connector after turning on the projector.

Input connector	SOURCE button on the projector cabinet	Button on the remote control
VIDEO IN	 VIDEO	(VIDEO)
S-VIDEO IN	 S-VIDEO	(S-VIDEO)

NOTE: The AUDIO IN L and R jacks (RCA) are shared between the Video and S-Video inputs.

NOTE: Refer to your VCR owner's manual for more information about your equipment's video output requirements.

NOTE: An image may not be displayed correctly when a Video or S-Video source is played back in fast-forward or fast-rewind via a scan converter.

2. Installation and Connections

Connecting to a Network (except NP405 and NP305)

The projector comes standard with a LAN port (RJ-45) which provides a LAN connection using a LAN cable. Using a LAN cable allows you to specify the Network Settings and the Alert Mail Settings for the projector over a LAN. To use a LAN connection, you are required to assign an IP address to the projector on the [PROJECTOR NETWORK SETTINGS] screen of the web browser on your computer. For setting, see page 48, 49, 50.

Example of LAN connection

Example of wired LAN connection

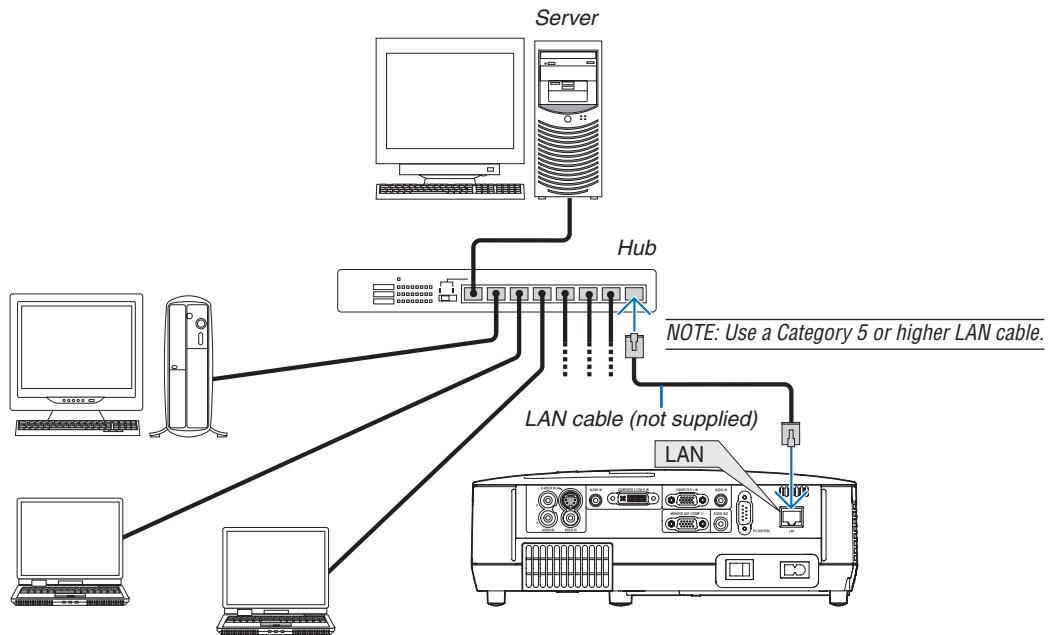

Connecting the Supplied Power Cable

Connect the supplied power cable to the projector.

First connect the supplied power cable's two-pin plug to the AC IN of the projector, and then connect the other plug of the supplied power cable in the wall outlet.

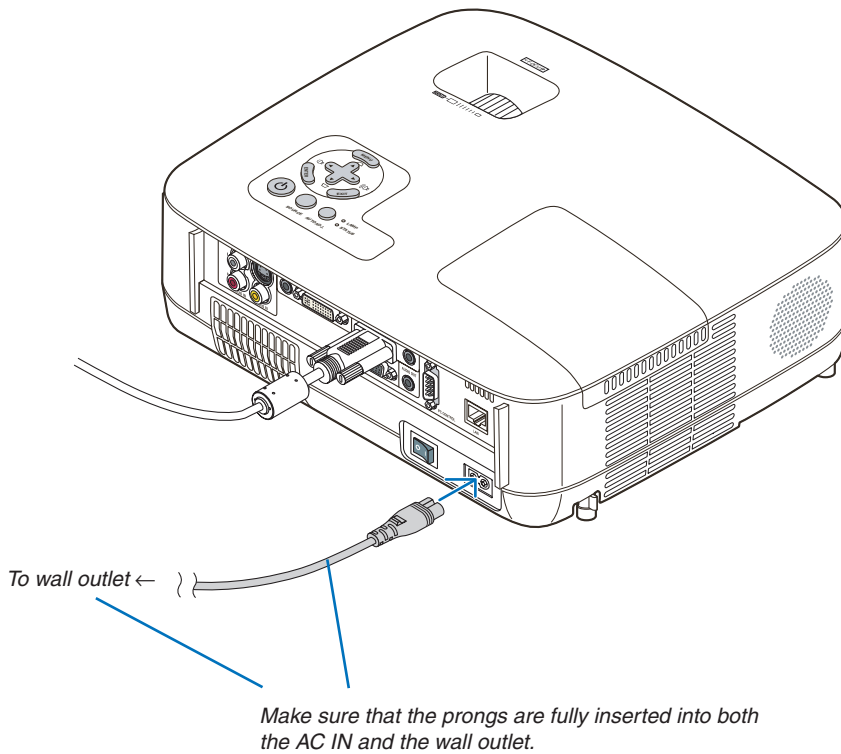

⚠ CAUTION:

Do not try to touch the ventilation outlet on the left front (when seen from the front) as it can become heated while the projector is turned on and immediately after the projector is turned off.

3. Projecting an Image (Basic Operation)

This section describes how to turn on the projector and to project a picture onto the screen.

1 Turning on the Projector

NOTE:

- The projector has two power switches: a main power switch and a  (POWER) button (POWER ON and OFF on the remote control).
- When plugging in or unplugging the supplied power cable, make sure that the main power switch is pushed to the off (O) position. Failure to do so may cause damage to the projector.

1. Remove the lens cap

- Do not remove the lens cap by pulling on the string. Doing so can cause mechanical damage to the part around the lens.

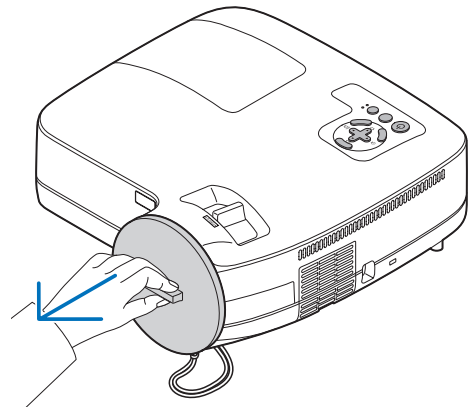
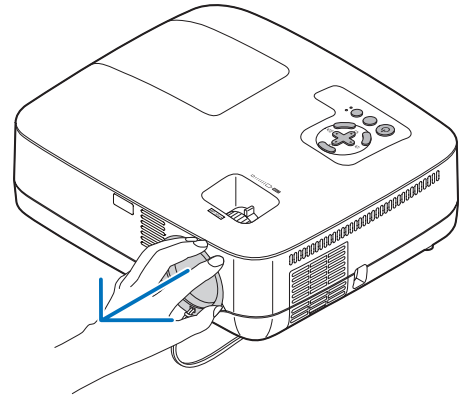

2. To turn on the main power to the projector, press the Main Power switch to the on position (I).

The projector will go into standby mode. When in standby mode, the POWER indicator will light orange and the STATUS indicator will light green when [NORMAL] is selected for [STANDBY MODE].

See the Power Indicator section. (→ page 87)

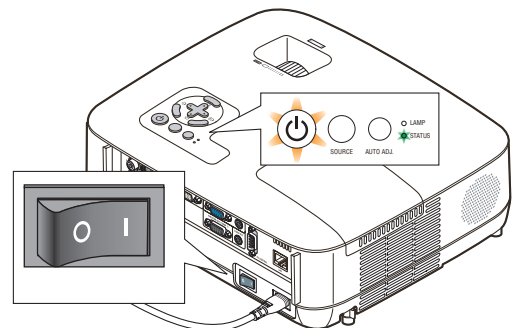

3. Projecting an Image (Basic Operation)

3. Press the  (POWER) button on the projector cabinet or the POWER ON button on the remote control for 1 second.

The POWER indicator will turn to green and the projector will become ready to use.

NOTE: When the projector is turned on, it may take some time before the lamp light becomes bright.

TIP:

- When the STATUS indicator lights orange, it means that the [CONTROL PANEL LOCK] is turned on. (→ page 72)
- When the message “Projector is locked! Enter your password.” is displayed, it means that the [SECURITY] is turned on. (→ page 43)

After you turn on your projector, ensure that the computer or video source is turned on and that your lens cap is removed.

NOTE: When no signal is available, the NEC logo, blue (default), or black screen will be displayed. When the projector displays the NEC logo, a blue or black screen, the projector will automatically switch to [ECO MODE].

The projector will return ECO MODE to its previous setting once an active signal is connected.

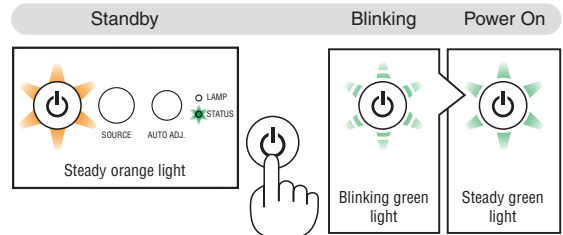
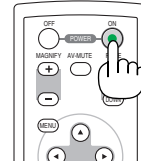
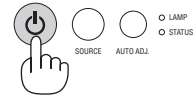

(→ page 87)

3. Projecting an Image (Basic Operation)

Note on Startup screen (Menu Language Select screen)

When you first turn on the projector, you will get the Startup menu. This menu gives you the opportunity to select one of the 21 menu languages.

To select a menu language, follow these steps:

1. Use the ▲, ▼, ◀ or ▶ button to select one of the 21 languages from the menu.

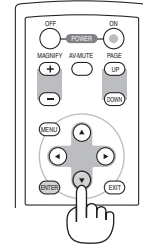
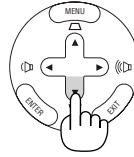

2. Press the ENTER button to execute the selection.

After this has been done, you can proceed to the menu operation.

If you want, you can select the menu language later. (→ [LANGUAGE] on page 58 and 70)

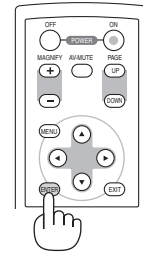
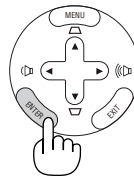

NOTE: Immediately after turning on the projector, screen flicker may occur. This is normal. Wait 3 to 5 minutes until the lamp lighting is stabilized.

NOTE: If you turn on the projector immediately after the lamp is turned off, the fans run without displaying an image for some time and then the projector will display the image.

CAUTION:

The projector cannot be turned off for 60 seconds after the lamp is turned on and while the POWER indicator is blinking green. Doing so could cause premature lamp failure.

When the [ECO MODE] is set to [ON], the LAMP indicator will light green.

If one of the following things happens, the projector will not turn on.

- If the internal temperature of the projector is too high, the projector detects abnormal high temperature. In this condition the projector will not turn on to protect the internal system. If this happens, wait for the projector's internal components to cool down.
- When the lamp reaches its end of usable life, the projector will not turn on. If this happens, replace the lamp.
- If the lamp fails to light, and if the STATUS indicator flashes on and off in a cycle of six times, wait a full minute and then turn on the power.

NOTE: Turning the Main Power Switch Off then Back On

Allow a minimum of 1 second between turning off the main power switch and turning it back on again.

The same will be applied when a power strip equipped with a switch and a breaker is used.

Failing to do so could result in no power to the projector. (There will be no stand-by LED)

Should this happen, unplug the power cable and plug it in again. Turn on the main power switch.

2 Selecting a Source

Selecting the computer or video source

NOTE: Turn on the computer or video source equipment connected to the projector.

Selecting from Source List

Press and quickly release the SOURCE button on the projector cabinet to display the Source list. Each time the SOURCE button is pressed, the input source will change as follows: "COMPUTER1", "COMPUTER2(DIGITAL/ANALOG)", "COMPUTER2" (on the NP405 and NP305 only), "VIDEO", "S-VIDEO". To display the selected source, allow 1 second to elapse.

Detecting the Signal Automatically

Press and hold the SOURCE button for a minimum of 2 seconds, the projector will search for the next available input source. Each time you press and hold the SOURCE button for a minimum of 2 seconds, the input source will change as follows:

COMPUTER1 → COMPUTER2(DIGITAL) → COMPUTER2(ANALOG) → VIDEO → S-VIDEO → COMPUTER1 → ...

TIP: If no input signal is present, the input will be skipped.

Using the Remote Control

Press any one of the COMPUTER 1/2, VIDEO, and S-VIDEO buttons.

TIP: The COMPUTER 2 button on the remote control toggles the Computer 2 source between [COMPUTER2(DIGITAL)] and [COMPUTER2(ANALOG)] (except on the NP405 and NP305).

Selecting Default Source

You can set a source as the default source so that it will be displayed each time the projector is turned on.

1. Press the MENU button.

The menu will be displayed.

2. Press the ► button twice to select [SETUP] and press the ▼ button or the ENTER button to select [GENERAL].

3. Press the ► button three times to select [OPTIONS(2)].

4. Press the ▼ button six times to select [DEFAULT SOURCE SELECT] and press the ENTER button.

The [DEFAULT SOURCE SELECT] screen will be displayed.

(→ page 77)

5. Select a source as the default source, and press the ENTER button.

6. Press the EXIT button a few times to close the menu.

7. Restart the projector.

The source you selected in step 5 will be projected.

TIP: When the projector is in Standby mode, applying a computer signal from a computer connected to the COMPUTER 1 IN input will power on the projector and simultaneously project the computer's image.

([AUTO POWER ON(COMP1)] → page 77)

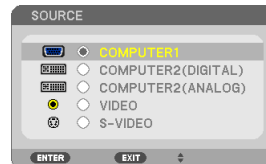
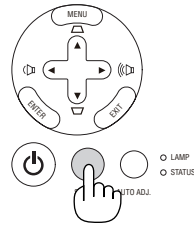

[NP610/NP510/NP410/NP310/NP510W/NP410W/NP610S/NP510WS]



[NP405/NP305]

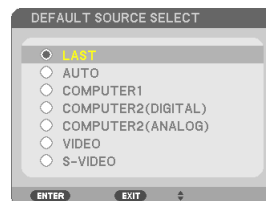
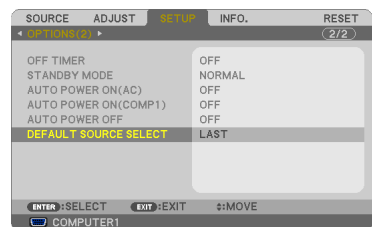
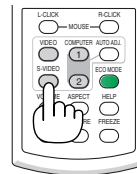

[NP610/NP510/NP410/NP310/NP510W/NP410W/NP610S/NP510WS]

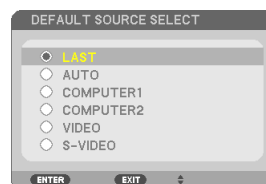

[NP405/NP305]

③ Adjusting the Picture Size and Position

Use the adjustable tilt foot, the zoom function or the focus ring to adjust the picture size and position.
In this chapter drawings and cables are omitted for clarity.

Adjusting the throw angle (the height of an image)
[Tilt foot] (→ page 31)

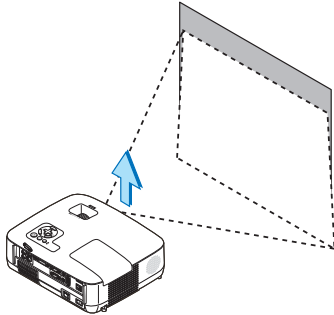

Adjusting the left and right tilt of an image
[Rear foot] (→ page 31)

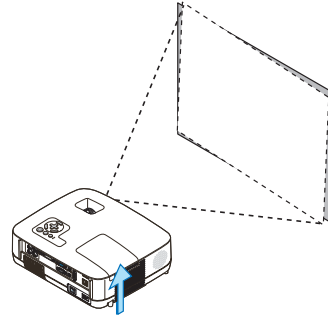

Finely adjusting the size of an image
[Zoom function] (→ page 32)

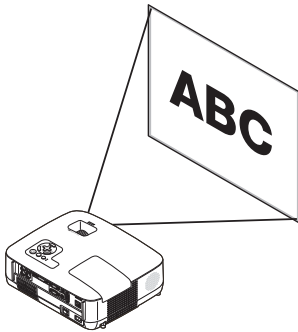

Adjusting the focus
[Focus ring] (→ page 33)

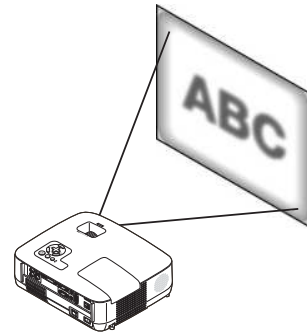

Adjusting the keystone correction [KEYSTONE]* (→ page 34)

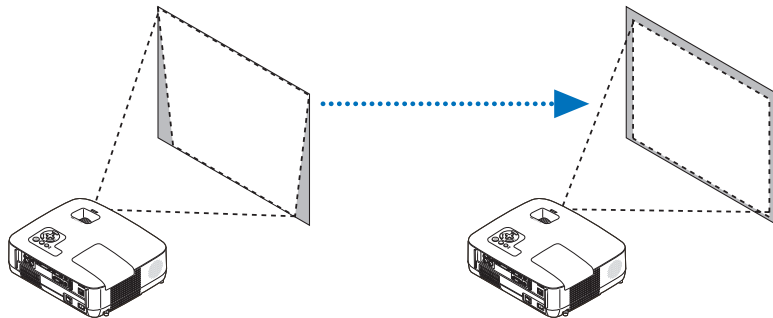

* Keystone correction can be also performed automatically. (→ page 36)

3. Projecting an Image (Basic Operation)

Adjust the Tilt Foot

1. Lift the front edge of the projector.

⚠ CAUTION:

Do not try to touch the ventilation outlet during Tilt Foot adjustment as it can become heated while the projector is turned on and after it is turned off.

2. Push up and hold the Adjustable Tilt Foot Lever on the front of the projector to extend the adjustable tilt foot.

3. Lower the front of the projector to the desired height.

4. Release the Adjustable Tilt Foot Lever to lock the Adjustable tilt foot.

The tilt foot can be extended up to 1.5 inch/38 mm.

There is approximately 10 degrees (up) of adjustment for the front of the projector.

Rotate the rear foot to the desired height in order to square the image on the projection surface.

⚠ CAUTION:

- Do not use the tilt-foot for purposes other than originally intended. Misuses such as using the tilt foot to carry or hang (from the wall or ceiling) the projector can cause damage to the projector.

Adjusting the left and right tilt of an image [Rear foot]

1. Remove the spacer (black rubber) from the rear foot.

Keep the spacer for future use.

2. Rotate the rear foot.

The rear foot can be extended up to 0.4 inch/10 mm. Rotating the rear foot allows the projector to be placed horizontally.

NOTE:

- Do not extend the rear foot beyond its height limit (0.4 inch/10 mm). Doing so may cause the rear foot to come out of the projector.
- After using the projector, attach the spacer to the rear foot.

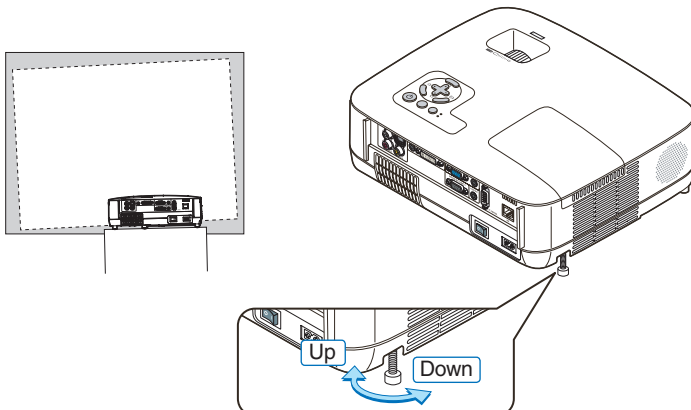
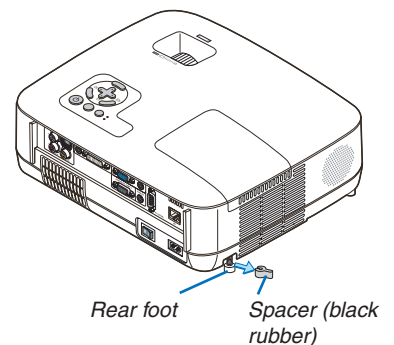
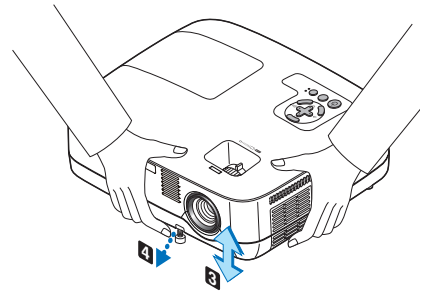
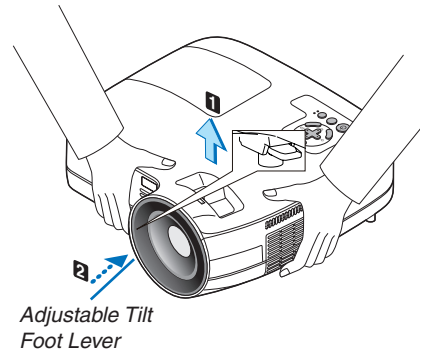
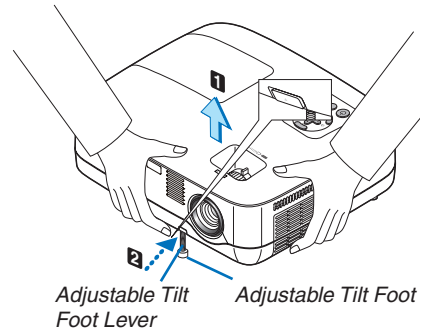

Zoom

[NP610/NP510/NP410/NP405/NP310/NP305/NP510W/NP410W]

Use the ZOOM lever to adjust the image size on the screen.

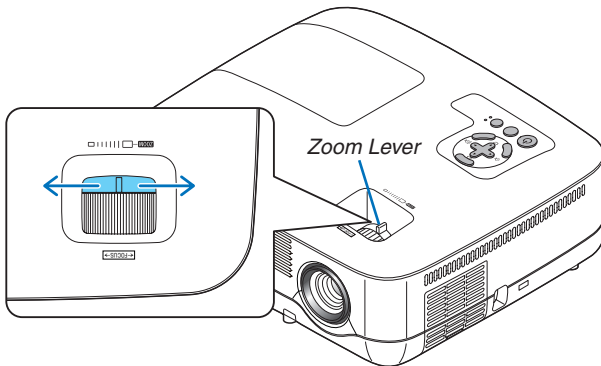

[NP610S/NP510WS]

The image size can be adjusted electronically from the menu. To do so, follow the steps below.

Adjusting from the menu

1. Press the **MENU** button.

The menu will be displayed.

2. Press the **▶** button to select **[SETUP]** and press the **ENTER** button.

The **[GENERAL]** tab will be highlighted.



3. Press the **▼** button.

The **[DIGITAL ZOOM]** will be highlighted.



3. Projecting an Image (Basic Operation)

4. Use the ◀ or ▶ button to adjust the image size.
5. After completing adjustment, press the EXIT button three times.
The menu will be closed.

Focus

[NP610/NP510/NP410/NP405/NP310/NP305/NP510W/NP410W]

Use the FOCUS ring to obtain the best focus.

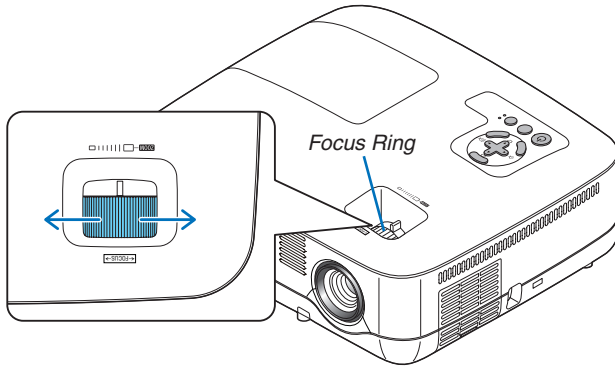

[NP610S/NP510WS]

Use the FOCUS lever to obtain the best focus.

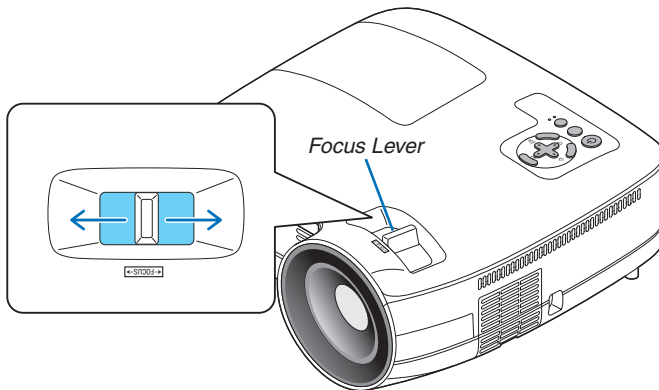

4 Correcting Keystone Distortion

Correcting Keystone Distortion

If the screen is tilted vertically, keystone distortion becomes large. Proceed with the following steps to correct keystone distortion

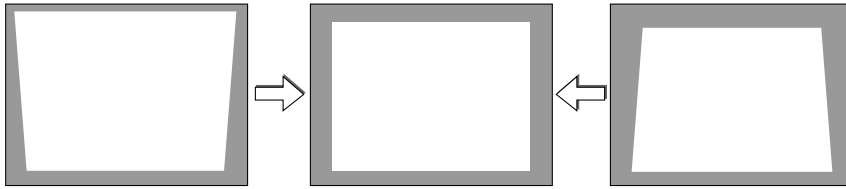

NOTE:

- The Keystone correction can cause an image to be slightly blurred because the correction is made electronically.
- The Keystone correction range can be made narrower, depending on a signal or its aspect ratio selection.

Adjusting with buttons on the cabinet

1. Press the **▲** or **▼** button with no menus displayed.

The keystone bar will be displayed.

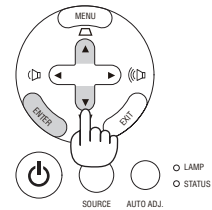
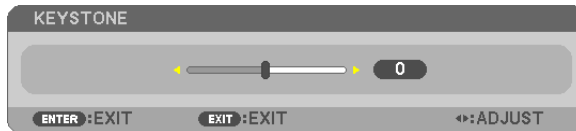

2. Use the **▲** or **▼** to correct the keystone distortion.

The keystone bar will be closed after a period of time.

3. Press the **ENTER** button.

The keystone bar will be closed.

NOTE: When the menu is displayed, the above operation is not available. When the menu is displayed, press the MENU button to close the menu and start the Keystone correction.

From the menu, select [SETUP] → [GENERAL] → [KEYSTONE]. The changes can be saved with [KEYSTONE SAVE]. (→ page 36, 68)

Adjusting from the menu

1. Press the **MENU** button.

The menu will be displayed.

2. Press the **▶** button to select **[SETUP]** and press the **ENTER** button.

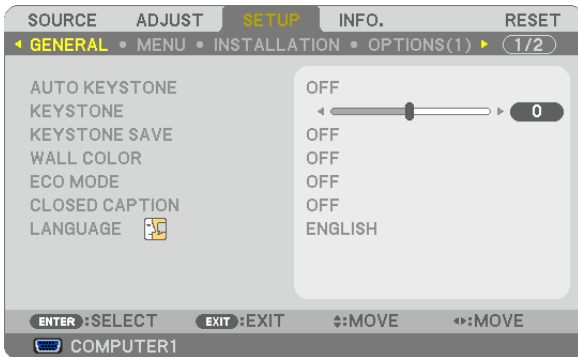

The **[GENERAL]** screen will be displayed.

3. Press the **▼** button to select **[KEYSTONE]**.

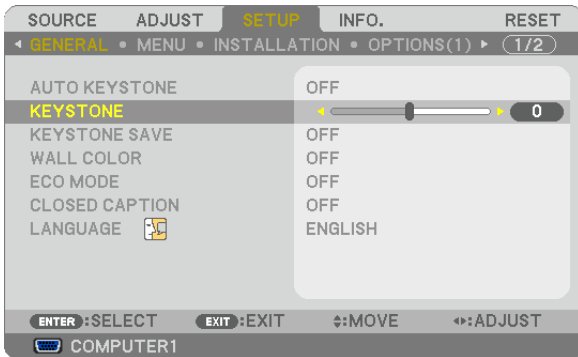

4. Press the **◀** or **▶** button.

Adjust so that the image is rectangular.

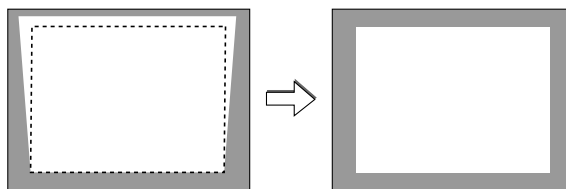

5. After completing adjustment, press the **EXIT** button three times.

The menu will be closed.

NOTE: The Keystone correction can cause an image to be slightly blurred because the correction is made electronically.

TIP: The changes can be saved with **[KEYSTONE SAVE]**. (→ page 36, 68)

3. Projecting an Image (Basic Operation)

Adjusting with the Auto Keystone Function

The Auto Keystone correction feature will correct the vertical distortion of a projected image on the screen. No special operation required. Just put the projector on a flat surface.

TIP: Even when the menu setting for [AUTO KEYSTONE] is turned on, [KEystone] can be adjusted manually.

To turn on [AUTO KEYSTONE], proceed the following steps.

1. Press the MENU button

The menu will be displayed.

2. Press the ► button to select [SETUP] and press the ENTER button.

The [GENERAL] screen will be highlighted.

3. Press the ▼ button.

The [AUTO KEYSTONE] will be highlighted.

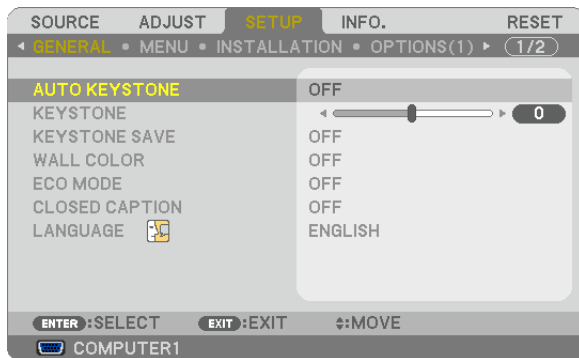

4. Press the ENTER button to display the [AUTO KEYSTONE] screen.

5. Press the ▲ or ▼ button to select [ON] and press the ENTER button.

6. Press the MENU button.

The menu will be closed.

NOTE:

- The maximum range of vertical keystone correction is ± 30 degrees on the NP610/NP510/NP410/NP405/NP310/NP305/NP510W/NP410W and ± 20 degrees on the NP610S/NP510WS.
*The maximum range of keystone correction may be lower depending on the signal or aspect ratio selection.
The range of keystone correction is not the maximum tilt angle of projector.*
 - The Auto Keystone correction will take effect in 2 seconds after changing the projection angle during projection.
 - The left and right (horizontal) keystone correction is not available.
*Place the projector so that the lens surface is parallel to the screen.
The rear feet of the projector can be adjusted to level the projector.*
 - Using keystone correction can cause the image to be slightly blurred because the correction is made electronically.
-

TIP: If you have one of the following conditions, the projector's Auto Keystone may not be performed correctly.

- The screen is tilted
 - The room temperature is too high or too low
 - The optical zoom is maximized or minimized
-

5 Optimizing Computer Signal Automatically

Adjusting the Image Using Auto Adjust

Optimizing a computer image automatically.

Press the AUTO ADJ. button to optimize a computer image automatically.

This adjustment may be necessary when you connect your computer for the first time.

[Poor picture]

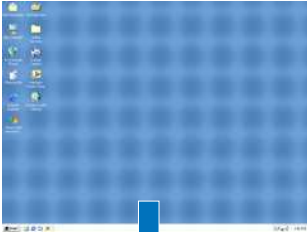

[Normal picture]

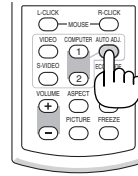
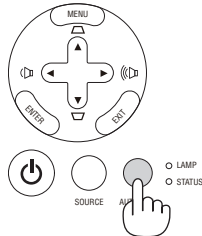
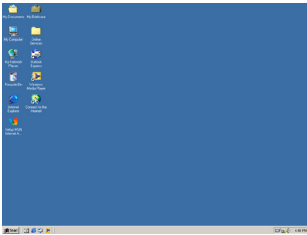

NOTE:

Some signals may take time to display or may not be displayed correctly.

- The Auto Adjust function does not work for component, video, and DVI digital signals.
- If the Auto Adjust operation cannot optimize the computer signal, try to adjust [HORIZONTAL], [VERTICAL], [CLOCK], and [PHASE] manually. (→ page 64, 65)

6 Turning Up or Down Volume

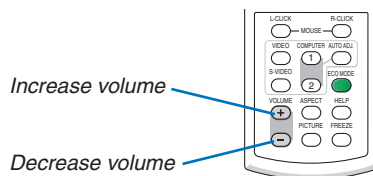

Sound level from the speaker can be adjusted.

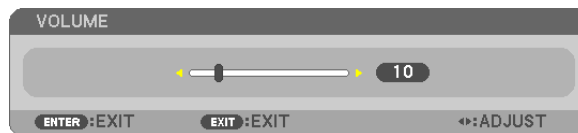

TIP: When no menus appear, the ◀ and ▶ buttons on the projector cabinet work as a volume control.

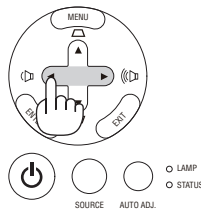

7 Turning off the Projector

To turn off the projector:

1. First, press the  (POWER) button on the projector cabinet or the POWER OFF button on the remote control.

The [POWER OFF / ARE YOU SURE? / CARBON SAVINGS- SESSION 0.000[g-CO2]] message will appear.

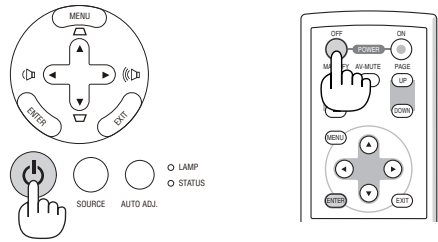
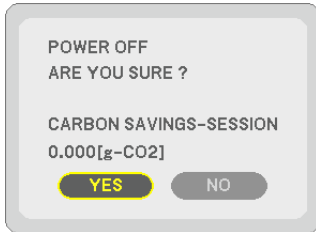

2. Secondly, press the ENTER button or press the  (POWER) or the POWER OFF button again.

The lamp will turn off and the projector will go into standby mode. When in standby mode, the POWER indicator will light orange and the STATUS indicator will light green when [NORMAL] is selected for [STANDBY MODE].

Immediately after turning on the projector and displaying an image, you cannot turn off the projector for 60 seconds.

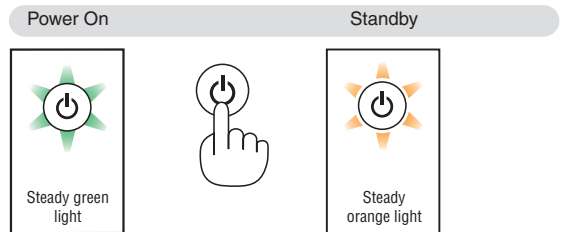

3. Finally, turn off the Main Power switch.

The POWER indicator will go out.

NOTE: Do not turn off the main power within 10 seconds of making adjustment or setting changes and closing the menu. Doing so can cause loss of adjustments and settings.

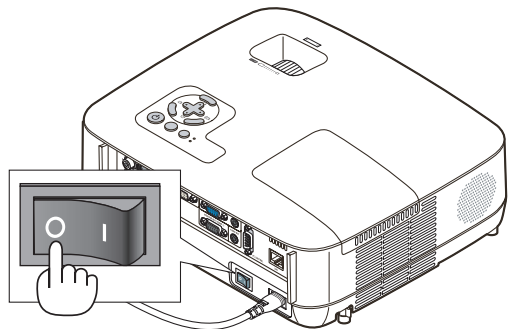

CAUTION:

Parts of the projector will become heated during operation. Use caution when picking up the projector immediately after it has been operating.

CAUTION:

The projector cannot be turned off for 60 seconds after the lamp is turned on and while the POWER indicator is blinking green. Doing so could cause premature lamp failure.

8 After Use

Preparation: Make sure that the projector is turned off.

1. *Unplug the power cable.*
2. *Disconnect any other cables.*
3. *Retract adjustable tilt foot if extended.*
4. *Cover the lens with the lens cap.*
5. *Put the projector and accessories in the supplied soft case.*

Place the projector in the soft case with the lens facing upward as shown below. This is to prevent the lens from damage.

NOTE: The NP610S, the NP510WS, the NP405, and the NP305 do not come with a soft case.

Insert the projector with the lens
facing upward

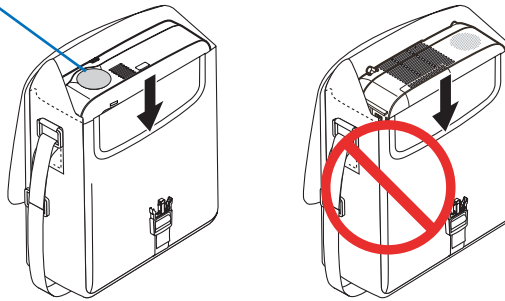

NOTE: When placing the projector in the soft case, retract the tilt foot and the rear feet. Failure to do so may cause damage to the projector.

CAUTION:

Use caution when putting the projector in the soft case immediately after the projector has been operating. The projector cabinet is hot.

4. Convenient Features

1 Turning off the Image and Sound

Press the AV-MUTE button to turn off the image and sound for a short period of time. Press again to restore the image and sound.

NOTE:

- Even though the image is turned off, the menu still remains on the screen.
- Sound from the AUDIO OUT jack (Stereo mini) can be turned off.

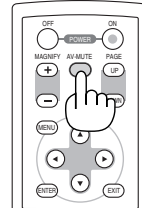

2 Freezing a Picture

Press the FREEZE button to freeze a picture. Press again to resume motion.

NOTE: The image is frozen but the original video is still playing back.

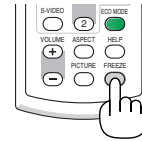

3 Enlarging a Picture

You can enlarge the picture up to four times.

NOTE: The maximum magnification may be less than four times depending on the signal.

To do so:

1. Press the MAGNIFY (+) button to magnify the picture.

To move the magnified image, use the ▲, ▼, ◀ or ▶ button.

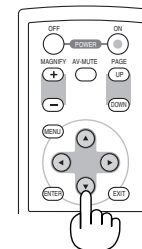
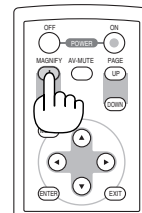
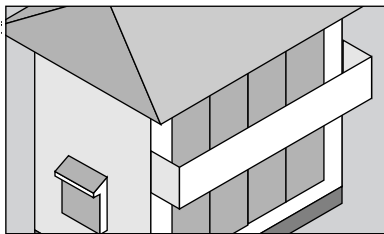
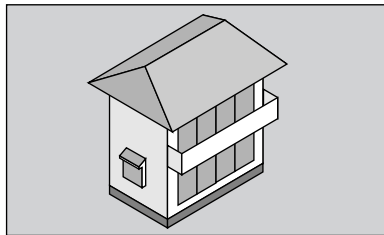

2. Press the ▲▼◀▶ button.

The area of the magnified image will be moved

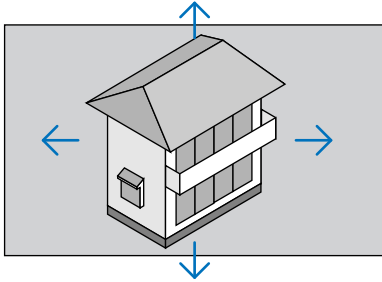

3. Press the MAGNIFY (-) button.

Each time the MAGNIFY (-) button is pressed, the image is reduced.

NOTE:

- The image will be enlarged or reduced at the center of the screen.
- Displaying the menu will cancel the current magnification.

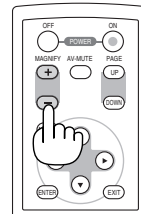

4 Changing Eco Mode

This feature enables you to select two brightness modes of the lamp:

OFF and ON modes. The lamp life can be extended by turning on the [ECO MODE].

[ECO MODE]	Description	Status of LAMP indicator
[OFF]	This is the default setting (100% Brightness).	Off ○ LAMP ○ STATUS
[ON]	Select this mode to increase the lamp life (approx. 70% Brightness on NP610/NP510W/NP410W/NP610S/NP510WS and approx. 80% Brightness on NP510/NP410/NP405/NP310/NP305).	Steady Green light ★ LAMP ○ STATUS

To turn on the [ECO MODE], do the following:

1. Press the **ECO MODE** button on the remote control to display [ECO MODE] screen.
2. Use the **▲** or **▼** button to select [ON].
3. Press the **ENTER** button.

To change from [ON] to [OFF], Go back to Step 2 and select [OFF]. Repeat Step 3.

NOTE:

- The [ECO MODE] can be changed by using the menu.
Select [SETUP] → [GENERAL] → [ECO MODE].
- The lamp life remaining and lamp hours used can be checked in [USAGE TIME]. Select [INFO.] → [USAGE TIME].
- The projector is always in [ON] for 90 seconds after the lamp is turned on and while the POWER indicator is blinking green. The lamp condition will not be affected even when [ECO MODE] is changed.
- After a lapse of 1 minute from when the projector displays a blue, black or logo screen, [ECO MODE] will automatically switch to [ON]. The projector will return to the [OFF] once a signal is accepted.
- If the projector is overheated in [OFF] mode, there may be a case where the [ECO MODE] automatically changes to [ON] mode to protect the projector. When the projector is in [ON] mode, the picture brightness decreases. When the projector comes back to normal temperature, the [ECO MODE] returns to [OFF] mode.
Thermometer symbol [🌡️] indicates the [ECO MODE] is automatically set to [ON] mode because the internal temperature is too high.

5 Checking Energy-Saving Effect [CARBON METER]

This feature will show energy-saving effect in terms of CO2 emission reduction (kg) when the projector's [ECO MODE] is set to [ON]. This feature is called as [CARBON METER].

There are two messages: [TOTAL CARBON SAVINGS] and [CARBON SAVINGS-SESSION]. The [TOTAL CARBON SAVINGS] message shows the total amount of CO2 emission reduction from the time of shipment up to now. You can check the information on [USAGE TIME] from [INFO.] of the menu. (→ page 78)

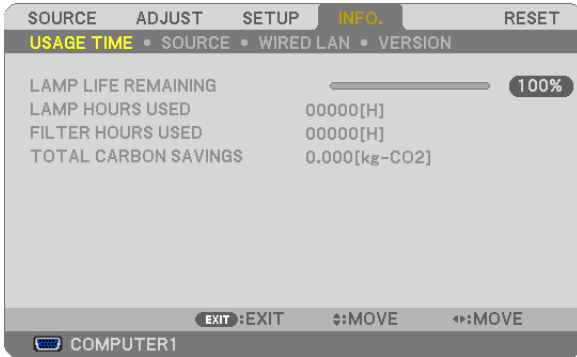

The [CARBON SAVINGS-SESSION] message shows the amount of CO2 emission reduction between the time of changing to ECO MODE immediately after the time of power-on and the time of power-off. The [CARBON SAVINGS-SESSION] message will be displayed in the [POWER OFF/ ARE YOU SURE?] message at the time of power-off.

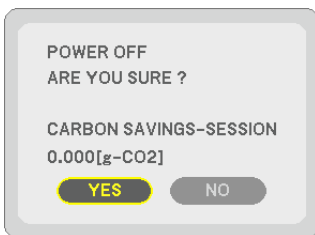

TIP:

- The formula as shown below is used to calculate the amount of CO2 emission reduction.
Amount of CO2 emission reduction = Power consumption in OFF for ECO MODE – Power consumption in ON for ECO MODE x CO2 conversion factor.*
- * Calculation for amount of CO2 emission reduction is based on an OECD publication "CO2 Emissions from Fuel Combustion, 2008 Edition".
- This formula will not apply to the power consumption which is not affected by whether [ECO MODE] is turned on or off.

6 Preventing the Unauthorized Use of the Projector [SECURITY]

A keyword can be set for your projector using the Menu to avoid operation by an unauthorized user. When a keyword is set, turning on the projector will display the Keyword input screen. Unless the correct keyword is entered, the projector cannot project an image.

- The [SECURITY] setting cannot be cancelled by using the [RESET] of the menu.

To enable the Security function:

1. Press the **MENU** button.

The menu will be displayed.

2. Press the **▶** button twice to select [SETUP] and press the **▼** button or the **ENTER** button to select [GENERAL].

3. Press the **▶** button to select [INSTALLATION].

4. Press the **▼** button three times to select [SECURITY] and press the **ENTER** button.

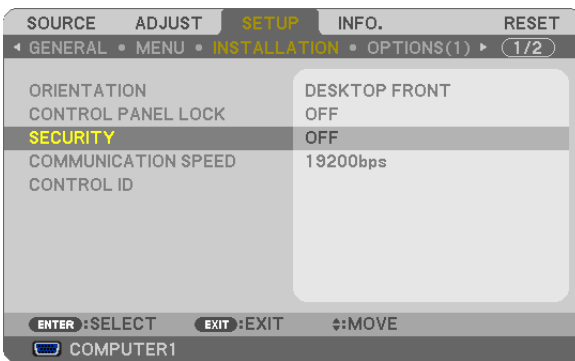

The OFF/ON menu will be displayed.

5. Press the **▼** button to select [ON] and press the **ENTER** button.



The [SECURITY KEYWORD] screen will be displayed.

6. Type in a combination of the four **▲▼◀▶** buttons and press the **ENTER** button.

NOTE: A keyword must be 4 to 10 digits in length.



The [CONFIRM KEYWORD] screen will be displayed.

7. Type in the same combination of ▲▼◀▶ buttons and press the ENTER button.

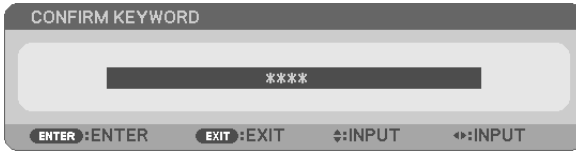

The confirmation screen will be displayed.

8. Select [YES] and press the ENTER button.

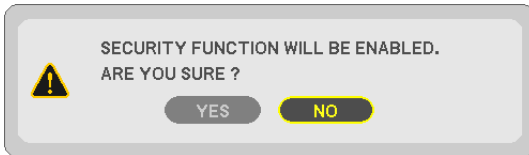

The SECURITY function has been enabled.

To turn on the projector when [SECURITY] is enabled:

1. Press and hold the POWER button for about 1 second.

The projector will be turned on and display a message to the effect that the projector is locked.

2. Press the MENU button.

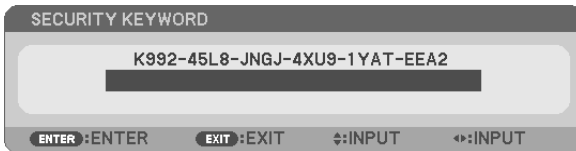

3. Type in the correct keyword and press the ENTER button. The projector will display an image.



NOTE: The security disable mode is maintained until the main power is turned off or unplugging the power cable.

To disable the SECURITY function:

1. Press the MENU button.

The menu will be displayed.

2. Select [SETUP] → [INSTALLATION] → [SECURITY] and press the ENTER button.

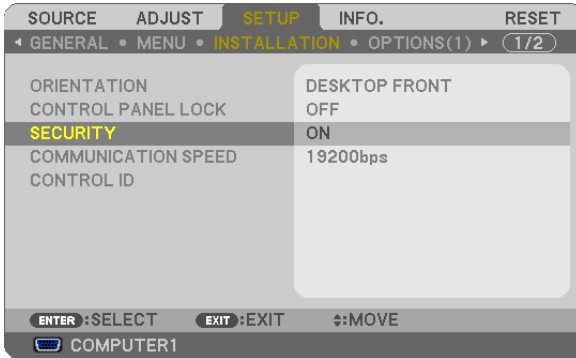

The OFF/ON menu will be displayed.

3. Select [OFF] and press the ENTER button.



The KEYWORD CONFIRMATION screen will be displayed.



4. Type in your keyword and press the ENTER button.

When the correct keyword is entered, the SECURITY function will be disabled.

NOTE: If you forget your keyword, contact your dealer. Your dealer will provide you with your keyword in exchange for your request code. Your request code is displayed in the Keyword Confirmation screen. In this example [K992-45L8-JNGJ-4XU9-1YAT-EEA2] is a request code.

⑦ Using the Optional Remote Mouse Receiver (NP01MR)

The optional remote mouse receiver enables you to operate your computer's mouse functions from the remote control. It is a great convenience for clicking through your computer-generated presentations.

Connecting the remote mouse receiver to your computer

If you wish to use the remote mouse function, connect the mouse receiver and computer. The mouse receiver can be connected directly to the computer's USB port (type A).

NOTE: Depending on the type of connection or OS installed on your computer, you may have to restart your computer or change your computer settings.

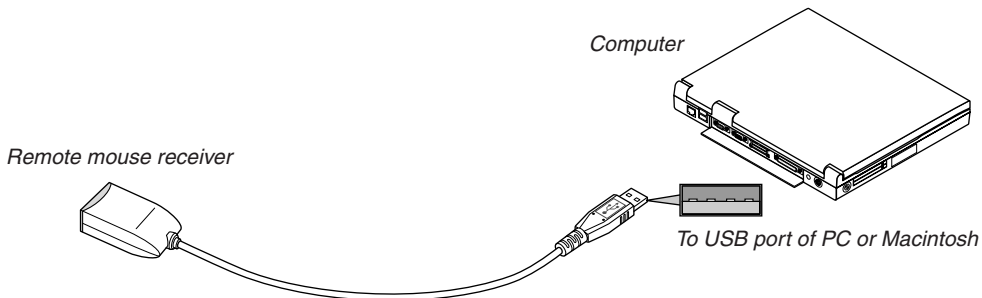

When operating a computer via the remote mouse receiver

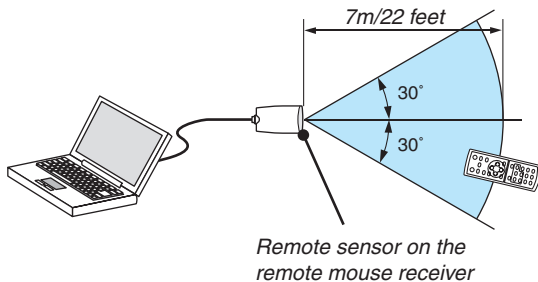

When connecting using the USB terminal

For PC, the mouse receiver can only be used with a Windows 98/Me/XP*, Windows 2000, Windows Vista, or Mac OS X 10.0.0 or later operating system.

** NOTE: In SP1 or older version of Windows XP, if the mouse cursor will not move correctly, do the following: Clear the Enhance pointer precision check box underneath the mouse speed slider in the Mouse Properties dialog box [Pointer Options tab].*

NOTE: The PAGE UP and DOWN buttons do not work with PowerPoint for Macintosh.

NOTE: Wait at least 5 seconds after disconnecting the mouse receiver before reconnecting it and vice versa. The computer may not identify the mouse receiver if it is repeatedly connected and disconnected in rapid intervals.

Operating your computer's mouse from the remote control

You can operate your computer's mouse from the remote control.

PAGE UP/DOWN Button: scrolls the viewing area of the window or to move to the previous or next slide in PowerPoint on your computer.

▲▼◀▶ Buttons: moves the mouse cursor on your computer.

MOUSE L-CLICK Button: works as the mouse left button.

MOUSE R-CLICK Button: works as the mouse right button.

NOTE:

- When you operate the computer using the ▲▼◀ or ▶ button with the menu displayed, both the menu and the mouse pointer will be affected. Close the menu and perform the mouse operation.
 - The PAGE UP and DOWN buttons do not work with PowerPoint for Macintosh.
-

About Drag Mode:

By pressing the MOUSE L-CLICK or R-CLICK button for 2 or 3 seconds then releasing, the drag mode is set and the drag operation can be performed simply by pressing the ▲▼◀▶ button. To drop the item, press the MOUSE L-CLICK (or R-CLICK) button. To cancel it, press the MOUSE R-CLICK (or L-CLICK) button.

TIP: You can change the Pointer speed on the Mouse Properties dialog box on the Windows. For more information, see the user documentation or online help supplied with your computer.

⑧ Network Setting by Using an HTTP Browser (except NP405 and NP305)

Overview

Connecting the projector to a network allows the Alert Mail setting (→ page 50) and the projector control from a computer via the network.

To perform the projector control from a web browser, you must have an exclusive application installed on your computer.

The IP address and subnet mask of the projector can be set on the Network Setting screen of the web browser by using an HTTP server function. Please be sure to use “Microsoft Internet Explorer 6.0” or a higher version for the web browser. (This device uses “JavaScript” and “Cookies” and the browser should be set to accept these functions. The setting method will vary depending on the version of browser. Please refer to the help files and the other information provided in your software.)

Access is gained to the HTTP server function by starting the Web browser on the computer via the network connected to the projector and enter the following URL.

- Network Setting
http://<the projector's IP address>/index.html
- Alert Mail Setting
http://<the projector's IP address>/lanconfig.html

TIP:

- The default IP address is “192.168.0.10”.
- The exclusive application can be downloaded from our website.

NOTE:

- If the PROJECTOR NETWORK SETTINGS screen does not appear in the web browser, press the Ctrl+F5 keys to refresh your web browser (or clear the cache).
 - The display's or button's response can be slowed down or operation may not be accepted depending the settings of your network. Should this happen, consult your network administrator.
The projector may not respond if its buttons are repeatedly pressed in rapid intervals. Should this happen, wait a moment and repeat. If you still can't get any response, turn off and back on the projector.
-

Preparation Before Use

Connect the projector to a commercially available LAN cable before engaging in browser operations. (→ page 24)
Operation with a browser that uses a proxy server may not be possible depending on the type of proxy server and the setting method. Although the type of proxy server will be a factor, it is possible that items that have actually been set will not be displayed depending on the effectiveness of the cache, and the contents set from the browser may not be reflected in operation. It is recommended that a proxy server not be used unless it is unavoidable.

Handling of the Address for Operation via a Browser

Regarding the actual address that is entered for the address or entered to the URL column when operation of the projector is via a browser, the host name can be used as it is when the host name corresponding to the IP address of the projector has been registered to the domain name server by a network administrator, or the host name corresponding to the IP address of the projector has been set in the “HOSTS” file of the computer being used.

- Example 1: When the host name of the projector has been set to “pj.nec.co.jp”, access is gained to the network setting by specifying
http://pj.nec.co.jp/index.html
for the address or the entry column of the URL.
- Example 2: When the IP address of the projector is “192.168.73.1”, access is gained to the mail alert settings by specifying
http://192.168.73.1/index.html
for the address or the entry column of the URL.

Network Settings

http://<the projector's IP address> /index.html

PROJECTOR NETWORK SETTINGS

ITEM	CURRENT VALUE	NEW VALUE
PHYSICAL ADDRESS		
MAC ADDRESS	00-11-1F-04-7*	CANNOT BE MODIFIED
IP NETWORK		
DHCP	DISABLE	<input checked="" type="radio"/> ENABLE <input type="radio"/> DISABLE
IP ADDRESS	192.168.0.10	192 . 168 . 0 . 10
SUBNET MASK	255.255.255.0	255 . 255 . 255 . 0
DEFAULT GATEWAY	192.168.0.1	192 . 168 . 0 . 1
DNS(PRIMARY)	10.32.97.60	0 . 0 . 0 . 0
DNS(SECONDARY)	0.0.0.0	0 . 0 . 0 . 0

FIRMWARE VERSION : 1.00 / MODEL : NP610_Series

Copyright (C) NEC Display Solutions, Ltd. 2008-2009. All rights reserved.

DHCP Enabling this option automatically assigns an IP address to the projector from your DHCP server. Disabling this option allows you to register the IP address or subnet mask number obtained from your network administrator.

TIP: You can check the IP address in the menu when [ENABLE] is selected for [DHCP]. To do so, from the menu, select [INFO.] → [WIRED LAN].

IP ADDRESS Set your IP address of the network connected to the projector when [DISABLE] is selected for [DHCP].

TIP: You can check your specified IP address in the menu. To do so, from the menu, select [INFO.] → [WIRED LAN].

SUBNET MASK Set your subnet mask number of the network connected to the projector when [DISABLE] is selected for [DHCP].

DEFAULT GATEWAY Set your default gateway of the network connected to the projector when [DISABLE] is selected for [DHCP].

DNS (PRIMARY) Set your primary DNS settings of the network connected to the projector.

DNS (SECONDARY) Set your secondary DNS settings of the network connected to the projector.

UPDATE Reflect your settings.

NOTE: Close the browser after clicking [UPDATE]. The projector will automatically update your settings.

TIP: Selecting [NETWORK SETTINGS] for [RESET] from the projector's menu allows you to return the following items to the factory default.

[DHCP]: DISABLE

[IP ADDRESS]: 192.168.0.10

[SUBNET MASK]: 255.255.255.0

[DEFAULT GATEWAY]: 192.168.0.1

* [DNS(PRIMARY)] and [DNS(SECONDARY)] will remain unchanged.

Alert Mail Setting

http://<the projector's IP address>/lanconfig.html

PROJECTOR NETWORK SETTINGS

ITEM	VALUE
DOMAIN	
HOST NAME	<input type="text"/>
DOMAIN NAME	<input type="text"/>
MAIL	
ALERT MAIL	<input type="radio"/> ENABLE <input type="radio"/> DISABLE
SENDER'S ADDRESS	<input type="text"/>
SMTP SERVER NAME	<input type="text"/>
RECIPIENT'S ADDRESS 1	<input type="text"/>
RECIPIENT'S ADDRESS 2	<input type="text"/>
RECIPIENT'S ADDRESS 3	<input type="text"/>

TEST MAIL

<input type="button" value="EXECUTE"/>	STATUS
	<input type="text"/>

Copyright (C) NEC Display Solutions, Ltd. 2008-2009. All rights reserved.

This option notifies your computer of an error message via e-mail when using wired LAN. An error message notification will be sent when the projector lamp has reached the end of its usable life or an error occurs in the projector.

- HOST NAME Type in the hostname of the network connected to the projector. Up to 60 alphanumeric characters can be used. If the host name is unknown, type in a string of characters representing the projector. Example: Projector 1
- DOMAIN NAME Type in the domain name of the network connected to the projector. Up to 60 alphanumeric characters can be used. If the domain name is unknown, type in the right side of @ in the sender's address. Example: nec. com
- ALERT MAIL Checking [ENABLE] will turn on the Alert Mail feature.
Checking [DISABLE] will turn off the Alert Mail feature.
- SENDER'S ADDRESS..... Type in the senders address. Up to 60 alphanumeric and symbols characters can be used.
- SMTP SERVER NAME..... Type in the SMTP server name to be connected to the projector. Up to 60 alphanumeric characters can be used.
- RECIPIENT'S ADDRESS 1 to 3.... Type in your recipient's address. Up to 60 alphanumeric and symbols characters can be used.
- APPLY..... Click this button to reflect the above settings
- EXECUTE Click this button to send a test mail to check if your settings are correct.
- STATUS..... A reply to a test mail will be displayed.

NOTE:

- If you execute a test, you may not receive an Alert mail. Should this happen, check if the network settings are correct.
- If you entered an incorrect address in a test, you may not receive an Alert mail. Should this happen, check if the Recipient's Address is correct

TIP: The Alert Mail settings will not be affected even when [RESET] is done from the menu.

⑨ Using the VGA Signal Cable to Operate the Projector (Virtual Remote)

Using the utility software “Virtual Remote Tool” included on the companion NEC Projector CD-ROM, Virtual Remote screen (or toolbar) can be displayed on your computer screen.

This will help you perform operations such as projector’s power on or off and signal selection via the VGA signal cable.



Virtual Remote screen



Toolbar

This section provides an outline of preparation for use of Virtual Remote Tool.

For information on how to use Virtual Remote Tool, see Help of Virtual Remote Tool. (→ page 55)

Step 1: Install Virtual Remote Tool on the computer. (→ page 51, 52)

Step 2: Connect the projector to the computer. (→ page 53)

Step 3: Start Virtual Remote Tool. (→ page 54)

NOTE:

- When [COMPUTER 1] is selected from your source selection, the Virtual Remote screen or the toolbar will be displayed as well as your computer screen.
- Use the supplied VGA signal cable to connect the COMPUTER 1 IN connector directly with the monitor output connector of the computer to use Virtual Remote Tool.
Using a switcher or other cables than the supplied VGA signal cable may cause failure in signal communication.
VGA cable connector:
Pin Nos. 12 and 15 are required for DDC/CI.
- Virtual Remote Tool may not work depending on your computer’s specifications and version of graphic adapters or drivers.

TIP:

- The projector’s COMPUTER 1 IN connector supports DDC/CI (Display Data Channel Command Interface). DDC/CI is a standard interface for bidirectional communication between display/projector and computer.
- For update information on Virtual Remote Tool, visit our website: <http://www.nec-display.com/dl/en/index.html>

Step 1: Install Virtual Remote Tool on the computer

Supported OS

Virtual Remote Tool will run on the following operating systems.

Windows Vista Home Basic *1, Windows Vista Home Premium *1, Windows Vista Business *1, Windows Vista Enterprise *1, Windows Vista Ultimate *1
Windows XP Home Edition *2, Windows XP Professional *2, Windows 2000 Professional *2

*1: Supports 32-bit version.

*2: To run Virtual Remote Tool, “Microsoft .NET Framework Version 2.0 or later” is required. The Microsoft .NET Framework Version 2.0 or later is available from Microsoft’s web page. Install the Microsoft .NET Framework Version 2.0 or later on your computer. Windows 2000 Professional supports Microsoft .NET Framework Version 2.0 only.

Install Virtual Remote Tool

Preparation:

Exit all running programs before installing Virtual Remote Tool. If another program is running, the installation may not be completed. To install Virtual Remote Tool, the Windows user account must have [Administrator] privilege (Windows Vista and Windows 2000) or [Computer Administrator] privilege (Windows XP).

1 Insert the accompanying NEC Projector CD-ROM into your CD-ROM drive.

The folders in NEC Projector CD-ROM will be displayed. If the folders are not displayed, right-click the CD/DVD drive icon in Windows' "Computer" (or "My Computer") and select "Open".

2 Double-click "software" and then "Virtual Remote Tool".

The "setup.exe" icon will be displayed.

3 Double-click the "setup.exe" icon.

The Installer will start and the Wizard screen will appear.



4 Click "Next".

"END USER LICENSE AGREEMENT" screen will be displayed.



Read "END USER LICENSE AGREEMENT" carefully.

5 If you agree, click "I accept the terms in the license agreement" and then click "Next".

Follow the instructions on the installer screens to complete the installation.

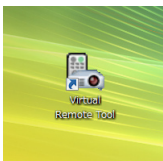

After the installation is completed, the shortcut icon  for Virtual Remote Tool will be placed on the desktop.

TIP:

Uninstalling Virtual Remote Tool

Preparation:

Exit Virtual Remote Tool before uninstalling. To uninstall Virtual Remote Tool, the Windows user account must have "Administrator" privilege (Windows Vista and Windows 2000) or "Computer Administrator" privilege (Windows XP).

• For Windows Vista

1 Click "Start" and then "Control Panel".

The Control Panel window will be displayed.

2 Click "Uninstall a program" under "Programs"

The "Programs and Features" window will be displayed.

3 Select Virtual Remote Tool and click it.

4 Click "Uninstall/Change" or "Uninstall".

• When the "User Account Control" window is displayed, click "Continue".

Follow the instructions on the screens to complete the uninstallation.

• For Windows XP/2000

1 Click "Start" and then "Control Panel".

The Control Panel window will be displayed.

2 Double-click "Add / Remove Programs".

The Add / Remove Programs window will be displayed.

• On Windows 2000, double-click "Uninstall a program".

3 Click Virtual Remote Tool from the list and then click "Remove".

Follow the instructions on the screens to complete the uninstallation.

Step 2: Connect the projector to the computer

1 Use the supplied VGA signal cable to connect the COMPUTER 1 IN connector of the projector directly with the monitor output connector of the computer.

2 Connect the supplied power cable to the AC IN of the projector and the wall outlet, and then press the Main Power switch to turn on the main power.

The projector is in the standby condition.

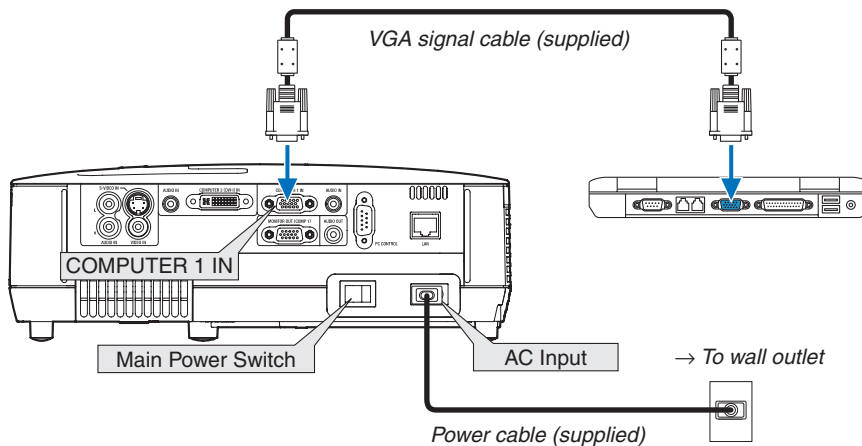

TIP:

• When Virtual Remote Tool starts for the first time, "Easy Setup" window will be displayed to navigate your connections.

Step 3: Start Virtual Remote Tool

1 Double-click the shortcut icon  on the Windows Desktop.

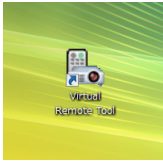

When Virtual Remote Tool starts for the first time, "Easy Setup" window will be displayed.

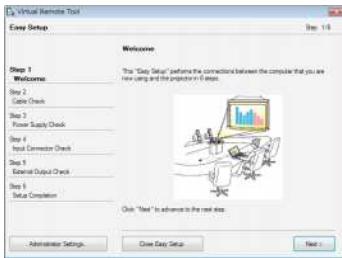

Follow the instructions on the screens

When "Easy Setup" is completed, the Virtual Remote Tool screen will be displayed.



TIP:

- The Virtual Remote Tool screen (or Toolbar) can be displayed without displaying "Easy Setup" window. To do so, click to place a check mark for " Do not use Easy Setup next time" on the screen at Step 6 in "Easy Setup".

Exiting Virtual Remote Tool

- 1 Click the Virtual Remote Tool icon  on the Taskbar.

The pop-up menu will be displayed.

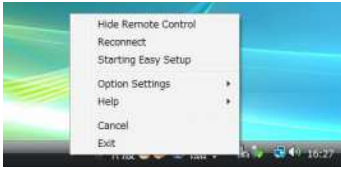

- 2 Click "Exit".

The Virtual Remote Tool will be closed.

Viewing the help file of Virtual Remote Tool

- Displaying the help file using the taskbar

- 1 Click the Virtual Remote Tool icon  on the taskbar when Virtual Remote Tool is running.

The pop-up menu will be displayed.

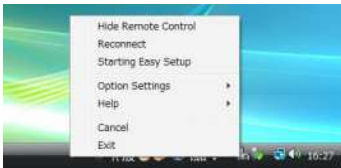

2. Click "Help".

The Help screen will be displayed.

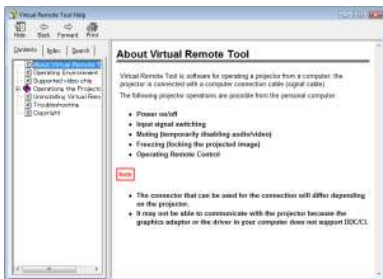

- Displaying the help file using the Start Menu.

1. Click "Start". "All programs" or "Programs". "NEC Projector User Supportware". "Virtual Remote Tool". and then "Virtual Remote Tool Help" in this order.

The Help screen will be displayed.

5. Using On-Screen Menu

① Using the Menus

NOTE: The on-screen menu may not be displayed correctly while interlaced motion video image is projected.

1. Press the **MENU** button on the remote control or the projector cabinet to display the menu.

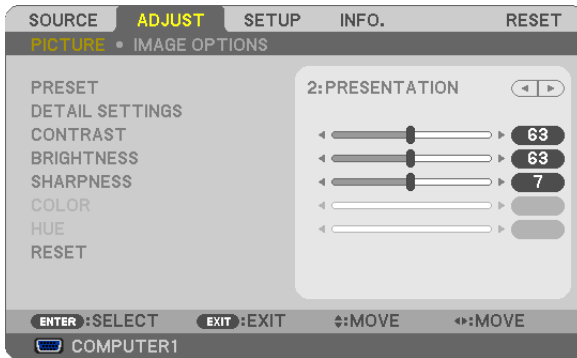

NOTE: The commands such as ENTER, EXIT, ▲▼, ◀▶ in the bottom show available buttons for your operation.

2. Press the **◀▶** buttons on the remote control or the projector cabinet to display the submenu.
3. Press the **ENTER** button on the remote control or the projector cabinet to highlight the top item or the first tab.
4. Use the **▲▼** buttons on the remote control or the projector cabinet to select the item you want to adjust or set.
You can use the **◀▶** buttons on the remote control or the projector cabinet to select the tab you want.
5. Press the **ENTER** button on the remote control or the projector cabinet to display the submenu window.
6. Adjust the level or turn the selected item on or off by using the **▲▼◀▶** buttons on the remote control or the projector cabinet.
Changes are stored until adjusted again.
7. Repeat steps 2-6 to adjust an additional item, or press the **EXIT** button on the remote control or the projector cabinet to quit the menu display.

NOTE: When a menu or message is displayed, several lines of information may be lost, depending on the signal or settings.

8. Press the **MENU** button to close the menu.
To return to the previous menu, press the **EXIT** button.

2 Menu Elements

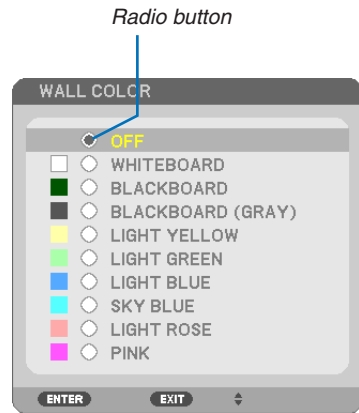
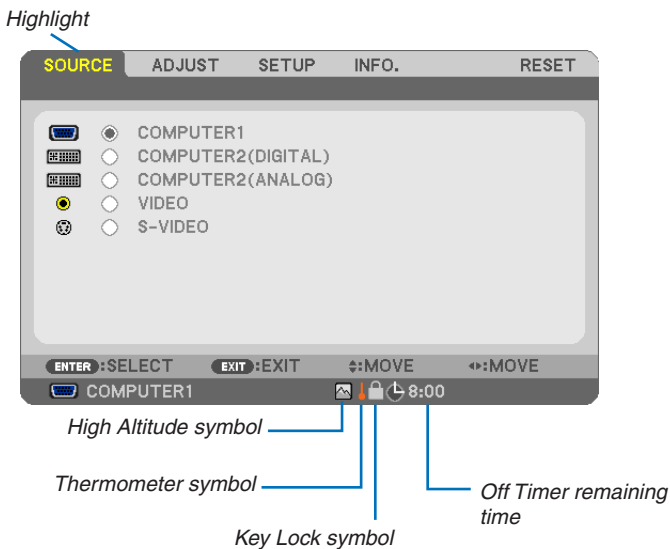
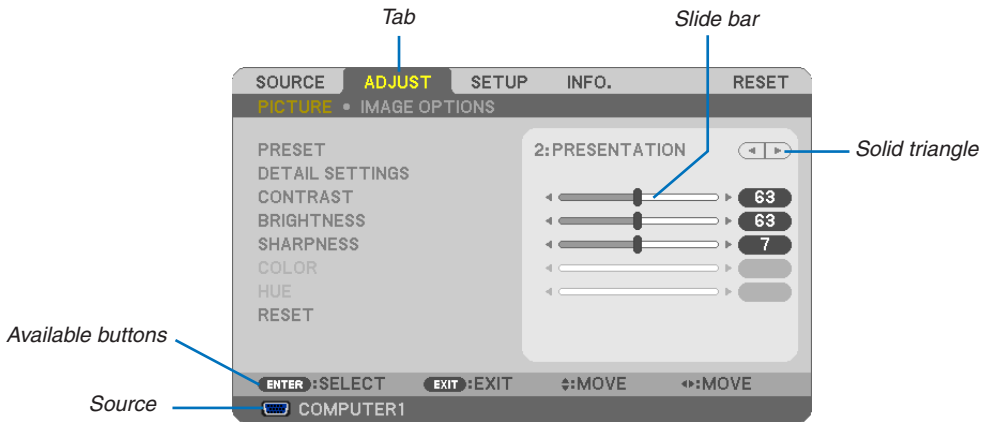

Menu windows or dialog boxes typically have the following elements:

- Highlight..... Indicates the selected menu or item.
- Solid triangle Indicates further choices are available. A highlighted triangle indicates the item is active.
- Tab..... Indicates a group of features in a dialog box. Selecting on any tab brings its page to the front.
- Radio button..... Use this round button to select an option in a dialog box.
- Source Indicates the currently selected source.
- Off Timer remaining time.... Indicates the remaining countdown time when the [OFF TIMER] is preset.
- Slide bar Indicates settings or the direction of adjustment.
- Key Lock symbol Indicates the [CONTROL PANEL LOCK] is enabled.
- Thermometer symbol Indicates the [ECO MODE] is forcibly set to [ON] mode because the internal temperature is too high.
- High Altitude symbol Indicates the [FAN MODE] is set to [HIGH ALTITUDE] mode.

3 List of Menu Items

Some menu items are not available depending on the input source.

Menu Item	Default	Options		
SOURCE	COMPUTER1	*		
	COMPUTER2(DIGITAL)*1	*		
	COMPUTER2(ANALOG)*1	*		
	VIDEO	*		
	S-VIDEO	*		
ADJUST	PRESET	* 1-6		
	PICTURE	GENERAL		
		REFERENCE	*	HIGH-BRIGHT, PRESENTATION, VIDEO, MOVIE, GRAPHIC, sRGB
		GAMMA CORRECTION		DYNAMIC, NATURAL, BLACK DETAIL
		COLOR TEMPERATURE	*	5000, 6500, 7800, 8500, 9300, 10500
		DYNAMIC CONTRAST*2	*	OFF, ON
		IMAGE MODE	*	STILL, MOVIE
		WHITE BALANCE		
		CONTRAST R	0	
		CONTRAST G	0	
		CONTRAST B	0	
		BRIGHTNESS R	0	
		BRIGHTNESS G	0	
	BRIGHTNESS B	0		
	CONTRAST			
	BRIGHTNESS			
	SHARPNESS			
	COLOR			
	HUE			
	RESET			
	IMAGE OPTIONS	CLOCK	*	
		PHASE	*	
		HORIZONTAL	*	
		VERTICAL	*	
		OVERSCAN	*	0[%], 5[%], 10[%]
		ASPECT RATIO	*	NP610/NP510/NP410/NP405/NP310/NP305/NP610S: AUTO, 4:3, 16:9, 15:9, 16:10, WIDE ZOOM, NATIVE
			*	NP510W/NP410W/NP510WS: AUTO, 4:3, 16:9, 15:9, 16:10, LETTERBOX, NATIVE
POSITION		0	(Not available on NP510W/NP410W/NP510WS)	
GENERAL	DIGITAL ZOOM*3	100	80-100	
	AUTO KEYSTONE	OFF	OFF, ON	
	KEYSTONE	0		
	KEYSTONE SAVE	OFF	OFF, ON	
	WALL COLOR	OFF	OFF, WHITEBOARD, BLACKBOARD, BLACKBOARD (GRAY), LIGHT YELLOW, LIGHT GREEN, LIGHT BLUE, SKY BLUE, LIGHT ROSE, PINK	
	ECO MODE	OFF	OFF, ON	
	CLOSED CAPTION	OFF	OFF, CAPTION1, CAPTION2, CAPTION3, CAPTION4, TEXT1, TEXT2, TEXT3, TEXT4	
	LANGUAGE	ENGLISH	ENGLISH, DEUTSCH, FRANÇAIS, ITALIANO, ESPAÑOL, SVENSKA, 日本語	
			DANSK, PORTUGUÊS, ČEŠTINA, MAGYAR, POLSKI, NEDERLANDS, SUOMI	
			NORSK, TÜRKÇE, РУССКИЙ, عربي, Ελληνικά, 中文, 한국어	
MENU	COLOR SELECT	COLOR	COLOR, MONOCHROME	
	SOURCE DISPLAY	ON	OFF, ON	
	ID DISPLAY	ON	OFF, ON	
	ECO MESSAGE	OFF	OFF, ON	
	DISPLAY TIME	AUTO 45 SEC	MANUAL, AUTO 5 SEC, AUTO 15 SEC, AUTO 45 SEC	
	BACKGROUND	BLUE	BLUE, BLACK, LOGO	
	FILTER MESSAGE	500[H]	OFF, 100[H], 200[H], 500[H], 1000[H]	

* The asterisk (*) indicates that the default setting varies depending on the signal.

*1: COMPUTER 2(DIGITAL) is not available on NP405 and NP305. The source for the computer 2 analog signal is displayed as "COMPUTER2" on NP405 and NP305.

*2: DYNAMIC CONTRAST is available on NP410 and NP310 only.

*3: DIGITAL ZOOM is available on NP610S and NP510WS only.

*4: Wired LAN is not supported by NP405 and NP305.

5. Using On-Screen Menu

SETUP	INSTALLATION	ORIENTATION		DESKTOP FRONT	DESKTOP FRONT, CEILING REAR, DESKTOP REAR, CEILING FRONT
		CONTROL PANEL LOCK		OFF	OFF, ON
		SECURITY		OFF	OFF, ON
		COMMUNICATION SPEED		19200bps	4800bps, 9600bps, 19200bps
		CONTROL ID	CONTROL ID NUMBER	1	1-254
	OPTIONS(1)	AUTO ADJUST		NORMAL	OFF, NORMAL, FINE
		FAN MODE		AUTO	AUTO, HIGH, HIGH ALTITUDE
		SIGNAL SELECT	COMPUTER1	RGB/COMPONENT	RGB/COMPONENT, RGB, COMPONENT
			COMPUTER2 (ANALOG)*1	RGB/COMPONENT	RGB/COMPONENT, RGB, COMPONENT
			VIDEO	AUTO	AUTO, NTSC3.58, NTSC4.43, PAL, PAL-M, PAL-N, PAL60, SECAM
			S-VIDEO	AUTO	AUTO, NTSC3.58, NTSC4.43, PAL, PAL-M, PAL-N, PAL60, SECAM
		WXGA MODE		NP610/NP510/ NP410/NP405/ NP310/NP305/ NP610S: OFF NP510W/ NP410W/ NP510WS: ON	OFF, ON
		DEINTERLACE		ON	OFF, ON
		BEEP		ON	OFF, ON
		OPTIONS(2)	OFF TIMER		OFF
	STANDBY MODE		NORMAL	NORMAL, POWER-SAVING	
	AUTO POWER ON(AC)		OFF	OFF, ON	
	AUTO POWER ON(COMP1)		OFF	OFF, ON	
	AUTO POWER OFF		OFF	OFF, 0:05, 0:10, 0:20, 0:30	
	DEFAULT SOURCE SELECT		LAST	LAST, AUTO, COMPUTER1, COMPUTER2(DIGITAL)*1, COMPUTER2(ANALOG), VIDEO, S-VIDEO	
INFO.	USAGE TIME	LAMP LIFE REMAINING			
		LAMP HOURS USED			
		FILTER HOURS USED			
		TOTAL CARBON SAVINGS			
	SOURCE	SOURCE NAME			
		SOURCE INDEX			
		HORIZONTAL FREQUENCY			
		VERTICAL FREQUENCY			
		SIGNAL TYPE			
		VIDEO TYPE			
		SYNC TYPE			
		SCAN TYPE			
	WIRED LAN*4	PROJECTOR NAME			
		IP ADDRESS			
		SUBNET MASK			
		GATEWAY			
	VERSION	MAC ADDRESS			
		PRODUCT			
		SERIAL NUMBER			
		FIRMWARE			
DATA					
RESET	CONTROL ID (when [CONTROL ID] is set)				
	CURRENT SIGNAL				
	ALL DATA				
	NETWORK SETTINGS*4				
	CLEAR LAMP HOURS				
CLEAR FILTER HOURS					

* The asterisk (*) indicates that the default setting varies depending on the signal.

*1: COMPUTER 2(DIGITAL) is not available on NP405 and NP305. The source for the computer 2 analog signal is displayed as "COMPUTER2" on NP405 and NP305.

*2: DYNAMIC CONTRAST is available on NP410 and NP310 only.

*3: DIGITAL ZOOM is available on NP610S and NP510WS only.

*4: Wired LAN is not supported by NP405 and NP305.

4 Menu Descriptions & Functions [SOURCE]

[NP610/NP510/NP410/NP310/NP510W/NP410W/
NP610S/NP510WS]

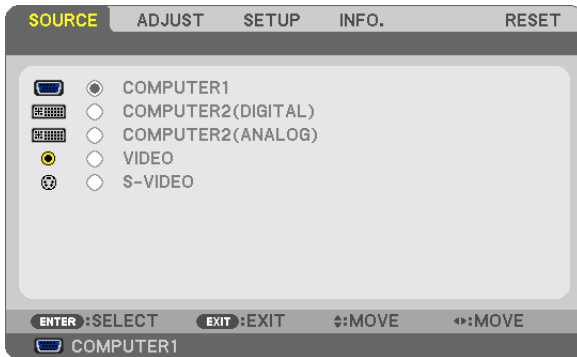

[NP405/NP305]

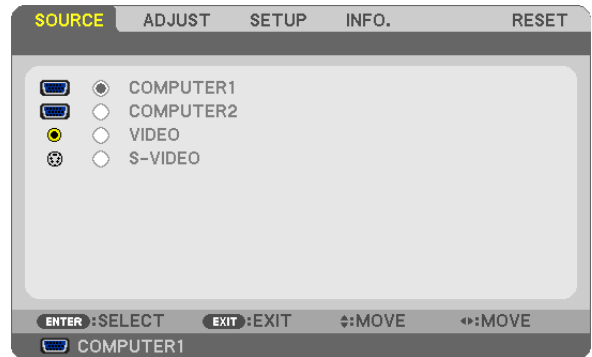

COMPUTER1

Selects the computer connected to your COMPUTER 1 IN input connector.

NOTE:

- When the component input signal is connected to the COMPUTER 1 IN connector, select [COMPUTER1].
- The projector will determine if the input signal is RGB or component signal.

COMPUTER2 (DIGITAL & ANALOG)

Selects the computer connected to your COMPUTER 2 IN (DVI-I) connector.

COMPUTER2 (NP405 and NP305 only)

Selects the computer connected to your COMPUTER2 IN connector.

VIDEO

Selects what is connected to your VIDEO input-VCR, DVD player or document camera.

S-VIDEO

Selects what is connected to your S-VIDEO input-VCR or DVD player.

NOTE: A frame may freeze for a brief period of time when a video is played back in fast-forward or fast-rewind with a Video or S-Video source.

5 Menu Descriptions & Functions [ADJUST]

[PICTURE]

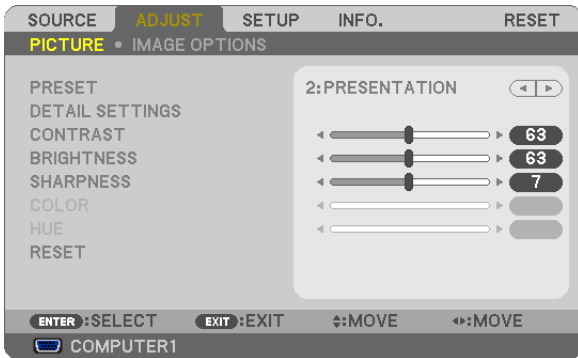

[PRESET]

This function allows you to select optimized settings for your projected image.

You can adjust neutral tint for yellow, cyan or magenta.

There are six factory presets optimized for various types of images. You can also use [DETAIL SETTINGS] to set user adjustable settings to customize each gamma or color.

Your settings can be stored in [PRESET 1] to [PRESET 6].

HIGH-BRIGHT Recommended for use in a brightly lit room.

PRESENTATION Recommended for making a presentation using a PowerPoint file.

VIDEO Recommended for typical TV program viewing.

MOVIE Recommended for movies.

GRAPHIC Recommended for graphics.

sRGB Standard color values

[DETAIL SETTINGS]

[NP610/NP510/NP405/NP305/NP510W/NP410W/
NP610S/NP510WS]

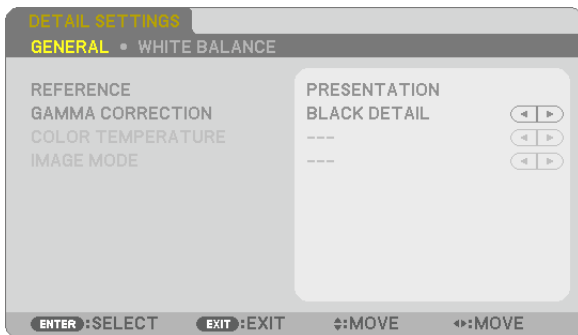

[NP410/NP310]

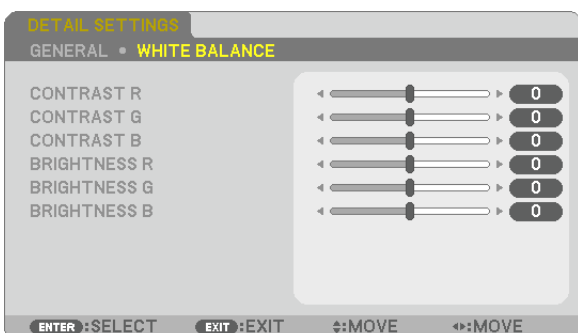

[GENERAL]

Storing Your Customized Settings [REFERENCE]

This function allows you to store your customized settings in [PRESET 1] to [PRESET 6].

First, select a base preset mode from [REFERENCE], then set [GAMMA CORRECTION] and [COLOR TEMPERATURE].

HIGH-BRIGHT Recommended for use in a brightly lit room.

PRESENTATION Recommended for making a presentation using a PowerPoint file.

VIDEO Recommended for typical TV program viewing.

MOVIE Recommended for movies.

GRAPHIC Recommended for graphics.

sRGB Standard color values.

Selecting Gamma Correction Mode [GAMMA CORRECTION]

Each mode is recommended for:

DYNAMIC Creates a high-contrast picture.

NATURAL Natural reproduction of the picture.

BLACK DETAIL Emphasizes detail in dark areas of the picture.

Adjusting Color Temperature [COLOR TEMPERATURE]

This option allows you to select the color temperature of your choice.

NOTE: When [PRESENTATION] or [HIGH-BRIGHT] is selected in [REFERENCE], this function is not available.

Adjusting Brightness and Contrast [DYNAMIC CONTRAST] (NP410 and NP310)

This function allows you to adjust the contrast ratio optically using the built-in iris.

To increase the contrast ratio, select [ON].

Selecting Still Image Mode or Movie Mode [IMAGE MODE]

This function allows you to select the still image mode or the movie mode.

STILL This mode is for a still image.

MOVIE This mode is for a movie.

NOTE: This function is available only when [HIGH-BRIGHT] is selected for [REFERENCE].

Adjusting White Balance [WHITE BALANCE]

This allows you to adjust the white balance. Contrast for each color (RGB) to adjust the white level of the screen; Brightness for each color (RGB) is used to adjust the black level of the screen.

[CONTRAST]

Adjusts the intensity of the image according to the incoming signal.

[BRIGHTNESS]

Adjusts the brightness level or the back raster intensity.

[SHARPNESS]

Controls the detail of the image.

[COLOR]

Increases or decreases the color saturation level.

[HUE]

Varies the color level from +/- green to +/- blue. The red level is used as reference.

Input signal	CONTRAST	BRIGHTNESS	SHARPNESS	COLOR	HUE
Computer (RGB DIGITAL)	Yes	Yes	Yes	No	No
Computer (RGB ANALOG)	Yes	Yes	Yes	No	No
Component	Yes	Yes	Yes	Yes*	Yes*
Video, S-Video	Yes	Yes	Yes	Yes	Yes

Yes = Adjustable, No = Not adjustable, Yes* = depending on the signal

NOTE: The NP405 and NP305 do not support "Computer (RGB DIGITAL)" signal.

[RESET]

The settings and adjustments for [CONTRAST], [BRIGHTNESS], [SHARPNESS], [COLOR], [HUE], and [REFERENCE] within [PRESET] will be returned to the factory settings.

The settings and adjustments under [DETAIL SETTINGS] within the [PRESET] screen that are not currently selected will not be reset.

[IMAGE OPTIONS]

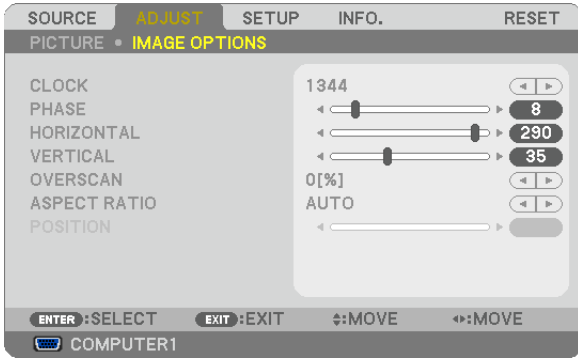

Adjusting Clock and Phase [CLOCK/PHASE]

This allows you to manually adjust CLOCK and PHASE.

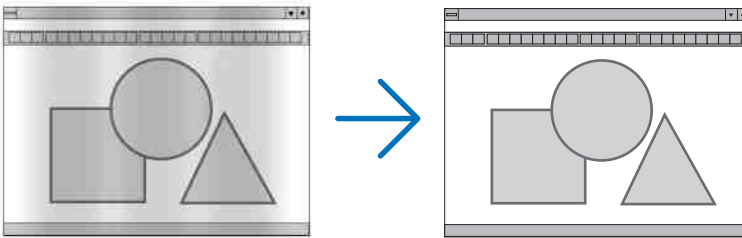

CLOCK..... Use this item to fine tune the computer image or to remove any vertical banding that might appear. This function adjusts the clock frequencies that eliminate the horizontal banding in the image. This adjustment may be necessary when you connect your computer for the first time.

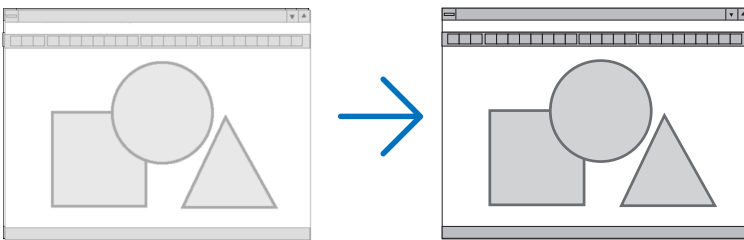

PHASE..... Use this item to adjust the clock phase or to reduce video noise, dot interference or cross talk. (This is evident when part of your image appears to be shimmering.) Use [PHASE] only after the [CLOCK] is complete.

Adjusting Horizontal/Vertical Position [HORIZONTAL/VERTICAL]

Adjusts the image location horizontally and vertically.

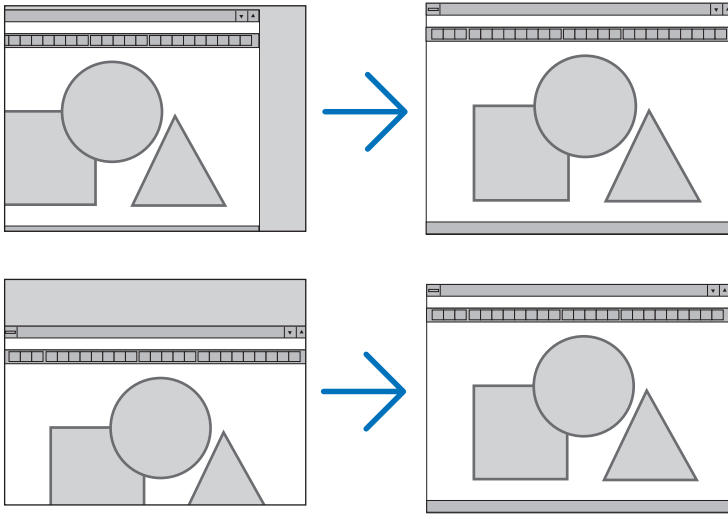

- An image can be distorted during the adjustment of [CLOCK] and [PHASE]. This is not malfunction.
- The adjustments for [CLOCK], [PHASE], [HORIZONTAL], and [VERTICAL] will be stored in memory for the current signal. The next time you project the signal with the same resolution, horizontal and vertical frequency, its adjustments will be called up and applied.

To delete adjustments stored in memory, from the menu, you select [RESET] → [CURRENT SIGNAL] or [ALL DATA] and reset the adjustments.

Selecting Overscan Percentage [OVERSCAN]

Select overscan percentage (0%, 5% and 10%) for signal.

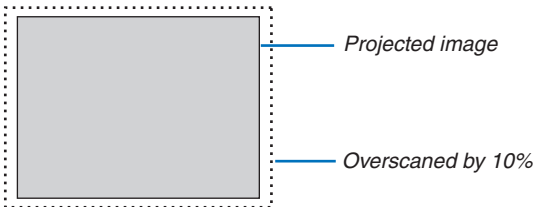

NOTE:

- The [0[%]] cannot be selected when VIDEO and S-VIDEO signals are used.
- [OVERSCAN] is not available when [NATIVE] is selected for [ASPECT RATIO].

Selecting Aspect Ratio [ASPECT RATIO]

The term “aspect ratio” refers to the ratio of width to height of a projected image.

The projector automatically determines the incoming signal and displays it in its appropriate aspect ratio.

- This table shows typical resolutions and aspect ratios that most computers support.

	Resolution	Aspect Ratio
VGA	640 x 480	4:3
SVGA	800 x 600	4:3
XGA	1024 x 768	4:3
WXGA	1280 x 768	15:9
WXGA	1280 x 800	16:10
WXGA+	1440 x 900	16:10
SXGA	1280 x 1024	5:4
SXGA+	1400 x 1050	4:3
UXGA	1600 x 1200	4:3

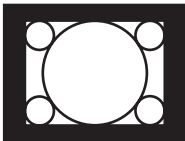
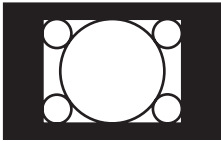
Options	Function
AUTO	The projector will automatically determine the incoming signal and display it in its aspect ratio. (→ next page) The projector may erroneously determine the aspect ratio depending on its signal. If this occurs, select the appropriate aspect ratio from the following.
4:3	The image is displayed in 4:3 aspect ratio.
16:9	The image is displayed in 16:9 aspect ratio.
15:9	The image is displayed in 15:9 aspect ratio.
16:10	The image is displayed in 16:10 aspect ratio.
WIDE ZOOM (NP610/NP510/NP410/ NP405/NP310/NP305/ NP610S)	The image is stretched left and right. Parts of the displayed image are cropped at the left and right edges and therefore not visible.
LETTERBOX (NP510W/NP410W/ NP510WS)	The image of a letterbox signal is stretched equally in the horizontal and vertical directions to fit the screen. Parts of the displayed image are cropped at the top and bottom edges and therefore not visible.
NATIVE	<p>The projector displays the current image in its true resolution when the incoming computer signal has a lower resolution than the projector’s native resolution.</p> <p>[Example 1] When the incoming signal with the resolution of 800 x 600 is displayed on the NP610/NP510/NP410/NP405/NP310/NP305/NP610S:</p>  <hr/> <p>[Example 2] When the incoming signal with the resolution of 800 x 600 is displayed on the NP510W/NP410W/NP510WS:</p>  <p>NOTE:</p> <ul style="list-style-type: none"> • When a non-computer signal is displayed, the [NATIVE] is not available. • When a signal with a higher resolution than the projector’s native resolution is displayed, [NATIVE] is not available.

Sample image when the appropriate aspect ratio is automatically determined

NP610/NP510/NP410/NP405/NP310/NP305/NP610S

[Computer signal]

Aspect ratio of incoming signal	4:3	5:4	16:9	15:9	16:10
Sample image when the appropriate aspect ratio is automatically determined					

[Video signal]

Aspect ratio of incoming signal	4:3	Letterbox	Squeeze
Sample image when the aspect ratio is automatically determined			 <i>NOTE: To display a squeezed signal properly, select [16:9] or [WIDE ZOOM].</i>

NP510W/NP410W/NP510WS

[Computer signal]

Aspect ratio of incoming signal	4:3	5:4	16:9	15:9	16:10
Sample image when the appropriate aspect ratio is automatically determined					

[Video signal]

Aspect ratio of incoming signal	4:3	Letterbox	Squeeze
Sample image when the aspect ratio is automatically determined		 <i>NOTE: To display a letterbox signal properly, select [LETTERBOX].</i>	 <i>NOTE: To display a squeezed signal properly, select [16:9].</i>

TIP:

- Image position can be adjusted vertically using [POSITION] when the [16:9], [15:9], or [16:10] aspect ratios are selected.
- The term "letterbox" refers to a more landscape-oriented image when compared to a 4:3 image, which is the standard aspect ratio for a vide source.
The letterbox signal has aspect ratios with the vista size "1.85:1" or cinema scope size "2.35:1" for movie film.
- The term "squeeze" refers to the compressed image of which aspect ratio is converted from 16:9 to 4:3.

Adjusting the Vertical Position of Image [POSITION] (not available on NP510W/NP410W/NP510WS)

(only when [16:9], [15:9], or [16:10] is selected for [ASPECT RATIO])

When [16:9], [15:9], or [16:10] is selected in [ASPECT RATIO], the image is displayed with black borders on the top and bottom.

You can adjust the vertical position from the top to the bottom of the black area.

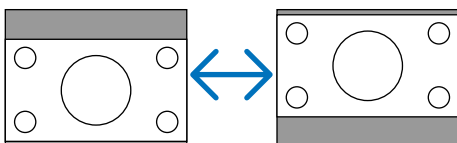

6 Menu Descriptions & Functions [SETUP]

[GENERAL]

[NP610/NP510/NP410/NP405/NP310/NP305/NP510W/
NP410W]

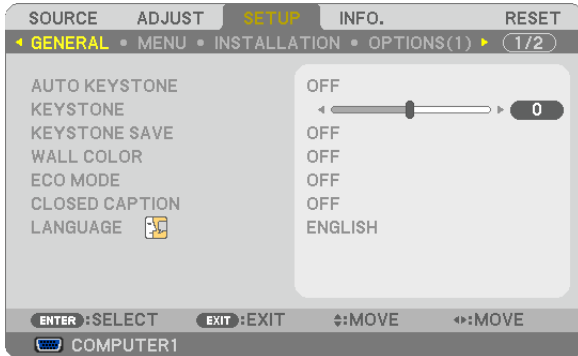

[NP610S/NP510WS]



Using Digital Zoom [DIGITAL ZOOM] (NP610S/NP510WS)

This feature allows you to electronically fine adjust the image size on the screen. Use ◀ or ▶ button to large or reduce the projected image.

TIP:

To adjust the projected image size roughly, move the projector away or closer to the screen. (→ page 30). To fine adjust the zoom, use the [DIGITAL ZOOM] function.

Enabling Auto Keystone [AUTO KEYSTONE]

This feature allows the projector to detect its tilt and correct vertical distortion automatically.

To turn on the AUTO KEYSTONE feature, select [ON]. To adjust the KEYSTONE feature manually, select [OFF].

Correcting Vertical Keystone Distortion Manually [KEYSTONE]

You can correct vertical distortion manually. (→ page 34)

TIP: When this option is highlighted, pressing the ENTER button will display its slide bar for adjustment.

Saving Vertical Keystone Correction [KEYSTONE SAVE]

This option enables you to save your current keystone settings.

OFF Does not save current keystone correction settings. It will return your keystone correction settings to "zero".

ON Saves current keystone correction settings

Saving your change once affects all sources. The changes are saved when the projector is turned off.

NOTE: When [AUTO KEYSTONE] is set to [ON], [KEYSTONE SAVE] is not available. Next time you turn on the power, the AUTO KEYSTONE function will work and the data stored with [KEYSTONE SAVE] will be invalid.

Using the Wall Color Correction [WALL COLOR]

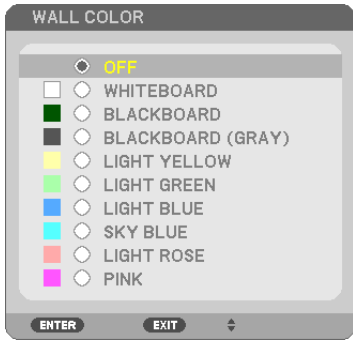

This function allows for quick adaptive color correction in applications where the screen material is not white.

NOTE: Selecting [WHITEBOARD] reduces lamp brightness.

Setting Eco Mode [ECO MODE]

This feature turns on or off the ECO mode. The lamp life can be extended by selecting [ON]. Selecting [ON] also decreases fan noise when compared to [OFF] mode.

ECO MODE	Description	Status of LAMP indicator
OFF	This is the Default setting (100% Brightness).	Off
ON	Select this mode to increase the lamp life (approx. 70% Brightness on NP610/NP510W/NP410W/NP610S/NP510WS and approx. 80% Brightness on NP510/NP410/NP405/NP310/NP305).	Steady Green light

NOTE:

- The [LAMP LIFE REMAINING] and [LAMP HOURS USED] can be checked in [USAGE TIME]. Select [INFO.] → [USAGE TIME]. (→ page 78)
- The projector is always in [ON] for 90 seconds after the lamp is turned on and while the POWER indicator is blinking green. The lamp condition will not be affected even when [ECO MODE] is changed.
- If there is no signal for about one minute, the projector will display a blue, black or logo background (depending on setting) and go into [ON].
The projector will return to the [OFF] mode once a signal is accepted.
- If the projector becomes overheated in [OFF] mode because of use in a high-temperature room, there may be a case where the [ECO MODE] automatically changes to [ON] mode to protect the projector. This mode is called “forced ECO mode”. When the projector is in [ON] mode, the picture brightness decreases. The LAMP indicator’s steady light indicates the projector is in [ON] mode. When the projector comes back to normal temperature, the [ECO MODE] returns to [OFF] mode.
Thermometer symbol [🔥] indicates the [ECO MODE] is automatically set to [ON] mode because the internal temperature is too high.

Setting Closed Caption [CLOSED CAPTION]

This option sets several closed caption modes that allow text to be superimposed on the projected image of Video or S-Video.

OFF This exits the closed caption mode.

CAPTION 1-4 Text is superimposed.

TEXT 1-4..... Text is displayed.

NOTE:

- The closed caption is not available under the following conditions:
 - when messages or menus are displayed.
 - when an image is magnified, frozen, or muted.
- Doing the following may cause portions of superimposed text or closed caption to be truncated. If this occurs, try to change correction amount or selection to place the superimposed text or closed caption within the screen.
 - Using the [DIGITAL ZOOM] or [KEystone] function to correct the image excessively
 - Selecting [16:10] or [16:9] from [ASPECT RATIO]
 - Using the [POSITION] (not available on NP510W/NP410W/NP510WS)

Selecting Menu Language [LANGUAGE]

You can choose one of 21 languages for on-screen instructions.

NOTE: Your setting will not be affected even when [RESET] is done from the menu.

[MENU]



Selecting Menu Color [COLOR SELECT]

You can choose between two options for menu color: COLOR and MONOCHROME.

Turning On / Off Source Display [SOURCE DISPLAY]

This option turns on or off input name display such as COMPUTER 1, COMPUTER2(DIGITAL), COMPUTER 2(ANALOG), VIDEO, S-VIDEO and No Input to be displayed on the top right of the screen.

On NP405/NP305, the input name will be displayed as COMPUTER 1, COMPUTER2, VIDEO, and S-VIDEO.

Turning ON/OFF Control ID [ID DISPLAY]

(Available only when the optional remote control NP02RC is used)

ID DISPLAY This option turns on or off the ID number which is displayed when the ID SET button on the remote control is pressed.

Turning On / Off Eco Message [ECO MESSAGE]

This option turns on or off the following messages when the projector is turned on.

The Eco Message prompts the user to save energy. When [OFF] is selected for [ECO MODE], you will get a message to prompt you to select [ON] for [ECO MODE].

When [ON] is selected for [ECO MODE]



To close the message, press any one of the buttons. The message will disappear if no button operation is done for 30 seconds.

When [OFF] is selected for [ECO MODE]

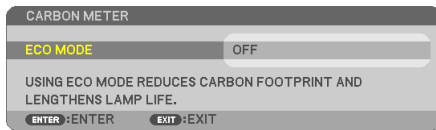

Pressing the ENTER button will display the [ECO MODE] screen. (→ page 69)

To close the message, press the EXIT button.

Selecting Menu Display Time [DISPLAY TIME]

This option allows you to select how long the projector waits after the last touch of a button to turn off the menu. The preset choices are [MANUAL], [AUTO 5 SEC], [AUTO 15 SEC], and [AUTO 45 SEC]. The [AUTO 45 SEC] is the factory preset.

Selecting a Color or Logo for Background [BACKGROUND]

Use this feature to display a blue/black screen or logo when no signal is available. The default background is [BLUE].

NOTE: Your setting will not be affected even when [RESET] is done from the menu.

Selecting Interval Time for Filter Message [FILTER MESSAGE]

This option allows you to select the time preference between displaying the message for cleaning the filters. Clean the filter when you get the message "PLEASE CLEAN FILTER." (→ page 81)

Five options are available: OFF, 100[H], 200[H], 500[H], 1000[H]

The default setting is 500[H].

NOTE: Your setting will not be affected even when [RESET] is done from the menu.

[INSTALLATION]

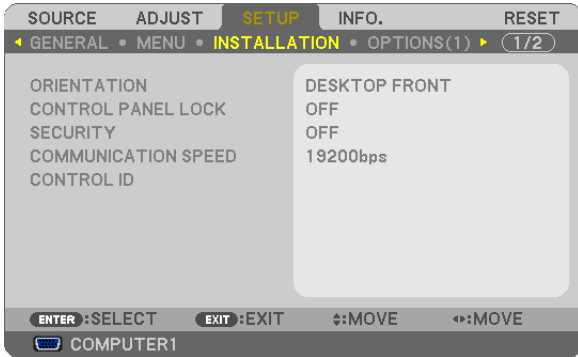

Selecting Projector Orientation [ORIENTATION]

This reorients your image for your type of projection. The options are: desktop front projection, ceiling rear projection, desktop rear projection, and ceiling front projection.

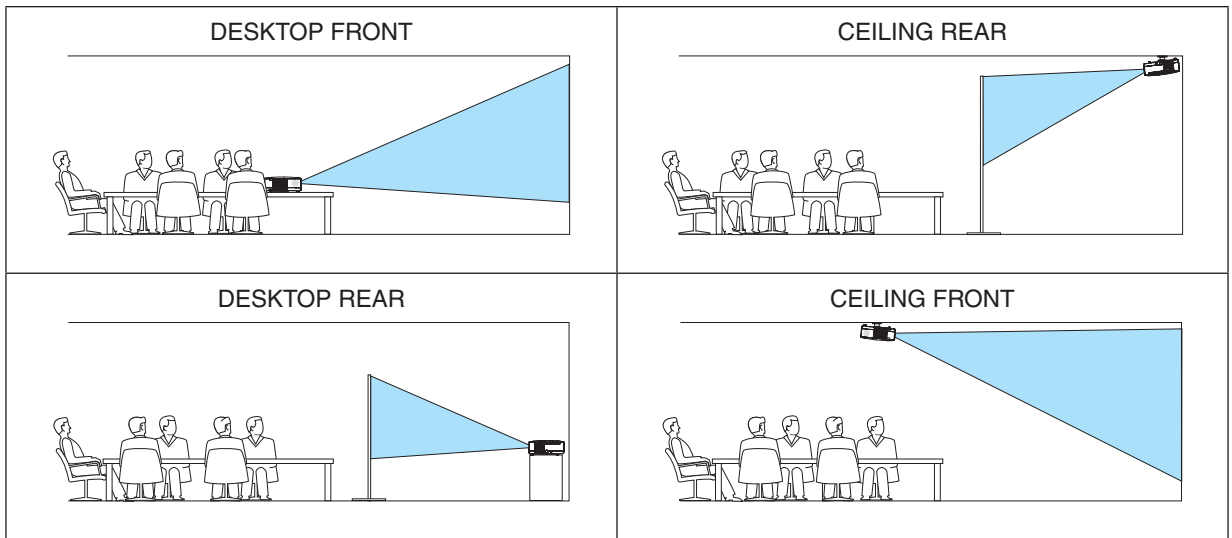

Disabling the Cabinet Buttons [CONTROL PANEL LOCK]

This option turns on or off the CONTROL PANEL LOCK function.

NOTE:

- This CONTROL PANEL LOCK does not affect the remote control functions.
- When the control panel is locked, pressing and holding the EXIT button on the projector cabinet for about 10 seconds will change the setting to [OFF].

TIP: When the [CONTROL PANEL LOCK] is turned on, a key lock icon [] will be displayed at the bottom right of the menu.

Enabling Security [SECURITY]

This feature turns on or off the SECURITY function.

Unless the correct keyword is entered, the projector cannot project an image. (→ page 43)

NOTE: Your setting will not be affected even when [RESET] is done from the menu.

Selecting Communication Speed [COMMUNICATION SPEED]

This feature sets the baud rate of the PC Control port (D-Sub 9P). It supports data rates from 4800 to 19200 bps. The default is 19200 bps. Select the appropriate baud rate for your equipment to be connected (depending on the equipment, a lower baud rate may be recommended for long cable runs).

NOTE: Your selected communication speed will not be affected even when [RESET] is done from the menu.

Setting ID to the Projector [CONTROL ID]

(Available only when the optional remote control NP02RC is used)

You can operate multiple projectors separately and independently with the single remote control that has the CONTROL ID function. If you assign the same ID to all the projectors, you can conveniently operate all the projectors together using the single remote control. To do so, you have to assign an ID number to each projector.

CONTROL ID NUMBER.....Select a number from 1 to 254 you wish to assign to your projector.

CONTROL ID.....Select [OFF] to turn off the CONTROL ID setting and select [ON] to turn on the CONTROL ID setting.

NOTE:

- Selecting [ON] for [CONTROL ID] will make the remote control supplied with the projector inoperable. The buttons on the projector cabinet can be used. Neither can you operate the projector by using the optional remote control NP01RC that does not has the CONTROL ID function.
- Your setting will not be affected even when [RESET] is done from the menu.
- Pressing and holding the ENTER button on the projector cabinet for 10 seconds will display the menu for canceling the Control ID.

Assigning or Changing the Control ID

1. Turn on the projector.

2. Press the ID SET button on the remote control (NP02RC).

The CONTROL ID screen will be displayed.

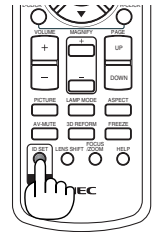

If the projector can be operated with the current remote control ID, the [ACTIVE] will be displayed. If the projector cannot be operated with the current remote control ID, the [INACTIVE] will be displayed. To operate the inactive projector, assign the control ID used for the projector by using the following procedure (Step 3).

3. Press one of numeric keypad buttons while pressing and holding the ID SET button on the remote control (NP02RC).

Example:

To assign "3", press the "3" button on the remote control.

No ID means that all the projectors can be operated together with a single remote control. To set "No ID", enter "000" or press the CLEAR button.

TIP: The range of IDs is from 1 to 254.

4. Release the ID SET button.

The updated CONTROL ID screen will be displayed.

NOTE: The IDs can be cleared in a few days after the batteries are run down or removed.

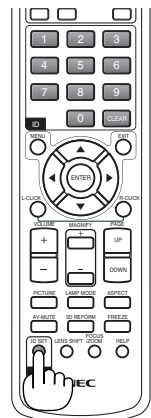

[OPTIONS(1)]

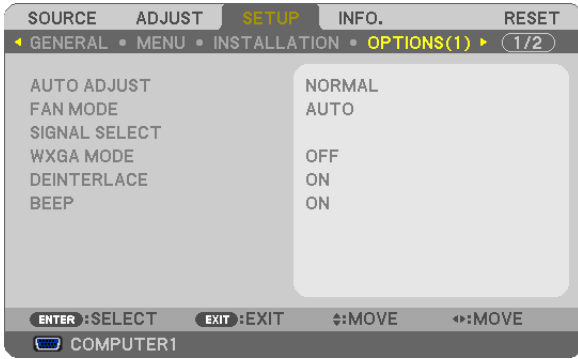

Setting Auto Adjust [AUTO ADJUST]

This feature sets the Auto Adjust mode so that the computer signal can be automatically or manually adjusted for noise and stability. You can automatically make adjustment in two ways: [NORMAL] and [FINE].

- OFF The computer signal will not be automatically adjusted. You can manually optimize the computer signal.
- NORMAL..... Default setting. The computer signal will be automatically adjusted. Normally select this option.
- FINE..... Select this option if fine adjustment is needed. It takes more time to switch to the source than when [NORMAL]is selected.

Selecting Fan Mode [FAN MODE]

This option allows you to select three modes for fan speed: Auto mode, High speed mode, and High Altitude mode.

- AUTO The built-in fans automatically run at a variable speed according to the internal temperature.
- HIGH..... The built-in fans run at high speed.
- HIGH ALTITUDE..... The built-in fans run at a high speed. Select this option when using the projector at altitudes approximately 5500 feet/1600 meters or higher.

When you wish to cool down the temperature inside the projector quickly, select [HIGH].

NOTE:

- It is recommended that you select High speed mode if you use the projector non-stop for consecutive days.
- Set [FAN MODE] to [HIGH ALTITUDE] when using the projector at altitudes approximately 5500 feet/1600 meters or higher.
- Using the projector at altitudes approximately 5500 feet/1600 meters or higher without setting to [HIGH ALTITUDE] can cause the projector to overheat and the protector could shut down. If this happens, wait a couple minutes and turn on the projector.
- Using the projector at altitudes less than approximately 5500 feet/1600 meters and setting to [HIGH ALTITUDE] can cause the lamp to overcool, causing the image to flicker. Switch [FAN MODE] to [AUTO].
- Using the projector at altitudes approximately 5500 feet/1600 meters or higher can shorten the life of optical components such as the lamp.
- Your setting will not be affected even when [RESET] is done from the menu.

Selecting Signal Format [SIGNAL SELECT]

[COMPUTER1], [COMPUTER2(ANALOG)], [COMPUTER2 on NP405/NP305]

Allows you to choose [COMPUTER1], or [COMPUTER2(ANALOG)] for an RGB source such as a computer, or [COMPONENT] for a component video source such as a DVD player. Normally select [RGB/COMPONENT] and the projector automatically detects a component signal. However there may be some component signals that the projector is unable to detect. If this is the case, select [COMPONENT].

[VIDEO & S-VIDEO System Select]

This feature enables you to select composite video standards automatically or manually.

Normally select [AUTO] and the projector will automatically detect the video standard.

In the case where the projector has difficulty detecting the video standard, select the appropriate video standard from the menu.

This must be done for VIDEO and S-VIDEO respectively.

Enabling or Disabling WXGA Mode [WXGA MODE]

Selecting [ON] will give priority to a WXGA (1280 x 768) signal in recognizing an input signal.

When [WXGA MODE] is set to [ON], an XGA (1024 x 768) signal may not be recognized on NP610, NP510, NP410, NP405, NP310, NP305, or NP610S. In this case, select [OFF].

Enabling the deinterlace [DEINTERLACE]

Turns on or off the deinterlace function for a telecine signal.

OFF Select this option if there is any jitter or artifacts in video.

ON Default standard setting.

NOTE: This feature is not available for RGB, 480p, 576p and HDTV signals.

Enabling Key Sound and Error Sound [BEEP]

This feature turns on or off the button sound or alarm when the following operations are performed.

- Displaying the main menu
- Switching sources
- Resetting data by using [RESET]
- Pressing POWER ON or POWER OFF button

[OPTIONS(2)]

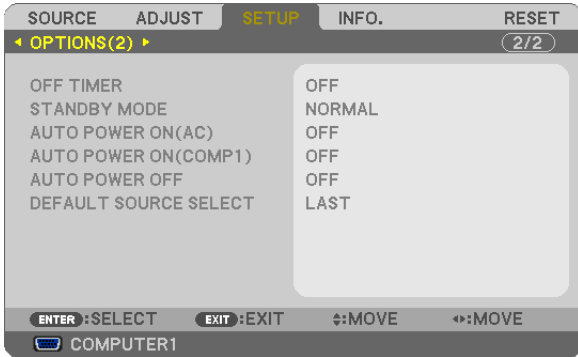

Using Off Timer [OFF TIMER]

1. Select your desired time between 30 minutes and 16 hours: OFF, 0:30, 1:00, 2:00, 4:00, 8:00, 12:00, 16:00.
2. Press the ENTER button on the remote control.
3. The remaining time starts counting down.
4. The projector will turn off after the countdown is complete.

NOTE:

- To cancel the preset time, set [OFF] for the preset time or turn off the power.
- When the remaining time reaches 3 minutes before the projector is turned off, the [THE PROJECTOR WILL TURN OFF WITHIN 3 MINUTES] message will be displayed on the bottom of the screen.

Selecting Power-saving in [STANDBY MODE]

The projector has two standby modes: [NORMAL] and [POWER-SAVING]. The POWER-SAVING mode is the mode that allows you to put the projector in the power-saving condition which consumes less power than the NORMAL mode. The projector is preset for NORMAL mode at the factory.

NORMAL..... Power indicator: Orange light/STATUS indicator: Green light

POWER-SAVING.... Power indicator: Red light/STATUS indicator: Off

The following connectors, buttons or functions will not work during this mode.

- PC CONTROL port, MONITOR OUT connector, and AUDIO OUT connector
- LAN and Mail Alert functions
- Buttons other than POWER button on the cabinet
- Buttons other than POWER ON button on the remote control
- Virtual Remote function

NOTE:

- When [CONTROL PANEL LOCK], [CONTROL ID], or [AUTO POWER ON(COMP1)] is turned on, the [STANDBY MODE] setting is not available.
- Your setting will not be affected even when [RESET] is done from the menu.

Enabling Auto Power On [AUTO POWER ON(AC)]

Turns the projector on automatically when the power cable is inserted into an active power outlet. This eliminates the need to always use the POWER button on the remote control or projector cabinet.

Turning On the Projector By Applying Computer Signal [AUTO POWER ON(COMP1)]

When the projector is in Standby mode, applying a computer signal from a computer connected to the COMPUTER1 IN input will power on the projector and simultaneously project the computer's image.

This functionality eliminates the need to always use the POWER button on the remote control or the projector cabinet to power on the projector.

To use this function, first connect a computer to the projector and the projector to an active AC input.

NOTE:

- *Disconnecting a computer signal from the computer will not power off the projector. We recommend using this function in combination of the AUTO POWER OFF function.*
 - *This function will not be available under the following conditions:*
 - *when a component signal is applied to the COMPUTER1 IN connector*
 - *when a Sync on Green RGB signal or composite sync signal is applied*
 - *To enable the AUTO POWER ON (COMP1) after turning off the projector, wait 3 seconds and input a computer signal. If a computer signal is still present when the projector is turned off, the AUTO POWER ON (COMP1) will not work and the projector remains in standby mode.*
-

Enabling Power Management [AUTO POWER OFF]

When this option is selected you can enable the projector to automatically turn off (at the selected time: 5min., 10min., 20min., 30min.) if there is no signal received by any input or if no operation is performed.

Selecting Default Source [DEFAULT SOURCE SELECT]

You can set the projector to default to any one of its inputs each time the projector is turned on.

- LAST Sets the projector to default to the previous or last active input each time the projector is turned on.
- AUTO Searches for an active source in order of COMPUTER1 → COMPUTER 2(DIGITAL) → COMPUTER2 (ANALOG) → VIDEO → S-VIDEO → COMPUTER1 and displays the first found source.
- COMPUTER1 Displays the computer signal from the COMPUTER 1 IN connector every time the projector is turned on.
- COMPUTER2(DIGITAL)..... Displays the DVI digital from the COMPUTER 2 IN connector every time the projector is turned on. (Not available on NP405/NP305)
- COMPUTER2(ANALOG) Displays the computer signal from the COMPUTER 2 IN connector every time the projector is turned on. ("COMPUTER2" on NP405/NP305)
- VIDEO Displays the Video source from the VIDEO IN connector every time the projector is turned on.
- S-VIDEO Displays the Video source from the S-VIDEO IN connector every time the projector is turned on.

7 Menu Descriptions & Functions [INFO.]

Displays the status of the current signal and lamp usage. This item has four pages (three pages on NP405 and NP305). The information included is as follows:

TIP: Pressing the HELP button on the remote control will show the [INFO.] menu items.

[USAGE TIME]

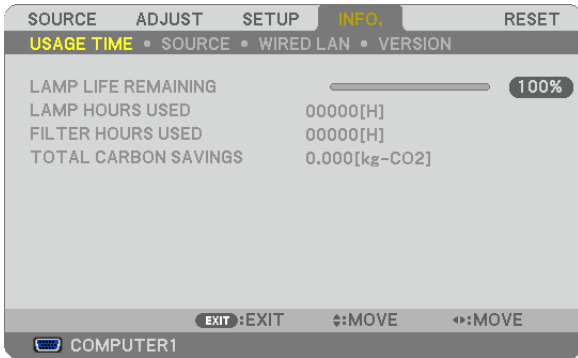

- [LAMP LIFE REMAINING] (%)*
- [LAMP HOURS USED] (H)
- [FILTER HOURS USED] (H)
- [TOTAL CARBON SAVINGS] (kg-CO2)

- * The progress indicator shows the percentage of remaining bulb life. The value informs you of the amount of lamp usage. When the remaining lamp time reaches 0, the LAMP LIFE REMAINING bar indicator changes from 0% to 100 Hours and starts counting down. If the remaining lamp time reaches 0 hours, the projector will not turn on regardless of whether the ECO MODE is set to OFF or ON.
- The message to the effect that the lamp or the filters should be replaced will be displayed for one minute when the projector is turned on and when the POWER button on the projector or the remote control is pressed. To dismiss this message, press any button on the projector or the remote control.

Lamp life(H)		Replacement lamp	Model
ECO MODE			
OFF	ON		
4000	5000	NP07LP	NP610/NP510W/NP410W/NP610S/NP510WS
		NP14LP	NP510/NP410/NP405/NP310/NP305

- [TOTAL CARBON SAVINGS] This displays the estimated carbon saving information in kg. The carbon footprint factor in the carbon saving calculation is based on the OECD (2008 Edition).

[SOURCE]

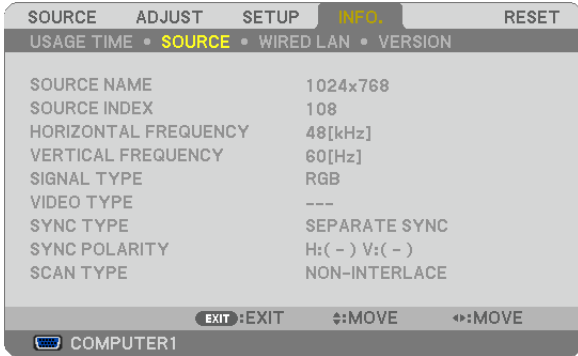

- [SOURCE NAME]
- [SOURCE INDEX]
- [HORIZONTAL FREQUENCY]
- [VERTICAL FREQUENCY]
- [SIGNAL TYPE]
- [VIDEO TYPE]
- [SYNC TYPE]
- [SYNC POLARITY]
- [SCAN TYPE]

[WIRED LAN] (not available on NP405/NP305)



- [PROJECTOR NAME]
- [IP ADDRESS]
- [SUBNET MASK]
- [GATEWAY]
- [MAC ADDRESS]

[VERSION]



- [PRODUCT]
- [SERIAL NUMBER]
- [FIRMWARE] Version
- [DATA] Version
- [CONTROL ID] (when [CONTROL ID] is set)

8 Menu Descriptions & Functions [RESET]

[NP610/NP510/NP410/NP310/NP510W/NP410W/
NP610S/NP510WS]

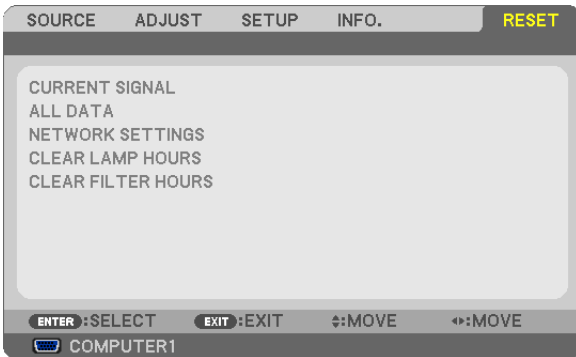

[NP405/NP305]

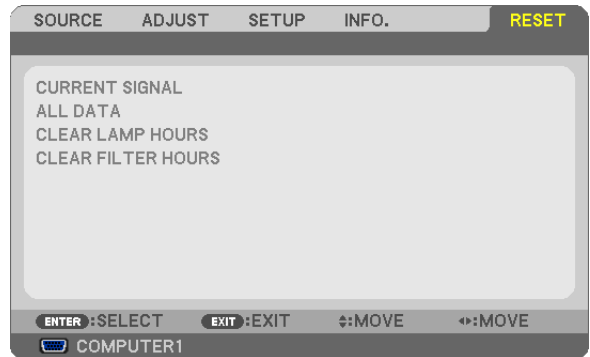

Returning to Factory Default [RESET]

The RESET feature allows you to change adjustments and settings to the factory preset for a (all) source (s) except the following:

[CURRENT SIGNAL]

Resets the adjustments for the current signal to the factory preset levels.

The items that can be reset are: [PRESET], [CONTRAST], [BRIGHTNESS], [COLOR], [HUE], [SHARPNESS], [ASPECT RATIO], [HORIZONTAL], [VERTICAL], [CLOCK], [PHASE], and [OVERSCAN].

[ALL DATA]

Reset all the adjustments and settings for all the signals to the factory preset.

All items can be reset **EXCEPT** [LANGUAGE], [BACKGROUND], [FILTER MESSAGE], [SECURITY], [COMMUNICATION SPEED], [CONTROL ID], [STANDBY MODE], [FAN MODE], [LAMP LIFE REMAINING], [LAMP HOURS USED], [FILTER HOURS USED], [TOTAL CARBON SAVINGS], and [NETWORK SETTINGS].

To reset the lamp usage time, see “Clearing Lamp Hour Meter [CLEAR LAMP HOURS]” below.

Clearing Networking Settings [NETWORK SETTINGS] (Not available on NP405/NP305)

Returns [DHCP], [IP ADDRESS], [SUBNET MASK], and [GATEWAY] to the default settings.

Clearing Lamp Hour Meter [CLEAR LAMP HOURS]

Resets the lamp clock back to zero. Selecting this option displays submenu for a confirmation. Select [YES] and press the ENTER button.

NOTE: Elapsed time of the lamp use will not be affected even when [RESET] is done from the menu.

NOTE: The projector will turn off and go into standby mode when you continue to use the projector for another 100 hours after the lamp has reached the end of its life. In this condition you cannot clear the lamp hour meter on the menu. If this happens, press the HELP button on the remote control for 10 seconds to reset the lamp clock back to zero. Do this only after replacing the lamp.

Clearing the Filter Usage Hours [CLEAR FILTER HOURS]

Resets the filter usage back to zero. Selecting this option displays submenu for a confirmation. Select [YES] and press the ENTER button.

NOTE: Elapsed time of the filter use will not be affected even when [RESET] is done from the menu.

6. Maintenance

This section describes the simple maintenance procedures you should follow to clean the filters and replace the lamp.

① Cleaning or Replacing the Filters

The air-filter sponge keeps dust and dirt from getting inside the projector and should be frequently cleaned. If the filter is dirty or clogged, your projector may overheat.

NOTE: The message for filter cleaning will be displayed for one minute after the projector is turned on or off. To cancel the message, press any button on the projector cabinet or the remote control.

CAUTION

- Turn off the projector, turn off the main power switch and unplug the projector before replacing the filters.
- Only clean the outside of the filter cover with a vacuum cleaner.
- Do not attempt to operate the projector without the filter cover.

To clean the air-filter:

Vacuum the filter-through the filter cover.

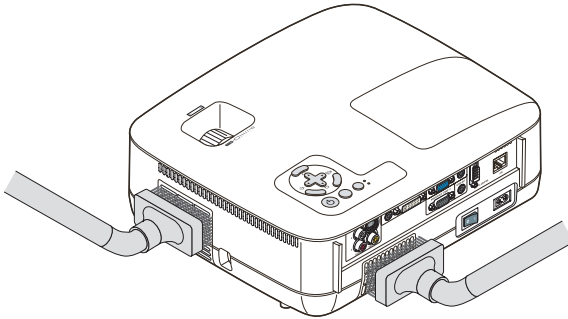

To replace the filter (sponge):

1. Remove the filter cover (2 locations) by pushing up on the catch of the cover until you feel it detach.

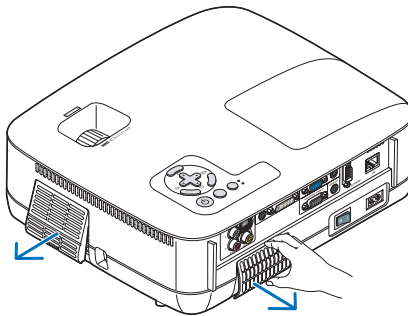

2. Replace two filters.

- (1) Gently peel off the filter (sponge) and clean the filter cover.
- (2) Attach the new filter to the filter cover.

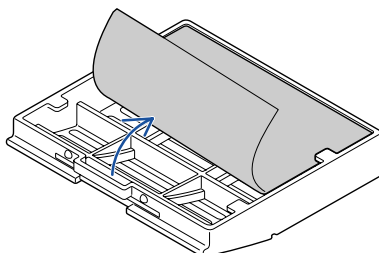

3. Reinstall the new filter cover (2 locations).

- Insert the filter cover until you feel click.

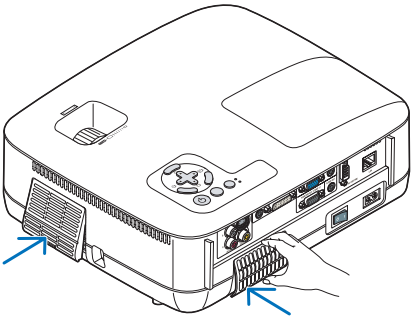

4. Clear the filter hours used.

To reset the filter usage time, from the menu, select [RESET] → [CLEAR FILTER HOURS].
(→ page 80 for resetting the filter usage time.)

NOTE: Do not wash the filter with soap and water. Soap and water will damage the filter membrane. Before replacing the filter, remove dust and dirt from the projector cabinet. Keep out dust and dirt during filter replacement.

NOTE: When you replace the lamp, it is also wise to replace the filter. The filter comes in the same package with your replacement lamp.

② Cleaning the Cabinet and the Lens

1. Turn off the projector before cleaning.
2. Clean the cabinet periodically with a damp cloth. If heavily soiled, use a mild detergent. Never use strong detergents or solvents such as alcohol or thinner.

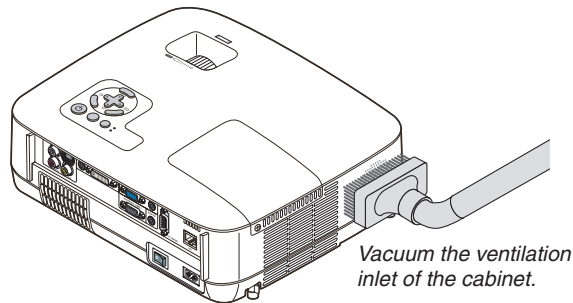

Note on Cleaning the Lens (NP610/NP510/NP410/NP405/NP310/NP305/NP510W/NP410W)

Use a blower or lens paper to clean the lens, and be careful not to scratch or mar the lens.

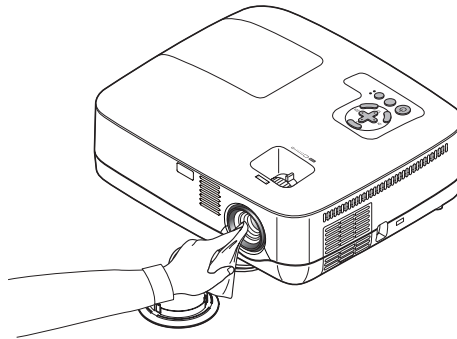

Note on Cleaning the Lens (NP610S/NP510WS)

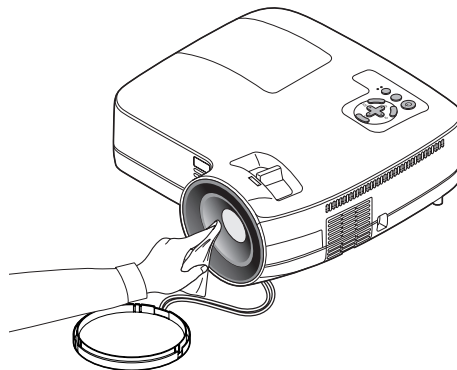

The NP610S and NP510WS have a plastic lens. Use a commercially available plastic lens cleaner.

NOTE:

- Do not scratch or mar the lens surface as a plastic lens is easily scratched.
 - Never use alcohol or glass lens cleaner as doing so will cause damage to the lens surface.
-

③ Replacing the Lamp

When the lamp reaches the end of its life, the LAMP indicator in the cabinet will blink red. Even though the lamp may still be working, replace the lamp to maintain the optimal projector performance. After replacing the lamp, be sure to clear the lamp hour meter. (→ page 80)

CAUTION

- DO NOT TOUCH THE LAMP immediately after it has been used. It will be extremely hot. Turn the projector off, turn off the main power switch and then disconnect the power cable. Allow at least one hour for the lamp to cool before handling.
- DO NOT REMOVE ANY SCREWS except one lamp cover screw and two lamp housing screws. You could receive an electric shock.
- Do not break the glass on the lamp housing.
Keep finger prints off the glass surface on the lamp housing. Leaving finger prints on the glass surface might cause an unwanted shadow and poor picture quality.
- The projector will turn off and go into standby mode when you continue to use the projector for another 100 hours after the lamp has reached the end of its life. If this happens, be sure to replace the lamp. If you continue to use the lamp after the lamp reaches the end of its life, the lamp bulb may shatter, and pieces of glass may be scattered in the lamp case. Do not touch them as the pieces of glass may cause injury. If this happens, contact your NEC dealer for lamp replacement.

**NOTE: This message will be displayed under the following conditions:*

- for one minute after the projector has been powered on
- when the  (POWER) button on the projector cabinet or the POWER OFF button on the remote control is pressed

To turn off the message, press any button on the projector cabinet or the remote control.

To replace the lamp:

Optional lamp and tools needed for replacement:

- Replacement lamp:
NP07LP (NP610/NP510W/NP410W/NP610S/NP510WS)
NP14LP (NP510/NP410/NP405/NP310/NP305)

1. Remove the lamp cover.

- (1) Loosen the lamp cover screw
 - The lamp cover screw is not removable.
- (2) Push and slide the lamp cover off.

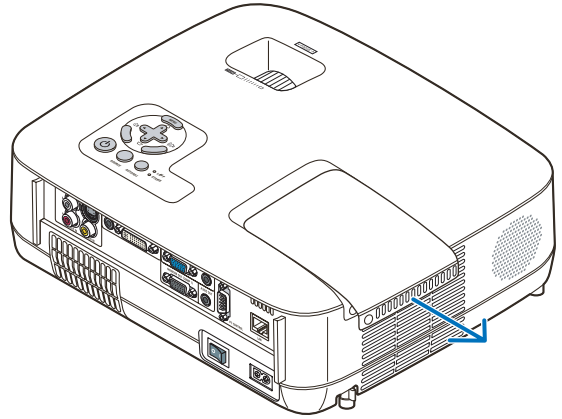
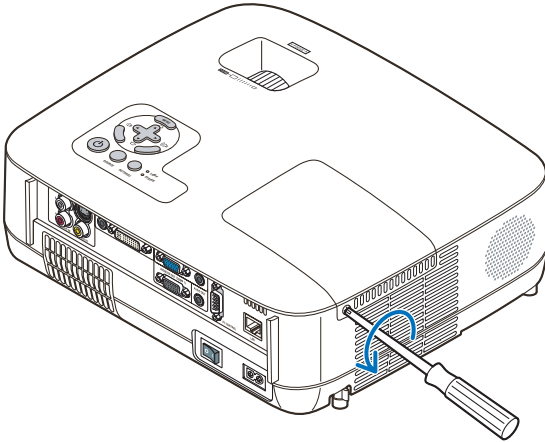

2. Remove the lamp housing.

- (1) Loosen the two screws securing the lamp housing until the phillips screwdriver goes into a freewheeling condition.
 - The two screws are not removable.
 - There is an interlock on this case to prevent the risk of electrical shock. Do not attempt to circumvent this interlock.
- (2) Remove the lamp housing by holding it.

 **CAUTION:**

Make sure that the lamp housing is cool enough to before removing it.

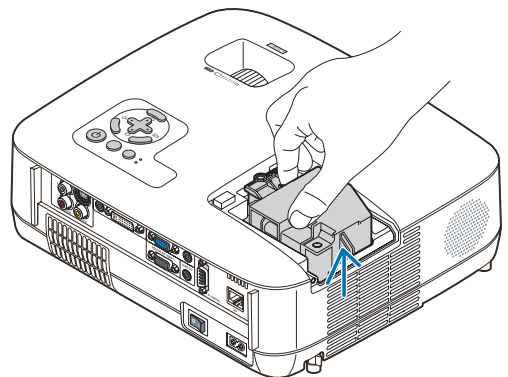
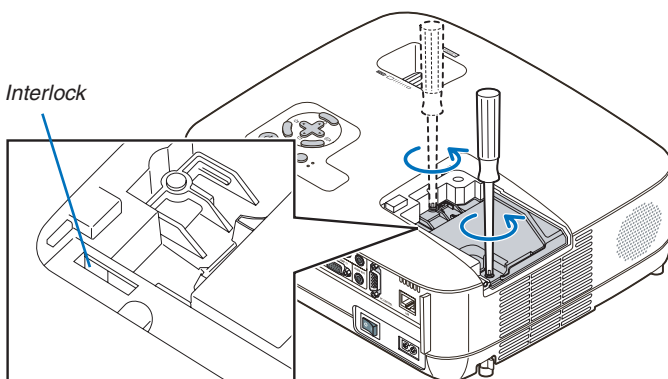

3. Install a new lamp housing.

(1) Insert a new lamp housing until the lamp housing is plugged into the socket.

CAUTION

Do not use a lamp other than the NEC replacement lamp NP07LP (NP610/NP510W/NP410W/NP610S/NP510WS)/NP14LP (NP510/NP410/NP405/NP310/NP305).
Order this from your NEC dealer.

(2) Push the top center of the lamp housing to secure it.

(3) Secure it in place with the two screws.

- Be sure to tighten the screws.

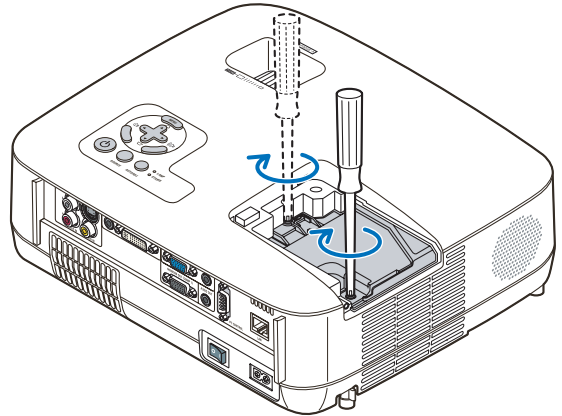
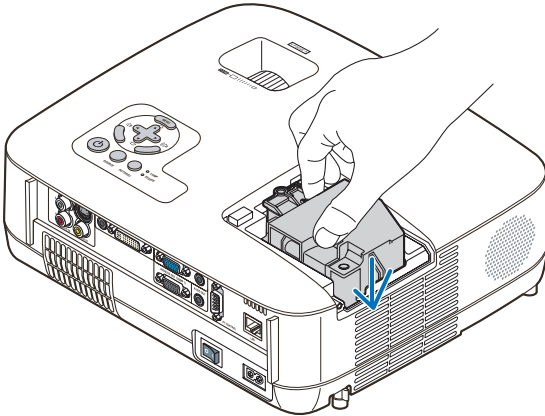

4. Reattach the lamp cover.

(1) Slide the lamp cover back until it snaps into place.

(2) Tighten the screw to secure the lamp cover.

- Be sure to tighten the screw.

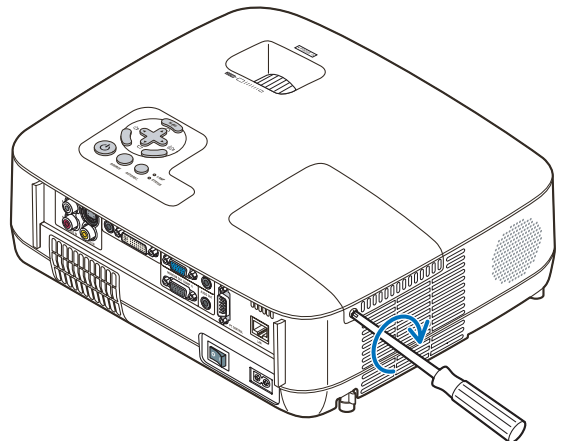
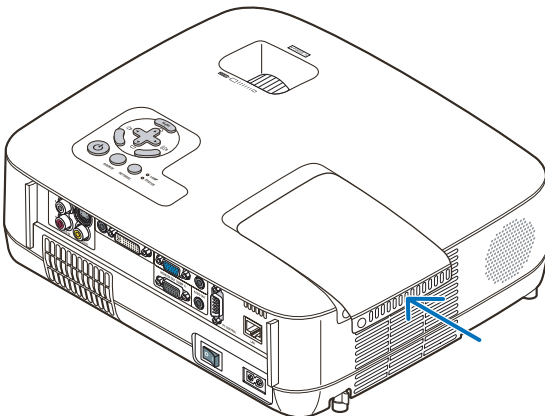

5. Connect the supplied power cable, turn on the Main Power switch and turn on the projector.

6. Finally, select the menu → [RESET] → [CLEAR LAMP HOURS] to reset the lamp usage hours.

NOTE: When you continue to use the projector for another 100 hours after the lamp has reached the end of its life, the projector cannot turn on and the menu is not displayed.

If this happens, press the HELP button on the remote control for 10 seconds to reset the lamp clock back to zero.

When the lamp time clock is reset to zero, the LAMP indicator goes out.

7. Appendix

1 Troubleshooting

This section helps you resolve problems you may encounter while setting up or using the projector.

Indicator Messages

Power Indicator

Indicator Condition			Projector Condition	Note
Off			The main power is off	—
Blinking light	Green	0.5 sec On, 0.5 sec Off	The projector is getting ready to turn on.	Wait for a moment.
		2.5 sec On, 0.5 sec Off	Off Timer is enabled.	—
Steady light	Green		The projector is turned on.	—
	Orange		[NORMAL] is selected for [STANDBY MODE]	—
	Red		[POWER-SAVING] is selected for [STANDBY MODE]	—

Status Indicator

Indicator Condition			Projector Condition	Note
Off			Normal or Standby ([POWER-SAVING] for [STANDBY MODE])	—
Blinking light	Red	1 cycle (0.5 sec On, 2.5 sec Off)	Lamp cover error or lamp housing error	Replace the lamp cover or lamp housing correctly.
		2 cycle (0.5 sec On, 0.5 sec Off)	Temperature error	The projector is overheated. Move the projector to a cooler location.
		3 cycle (0.5 sec On, 0.5 sec Off)	Power error	Power unit is not working properly. Contact your dealer.
		4 cycle (0.5 sec On, 0.5 sec Off)	Fan error	Fans will not work correctly.
		6 cycle (0.5 sec On, 0.5 sec Off)	Lamp error	Lamp fails to light. Wait a full minute and then turn on again.
		9 cycle (0.5 sec On, 0.5 sec Off)	[DYNAMIC CONTRAST] error	Dynamic Contrast function is not working properly on NP410/NP310. Contact your dealer.
	Green		Re-firing the lamp (The projector is cooling down.)	The projector is re-firing. Wait for a moment.
Steady light	Green		Standby ([NORMAL] for [STANDBY MODE])	—
	Orange		CONTROL PANEL LOCK is on.	You have pressed cabinet button when Control Panel Lock is on.
			CONTROL ID error	Remote control ID and projector ID are not matched.

Lamp Indicator

Indicator Condition		Projector Condition	Note
Off		Normal	—
Blinking light	Red	Lamp has reached its end of life. Lamp replacement message will be displayed.	Replace the lamp.
Steady light	Red	Lamp has been used beyond its limit. The projector will not turn on until the lamp is replaced.	Replace the lamp.
	Green	[ECO MODE] is set to [ON]	—

Over-Temperature Protection

If the temperature inside the projector rises too high, the over-temperature protector will automatically turn off the lamp with the STATUS indicator blinking (2-cycle On and Off.)

Should this happen, do the following:

- Unplug the power cable after the cooling fans stop.
- Move the projector to a cooler location if the room where you are presenting is particularly too warm.
- Clean the ventilation holes if they are clogged with dust.
- Wait about 60 minutes until the inside of the projector becomes cool enough.

Common Problems & Solutions (→ “Power/Status/Lamp Indicator” on page 87.)

Problem	Check These Items
Does not turn on or shut down	<ul style="list-style-type: none"> • Check that the power cable is plugged in and that the power button on the projector cabinet or the remote control is on. (→ pages 25, 26, 27) • Ensure that the lamp cover is installed correctly. (→ page 86) • Check to see if the projector has overheated. If there is insufficient ventilation around the projector or if the room where you are presenting is particularly warm, move the projector to a cooler location. • Check to see if you continue to use the projector for another 100 hours after the lamp has reached the end of its life. If so, replace the lamp. After replacing the lamp, reset the lamp hours used. (→ page 80) • The lamp may fail to light. Wait a full minute and then turn on the power again. • Set [FAN MODE] to [HIGH ALTITUDE] when using the projector at altitudes approximately 5500 feet/1600 meters or higher. Using the projector at altitudes approximately 5500 feet/1600 meters or higher without setting to [HIGH ALTITUDE] can cause the projector to overheat and the projector could shut down. If this happens, wait a couple minutes and turn on the projector. (→ page 74) If you turn on the projector immediately after the lamp is turned off, the fans run without displaying an image for some time and then the projector will display the image. Wait for a moment.
Will turn off	<ul style="list-style-type: none"> • Ensure that the [OFF TIMER] or [AUTO POWER OFF] is off. (→ page 76, 77)
No picture	<ul style="list-style-type: none"> • Use the COMPUTER1, the COMPUTER2, the VIDEO or the S-VIDEO button on the remote control to select your source (Computer, Video or S-Video). (→ page 29) If there is still no picture, press the button again. • Ensure your cables are connected properly. • Use menus to adjust the brightness and contrast. (→ page 62) • Remove the lens cap. • Reset the settings or adjustments to factory preset levels using the [RESET] in the Menu. (→ page 80) • Enter your registered keyword if the Security function is enabled. (→ page 43) • Be sure to connect the projector and notebook PC while the projector is in standby mode and before turning on the power to the notebook PC. In most cases the output signal from the notebook PC is not turned on unless connected to the projector before being powered up. * If the screen goes blank while using your remote control, it may be the result of the computer's screen-saver or power management software. • See also the next page.
Picture suddenly becomes dark	<ul style="list-style-type: none"> • Check if the projector is in the Forced ECO mode because of too high ambient temperature. If this is the case, lower the internal temperature of the projector by selecting [HIGH] for [FAN MODE]. (→ page 74)
Color tone or hue is unusual	<ul style="list-style-type: none"> • Check if an appropriate color is selected in [WALL COLOR]. If so, select an appropriate option. (→ page 69) • Adjust [HUE] in [PICTURE]. (→ page 63)
Image isn't square to the screen	<ul style="list-style-type: none"> • Reposition the projector to improve its angle to the screen. (→ page 30) • Use the Keystone correction function to correct the trapezoid distortion. (→ page 34)
Picture is blurred	<ul style="list-style-type: none"> • Adjust the focus. (→ page 33) • Reposition the projector to improve its angle to the screen. (→ page 30) • Ensure that the distance between the projector and screen is within the adjustment range of the lens. (→ page 15, 16) • Condensation may form on the lens if the projector is cold, brought into a warm place and is then turned on. Should this happen, let the projector stand until there is no condensation on the lens.
Flicker appears on screen	<ul style="list-style-type: none"> • Set [FAN MODE] to other than [HIGH ALTITUDE] mode when using the projector at altitudes approximately 5500 feet/1600 meters or lower. Using the projector at altitudes less than approximately 5500 feet/1600 meters and setting to [HIGH ALTITUDE] can cause the lamp to overcool, causing the image to flicker. Switch [FAN MODE] to [AUTO]. (→ page 74)
Image is scrolling vertically, horizontally or both	<ul style="list-style-type: none"> • Check the computer's resolution and frequency. Make sure that the resolution you are trying to display is supported by the projector. (→ page 97) • Adjust the computer image manually with the Horizontal/Vertical in the [IMAGE OPTIONS]. (→ page 65)
Remote control does not work	<ul style="list-style-type: none"> • Install new batteries. (→ page 10) • Make sure there are no obstacles between you and the projector. • Stand within 22 feet (7 m) of the projector. (→ page 10)
Indicator is lit or blinking	<ul style="list-style-type: none"> • See the POWER/STATUS/LAMP Indicator. (→ page 87)
Cross color in RGB mode	<ul style="list-style-type: none"> • Press the AUTO ADJ. button on the projector cabinet or the remote control. (→ page 37) • Adjust the computer image manually with [CLOCK]/[PHASE] in [IMAGE OPTIONS] in the menu. (→ page 64)

For more information contact your dealer.

If there is no picture, or the picture is not displayed correctly.

- Power on process for the projector and the PC.

Be sure to connect the projector and notebook PC while the projector is in standby mode and before turning on the power to the notebook PC.

In most cases the output signal from the notebook PC is not turned on unless connected to the projector before being powered up.

NOTE: You can check the horizontal frequency of the current signal in the projector's menu under Information. If it reads "0kHz", this means there is no signal being output from the computer. (→ page 79 or go to next step)

- Enabling the computer's external display.

Displaying an image on the notebook PC's screen does not necessarily mean it outputs a signal to the projector. When using a PC compatible laptop, a combination of function keys will enable/disable the external display. Usually, the combination of the "Fn" key along with one of the 12 function keys gets the external display to come on or off. For example, NEC laptops use Fn + F3, while Dell laptops use Fn + F8 key combinations to toggle through external display selections.

- Non-standard signal output from the computer

If the output signal from a notebook PC is not an industry standard, the projected image may not be displayed correctly. Should this happen, deactivate the notebook PC's LCD screen when the projector display is in use. Each notebook PC has a different way of deactivate/reactivate the local LCD screens as described in the previous step. Refer to your computer's documentation for detailed information.

- Image displayed is incorrect when using a Macintosh

When using a Macintosh with the projector, set the DIPswitch of the Mac adapter (not supplied with the projector) according to your resolution. After setting, restart your Macintosh for the changes to take affect.

For setting display modes other than those supported by your Macintosh and the projector, changing the DIP switch on a Mac adapter may bounce an image slightly or may display nothing. Should this happen, set the DIP switch to the 13" fixed mode and then restart your Macintosh. After that, restore the DIP switches to a displayable mode and then restart the Macintosh again.

NOTE: A Video Adapter cable manufactured by Apple Computer is needed for a PowerBook which does not have a mini D-Sub 15-pin connector.

- Mirroring on a PowerBook

* When using the projector with a Macintosh PowerBook, output may not be set to 1024 x 768 unless "mirroring" is off on your PowerBook. Refer to owner's manual supplied with your Macintosh computer for mirroring.

- Folders or icons are hidden on the Macintosh screen

Folders or icons may not be seen on the screen. Should this happen, select [View] → [Arrange] from the Apple menu and arrange icons.

② Specifications

This section provides technical information about projector's performance.

Model Number	NP610/NP510/NP410/NP405/NP310/NP305/NP510W/NP410W	
Optical	NP610/NP510/NP410/NP405/NP310/NP305	NP510W/NP410W
LCD Panel	NP610/NP510: 0.63 inch LCD with Micro Lens Array (Aspect Ratio 4:3) NP410/NP405/NP310/NP305: 0.63 inch LCD (Aspect Ratio 4:3)	0.59 inch LCD with Micro Lens Array (Aspect Ratio 16:10)
Resolution	1024 × 768 pixels* ¹	1280 × 800 pixels* ¹
Lens	Manual zoom and focus Zoom Ratio = 1–1.2 F1.7–2.0 f = 19.8–23.7 mm	
Lamp	NP610: 230W AC (170W in ECO Mode) NP510/NP410/NP405/NP310/NP305: 180W AC (145W ECO Mode)	230W AC (170W in ECO Mode)
Light Output* ^{2,3}	NP610: 3500 lumens (approx. 70% in ECO Mode) NP510: 3000 lumens (approx. 80% in ECO Mode) NP410/NP405: 2600 lumens (approx. 80% in ECO Mode) NP310/NP305: 2200 lumens (approx. 80% in ECO Mode)	NP510W: 3000 lumens (approx. 70% in ECO Mode) NP410W: 2600 lumens (approx. 70% in ECO Mode)
Contrast Ratio* ³ (full white: full black)	NP610/NP510/NP405/NP305: 500:1 NP410/NP310: 2000:1	NP510W: 500:1 NP410W: 450:1
Image Size (Diagonal)	21–300 inches/ 0.53 m–7.6 m	
Projection Distance	30–444 inches/0.7–11.3 m	31–470 inches/0.8–11.9 m
Projection Angle	Tele: 7.9°–8.3°/Wide: 9.5°–10.0°	Tele: 7.9°–8.3°/Wide: 9.5°–10.0°

*1 Effective pixels are more than 99.99%.

*2 This is the light output value (lumens) when the [PRESET] mode is set to [HIGH-BRIGHT]. If any other mode is selected as the [PRESET] mode, the light output value may drop slightly.

*3 Compliance with ISO21118-2005

Electrical

Inputs	1 RGB/Component (D-Sub 15 P), 1 RGB (Digital/Analog, DVI-I 29P, HDCP* ⁴ supported), 1 S-Video (DIN 4 P), 1 Video (RCA), 1 (L/R) RCA Audio, 2 Stereo Mini Audio DVI-I 29P is not available on NP405/NP305	
Outputs	1 RGB (D-Sub 15P), 1 Stereo Mini Audio	
PC Control	1 PC Control Port (D-Sub 9P)	
Wired LAN Port	RJ-45 (not available on NP405/NP305)	
External Control	RS232, IR, Wired LAN (not available on NP405/NP305)	
Color Reproduction	16.7 million colors simultaneously, Full color	
Compatible Signals* ⁵	Analog: VGA/SVGA/XGA/WXGA/WXGA+/SXGA/SXGA+/UXGA 480i/480p/576i/576p/720p/1080i Digital: VGA/SVGA/XGA/WXGA/SXGA	
Video Bandwidth	RGB: 80 MHz (Max.)	
Horizontal Resolution	540 TV lines: NTSC/NTSC4.43/PAL/PAL-M/PAL-N/PAL60 300 TV lines: SECAM	
Scan Rate	Horizontal: 15 kHz to 100 kHz (RGB: 24 kHz or over) Vertical: 50 Hz to 120 Hz	
Sync Compatibility	Separate Sync / Composite Sync / Sync on G	
Built-in Speaker	7W (monaural)	
Power Requirement	NP610/NP510/NP410/NP405/NP310/NP305: 100–240V AC, 50/60Hz NP610G/NP510G/NP410G/NP405G/NP310G/NP305G: 200–240V AC, 50/60Hz	NP510W/NP410W: 100–240V AC, 50/60Hz NP510WG/NP410WG: 200–240V AC, 50/60Hz

Input Current	NP610: 3.8–1.5A NP510/NP410/NP405/NP310/NP305: 3.2–1.4A NP610G: 1.8A NP510G/NP410G/NP310G/NP405G/NP305G: 1.5A	NP510W/NP410W: 3.8–1.5A NP510WG/NP410WG: 1.8A
Power Consumption	NP610: 312W(100-130V AC)/294W(200-240V AC) in OFF for ECO MODE/237W(100-130V AC)/228W(200-240V AC) in ON for ECO MODE NP510/NP410/NP310/NP405/NP305: 251W(100-130V AC)/239W(200-240V AC) in OFF for ECO MODE/203W(100-130V AC)/195W(200-240V AC) in ON for ECO MODE NP610/NP510/NP410/NP310: 10W in NORMAL Mode for STANDBY MODE/0.6W(100-130V AC)/0.7W(200-240V AC) in POWER-SAVING Mode for STANDBY MODE NP405/NP305: 8W in NORMAL Mode for STANDBY MODE/0.6W(100-130V AC)/0.7W(200-240V AC) in POWER-SAVING Mode for STANDBY MODE	NP510W/NP410W: 312W(100-130V AC)/294W(200-240V AC) in OFF for ECO MODE/237W(100-130V AC)/228W(200-240V AC) in ON for ECO MODE 10W in NORMAL Mode for STANDBY MODE/0.6W(100-130V AC)/0.7W(200-240V AC) in POWER-SAVING Mode for STANDBY MODE

*4 What is HDCP/HDCP technology?

HDCP is an acronym for High-bandwidth Digital Content Protection. High bandwidth Digital Content Protection (HDCP) is a system for preventing illegal copying of video data sent over a Digital Visual Interface (DVI).

If you are unable to view material via the DVI input, this does not necessarily mean the projector is not functioning properly. With the implementation of HDCP, there may be cases in which certain content is protected with HDCP and might not be displayed due to the decision/intention of the HDCP community (Digital Content Protection, LLC).

*5 An image with higher or lower resolution than the projector's native resolution (NP610/NP510/NP410/NP405/NP310/NP305: 1024 × 768 / NP510W/NP410W: 1280 × 800) will be displayed with Advanced AccuBlend.

Mechanical

Installation	Orientation: Desktop/Front, Desktop/Rear, Ceiling/Front, Ceiling/Rear	
Dimensions	12.1" (W) × 3.7" (H) × 10.3" (D) /308 mm (W) × 93.5 mm (H) × 262 mm (D) (not including protrusions)	
Weight	NP610/NP510: 6.59 lbs/2.99 kg NP410/NP310: 6.61 lbs/3.0 kg NP405/NP305: 6.59 lbs/2.97 kg	NP510W/NP410W: 6.59 lbs/2.99 kg
Environmental Considerations	Operational Temperatures : 41° to 104°F (5° to 40°C), (ECO mode selected automatically at 95°F to 104°F/35°C to 40°C) 20% to 80% humidity (non-condensing) Storage Temperatures : 14° to 122°F (-10° to 50°C), 20% to 80% humidity (non-condensing)	
Regulations	UL/C-UL Approved (UL 60950-1, CSA 60950-1) Meets DOC Canada Class B requirements Meets FCC Class B requirements Meets AS/NZS CISPR.22 Class B Meets EMC Directive (EN55022, EN55024, EN61000-3-2, EN61000-3-3) Meets Low Voltage Directive (EN60950-1, TÜV GS Approved) 	

Model Number	NP610S/NP510WS	
Optical	NP610S	NP510WS
LCD Panel	0.63 inch LCD with Micro Lens Array (Aspect Ratio 4:3)	0.59 inch LCD with Micro Lens Array (Aspect Ratio 16:10)
Resolution	1024 × 768 pixels* ¹	1280 × 800 pixels* ¹
Lens	Fixed zoom and manual focus Digital Zoom Ratio= 1.2 F2.3 f= 9.7 mm	
Lamp	230W AC (170W in ECO Mode)	
Light Output** ² * ³	2600 lumens (approx. 70% in ECO Mode)	2100 lumens (approx. 70% in ECO Mode)
Contrast Ratio* ³ (full white: full black)	600:1	
Image Size (Diagonal)	60"–110"/ 1.52 m–2.79 m	57"–104"/1.45 m–2.64 m
Projection Distance	35"–66"/ 0.9 m–1.7 m	
Projection Angle	29.1°–29.4°	

*1 Effective pixels are more than 99.99%.

*2 This is the light output value (lumens) when the [PRESET] mode is set to [HIGH-BRIGHT]. If any other mode is selected as the [PRESET] mode, the light output value may drop slightly.

*3 Compliance with ISO21118-2005

Electrical

Inputs	1 RGB/Component (D-Sub 15 P), 1 RGB (Digital/Analog, DVI-I 29 P, HDCP* ⁴ supported), 1 S-Video (DIN 4 P), 1 Video (RCA), 1 (L/R) RCA Audio, 2 Stereo Mini Audio	
Outputs	1 RGB (D-Sub 15P), 1 Stereo Mini Audio	
PC Control	1 PC Control Port (D-Sub 9P)	
Wired LAN Port	RJ-45	
External Control	RS232, IR, Wired LAN	
Color Reproduction	16.7 million colors simultaneously, Full color	
Compatible Signals* ⁵	Analog: VGA/SVGA/XGA/WXGA/WXGA+/SXGA/SXGA+/UXGA 480i/480p/576i/576p/720p/1080i Digital: VGA/SVGA/XGA/WXGA/SXGA	
Video Bandwidth	RGB: 80 MHz (Max.)	
Horizontal Resolution	540 TV lines: NTSC/NTSC4.43/PAL/PAL-M/PAL-N/PAL60 300 TV lines: SECAM	
Scan Rate	Horizontal: 15 kHz to 100 kHz (RGB: 24 kHz or over) Vertical: 50 Hz to 120 Hz	
Sync Compatibility	Separate Sync / Composite Sync / Sync on G	
Built-in Speaker	7W (monaural)	
Power Requirement	NP610S: 100–240V AC, 50/60Hz NP610SG: 200–240V AC, 50/60Hz	NP510WS: 100–240V AC, 50/60Hz NP510WSG: 200–240V AC, 50/60Hz
Input Current	NP610S: 3.8–1.5A NP610SG: 1.8A	NP510WS: 3.8–1.5A NP510WSG: 1.8A
Power Consumption	312W(100-130V AC)/294W(200-240V AC) in OFF for ECO MODE/237W(100-130V AC)/228W(200-240V AC) in ON for ECO MODE/10W in NORMAL Mode for STANDBY Mode/0.6W(100-130V AC)/0.7W(200-240V AC) in POWER-SAVING Mode for STANDBY MODE	

*4 What is HDCP/HDCP technology?

HDCP is an acronym for High-bandwidth Digital Content Protection. High bandwidth Digital Content Protection (HDCP) is a system for preventing illegal copying of video data sent over a Digital Visual Interface (DVI).

If you are unable to view material via the DVI input, this does not necessarily mean the projector is not functioning properly. With the implementation of HDCP, there may be cases in which certain content is protected with HDCP and might not be displayed due to the decision/intention of the HDCP community (Digital Content Protection, LLC).

*5 An image with higher or lower resolution than the projector's native resolution (NP610S: 1024 × 768 / NP510WS: 1280 × 800) will be displayed with Advanced AccuBlend.

Mechanical

Installation Orientation	Desktop/Front, Desktop/Rear, Ceiling/Front, Ceiling/Rear
Dimensions	12.1"(W) × 5.4"(H) × 11.9"(D)/308 mm(W) × 136 mm(H) × 301 mm(D) (not including protrusions)
Weight	7.28 lbs/3.3 kg
Environmental Considerations	Operational Temperatures : 41° to 104°F (5° to 40°C), (ECO mode selected automatically at 95°F to 104°F/35°C to 40°C) 20% to 80% humidity (non-condensing) Storage Temperatures : 14° to 122°F (-10° to 50°C), 20% to 80% humidity (non-condensing)
Regulations	UL/C-UL Approved (UL 60950-1, CSA 60950-1) Meets DOC Canada Class B requirements Meets FCC Class B requirements Meets AS/NZS CISPR.22 Class B Meets EMC Directive (EN55022, EN55024, EN61000-3-2, EN61000-3-3) Meets Low Voltage Directive (EN60950-1, TÜV GS Approved) 

For additional information visit:

US : <http://www.necdisplay.com/>

Europe : <http://www.nec-display-solutions.com/>

Global : <http://www.nec-display.com/global/index.html>

For information on our optional accessories, visit our website or see our brochure.

The specifications are subject to change without notice.

3 Cabinet Dimensions

NP610/NP510/NP410/NP405/NP310/NP305/NP510W/NP410W

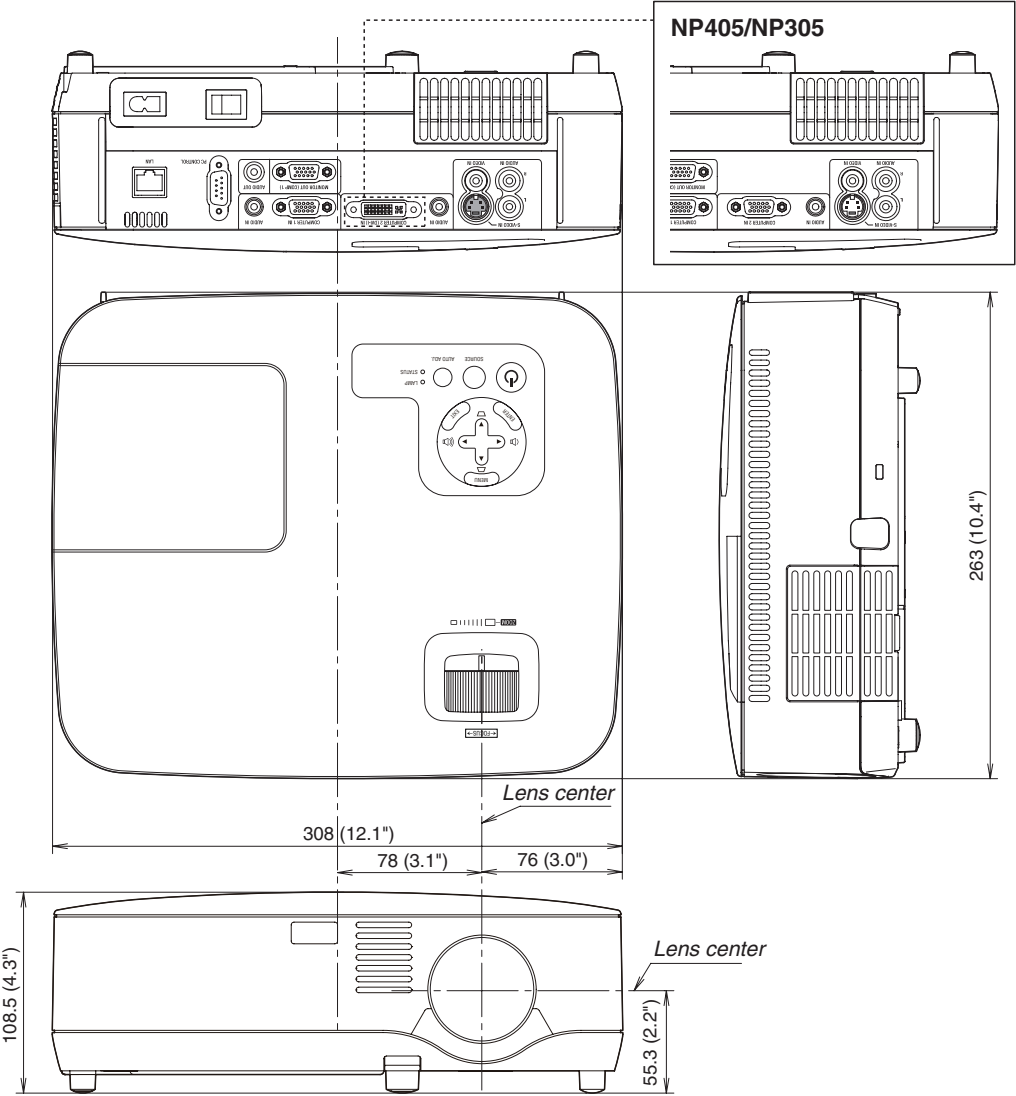

Unit: mm (inch)

NP610S/NP510WS

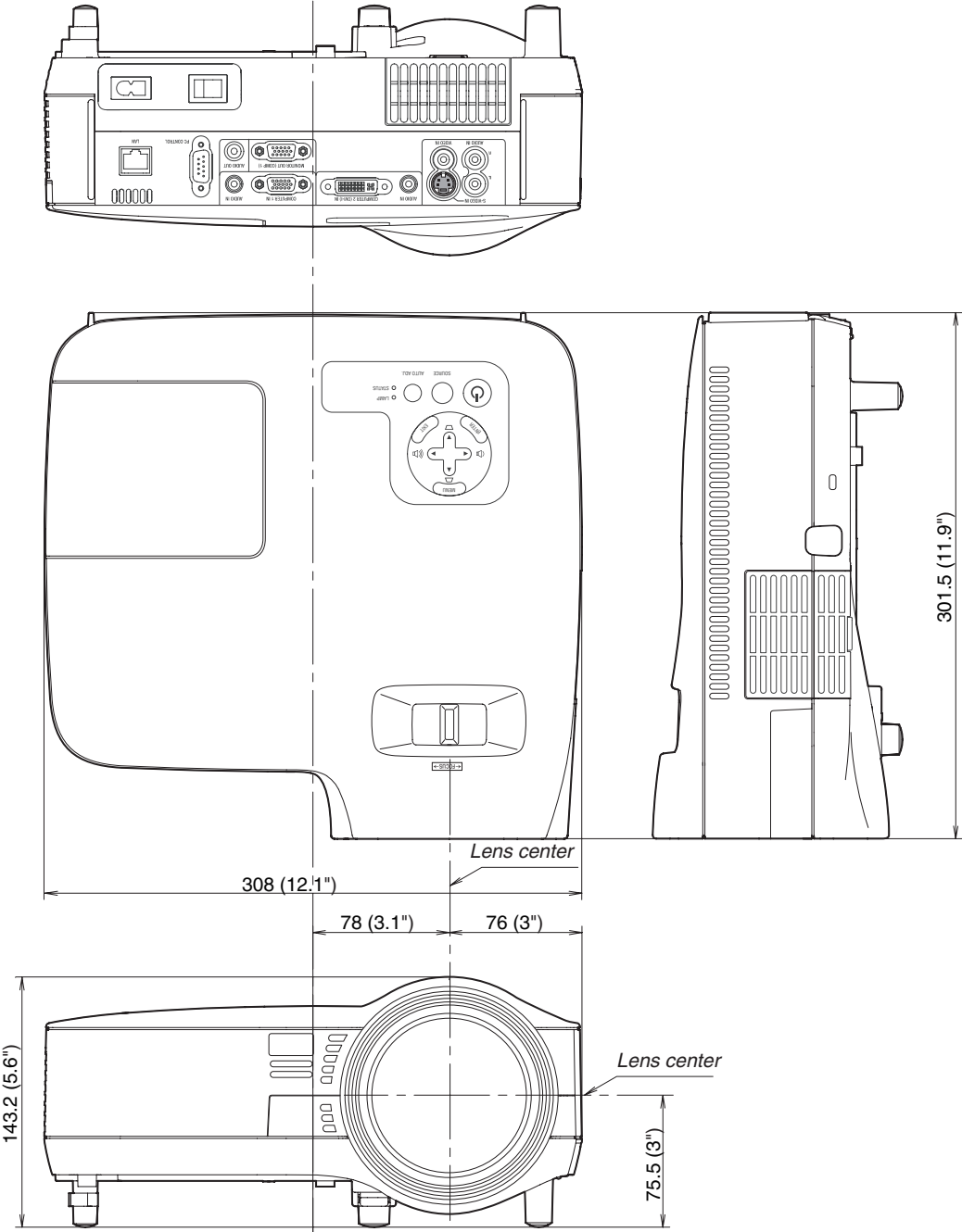

Unit: mm (inch)

④ Pin Assignments of D-Sub COMPUTER Input Connector

Mini D-Sub 15 Pin Connector

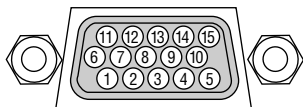

Signal Level

Video signal : 0.7Vp-p (Analog)

Sync signal : TTL level

Pin No.	RGB Signal (Analog)	YCbCr Signal
1	Red	Cr
2	Green or Sync on Green	Y
3	Blue	Cb
4	Ground	
5	Ground	
6	Red Ground	Cr Ground
7	Green Ground	Y Ground
8	Blue Ground	Cb Ground
9	No Connection	
10	Sync Signal Ground	
11	No Connection	
12	Bi-directional DATA (SDA)	
13	Horizontal Sync or Composite Sync	
14	Vertical Sync	
15	Data Clock	

NOTE: Pin Nos. 12 and 15 are required for DDC/CI.

5 Compatible Input Signal List

Horizontal: 15KHz to 100KHz (RGB: 24KHz or over)

Vertical: 50Hz to 120Hz

Signal		Resolution (Dots)		Frequency H. (kHz)	Refresh Rate (Hz)
VIDEO	NTSC	-	*	15.7	59.9
	PAL	-	*	15.6	50.0
	PAL60	-	*	15.7	60.0
	SECAM	-	*	15.6	50.0
IBM		640 × 480		31.5	59.9
		640 × 480		31.5	60.0
		640 × 480		37.9	72.8
		640 × 480		37.5	75.0
		640 × 480		39.4	75.0
		640 × 480		43.3	85.0
		800 × 600		35.2	56.3
		800 × 600		37.9	60.3
		800 × 600		48.1	72.2
		800 × 600		46.9	75.0
		800 × 600		53.7	85.1
		1024 × 768		48.4	60.0
		1024 × 768		56.5	70.1
		1024 × 768		60.0	75.0
		1024 × 768		68.7	85.0
		1152 × 864		54.4	60.1
		1152 × 864		64.0	70.0
		1152 × 864		67.5	75.0
		1152 × 864 *		77.5	85.1
		1280 × 768		47.8	59.9
		1280 × 800		49.7	59.8
		1280 × 960		60.0	60.0
		1280 × 960 *		75.0	75.0
		1280 × 960 *		85.9	85.0
		1280 × 1024		64.0	60.0
		1280 × 1024 *		80.0	75.0
		1280 × 1024 *		91.2	85.0
		1400 × 1050		64.7	60.0
		1400 × 1050 *		65.3	60.0
		1440 × 900 *		55.9	59.9
	1600 × 1200 *		75.0	60.0	
	1600 × 1200 *		81.3	65.0	
	1600 × 1200 *		87.5	70.0	
	1600 × 1200 *		93.8	75.0	
Apple Macintosh®		640 × 480		35.0	66.7
		832 × 624		49.7	74.6
		1024 × 768		60.2	74.9
		1152 × 870		68.7	75.1
		1280 × 1024		64.3	60.4
		1280 × 1024 *		69.9	65.2
		1280 × 1024 *		78.4	73.7
HDTV	(1080i/60)	1920 × 1080		33.8	60.0
	(1080i/50)	1920 × 1080		28.1	50.0
		1280 × 720		45.0	60.0
SDTV	480p	720 × 480		31.5	59.9
DVD	YCbCr	720 × 480		15.7	59.9
		720 × 576		15.6	50.0
	Progressive	720 × 480 *		31.5	59.9
		720 × 576		31.3	50.0

NOTE:

- Images above flagged with “*” are not supported by digital signal.
- An image with higher or lower resolution than the projector's native resolution (NP610/NP510/NP410/NP405/NP310/NP305/ NP610S: 1024 x 768 / NP510W/NP410W/NP510WS: 1280 x 800) will be displayed with Advanced AccuBlend.
- Some composite sync signals may not be displayed correctly.
Signals other than those specified in the table above may not be displayed correctly. If this should happen, change the refresh rate or resolution on your PC. Refer to Display Properties help section of your PC for procedures.

⑥ PC Control Codes and Cable Connection

PC Control Codes

Function	Code Data					
POWER ON	02H	00H	00H	00H	00H	02H
POWER OFF	02H	01H	00H	00H	00H	03H
INPUT SELECT COMPUTER 1	02H	03H	00H	00H	02H	01H 01H 09H
INPUT SELECT COMPUTER 2 (Digital)	02H	03H	00H	00H	02H	01H 1AH 22H
INPUT SELECT COMPUTER 2 (Analog)	02H	03H	00H	00H	02H	01H 02H 0AH
INPUT SELECT VIDEO	02H	03H	00H	00H	02H	01H 06H 0EH
INPUT SELECT S-VIDEO	02H	03H	00H	00H	02H	01H 0BH 13H
PICTURE MUTE ON	02H	10H	00H	00H	00H	12H
PICTURE MUTE OFF	02H	11H	00H	00H	00H	13H
SOUND MUTE ON	02H	12H	00H	00H	00H	14H
SOUND MUTE OFF	02H	13H	00H	00H	00H	15H

NOTE: Contact your local dealer for a full list of the PC Control Codes if needed.

Cable Connection

Communication Protocol

Baud rate19200 bps
 Data length8 bits
 ParityNo parity
 Stop bitOne bit
 X on/offNone
 Communications procedureFull duplex

NOTE: Depending on the equipment, a lower baud rate may be recommended for long cable runs.

PC Control Connector (D-SUB 9P)

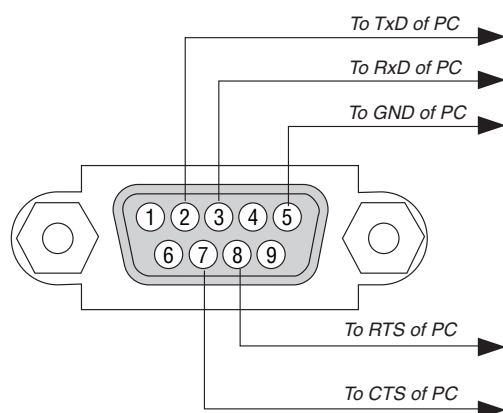

NOTE 1: Pins 1, 4, 6 and 9 are no used.

NOTE 2: Jumper "Request to Send" and "Clear to Send" together on both ends of the cable to simplify cable connection.

NOTE 3: For long cable runs it is recommended to set communication speed within projector menus to 9600 bps.

7 Troubleshooting Check List

Before contacting your dealer or service personnel, check the following list to be sure repairs are needed also by referring to the "Troubleshooting" section in your user's manual. This checklist below will help us solve your problem more efficiently.

* Print this page and the next page for your check.

Frequency of occurrence always sometimes (How often? _____) other (_____)

Power

- No power (POWER indicator does not light green) See also "Status Indicator (STATUS)".
 - Power cable's plug is fully inserted into the wall outlet.
 - Main power switch is pressed to the ON position.
 - Lamp cover is installed correctly .
 - Lamp Hours Used (lamp operation hours) was cleared after lamp replacement.
 - No power even though you press and hold the POWER button for 1 second.
- Shut down during operation.
 - Power cable's plug is fully inserted into the wall outlet.
 - Lamp cover is installed correctly .
 - [AUTO POWER OFF] is turned off (only models with the [AUTO POWER OFF] function).
 - [OFF TIMER] is turned off (only models with the [OFF TIMER] function).

Video and Audio

- No image is displayed from your PC or video equipment to the projector.
 - Still no image even though you connect the projector to the PC first, then start the PC.
 - Enabling your notebook PC's signal output to the projector.
 - *A combination of function keys will enable/disable the external display. Usually, the combination of the "Fn" key along with one of the 12 function keys turns the external display on or off.*
 - No image (blue or black background, no display).
 - Still no image even though you press the AUTO ADJUST button.
 - Still no image even though you carry out [RESET] in the projector's menu.
 - Signal cable's plug is fully inserted into the input connector
 - A message appears on the screen.
(_____)
 - The source connected to the projector is active and available.
 - Still no image even though you adjust the brightness and/or the contrast.
 - Input source's resolution and frequency are supported by the projector.
- Image is too dark.
 - Remains unchanged even though you adjust the brightness and/or the contrast.
- Image is distorted.
 - Image appears to be trapezoidal (unchanged even though you carry out the [KEYSTONE] adjustment).
- Parts of the image are lost.
 - Still unchanged even though you press the AUTO ADJUST button.
 - Still unchanged even though you carry out [RESET] in the projector's menu.
- Image is shifted in the vertical or horizontal direction.
 - Horizontal and vertical positions are correctly adjusted on a computer signal.
 - Input source's resolution and frequency are supported by the projector.
 - Some pixels are lost.
- Image is flickering.
 - Still unchanged even though you press the AUTO ADJUST button.
 - Still unchanged even though you carry out [RESET] in the projector's menu.
 - Image shows flickering or color drift on a computer signal.
 - Still unchanged even though you change [FAN MODE] from [HIGH ALTITUDE] to [AUTO].
- Image appears blurry or out of focus.
 - Still unchanged even though you checked the signal's resolution on PC and changed it to projector's native resolution.
 - Still unchanged even though you adjusted the focus.
- No sound.
 - Audio cable is correctly connected to the audio input of the projector.
 - Still unchanged even though you adjusted the volume level.
 - AUDIO OUT is connected to your audio equipment (only models with the AUDIO OUT connector).

Other

- Remote control does not work.
 - No obstacles between the sensor of the projector and the remote control.
 - Projector is placed near a fluorescent light that can disturb the infrared remote controls.
 - Batteries are new and are not reversed in installation.
- Buttons on the projector cabinet do not work (only models with the [CONTROL PANEL LOCK] function)
 - [CONTROL PANEL LOCK] is not turned on or is disabled in the menu.
 - Still unchanged even though you press and hold the EXIT button for a minimum of 10 seconds.

In the space below please describe your problem in detail.

Information on application and environment where your projector is used

Projector

Model number:

Serial No.:

Date of purchase:

Lamp operating time (hours):

Eco Mode: Off On

Information on input signal:

Horizontal synch frequency [] kHz

Vertical synch frequency [] Hz

Synch polarity H (+) (-)

V (+) (-)

Synch type Separate Composite

Sync on Green

STATUS Indicator:

Steady light Orange Green

Flashing light [] cycles

Remote control model number:

Installation environment

Screen size: inch

Screen type: White matte Beads Polarization
 Wide angle High contrast

Throw distance: feet/inch/m

Orientation: Ceiling mount Desktop

Power outlet connection:

Connected directly to wall outlet

Connected to power cord extender or other (the number of connected equipment _____)

Connected to a power cord reel or other (the number of connected equipment _____)

Computer

Manufacturer:

Model number:

Notebook PC / Desktop

Native resolution:

Refresh rate:

Video adapter:

Other:

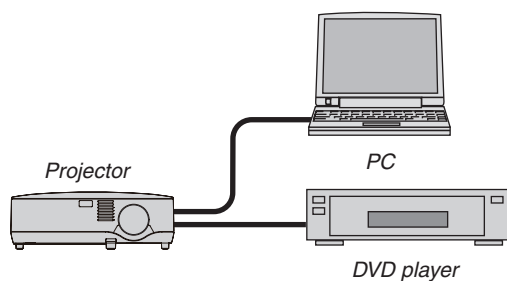

Signal cable

NEC standard or other manufacturer's cable?

Model number: Length: inch/m

Distribution amplifier

Model number:

Switcher

Model number:

Adapter

Model number:

Video equipment

VCR, DVD player, Video camera, Video game or other

Manufacturer:

Model number:

8 TravelCare Guide

TravelCare - a service for international travelers

This product is eligible for "TravelCare", NEC's unique international warranty.

Please note that TravelCare coverage differs in part from coverage under the warranty included with the product.

Services offered with TravelCare

This warranty allows customers to receive service on their product at the NEC and NEC-designated service stations in the countries listed herein when temporarily traveling internationally for business or pleasure. For details on services offered by the different service stations, please refer to the "List of TravelCare Outlets" below.

1 Repair services

The product will be repaired and delivered within 10 business days, not including shipping time.

During the term of warranty, the cost of maintenance parts, labor costs for repairs and shipping costs within the service station's coverage area are covered by the warranty.

2 Replacement product rental service

If the customer desires, he or she can rent a replacement product while the original product is being repaired.

Fee: US\$200 for 12 days

This fee must be paid at the local service station in cash or credit card.

The US\$200 rental fee is non-refundable even if the customer rents it less than 12 days before returning.

The replacement product will be delivered within 3 business days.

If the customer did not return the replacement product within 12 days, the customer will be charged the price of the unit.

If the customer returned the replacement product in a faulty or damaged condition, the repair cost will be charged to the customer.

Note that this service is not offered in all countries and regions. Please refer to the "List of TravelCare Outlets".

In addition, this replacement product rental service is not offered after the product's warranty has expired.

Term of warranty

1

- a. Upon presentation of the warranty or receipt received upon purchase:

Valid for the term indicated on the warranty or the normal term of warranty for the country of purchase.

- b. When only the product is brought in:

Valid for a period of within 14 months of the date of manufacture indicated by the serial number attached to the product.

- 2 When a product whose term of warranty is expired is brought in:

Repairs will be offered for a fee. In this case the customer is not eligible for the replacement product rental service.

- 3 In the following cases, repairs may be charged, even if the product's warranty is still in effect:

- 1) If the term of warranty, model name, serial number and name of the store of purchase are not indicated on the warranty or have been altered.
- 2) Problems or damage caused by dropping or shocks during shipment or movement by the customer or by improper handling by the customers.
- 3) Problems or damage caused by improper usage or unwarrantable alterations or repairs by the customer.
- 4) Problems or damage caused by fire, salt damage, gas damage, earthquakes, lightning damage, storm or flood damage or other natural disasters or such external factors as dust, cigarette smoke, abnormal voltage, etc.
- 5) Problems or damage caused by use in hot or humid places, in vehicles, boats or ships, etc.

- 6) Problems or damage caused by expendable supplies or devices connected to the product other than those designated by NEC.
- 7) Problems caused by natural consumption, wear or deterioration of parts under normal usage conditions.
- 8) Problems or damage to lamps and other expendable supplies, included parts or optional parts.
- 9) Other conditions stipulated in the warranty included with the product also apply.

NOTE: The product can be used overseas with voltages indicated in the rating label on the product by using a power cable suited for the standards and power source voltage of the country in which the product is being used.

List of TravelCare Outlets

This list applies as of July 1, 2009.

For the most up-to-date information, please refer to the websites of the service stations in the various countries on the List of TravelCare Outlets or to the NEC website at <http://www.nec-display.com/global/index.html>

In Europe

NEC Europe Ltd. / European Technical Centre

Address: Unit G, Stafford Park 12, Telford TF3 3BJ, U.K.

Telephone: +44 1952 237000

Fax Line: +44 1952 237006

Email Address: AFR@uk.neceur.com

WEB Address: <http://www.neceur.com>

(Regions Covered)

EU: Austria*, Belgium*, Bulgaria*, Czech Republic*, Cyprus*, Denmark*, Estonia*, Finland*, France*, Germany*, Greece*, Hungary*, Ireland*, Italy*, Latvia*, Lithuania*, Luxembourg*, Malta*, The Netherlands*, Poland*, Portugal*, Romania*, Slovakia*, Slovenia*, Spain*, Sweden* and the United Kingdom*

EEA: Norway*, Iceland and Liechtenstein

In North America

NEC Display Solutions of America, Inc.

Address: 500 Park Boulevard, Suite 1100 Itasca, Illinois 60143, U.S.A.

Telephone: +1 800 836 0655

Fax Line: +1 800 356 2415

Email Address: vsd.tech-support@necdisplay.com

WEB Address: <http://www.necdisplay.com/>

(Regions Covered)

U.S.A. *, Canada*

In Oceania

AWA Limited.

Address: 151 Arthur Street
Homebush West NSW 2140 Australia

Customer Call Centre

Telephone: 0297647777

Fax Line: 1300772688

Email Address: commercialsupport@awa.com.au

For Travel Care service, while customer is in Australia, the customer will contact AWA on 1300366144, select Option 4. If you want to book warranty service by email customer goes to: commercialsupport@awa.com.au.

(Regions Covered)

Australia

Visual Group Ltd.

Address: 28 Walls Road Penrose Auckland New Zealand

Telephone: 095250740

Fax Line: 095809607

Email Address: sarah.reed@visualgroup.co.nz

(Regions Covered)

New Zealand

In Asia and Middle East**NEC Display Solutions, Ltd.**

Address: 686-1, Nishioji, Oi-Machi, Ashigarakami-Gun,
Kanagawa 258-0017, Japan
Telephone: +81 465 85 2369
Fax Line: +81 465 85 2393
Email Address: support_pjweb@gw.necds.nec.co.jp
WEB Address: <http://www.nec-pj.com>

(Regions Covered)
Japan*

NEC Solutions (China) Co.,Ltd.

Address: Rm 1903, Shining Building, 35 Xueyuan Rd,
Haidian District Beijing 100083, P.R.C.
Telephone: +8610 82317788
Fax Line: +8610 82331722
Email Address: Lily@necsl.com.cn
Johnson_liu@necsl.com.cn
WEB Address: <http://www.necsl.com.cn>

(Regions Covered)
China

NEC Hong Kong Ltd.

Address: 25/F., The Metropolis Tower, 10 Metropolis Drive,
Hung Hom, Kowloon, Hong Kong
Telephone: +852 2369 0335
Fax Line: +852 2795 6618
Email Address: nechksc@nechk.nec.com.hk
esmond_au@nechk.nec.com.hk
WEB Address: <http://www.nec.com.hk>

(Regions Covered)
Hong Kong

NEC Taiwan Ltd.

Address: 7F, No.167, SEC.2, Nan King East Road, Taipei,
Taiwan, R.O.C.
Telephone: +886 2 8500 1700
Fax Line: +886 2 8500 1420
Email Address: eric@nec.com.tw
WEB Address: <http://www.nec.com.tw>

(Regions Covered)
Taiwan

NEC Asia Pte.Ltd.

Address: 401 Commonwealth Drive, #07-02, Haw Par
Technocentre, Singapore 149598
Telephone: +65 6 273 8333
Fax Line: +65 6 274 2226
Email Address: ncare@nec.com.sg
WEB Address: <http://www.nec.com.sg/home.php>

(Regions Covered)
Singapore

NEC Corporation of Malaysia Sdn. Bhd.

Address: 33rd Floor, Menara TA One, 22, Jalan P. Ramlee,
50250 Kuala Lumpur, Malaysia
Telephone: +6 03 2178 3600 (ISDN)
Fax Line: +6 03 2178 3789
Email Address: ncare@nsm.nec.co.jp
WEB Address: <http://www.necarecenter.com>

(Regions Covered)
Malaysia

Hyosung ITX Co., Ltd.

Address: 1st Fl., Ire B/D. #2, 4Ga, Yangpyeng-Dong,
Youngdeungpo-Gu, Seoul, Korea 150-967
Telephone: +82 2 2163 4193
Fax Line: +82 2 2163 4196
Email Address: moneybear@hyosung.com

(Regions Covered)
South Korea

Lenso Communication Co., Ltd.

Address: 292 Lenso House 4, 1st Floor, Srinakarin Road,
Huamark, Bangkok, Bangkok 10240, Thailand
Telephone: +66 2 375 2425
Fax Line: +66 2 375 2434
Email Address: pattara@lenso.com
WEB Address: <http://www.lenso.com/>

(Regions Covered)
Thailand

ABBA Electronics L.L.C.

Address: Tariq Bin Ziyad Road, P.O.Box 327, Dubai, United
Arab Emirates
Telephone: +971 4 371800
Fax Line: +971 4 364283
Email Address: ABBA@emirates.net.ae

(Regions Covered)
United Arab Emirates

Samir Photographic Supplies

Address: P.O.Box 599, Jeddah 21421, Saudi Arabia
Telephone: +966 2 6828219
Fax Line: +966 2 6830820
Email Address: asif@samir-photo.com

Riyadh

Address: P.O.Box 5519, Riyadh 11432, Saudi Arabia
Telephone: +966 1 4645064
Fax Line: +966 1 4657912
Email Address: bhimji@samir-photo.com

Alkhobar

Address: P.O.Box 238, Alkhobar 31952, Saudi Arabia
Telephone: +966 3 8942674
Fax Line: +966 3 8948162
Email Address: chamseidin@samir-photo.com

(Regions Covered)
Saudi Arabia

NOTE: In countries designated with an asterisk(), replacement product rental service are offered.*

Date: / / ,

P-1/ ,

TO: NEC or NEC's Authorized Service Station:

FM:

(Company & Name with signature)

Dear Sir (s),

I would like to apply your TravelCare Service Program based on attached registration and qualification sheet and agree with your following conditions, and also the Service fee will be charged to my credit card account, if I don't return the Loan units within the specified period. I also confirm following information is correct. Regards.

Application Sheet for TravelCare Service Program

Country, product purchased :	
User's Company Name :	
User's Company Address : Phone No., Fax No. :	
User's Name :	
User's Address :	
Phone No., Fax No. :	
Local Contact office :	
Local Contact office Address :	
Phone No., Fax No. :	
User's Model Name :	
Date of Purchase :	
Serial No. on cabinet :	
Problem of units per User :	
Required Service :	(1) Repair and Return (2) Loan unit
Requested period of Loan unit :	
Payment method :	(1) Credit Card (2) Travelers Cheque (3) Cash
In Case of Credit Card : Card No. w/Valid Date :	

Condition of your TravelCare Service Program

Enduser is requested to understand following condition of TravelCare Service Program and complete the necessary information on the application sheet.

1. Service Options:

There are 3 types of [Service] available. Enduser has to understand following condition and is required to fill in the Application Sheet.

1) Repair and Return:

The 'Faulty unit' is sent or collected from the customer. It is repaired and returned within 10 days to the customer, excluding transport time.

There may have a case, repair and return can't be done by NEC Authorized Service Station, because of shortage of spare parts due to same model is not sold in the territory.

2) Repair and Return with Loan: (This service is limited to some Service Stations)

This service is offered to the Enduser, who cannot wait until their unit is repaired.

The customer can borrow a unit for US\$200 up to 12 days. Customer then sends in inoperable unit to nearest NEC Authorized Service Station for service. In order to prevent collection problem, Enduser is required to fill in Application Sheet.

Enduser needs to confirm the availability of the Service to NEC Authorized Service Stations.

3) Loan Only:

For this service, NEC Authorized Service Station supplies the customer with a loan unit for US\$200 up to 12 days. Customer keeps the inoperable unit and when customer returns home, customer arranges to have the projector serviced in the home country.

2. Warranty Exclusions:

This program does not apply if the Projector's serial number has been defaced, modified or removed.

If, in the judgement of NEC Authorized Service Station or its agent the defects or failures result from any cause other than fair wear and tear or NEC neglect, or fault including the following without limitation:

- 1) Accidents, transportation, neglect, misuse, abuse, water, dust, smoke or default of or by the Customer its employees or agents or any third party;
- 2) Failure or fluctuation of electrical power, electrical circuitry, air conditioning, humidity control or other environmental conditions such as use it in smoking area;
- 3) Any fault in the attachments or associated products or components (whether or not supplied by NEC or its agents which do not form part of the Product covered by this warranty);
- 4) Any act of God, fire, flood, war, act of violence or any similar occurrence;
- 5) Any attempt by any person other than any person authorized by NEC to adjust, modify, repair, install or service the product.
- 6) Any Cross-border charges such as, duty, insurance, tax etc.

3. Charges for Warranty Exclusions and Out of Warranty Case:

In case faulty unit is under warranty exclusions case or under Out of Warranty period, NEC Authorized Service Station will Inform estimation of actual service cost to the Enduser with reason.

4. Dead on Arrival (DOA):

Enduser must take this issue up with their original supplier in the country of purchase.

NEC Authorized Service Station will repair the DOA unit as a Warranty repair, but will not exchange DOA unit with new units.

5. Loan Service Charges and Conditions:

Upon acceptance of this NEC Projector, Customer agrees to assume liability for this loan unit.

The current cost of use of this loan unit is US\$200 for 12 calendar days.

If Customer does not return the unit within the 12 calendar days, Customer will be charged the next highest cost up to and including the full list price to Credit Cards, which price will be informed by NEC Authorized Service Stations. Please see the attached listing of contacts for each country to arrange for pickup of the loan unit.

If you return to their country of origin with the loan unit, you will be charged additional freight to return the unit to the loaning country.

Thank you for your understanding of this program.

NEC