



# MITSUBISHI ELECTRIC

## MULTIMEDIA DATA/VIDEO PROJECTORS

### Specifications

Model		HC6800	
Projection system		Transmissive liquid crystal system	
Panel specs	Panel size	0.74type x3, Aspect ratio 16:9, D7 (with Micro Lens)	
	Number of pixels	1920x1080 (2,073,600 pixels)	
	Drive system	3 primary color liquid crystal shutter system	
Optical specs	Array	Stripe pattern	
	Zoom / focus operation	Zoom ratio 1.6:1 (powered)	
	Throw ratio	1.42 - 2.26	
	Projection lens	f=23.5mm - 37.6mm	
	Off axis	(V) 5: -1 - 5: 1 (+/-75%), (H) Screen Width +/-5% (with Variable H+V Powered Lens Shift)	
	Light source lamp	170W - Standard Mode (2000hrs estimated lamp life) 136W - Low Mode (4000hrs estimated lamp life)	
Optical system		Mirror color separation / prism synthesis system	
Iris		Auto-iris	
Projection screen size		50"-300"	
Images	Brightness	1500lm (Max), 1300lm (typical)	
	Contrast ratio	30,000:1 (w/ auto-iris operation) typ.	
	Resolution	PC input VGA 640x480 — SXGA 1280x1024, UXGA 1600x1200 Compressed	
	Scan frequency	Horizontal (kHz) 15-100kHz Vertical (Hz) 50-120Hz	
Input signal system		Video NTSC, NTSC4.43, PAL (including PAL-M and N), SECAM, PAL-60 Video input: 480i/p, 576i/p, 1080i 60/50, 1080p 60/50/24, 720p 60/50	
Input	PC		PC/AT compatibles, Mac
	Video	PC input	Mini D-Sub 15 pin 1 terminal
		HDMI input	HDMI terminal 2 terminals (v1.3 with Deep Color)
	Composites	Composites	RCA terminal 1 terminal
		S	S-Video terminal 1 terminal
		Components	RCA terminal 1 terminal (component can be also input to Mini D-Sub 15 pin)
Serial / RS-232C standard		1 terminal (D-Sub 9 pin)	
Output		Trigger terminal 1 terminal (Stereo mini jack (ø3.5mm))	
Functions	Digital keystone		Vertical ±15steps
	Fan noise		20dBA (at low mode)
	Power source voltage		AC100V 50/60Hz
	Power consumption		250W (at standby 7W)
	Weight		16.5lbs
Main unit dimensions		WxDxH 427x440x159mm / 16.8"x17.3"x6.3" (excluding height adjustment)	
Other	Supplied accessories		Power source cord (2.9m), Remote control, AA batteries (x2), RGB signal cable, RS-232C cable, Lens cap, Lamp replacement tray
	Optional accessories		Ceiling Mount (XL7000CM), Ceiling Mount Accessory (PROJ-FCA), Replacement Lamp (VLT-HC6800LP)
	Warranty		2-years parts and labor, 1-year or 500 hours on lamp (whichever comes first)

\*All brand and product names are trademarks or registered trademarks of their respective companies.

### Projection distance

Screen size (16:9)				Projection distance		Up-down lens shift		Right-Left lens shift	
Diagonal	W (width)	H (height)	Max Zoom	Min Zoom	Down	Up	Left	Right	
50	127	43.7	24.4	59	98	19 ← 0 → 19	2.4 ← 0 → 2.4		
60	152	52.4	29.5	71	118	22 ← 0 → 22	2.8 ← 0 → 2.8		
70	178	61.0	34.3	87	138	26 ← 0 → 26	3.1 ← 0 → 3.1		
80	203	69.7	39.4	98	158	30 ← 0 → 30	3.5 ← 0 → 3.5		
90	229	78.3	44.1	110	177	33 ← 0 → 33	3.9 ← 0 → 3.9		
100	254	87.0	49.2	122	197	37 ← 0 → 37	4.3 ← 0 → 4.3		
110	279	96.1	53.9	134	217	41 ← 0 → 41	4.7 ← 0 → 4.7		
120	305	104.7	58.7	150	236	44 ← 0 → 44	5.1 ← 0 → 5.1		
130	330	113.4	63.8	161	256	48 ← 0 → 48	5.5 ← 0 → 5.5		
140	356	122.0	68.5	173	276	52 ← 0 → 52	5.9 ← 0 → 5.9		
150	381	130.7	73.6	185	299	55 ← 0 → 55	6.7 ← 0 → 6.7		
200	508	174.4	98.0	248	398	74 ← 0 → 74	8.7 ← 0 → 8.7		
250	635	217.7	122.4	311	496	92 ← 0 → 92	11 ← 0 → 11		
300	762	261.4	147.2	374	598	110 ← 0 → 110	13 ← 0 → 13		

Screen size (4:3)			Projection image size (16:9)			Projection distance		Up-down lens shift		Right-Left lens shift		
Diagonal	W (width)	H (height)	Diagonal	W (width)	H (height)	Black zone	Max Zoom	Min Zoom	Down	Up	Left	Right
50	127	40.2	29.9	46.1	40.2	22.4	3.9	55	91	16.9 ← 0 → 16.9	1.9 ← 0 → 1.9	
60	152	48.0	35.8	55.1	48.0	27.2	4.3	67	106	20.0 ← 0 → 20.0	2.4 ← 0 → 2.4	
70	178	55.9	42.1	64.2	55.9	31.5	5.1	79	126	23.6 ← 0 → 23.6	2.8 ← 0 → 2.8	
80	203	64.2	48.0	73.6	64.2	35.8	5.9	91	148	27.2 ← 0 → 27.2	3.1 ← 0 → 3.1	
90	229	72.0	53.9	82.7	72.0	40.6	6.7	102	161	30.3 ← 0 → 30.3	3.5 ← 0 → 3.5	
100	254	79.9	59.8	91.7	79.9	44.9	7.5	114	181	33.9 ← 0 → 33.9	3.9 ← 0 → 3.9	
110	279	88.2	66.1	101	88.2	49.6	8.3	122	201	37.0 ← 0 → 37.0	4.3 ← 0 → 4.3	
120	305	96.1	72.0	110	96.1	53.9	9.1	134	217	40.6 ← 0 → 40.6	4.7 ← 0 → 4.7	
130	330	104	77.9	119	104	58.7	9.8	146	236	43.7 ← 0 → 43.7	5.1 ← 0 → 5.1	
140	356	112	83.9	128	112	62.9	10.6	158	256	47.2 ← 0 → 47.2	5.5 ← 0 → 5.5	
150	381	120	90.2	138	120	67.3	11.4	169	272	50.8 ← 0 → 50.8	5.9 ← 0 → 5.9	
200	508	160	120	183	160	90.2	14.9	228	366	67.3 ← 0 → 67.3	7.9 ← 0 → 7.9	
250	635	200	150	230	200	113	18.9	284	457	84.3 ← 0 → 84.3	9.8 ← 0 → 9.8	
300	762	240	180	275	240	135	22.4	343	547	101 ← 0 → 101	12 ← 0 → 12	

\*The above figures are approximate and may be slightly different from the actual measurements.

### Vertical direction

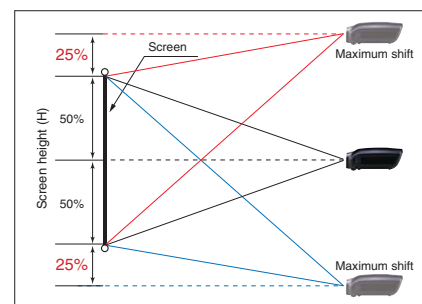

### Horizontal direction

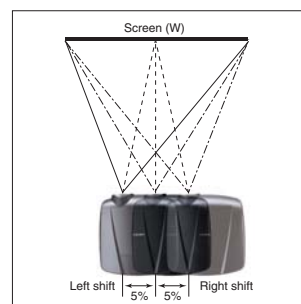

### Dimensions

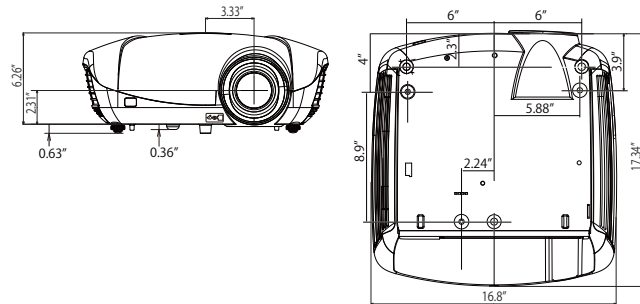

MITSUBISHI DIGITAL ELECTRONICS  
AMERICA, INC.  
Presentation Products Division  
Phone: 888.307.0349  
www.mitsubishi-presentations.com

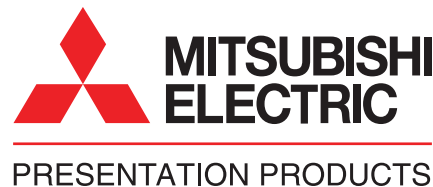

MITSUBISHI ELECTRIC SALES  
CANADA, INC.  
Display & Imaging Solutions Division  
Phone: 905.475.7728  
www.mitsubishielectric.ca

Deep blacks... Brilliant whites...  
Both at levels never believed possible



**NEW HC6800**



# Light and dark images have never been more distinctive Contrast so impressive it takes your breath away

Here is the 1080P high-definition projector you've been waiting for.

Prepare to witness beautiful, colorful imagery with well-defined blacks and bright whites.

The secret is inside Mitsubishi Electric's advanced imaging software technology—where stark blacks reside alongside brilliant whites.

Ideal for enjoying movies in vivid color, the HC6800 offers a cinema-like experience in the comfort of your own home.

Images so powerful, they will take your breath away.



京都 FULL HD 1080 3LCD NEW HC6800

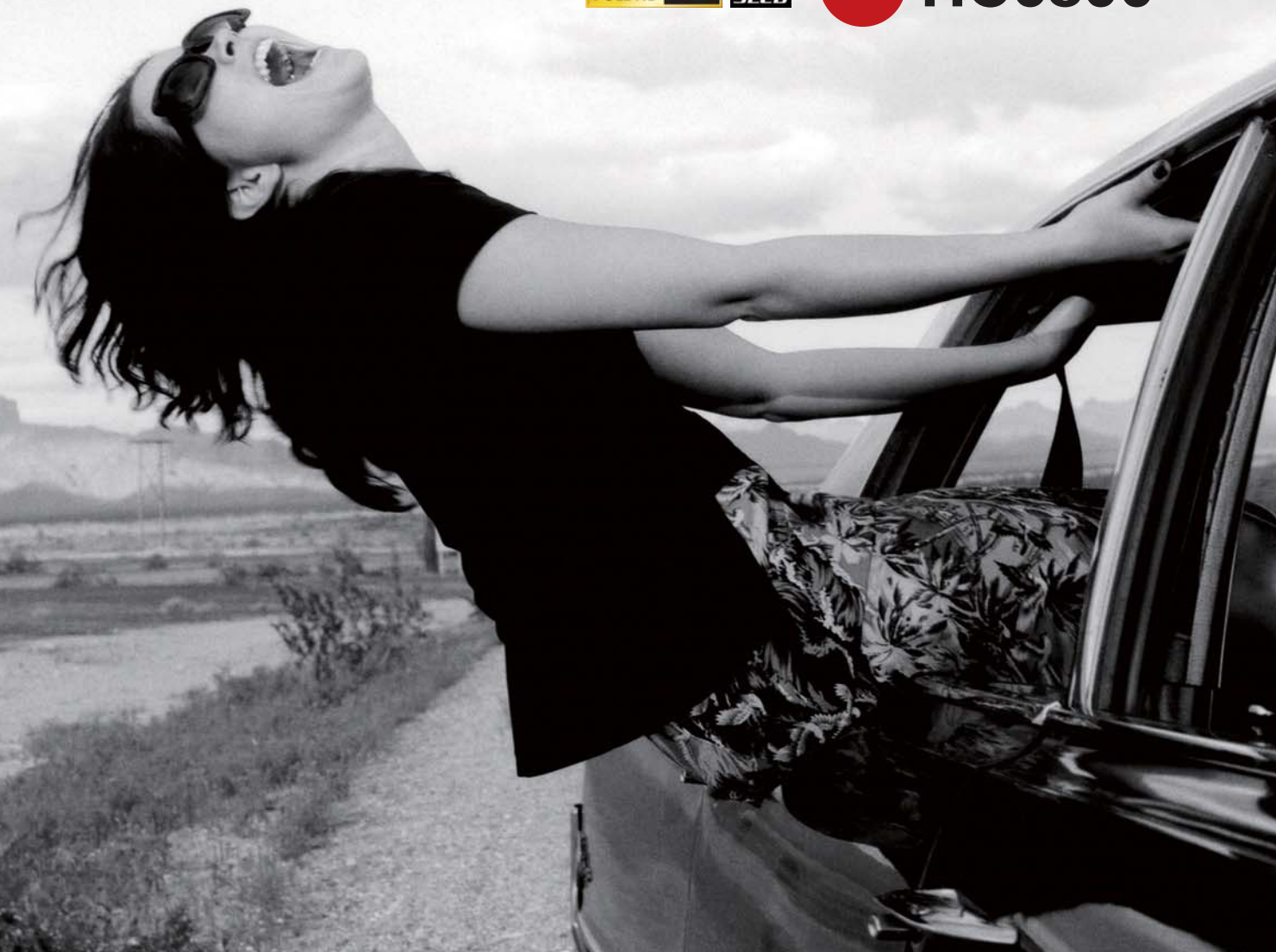

## Majestic Large-Screen Reproduction Regardless of Image Source

Clear and bright images

**A high 1500lm for clear projection even in brightly lit rooms**

The aperture ratio of the HC6800 is increased by 20% compared to conventional LCD panels, improving the light transmittance ratio. This creates clearer, more vivid images by concealing the grid between pixels. Even in the relative brightness of a living room with the curtains open—high-definition video, Blu-Ray media or other sources are enjoyed to the fullest. A dedicated dark room is no longer necessary to experience the best in home theater.

Accurate color reproduction true to the image source

**Wide-range cinema color filter for precise color reproduction**

Even when using Cinema mode (D65), an expanded color reproduction range enables color balance adjustments spanning green and cyan spectrums—so image colors are reproduced with greater depth and brightness. DVD playback has also been improved.

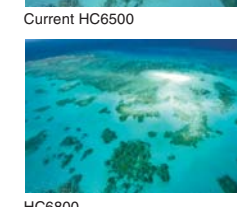
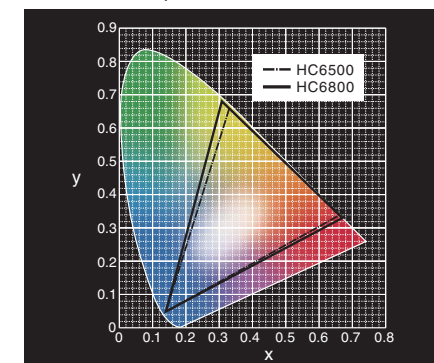

DVD playback upconversion

**"Reon-VX IC – A product of IDT, Inc. (Silicon Optix)**

Reon-VX is the ideal device for converting quality high-definition and DVD into 1,920 x 1,080 pixel images. Thanks to a 10-bit calculation at the core of the high-precision I/P conversion function—signals from every type of video source, from digital television broadcasts to pre-recorded videos, are progressively played back with high picture quality.



Enjoy movies the way they were filmed

**Supports a native 24P signal**

Our HC6800 handles an output of 48P, twice the speed of cinema film (24 frames per second), precise timing ensures true-to-life reproduction of Blu-Ray films with original smooth movement

**2-3 Pull-down**

When converting 24 frames per second into 60 frames per second, lining up the second and third frames in sequence, creates a surplus third B frame—which deteriorates smooth frame transitions.

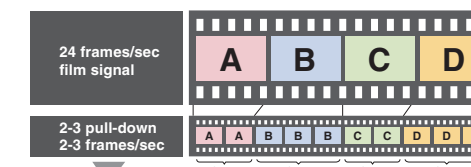

**24P direct output**

With 24P direct output, the 24 frames per second is converted to a full 48 frames per second. This allows sequential matching of two frames at a time, thereby enabling true film reproduction and its original smoothness.

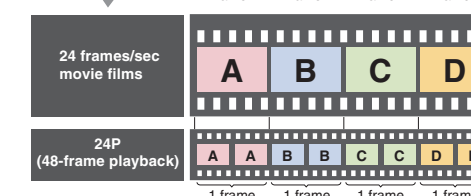

## Advanced Technology and Features for More Beautiful Images

Sharp, dynamic images

**Diamond Black Iris – A Mitsubishi Electric Original**

Our high-speed iris automatically controls the projected light quantity and analyzes brightness every 1/60 of a second. When scenes change repeatedly between light and dark, blacks are toned down using instantaneous tracking. Moreover, the HC6800 is equipped with our "Original Contrast Control" technology, allowing peak expression of white while simultaneously maintaining black gradation performance.

<p><b>Previous Auto-iris (HC5000)</b></p>	<p><b>New Auto-iris (HC6800)</b></p>
<p><b>Iris control only</b> The deep black of the night sky is reproduced, but the bright highlights are dark.</p>	<p><b>w/Original Contrast Control</b> Highlights are clearly reproduced.</p>

For the enjoyment of full high-definition

**High-performance extra-low dispersion (ED) lens**

The 17-piece, 14-cluster ED lens boasts higher performance than a standard glass lens. Resolution is increased another level to better define image properties.

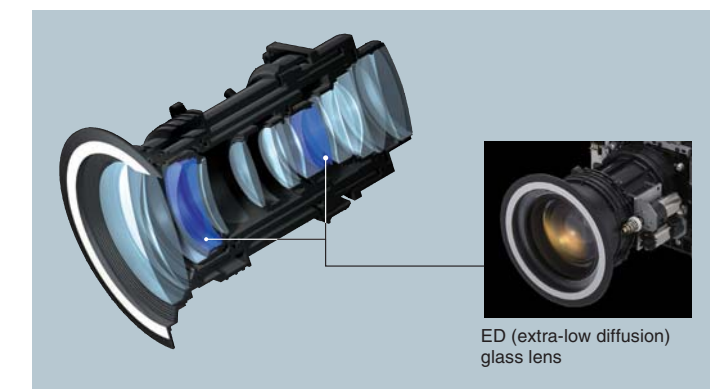

## Flexibility, innovation, and quiet performance. You're limited only by your imagination.

**Quiet sound design allows movies to be enjoyed in original sound quality**  
The cooling duct design has been modified and a large fan with small-sized motor has been installed—resulting in an extremely quiet 20dBA operation. With the noise of the cooling fan silenced, the movie sounds are clearly heard.

**Greater flexibility for room installation**  
When used with a 100" screen (16:9), the included 1.6x ultrashort-throw lens offers projection from as close as 10.1'–16.4'. Additionally, the motorized lens shift adjusts the image both horizontally and vertically, providing greater freedom and easier of projector set-up.

**"Deep Color" compatible – Increased image depth**  
Equipped with two HDMI Ver 1.3 input ports—8, 10 and 12bit native transmissions are all possible. Rich gradation and high contrast Deep Color are truly achieved.



**Appreciate the grandeur with wide anamorphic support**  
A fast-growing trend in the world of home theaters is viewing in super wide 2.35:1 aspect ratios. When equipped with an anamorphic lens (sold separately), this convenient function enables easy switching between "Normal" and "Wide" viewing modes.