

Multimedia Projector

MODEL **PLC-XU73**
PLC-XU70
PLC-SU70

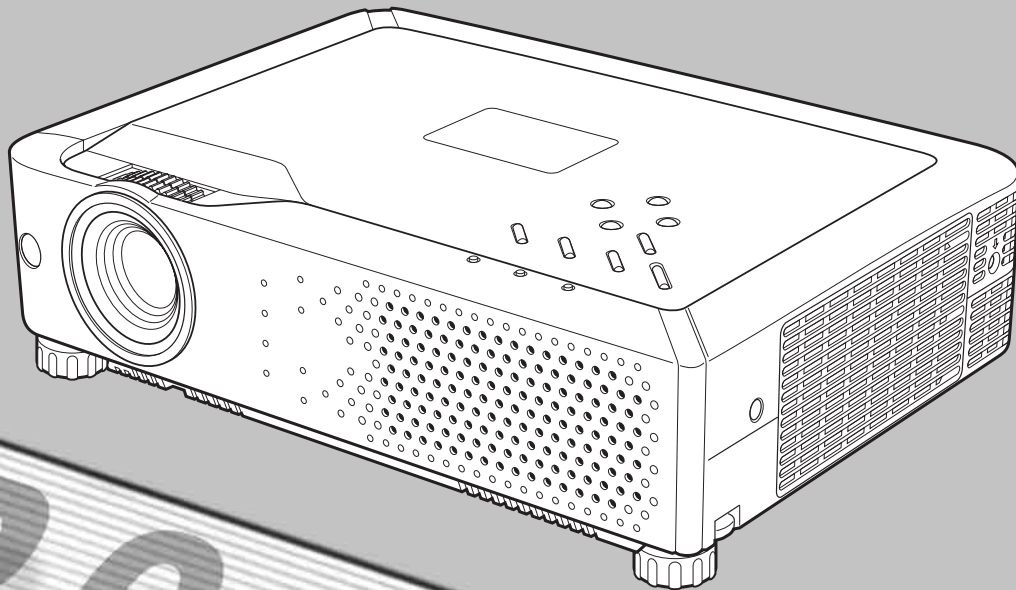

Owner's Manual

Features and Design

This Multimedia Projector is designed with the most advanced technology for portability, durability, and ease of use. This projector utilizes built-in multimedia features, a palette of 16.77 million colors, and matrix liquid crystal display (LCD) technology.

◆ **Compact Design**

This projector is designed compact in size and weight. It is easy to carry and work anywhere you wish to use.

◆ **Compatibility**

The projector widely accepts various video and computer input signals including; Computers, 6 Color systems (PAL, SECAM, NTSC, NTSC4.43, PAL-M, PAL-N), Component video, S-Video and RGB scart.

◆ **Simple Computer System Setting**

The projector has the Multi-scan system to conform to almost all computer output signals quickly. (p26)

◆ **Quick Termination**

The AC cord can be plugged out right after turning off the projector. (p19)

◆ **Digital Zoom (for Computer)**

The digital zoom function expands (to approx. 16 times of screen size) or compresses (to approx. half of the screen size) the image size, allowing you to focus on crucial information during a presentation. (p33)

◆ **Noise reduction function**

The Noise reduction function helps you to reduce the contained noise on the screen to get smoother images. (p39)

◆ **Blackboard Function**

Blackboard* can be used as a projection screen.
* The board color is limited to Green. (p30, 37)

◆ **Multilanguage Menu Display**

Operation menu is available in 16 languages; English, German, French, Italian, Spanish, Portuguese, Dutch, Swedish, Finnish, Polish, Hungarian, Romanian, Russian, Chinese, Korean, or Japanese. (p41)

◆ **Logo Function**

The Logo function allows you to customize the screen logo with the Logo functions. (p42, 43) You can capture an image for the screen logo, choose a logo between provided and captured.

◆ **Switchable Interface Terminal**

The projector provides a switchable interface terminal. You can use the terminal as computer input or monitor output conveniently. (p44)

◆ **Power Management**

The Power management function reduces power consumption and maintains the lamp life. (p44)

◆ **Lamp Control**

Brightness of the projection lamp can be selected. (p45)

◆ **Security Function**

The Security function helps you to ensure the security with the Key lock (p46) and the PIN code lock (p18, 46, 47) functions. You can lock the operation on the projector and the remote control. Also you can prevent unauthorized persons from using the projector.

✓ **Note:**

- The On-Screen Menu and figures in this manual may differ slightly from the product.
- The contents of this manual are subject to change without notice.

Table of Contents

Features and Design	2	Computer Input	25
Table of Contents	3	Input Source Selection	25
To the Owner	4	Computer System Selection	26
Safety Instructions	5	Auto PC Adjustment	27
Air Circulation	6	Manual PC Adjustment	28
Installing the Projector in Proper Position	6	Image Level Selection	30
Moving the Projector	6	Image Level Adjustment	31
Compliance	7	Screen Size Adjustment	32
Part Names and Functions	8	Video Input	34
Front	8	Input Source Selection (Video, S-Video)	34
Back	8	Input Source Selection	
Bottom	8	(Component, RGB Scart 21-pin)	35
Rear Terminal	9	Video System Selection	36
Top Control	10	Image Level Selection	37
Remote Control	11	Image Level Adjustment	38
Remote Control Battery Installation	12	Screen Size Adjustment	40
Operating Range	12	Setting	41
Installation	13	Setting	41
Positioning the Projector	13	Maintenance and Cleaning	49
Adjustable Feet	13	Warning Indicator	49
Connecting the AC Power Cord	14	Cleaning the Air Filters	50
Connecting to a Computer	15	Attaching the Lens Cover	50
Connecting to Video Equipment	16	Cleaning the Projection Lens	51
Connecting to Component Video Equipment	17	Cleaning the Projector Cabinet	51
Basic Operation	18	Lamp Replacement	52
Turning On the Projector	18	Lamp Replacement Counter	53
Turning Off the Projector	19	Appendix	54
How to Operate the On-Screen Menu	20	Troubleshooting	54
Menu Bar	21	Menu Tree	56
Zoom and Focus Adjustment	22	Indicators and Projector Condition	58
Keystone Correction	22	Compatible Computer Specifications	59
Sound Adjustment	23	Technical Specifications	60
Remote Control Operation	23	Optional Parts	61
		Configurations of Terminals	62
		PIN Code Number Memo	63

Trademarks

Each name of corporations or products in this book is either a registered trademark or a trademark of its respective corporation.





To the Owner

Before operating this projector, read this manual thoroughly and operate the projector properly.

This projector provides many convenient features and functions. Operating the projector properly enables you to manage those features and maintains it in better condition for a considerable time.

Improper operation may result in not only shortening the product-life, but also malfunctions, fire hazard, or other accidents.

If your projector seems to operate improperly, read this manual again, check operations and cable connections and try the solutions in the "Troubleshooting" section in the end of this booklet. If the problem still persists, contact the dealer where you purchased the projector or the service center.

	CAUTION RISK OF ELECTRIC SHOCK DO NOT OPEN	
CAUTION : TO REDUCE THE RISK OF ELECTRIC SHOCK, DO NOT REMOVE COVER (OR BACK). NO USER-SERVICEABLE PARTS INSIDE EXCEPT LAMP REPLACEMENT. REFER SERVICING TO QUALIFIED SERVICE PERSONNEL.		
	THIS SYMBOL INDICATES THAT DANGEROUS VOLTAGE CONSTITUTING A RISK OF ELECTRIC SHOCK IS PRESENT WITHIN THIS UNIT.	
	THIS SYMBOL INDICATES THAT THERE ARE IMPORTANT OPERATING AND MAINTENANCE INSTRUCTIONS IN THE OWNER'S MANUAL WITH THIS UNIT.	

NOTE: This symbol mark and recycle system are applied only to EU countries and not applied to the countries in the other area of the world.



Your SANYO product is designed and manufactured with high quality materials and components which can be recycled and reused.

This symbol means that electrical and electronic equipment, at their end-of-life, should be disposed of separately from your household waste.

Please dispose of this equipment at your local community waste collection/recycling centre.

In the European Union there are separate collection systems for used electrical and electronic products.

Please help us to conserve the environment we live in!



Safety Precaution

WARNING : TO REDUCE THE RISK OF FIRE OR ELECTRIC SHOCK, DO NOT EXPOSE THIS APPLIANCE TO RAIN OR MOISTURE.

- This projector produces intense light from the projection lens. Do not stare directly into the lens as much as possible. Eye damage could result. Be especially careful that children do not stare directly into the beam.
- Install the projector in a proper position. If not, it may result in a fire hazard.
- Provide appropriate space on the top, sides and rear of the projector cabinet for allowing air circulation and cooling the projector. Minimum clearance must be maintained. If the projector is to be built into a compartment or similarly enclosed, the minimum distances must be maintained. Do not cover the ventilation slot on the projector. Heat build-up can reduce the service life of your projector, and can also be dangerous.

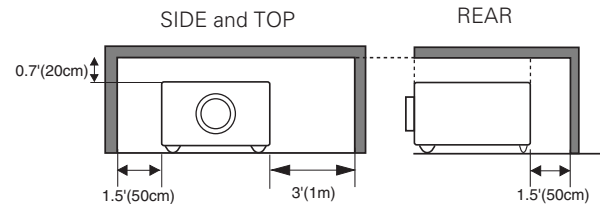

- If the projector is not to be used for an extended time, unplug the projector from the power outlet.



CAUTION ON HANGING FROM THE CEILING

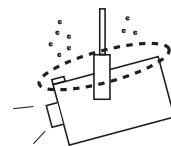

When hanging the projector from the ceiling, clean air intake vents, air filters, or top of the projector periodically with a vacuum cleaner. If you leave the projector without cleaning for a long time, the dust will block the operation of the cooling function, and it may cause a breakdown or a disaster.

DO NOT SET THE PROJECTOR IN GREASY, WET, OR SMOKY CONDITIONS SUCH AS IN A KITCHEN TO PREVENT A BREAKDOWN OR A DISASTER. IF THE PROJECTOR COMES IN CONTACT WITH OIL OR CHEMICALS, IT MAY BECOME DETERIORATED.

CAUTION

Not for use in a computer room as defined in the Standard for the Protection of Electronic Computer/Data Processing Equipment, ANSI/NFPA 75.

Ne peut être utilisé dans une salle d'ordinateurs telle que définie dans la norme ANSI/NFPA 75 Standard for Protection of Electronic Computer/Data Processing Equipment

READ AND KEEP THIS OWNER'S MANUAL FOR LATER USE.

Safety Instructions

All the safety and operating instructions should be read before the product is operated.

Read all of the instructions given here and retain them for later use. Unplug this projector from AC power supply before cleaning. Do not use liquid or aerosol cleaners. Use a damp cloth for cleaning.

Follow all warnings and instructions marked on the projector.

For added protection to the projector during a lightning storm, or when it is left unattended and unused for long periods of time, unplug it from the wall outlet. This will prevent damage due to lightning and power line surges.

Do not expose this unit to rain or use near water... for example, in a wet basement, near a swimming pool, etc...

Do not use attachments not recommended by the manufacturer as they may cause hazards.

Do not place this projector on an unstable cart, stand, or table. The projector may fall, causing serious injury to a child or adult, and serious damage to the projector. Use only with a cart or stand recommended by the manufacturer, or sold with the projector. Wall or shelf mounting should follow the manufacturer's instructions, and should use a mounting kit approved by the manufacturers.

An appliance and cart combination should be moved with care. Quick stops, excessive force, and uneven surfaces may cause the appliance and cart combination to overturn.



Slots and openings in the back and bottom of the cabinet are provided for ventilation, to ensure reliable operation of the equipment and to protect it from overheating.

The openings should never be covered with cloth or other materials, and the bottom opening should not be blocked by placing the projector on a bed, sofa, rug, or other similar surface. This projector should never be placed near or over a radiator or heat register.

This projector should not be placed in a built-in installation such as a book case unless proper ventilation is provided.

Never push objects of any kind into this projector through cabinet slots as they may touch dangerous voltage points or short out parts that could result in a fire or electric shock. Never spill liquid of any kind on the projector.

Do not install the projector near the ventilation duct of air-conditioning equipment.

This projector should be operated only from the type of power source indicated on the marking label. If you are not sure of the type of power supplied, consult your authorized dealer or local power company.

Do not overload wall outlets and extension cords as this can result in fire or electric shock. Do not allow anything to rest on the power cord. Do not locate this projector where the cord may be damaged by persons walking on it.

Do not attempt to service this projector yourself as opening or removing covers may expose you to dangerous voltage or other hazards. Refer all servicing to qualified service personnel.

Unplug this projector from wall outlet and refer servicing to qualified service personnel under the following conditions:

- a. When the power cord or plug is damaged or frayed.
- b. If liquid has been spilled into the projector.
- c. If the projector has been exposed to rain or water.
- d. If the projector does not operate normally by following the operating instructions. Adjust only those controls that are covered by the operating instructions as improper adjustment of other controls may result in damage and will often require extensive work by a qualified technician to restore the projector to normal operation.
- e. If the projector has been dropped or the cabinet has been damaged.
- f. When the projector exhibits a distinct change in performance-this indicates a need for service.

When replacement parts are required, be sure the service technician has used replacement parts specified by the manufacturer that have the same characteristics as the original part. Unauthorized substitutions may result in fire, electric shock, or injury to persons.

Upon completion of any service or repairs to this projector, ask the service technician to perform routine safety checks to determine that the projector is in safe operating condition.



Voor de klanten in Nederland

Bij dit produkt zijn batterijen geleverd.

Wanneer deze leeg zijn, moet u ze niet weggooien maar inleveren als KCA.



Air Circulation

Openings in the cabinet are provided for ventilation and to ensure reliable operation of the product and to protect it from overheating, and these openings must not be blocked or covered.

CAUTION

Hot air is exhausted from the exhaust vent. When using or installing the projector, the following precautions should be taken.

- Do not put any flammable object or spray can near the projector, hot air is exhausted from the ventilation holes.
- Keep the exhaust vent at least 3'(1m) away from any objects.
- Do not touch a peripheral part of the exhaust vent, especially screws and metallic part. This area will become hot while the projector is being used.
- Do not put anything on the cabinet. The materials put on the cabinet will not only get damaged but also cause fire hazard by heat.

Cooling fans are provided to cool down the projector. The fans' running speed is changed according to the temperature inside the projector.

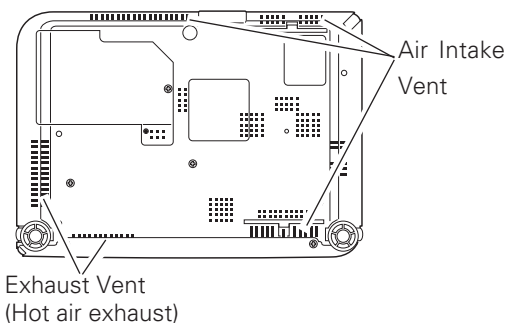
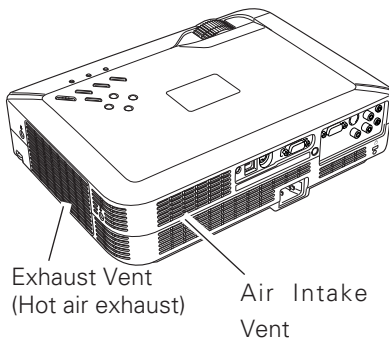
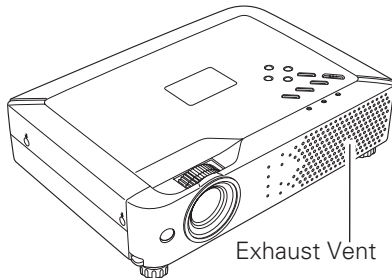

Installing the Projector in Proper Position

Install the projector properly. Improper Installation may reduce the lamp life and cause a fire hazard.

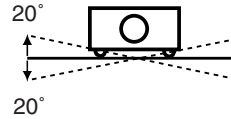

Do not tilt the projector more than 20 degrees from side to side.



Do not point the projector up to project an image.



Do not point the projector down to project an image.



Do not put the projector on either side to project an image.

Moving the Projector

When moving the projector, replace the lens cover and retract the adjustable feet to prevent damage to the lens and cabinet. When the projector is not in use for an extended period, put it into a suitable case to protect the projector.

When handling the projector, do not drop, bump, subject it to strong forces or put other things on the cabinet.



USE CAUTION IN CARRYING OR TRANSPORTING THE PROJECTOR

- Do not drop or bump the projector, otherwise damages or malfunctions may result.
- When carrying the projector, use a suitable carrying case.
- Do not transport the projector by using a courier or transport service in an unsuitable transport case. This may cause damage to the projector. To transport the projector through a courier or transport service, consult your dealer for their information.
- Do not put the projector in a case before the projector is cooled enough.

Federal Communication Commission Notice

Note : This equipment has been tested and found to comply with the limits for a Class B digital device, pursuant to part 15 of the FCC Rules. These limits are designed to provide reasonable protection against harmful interference in a residential installation. This equipment generates, uses and can radiate radio frequency energy and, if not installed and used in accordance with the instructions, may cause harmful interference to radio communications. However, there is no guarantee that interference will not occur in a particular installation. If this equipment does cause harmful interference to radio or television reception, which can be determined by turning the equipment off and on, the user is encouraged to try to correct the interference by one or more of the following measures :

- Reorient or relocate the receiving antenna.
- Increase the separation between the equipment and receiver.
- Connect the equipment into an outlet on a circuit different from that to which the receiver is connected.
- Consult the dealer or an experienced radio/TV technician for help.

Use of shielded cable is required to comply with class B limits in Subpart B of Part 15 of FCC Rules.

Do not make any changes or modifications to the equipment unless otherwise specified in the instructions. If such changes or modifications should be made, you could be required to stop operation of the equipment.

Model Numbers : PLC-XU73, PLC-XU70, PLC-SU70
Trade Name : Sanyo
Responsible party : SANYO FISHER COMPANY
Address : 21605 Plummer Street, Chatsworth, California 91311
Telephone No. : (818)998-7322

AC Power Cord Requirement

The AC Power Cord supplied with this projector meets the requirement for use in the country you purchased it.

AC Power Cord for the United States and Canada :

AC Power Cord used in the United States and Canada is listed by the Underwriters Laboratories (UL) and certified by the Canadian Standard Association (CSA).

AC Power Cord has a grounding-type AC line plug. This is a safety feature to be sure that the plug will fit into the power outlet. Do not try to defeat this safety feature. Should you be unable to insert the plug into the outlet, contact your electrician.

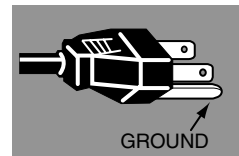

AC Power Cord for the United Kingdom :

This cord is already fitted with a moulded plug incorporating a fuse, the value of which is indicated on the pin face of the plug. Should the fuse need to be replaced, an ASTA approved BS 1362 fuse must be used of the same rating, marked thus \diamond . If the fuse cover is detachable, never use the plug with the cover omitted. If a replacement fuse cover is required, ensure it is of the same colour as that visible on the pin face of the plug (i.e. red or orange). Fuse covers are available from the Parts Department indicated in your User Instructions.

If the plug supplied is not suitable for your socket outlet, it should be cut off and destroyed.

The end of the flexible cord should be suitably prepared and the correct plug fitted. (See Over)

WARNING : A PLUG WITH BARED FLEXIBLE CORD IS HAZARDOUS IF ENGAGED IN A LIVE SOCKET OUTLET.

The Wires in this mains lead are coloured in accordance with the following code:

Green-and-yellow Earth
Blue Neutral
Brown Live

As the colours of the wires in the mains lead of this apparatus may not correspond with the coloured markings identifying the terminals in your plug proceed as follows:

The wire which is coloured green-and-yellow must be connected to the terminal in the plug which is marked by the letter E or by the safety earth symbol \perp or coloured green or green-and-yellow.

The wire which is coloured blue must be connected to the terminal which is marked with the letter N or coloured black.

The wire which is coloured brown must be connected to the terminal which is marked with the letter L or coloured red.

WARNING : THIS APPARATUS MUST BE EARTHED.

THE SOCKET-OUTLET SHOULD BE INSTALLED NEAR THE EQUIPMENT AND EASILY ACCESSIBLE.

Part Names and Functions

Front

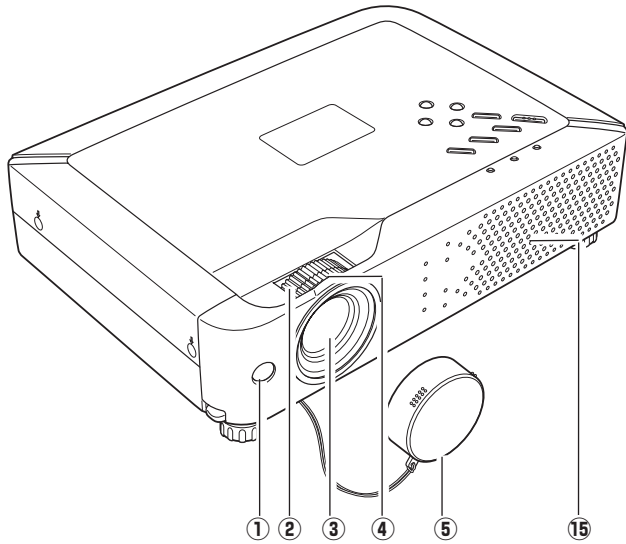

- ① Infrared Remote Receiver
- ② Zoom Ring
- ③ Projection Lens
- ④ Focus Ring
- ⑤ Lens Cover
(See page 50 for attaching.)

- ⑥ Top Controls and Indicators
- ⑦ Speaker
- ⑧ Air Intake Vent
- ⑨ Power Cord Connector
- ⑩ Terminals and Connectors

Back

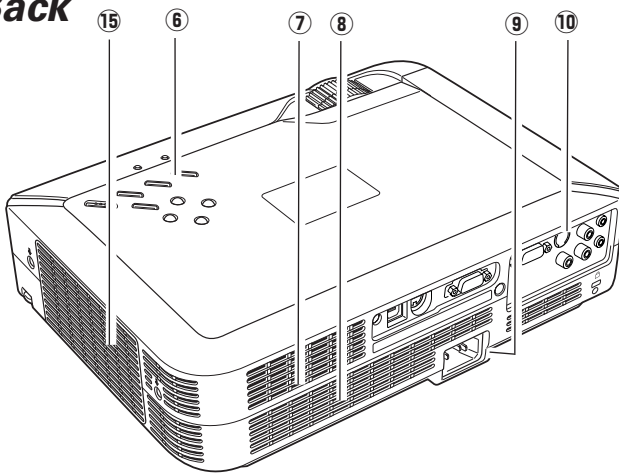

- ⑪ Lamp Cover
- ⑫ Air Intake Vents (back and bottom)
- ⑬ Air Filters
- ⑭ Adjustable Feet

- ⑮ Exhaust Vents



Hot air is exhausted from the exhaust vent. Do not put heat-sensitive objects near this side.

Bottom

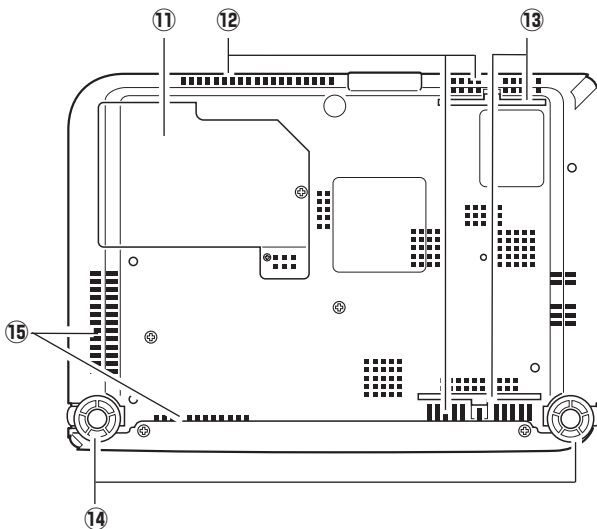

Rear Terminal

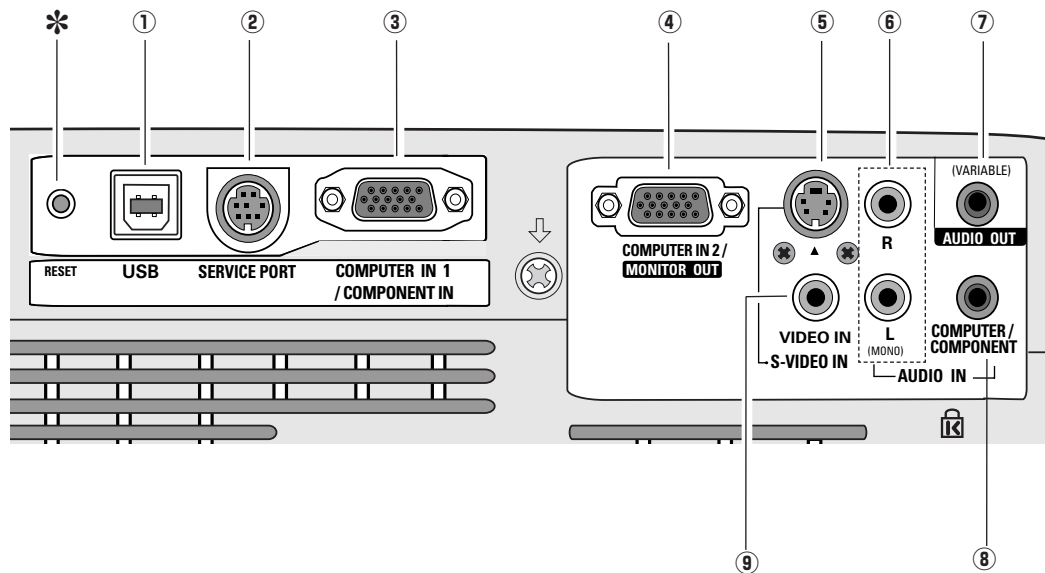

① USB (Series B)

In order to operate the computer with the remote control during a presentation, connect the USB port of the computer to the projector with a USB cable.(p15)

② SERVICE PORT

This jack is used to service the projector.

③ COMPUTER IN 1 / COMPONENT IN

Connect output signal from a computer, RGB scart 21-pin video output, or component video output to this terminal. (p15, 17)

When the cable is of the longer variety, it is advisable to use this terminal and not COMPUTER IN 2 / MONITOR OUT.

④ COMPUTER IN 2 / MONITOR OUT

This terminal is switchable and can be used for input from a computer and video equipment (component or RGB scart 21-pin) or output to the other monitor.

Set the terminal up as either Computer input or Monitor output properly. (Used for Monitor out, this terminal outputs only incoming signal from COMPUTER IN 1 / COMPONENT IN terminal.) (p15, 17, 44)

⑤ S-VIDEO IN

Connect the S-VIDEO output from video equipment to this jack. (p16)

⑥ AUDIO IN

Connect the audio output from video equipment connected to ⑤ or ⑨ to this jack. (When the audio output is monaural, connect it to L (MONO) jack.) (p16)

⑦ AUDIO OUT(VARIABLE)

Connect an external audio amplifier to this jack. (p15- 17)

This terminal outputs sound from AUDIO IN terminal (⑥ or ⑧).

⑧ COMPUTER/ COMPONENT AUDIO IN

Connect the audio output (stereo) from a computer or video equipment connected to ③ or ④ to this jack. (p 15, 17)

⑨ VIDEO IN

Connect the composite video output from video equipment to VIDEO jack. (p16)

* RESET button

A built-in micro processor which controls this unit may occasionally malfunction and need to be reset. This can be done by pressing the RESET button with a pen, which will shut down and restart the unit. Do not use the RESET function excessively.

Top Control

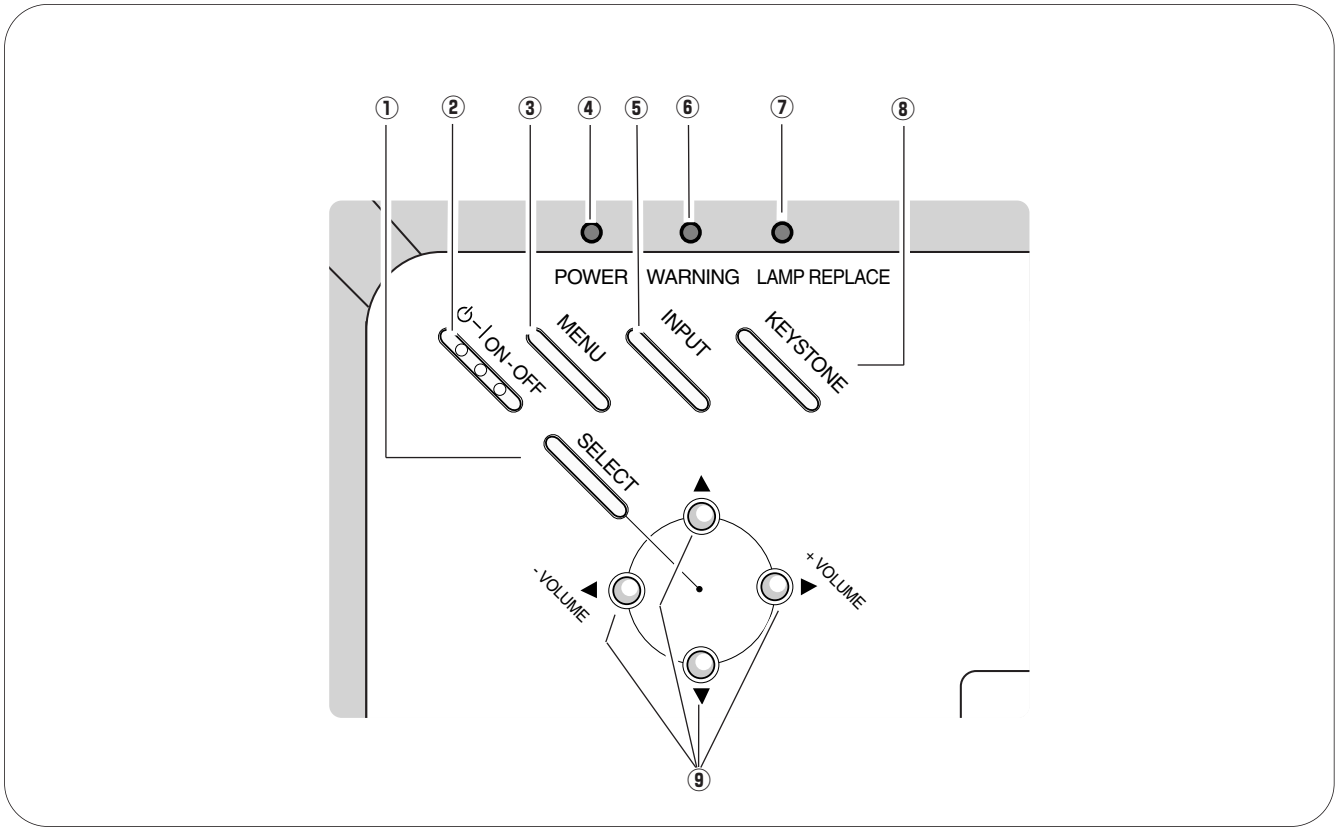

① **SELECT button**

- Execute the selected item. (p20)
- Expand or compress the image in Digital zoom mode. (p33)

② **POWER ON-OFF button**

Turn the projector on or off. (p18, 19)

③ **MENU button**

Open or close the On-Screen Menu. (p20)

④ **POWER indicator**

Emit a red light until the projector gets ready to be turned on. It turns red when the projector is in the stand-by mode. It remains green while the projector is under operation. (p18, 19, 58)

⑤ **INPUT button**

Select input source. (p25, 34, 35)

⑥ **WARNING indicator**

Emit a red light when the projector detects abnormal condition. This also blinks red when the internal temperature of the projector exceeds the operating range. (p49, 58)

⑦ **LAMP REPLACE indicator**

Turn yellow when the life of the projection lamp draws to an end. (p52, 58)

⑧ **KEYSTONE button**

Correct the keystone distortion. (p22, 41)

⑨ **POINT (▲▼◀▶) buttons**

- Select an item or adjust the value in the On-Screen Menu. (p20)
- Pan the image in Digital zoom + mode. (p33)
- Adjust the volume level. (Point ◀▶ buttons) (p23)

Remote Control

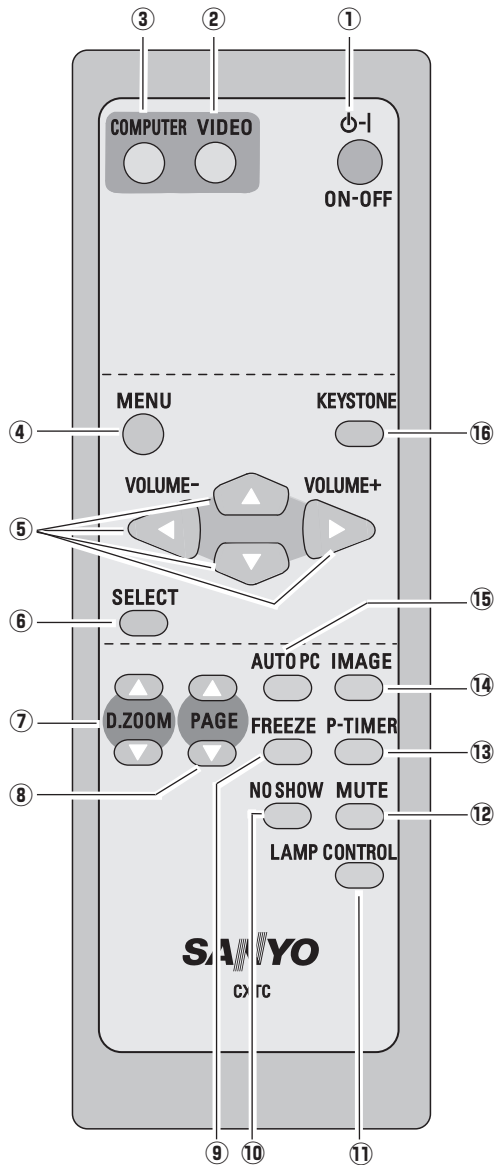

- ① **POWER ON-OFF button**
Turn the projector on or off. (p18, 19)
- ② **VIDEO button**
Select VIDEO input source. (p23, 34)
- ③ **COMPUTER button**
Select COMPUTER input source. (p23, 25, 35)
- ④ **MENU button**
Open or close the On-Screen Menu. (p20)
- ⑤ **Point ▲▼◀▶ (VOLUME + / -) buttons**
 - Select an item or adjust the value in the On-Screen Menu. (p20)
 - Pan the image in Digital zoom + mode. (p33)
 - Adjust the volume level. (Point ◀▶ buttons) (p23)
- ⑥ **SELECT button**
 - Execute the selected item. (p20)
 - Expand or compress the image in Digital zoom mode. (p33)
- ⑦ **D.ZOOM ▲▼ buttons**
Zoom in and out the images. (p24, 33)
- ⑧ **PAGE ▲▼ buttons**
Scroll back and forth pages on the screen when giving a presentation. Connect the projector and your computer with a USB cable to use these buttons. (p9, 15)
- ⑨ **FREEZE button**
Freeze the picture. (p23)
- ⑩ **NO SHOW button**
Temporarily turn off the image on the screen. (p24)
- ⑪ **LAMP CONTROL button**
Select the lamp mode. (p24, 45)
- ⑫ **MUTE button**
Mute the sound. (p 23)
- ⑬ **P-TIMER button**
Operate the P-timer function. (p24)
- ⑭ **IMAGE button**
Select the image level. (p24, 30, 37)
- ⑮ **AUTO PC button**
Automatically adjust the computer image to its optimum setting. (p24, 27)
- ⑯ **KEYSTONE button**
Correct the keystone distortion. (p22, 41)



- To ensure safe operation, please observe the following precautions :
- Do not bend, drop the remote control or expose the remote control to moisture or heat.
 - For cleaning, use soft dry cloth. Do not apply benzene, thinner, splay or any chemical material.

Remote Control Battery Installation

- 1** Open the battery compartment lid.

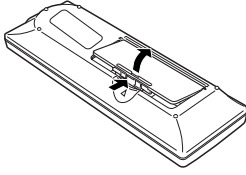

- 2** Install new batteries into the compartment.

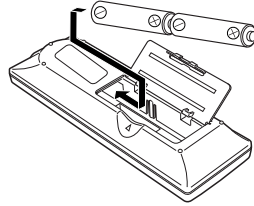

Two AA size batteries

For correct polarity (+ and -), be sure battery terminals are in contact with pins in the compartment.

- 3** Replace the compartment lid.

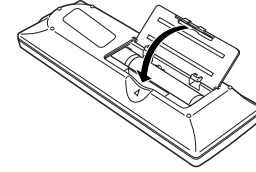

To insure safe operation, please observe the following precautions:

- Use (2) AA or LR6 type alkaline batteries.
- Always replace batteries in sets.
- Do not use a new battery with a used battery.
- Avoid contact with water or liquid.
- Do not expose the remote control to moisture or heat.
- Do not drop the remote control.
- If the battery has leaked on the remote control, carefully wipe the case clean and install new batteries.
- Risk of explosion if a battery is replaced by an incorrect type.
- Dispose of used batteries according to the instructions.

Operating Range

Point the remote control toward the projector (Infrared Remote Receiver) when pressing any button. Maximum operating range for the remote control is about 16.4' (5m) and 60° in front of the projector.

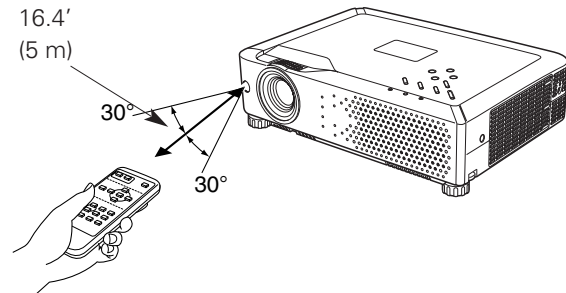

Installation

Positioning the Projector

For projector positioning, see the figures below. The projector should be set horizontally to the flat screen.

✓ **Note:**

- The brightness in the room has a great influence on picture quality. It is recommended to limit ambient lighting in order to obtain the best image.
- The values shown below are approximate and may vary from the actual sizes.

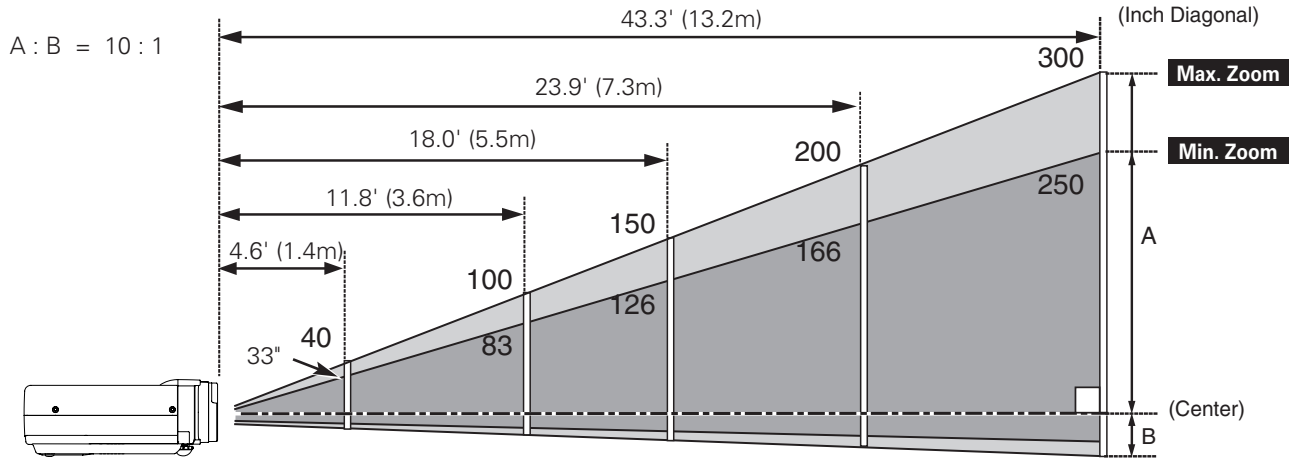

Screen Size (W x H) mm	40"	100"	150"	200"	300"
4 : 3 aspect ratio	813 x 610	2032 x 1524	3048 x 2286	4064 x 3048	6096 x 4572
Zoom (min)	5.6' (1.7m)	14.4' (4.4m)	21.7' (6.6m)	28.9' (8.8m)	43.3' (13.2m)
Zoom (max)	4.6' (1.4m)	11.8' (3.6m)	18.0' (5.5m)	23.9' (7.3m)	36.1' (11.0m)

Adjustable Feet

Projection angle can be adjusted up to 10.0 degrees with the adjustable feet.

- 1 Lift the front of the projector and pull upward the feet lock latches on both sides of the projector.
- 2 Release the feet lock latches to lock the adjustable feet and rotate the adjustable feet to adjust the position and tilt.
- 3 To retract the adjustable feet, lift the front of the projector and pull and undo the feet lock latches. Keystone distortion of the projected image can be corrected by menu operation. (p22, 41)

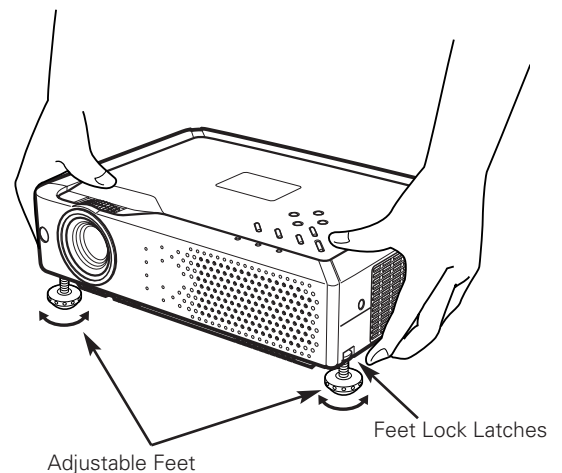

Connecting the AC Power Cord

This projector uses nominal input voltages of 100-120 V or 200-240 V AC. This projector automatically selects the correct input voltage. It is designed to work with single-phase power systems having a grounded neutral conductor. To reduce the risk of electrical shock, do not plug into any other type of power system.

Consult your authorized dealer or service station if you are not sure of the type of power being supplied.

Connect the projector with all peripheral equipment before turning the projector on. (See page 15-17 for connection.)



CAUTION

For safety, unplug the AC power cord when the projector is not in use. When this projector is connected to an outlet with the AC power cord, it is in Stand-by mode and consumes a little electric power.

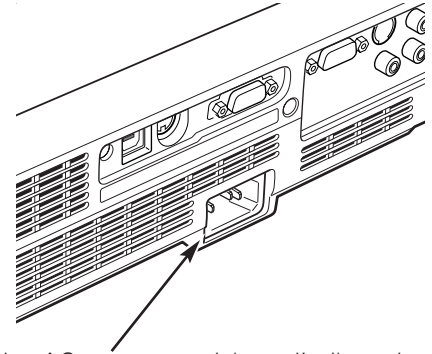

Connect the AC power cord (supplied) to the projector. The AC outlet must be near this equipment and must be easily accessible.

NOTE ON THE POWER CORD

AC power cord must meet requirement of the country where you use the projector. Confirm the AC plug type with the chart below and proper AC power cord must be used. If supplied AC power cord does not match your AC outlet, contact your sales dealer.

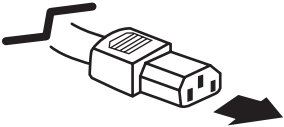
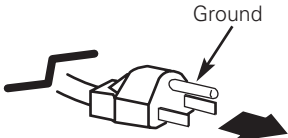
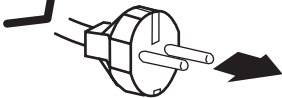
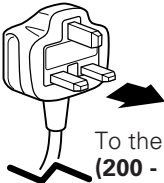
Projector side	AC outlet side		
 <p data-bbox="207 1268 407 1350">To power cord connector on your projector.</p>	<p data-bbox="508 1073 781 1100">For the U.S.A. and Canada</p>  <p data-bbox="570 1283 753 1339">To the AC outlet. (120 V AC)</p>	<p data-bbox="842 1073 1115 1100">For Continental Europe</p>  <p data-bbox="938 1297 1122 1354">To the AC outlet. (200 - 240 V AC)</p>	<p data-bbox="1237 1073 1380 1100">For the U.K.</p>  <p data-bbox="1279 1276 1463 1333">To the AC outlet. (200 - 240 V AC)</p>

Connecting to a Computer

Cables used for connection

- VGA Cables (Mini D-sub 15 pin) (Only one cable is supplied.)
 - USB Cable *
 - Audio Cables (Mini Plug: stereo) *
- (* = Not supplied with this projector.)

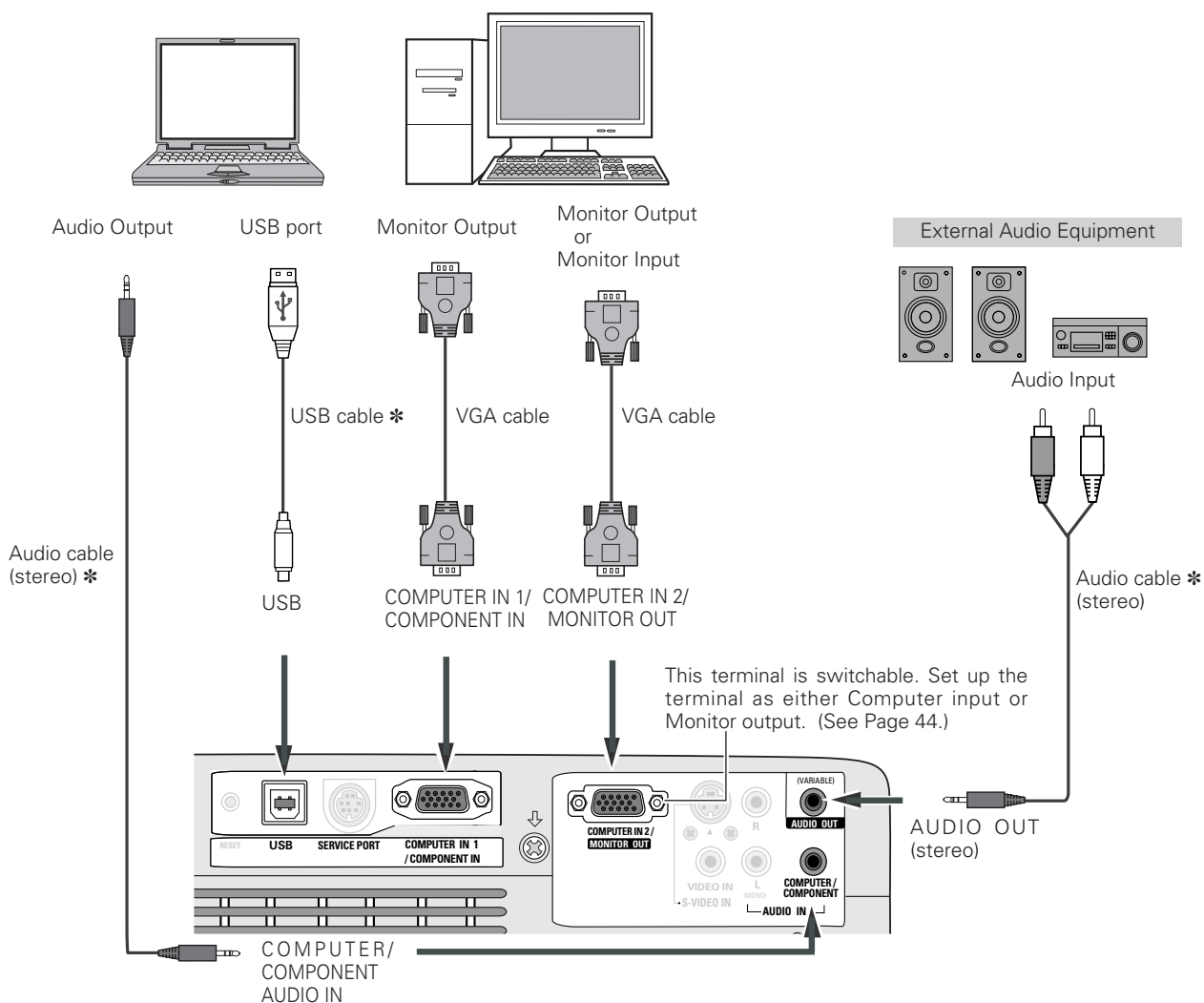

✓ Note:

- Input sound to the **COMPUTER / COMPONENT AUDIO IN** terminal when using the **COMPUTER IN 1 / COMPONENT IN** and the **COMPUTER IN 2 / MONITOR OUT** terminal as input.
- When connecting the **AUDIO OUT** to external audio equipment, the projector's built-in speaker is disconnected.
- When the cable is of the longer variety, it is advisable to use the **COMPUTER IN 1 / COMPONENT IN** and not the **COMPUTER IN 2 / MONITOR OUT**.
- See p61 for ordering optional parts.



When connecting the cable, the power cords of both the projector and the external equipment should be disconnected from AC outlet.

Connecting to Video Equipment

Cables used for connection

- Video and Audio Cable (RCA x 3) *
 - S-VIDEO Cable *
 - Audio Cable (Mini Plug: stereo) *
- (* = Not supplied with this projector.)

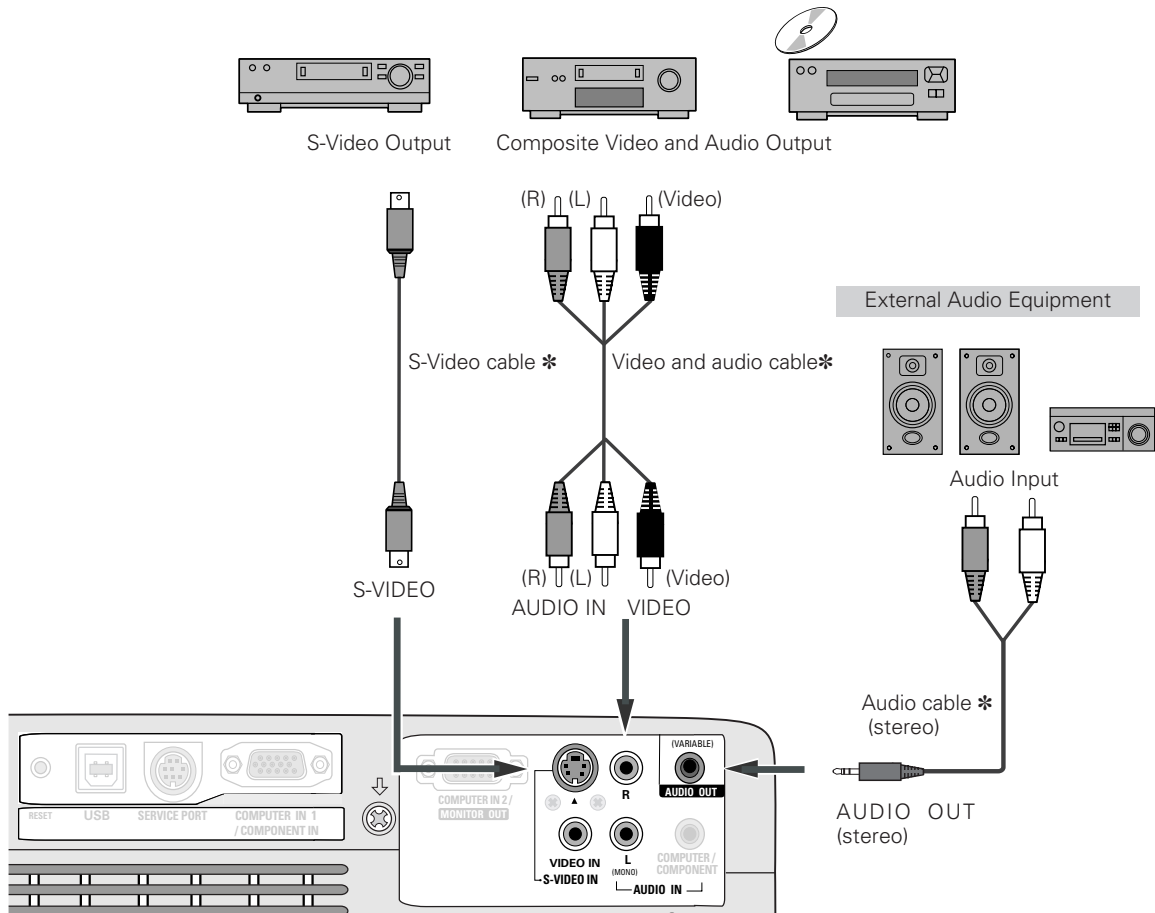

✓ **Note:**

- When connecting AUDIO OUT to external audio equipment, the projector's built-in speaker is disconnected.
- See p61 for ordering optional parts.



When connecting the cable, the power cords of both the projector and the external equipment should be disconnected from AC outlet.

Connecting to Component Video Equipment

Cables used for connection

- Audio Cables (Mini Plug :stereo) *
 - Scart-VGA Cable *
 - Component Cable *
 - Component-VGA Cable *
- (* = Not supplied with this projector.)

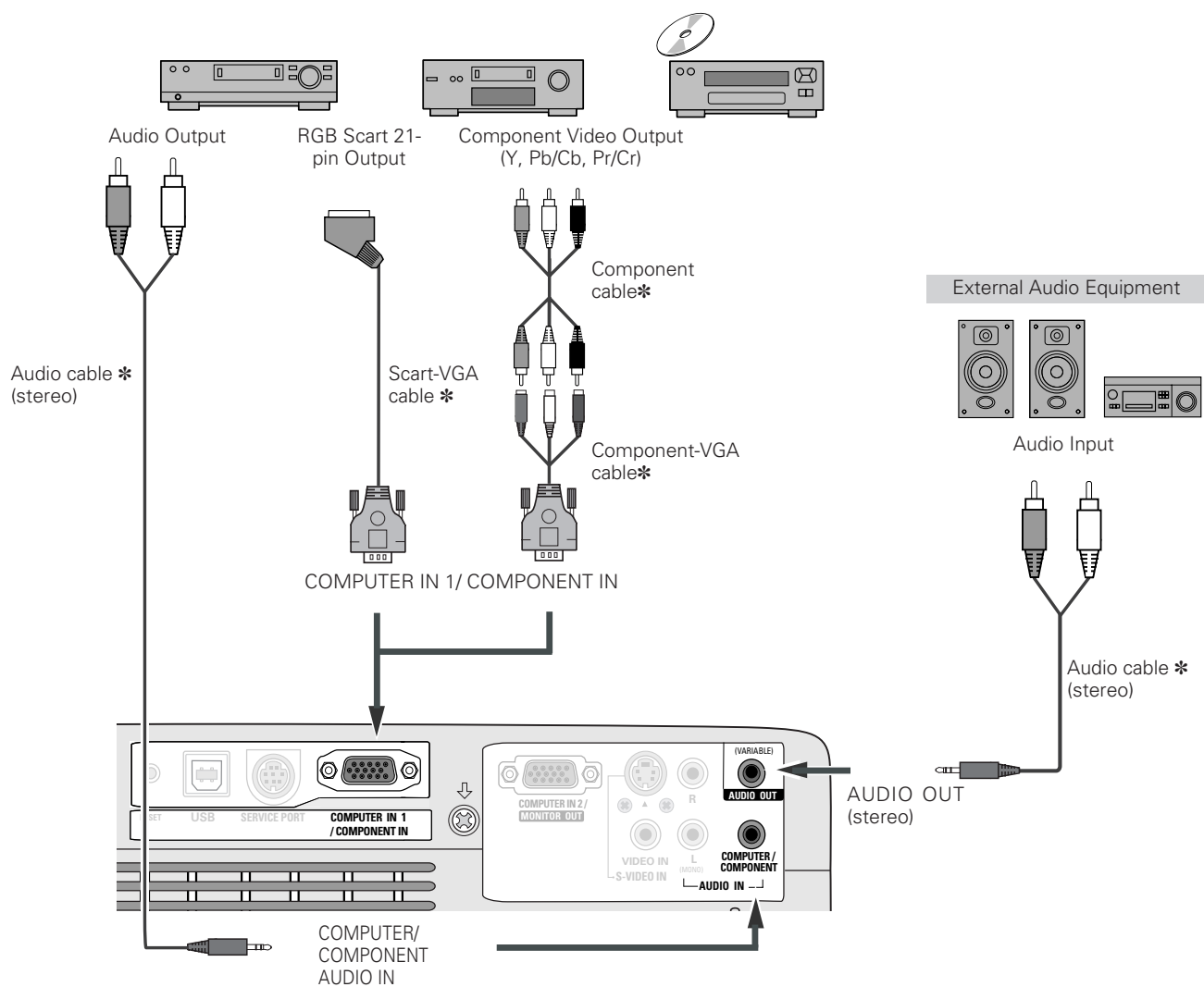

✓ **Note:**

- When connecting **AUDIO OUT** to external audio equipment, the projector's built-in speaker is disconnected.
- See p61 for ordering optional parts.



When connecting the cable, the power cords of both the projector and the external equipment should be disconnected from AC outlet.

Basic Operation

Turning On the Projector

- 1 Complete peripheral connections (with a computer, VCR, etc.) before turning on the projector.
- 2 Connect the projector's AC power cord into an AC outlet. The POWER indicator will be red.
- 3 Press the POWER ON-OFF button on the top control or on the remote control. The POWER indicator will become green and the cooling fans will start to operate. The preparation display will appear on the screen and the count down will start.
- 4 After the countdown, the input source that was selected last and the Lamp mode status icon (see page 45) will appear on the screen.

If the projector is locked with a PIN code, PIN code Input Dialog Box will appear. Enter the PIN code as instructed below.

Enter a PIN code

Select a number by pressing the Point ◀▶ buttons and fix the number with the SELECT button. The number will change to "*". If you fixed an incorrect number, move the pointer to "Set" or "Clear" once by pressing the Point ▼ button, then return to "PIN code". Enter the correct number again.

Repeat this step to complete entering a four-digit number. "1234" is set as the initial PIN code at the factory.

When the four-digit number is fixed, the pointer will automatically move to "Set". Press the SELECT button so that you can start to operate the projector.

If you entered an incorrect PIN code, "PIN code" and the number (****) will turn red and disappear. Enter the correct PIN code all over again.

What is PIN code?

PIN code is a security code using Personal Identification Number that allows the person who knows it to operate the projector. Setting PIN code prevents others except the specific users from operating the projector.

A PIN code consists of a four-digit number. Refer to PIN code lock function in Setting on page 46, 47 for locking operation of the projector with your PIN code.



CAUTION ON HANDLING PIN CODE

If you forget your PIN code, the projector can no longer be started. Set a new PIN code with special care, write it down in column on page 63 of this manual, and keep it at hand. Should the PIN code be missing or forgotten, consult your dealer or service center.



The preparation display will disappear after 30 seconds.

Selected Input Source and Lamp Mode

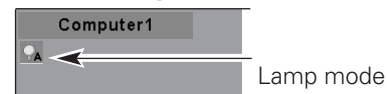

(See page 45 for Lamp mode.)

PIN Code Input Dialog Box



After the OK icon disappears, you can operate the projector.

✓Note:

- When the Logo select function is off, the logo will not be shown on the screen. (p42)
- When the "Countdown off" or "Off" is selected in the Display function, the countdown will not be shown on the screen. (p41)
- During the countdown period, all operations are invalid.
- If the correct PIN code number is not input for 3 minutes after the PIN code dialog box appeared, the projector will be turned off automatically.

Turning Off the Projector

- 1 Press the POWER ON-OFF button on the top control or on the remote control, and a message "Power off?" will appear on the screen.
- 2 Press the POWER ON-OFF button again to turn off the projector. The POWER indicator will start to blink red, and the cooling fans will keep operating. (You can select the level of fan quietness and rotation speed. See page 48.) At this time you can disconnect the AC power cord even if the fans are still running.
- 3 When the projector has cooled down enough to be turned on again, the POWER indicator will be red.

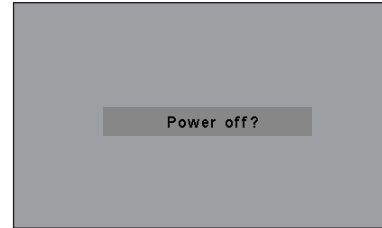

The message will disappear after 4 seconds.



TO MAINTAIN THE LIFE OF THE LAMP, ONCE YOU TURN THE PROJECTOR ON, WAIT AT LEAST 5 MINUTES BEFORE TURNING IT OFF.

✓Note:

- When the On start function is on, this projector will be turned on automatically by connecting the AC power cord to an AC outlet. (p45)
- Do not operate the projector continuously without rest. Continuous use may result in shortening the lamp life. Turn off the projector and give it a rest about an hour in every 24 hours.
- The running speed of cooling fans is changed according to the temperature inside the projector.
- Do not put the projector in a case before the projector is cooled enough.
- If the WARNING indicator blinks or emits a red light, see "Warning Indicator" on page 49.
- While the POWER indicator is blinking, lamp is being cooled down and the projector cannot be turned on. Wait until the POWER indicator becomes red to be turned on again.
- For assisting the cooling fans' operation, the projector is equipped with a large capacitor. While the projector is operating, the capacitor charges electricity. When disconnecting the AC plug from AC outlet, cooling fans start to run about 1 minutes until the capacitor is discharged.

How to Operate the On-Screen Menu

The projector can be adjusted or set via the On-Screen Menu. Refer to the following pages regarding each adjustment and setting procedures.

- 1 Press the MENU button to display the On-Screen Menu.
- 2 Press the Point ◀▶ buttons to select a Menu icon to adjust and press the Point ▲▼ buttons to select an item to adjust.
- 3 Press the SELECT button to show the item data. To adjust the data, press the Point ◀▶ buttons. Refer to the following pages for each adjustment.

To close the On-Screen Menu, press the MENU button again .

✓**Note:**

The selected item is not active until the SELECT button is pressed.

Top Control

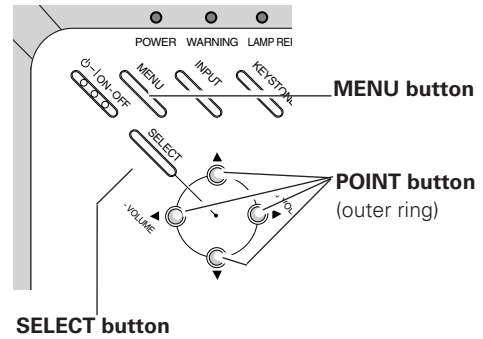

Remote Control

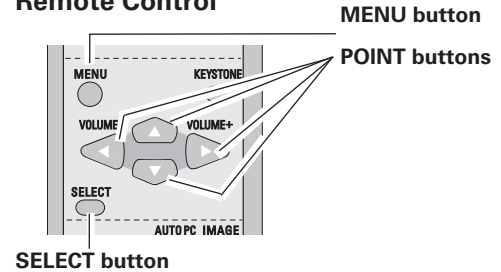

On-Screen Menu

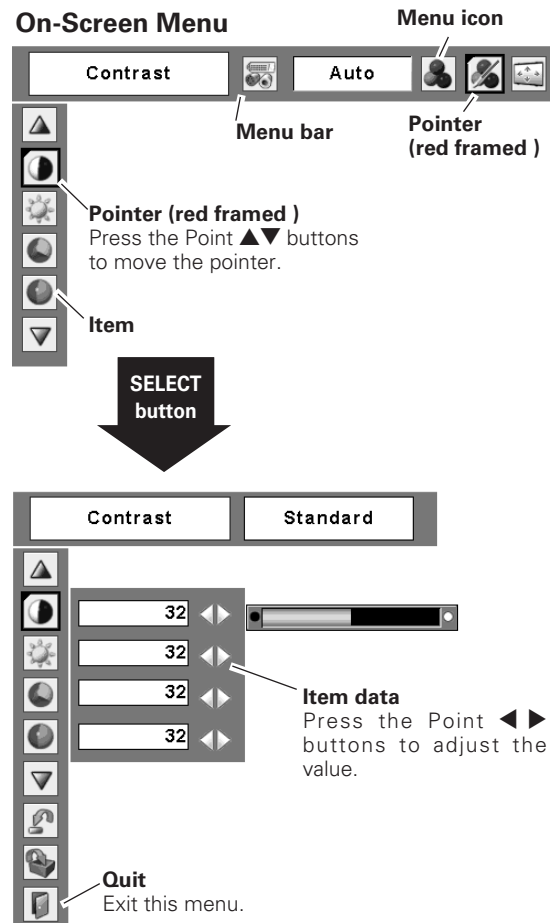

Menu Bar

For detailed functions, see Menu Tree on p56, 57.

For computer source

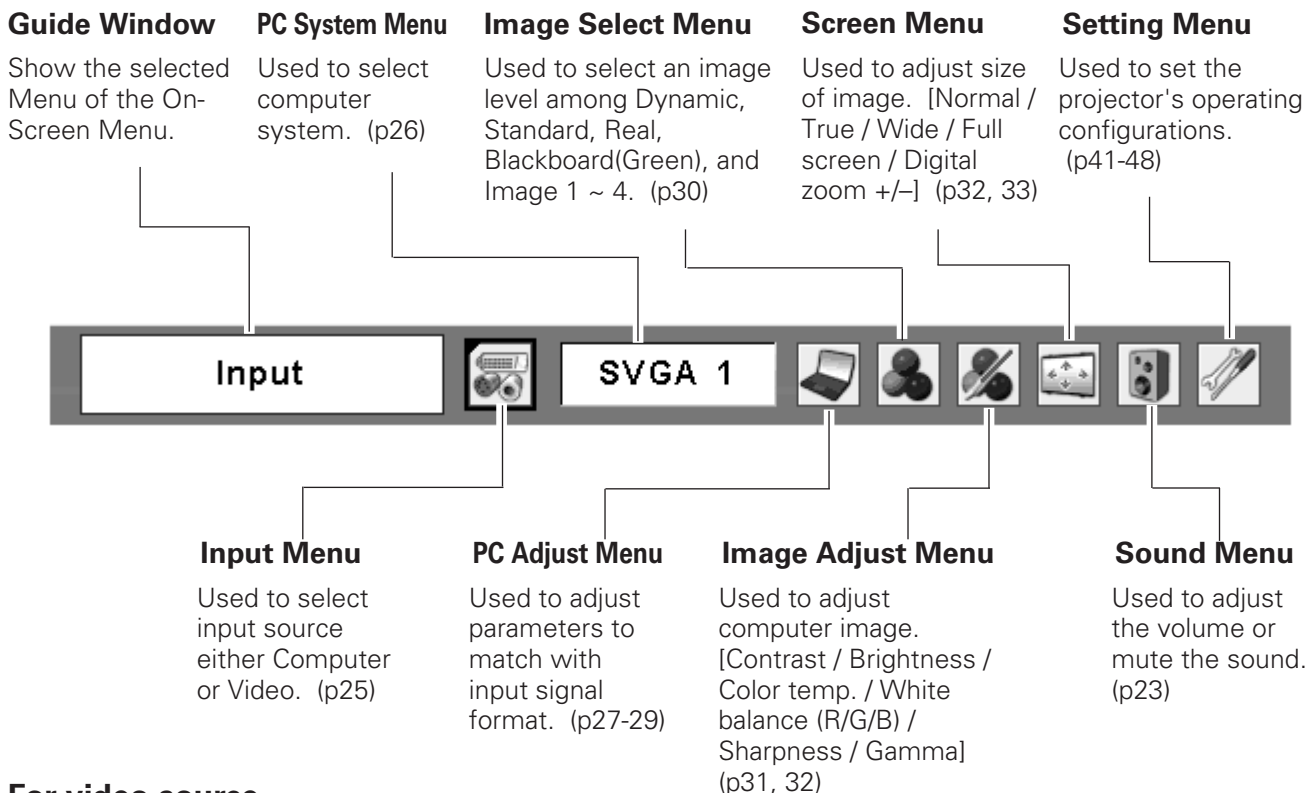

For video source

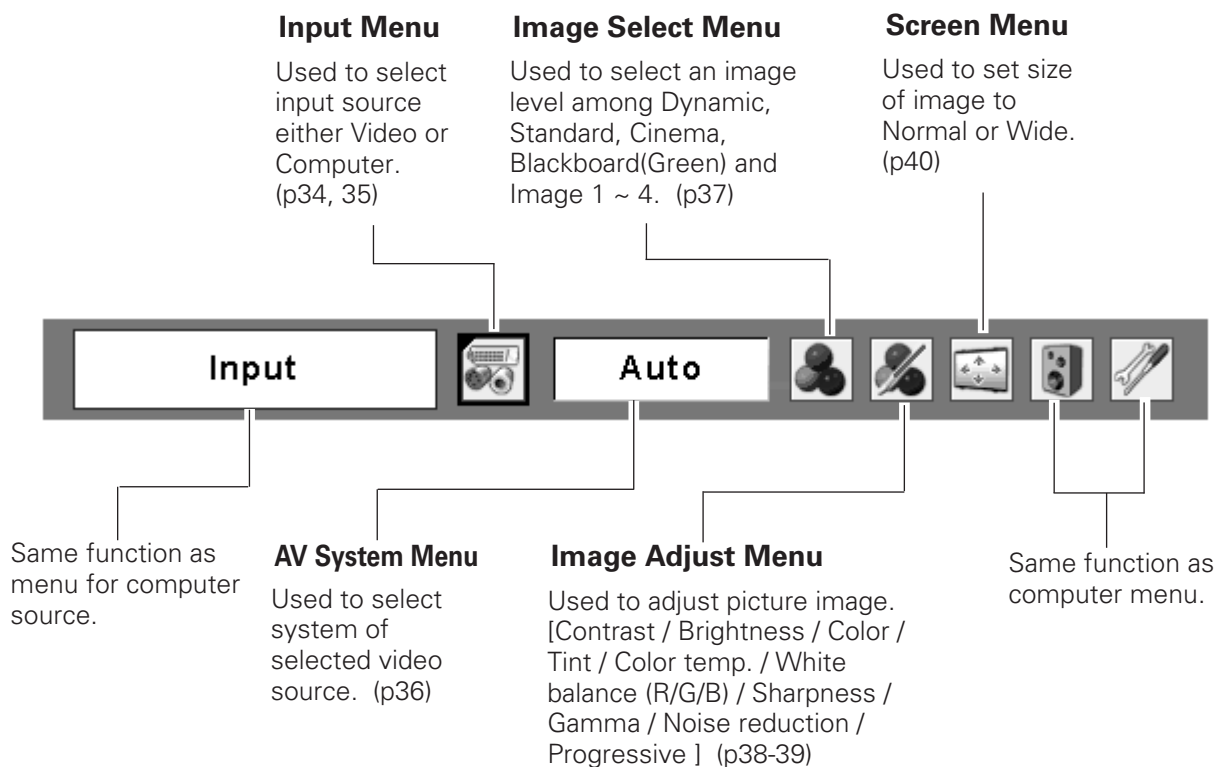

Zoom and Focus Adjustment

Rotate the Zoom Ring to zoom in and out.
Rotate the Focus Ring to adjust the projected picture focus.

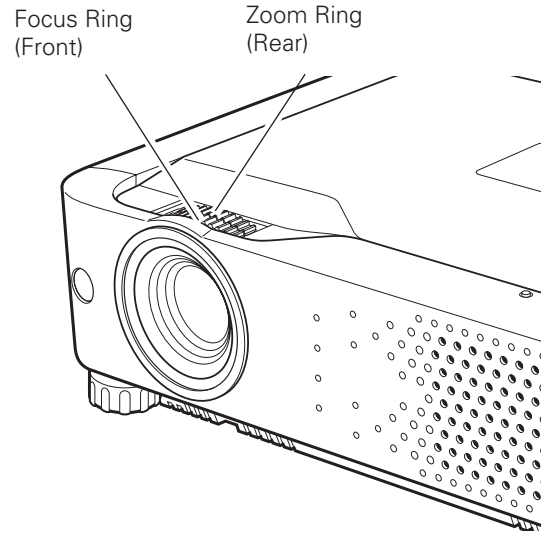

Keystone Correction

If a projected picture has keystone distortion, correct the image with Keystone adjustment.

Press the KEYSTONE button on the top control or on the remote control. The keystone dialog box will appear. Correct keystone distortion by pressing the Point ▲▼ buttons. Keystone adjustment can be memorized. (p41)



- The arrows are white when there is no correction.
- The direction of the arrow being corrected turns red.
- The arrows disappear at the maximum correction.
- If you press the KEYSTONE button on the top control or on the remote control once more while the keystone dialog box is being displayed, the keystone adjustment will be canceled.

Reduce the upper width with Point ▲ button.

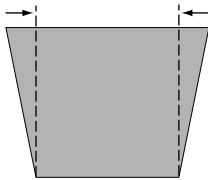

Reduce the lower width with Point ▼ button.

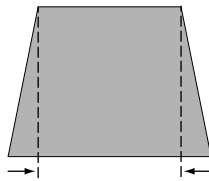

TOP CONTROL

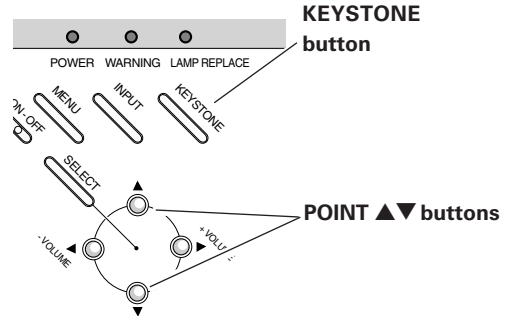

REMOTE CONTROL

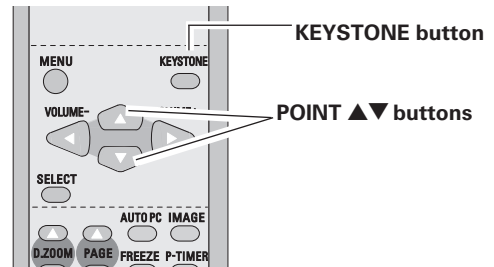

Sound Adjustment

Direct Operation

Volume

Press the VOLUME+/- buttons on the top control or on the remote control to adjust the volume. The volume dialog box will appear on the screen for a few seconds.

Mute

Press the MUTE button on the remote control to cut off the sound. To restore the sound to its previous level, press the MUTE button again or press the VOLUME+/- buttons. Mute function is also effective for AUDIO OUT jack.

Menu Operation

- 1 Press the MENU button to display the On-Screen Menu. Press the Point ◀▶ buttons to move the red framed pointer to the Sound Menu icon.
- 2 Press the Point ▲▼ buttons to move the red framed pointer to the item that you want to select, and then press the SELECT button.

Volume

Press the Point ▶ button to turn up the volume, and press the Point ◀ button to turn down the volume.

Mute

Press the Point ◀▶ buttons to cut off the sound. Dialog box display will be changed to "On" and the sound will be cut off. To restore the sound to its previous level, press the Point ◀▶ buttons again.

TOP CONTROL

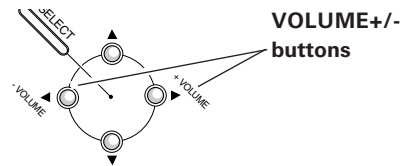

Remote Control

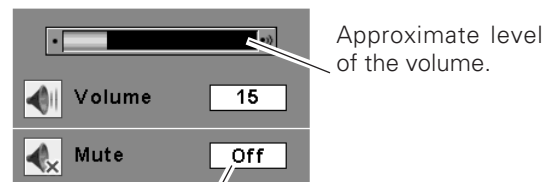
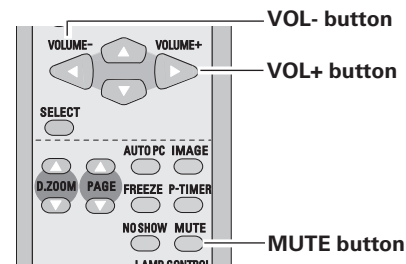

Press the MUTE button to set the Mute function On or Off. The display will disappear after 4 seconds.

Sound Menu

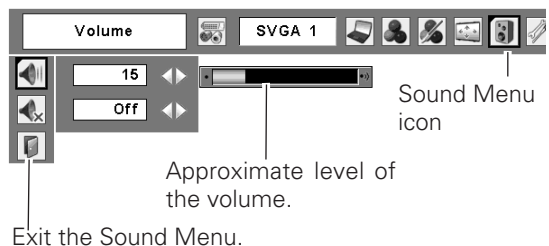

Remote Control Operation

For some frequently used operations, using the remote control is advisable. Just pressing one of the buttons enables you to make the operation, and no need for calling up the On-Screen Menu.

COMPUTER / VIDEO button

Press the COMPUTER or VIDEO button on the remote control to select the input source. For more detail, see p25. 34. 35.

FREEZE button

Press the FREEZE button on the remote control to freeze the picture on the screen. To cancel the Freeze function, press the FREEZE button again or press any other button.

Remote Control

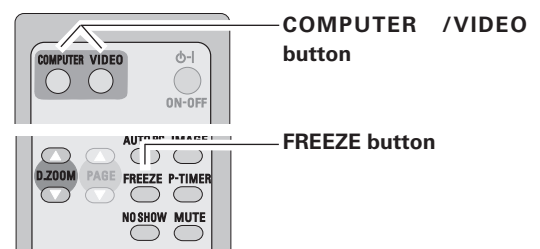

✓ Note:

- See the next page for the other buttons.

AUTO PC button

Press the AUTO PC button on the remote control to operate the Auto PC function.
For more detail, see 27.

D.ZOOM buttons

Press the D.ZOOM buttons on the remote control to zoom in and zoom out the images.
For more detail, see 33.

NO SHOW button

Press the NO SHOW button on the remote control to black out the image. To restore to normal, press the NO SHOW button again or press any other button. When a projected image is captured and set as "User" in the Logo selection (p42), the screen changes each time you press the NO SHOW button as follows.

black out → the captured image → normal →

KEYSTONE button

For detail, see p22.

IMAGE button

Press the IMAGE button on the remote control to select a desired image level of the screen.
For more detail, see p30, 37.

P-TIMER button

Press the P-TIMER button on the remote control. The timer display "00 : 00" will appear on the screen and the timer will start to count time (00 : 00 ~ 59 : 59).

To stop the P-Timer, press the P-TIMER button. Press the P-TIMER button again, then the P-timer display will disappear.

LAMP CONTROL button

Press the LAMP CONTROL button on the remote control to select the lamp mode for changing the brightness of the screen.

- 💡 Normalnormal brightness
- 💡_A Autobrightness according with the input signal
- 💡 Ecolower brightness reduces the lamp power consumption and extends the lamp life.

Remote Control

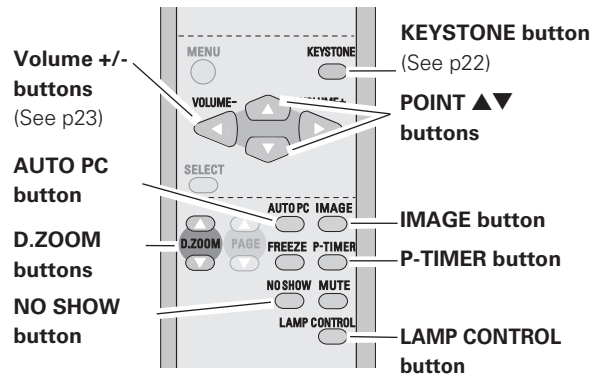

✓ Note:

- See the previous page for the other buttons.

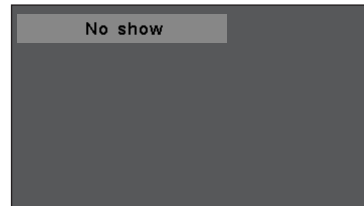

The message will disappear after 4 seconds.



P-Timer display

Computer Input

Input Source Selection

Direct Operation

Choose either Computer 1 or Computer 2 by pressing the INPUT button on the top control or press the COMPUTER button on the remote control.

Before using these buttons, correct input source should be selected through Menu operation as described below.

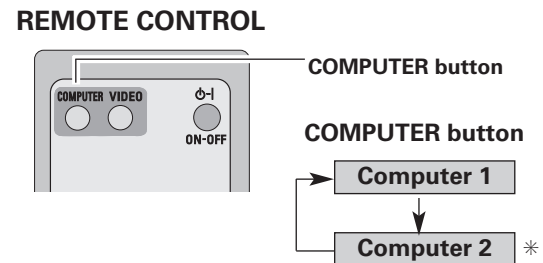
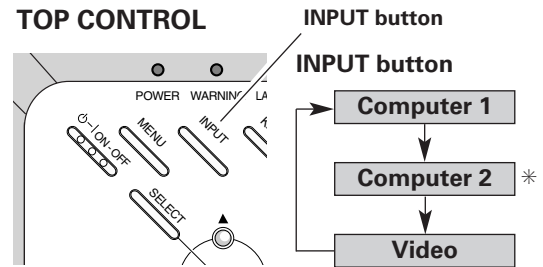

* See Note at the bottom of this page.

Menu Operation

- 1 Press the MENU button to display the On-Screen Menu. Press the Point ◀▶ buttons to move the red framed pointer to the Input Menu icon.
- 2 Press the Point ▲▼ buttons to move the red arrow pointer to either Computer 1 or Computer 2, and then press the SELECT button.
- 3 After the Source Select Menu appeared for Computer 1, move the pointer to RGB and then press the SELECT button.

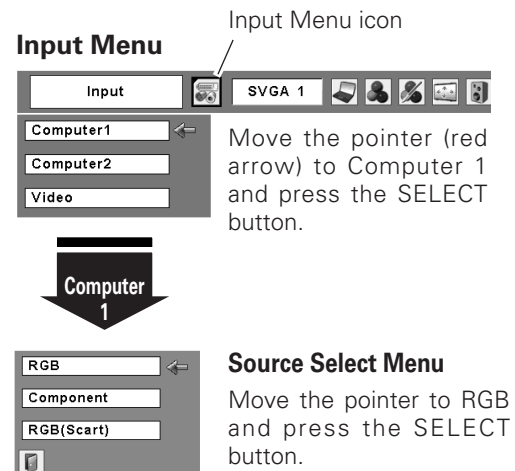

✓Note:

- Computer 2 is not displayed when the COMPUTER IN 2/MONITOR OUT terminal is set as Monitor out. (p44)
- Computer 2 (COMPUTER IN 2 / MONITOR OUT) can accept only RGB signal.

Computer System Selection

This projector automatically tunes to various types of computers based on VGA, SVGA, XGA, SXGA, WXGA or UXGA with its Multi-scan system and Auto PC Adjustment. If Computer is selected as a signal source, this projector automatically detects the signal format and tunes to project a proper image without any additional setting. (Signal formats provided in this projector is shown on page 59)

One of the following messages may appear when:

Auto

The projector cannot recognize the connected signal conforming to the provided PC Systems. The message "Auto" will be displayed on the PC System Menu icon and the Auto PC Adjustment function will work to display proper images. If the image is not projected properly, a manual adjustment is required. (p28, 29)

There is no signal input from computer. Check the connection between your computer and the projector. (See "Troubleshooting" p54)

Mode 1

The preset system is manually adjusted in the PC Adjust Menu. The adjusted data can be stored in Mode 1~5. (p28, 29)

SVGA 1

PC Systems provided in this projector is chosen. The projector chooses a proper system provided in the projector and displays it.

*Mode 1 and SVGA 1 are examples.

PC System Menu

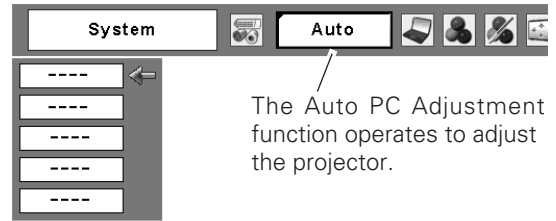

Selecting Computer System Manually

PC system can also be selected manually.

- 1 Press the MENU button to display the On-Screen Menu. Press the Point ◀▶ buttons to move the red framed pointer to the PC System Menu icon.
- 2 Press the Point ▲▼ buttons to move the red arrow pointer to the system that you want to set, and then press the SELECT button.

PC System Menu

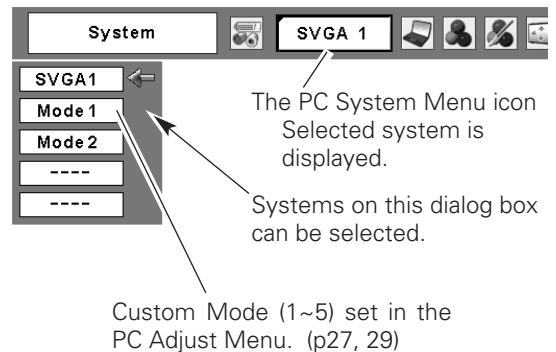

Auto PC Adjustment

Auto PC Adjustment function is provided to automatically adjust Fine sync, Total dots, Horizontal, and Vertical to conform to your computer. Auto PC Adjustment function can be operated as follows.

Direct Operation

The Auto PC adjustment function can be operated directly by pressing the AUTO PC button on the remote control unit.

Remote Control Unit

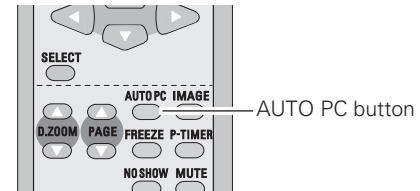

Menu Operation

Auto PC Adj.

- 1 Press the MENU button to display the On-Screen Menu. Press the Point ◀▶ buttons to move the red framed pointer to PC Adjust Menu item.
- 2 Press the Point ▲▼ buttons to move the red framed pointer to Auto PC Adj. item and then press the SELECT button twice.

To store adjustment parameters

Adjustment parameters from Auto PC Adjustment can be memorized in this projector. Once parameters are memorized, the setting can be done just by selecting Mode in the PC System Menu (p26). See "Store" on page 29.

✓ Note:

- Fine sync, Total dots, Horizontal, and Vertical of some computers cannot be fully adjusted with this Auto PC Adjustment function. When the image is not provided properly with this operation, manual adjustments are required. (p28, 29)
- The Auto PC Adjustment cannot be operated when 480i, 575i, 480p, 575p, 720p, 1035i, or 1080i is selected in the PC System Menu (p26)

PC Adjust Menu

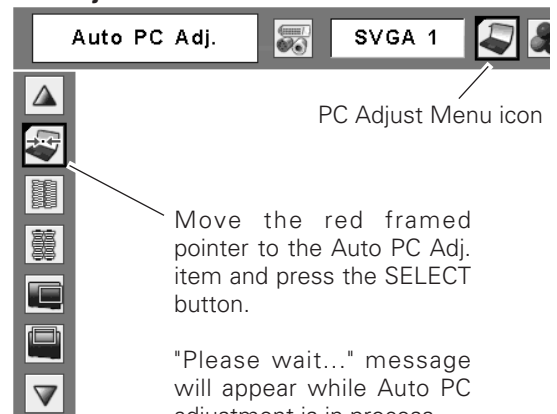

Manual PC Adjustment

Some computers employ special signal formats which may not be tuned by Multi-scan system of this projector. Manual PC Adjustment enables you to precisely adjust several parameters to match those signal formats. The projector has 5 independent memory areas to memorize those parameters manually adjusted. It allows you to recall the setting for a specific computer.

1 Press the MENU button to display the On-Screen Menu. Press the Point ◀▶ buttons to move the red framed pointer to the PC Adjust Menu icon.

2 Press the Point ▲▼ buttons to move the red framed pointer to the item that you want to adjust and then press the SELECT button to display the adjustment dialog box. Press the Point ◀▶ buttons to adjust the value.

Fine sync

Eliminate flicker from the image displayed. Press the Point ◀▶ buttons to adjust the value. (From 0 to 31)

Total dots

Adjust the number of total dots in one horizontal period. Press the Point ◀▶ buttons to adjust number to match your PC image.

Horizontal

Press the Point ◀▶ buttons to adjust the horizontal picture position.

Vertical

Press the Point ◀▶ buttons to adjust the vertical picture position.

Current mode

Press the SELECT button to show H-sync freq. and V-sync freq. of the connected computer.

Clamp

Adjust clamp level. When the image has dark bars, try this adjustment.

PC Adjust Menu PC Adjust Menu icon

Auto PC Adj. SVGA 1

Move the red framed pointer to an item and press the SELECT button.

Status (Stored / Free) of the selected Mode.

Selected Mode

Auto PC Adj. Mode1 Stored

Press the Point ◀▶ buttons to adjust the value.

15 ◀▶

1346 ◀▶

301 ◀▶

39 ◀▶

Press the SELECT button at this item to adjust other items.

Current mode Mode1 Stored

H-sync freq. 48.5

V-sync freq. 60.0

Press the SELECT button at the Current mode item to show the information of the connected computer.

 **Display area H**

Adjust the horizontal area displayed by this projector. Press the Point ◀▶ buttons to decrease/increase the value.

 **Display area V**

Adjust the vertical area displayed by this projector. Press the Point ◀▶ buttons to decrease/increase the value.

 **Reset**

To reset the adjusted data, select Reset and press the SELECT button. The confirmation box will appear and then select [Yes]. All adjustments will return to their previous figures.

 **Mode free**

To clear the stored data, move the red framed pointer to the Mode free item and then press the SELECT button. Move the red arrow pointer to the Mode that you want to clear and then press the SELECT button.

 **Store**

To store adjusted data, move the red framed pointer to the Store item and then press the SELECT button. Move the red arrow pointer to any of Mode 1 to 5 in which you want to store and then press the SELECT button.

 **Quit**

Exit the PC Adjust Menu.

✓Note:

Display area (H/V) cannot be selected when 480i, 575i, 480p, 575p, 720p, 1035i, or 1080i is selected in the PC System Menu (p26).

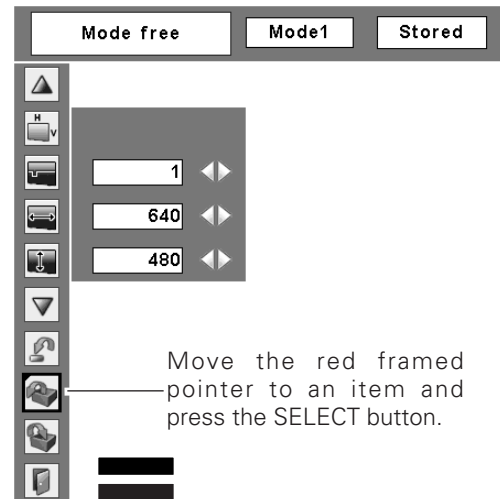

To clear adjusted data This Mode has stored parameters.

Where to free?

Mode1	Stored	800	142	34	1024	768
Mode2	Free	800	142	34	1024	768
Mode3	Free	800	142	34	1024	768
Mode4	Free	800	142	34	1024	768
Mode5	Free	800	142	34	1024	768

Vacant Mode

Values of "Total dots," "Horizontal," "Vertical," "Display area H," and "Display area V."

To store adjusted data

Where to store?

Mode1	Stored	800	142	34	1024	768
Mode2	Free	800	142	34	1024	768
Mode3	Free	800	142	34	1024	768
Mode4	Free	800	142	34	1024	768
Mode5	Free	800	142	34	1024	768

Close this dialog box.

Image Level Selection

Direct Operation

Select an image level among Dynamic, Standard, Real, Blackboard(Green), Image 1, Image 2, Image 3, and Image 4 by pressing the IMAGE button on the remote control.

Dynamic

Picture level suitable for viewing picture in a bright room.

Standard

Normal picture level preset on this projector.

Real

Picture level with improved halftone for graphics.

Blackboard(Green)

Picture level suitable for the image projected on a blackboard.
This mode assists to enhance the image projected on a blackboard. This is mainly effective on a green colored board, not truly effective on a black colored board.

Image 1~4

User preset image in the Image Adjust Menu (p32).

Remote Control

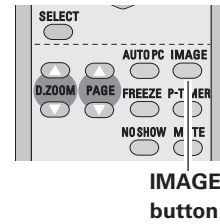
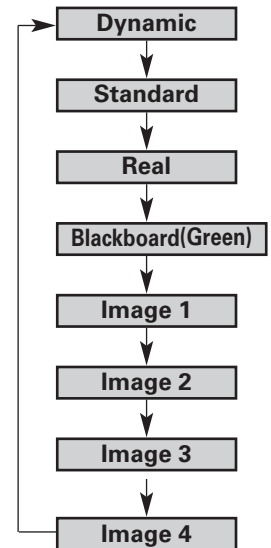

IMAGE button



Menu Operation

- 1 Press the MENU button to display the On-Screen Menu. Press the Point ◀▶ buttons to move the red framed pointer to the Image Select Menu icon.
- 2 Press the Point ▲▼ buttons to move the red framed pointer to the level that you want to set and then press the SELECT button.

Dynamic

Picture level suitable for viewing picture in a bright room.

Standard

Normal picture level preset on this projector.

Real

Picture level with improved halftone for graphics.

Blackboard(Green)

Picture level suitable for the image projected on a blackboard. See above for further description.

Image 1~4

User preset image in the Image Adjust Menu (p32).

Image Select Menu

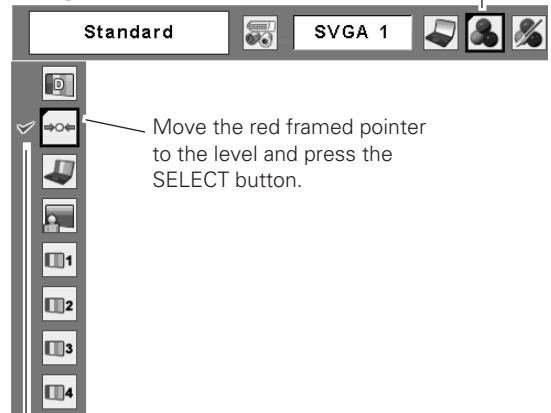

The level being selected.

Image Level Adjustment

- 1 Press the MENU button to display the On-Screen Menu. Press the Point ◀▶ buttons to move the red framed pointer to the Image Adjust Menu icon.
- 2 Press the Point ▲▼ buttons to move the red framed pointer to the item that you want to adjust, and then press the SELECT button. The level of each item is displayed. Adjust each level by pressing the Point ◀▶ buttons.

Contrast

Press the Point ◀ button to decrease the contrast and the Point ▶ button to increase contrast. (From 0 to 63.)

Brightness

Press the Point ◀ button to adjust the image darker and the Point ▶ button to adjust the image brighter. (From 0 to 63.)

Color temp.

Press the Point ◀ button or the Point ▶ button for Color temp. level that you want to select. (XLow, Low, Mid, or High)

White balance (Red)

Press the Point ◀ button to lighten the red tone and the Point ▶ button to deepen the red tone. (From 0 to 63.)

White balance (Green)

Press the Point ◀ button to lighten the green tone and the Point ▶ button to deepen the green tone. (From 0 to 63.)

White balance (Blue)

Press the Point ◀ button to lighten the blue tone and the Point ▶ button to deepen the blue tone. (From 0 to 63.)

Sharpness

Press the Point ◀ button to soften the image and the Point ▶ button to sharpen the image. (From 0 to 15.)

Gamma

Press the Point ◀▶ buttons to obtain better balance of contrast. (From 0 to 15.)

Reset

To reset the adjusted data, select Reset and press the SELECT button. The confirmation box will appear and then select [Yes]. All adjustments will return to their previous figures.

Image Adjust Menu

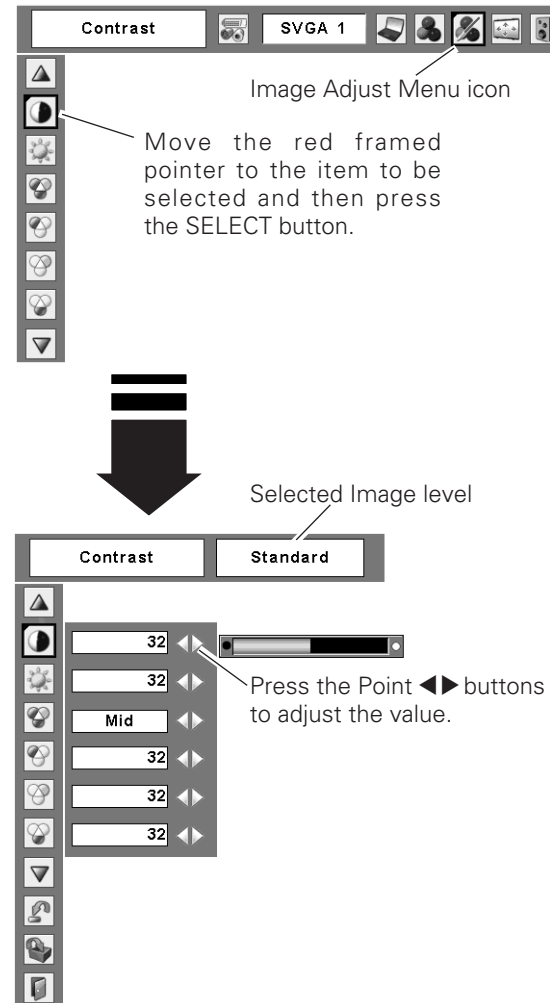

✓ Note:

After adjusting any of the White balance Red, Green or Blue, the Color temp will change to "Adj."

Store

To store the adjusted data, select Store and press the SELECT button. Select a level from Image 1 to 4 with the Point ▲▼ buttons and press the SELECT button. A confirmation box will appear and then select [Yes]. Stored data can be called up by selecting "Image" in the Image Level Selection on page 30.

Quit

Exit the Image Adjust Menu.

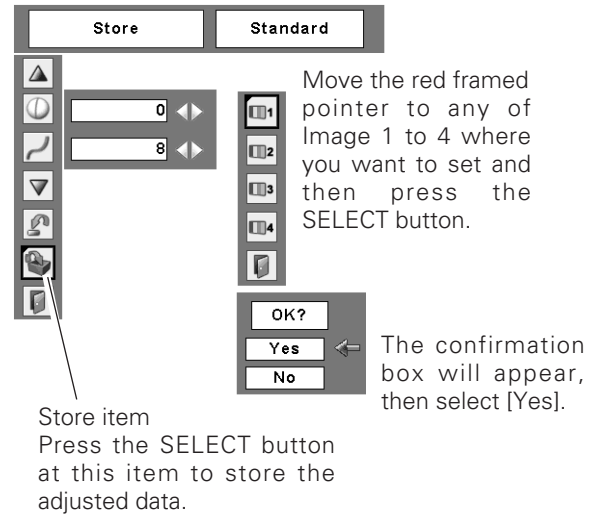

Screen Size Adjustment

This projector has the picture screen resize function, which enables you to customize the image size.

- 1 Press the MENU button to display the On-Screen Menu. Press the Point ◀▶ buttons to move the red framed pointer to the Screen Menu icon.
- 2 Press the Point ▲▼ buttons and move the red framed pointer to the function that you want to select and then press the SELECT button.

Normal

Provide the image to fit the screen size.

True

Provide the image in its original size. When the original image size is larger than the screen size (1024 x 768 for PLC-XU73/PLC-XU70, 800 x 600 for PLC-SU70), this projector enters panning mode automatically. Pan the image with Point ▲▼◀▶ buttons. When adjusted, the arrows will turn red. When reached to the correction limit, the arrows will disappear.

Wide

Provide the image to fit wide video aspect ratio (16 : 9) by expanding the image width uniformly. This function can be used for providing a squeezed video signal at 16 : 9.

Full screen

Provide the full screen image.

Screen Menu

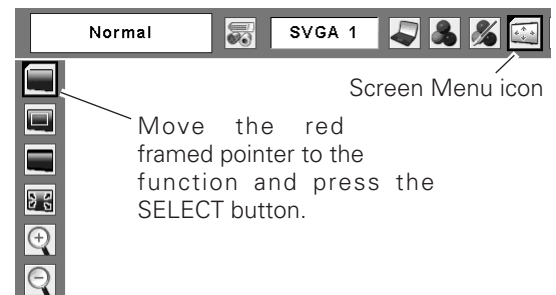

✓ Note:

- This Screen Menu cannot be operated when 720p(HDTV), 1035i (HDTV), or 1080i (HDTV) is selected in the PC System Menu (p26).
- The projector cannot display any resolution higher than 1280 X 1024. If your computer's screen resolution is higher than it, reset the resolution to the lower before connecting to the projector.
- The image data in other than XGA (1024 x 768 for PLC-XU73/ PLC-XU70) or SVGA (800 x 600 for PLC-SU70) is modified to fit the screen size in initial mode.
- True, Full screen, and Digital zoom +/- cannot be selected when 480i, 575i, 480p, or 575p is selected in the PC System Menu (p26).

For zooming in and out the images

Digital zoom +

When the Digital zoom + is selected, the On-Screen Menu will disappear and the message "D. zoom +" will be displayed. Press the SELECT button to expand the image size. And press the Point ▲▼◀▶ buttons to pan the image. The Panning function can work only when the image is larger than the screen size.

A projected image can be also expanded by pressing the D.ZOOM ▲ button on the remote control.

Digital zoom -

When Digital zoom - is selected, the On-Screen Menu will disappear and the message "D. zoom -" will be displayed. Press the SELECT button to compress image size.

A projected image can be also compressed by pressing the D.ZOOM ▼ button on the remote control.

To exit the Digital zoom +/- mode, press any button except the D.ZOOM ▲▼ buttons, SELECT, and Point button.

To return to the previous screen size, select a screen size from the Screen Size Adjustment or select an input source from the Input Source Selection (p25) again, or adjust the screen size with the D.ZOOM ▲▼ buttons.

Remote Control

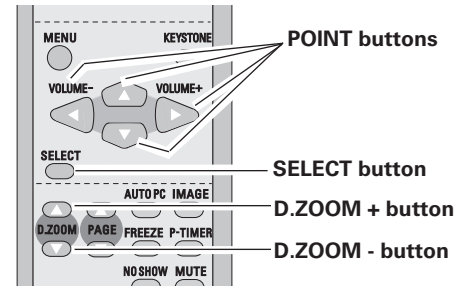

✓ Note:

- The panning function may not operate properly if the stored Mode in the PC Adjust Menu is used. (p29)
- The minimum compression ratio can be limited depending on the input signal or when the Keystone function is working.
- True, Full screen, and Digital zoom +/- cannot be selected when 480i, 575i, 480p, or 575p is selected in the PC System Menu (p26).
- Digital zoom +/- cannot be selected when Full screen or True is selected.

Video Input

Input Source Selection (Video, S-Video)

Direct Operation

Choose Video by pressing the INPUT button on the top control or the VIDEO button on the remote control. Before using these buttons, correct input source should be selected through menu operation as described below.

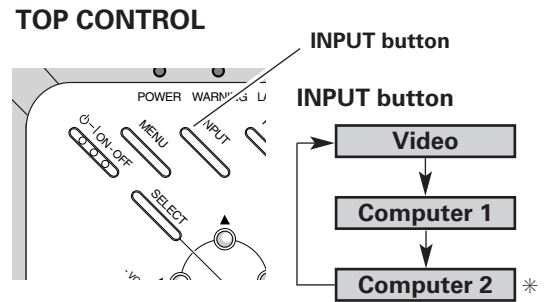

* See Note at the bottom of this page.

REMOTE CONTROL

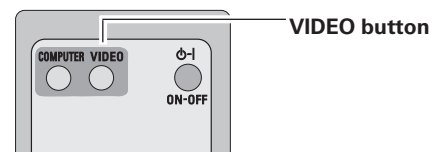

Menu Operation

- 1 Press the MENU button to display the On-Screen Menu. Press the Point ◀▶ buttons to move the red framed pointer to the Input Menu icon.
- 2 Press the Point ▲▼ buttons to move the red arrow pointer to Video and then press the SELECT button to display the Source Select Menu .
- 3 Move the pointer to the source that you want to select and then press the SELECT button.

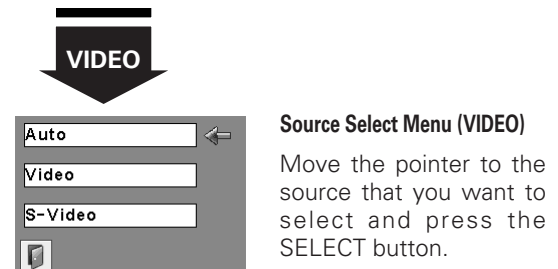
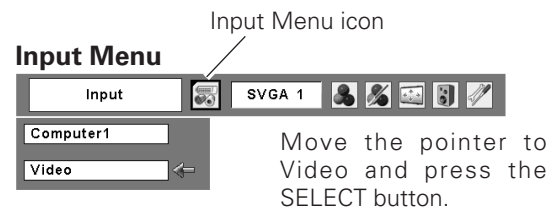

Auto When selecting Auto, the projector automatically detects incoming video signal, and adjusts itself to optimize its performance. The projector selects connection in the following order:

1. S-Video
2. Video

Video When video input signal is connected to the VIDEO jack, select Video.

S-Video When video input signal is connected to the S-VIDEO jack, select S-Video.

✓Note:

When Monitor out is selected in the Terminal function (p44), Computer 2 is not displayed.

Input Source Selection (Component, RGB Scart 21-pin)

Direct Operation

Choose Computer 1 by pressing the INPUT button on the top control or press the COMPUTER button on the remote control.

Before using these buttons, correct input source should be selected through Menu operation as described below.

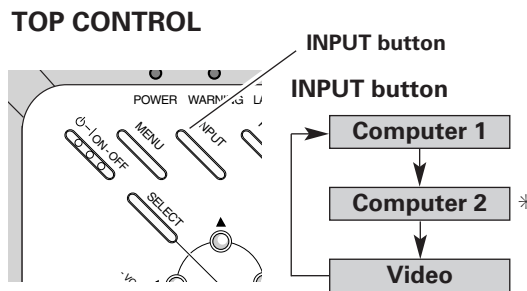

REMOTE CONTROL

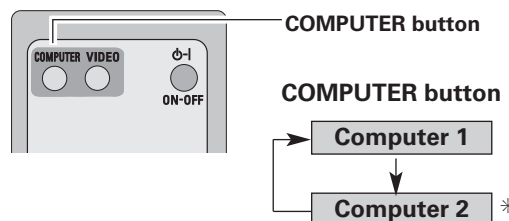

* See Note at the bottom of this page.

Menu Operation

- 1 Press the MENU button to display the On-Screen Menu. Press the Point ◀▶ buttons to move the red framed pointer to the Input Menu icon.
- 2 Press the Point ▲▼ buttons to move the red arrow pointer to Computer 1 and then press the SELECT button.
- 3 After the Source Select Menu appeared for Computer 1, move the pointer to Component or RGB(Scart) and then press the SELECT button.

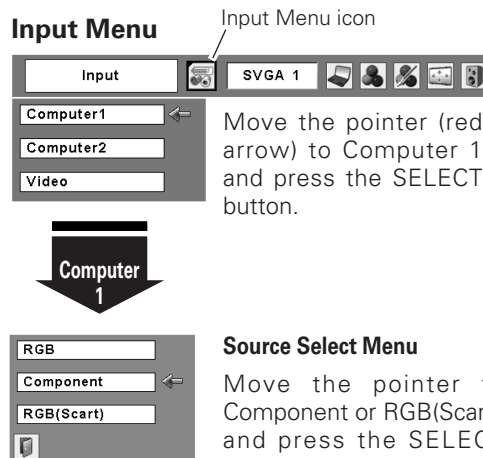

Component

When the input source is coming from video equipment connected to the COMPUTER IN 1 / COMPONENT IN terminal with a Component-VGA Cable, select Component.

RGB (Scart)

When the input source is coming from video equipment connected to the COMPUTER IN 1 / COMPONENT IN terminal with a Scart-VGA Cable, select RGB (Scart).

Video System Selection

- 1 Press the MENU button to display the On-Screen Menu. Press the Point ◀▶ buttons to move the red framed pointer to the AV System Menu icon.
- 2 Press the Point ▲▼ buttons to move the red arrow pointer to the system that you want to select and then press the SELECT button.

Video or S-Video

Auto

The projector automatically detects incoming video system, and adjusts itself to optimize its performance. When Video System is PAL-M or PAL-N, select system manually.

PAL / SECAM / NTSC / NTSC4.43 / PAL-M / PAL-N

If the projector cannot reproduce proper video image, it is necessary to select a specific broadcast signal format among PAL, SECAM, NTSC, NTSC 4.43, PAL-M, and PAL-N.

Component

Auto

The projector automatically detects incoming video signal, and adjusts itself to optimize its performance.

COMPONENT VIDEO SIGNAL FORMAT

If the projector cannot reproduce proper video image, it is necessary to select a specific component video signal format among 480i, 575i, 480p, 575p, 720p, 1035i, and 1080i.

✓ **Note:**

The AV System Menu cannot be selected when selecting RGB(Scart).

AV System Menu (Video or S-Video)

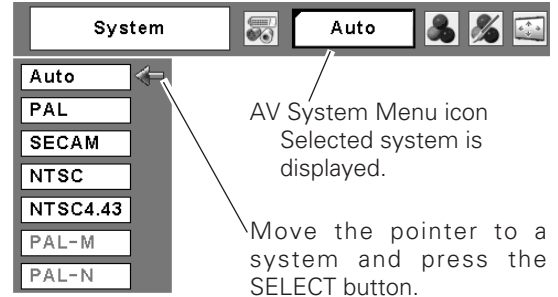

AV System Menu (Component)

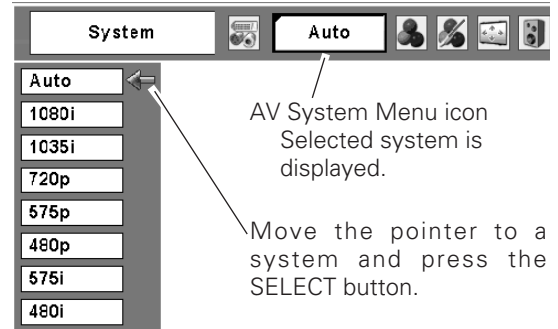

Image Level Selection

Direct Operation

Select a desired image level among Dynamic, Standard, Cinema, Blackboard (Green), Image 1, Image 2, Image 3, and Image 4 by pressing the IMAGE button on the remote control.

Dynamic

Picture level suitable for viewing picture in a bright room.

Standard

Normal picture level preset on this projector.

Cinema

Picture level adjusted for the picture with fine tone.

Blackboard(Green)

Picture level suitable for the image projected on a blackboard.

This mode assists to enhance the image projected on a blackboard. This is mainly effective on a green colored board, not truly effective on a black colored board.

Image 1~4

User preset image in the Image Adjust Menu (p38, 39).

Menu Operation

- 1 Press the MENU button to display the On-Screen Menu. Press the Point ◀▶ buttons to move the red framed pointer to the Image Select Menu icon.
- 2 Press the Point ▲▼ buttons to move the red framed pointer to the level that you want to set and then press the SELECT button.

Dynamic

Picture level suitable for viewing picture in a bright room.

Standard

Normal picture level preset on this projector.

Cinema

Picture level adjusted for the picture with fine tone.

Blackboard(Green)

Picture level suitable for the image projected on a Blackboard. See above for further description.

Image1~4

User preset image in the Image Adjust Menu (p38, 39).

Remote Control

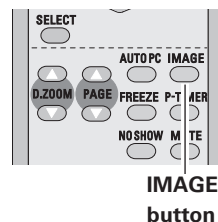

IMAGE button

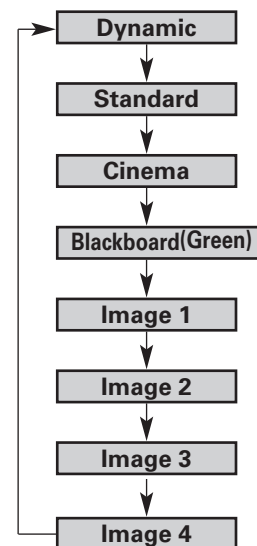
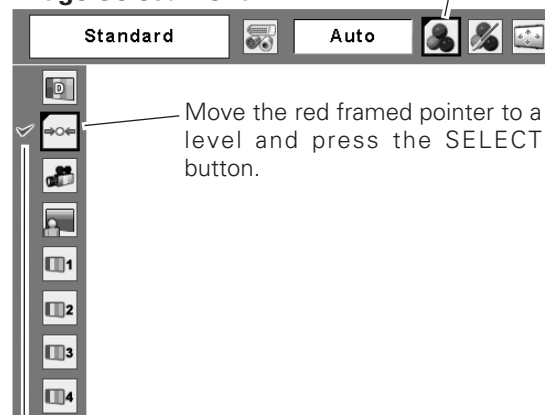

Image Select Menu



The level being selected.

Image Level Adjustment

- 1 Press the MENU button to display the On-Screen Menu. Press the Point ◀▶ buttons to move the red framed pointer to the Image Adjust Menu icon.
- 2 Press the Point ▲▼ buttons to move the red framed pointer to the item that you want to adjust and then press the SELECT button. The level of each item is displayed. Adjust each level by pressing the Point ◀▶ buttons.

Contrast

Press the Point ◀ button to decrease the contrast and the Point ▶ button to increase contrast. (From 0 to 63.)

Brightness

Press the Point ◀ button to adjust the image darker and the Point ▶ button to adjust the image brighter. (From 0 to 63.)

Color

Press the Point ◀ button to lighten the color and the Point ▶ button to deepen the color. (From 0 to 63.)

Tint

Press the Point ◀▶ buttons to obtain a proper color. (From 0 to 63.)

Color temp.

Press the Point ◀▶ buttons for Color temp. level that you want to select. (XLow, Low, Mid, or High)

White balance (Red)

Press the Point ◀ button to lighten the red tone and the Point ▶ button to deepen the red tone. (From 0 to 63.)

White balance (Green)

Press the Point ◀ button to lighten the green tone and the Point ▶ button to deepen the green tone. (From 0 to 63.)

White balance (Blue)

Press the Point ◀ button to lighten the blue tone and the Point ▶ button to deepen the blue tone. (From 0 to 63.)

✓ **Note:**

- The Tint cannot be selected when the video system is PAL, SECAM, PAL-M, or PAL-N.
- After adjusting any of the White balance Red, Green or Blue, the Color temp. will change to "Adj."

Image Adjust Menu

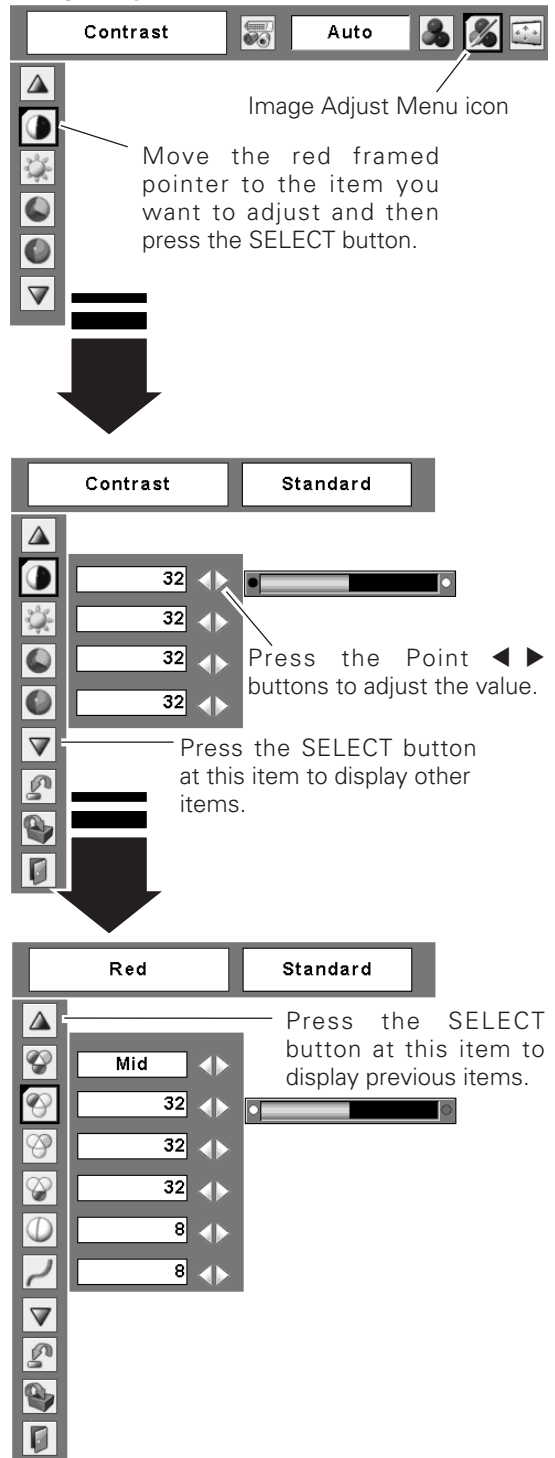

 **Sharpness**

Press the Point ◀ button to soften the image and the Point ▶ button to sharpen the image. (From 0 to 15.)

 **Gamma**

Press the Point ◀▶ buttons to obtain better balance of contrast. (From 0 to 15.)

 **Noise reduction**

Noise interference on the screen can be reduced. Select one of the following to get smoother images.

- Off.....disabled.
- L1.....lower reduction
- L2.....higher reduction

 **Progressive**

Interlaced video signal can be displayed in a progressive picture. Select one of the following.

- Off.....disabled.
- L1.....Select "L1" for an active picture.
- L2.....Select "L2" for a still picture.
- Film.....Select "Film" for watching a film. With this function, the projector reproduces pictures faithful to the original film quality.

 **Reset**

To reset the adjusted data, select Reset and press the SELECT button. The confirmation box will appear and then select [Yes]. All adjustments will return to their previous figures.

 **Store**

To store the adjusted data, select Store and press the SELECT button. Select a level from Image 1 to 4 with the Point ▲▼ buttons and press the SELECT button. A confirmation box will appear and then select [Yes]. Stored data can be called up by selecting "Image" in the Image Level Selection on page 37.

 **Quit**

Exit the Image Adjust Menu.

✓ **Note:**

Noise reduction and Progressive cannot be selected when 480p, 575p, 720p, 1035i, or 1080i is selected. (p36)

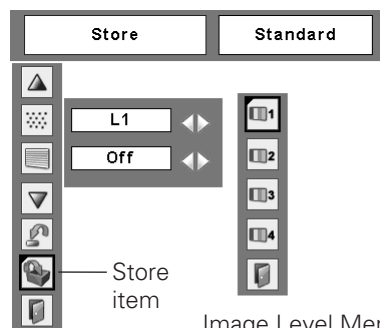
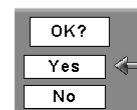

Image Level Menu
Move the red framed pointer to an image item to be set and then press the SELECT button.



The confirmation box will appear and then select [Yes].

Screen Size Adjustment

This projector has the picture screen resize function, which enables you to customize the image size.

- 1 Press the MENU button to display the On-Screen Menu. Press the Point ◀▶ buttons to move the red framed pointer to the Screen Menu icon.
- 2 Press the Point ▲▼ buttons and move the red framed pointer to the function that you want to select and then press the SELECT button.

Screen Menu



Normal

Provide the image at a normal video aspect ratio of 4 : 3.

Wide

Provide the image at a wide screen ratio of 16 : 9.

✓ **Note:**

Screen Menu cannot be operated when 720p, 1035i, or 1080i is selected in the AV System Menu (p36).

Setting

This projector has Setting menu that allows you to set up the other various functions described as follows;

- 1 Press the MENU button to display the On-Screen Menu. Press the Point ◀▶ buttons to move the red framed pointer to the Setting Menu icon.
- 2 Press the Point ▲▼ buttons to move the red framed pointer to the item that you want to set and then press the SELECT button. The Setting dialog box appears.

Language

The language used in the On-Screen Menu is available in English, German, French, Italian, Spanish, Portuguese, Dutch, Swedish, Finnish, Polish, Hungarian, Romanian, Russian, Chinese, Korean, or Japanese.

Keystone

This function corrects distortion of a projected image. Select either Store or Reset with the Point ◀▶ buttons, and then press the SELECT button. The keystone dialog box will appear. Correct keystone with the Point ▲▼ buttons. (p22)

- Storestore the keystone correction even when the AC power cord is unplugged.
- Resetreset the keystone correction when the AC power cord is unplugged.

Blue back

Press the Point ◀▶ buttons to switch On/Off. When this function is "On," a blue image is displayed while the input signal is not detected.

Display

Press the Point ◀▶ buttons to switch On/Off. This function decides to display On-Screen Displays.

- OnShow all the On-Screen Displays. Use this function when you want to project images after the lamp becomes bright enough. Factory default setting is this mode.
- Countdown offShow the input image instead of the countdown when turning on the projector. Use this function when you want to project the image as early as possible even when the lamp is not bright enough.
- OffDo not show On-Screen Displays. except;

- On-Screen Menu
- "Power off?" message
- P-Timer
- "No signal" message for Power management item (p44)
- "Please wait..." message
- White arrows for True item in the Screen Menu (p32)

Setting Menu (Language)

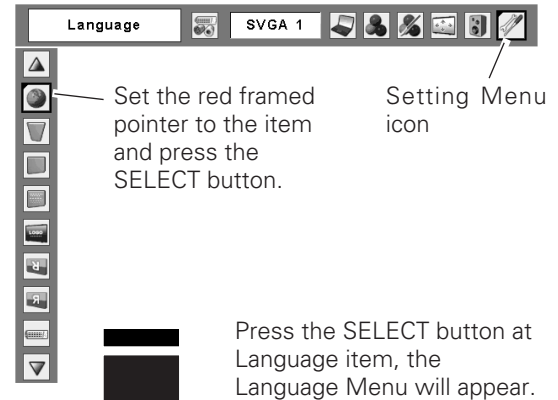

Press the SELECT button at Language item, the Language Menu will appear.

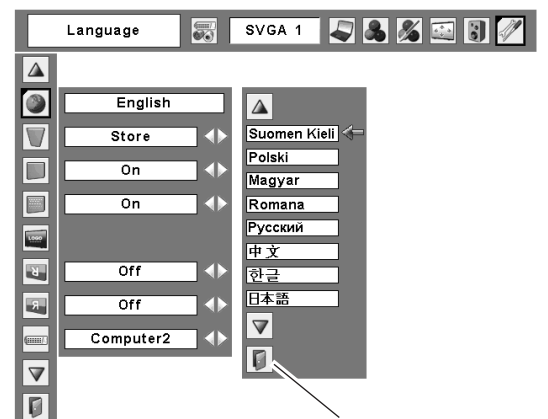
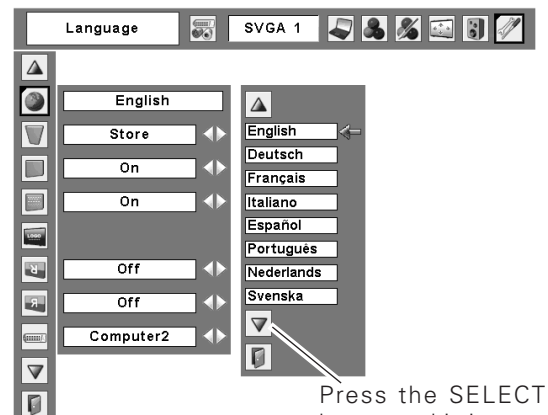

Logo (Logo and Logo PIN code lock settings)

This function allows you to customize the screen logo with Logo select, Capture, and Logo PIN code lock functions.

✓ Note:

When On is selected in Logo PIN code lock function, Logo select and Capture functions cannot be selected.

Logo select

This function decides the start-up display as follows:

Userthe image you captured

Defaultthe factory-set logo

Off.....countdown only

Capture

This function enables you to capture the image being projected and use it for a start-up display or interval of presentations.

After capturing the projected image, go to the Logo select function and set it to "User". Then the captured image will be displayed when turning on the projector next time or pressing the NO SHOW button. (p24)

To capture the image, select [Yes]. To cancel the Capture function, select [No].

✓ Note:

- Before capturing an image, select Standard in the Image Select Menu to capture a proper image. (p30, 37.)
- A signal from a computer can be captured up to XGA(1024 x 768). A signal from video equipment can be captured except for 720p, 1035i, and 1080i.
- When capturing the image that has been adjusted by the Keystone function, the adjustment data is automatically reset and the projector captures an image without keystone adjustment.
- When the Logo PIN code lock function is On, Capture menu cannot be selected.
- When starting to capture a new image, the previously stored image is cleared even if you cancel the capturing.

Logo select

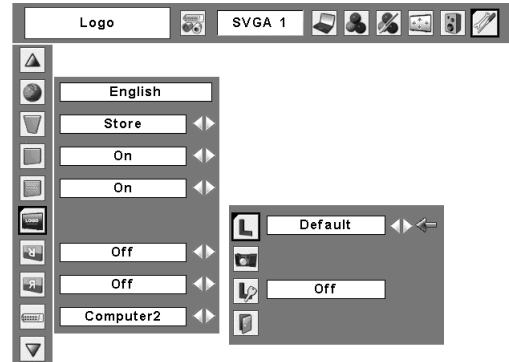

Capture

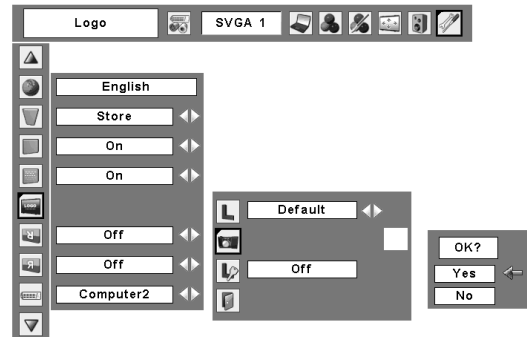

Select [Yes] to capture the projected image.

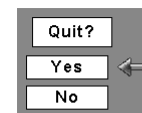

Select [Yes] to stop capturing.



 **Logo PIN code lock**

This function prevents an unauthorized person from changing the screen logo.

- Off.....the screen logo can be changed freely from the Logo select menu. (p42)
- On.....the screen logo cannot be changed without the Logo PIN code.

If you want to change the Logo PIN code lock setting, enter a Logo PIN code along the following steps. The initial Logo PIN code is set "4321" at the factory.

Enter a Logo PIN code

Select a number by pressing the Point ◀▶ buttons and fix the number with the SELECT button. The number will change to "*". If you fixed an incorrect number, move the pointer to "Set" or "Clear" once by pressing the Point ▼ button, then return to "Logo PIN code". Enter the correct number again.

Repeat this step to complete entering a four-digit number.

When the four-digit number is fixed, the pointer will automatically move to "Set". Press the SELECT button so that you can change the Logo PIN code lock setting.

If you entered an incorrect Logo PIN code, "Logo PIN code" and the number (****) will turn red and disappear. Enter a correct Logo PIN code all over again.

Change the Logo PIN code

Logo PIN code can be changed to your desired four-digit number. Select "Logo PIN code change" with the Point ▼ button and press the SELECT button. Set a new Logo PIN code.

Be sure to note the new Logo PIN code and keep it at hand. If you lost the number, you could no longer change the Logo PIN code setting. For details on PIN code setting, refer to relevant instructions of the PIN code lock function on page 46, 47.

CAUTION:
WHEN YOU HAVE CHANGED THE LOGO PIN CODE, WRITE DOWN THE NEW PIN CODE IN COLUMN OF THE LOGO PIN CODE NO. MEMO ON PAGE 63, AND KEEP IT SECURELY. SHOULD THE LOGO PIN CODE BE LOST OR FORGOTTEN, THE PROJECTOR CAN NO LONGER BE OPERATED.

Logo PIN code lock

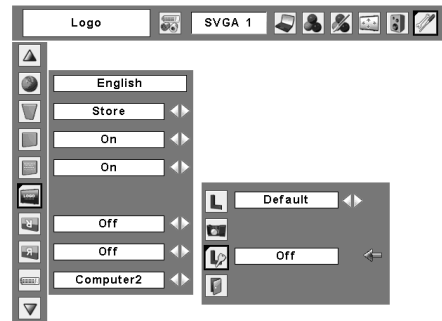

Logo PIN code lock Dialog Box

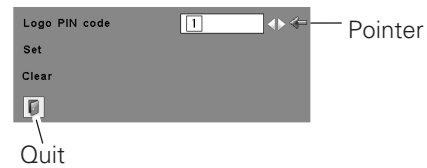

After a correct Logo PIN code is entered, the following dialog box will appear.



Select On/Off by pressing the Point ◀▶ buttons or change the Logo PIN code.

 **Ceiling**

When this function is "On," the picture will be top/bottom and left/right reversed. This function is used to project the image from a ceiling mounting the projector.

 **Rear**

When this function is "On," the picture will be left/right reversed. This function is used to project the image to a rear projection screen.

 **Terminal**

The COMPUTER IN 2/MONITOR OUT terminal on the back of the projector is switchable for computer input or monitor output. (See page 9) Select Computer 2 or Monitor Out with the Point ◀▶ buttons.

- Computer 2computer input
- Monitor Out . . .monitor out

Terminal function is not available when selecting Computer 2 to the input source. Change the input source to the others (Computer1 or Video) so that the Terminal function will be available. (p25, 34, 35)

 **Power management**

For reducing power consumption as well as maintaining the lamp life, the Power management function turns off the projection lamp when the input signal is interrupted and no button is pressed for a certain period.

When the input signal is interrupted and no button is pressed for 30 seconds or more, the timer display with "No signal" message will appear. The countdown will start to turn off the lamp.

Select one of the operations.

- ReadyWhen the lamp has been fully cooled down, the POWER indicator changes to green blinking. In this condition, the projection lamp will be turned on if the input signal is reconnected or any button on the top control or remote control unit is pressed.
- Shut downWhen the lamp has been fully cooled down, the power will be turned off.
- OffPower management function is off.

Then set the countdown timer with the Point ◀▶ buttons.

Ceiling

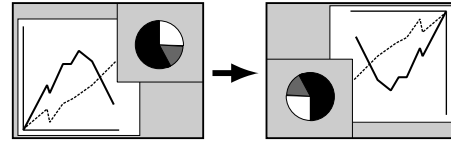

Rear

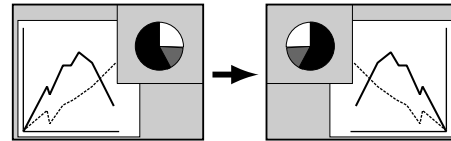

Power management



Time left before Lamp is off.

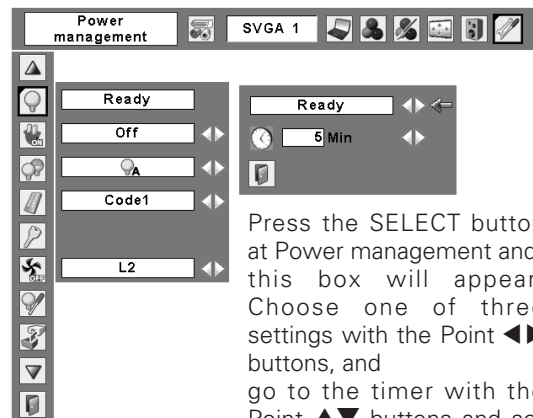

Press the SELECT button at Power management and this box will appear. Choose one of three settings with the Point ◀▶ buttons, and go to the timer with the Point ▲▼ buttons and set time with the Point ◀▶ buttons.

 **On start**



When this function is "On", the projector will be automatically turned on just by connecting the AC power cord to a wall outlet.

✓ **Note:**

Be sure to turn the projector off properly (see "Turning Off the Projector" on page 19). If the projector is turned off in the incorrect sequence, the On start function does not operate properly.

 **Lamp control**

This function allows you to change brightness of the screen.

-  Normalnormal brightness
-  Autobrightness according with the input signal
-  Ecolower brightness reduces the lamp power consumption and extends the lamp life.

 **Remote control**

This projector provides two different remote control codes; the factory-set, initial code (Code 1) and the secondary code (Code 2). This switching function prevents remote control interference when operating several projectors or video equipment at the same time.

When operating the projector in "Code 2", both the projector and the remote control must be switched to "Code 2".

To change the code for the projector;

Select either "Code 1" or "Code 2" in this Setting Menu.

To change the code for the remote control;

Press and hold both the MENU and IMAGE buttons together for 10 seconds or more. After changing the code, make sure the remote control operates properly.

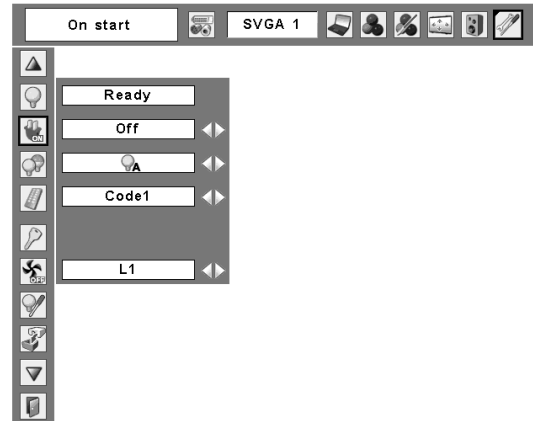

Remote control

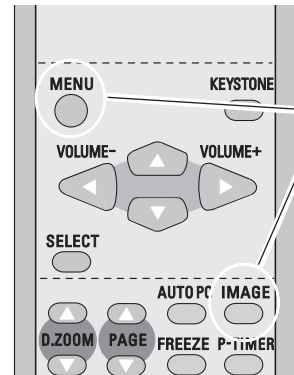



Press and hold MENU and IMAGE buttons for 10 seconds or more.

 **Security (Key lock and PIN code lock settings)**

This function allows you to use Key lock and PIN code lock function to set the security for the projector operation.

 **Key lock**

This function locks operation of the top control or the remote control. It is useful to prevent operation by an unauthorized person.

-  not locked.
-  lock the operation of the top control.
To unlock, use the remote control.
-  lock the operation of the remote control.
To unlock, use the top control.

If the top control accidentally becomes locked and you do not have the remote control nearby, disconnect the AC power cord from the AC outlet, and then with pressing the SELECT button, reinsert the AC power cord. This will cancel the top control lock.

 **PIN code lock**

This function prevents the projector from being operated by an unauthorized person and provides the following settings for security options.

- Off.....the projector is not locked with the PIN code.
- On1require to enter the PIN code every time turning on the projector.
- On2require to enter the PIN code to operate the projector once the power cord is disconnected; as long as the AC power cord is connected, the projector can be operated without the PIN code.

Whenever to change the PIN code lock setting or the PIN code (the four-digit number), you are required to enter the PIN code. "1234" is set as the initial PIN code at the factory.

Key lock

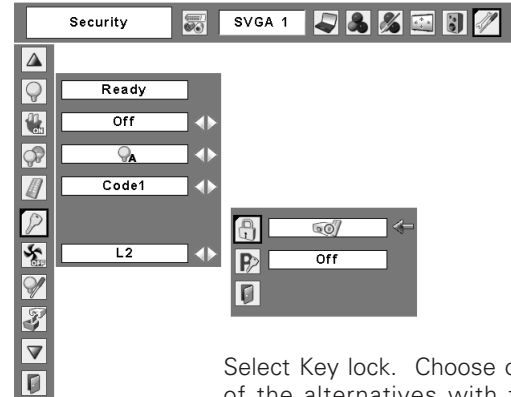

Select Key lock. Choose one of the alternatives with the Point ▲▼ buttons and select [Yes] to activate it.

PIN code lock

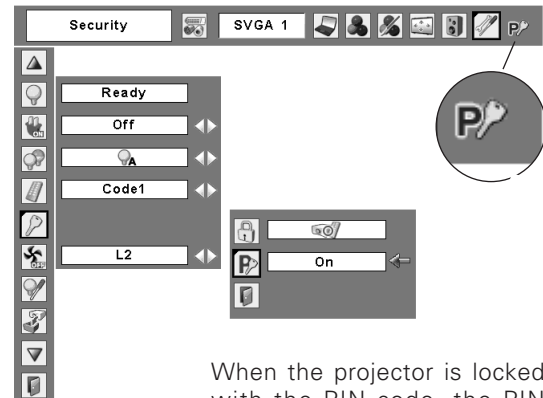

When the projector is locked with the PIN code, the PIN code lock mark appears on the menu bar.

Enter a PIN code

Select a number by pressing the Point ◀▶ buttons and fix the number with the SELECT button. The number will change to "*". If you fixed an incorrect number, move the pointer to "Set" or "Clear" once by pressing the Point ▼ button, then return to "PIN code". Enter the correct number again. Repeat this step to complete entering a four-digit number.

When the four-digit number is fixed, the pointer will automatically move to "Set". Press the SELECT button so that you can change the following PIN code lock settings.

If you entered an incorrect PIN code, "PIN code" and the number (****) will turn red and disappear. Enter a correct PIN code all over again.

To Change the PIN code lock setting

Select Off, On1, or On2 with the Point ◀▶ buttons and then move the red framed pointer to "Quit" with the Point ▼ button. Press the SELECT button to close the dialog box.

To Change the PIN code

The PIN code can be changed to your desired four-digit number. Select "PIN code change" with the Point ▼ button, and press the SELECT button to display the New PIN code input dialog box.

Select a number with the Point ◀▶ buttons and fix the number with the SELECT button. Repeat it to complete entering a four-digit number. When the four-digit number is fixed, the pointer will automatically move to "Set". Then press the SELECT button.

CAUTION:
WHEN YOU HAVE CHANGED THE PIN CODE, WRITE DOWN THE NEW PIN CODE IN COLUMN OF THE PIN CODE NO. MEMO ON PAGE 63, AND KEEP IT SECURELY. IF YOU FORGET YOUR PIN CODE, THE PROJECTOR CAN NO LONGER BE STARTED.

Enter a PIN code

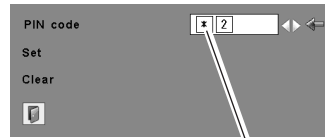

The input numbers change to "*" for security.



When the pointer automatically moves to "Set", press the SELECT button.

Change the PIN code lock setting



Select a desired setting with the Point ◀▶ buttons.

Change the PIN code



Select PIN code change and press the SELECT button. The New PIN code input dialog box will appear.



The input numbers are being displayed for confirmation.

Fan

This function provides the following alternatives in the cooling fans' operation after turning off the projector. (p19)

- L1normal operation
- L2slower and lower-sound than the normal operation (L1), but it takes longer to cool the projector down.

Lamp counter

This function is used to reset the lamp replacement counter. When replacing the projection lamp, reset the lamp replacement counter by using this function. See page 53 for operation.

Factory default

This function returns all setting values except for the user logo, PIN code lock, Logo PIN code lock and the lamp counter to the factory default settings.

Quit

Exit the Setting Menu.

Factory default

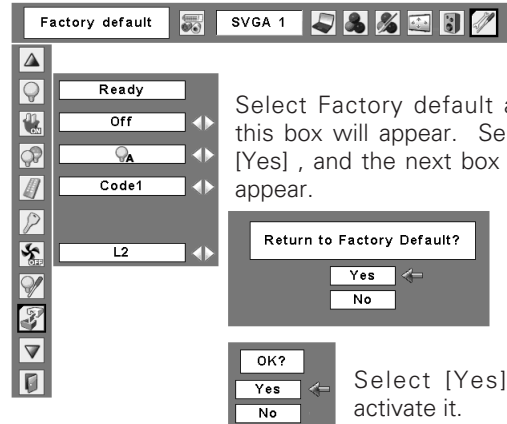

Select Factory default and this box will appear. Select [Yes] , and the next box will appear.

Select [Yes] to activate it.

Maintenance and Cleaning

Warning Indicator

The WARNING indicator shows the state of the function which protects the projector. Check the state of the WARNING indicator and the POWER indicator to take proper maintenance.

The projector is shut down and the WARNING indicator is blinking red.

When the temperature inside the projector reaches a certain level, the projector will be automatically shut down to protect the inside of the projector. The POWER indicator is blinking while the projector is being cooled down. When the projector has cooled down sufficiently (to its normal operating temperature), it can be turned on again by pressing the POWER ON-OFF button.

✓ **Note:**

After the temperature inside the projector returns to normal, the WARNING indicator still continues to blink. When the projector is turned on again, the WARNING indicator stops blinking.

Then check the matters below:

- Did you provide appropriate space for the projector to be ventilated? Check the installing condition to see if ventilation slots are not blocked.
- Is the projector not installed near the ventilation duct of air-conditioning equipment which may be hot? Install the projector away from the ventilation duct of air-conditioning equipment.
- Are the air filters clean? Clean the air filters periodically. (p50)

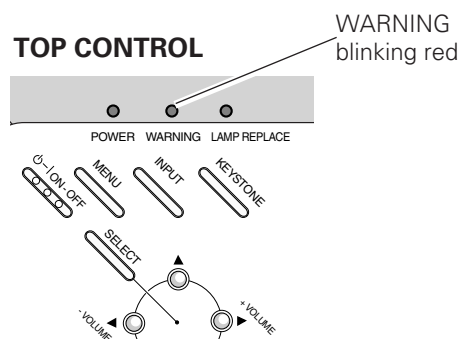

The projector is shut down and the WARNING indicator emits a red light.

When the projector detects an abnormal condition, it is automatically shut down to protect the inside and the WARNING indicator will be red. In this case, disconnect the AC power cord and reconnect it, and then turn the projector on once again for check. If the projector cannot be turned on and the WARNING indicator emits a red light, disconnect the AC power cord and contact the service station for check and repair.

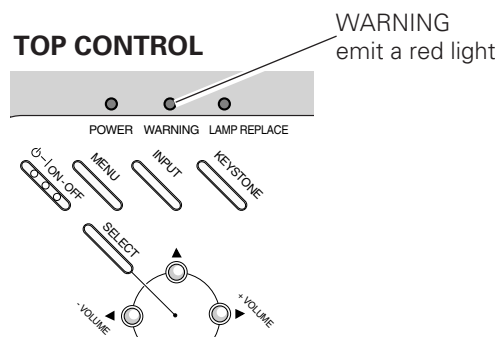

CAUTION

DO NOT LEAVE THE PROJECTOR WITH THE AC POWER CORD CONNECTED UNDER THE ABNORMAL CONDITION. IT MAY RESULT IN FIRE OR ELECTRIC SHOCK.

Cleaning the Air Filters

Air filters prevent dust from accumulating on the optical elements inside the projector. Should the air filters become clogged with dust particles, it will reduce cooling fans' effectiveness and may result in internal heat build up and adversely affect the life of the projector. Clean the air filters following the steps below.

- 1 Turn off the projector, and disconnect the AC power cord from the AC outlet.
- 2 Turn over the projector and remove the air filters by pulling the latches upward.
- 3 Clean the air filters with a brush or rinse them softly.
- 4 When cleaning the air filters by rinsing, dry them well. Replace the air filters properly. Make sure that the air filters are fully inserted.



CAUTION

Do not operate the projector with the air filters removed. Dust may accumulate on the optical elements degrading picture quality. Do not put small parts into the air intake vents. It may result in malfunction of the projector.

RECOMMENDATION

We recommend avoiding dusty/smoky environments when operating the projector. Usage in these environments may cause poor image quality.

When using the projector under dusty or smoky conditions, dust may accumulate on a lens, LCD panels, or optical elements inside the projector. This condition may degrade the quality of a projected image.

When the symptoms above are noticed, contact your authorized dealer or service station for proper cleaning.

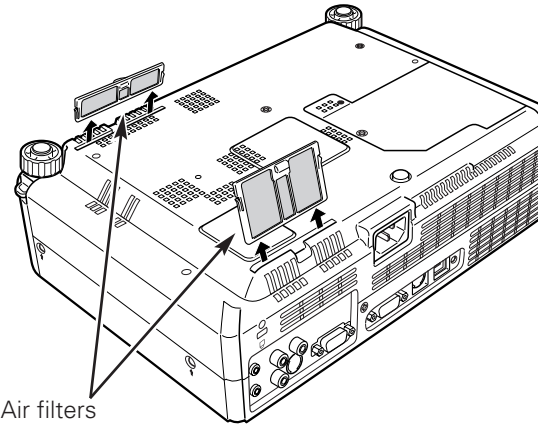

Air filters
Pull up and remove.

✓ Note:

When reinserting this air filter, be sure that the slit part is facing the outer side.

Attaching the Lens Cover

When moving this projector or while not using it over an extended period of time, replace the lens cover.

Attach the lens cover according to the following procedures.

- 1 Pass the string through a hole of the lens cover.
- 2 Turn over the projector and remove the screw with a screwdriver.
- 3 Attach the string with lens cover to a hole at the bottom of the projector and secure it with a screw.

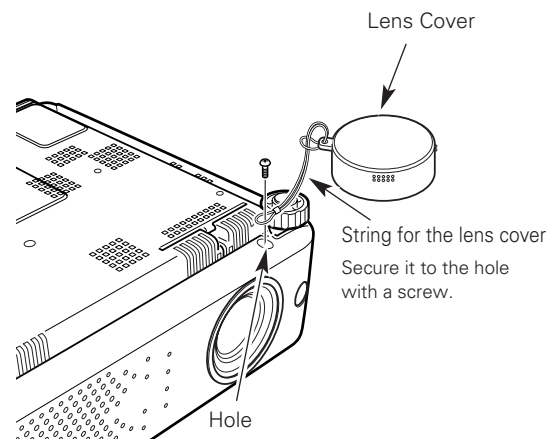

Cleaning the Projection Lens

Follow these steps to clean the projection lens.

- 1** Disconnect the AC power cord before cleaning.
- 2** Softly wipe the projection lens with a cleaning cloth that contains a small amount of non-abrasive camera lens cleaner, or use lens cleaning paper or a commercially available air blower to clean the lens. Avoid using an excessive amount of cleaner. Abrasive cleaners, solvents, or other harsh chemicals might scratch the surface.
- 3** When the projector is not in use, replace the lens cover.

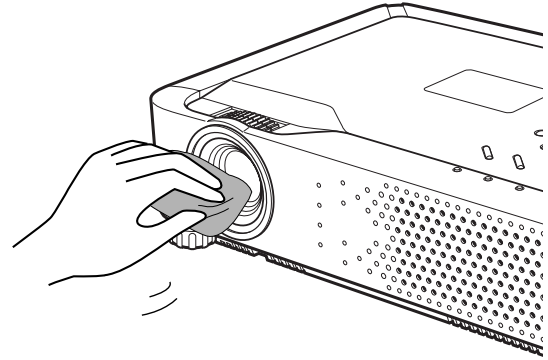

Cleaning the Projector Cabinet

Follow these steps to clean the projector cabinet.

- 1** Disconnect the AC power cord before cleaning.
- 2** Softly wipe the projector body with a soft, dry cleaning cloth. When it is heavily soiled, use a small amount of mild detergent and finish with a soft, dry cleaning cloth. Avoid using an excessive amount of cleaner. Abrasive cleaners, solvents, or other harsh chemicals might scratch the surface.
- 3** When the projector is not in use, put the projector in an appropriate carrying case to protect it from dust and scratches.

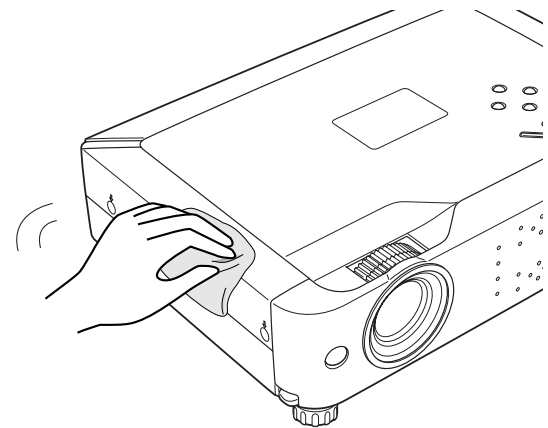

Lamp Replacement

When the life of the projection lamp of this projector draws to an end, the LAMP REPLACE indicator emits a yellow light. If this indicator lights yellow, replace the lamp with a new one promptly.



WARNING:
TURN OFF THE UV LAMP BEFORE
OPENING THE LAMP COVER

This indicator is yellow when the life of the projection lamp draws to an end.

Top Control

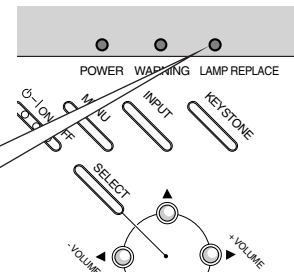

CAUTION

Allow a projector to cool, for at least 45 minutes before you open the Lamp cover. The inside of the projector can become very hot.



CAUTION

For continued safety, replace with a lamp of the same type. Do not drop a lamp or touch a glass bulb! The glass can shatter and may cause injury.

Follow these steps to replace the lamp.

- 1** Turn off the projector and disconnect the AC power cord. Allow the projector to cool for at least 45 minutes.
- 2** Remove the screw with a screwdriver, and remove the lamp cover.
- 3** Remove 2 screws of the lamp with a screwdriver and pull out the lamp by grasping the handle.
- 4** Replace the lamp with a new one and tighten the 2 screws back into position. Make sure that the lamp is set properly. Replace the lamp cover and tighten the screw.
- 5** Connect the AC power cord to the projector and turn on the projector.
- 6** **Reset the lamp replacement counter.**
See "Lamp Replacement Counter" on the next page .

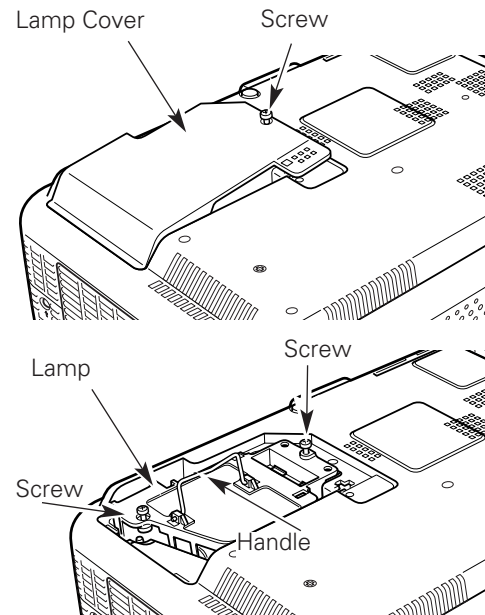

ORDER REPLACEMENT LAMP

Replacement lamp can be ordered through your dealer. When ordering a projection lamp, give the following information to the dealer.

- **Model No. of your projector** : PLC-XU73/ PLC-XU70/ PLC-SU70
- **Replacement Lamp Type No.** : POA-LMP90 (for PLC-XU73/ PLC-SU70)
(Service Parts No. 610 323 0726)
POA-LMP93 (for PLC-XU70)
(Service Parts No. 610 323 0719)

Lamp Replacement Counter

Be sure to reset the Lamp replacement counter after the lamp is replaced. When the Lamp replacement counter is reset, the LAMP REPLACE indicator stops lighting.

- 1 Turn the projector on, press the MENU button to display the On-Screen Menu. Press the Point ◀▶ buttons to move the red framed pointer to the Setting Menu icon.
- 2 Press the Point ▲▼ buttons to move the red framed pointer to the Lamp counter function and then press the SELECT button. The first dialog box appears and shows the total accumulated time of the lamp usage and the reset option. If you select "Reset", a "Lamp replacement counter Reset?" message will appear. Select [Yes] to continue.
- 3 Another confirmation dialog box will appear, select [Yes] to reset the Lamp replacement counter.

✓ **Note:**

Do not reset the Lamp replacement counter without implementation of lamp replacement. Be sure to reset the Lamp replacement counter only after replacing the lamp.

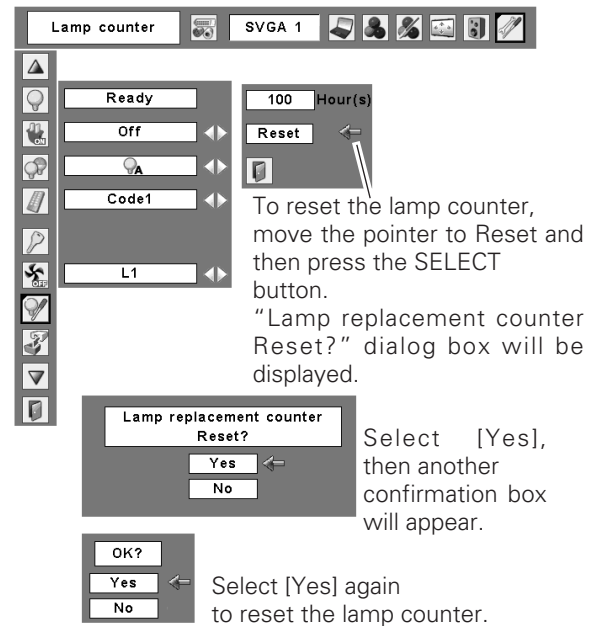

LAMP HANDLING PRECAUTIONS

This projector uses a high-pressure lamp which must be handled carefully and properly. Improper handling may result in accidents, injury, or create a fire hazard.

- Lamp life may differ from lamp to lamp and according to the environment of use. There is no guarantee of the same life for each lamp. Some lamps may fail or terminate their life in a shorter period of time than other similar lamps.
- If the projector indicates that the lamp should be replaced, i.e., if the LAMP REPLACE indicator lights up, replace the lamp with a new one IMMEDIATELY after the projector has cooled down. (Follow carefully the instructions in the Lamp Replacement section of this manual.) Continuous use of the lamp with the LAMP REPLACE indicator lighted may increase the risk of lamp explosion.
- A Lamp may explode as a result of vibration, shock or degradation as a result of hours of use as its lifetime draws to an end. Risk of explosion may differ according to the environment or conditions in which the projector and lamp are being used.

IF A LAMP EXPLODES, THE FOLLOWING SAFETY PRECAUTIONS SHOULD BE TAKEN.

If a lamp explodes, disconnect the projector's AC plug from the AC outlet immediately. Contact an authorized service station for a checkup of the unit and replacement of the lamp. Additionally, check carefully to ensure that there are no broken shards or pieces of glass around the projector or coming out from the cooling air circulation holes. Any broken shards found should be cleaned up carefully. No one should check the inside of the projector except those who are authorized trained technicians and who are familiar with projector service. Inappropriate attempts to service the unit by anyone, especially those who are not appropriately trained to do so, may result in an accident or injury caused by pieces of broken glass.

Troubleshooting

Before calling your dealer or service center for assistance, check the items below once again.

- Make sure you have properly connected the projector to peripheral equipment as described on page15-17.
- Make sure all equipment is connected to AC outlet and the power is turned on.
- When you operate the projector with a computer and it does not project an image, restart the computer.

Problem:	Solutions
No power	<ul style="list-style-type: none">- Plug the power cord of the projector into the AC outlet.- See if the POWER indicator lights red.- Wait 90-120 seconds after the projector is turned off when turning the projector back on. The projector can be turned on after the POWER indicator turns red. (See on page 19.)- Check the WARNING indicator. If the WARNING indicator lights red, the projector cannot be turned on. (See on page 49.)- Check the projection lamp. (See page 52.)- Unlock Key lock for the projector Key lock function. (See page 46.)
Image is out of focus.	<ul style="list-style-type: none">- Adjust focus of the projector. (See page 22.)- Provide proper distance between the projector and the projection screen. (See page 13.)- Check the projection lens to see if it needs cleaning. (See page 51.)- Moving the projector from a cool to a warm place may result in moisture condensation on the projection lens. In such cases, leave the projector off and wait until condensation evaporates.
No image	<ul style="list-style-type: none">- Check the connection between your computer or video equipment and the projector. (See page 15–17)- See if the input signal is correctly output from your computer. Some laptop computers may need to change the setting for monitor output when connecting to a projector. See your computer's instruction manual for the setting.- It takes about 30 seconds to display an image after turning on the projector. See if the selected system is corresponding with your computer or video equipment. (See page 26 and 36)- Select correct input source once again through menu operation. (See page 25 ,34 and 35)- Make sure the temperature is not out of the specified Operating Temperature (41 °F ~ 95 °F (5 °C ~ 35 °C)) .
Image is Left/Right reversed. Image is Top/Bottom reversed.	<ul style="list-style-type: none">- Check the Ceiling / Rear function. (See page 44.)- Check the Ceiling function. (See page 44.)
No sound	<ul style="list-style-type: none">- Check audio cable connection from audio input source.- Adjust the audio source.- Press the Volume+ button. (See page 23.)- Press the Mute button. (See page 23.)

<i>Some displays are not seen during the operation.</i>	-Check the Display function. (See page 41.)
<i>PIN code dialog box appears at start-up.</i>	-PIN code lock is being set. Input a PIN code (1234 or numbers you have set). (See page 18, 46, 47.)
<i>Computer 2 cannot be selected.</i>	-Select Computer 2 at the Terminal function. (See page 44.)
<i>The Terminal function cannot be selected.</i>	-The Terminal function cannot be selected after Computer 2 is selected. Select other input source such as Computer 1 or Video with the INPUT button on the top control, the COMPUTER button or the VIDEO button on the remote control so that the Terminal function can be selected.
<i>The Remote Control does not work.</i>	-Check the batteries. -Make sure no obstruction is between the projector and remote control. -Make sure you are not too far from the projector when using the remote control. Maximum operating range is 16.4' (5m). -Make sure the code of the remote control is conformed to the projector. (See page 45.) -Unlock Key lock for the remote control in the Key lock function. (See page 46.)
<i>Cooling fans are still running after the AC plug is disconnected.</i>	-This is normal condition. Fans are running about 1 minute even after disconnecting the AC plug.

WARNING :

High voltages are used to operate this projector. Do not attempt to open the cabinet.

If problems still persist after following all operating instructions, contact the dealer where you purchased the projector or the service center. Give the model number and explain about the problem. We will advise you how to obtain service.



The CE Mark is a Directive conformity mark of the European Community (EC).



This symbol on the nameplate means the product is Listed by Underwriters Laboratories Inc. It is designed and manufactured to meet rigid U.L. safety standards against risk of fire, casualty and electrical hazards.



Pixelworks ICs used.

Menu Tree

Computer Input / Video Input

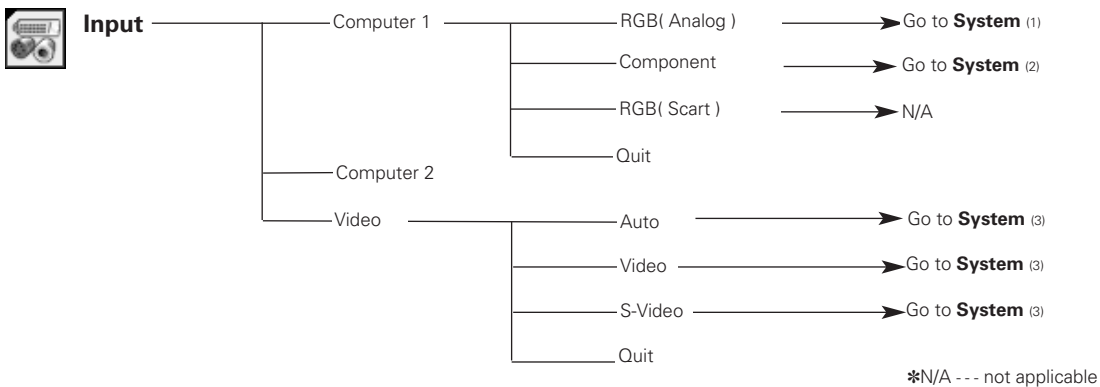

Sound

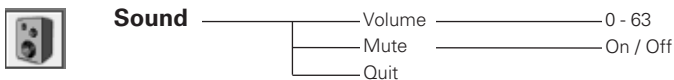

Computer Input

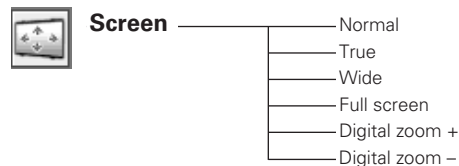
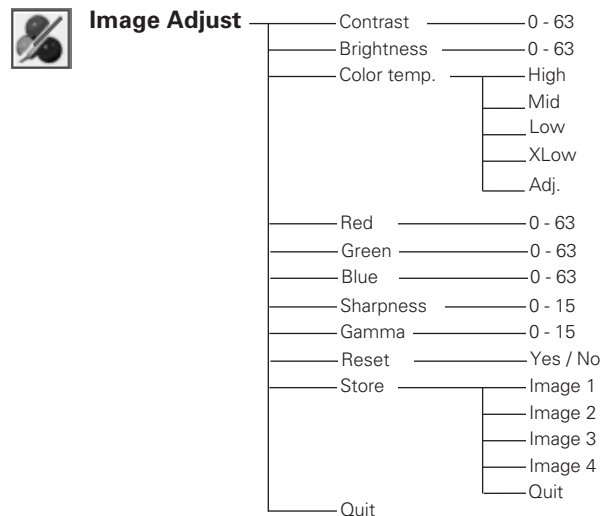
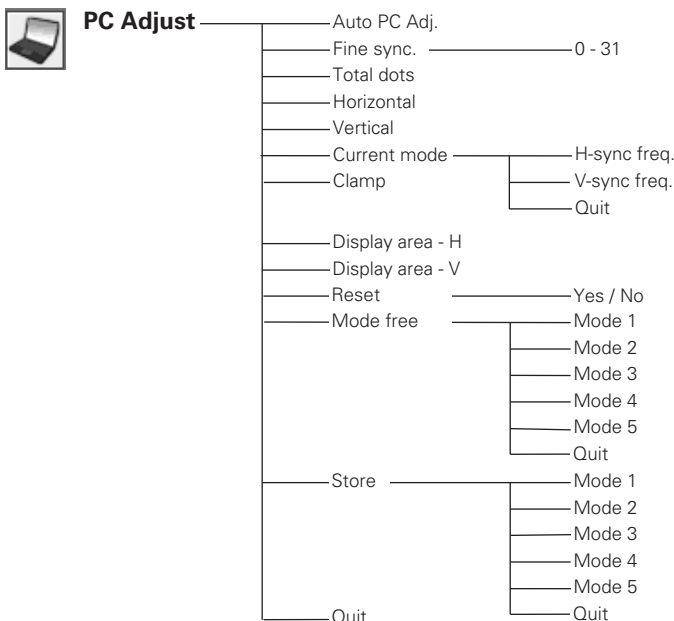
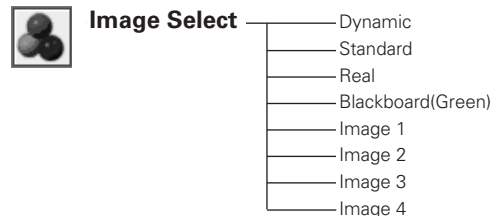
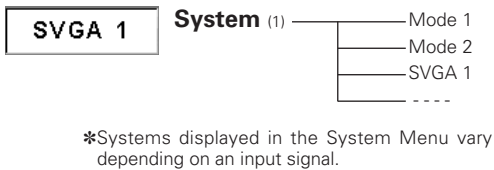

Video Input



- System (2)**
 - Auto
 - 1080i
 - 1035i
 - 720p
 - 575p
 - 480p
 - 575i
 - 480i

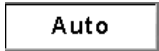

- System (3)**
 - Auto
 - PAL
 - SECAM
 - NTSC
 - NTSC 4.43
 - PAL-M
 - PAL-N



- Image Select**
 - Dynamic
 - Standard
 - Cinema
 - Blackboard(Green)
 - Image 1
 - Image 2
 - Image 3
 - Image 4



- Image Adjust**
 - Contrast 0 - 63
 - Brightness 0 - 63
 - Color 0 - 63
 - Tint 0 - 63
 - Color temp.
 - High
 - Mid
 - Low
 - XLow
 - Adj.
 - Red 0 - 63
 - Green 0 - 63
 - Blue 0 - 63
 - Sharpness 0 - 15
 - Gamma 0 - 15
 - Noise reduction
 - Off
 - L1
 - L2
 - Progressive
 - Off
 - L1
 - L2
 - Film
 - Reset Yes / No
 - Store
 - Image 1
 - Image 2
 - Image 3
 - Image 4
 - Quit
 - Quit



- Screen**
 - Normal
 - Wide

























Setting



- Setting**
 - Language
 - English
 - German
 - French
 - Italian
 - Spanish
 - Portuguese
 - Dutch
 - Swedish
 - Finnish
 - Polish
 - Hungarian
 - Romanian
 - Russian
 - Chinese
 - Korean
 - Japanese
 - Quit
 - Keystone Store / Reset
 - Blue back On / Off
 - Display On / Countdown off / Off
 - Logo
 - Logo select
 - Off
 - Default
 - User
 - Capture
 - Yes / No
 - Logo PIN code lock
 - Logo PIN code entry
 - Off
 - On
 - PIN code change
 - Quit
 - Quit
 - Ceiling On / Off
 - Rear On / Off
 - Terminal Computer 2 / Monitor out
 - Power management
 - Off
 - Ready
 - Shut down
 - Timer(1-30 Min)
 - Quit
 - On start On / Off
 - Lamp control Normal / Auto / Eco
 - Remote control Code 1 / Code 2
 - Security
 - Key lock
 - Off
 - Projector
 - Remote control
 - Quit
 - PIN code lock
 - PIN code lock entry
 - Off
 - On
 - PIN code change
 - Quit
 - Fan L1 / L2
 - Lamp counter
 - Hour(s)
 - Reset
 - Quit
 - Factory default Yes / No
 - Quit

Indicators and Projector Condition

Check the indicators for projector condition.

Indicators			Projector Condition
POWER red/green	WARNING red	LAMP REPLACE yellow	
			The projector is off. (The AC power cord is unplugged.)
			The projector is preparing for stand-by or the projection lamp is being cooled down. The projector cannot be turned on until cooling is completed.
			The projector is ready to be turned on with the POWER ON-OFF button.
			The projector is operating normally.
			The projector is in the Power management mode.
			The temperature inside the projector is abnormally high. The projector cannot be turned on. When the projector is cooled down enough and the temperature returns to normal, the POWER indicator emits a red light and the projector can be turned on. (The WARNING indicator keeps blinking.) Check and clean the air filters.
			The projector has been cooled down enough and the temperature returns to normal. When turning on the projector, the WARNING indicator stops blinking. Check and clean the air filters.
			The projector detects an abnormal condition and cannot be turned on. Unplug the AC power cord and plug it again to turn on the projector. If the projector is turned off again, disconnect the AC power cord and contact the dealer or the service center for service and checkup. Do not leave the projector on. It may cause an electric shock or a fire hazard.

 ●●● green.

 ●●● red

 ●●● off

 ●●● blinks green.

 ●●● blinks red.

* When the life of the projection lamp draws to an end, the LAMP REPLACE indicator lights yellow. When this indicator lights yellow, replace the projection lamp with a new one promptly. Reset the lamp replacement counter after replacement of the lamp. See page 52 and 53.

Compatible Computer Specifications

The projector can basically accept the signal from all computers with the V, H-Frequency mentioned below and less than 140 MHz of Dot Clock for PLC-XU73/PLC-XU70 (XGA), and 100 MHz of Dot Clock for PLC-SU70(SVGA).

ON-SCREEN DISPLAY	RESOLUTION	H-Freq. (kHz)	V-Freq. (Hz)	ON-SCREEN DISPLAY	RESOLUTION	H-Freq. (kHz)	V-Freq. (Hz)	
VGA 1	640 x 480	31.47	59.88	SXGA 1	1152 x 864	64.20	70.40	
VGA 2	720 x 400	31.47	70.09	SXGA 2	1280 x 1024	62.50	58.60	*2
VGA 3	640 x 400	31.47	70.09	SXGA 3	1280 x 1024	63.90	60.00	*2
VGA 4	640 x 480	37.86	74.38	SXGA 4	1280 x 1024	63.34	59.98	*2
VGA 5	640 x 480	37.86	72.81	SXGA 5	1280 x 1024	63.74	60.01	*2
VGA 6	640 x 480	37.50	75.00	SXGA 6	1280 x 1024	71.69	67.19	*2
VGA 7	640 x 480	43.269	85.00	SXGA 7	1280 x 1024	81.13	76.107	*2
MAC LC13	640 x 480	34.97	66.60	SXGA 8	1280 x 1024	63.98	60.02	*2
MAC 13	640 x 480	35.00	66.67	SXGA 9	1280 x 1024	79.976	75.025	*2
480i	————	15.734	^{60.00} (Interface)	SXGA 10	1280 x 960	60.00	60.00	*2
575i	————	15.625	^{50.00} (Interface)	SXGA 11	1152 x 900	61.20	65.20	
SVGA 1	800 x 600	35.156	56.25	SXGA 12	1152 x 900	71.40	75.60	*2
SVGA 2	800 x 600	37.88	60.32	SXGA 13	1280 x 1024	50.00	^{86.00} (Interface)	
SVGA 3	800 x 600	46.875	75.00	SXGA 14	1280 x 1024	50.00	^{94.00} (Interface)	
SVGA 4	800 x 600	53.674	85.06	SXGA 15	1280 x 1024	63.37	60.01	*2
SVGA 5	800 x 600	48.08	72.19	SXGA 16	1280 x 1024	76.97	72.00	*2
SVGA 6	800 x 600	37.90	61.03	SXGA 17	1152 x 900	61.85	66.00	
SVGA 7	800 x 600	34.50	55.38	SXGA 18	1280 x 1024	46.43	^{86.70} (Interface)	
SVGA 8	800 x 600	38.00	60.51	SXGA 19	1280 x 1024	63.79	60.18	*2
SVGA 9	800 x 600	38.60	60.31	SXGA 20	1280 x 1024	91.146	85.024	*1
SVGA 10	800 x 600	32.70	51.09	SXGA 21	1400 x 1050	63.979	60.190	*2
SVGA 11	800 x 600	38.00	60.51	SXGA 22	1400 x 1050	65.346	60.116	*2
MAC 16	832 x 624	49.72	74.55	SXGA 23	1400 x 1050	65.121	59.902	*2
XGA 1	1024 x 768	48.36	60.00	MAC21	1152 x 870	68.68	75.06	*2
XGA 2	1024 x 768	68.677	84.997	MAC	1280 x 960	75.00	75.08	*2
XGA 3	1024 x 768	60.023	75.03	MAC	1280 x 1024	80.00	75.08	*2
XGA 4	1024 x 768	56.476	70.07	480p	————	31.47	59.88	
XGA 5	1024 x 768	60.31	74.92	575p	————	31.25	50.00	
XGA 6	1024 x 768	48.50	60.02	720p	————	45.00	60.00	
XGA 7	1024 x 768	44.00	54.58	1035i	————	33.75	^{60.00} (Interface)	
XGA 8	1024 x 768	63.48	79.35	1080i	————	33.75	^{60.00} (Interface)	
XGA 9	1024 x 768	36.00	^{87.17} (Interface)	1080i	————	28.125	^{50.00} (Interface)	
XGA 10	1024 x 768	62.04	77.07	WXGA 1	1366 x 768	48.36	60.00	
XGA 11	1024 x 768	61.00	75.70	WXGA 2	1360 x 768	47.70	60.00	
XGA 12	1024 x 768	35.522	^{86.96} (Interface)	WXGA 3	1376 x 768	48.36	60.00	
XGA 13	1024 x 768	46.90	58.20	WXGA 4	1360 x 768	56.16	72.00	*2
XGA 14	1024 x 768	47.00	58.30	UXGA 1	1600 x 1200	75.00	60.00	*1
XGA 15	1024 x 768	58.03	72.00	UXGA 2	1600 x 1200	81.25	65.00	*1
MAC 19	1024 x 768	60.24	75.08	UXGA 3	1600 x 1200	87.5	70.00	*1
				UXGA 4	1600 x 1200	93.75	75.00	*1

*1 For PLC-XU73/PLC-XU70/PLC-SU70, PC adjustment can be limited.

*2 For PLC-SU70, PC adjustment can be limited.

Technical Specifications

Mechanical Information

Projector Type	Multi-media Projector
Dimensions (W x H x D)	9.66" x 2.3" x 6.82" (294.5mm x 69.5mm x 208mm) (Not including adjustable feet)
Net Weight	5.3 lbs (2.4kgs)
Feet Adjustment	0° to 10.0°

Panel Resolution

	PLC-XU73 / PLC-XU70	PLC-SU70
LCD Panel System	0.6" TFT Active Matrix type, 3 panels	
Panel Resolution	1,024 x 768 dots	800 x 600 dots
Number of Pixels	2,359,296 (1,024 x 768 x 3 panels)	1,440,000 (800 x 600 x 3 panels)

Signal Compatibility

Color System	PAL, SECAM, NTSC, NTSC4.43, PAL-M, PAL-N
High Definition TV Signal	480i, 480p, 575i, 575p, 720p, 1035i, and 1080i
Scanning Frequency	H-sync. 15 ~ 100 KHz, V-sync. 50 ~ 100 Hz

Optical Information

Projection Image Size (Diagonal)	Adjustable from 40" to 300"
Projection Lens	F 1.65 ~ 1.81 lens with f 22.5 mm ~ 27 mm with manual zoom and focus
Throw Distance	4.6' - 43.3' (1.4m - 13.2m)
Projection Lamp	200W (for PLC-XU73/PLC-SU70) / 180W (for PLC-XU70)

Interface

Video Input Jack	RCA Type x 1
S-Video Input Jack	Mini DIN 4 pin x 1
Audio Input Jacks	RCA Type x 2
Computer Input 1 / Component Input Terminal	Analog RGB (Mini D-sub 15 pin) Terminal X 1
Computer Input 2 / Monitor Output Terminal	Analog RGB (Mini D-sub 15 pin) Terminal X 1 (In / Out switchable)
Computer/ Component Audio Input Jack	Mini Jack (stereo) x 1
Service Port Connector	Mini DIN 8 pin x 1
USB Connector	USB Series B receptacle x 1
Audio Output Jack	Mini Jack (stereo) x 1 (Variable)

Audio

Internal Audio Amp	1.0W RMS
Built-in Speaker	1 speaker, ø1.1" (28mm)

Power

Voltage and Power Consumption	for PLC-XU73 / PLC-SU70
	AC 100 ~ 120 V (3.2A Max. Ampere), 50 / 60 Hz (The U.S.A and Canada)
	AC 200 ~ 240 V (1.6A Max. Ampere), 50 / 60 Hz (Continental Europe and The U.K.)
	for PLC-XU70
	AC 100 ~ 120 V (2.9A Max. Ampere), 50 / 60 Hz (The U.S.A and Canada)
	AC 200 ~ 240 V (1.4 A Max. Ampere), 50 / 60 Hz (Continental Europe and The U.K.)

Operating Environment

Operating Temperature	41 °F ~ 95 °F (5 °C ~ 35 °C)
Storage Temperature	14 °F ~ 140 °F (-10°C ~ 60 °C)

Remote Control

Battery	AA or LR6 1.5V ALKALINE TYPE x 2
Operating Range	16.4' (5m) / ±30°
Dimensions	1.9"(W) x 0.87"(H) x 5.7"(D) (49mm x 22mm x 145.3mm)
Net Weight	3.53 oz (100 g) (including batteries)

Accessories

Owner's Manual
 AC Power Cord
 Remote Control and Batteries
 VGA Cable
 Lens Cover with String
 PIN Code Label

- The specifications are subject to change without notice.
- LCD panels are manufactured to the highest possible standards. Even though 99.99% of the pixels are effective, a tiny fraction of the pixels (0.01% or less) may be ineffective by the characteristics of the LCD panels.

Optional Parts

The parts listed below are optionally available. When ordering those parts, give the item name and Model No. to the sales dealer.

	<i>Model No.</i>
COMPONENT-VGA Cable	: POA-CA-COMPVGA
SCART-VGA Cable	: POA-CA-SCART
Ceiling Hanger	: POA-CHS-US01 (for low ceiling) POA-CHL-UL01 (for high ceiling) POA-CHB-XU70
Laser Pointer Remote Control Unit	: POA-RCKIT03
Presentation Kit	: POA-RCKIT02

Configurations of Terminals

COMPUTER INPUT/COMPONENT INPUT/MONITOR OUTPUT TERMINAL (ANALOG)

Terminal : Analog RGB (Mini D-sub 15 pin)

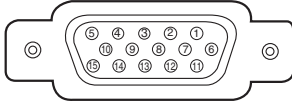

1	Red (R/Cr) Input / Output	9	----
2	Green (G/Y) Input / Output	10	Ground (Vert.sync.)
3	Blue (B/Cb) Input / Output	11	Ground / ----
4	----	12	----
5	Ground (Horiz.sync.)	13	Horiz. sync. Input/Output (Composite H/V sync.)
6	Ground (Red)	14	Vert. sync.
7	Ground (Green)	15	----
8	Ground (Blue)		

SERVICE PORT CONNECTOR

Terminal : Mini DIN 8-PIN

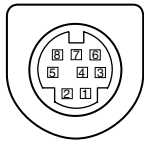

	Serial
1	R X D
2	----
3	----
4	GND
5	RTS / CTS
6	T X D
7	GND
8	GND

USB CONNECTOR (Series B)

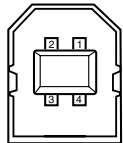

1	Vcc
2	- Data
3	+ Data
4	Ground

PIN Code Number Memo

Write down the PIN code number in the column below and keep it with this manual securely. If you forgot or lost the number and unable to operate the projector, contact the service station.

PIN Code Lock No.

--	--	--	--

Factory default set No: 1 2 3 4*

Logo PIN Code Lock No.

--	--	--	--

Factory default set No: 4 3 2 1*

*Should the four-digit number be changed, the factory set number will be invalid.

While the projector is locked with the PIN code...

Put the label below (supplied) on in a prominent place of the projector's body while it is locked with a PIN code.

