

SANYO

Multimedia Projector

MODEL PLC-XU45

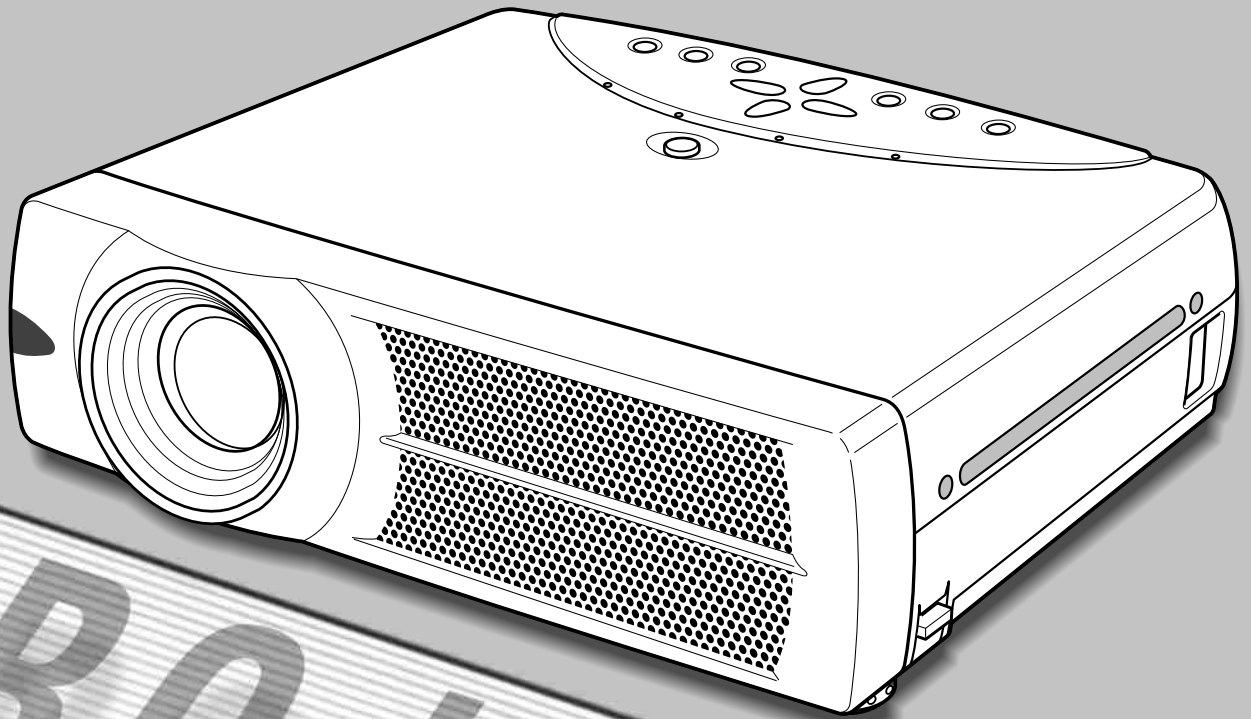

Owner's Manual

ProSelecta

View :: Compare :: Select - www.ProSelecta.com

TO THE OWNER

Before operating this projector, read this manual thoroughly and operate the projector properly. This projector provides many convenient features and functions. Operating the projector properly enables you to manage those features and maintains it in better condition for a considerable time. Improper operation may result in not only shortening the product-life, but also malfunctions, fire hazard, or other accidents. If your projector seems to operate improperly, read this manual again, check operations and cable connections and try the solutions in the "TROUBLESHOOTING" section at the end of this booklet. If the problem still persists, contact the sales dealer where you purchased the projector or the service center.



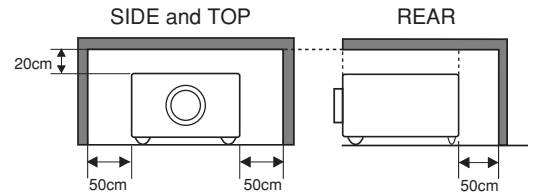

SAFETY PRECAUTIONS

WARNING : TO REDUCE THE RISK OF FIRE OR ELECTRIC SHOCK, DO NOT EXPOSE THIS APPLIANCE TO RAIN OR MOISTURE.

- This projector produces intense light from the projection lens. Do not stare directly into the lens as it could possibly damage your eyes. Be especially careful that children do not stare directly into the beam.
- This projector should be set in the way indicated. If not, it may result in a fire hazard.
- Provide appropriate space on the top, sides and rear of the projector cabinet for allowing air circulation and cooling the projector. Minimum clearance must be maintained. If the projector is to be built into a compartment or similarly enclosed, the minimum distances must be maintained. Do not cover the ventilation slot on the projector. Heat build-up can reduce the service life of your projector, and can also be dangerous.
- Do not put any flammable object or spray can near the projector, hot air is exhausted from the ventilation holes.
- The Remote Control, supplied to this projector, emits the laser beam as the laser pointer function from Laser Light Window while pressing the LASER button (for 1 minute / LASER POINTER INDICATOR lights red to indicate laser emission). Do not look into the Laser Light Window or shine the laser beam on yourself or other people. Eye damage may result.
- If the projector is not to be used for an extended time, unplug the projector from the power outlet.



READ AND KEEP THIS OWNER'S MANUAL FOR LATER USE.

| | | |
|---|---|---|
|  | CAUTION RISK OF ELECTRIC SHOCK DO NOT OPEN |  |
| CAUTION : TO REDUCE THE RISK OF ELECTRIC SHOCK, DO NOT REMOVE COVER (OR BACK). NO USER-SERVICEABLE PARTS INSIDE EXCEPT LAMP REPLACEMENT. REFER SERVICING TO QUALIFIED SERVICE PERSONNEL. | | |
|  THIS SYMBOL INDICATES THAT DANGEROUS VOLTAGE CONSTITUTING A RISK OF ELECTRIC SHOCK IS PRESENT WITHIN THIS UNIT. |  THIS SYMBOL INDICATES THAT THERE ARE IMPORTANT OPERATING AND MAINTENANCE INSTRUCTIONS IN THE OWNER'S MANUAL WITH THIS UNIT. | |

SAFETY INSTRUCTIONS

All the safety and operating instructions should be read before the product is operated.

Read all of the instructions given here and retain them for later use. Unplug this projector from AC power supply before cleaning. Do not use liquid or aerosol cleaners. Use a damp cloth for cleaning.

Follow all warnings and instructions marked on the projector.

For added protection to the projector during a lightning storm, or when it is left unattended and unused for long periods of time, unplug it from the wall outlet. This will prevent damage due to lightning and power line surges.

Do not expose this unit to rain or use near water... for example, in a wet basement, near a swimming pool, etc...

Do not use attachments not recommended by the manufacturer as they may cause hazards.

Do not place this projector on an unstable cart, stand, or table. The projector may fall, causing serious injury to a child or adult, and serious damage to the projector. Use only with a cart or stand recommended by the manufacturer, or sold with the projector. Wall or shelf mounting should follow the manufacturer's instructions, and should use a mounting kit approved by the manufacturers.

An appliance and cart combination should be moved with care. Quick stops, excessive force, and uneven surfaces may cause the appliance and cart combination to overturn.



Slots and openings in the back and bottom of the cabinet are provided for ventilation, to insure reliable operation of the equipment and to protect it from overheating.

The openings should never be covered with cloth or other materials, and the bottom opening should not be blocked by placing the projector on a bed, sofa, rug, or other similar surface. This projector should never be placed near or over a radiator or heat register.

This projector should not be placed in a built-in installation such as a book case unless proper ventilation is provided.

Never push objects of any kind into this projector through cabinet slots as they may touch dangerous voltage points or short out parts that could result in a fire or electric shock. Never spill liquid of any kind on the projector.

This projector should be operated only from the type of power source indicated on the marking label. If you are not sure of the type of power supplied, consult your authorized dealer or local power company.

Do not overload wall outlets and extension cords as this can result in fire or electric shock. Do not allow anything to rest on the power cord. Do not locate this projector where the cord may be damaged by persons walking on it.

Do not attempt to service this projector yourself as opening or removing covers may expose you to dangerous voltage or other hazards. Refer all servicing to qualified service personnel.

Unplug this projector from wall outlet and refer servicing to qualified service personnel under the following conditions:

- a. When the power cord or plug is damaged or frayed.
- b. If liquid has been spilled into the projector.
- c. If the projector has been exposed to rain or water.
- d. If the projector does not operate normally by following the operating instructions. Adjust only those controls that are covered by the operating instructions as improper adjustment of other controls may result in damage and will often require extensive work by a qualified technician to restore the projector to normal operation.
- e. If the projector has been dropped or the cabinet has been damaged.
- f. When the projector exhibits a distinct change in performance-this indicates a need for service.

When replacement parts are required, be sure the service technician has used replacement parts specified by the manufacturer that have the same characteristics as the original part. Unauthorized substitutions may result in fire, electric shock, or injury to persons.

Upon completion of any service or repairs to this projector, ask the service technician to perform routine safety checks to determine that the projector is in safe operating condition.

Voor de klanten in Nederland



Bij dit product zijn batterijen geleverd. Wanneer deze leeg zijn, moet u ze niet weggooien maar inleveren als KCA.

COMPLIANCES

Federal Communication Commission Notice

Note : This equipment has been tested and found to comply with the limits for a Class B digital device, pursuant to part 15 of the FCC Rules. These limits are designed to provide reasonable protection against harmful interference in a residential installation. This equipment generates, uses and can radiate radio frequency energy and, if not installed and used in accordance with the instructions, may cause harmful interference to radio communications. However, there is no guarantee that interference will not occur in a particular installation. If this equipment does cause harmful interference to radio or television reception, which can be determined by turning the equipment off and on, the user is encouraged to try to correct the interference by one or more of the following measures :

- Reorient or relocate the receiving antenna.
- Increase the separation between the equipment and receiver.
- Connect the equipment into an outlet on a circuit different from that to which the receiver is connected.
- Consult the dealer or an experienced radio/TV technician for help.

Use of shielded cable is required to comply with class B limits in Subpart B of Part 15 of FCC Rules.

Do not make any changes or modifications to the equipment unless otherwise specified in the instructions. If such changes or modifications should be made, you could be required to stop operation of the equipment.

Model Numbers : PLC-XU45
Trade Name : Sanyo
Responsible party : SANYO FISHER COMPANY
Address : 21605 Plummer Street, Chatsworth, California 91311
Telephone No. : (818)998-7322

AC POWER CORD REQUIREMENT

The AC Power Cord supplied with this projector meets the requirement for use in the country you purchased it.

AC Power Cord for the United States and Canada :

AC Power Cord used in the United States and Canada is listed by the Underwriters Laboratories (UL) and certified by the Canadian Standard Association (CSA).

AC Power Cord has a grounding-type AC line plug. This is a safety feature to be sure that the plug will fit into the power outlet. Do not try to defeat this safety feature. Should you be unable to insert the plug into the outlet, contact your electrician.

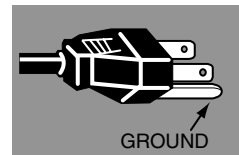

AC Power Cord for the United Kingdom :

This cord is already fitted with a moulded plug incorporating a fuse, the value of which is indicated on the pin face of the plug. Should the fuse need to be replaced, an ASTA approved BS 1362 fuse must be used of the same rating, marked thus \diamond . If the fuse cover is detachable, never use the plug with the cover omitted. If a replacement fuse cover is required, ensure it is of the same colour as that visible on the pin face of the plug (i.e. red or orange). Fuse covers are available from the Parts Department indicated in your User Instructions.

If the plug supplied is not suitable for your socket outlet, it should be cut off and destroyed.

The end of the flexible cord should be suitably prepared and the correct plug fitted. (See Over)

WARNING : A PLUG WITH BARED FLEXIBLE CORD IS HAZARDOUS IF ENGAGED IN A LIVE SOCKET OUTLET.

The Wires in this mains lead are coloured in accordance with the following code:

Green-and-yellow Earth
Blue Neutral
Brown Live

As the colours of the wires in the mains lead of this apparatus may not correspond with the coloured markings identifying the terminals in your plug proceed as follows:

The wire which is coloured green-and-yellow must be connected to the terminal in the plug which is marked by the letter E or by the safety earth symbol \perp or coloured green or green-and-yellow.

The wire which is coloured blue must be connected to the terminal which is marked with the letter N or coloured black.

The wire which is coloured brown must be connected to the terminal which is marked with the letter L or coloured red.

WARNING : THIS APPARATUS MUST BE EARTHED.

THE SOCKET-OUTLET SHOULD BE INSTALLED NEAR THE EQUIPMENT AND EASILY ACCESSIBLE.

TABLE OF CONTENTS

FEATURES AND DESIGN 6

PREPARATION 7

| | |
|---|----|
| NAME OF EACH PART OF PROJECTOR | 7 |
| SETTING-UP PROJECTOR | 8 |
| CONNECTING AC POWER CORD | 8 |
| POSITIONING PROJECTOR | 9 |
| ADJUSTABLE FEET | 9 |
| INSTALLING PROJECTOR IN PROPER POSITION | 10 |
| MOVING PROJECTOR | 10 |

CONNECTING PROJECTOR 11

| | |
|-------------------------------|----|
| TERMINALS OF PROJECTOR | 11 |
| CONNECTING TO COMPUTER | 12 |
| CONNECTING TO VIDEO EQUIPMENT | 13 |

BEFORE OPERATION 14

| | |
|---------------------------------------|----|
| OPERATION OF REMOTE CONTROL | 14 |
| LASER POINTER FUNCTION | 14 |
| REMOTE CONTROL BATTERIES INSTALLATION | 15 |
| TOP CONTROLS AND INDICATORS | 16 |
| OPERATING ON-SCREEN MENU | 17 |
| HOW TO OPERATE ON-SCREEN MENU | 17 |
| FLOW OF ON-SCREEN MENU OPERATION | 17 |
| MENU BAR | 18 |

BASIC OPERATION 19

| | |
|----------------------------|----|
| TURNING ON / OFF PROJECTOR | 19 |
| ADJUSTING SCREEN | 20 |
| ZOOM ADJUSTMENT | 20 |
| FOCUS ADJUSTMENT | 20 |
| KEystone ADJUSTMENT | 20 |
| PICTURE FREEZE FUNCTION | 20 |
| NO SHOW FUNCTION | 21 |
| P-TIMER FUNCTION | 21 |
| SOUND ADJUSTMENT | 21 |

COMPUTER INPUT 22

| | |
|---------------------------|----|
| SELECTING INPUT SOURCE | 22 |
| SELECTING COMPUTER SYSTEM | 22 |
| PC ADJUSTMENT | 23 |
| AUTO PC ADJUSTMENT | 23 |
| MANUAL PC ADJUSTMENT | 24 |
| PICTURE IMAGE ADJUSTMENTS | 26 |
| IMAGE LEVEL SELECT | 26 |
| IMAGE LEVEL ADJUSTMENT | 27 |
| PICTURE SCREEN ADJUSTMENT | 28 |

VIDEO INPUT 29

| | |
|---------------------------|----|
| SELECTING INPUT SOURCE | 29 |
| SELECTING VIDEO SYSTEM | 30 |
| PICTURE IMAGE ADJUSTMENTS | 31 |
| IMAGE LEVEL SELECT | 31 |
| IMAGE LEVEL ADJUSTMENT | 32 |
| PICTURE SCREEN ADJUSTMENT | 33 |

SETTING 34

| | |
|--------------|----|
| SETTING MENU | 34 |
|--------------|----|

APPENDIX 37

| | |
|------------------------------------|----|
| LAMP REPLACEMENT | 36 |
| LAMP REPLACE | 36 |
| LAMP REPLACE COUNTER | 37 |
| OPERATING WIRELESS MOUSE | 38 |
| MAINTENANCE | 39 |
| WARNING TEMP. INDICATOR | 39 |
| AIR FILTER CARE AND CLEANING | 39 |
| CLEANING PROJECTION LENS | 39 |
| TROUBLESHOOTING | 40 |
| INDICATORS AND PROJECTOR CONDITION | 42 |
| COMPATIBLE COMPUTER SPECIFICATIONS | 43 |
| TECHNICAL SPECIFICATIONS | 44 |
| CONFIGURATIONS OF TERMINALS | 45 |
| OPTIONAL PARTS | 46 |

TRADEMARKS

- Apple, Macintosh, and PowerBook are trademarks or registered trademarks of Apple Computer, Inc.
- IBM, VGA, XGA, and PS/2 are trademarks or registered trademarks of International Business Machines, Inc.
- Windows and PowerPoint are registered trademarks of Microsoft Corporation.
- Each name of corporations or products in the owner's manual is a trademark or a registered trademark of its respective corporation.

FEATURES AND DESIGN

This Multimedia Projector is designed with the most advanced technology for portability, durability, and ease of use. This projector utilizes built-in multimedia features, a palette of 16.77 million colors, and matrix liquid crystal display (LCD) technology.

◆ Compact Design

This projector is extremely compact in size and weight. It is designed to be carried and work anywhere you wish to use.

◆ Compatibility

This projector widely accepts various video and computer input signals including;

- **Computers**
IBM-compatible or Macintosh computer up to 1280 x 1024 resolution.
- **6 Color Systems**
NTSC, PAL, SECAM, NTSC 4.43, PAL-M or PAL-N color system can be connected.
- **Component Video**
Component video signal, such as a DVD player output high definition TV signals including 480i, 480p, 575i, 575p, 720p, 1035i or 1080i, can be connected.
- **S-Video**
S-Video signal, such as a S-VHS VCR output signal, can be connected.

◆ High Resolution Image

This projector provides 1024 x 768 dots resolution for computer input and 800 horizontal TV lines. Resolution from a computer between XGA (1024 x 768) and SXGA (1280 x 1024) is compressed into 1024 x 768 dots. This projector cannot display image of over 1280 x 1024 dots. When resolution of your computer is over than 1280 x 1024, reset a computer output for lower resolution.

◆ Multi-Scan System

This projector has Multi-Scan System to conform to almost all computer output signals quickly. There is no need for troublesome manual adjustment of frequency and other settings.

◆ One-Touch Auto PC Adjustment

Incoming computer video signals are recognized and the best adjustment is automatically set by Auto PC Adjustment. No complicated setup is necessary and projection is always precise.

◆ Digital Zoom (for Computer)

Digital Zoom function adjusts the image size to approx. 1/4 ~ 49 times of original image size, allowing you to focus on crucial information at a presentation.

◆ Keystone Correction

Positioning of a projector may result in distorted image being displayed in a trapezoid shape. Keystone Correction solves this problem by digitally altering projection to produce undistorted images.

◆ Power Management

Power Management function is provided to reduce power consumption while a projector is not in use. This Power Management function operates to turn Projection Lamp off when a projector detects signal interruption and any button is not pressed over 5 minutes. Projection Lamp is automatically turned on again when a projector detects signal or any operation button is pressed. This projector is shipped with this function ON.

◆ Digital Visual Interface

This projector is equipped with DVI 29-pin terminal for connecting DVI output from a computer.

◆ Laser Pointer Function

Remote Control supplied with this projector includes the Laser Pointer function. This function helps you to make a smart presentation on a projected screen.

◆ Wireless Mouse

Remote Control supplied with this projector has Wireless Mouse function for a connected computer. This function enables you to operate both projector and computer with Remote Control only.

◆ Multilanguage Menu Display

Operation menu is displayed in; English, German, French, Italian, Spanish, Portuguese, Dutch, Swedish, Russian, Chinese, Korean, or Japanese.

◆ Media Card Imager (Optional)

Optional Media Card Imager is available for this projector. For the Media Card Imager, contact the dealer where you purchased this projector.

◆ Wireless Imager (Optional)

This projector can be operated through Wireless LAN by attaching Wireless imager that is optionally supplied. For the Wireless Imager, contact the dealer where you purchased the projector.

PREPARATION

NAME OF EACH PART OF PROJECTOR

FRONT

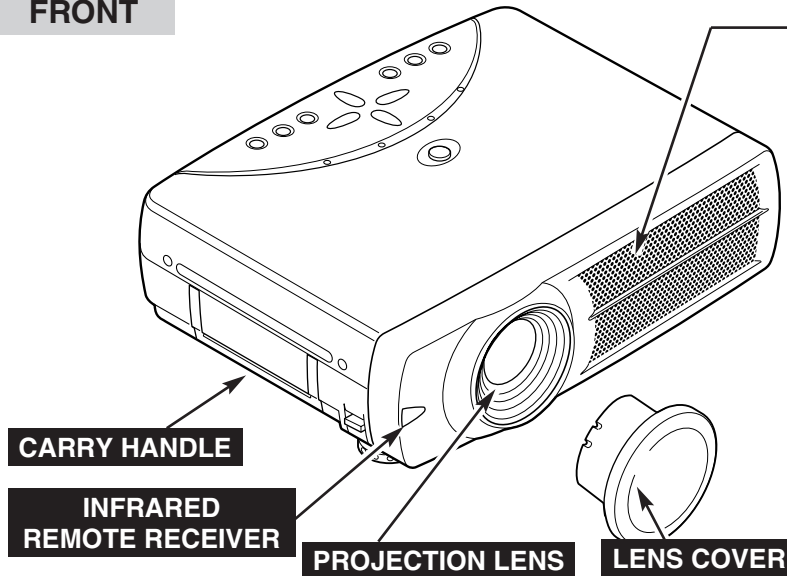

EXHAUST VENTS

⚠ CAUTION

Hot air is exhausted from the exhaust vents. When using or installing the projector, the following precautions should be taken.

- Do not put any flammable object near these vents.
- Keep front grills at least 3'(1m) away from any object, especially heat-sensitive object.
- Do not touch this area, especially screw and metallic part. This area will become hot while a projector is used.

This projector detects internal temperature and automatically controls operating power of Cooling Fans.

BACK

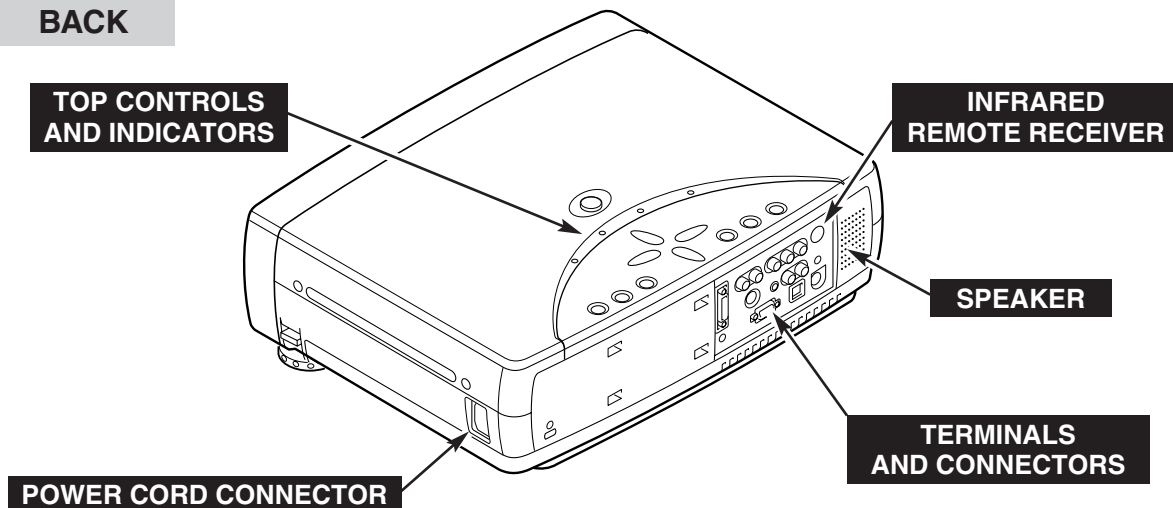

BOTTOM

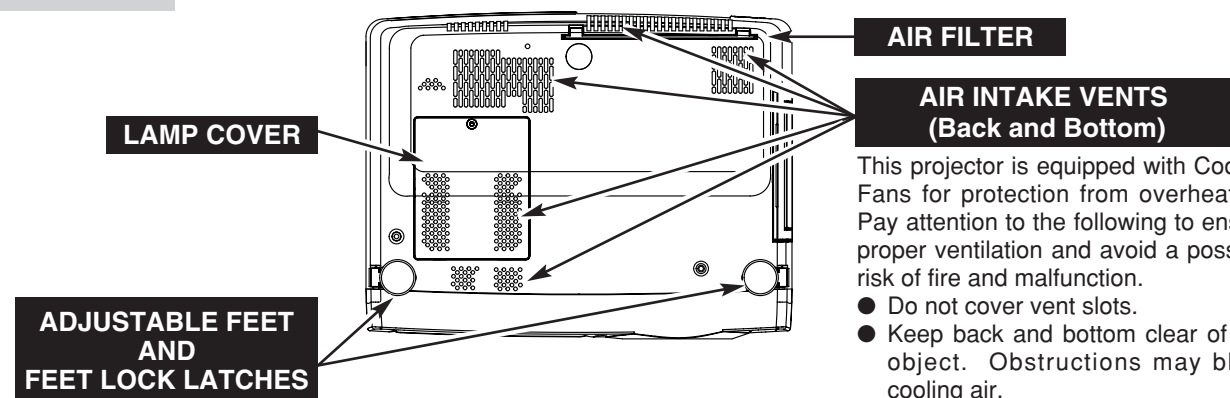

This projector is equipped with Cooling Fans for protection from overheating. Pay attention to the following to ensure proper ventilation and avoid a possible risk of fire and malfunction.

- Do not cover vent slots.
- Keep back and bottom clear of any object. Obstructions may block cooling air.

SETTING-UP PROJECTOR

CONNECTING AC POWER CORD

This projector uses nominal input voltages of 100-120 V or 200-240 V AC. This projector automatically selects the correct input voltage. It is designed to work with single-phase power systems having a grounded neutral conductor. To reduce risk of electrical shock, do not plug into any other type of power system. Consult your authorized dealer or service station if you are not sure of the type of power supply being in use. Connect the projector with peripheral equipment before turning the projector on. (Refer to pages 11 ~ 13 for connection.)

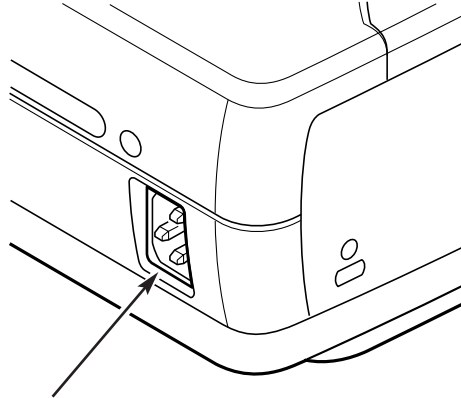

Connect AC Power Cord (supplied) to a projector. The AC outlet must be near this equipment and must be easily accessible.



CAUTION

For safety, unplug AC Power Cord when the projector is not in use.
When this projector is connected to an outlet with AC Power Cord, it is in Stand-by mode and consumes a little electric power.

NOTE ON THE POWER CORD

AC Power Cord must meet requirement of the country where you use a projector. Confirm an AC plug type with the chart below and proper AC Power Cord must be used. If supplied AC Power Cord does not match your AC outlet, contact your sales dealer.

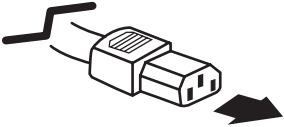
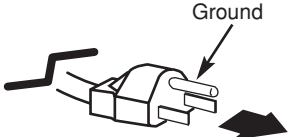
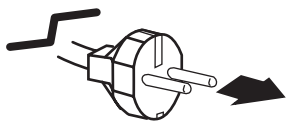
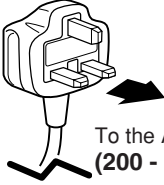
| Projector side | AC Outlet side | | |
|---|--|--|---|
|  <p data-bbox="240 1373 456 1444">To POWER CORD CONNECTOR on your projector.</p> | <p data-bbox="493 1171 795 1201">For the U.S.A. and Canada</p>  <p data-bbox="623 1381 792 1432">To the AC Outlet. (120 V AC)</p> | <p data-bbox="828 1171 1123 1201">For Continental Europe</p>  <p data-bbox="948 1394 1133 1444">To the AC Outlet. (200 - 240 V AC)</p> | <p data-bbox="1230 1171 1383 1201">For the U.K.</p>  <p data-bbox="1279 1373 1464 1423">To the AC Outlet. (200 - 240 V AC)</p> |

POSITIONING PROJECTOR

- This projector is designed to project on a flat projection surface.
- The projector can be focused from 5.3'(1.6m) ~ 40.0'(12.2m).
- Refer to the figure below to adjust a screen size.

ROOM LIGHT

The brightness in a room has a great influence on picture quality. It is recommended to limit ambient lighting in order to provide the best image.

H1 : H2 = 9 : 1

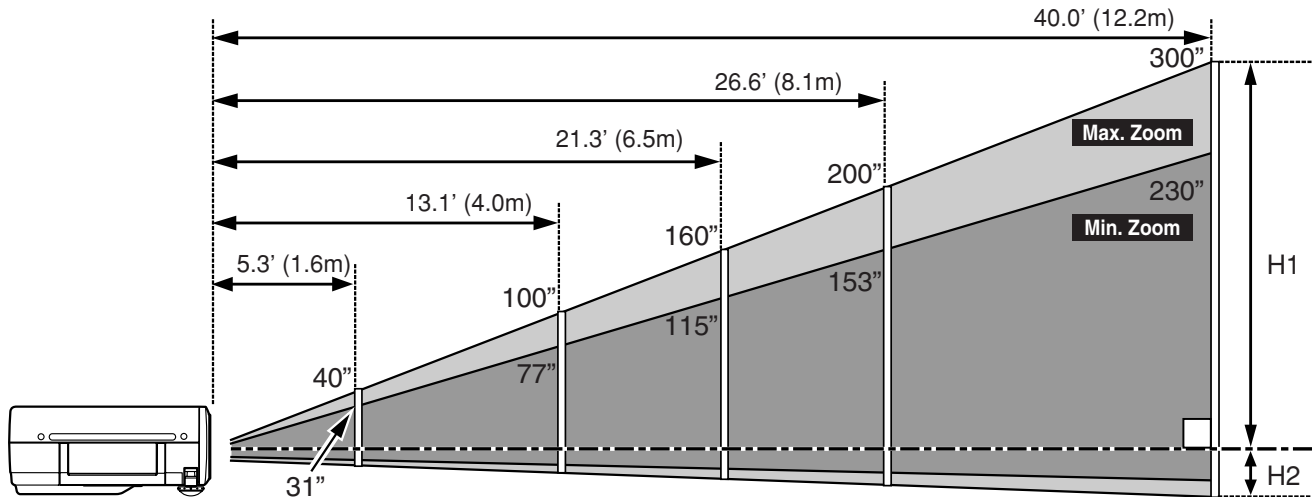

| Screen Size (W x H) mm | 31" | 40" | 100" | 160" | 200" | 300" |
|------------------------|-------------|-------------|--------------|--------------|---------------|---------------|
| Zoom (min) | 5.3' (1.6m) | 6.9' (2.1m) | 17.4' (5.3m) | 27.9' (8.5m) | 34.8' (10.6m) | — |
| Zoom (max) | — | 5.3' (1.6m) | 13.1' (4.0m) | 21.3' (6.5m) | 26.6' (8.1m) | 40.0' (12.2m) |

ADJUSTABLE FEET

Picture tilt and projection angle can be adjusted by rotating ADJUSTABLE FEET. Projection angle can be adjusted up to 15.6 degrees.

- 1 Lift the front of the projector and pull the FEET LOCK LATCHES on both sides of the projector.
- 2 Release the FEET LOCK LATCHES to lock the ADJUSTABLE FEET and rotate the ADJUSTABLE FEET to adjust the position and tilt.
- 3 To retract the ADJUSTABLE FEET, lift the front of the projector and pull and undo the FEET LOCK LATCHES.

Keystone distortion of the projected image can be adjusted by Menu Operation. Refer to page 20 and 35.



CAUTION

Tilt the projector within the adjustable range in order not to shorten the life of the lamp. Proper angle should be taken. Refer to page 10.

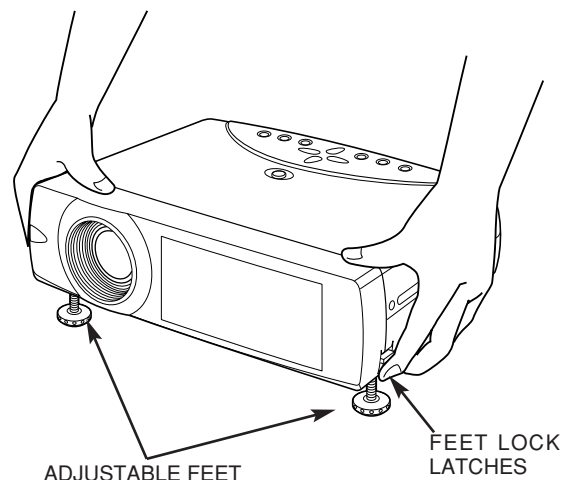

INSTALLING PROJECTOR IN PROPER POSITION

Install the projector properly. Improper installation may reduce the lamp lifetime and cause a fire hazard.

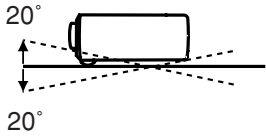

Do not tilt the projector more than 20 degrees above and below.



NO UPWARD

Do not point the projector up to project an image.



NO DOWNWARD

Do not point the projector down to project an image.



NO SIDEWAYS

Do not put the projector on either side to project an image.

MOVING PROJECTOR

Use Carry Handle when moving the projector.
When moving the projector, replace the Lens Cover and retract the Adjustable Feet to prevent damage to the lens and cabinet.
When the projector is not in use for an extended period, put it into the case (carrying bag) supplied with the projector.



CAUTION

Carrying Bag (supplied) is intended for protection from dust and scratches on the surface of a cabinet, and it is not designed to protect an appliance from external forces. Do not transport the projector through a courier or transport services with this bag. The projector can be damaged. When handling the projector, do not drop, bump, subject it to strong forces or put other things on the cabinet.

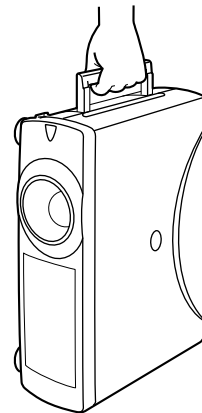

CAUTION IN CARRYING OR TRANSPORTING THE PROJECTOR

- Do not drop or bump the projector, otherwise damages or malfunctions may result.
- When carrying the projector, use a suitable carrying case.
- Do not transport the projector by using a courier or transport service in an unsuitable transport case. This may cause damage to the projector. To transport the projector through a courier or transport service, consult your dealer for best way.

CONNECTING PROJECTOR

TERMINALS OF PROJECTOR

This projector has input and output terminals on its back for connecting computers and video equipment. Refer to figures on pages 11 to 13 and connect properly.

S-VIDEO INPUT JACK

Connect the S-VIDEO output from video equipment to this jack. (Refer to P13.)

AUDIO INPUT JACKS

Connect the audio output from video equipment to these jacks. (Refer to P13.)

● When the audio output is monaural, connect it to L (MONO) jack.

VIDEO INPUT JACKS

Connect the composite video output from video equipment to VIDEO/Y jack or connect the component video outputs to VIDEO/Y, Pb/Cb and Pr/Cr jacks. (Refer to P13.)

AUDIO OUTPUT JACKS

Connect an external audio amplifier to these jacks. (Refer to P12, 13.)

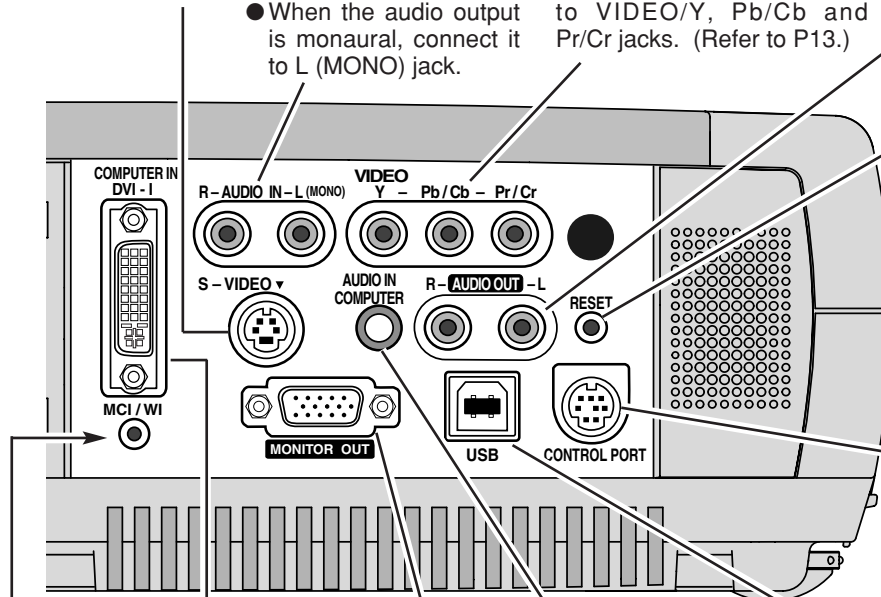

RESET BUTTON

This projector uses a micro processor to control this unit, and occasionally, this micro processor may malfunction and need to be reset. This can be done by pressing the RESET button with a pen, which will shut down and restart the unit. Do not use the RESET function excessively.

CONTROL PORT CONNECTOR

When controlling the computer with Remote Control of this projector, connect the mouse port of your personal computer to this connector. (Refer to P12.)

MONITOR OUTPUT TERMINAL

Connect a monitor to this terminal. This terminal outputs a computer input signal. (Refer to P12.)

COMPUTER AUDIO INPUT JACK

Connect the audio output (stereo) from computer to this jack. (Refer to P12.)

USB CONNECTOR (Series B)

When controlling the computer with the Remote Control of this projector, connect USB port of your personal computer to this connector. (Refer to P12.)

COMPUTER INPUT (DIGITAL/ANALOG) Media Card Imager / Wireless Imager TERMINAL

Connect computer output (Digital / Analog DVI-I type), Media Card Imager*, or Wireless Imager* to this terminal.

*optional accessories

* Do not press this button. This button is used for our optional accessories.

CONNECTING TO COMPUTER

Cables used for connection

- DVI-VGA Cable
- Control Cable for PS/2 Port
- VGA Cable (HDB 15 pin)
- DVI-Digital Cable (for Single Link T.M.D.S.)
- Control Cable for Serial Port , or ADB Port
- USB Cable
- MAC Adapter (When connecting to Macintosh computer)
- Audio Cables (RCA x 2 and Mini Plug (stereo) x 1)

DVI-VGA Cable and Control Cable for PS/2 Port are supplied with the projector.

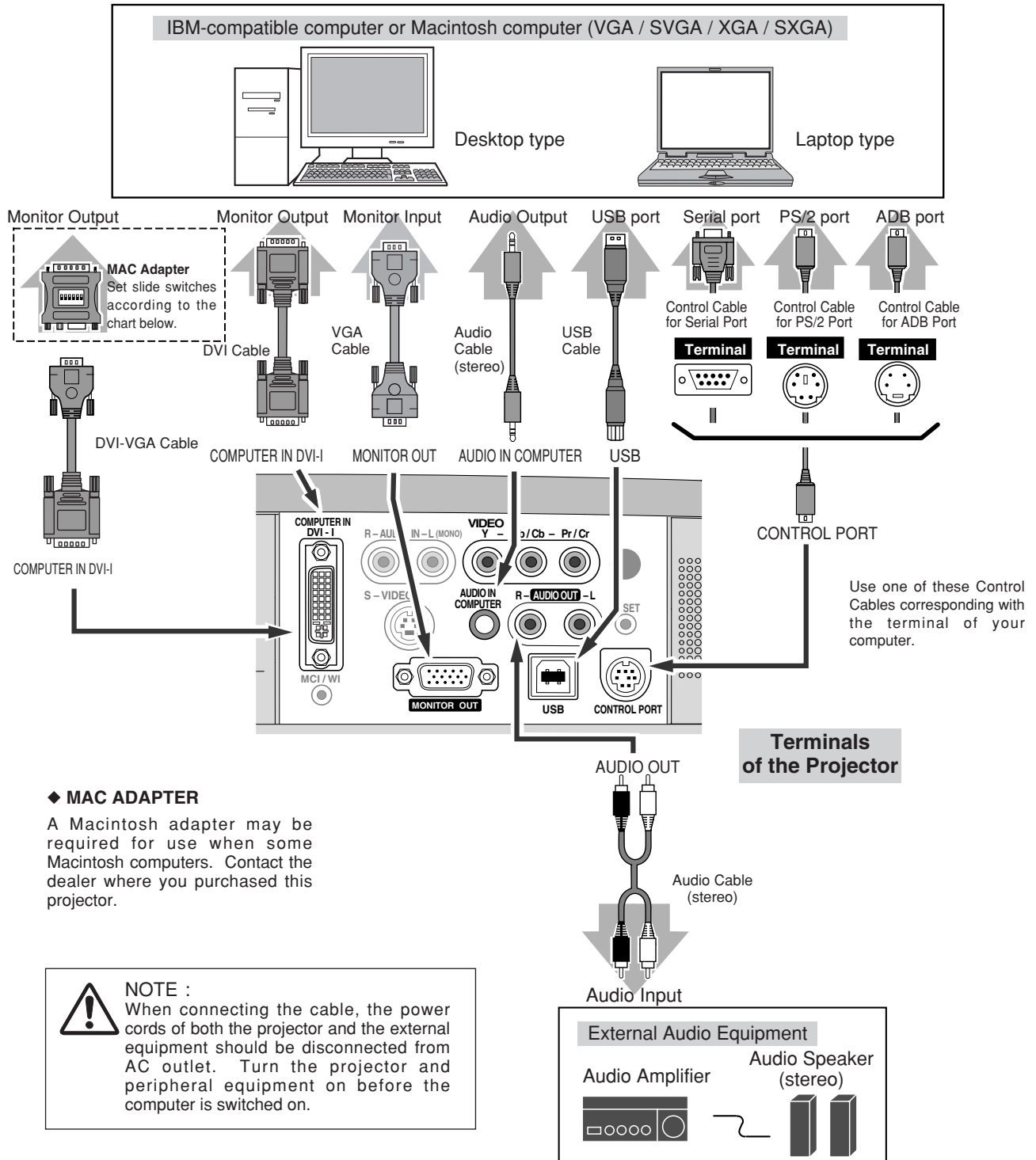

CONNECTING TO VIDEO EQUIPMENT

Cables used for connection

- Video Cable (RCA x 1 or RCA x 3)
- S-VIDEO Cable
- Audio Cable (RCA x 2)

These cables are not supplied with the projector.

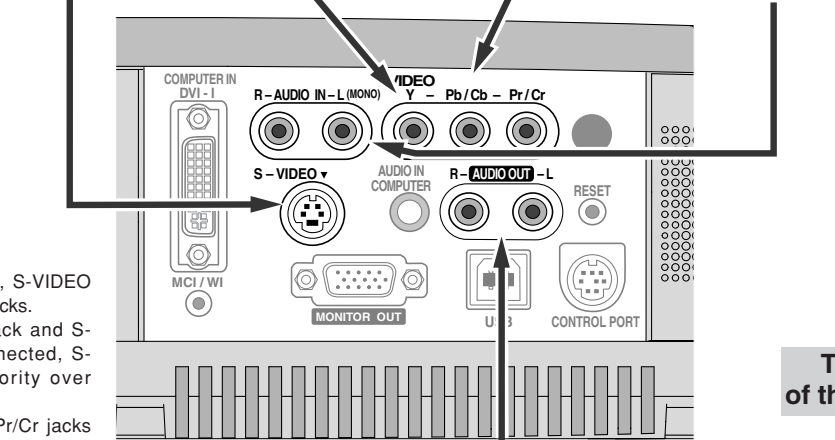
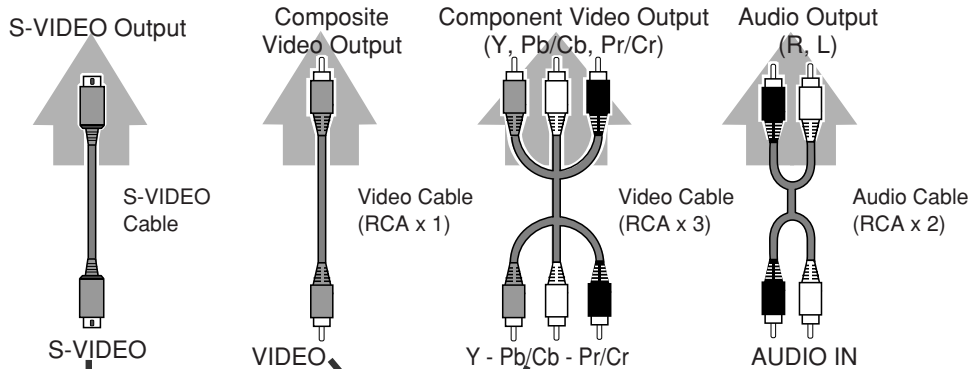
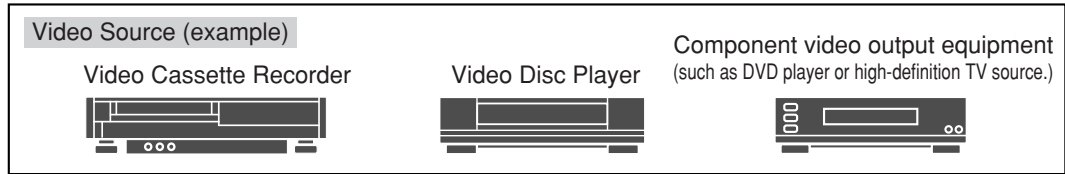

- Use any of VIDEO jack, S-VIDEO jack, or Y-Pb/Cb-Pr/Cr jacks.
- When both VIDEO jack and S-VIDEO jack are connected, S-VIDEO jack has priority over VIDEO jack.
 - When both Y-Pb/Cb-Pr/Cr jacks and S-VIDEO jack are connected, Y-Pb/Cb-Pr/Cr jacks has priority over S-VIDEO jack.

Terminals of the Projector

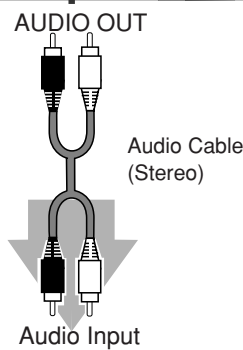

NOTE : When connecting the cable, the power cords of both the projector and the external equipment should be disconnected from AC outlet.

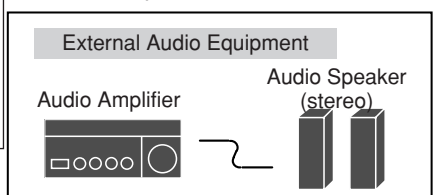

BEFORE OPERATION

OPERATION OF REMOTE CONTROL

Left Side

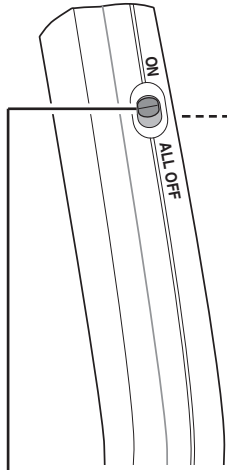

ALL-OFF SWITCH

When using the Remote Control, turn this switch to "ON." And turn it to "ALL OFF" when it is not used.

LASER POINTER INDICATOR

Lights red while laser beam is emitted from Laser Light Window.

MENU BUTTON

Used to select MENU operation. (P17, 18)

SELECT BUTTON

Used to execute the item selected, or to expand or compress the image in DIGITAL ZOOM +/- mode. (P28)
It is also used as a PC mouse in Wireless Mouse Operation. (P38)

LASER BUTTON

Used to operate Laser Pointer Function. Laser beam is emitted while pressing this button within 1 minute.
When using this Laser Pointer for more than 1 minute, release the LASER button and press it again.

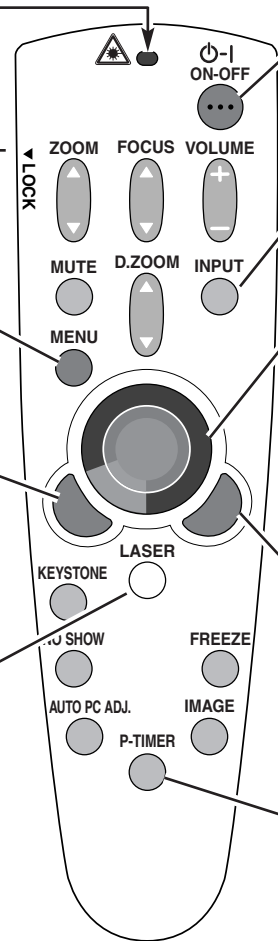

POWER ON-OFF BUTTON

Used to turn the projector on or off. (P19)

INPUT BUTTON

Used to select input source. (P22, 29)

POINT BUTTON

Used to move the pointer on ON-SCREEN MENU, adjust each item, or pan image in DIGITAL ZOOM +/- mode. (P28)

It is also used as a PC mouse in Wireless Mouse Operation. (P38)
* When pressing the center of this button, it works as SELECT button.

RIGHT CLICK BUTTON

Used as a PC mouse in Wireless Mouse Operation. (P38)

P-TIMER BUTTON

Used to operate P-TIMER function. (P21)

LASER POINTER FUNCTION

This Remote Control emits a laser beam as laser pointer function from the Laser Light Window. When the LASER button is pressed, laser light goes on. And when the LASER button is being pressed for more than 1 minute or the LASER button is released, light goes off. The LASER POINTER INDICATOR lights RED and Laser is emitted with RED light to indicate laser beam is being emitted.

The Laser emitted is a class II laser; therefore, do not look into the Laser Light Window or shine the laser beam on yourself or other people. Three marks below are caution labels for laser beam.

CAUTION : Use of controls, adjustments or performance of procedures other than those specified herein may result hazardous radiation exposure.

LASER POINTER INDICATOR

Laser Light Window

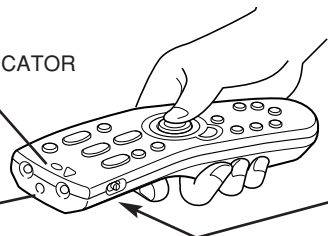

These caution labels are put on the Remote Control Unit.

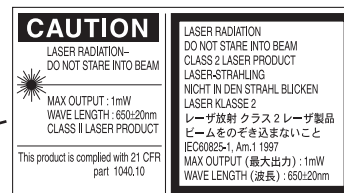

AVOID EXPOSURE-LASER RADIATION IS EMITTED FROM THIS APERTURE
レーザー光の出口
ビームをのぞき込まないこと

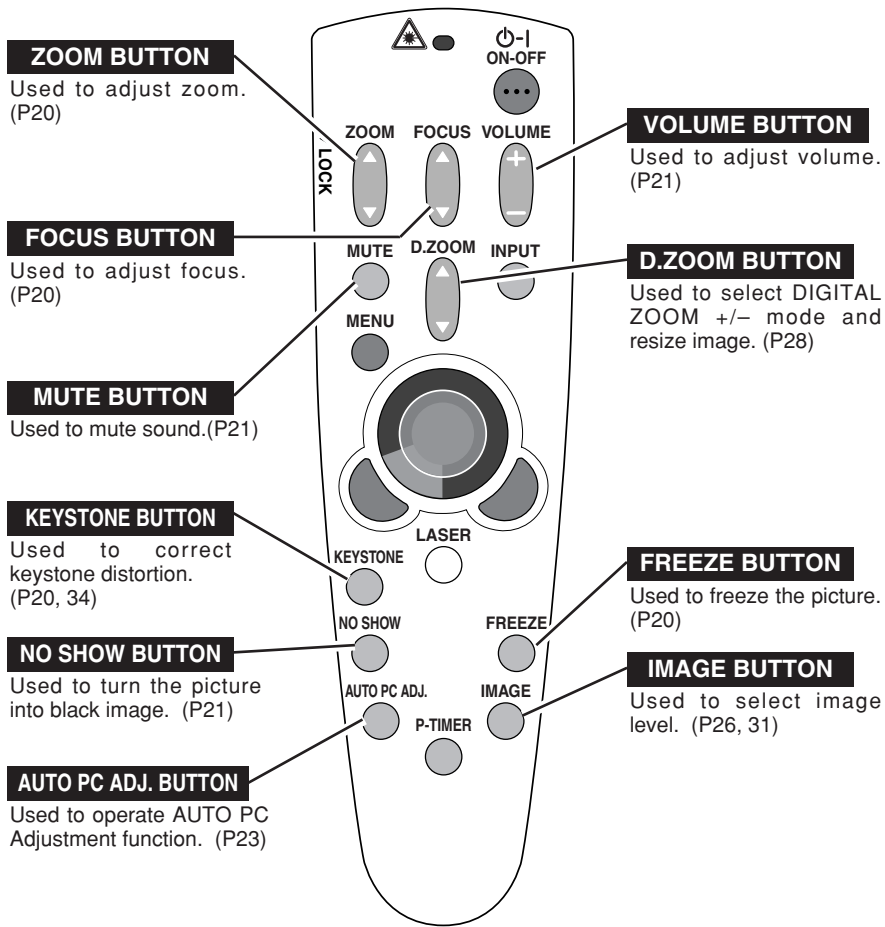

Operating Range

Point the Remote Control toward projector (Infrared Remote Receiver) whenever pressing any button. Maximum operating range for Remote Control is about 16.4' (5m) and 60° in front and rear of the projector.

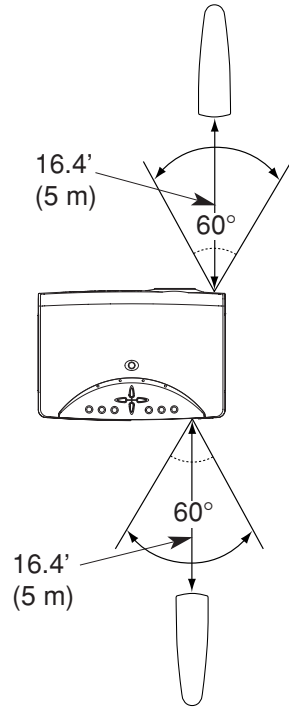

REMOTE CONTROL BATTERIES INSTALLATION

1 Remove the battery compartment lid.

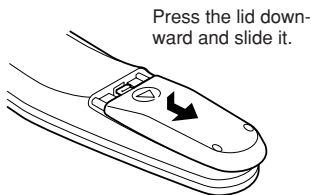

2 Slide the batteries into the compartment.

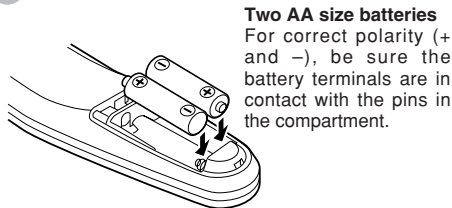

3 Replace the compartment lid.

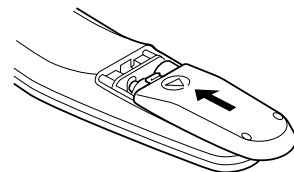

To insure safe operation, please observe the following precautions :

- Use (2) AA, UM3 or R06 type alkaline batteries.
- Replace two batteries at the same time.
- Do not use a new battery with a used battery.
- Avoid contact with water or liquid.
- Do not expose the Remote Control to moisture, or heat.
- Do not drop the Remote Control.
- If a battery has leaked on Remote Control, carefully wipe case clean and install new batteries.
- Risk of explosion if battery is replaced by an incorrect type.
- Dispose of used batteries according to the instructions.

TOP CONTROLS AND INDICATORS

This projector has CONTROL BUTTONS (TOP CONTROLS) and INDICATORS on its top.

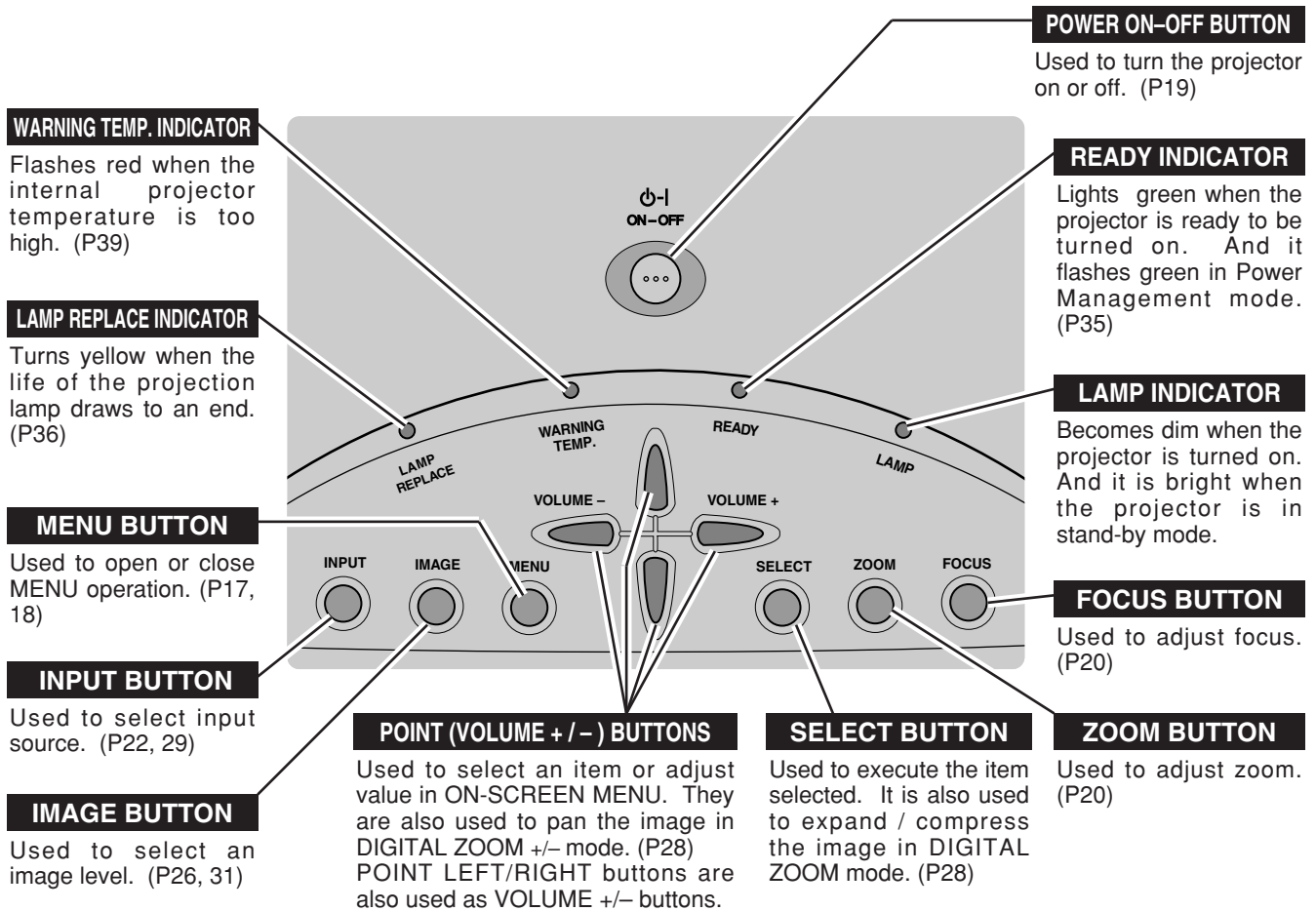

OPERATING ON-SCREEN MENU

HOW TO OPERATE ON-SCREEN MENU

You can control and adjust this projector through the ON-SCREEN MENU. Refer to the following pages to operate each adjustment on the ON-SCREEN MENU.

1 DISPLAY MENU

Press the MENU button to display the ON-SCREEN MENU.

2 MOVING POINTER

Move the pointer (* see below) or adjust the value of an item by pressing the POINT button(s) on the Top Control or on the Remote Control.

* Pointer is the icon on the ON-SCREEN MENU to select an item. See the figures on the section "FLOW OF ON-SCREEN MENU OPERATION" below.

3 SELECT ITEM

Select the item or set the selected function by pressing the SELECT button.

REMOTE CONTROL

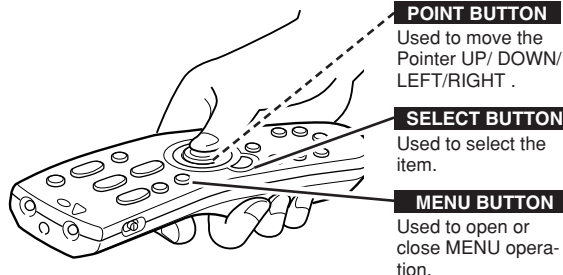

TOP CONTROL

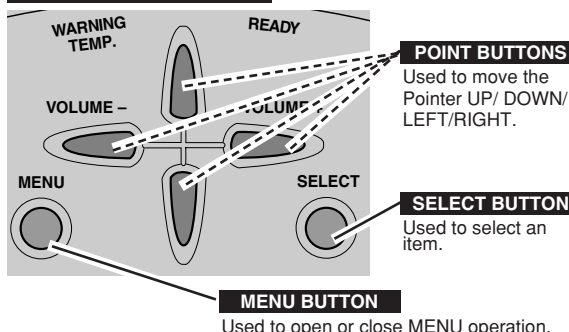

FLOW OF ON-SCREEN MENU OPERATION

Display ON-SCREEN MENU

1 Press the MENU button to display the ON-SCREEN MENU (MENU BAR). A red frame is a POINTER.

Select Menu to be adjusted

2 Move the POINTER (red frame) to the MENU ICON that you want to select by pressing the POINT LEFT / RIGHT buttons.

Control or adjust item through ON-SCREEN MENU

3 Press the POINT DOWN button and move the POINTER (red frame or red arrow) to the ITEM that you want to adjust, and then press the SELECT button to show the ITEM DATA.

4 Adjust the ITEM DATA by pressing the POINT LEFT / RIGHT buttons. Refer to the following pages for details of respective adjustments.

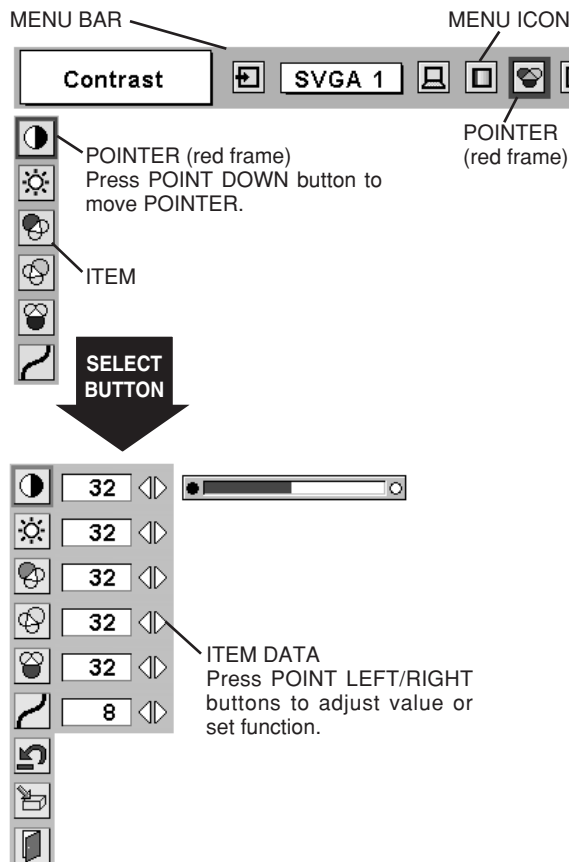

MENU BAR

FOR PC SOURCE

Press the MENU BUTTON while connecting to PC input source.

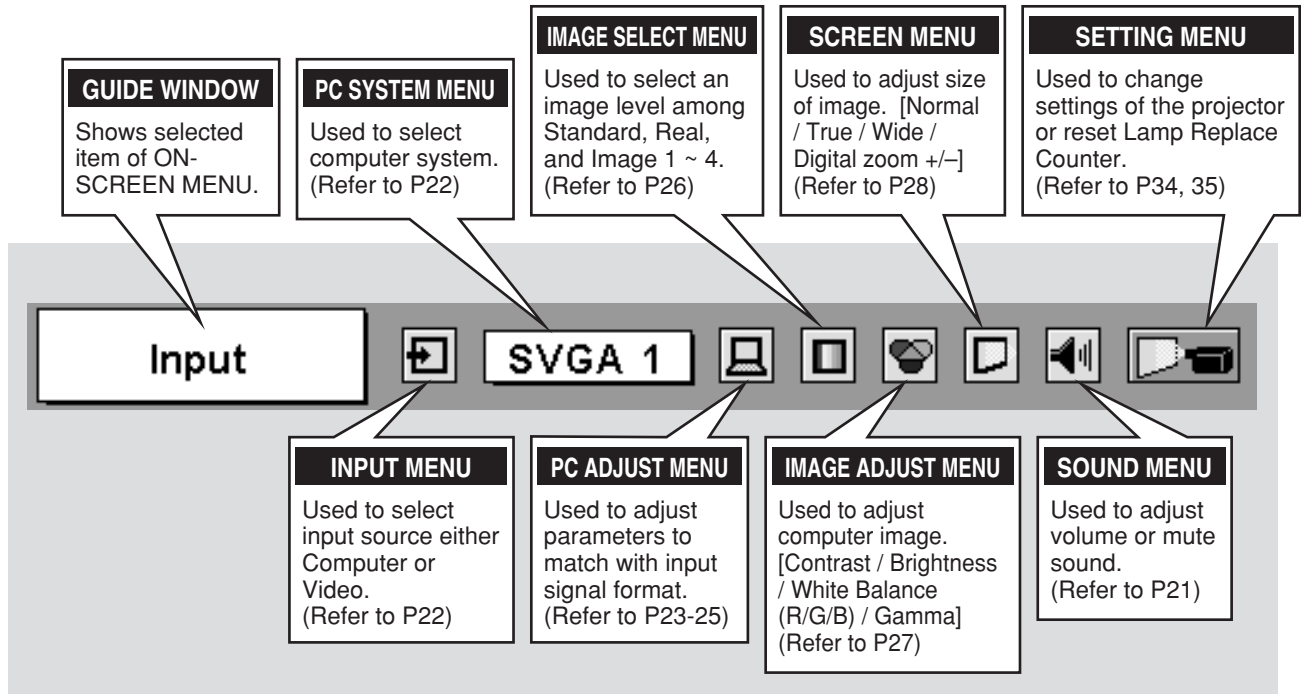

FOR VIDEO SOURCE

Press the MENU BUTTON while connecting to VIDEO input source.

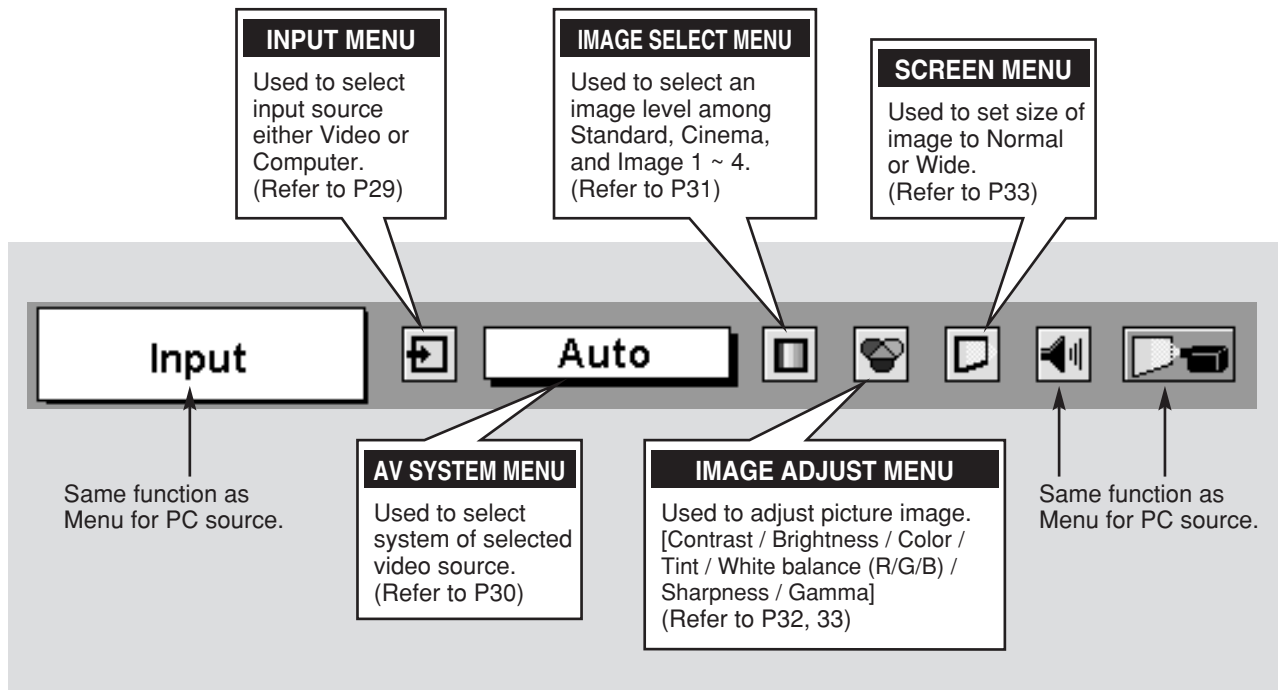

TURNING ON / OFF PROJECTOR

TURNING ON PROJECTOR

- 1 Complete peripheral connections (with Computer, VCR, etc.) before turning on the projector. (Refer to "CONNECTING PROJECTOR" on page 11~13.)
- 2 Connect the projector's AC Power Cord into an AC outlet. The LAMP Indicator lights red, and the READY Indicator lights green.

NOTE : When "On start" function is ON, this projector is turned on automatically by connecting AC Power Cord to an AC outlet. (Refer to the menu item "On start" on page 35.)
- 3 Press the POWER ON-OFF button on the Top Control or on the Remote Control to ON. The LAMP Indicator dims, and the Cooling Fans start to operate. The Preparation Display appears on the screen and the count-down starts.
- 4 The input source that was selected last and the Lamp mode status icon appear on the screen after the count-down. The signal from PC or Video source appears after 30 seconds.

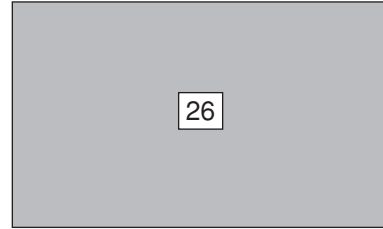

The Preparation Display disappears after 30 seconds.

Lamp mode

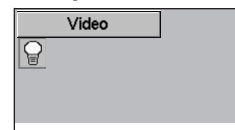

*Refer to page 35 for the Lamp mode.

TURNING OFF PROJECTOR

- 1 Press the POWER ON-OFF button on the Top Control or on the Remote Control, and a message "Power off?" appears on a screen.
- 2 Press the POWER ON-OFF button again to turn off the projector. The LAMP Indicator lights bright and the READY Indicator turns off. After the projector is turned off, the Cooling Fans operate (for 90 seconds).
- 3 When the projector has cooled down, the READY Indicator lights green again.

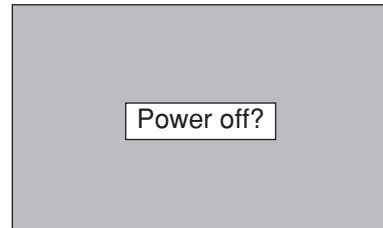

The message disappears after 4 seconds.

NOTE : The Projector cannot be turned on during cooling period with the READY Indicator off. You can turn it on again after the READY Indicator lights green.



TO MAINTAIN THE LIFE OF LAMP, ONCE YOU TURN PROJECTOR ON, WAIT AT LEAST 5 MINUTES BEFORE TURNING IT OFF.
DO NOT DISCONNECT AC POWER CORD BEFORE READY INDICATOR LIGHTS GREEN.

note on operation

Do not use the projector for more than 24 hours continuously. Turn off the projector at least once in 24 hours and give it a rest. Continuous use may result in shortening the lamp lifetime.

When the "Power management" function is ON, the projector detects signal interruption and turns off the Projection lamp automatically. Refer to "Power management" on page 35.

When the WARNING TEMP. indicator flashes red, the projector is automatically turned off. Wait at least 5 minutes before turning on the projector again. (Refer to the section "WARNING TEMP. INDICATOR" on page 39.)

ADJUSTING SCREEN

ZOOM ADJUSTMENT

- 1** Press the ZOOM button on the Top Control or the ZOOM ▲/▼ button on the Remote Control. The message “Zoom” is displayed.
- 2** Press the ZOOM ▲ button or the POINT UP button to make image larger, and press the ZOOM ▼ button or the POINT DOWN button to make image smaller.

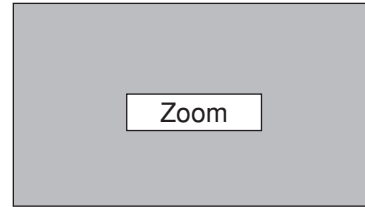

Message disappears after 4 seconds.

FOCUS ADJUSTMENT

- 1** Press the FOCUS button on the Top Control or the FOCUS ▲/▼ button on the Remote Control. The message “Focus” is displayed.
- 2** Adjust focus of image by pressing the FOCUS ▲/▼ button or the POINT UP/DOWN button(s) .

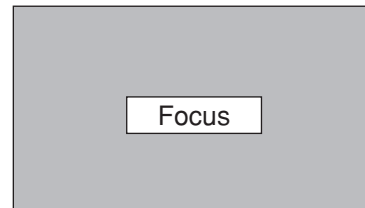

Message disappears after 4 seconds.

KEYSTONE ADJUSTMENT

If the projected picture has keystone distortion, correct the image with KEYSTONE adjustment.

- 1** Press the KEYSTONE button on the Remote Control or select Keystone in the SETTING menu. (Refer to page 34.) The keystone dialog box appears.
- 2** Correct keystone distortion by pressing the POINT UP/DOWN/LEFT/RIGHT button(s). Press the POINT UP button to reduce the upper part of the image, and press the POINT DOWN button to reduce the lower part. Press the POINT LEFT button to reduce the left part, and press the POINT RIGHT button to reduce the right part.



- The arrows are white when there is no correction.
- The direction of the arrow being corrected turns red.
- The arrow(s) disappear(s) at the maximum correction.

Reduce the upper width with POINT UP button.

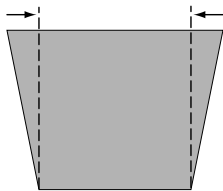

Reduce the lower width with POINT DOWN button.

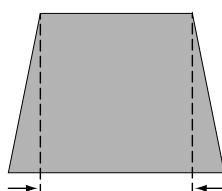

Reduce the left part with POINT LEFT button.

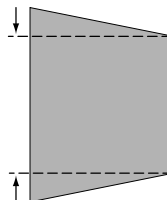

Reduce the right part with POINT RIGHT button.

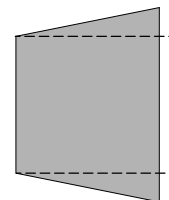

PICTURE FREEZE FUNCTION

Press the FREEZE button on the Remote Control to freeze the picture on-screen. To cancel the FREEZE function, press the FREEZE button again or press any other button.

NO SHOW FUNCTION

Press the NO SHOW button on the Remote Control to black out the image. To restore to normal, press the NO SHOW button again or press any other button.

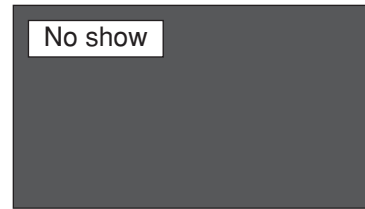

Message disappears after 4 seconds.

P-TIMER FUNCTION

Press the P-TIMER button on the Remote Control. The timer display "00 : 00" appears on the screen and the timer starts to count time (00 : 00 ~ 59 : 59).

To stop P-TIMER display, press the P-TIMER button. And then, press the P-TIMER button again to cancel the P-TIMER function.



SOUND ADJUSTMENT

DIRECT OPERATION

Volume

Press the VOLUME (+/-) button(s) on the Top Control or on the Remote Control to adjust volume. The volume dialog box appears on the screen for a few seconds.

(+) button to increase volume, and (-) button to decrease.

Mute

Press the MUTE button on the Remote Control to cut off sound. To restore sound to its previous level, press the MUTE button again or press the Volume (+/-) button(s).

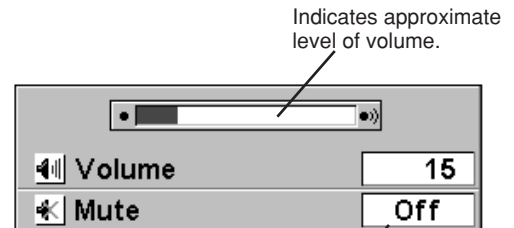

Press the MUTE button to set Mute function On or Off.

The display disappears after 4 seconds.

MENU OPERATION

1 Press the MENU button and the ON-SCREEN MENU will appear. Press the POINT LEFT/RIGHT buttons to move the red frame pointer to the SOUND Menu icon.

2 Press the POINT DOWN button to move the red frame pointer to the item that you want to select, and then press the SELECT button.



Volume

To increase volume, press the POINT RIGHT button, and press the POINT LEFT button to decrease volume.



Mute

Press the POINT LEFT/RIGHT button(s) to cut off sound. Dialog box display is changed to "On" and sound is cut off. To restore sound to its previous level, press the POINT LEFT/RIGHT button(s) again.

SOUND MENU

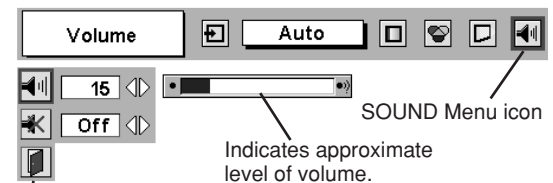

Close SOUND Menu.

COMPUTER INPUT

SELECTING INPUT SOURCE

DIRECT OPERATION

Choose Computer by pressing the INPUT button on the Top Control or on the Remote Control.

If the projector cannot reproduce proper image, select correct input source through MENU OPERATION (see below).

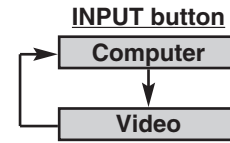

MENU OPERATION

- 1 Press the MENU button and the ON-SCREEN MENU will appear. Press the POINT LEFT/RIGHT button to move the red frame pointer to the INPUT Menu icon.
- 2 Press the POINT DOWN button to move the red arrow pointer to Computer and then press the SELECT button. The Source Select Menu will appear.
- 3 Move the pointer to either RGB (Digital) or RGB (Analog) and then press the SELECT button.

RGB (Digital) When digital signal is connected to DVI terminal, select Digital.

RGB (Analog) When analog signal is connected to DVI terminal, select Analog.

INPUT MENU

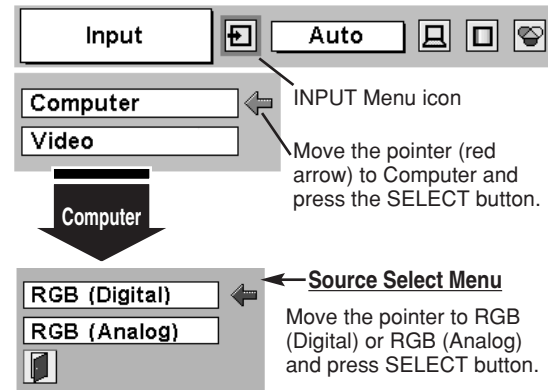

SELECTING COMPUTER SYSTEM

This projector accepts various kinds of computer signals including VGA, SVGA, XGA, and SXGA. By selecting Computer input as a signal source, it automatically detects the signal format and tune itself to project a proper image without any additional settings. (Signal formats provided in this projector is shown on page 43.)

Note : The projector displays one of the Auto, ---, Mode 1/2/3/4/5, or the system provided in the projector.

Auto When the projector cannot recognize a connected signal as a PC system provided in this projector, the Auto PC Adjustment function operates to adjust the projector and the message "Auto" is displayed on the SYSTEM Menu icon. (Refer to P23.) When the image is not provided properly, manual adjustment is required. (Refer to P24 and 25.)

--- There is no signal input from the connected computer. Make sure the connection of the computer and the projector is set correctly. (Refer to TROUBLESHOOTING on page 40.)

PC SYSTEM MENU

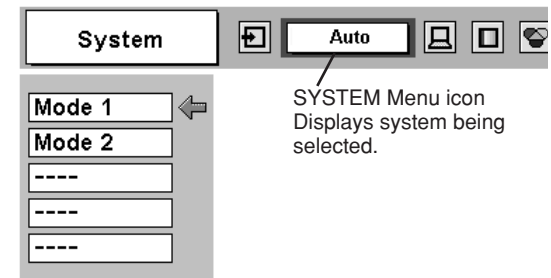

SELECT COMPUTER SYSTEM MANUALLY

PC system can also be selected manually.

- 1 Press the MENU button and the ON-SCREEN MENU will appear. Press the POINT LEFT/RIGHT buttons to move the red frame pointer to the PC SYSTEM Menu icon.
- 2 Press the POINT DOWN button to move the red arrow pointer to the system that you want to set, and then press the SELECT button.

PC SYSTEM MENU

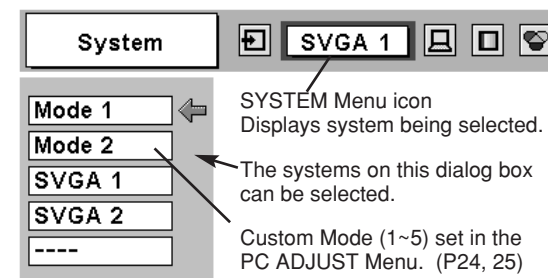

PC ADJUSTMENT

AUTO PC ADJUSTMENT

Auto PC Adjustment function is provided to automatically adjust Fine sync, Total dots and Picture Position to conform to your computer. Auto PC Adjustment function can be operated as follows.



Auto PC Adj.

- 1 Press the MENU button and the ON-SCREEN MENU will appear. Press the POINT LEFT/RIGHT button to move the red frame pointer to the PC ADJUST Menu icon.
- 2 Press the POINT DOWN button to move the red frame pointer to the AUTO PC Adj. icon and then press the SELECT button twice.
This Auto PC Adjustment can also be executed by pressing the AUTO PC ADJ. button on the Remote Control.

Store adjustment parameters.

Adjustment parameters from Auto PC Adjustment can be memorized in this projector. Once parameters are memorized, the setting can be done just by selecting Mode in PC SYSTEM Menu (P22). Refer to step 3 of the MANUAL PC ADJUSTMENT section (P25).

PC ADJUST MENU

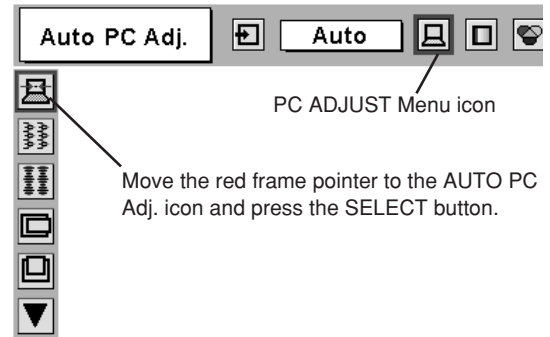

NOTE

- The PC ADJUST Menu cannot be operated when the input signal is digital or RGB is selected in the PC SYSTEM Menu.
- The Fine sync, Total dots, Horizontal, and Vertical of some computers cannot be fully adjusted with this Auto PC Adjustment function. When the image is not provided properly through this function, manual adjustments are required. (Refer to page 24, 25.)
- Auto PC Adjustment function cannot be operated when "RGB," "720p (HDTV)," "1035i (HDTV)" or "1080i (HDTV)" is selected on the PC SYSTEM Menu (P22).

MANUAL PC ADJUSTMENT

This projector can automatically tune the display signals from most personal computers currently distributed. However, some computers employ the special signal formats which may not be turned by Multi-Scan system of this projector. In this case, the image may be recognized as a flickering picture, a non-synchronized picture, a non-centered picture or a skewed picture, and projected improperly.

The MANUAL PC ADJUSTMENT function allows you to manually adjust several parameters to match these special signal formats. Also, you can store these adjusted parameters in the 5 independent memory areas, enabling you to call up whenever you need.

1 Press the MENU button and the ON-SCREEN MENU will appear. Press the POINT LEFT/RIGHT button to move the red frame pointer to the PC ADJUST Menu icon.

2 Press the POINT DOWN button to move the red frame pointer to the item that you want to adjust and then press the SELECT button. An adjustment dialog box will appear. Press the POINT LEFT/RIGHT button to adjust value.



Fine sync

Adjusts an image as necessary to eliminate flicker from the display. Press the POINT LEFT/RIGHT button to adjust value.(From 0 to 31.)



Total dots

The number of total dots in one horizontal period. Press the POINT LEFT/RIGHT button(s) and adjust number to match your PC image.



Horizontal

Adjusts horizontal picture position. Press the POINT LEFT/RIGHT button(s) to adjust the position.



Vertical

Adjusts vertical picture position. Press the POINT LEFT/RIGHT button(s) to adjust the position.



Current mode

Press the SELECT button to show the information of the computer selected.



Clamp

Adjusts clamp level. When the image has a dark bar(s), try this adjustment.

PC ADJUST MENU

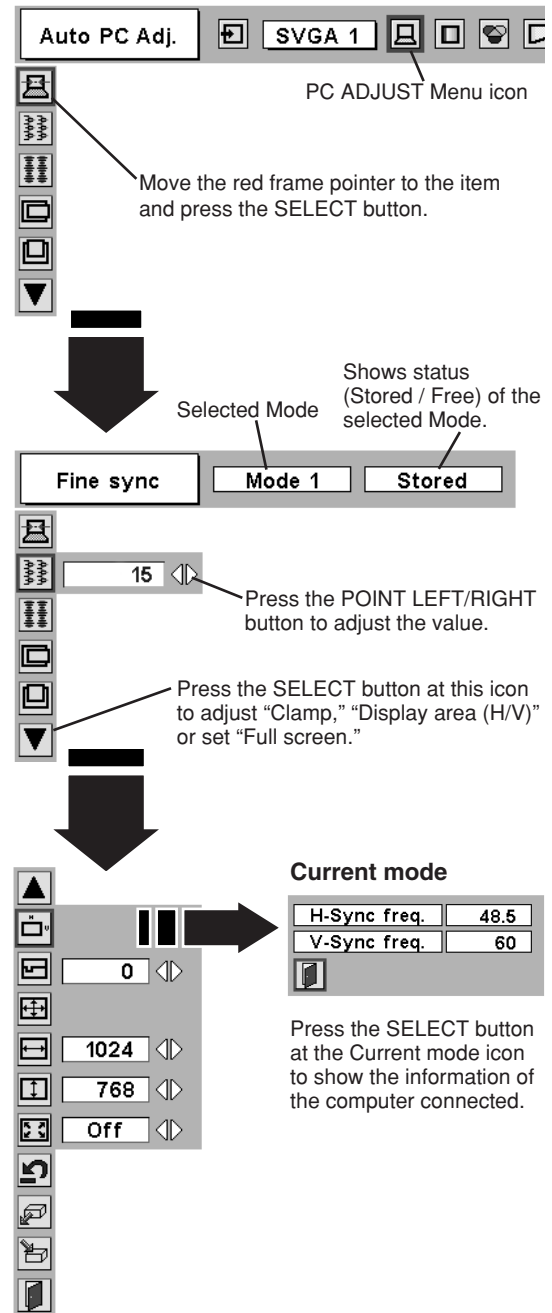

 **Display area**

Selects the area displayed by this projector. Select the resolution at the Display area dialog box.

 **Display area H**

Adjustment of the horizontal area displayed by this projector. Press the POINT LEFT/RIGHT button(s) to decrease/increase value and then press the SELECT button.

 **Display area V**

Adjustment of the vertical area displayed with this projector. Press the POINT LEFT/RIGHT button(s) to decrease/increase value and then press the SELECT button.

 **Full screen**

Press the POINT LEFT/RIGHT button(s) to switch the Full screen function to "On" or "Off." Set "On" to resize the image with 4 x 3 aspect ratio to fit the screen.

NOTE : Fine sync, Total dots, Display area (H/V), and Full screen cannot be adjusted when "1035i (HDTV)" or "1080i (HDTV)" is selected in the PC SYSTEM Menu (P22).

3  **Store**

To store adjustment parameters, move the red frame pointer to the Store icon and then press the SELECT button. Move the red arrow pointer to any of Mode 1 to 5 that you want to store to and then press the SELECT button.

 **Mode free**

To clear adjustment parameters previously set, move the red frame pointer to Mode free icon and then press the SELECT button. Move the red arrow pointer to the Mode that you want to clear and then press the SELECT button.

Other icons operate as follows.

 **Reset**

Reset all adjustment to their previous figure.

 **Quit**

Closes the PC ADJUST MENU.

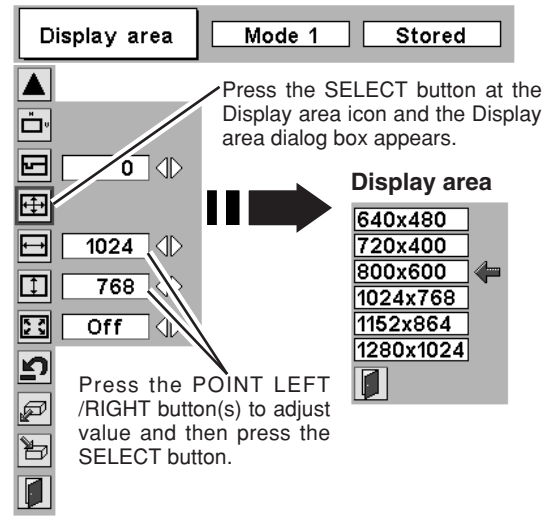

To store adjustment data.

This Mode has parameters being stored.

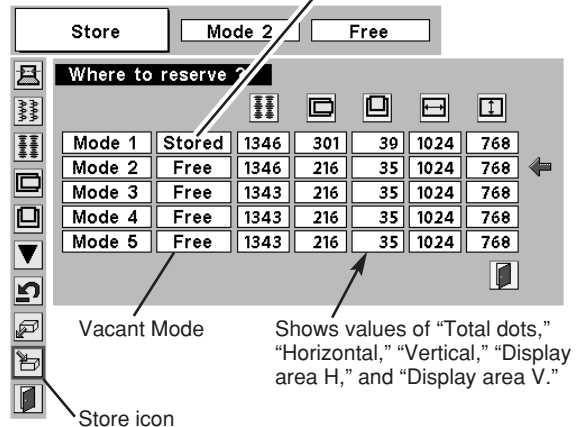

To clear adjustment data.

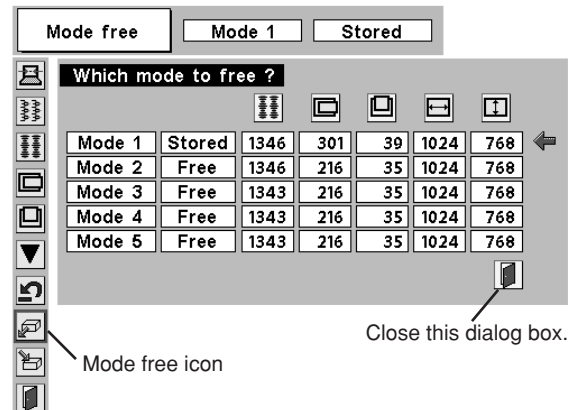

PICTURE IMAGE ADJUSTMENTS

IMAGE LEVEL SELECT (DIRECT)

Select an image level among Standard, Real, Image 1, Image 2, Image 3 and Image 4 by pressing the IMAGE button on the Top Control or on the Remote Control.

Standard

Normal picture level preset on this projector.

Real

Picture level with improved halftone for graphics.

IMAGE 1~4

User preset picture adjustment in the IMAGE ADJUST Menu (P27).

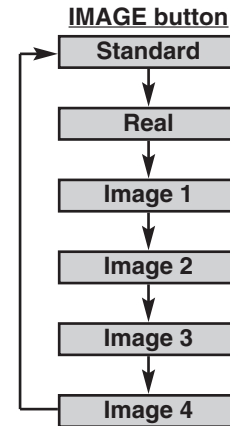

IMAGE LEVEL SELECT (MENU)

- 1 Press the MENU button and the ON-SCREEN MENU will appear. Press the POINT LEFT/RIGHT button to move the red frame pointer to the IMAGE SELECT Menu icon.
- 2 Press the POINT DOWN button to move the red frame pointer to the level that you want to set and then press the SELECT button.

 **Standard**

Normal picture level preset on this projector.

 **Real**

Picture level with improved halftone for graphics.

 **IMAGE 1~4**

User preset picture adjustment in the IMAGE ADJUST Menu (P27).

IMAGE SELECT MENU

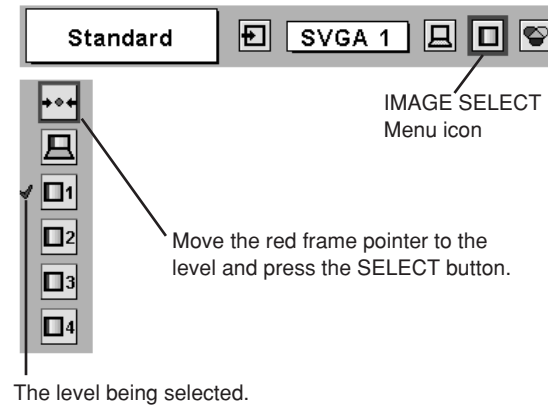

IMAGE LEVEL ADJUSTMENT

- 1 Press the MENU button and the ON-SCREEN MENU will appear. Press the POINT LEFT/RIGHT buttons to move the red frame pointer to the IMAGE ADJUST Menu icon.
- 2 Press the POINT DOWN button to move the red frame pointer to the item that you want to adjust, and then press the SELECT button. The level of each item is displayed. Adjust each level by pressing the POINT LEFT/RIGHT button(s).

Contrast

Press the POINT LEFT button to decrease contrast and the POINT RIGHT button to increase contrast. (From 0 to 63.)

Brightness

Press the POINT LEFT button to adjust image darker and the POINT RIGHT button to adjust brighter. (From 0 to 63.)

White balance (Red)

Press the POINT LEFT button to lighten red tone and the POINT RIGHT button to deepen red tone. (From 0 to 63.)

White balance (Green)

Press the POINT LEFT button to lighten green tone and the POINT RIGHT button to deepen green tone. (From 0 to 63.)

White balance (Blue)

Press the POINT LEFT button to lighten blue tone and the POINT RIGHT button to deepen blue tone. (From 0 to 63.)

Gamma

Press either the POINT LEFT button or the POINT RIGHT button to obtain better balance of contrast. (From 0 to 15.)

3 Store

To store manually preset image, move the red frame pointer to the Store icon and press the SELECT button. The Image Level Menu will appear. Move the red frame pointer to the Image 1 to 4 where you want to set and then press the SELECT button.

Other icons operate as follows.

Reset

Reset all adjustment to their previous levels.

Quit

Closes the IMAGE MENU.

IMAGE ADJUST MENU

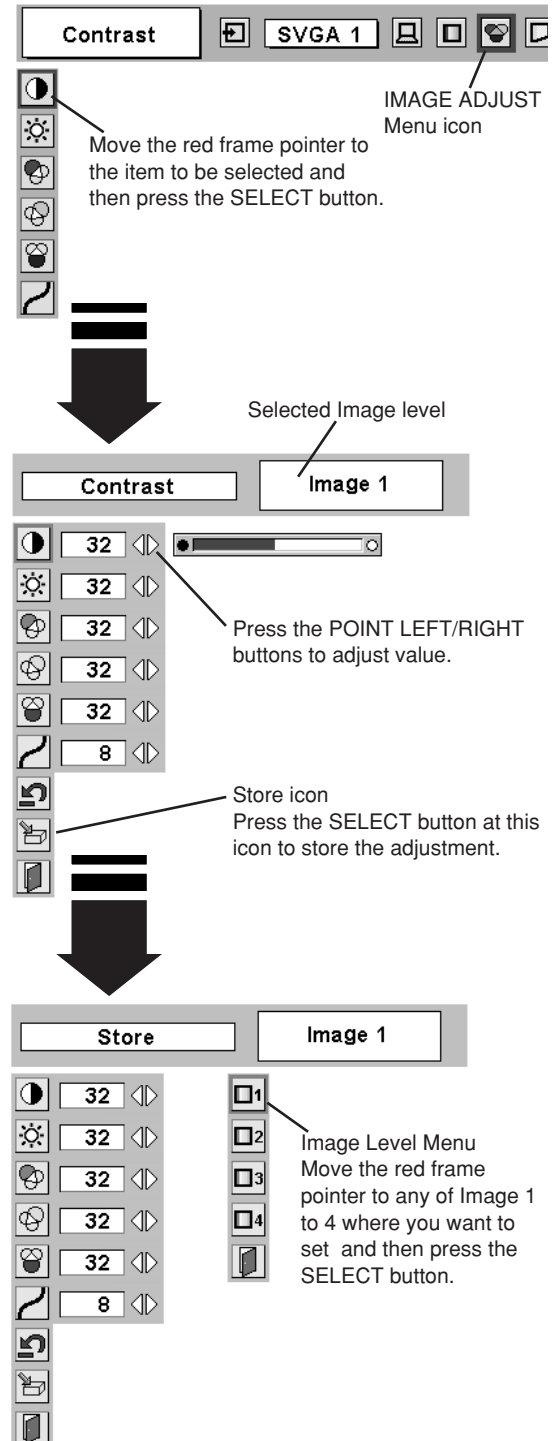

PICTURE SCREEN ADJUSTMENT

This projector has a picture screen resize function, which enables you to display the desirable image size.

- 1 Press the MENU button and the ON-SCREEN MENU will appear. Press the POINT LEFT/RIGHT button(s) to move the red frame pointer to the SCREEN Menu icon.
- 2 Press the POINT DOWN button and move the red frame pointer to the function that you want to select and then press the SELECT button.



Normal

Provides image to fit screen size.



True

Provides image in its original size. When the original image size is larger than screen size (1024 x 768), this projector enters "Digital zoom +" mode automatically.



Wide

Provides image to fit wide video aspect ratio (16 : 9) by expanding image width uniformly. This function can be used for providing a squeezed video signal at 16 : 9.



Digital zoom +

When Digital zoom + is selected, the ON-SCREEN MENU disappears and the message "D. Zoom +" is displayed. Press the SELECT button to expand image size. And press the POINT UP/DOWN/LEFT/RIGHT button(s) to pan the image. The panning function can work only when the image is larger than screen size.

A projected image can be also expanded by pressing the D.ZOOM ▲ button on the Remote Control.



Digital zoom -

When Digital zoom - is selected, the ON-SCREEN MENU disappears and the message "D. Zoom -" is displayed. Press the SELECT button to compress image size.

A projected image can be also compressed by pressing the D.ZOOM ▼ button on the Remote Control.

To cancel Digital Zoom +/- mode, press any button except the D.ZOOM ▲/▼, SELECT, and POINT buttons.

SCREEN MENU

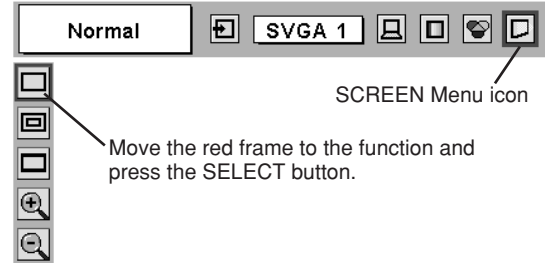

NOTE

- This SCREEN Menu cannot be operated when "1035i (HDTV)" or "1080i (HDTV)" is selected in the PC SYSTEM Menu (P22).
- Wide cannot be selected when "720p (HDTV)" is selected in the PC SYSTEM Menu (P22).
- True and Digital zoom +/- cannot be selected when "RGB" is selected in the PC SYSTEM Menu (P22).
- This projector cannot display any resolution higher than 1280 X 1024. If your computer's screen resolution is higher than 1280 X 1024, reset the resolution to the lower before connecting projector.
- The image data in other than XGA (1024 x 768) is modified to fit the screen size in initial mode.
- The panning function may not operate properly if the computer system prepared in the PC ADJUST Menu is used.

SELECTING INPUT SOURCE

DIRECT OPERATION

Choose Video by pressing the INPUT button on the Top Control or on the Remote Control.

If the projector cannot reproduce proper video source, select correct input source through MENU OPERATION (see below).

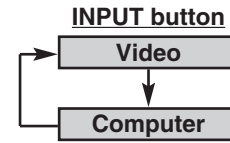

MENU OPERATION

- 1 Press the MENU button and the ON-SCREEN MENU will appear. Press the POINT LEFT/RIGHT button to move the red frame pointer to the INPUT Menu icon.
- 2 Press the POINT DOWN button to move the red arrow pointer to Video and then press the SELECT button. The Source Select Menu will appear.
- 3 Move the pointer to the source that you want to select and then press the SELECT button.

Auto

When selecting Auto, the projector automatically detects incoming video signal, and adjusts itself to optimize its performance. The projector selects connection in the following order:

- 1st Y-Pb/Cb-Pr/Cr
- 2nd S-VIDEO
- 3rd VIDEO

The Y-Pb/Cb-Pr/Cr has priority over the S-VIDEO. The S-VIDEO has priority over the VIDEO.

Video

When video input signal is connected to the VIDEO jack, select Video.

S-Video

When video input signal is connected to the S-VIDEO jack, select S-Video.

Y,Pb/Cb,Pr/Cr

When video input signal is connected to the Y-Pb/Cb-Pr/Cr jacks, select Y, Pb/Cb, Pr/Cr.

INPUT MENU

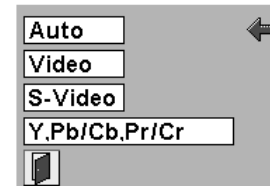
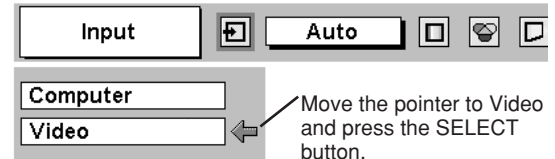

Source Select Menu (VIDEO)

Move the pointer to the source and press the SELECT button.

SELECTING VIDEO SYSTEM

- 1 Press the MENU button and the ON-SCREEN MENU will appear. Press the POINT LEFT/RIGHT buttons to move the red frame pointer to the AV SYSTEM Menu icon.
- 2 Press the POINT DOWN button to move the red arrow pointer to the system that you want to select and then press the SELECT button.

VIDEO JACK OR S-VIDEO JACK

Auto

The projector automatically detects incoming Video system, and adjusts itself to optimize its performance.

When Video System is PAL-M or PAL-N, select system manually.

PAL / SECAM / NTSC / NTSC4.43 / PAL-M / PAL-N

If the projector cannot reproduce proper video image, it is necessary to select a specific broadcast signal format among PAL, SECAM, NTSC, NTSC 4.43, PAL-M, and PAL-N.

Y, Pb/Cb, Pr/Cr JACKS

Auto

The projector automatically detects incoming Video signal, and adjusts itself to optimize its performance.

COMPONENT VIDEO SIGNAL FORMAT

If the projector cannot reproduce proper video image, it is necessary to select a specific component video signal format among 480i, 575i, 480p, 575p, 720p, 1035i, and 1080i.

AV SYSTEM MENU (VIDEO OR S-VIDEO)

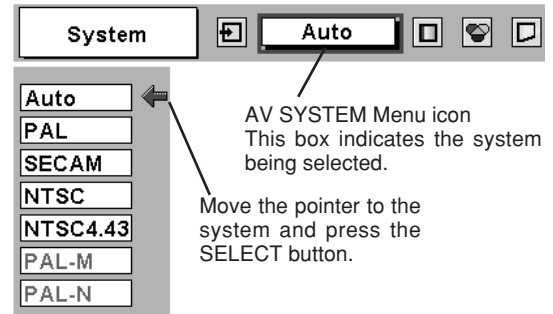

AV SYSTEM MENU (COMPONENT VIDEO)

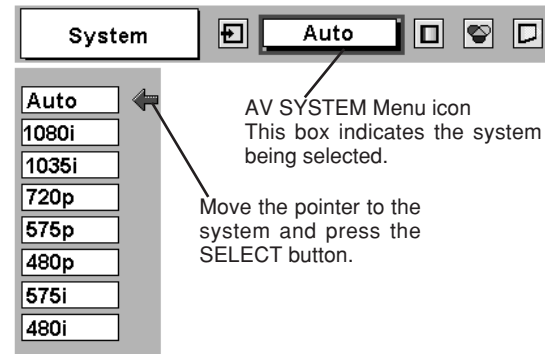

PICTURE IMAGE ADJUSTMENTS

IMAGE LEVEL SELECT (DIRECT)

Select an image level among Standard, Cinema, Image 1, Image 2, Image 3, and Image 4 by pressing the IMAGE button on the Top Control or on the Remote Control.

Standard

Normal picture level preset on this projector.

Cinema

Picture level adjusted for the picture with fine tone.

IMAGE 1~4

User preset picture adjustment in the IMAGE ADJUST Menu (P32, 33).

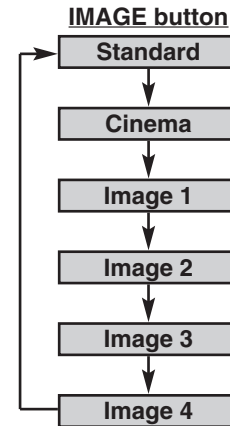

IMAGE LEVEL SELECT (MENU)

- 1 Press the MENU button and the ON-SCREEN MENU will appear. Press the POINT LEFT/RIGHT button to move the red frame pointer to the IMAGE SELECT Menu icon.
- 2 Press the POINT DOWN button to move the red frame pointer to the level that you want to set and then press the SELECT button.

Standard

Normal picture level preset on this projector.

Cinema

Picture level adjusted for the picture with fine tone.

IMAGE 1~4

User preset picture adjustment in the IMAGE ADJUST Menu (P32, 33).

IMAGE SELECT MENU

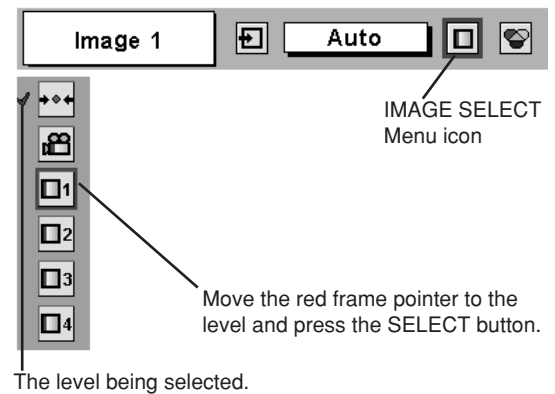

IMAGE LEVEL ADJUSTMENT

1 Press the MENU button and the ON-SCREEN MENU will appear. Press the POINT LEFT/RIGHT button(s) to move the red frame pointer to the IMAGE ADJUST Menu icon.

2 Press the POINT DOWN button to move the red frame pointer to the item that you want to adjust and then press the SELECT button. The level of each item is displayed. Adjust each level by pressing the POINT LEFT/RIGHT button(s).

Contrast

Press the POINT LEFT button to decrease contrast and the POINT RIGHT button to increase contrast. (From 0 to 63.)

Brightness

Press the POINT LEFT button to adjust image darker and the POINT RIGHT button to adjust image brighter. (From 0 to 63.)

Color

Press the POINT LEFT button to lighten color and the POINT RIGHT button to deepen color. (From 0 to 63.)

Tint

Press the POINT LEFT button or the POINT RIGHT button to obtain proper color. (From 0 to 63.)

White balance (Red)

Press the POINT LEFT button to lighten red tone and the POINT RIGHT button to deepen red tone. (From 0 to 63.)

White balance (Green)

Press the POINT LEFT button to lighten green tone and the POINT RIGHT button to deepen green tone. (From 0 to 63.)

White balance (Blue)

Press the POINT LEFT button to lighten blue tone and the POINT RIGHT button to deepen blue tone. (From 0 to 63.)





Sharpness

Press the POINT LEFT button to soften the image and the POINT RIGHT button to sharpen the image. (From 0 to 15.)

Gamma





Press the POINT LEFT button or the POINT RIGHT button to obtain better balance of contrast. (From 0 to 15.)



IMAGE ADJUST MENU



Contrast  **Auto**   



Move the red frame pointer to the item to be selected and then press the SELECT button. IMAGE ADJUST Menu icon

Contrast **Image 1**

 32   

 32  





 32  



 32  



Press the POINT LEFT/RIGHT buttons to adjust value. Press the SELECT button at this icon to display other items.







Press the SELECT button at this icon to display previous items.

 32   

 32  

 15  

 8  

Press the SELECT button at this icon to store the value.

NOTE

- Tint cannot be adjusted when the video system is PAL, SECAM, PAL-M or PAL-N.

3  **Store**

To store the adjustment data, move the red frame pointer to the Store icon and press the SELECT button. The Image Level Menu will appear. Move the red frame pointer to the Image Level 1 to 4 and then press the SELECT button.

Other icons operate as follows.

 **Reset**

Reset all adjustment to their previous figure.

 **Quit**

Closes the IMAGE MENU.

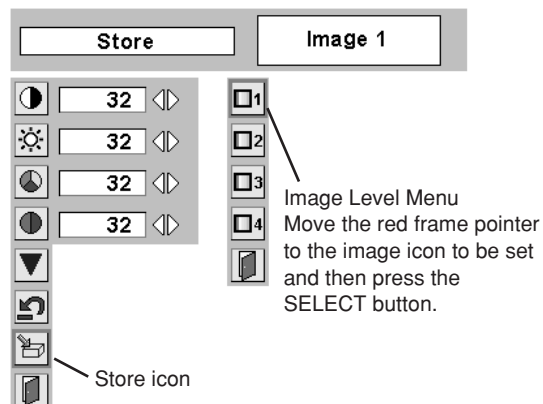

PICTURE SCREEN ADJUSTMENT

This projector has a picture screen resize function, which enables you to display the desirable image size.

1 Press the MENU button and the ON-SCREEN MENU will appear. Press the POINT LEFT/RIGHT button(s) to move the red frame pointer to the SCREEN Menu icon.

2 Press the POINT DOWN button and move the red frame pointer to the function that you want to select and then press the SELECT button.

SCREEN MENU

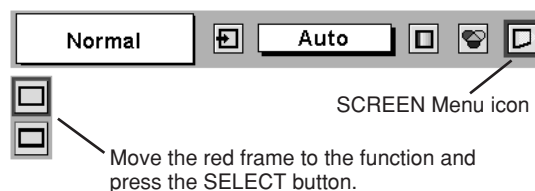

 **Normal**

Provides image at a normal video aspect ratio of 4 : 3.

 **Wide**

Provides image at a wide screen ratio of 16 : 9.

NOTE

- SCREEN Menu cannot be operated when “720p,” “1035i,” or “1080i” is selected in the AV SYSTEM Menu (P30).

SETTING MENU

- 1 Press the MENU button and the ON-SCREEN MENU will appear. Press the POINT LEFT/RIGHT button(s) to move the red-frame pointer to the SETTING icon.
- 2 Press the POINT DOWN button to move the red-frame pointer to the item that you want to set and then press the SELECT button. The setting dialog box appears.

Language

The language used in the ON-SCREEN MENU is available in English, German, French, Italian, Spanish, Portuguese, Dutch, Swedish, Russian, Chinese, Korean, and Japanese.

Keystone

When the image is distorted, select Keystone. The ON-SCREEN MENU disappears and the keystone dialog box is displayed. Correct keystone distortion by pressing the POINT UP/DOWN/LEFT/RIGHT button(s). Refer to KEYSTONE ADJUSTMENT on page 20.

Blue back

When this function is "On," the projector produces a blue image while input signal is not detected.

Display

This function decides whether to display On-Screen Displays.

- On ... shows all the On-Screen Displays.
- Off ... sets On-Screen Displays disappeared except;
 - ON-SCREEN MENU
 - "Power off?" message
 - P-TIMER
 - "No signal" message
 - "Wait a moment!" message

Logo

When this function is "On," the projector displays our logo when starting up.

Ceiling

When this function is "On," the picture is top / bottom and left / right reversed. This function is used to project the image from a ceiling mounting the projector.

Rear

When this function is "On," the picture is left / right reversed. This function is used to project the image to a rear projection screen.

SETTING MENU

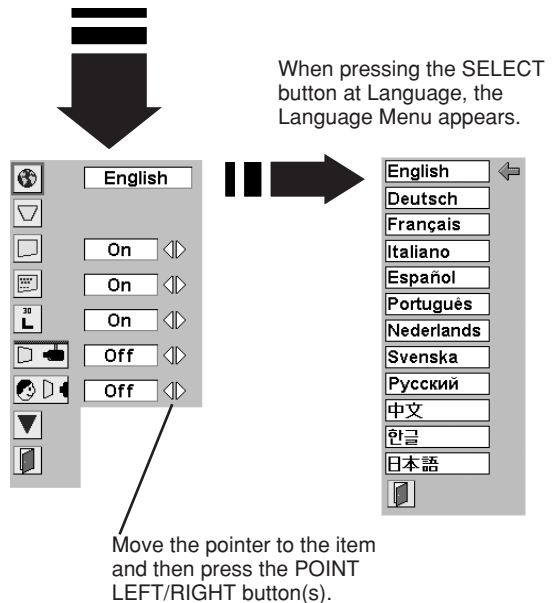
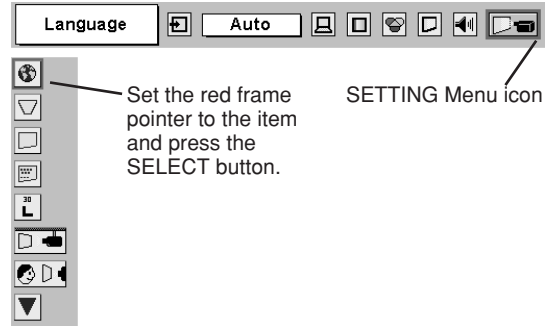

Ceiling function

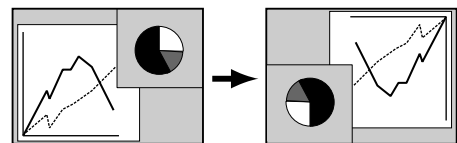

Rear function

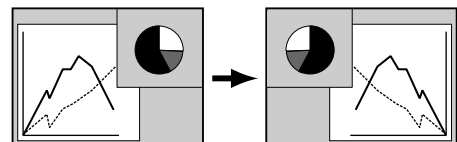

Power management

This function turns the Projection Lamp off when this projector detects signal interruption and is not used for a certain period in order to reduce power consumption and maintain the Lamp-life. (This projector is shipped with this function ON.)

The Power Management function operates to turn the Projection Lamp off when the input signal is interrupted and any button is not pressed over 5 minutes. This function operates as follows;

1. When any input signal is interrupted, "No signal" and the counting down display appears (for 5 minutes).
2. After counting down for 5 minutes, the Projection Lamp and the READY Indicator are turned off. (Cooling Fans keep running.)
3. The READY Indicator starts to flash after cooling down the Projection Lamp about for 90 seconds (Power Management mode).

In this Power Management mode, the Projection Lamp is automatically turned on when the input signal is connected or the projector is operated with any button on the Top Control or on the Remote Control again.

On start

When this function is "On," the projector is automatically turned on just by connecting the AC Power cord to a wall outlet.

Note ; Be sure to turn the projector off properly (refer to the section "TURNING OFF PROJECTOR" on page 19). If the projector is turned off in the wrong steps, the On Start function does not operate properly.

Lamp mode

When selecting the "  " (Eco), the projector reduce the brightness and set into the low power consumption mode.

Remote control

This projector has two different remote control codes; the factory-set normal code (Code 1) and the secondary code (Code 2). This switching function prevents remote control operation mixture (jam) when operating several projectors or video equipment together.

When operating the projector in "Code 2," both the projector and the Remote Control must be switched to "Code 2."

To change the code of the Projector;

Set the Remote control in the SETTING MENU to "Code 2."

To change the code of the Remote Control;

Press both the MENU and the IMAGE buttons on the Remote Control together for over 10 seconds.

After changing the code, make sure the Remote Control operates properly.

To return to the initial code (Code 1), repeat the steps above.

NOTE : When the batteries of the Remote Control are replaced or ALL-OFF switch is turned to "ALL-OFF," the remote control code automatically returns to the normal code (Code 1).

Lamp counter reset

This function is used to reset the Lamp Replace Counter. When replacing the Projection Lamp, reset the Lamp Replace Counter by using this function. Refer to page 37 for operation.

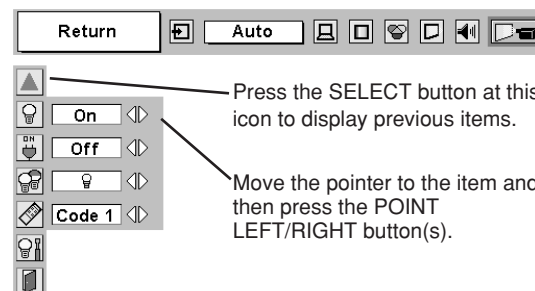
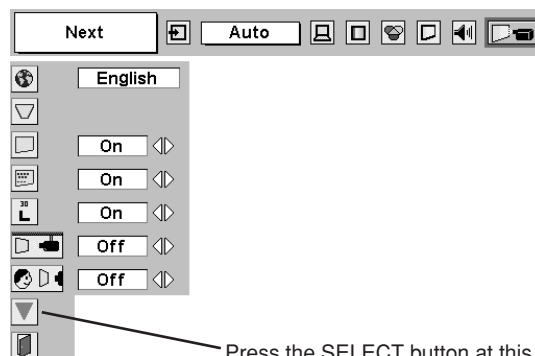

LAMP REPLACEMENT

LAMP REPLACE

When the life of the Projection Lamp of this projector draws to an end, the LAMP REPLACE indicator lights yellow. If this indicator lights yellow, replace the projection lamp with a new one promptly.

TOP CONTROL

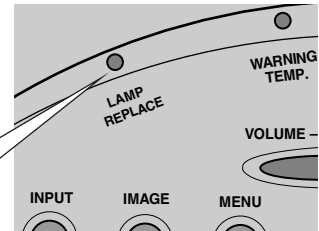

This indicator lights yellow when the life of the projection lamp draws to an end. Replace the Projection Lamp with a new one promptly.



Allow a projector to cool, for at least 45 minutes before you open Lamp Cover. The inside of a projector can become very hot.



CAUTION

For continued safety, replace with a lamp assembly of the same type.

Do not drop a lamp assembly or touch a glass bulb! The glass can shatter and may cause injury.

Follow these steps to replace the lamp assembly.

- 1 Turn off the projector and disconnect the AC plug. Allow the projector to cool for at least 45 minutes.
- 2 To remove the Lamp Cover, remove the screw with a screwdriver.
- 3 Loosen 3 screws with a screwdriver and pull out the Lamp Assembly by grasping the Handle.
- 4 Replace the Lamp Assembly with a new one and tighten the 3 screws back into position. Make sure that the Lamp Assembly is set properly. Replace the Lamp Cover and tighten the screw.
- 5 Connect the AC Power Cord to the projector and turn on the projector.
- 6 **Reset the Lamp Replace Counter.**
Refer to "LAMP REPLACE COUNTER" on the next page .

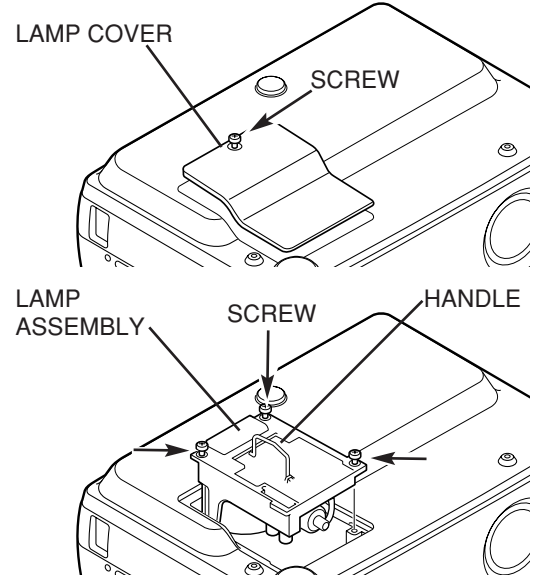

ORDER REPLACEMENT LAMP

Replacement Lamp can be ordered through your dealer. When ordering a Projection Lamp, give the following information to the dealer.

- **Model No. of your projector** : **PLC-XU45**
- **Replacement Lamp Type No.** : **POA-LMP63**

(Service Parts No. 610 304 5214)

LAMP REPLACE COUNTER

Be sure to reset the Lamp Replace Counter after the Lamp Assembly is replaced. When the Lamp Replace Counter is reset, the LAMP REPLACE Indicator stops lighting.

- 1 Turn the projector on, press the MENU button and the ON-SCREEN MENU will appear. Press the POINT LEFT/RIGHT button(s) to move the red frame pointer to the SETTING Menu icon (refer to page 34, 35).
- 2 Press the POINT DOWN button to move the red frame pointer to "Lamp counter reset" and then press the SELECT button. The message "Lamp replace counter reset?" is displayed. Move the pointer to [Yes] and then press the SELECT button.
- 3 Another confirmation dialog box appears and select [Yes] to reset the Lamp Replace Counter.

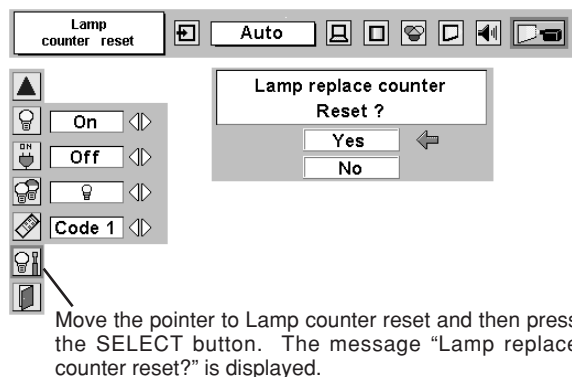

NOTE : Do not reset the Lamp Replace Counter before the Projection Lamp is replaced.



LAMP HANDLING PRECAUTIONS

This projector uses a high-pressure lamp which must be handled carefully and properly. Improper handling may result in accidents, injury, or create a fire hazard.

- Lamp lifetime may differ from lamp to lamp and according to the environment of use. There is no guarantee of the same lifetime for each lamp. Some lamps may fail or terminate their lifetime in a shorter period of time than other similar lamps.
- If the projector indicates that the lamp should be replaced, i.e., if the LAMP REPLACE INDICATOR lights up, replace the lamp with a new one IMMEDIATELY after the projector has cooled down. (Follow carefully the instructions in the LAMP REPLACEMENT section of this manual.) Continuous use of the lamp with the LAMP REPLACE INDICATOR lighted may increase the risk of lamp explosion.
- A Lamp may explode as a result of vibration, shock or degradation as a result of hours of use as its lifetime draws to an end. Risk of explosion may differ according to the environment or conditions in which the projector and lamp are being used.

IF A LAMP EXPLODES, THE FOLLOWING SAFETY PRECAUTIONS SHOULD BE TAKEN.

If a lamp explodes, disconnect the projector's AC plug from the AC outlet immediately. Contact an authorized service station for a checkup of the unit and replacement of the lamp. Additionally, check carefully to ensure that there are no broken shards or pieces of glass around the projector or coming out from the cooling air circulation holes. Any broken shards found should be cleaned up carefully. No one should check the inside of the projector except those who are authorized trained technicians and who are familiar with projector service. Inappropriate attempts to service the unit by anyone, especially those who are not appropriately trained to do so, may result in an accident or injury caused by pieces of broken glass.

OPERATING WIRELESS MOUSE

The Wireless Remote Control is not only able to operate this projector but is also usable as a Wireless Mouse for most Personal Computers. The POINT button and two CLICK buttons are used for wireless mouse operation.

This Wireless Mouse function is available only when PC mouse pointer is displayed on a projected screen. When ON-SCREEN MENU or any message / dialog box is displayed on the screen instead of PC mouse pointer, the POINT and CLICK buttons control the projector, rather than the computer.

INSTALLATION

To use the Wireless Remote Control as Wireless Mouse, a mouse driver must be already installed on your computer. No mouse driver is supplied with this projector: instead, the Wireless Remote Control becomes the pointing device for your computer's existing mouse driver. Make sure that the mouse driver is properly installed in your computer, and that the appropriate port (PS/2, DB9, ADB, or USB port) is activated. Note that only a PS/2 mouse cable is supplied with the projector: for other mouse cables, contact your dealer.

- 1 With the projector and computer both OFF, connect the mouse port (or USB port) of your computer to Control Port (or USB connector) of this projector with the appropriate cable. (Refer to page 11, 12 for connection.)
- 2 Turn the projector ON first, and then turn ON your computer. When the computer is switched on first, Wireless Mouse may not work properly.

OPERATING WIRELESS MOUSE

When controlling a mouse pointer, operate Wireless Mouse with the POINT button, SELECT button, and RIGHT CLICK button on the Wireless Remote Control.

POINT button

Used to move mouse pointer. The pointer is moved in a direction corresponding to the direction you are pressing.

SELECT (LEFT CLICK) button

This button has the same function as the left button in a PC mouse.

RIGHT CLICK button

This button has the same function as the right button in a PC mouse.

POINT button (Move the pointer)

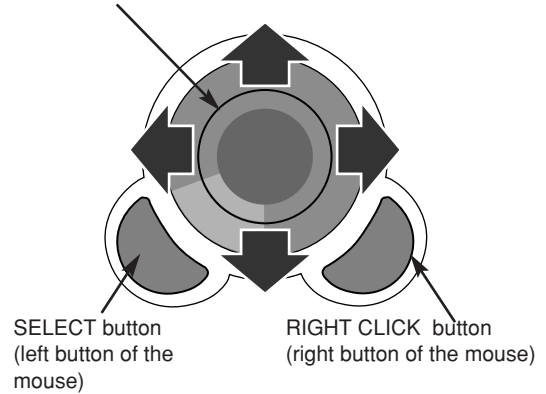

MAINTENANCE

WARNING TEMP. INDICATOR

The WARNING TEMP. indicator flashes red when an internal temperature of the projector exceeds the normal temperature. The indicator stops flashing when the temperature of the projector returns to normal.

When the WARNING TEMP. indicator continues to flash, check the items listed below.

- 1 Ventilation slots of the projector may be blocked. In such an event, reposition the projector so that the Ventilation slots cannot be obstructed.
- 2 The Air filter may be clogged with dust particles. Clean the Air filter by following the section "AIR FILTER CARE AND CLEANING" below.
- 3 If the WARNING TEMP. indicator remains on after performing the above checks, the Cooling fans or the internal circuits may be malfunctioning. Contact service personnel from an authorized dealer or a service station.

TOP CONTROL

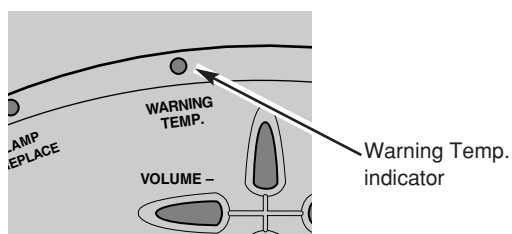

AIR FILTER CARE AND CLEANING

Removable Air Filter prevents dust from accumulating on the surface of the Projection Lens and Projection Mirror. Should the Air Filter become clogged with dust particles, it will reduce Cooling Fans' effectiveness and may result in internal heat build up and adversely affect the life of the projector. Clean the Air Filter following the steps below:

- 1 Turn off the projector, and disconnect AC power cord from the AC outlet.
- 2 Turn the projector upside down and remove the Air Filter by pulling the latches upward.
- 3 Clean the Air Filter with a brush or wash out dust and particles.
- 4 Replace the Air Filter properly. Make sure that the Air Filter is fully inserted.



CAUTION

Do not operate the projector with the Air Filter removed. Dust may accumulate on the LCD Panel and the Projection Mirror degrading picture quality.

Do not put small parts into the Air Intake Vents. It may result in malfunction of the projector.

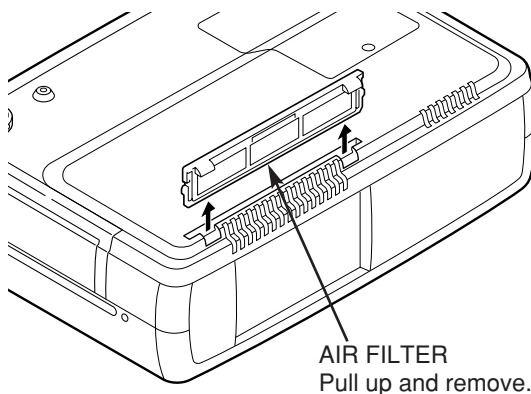

RECOMMENDATION

We recommend avoiding dusty/smoky environments when operating a projector. Usage in these environments may cause poor image quality.

When using under dusty or smoky conditions, dust may accumulate on a lens, liquid crystal panels, or optical elements inside the projector. This condition may degrade the quality of a projected image.

When the above symptoms are noticed, contact your authorized dealer or service station for proper cleaning.

CLEANING PROJECTION LENS

Follow these steps to clean the Projection Lens:

- 1 Apply a non-abrasive camera lens cleaner to a soft, dry cleaning cloth. Avoid using an excessive amount of cleaner. Abrasive cleaners, solvents or other harsh chemicals might scratch a surface.
- 2 Lightly wipe a cleaning cloth over the Projection Lens.
- 3 When the projector is not in use, replace the Lens Cover.

TROUBLESHOOTING

Before calling your dealer or service center for assistance, check the items below once again.

- Make sure you have connected the projector to peripheral equipment as described properly in the section "CONNECTING PROJECTOR" on pages 11 ~ 13.
- Verify that all computer, video and power cord are properly connected and turn the equipment on.
- When you are operating the projector with a computer and it does not produce an image, restart the computer.
- Select the other input source.

| Problem: | Try these Solutions |
|---|--|
| No power. | <ul style="list-style-type: none"> ● Plug the projector into your AC outlet. ● Make sure the READY Indicator lights. ● Wait 90 seconds after the projector is turned OFF when turning the projector back on. <p>NOTE : After pressing the Power ON-OFF button to OFF, make sure the projector works as follows:</p> <ol style="list-style-type: none"> 1. The LAMP indicator lights bright, and the READY indicator is turned off. 2. After 90 seconds, the READY indicator lights green again and the projector can be turned on by pressing the Power ON-OFF button. <ul style="list-style-type: none"> ● Check the WARNING TEMP. indicator. If the indicator flashes red, the projector cannot be turned on. (Refer to the section "MAINTENANCE" on page 39.) ● Check the Projection Lamp. (Refer to page 36.) |
| Image is out of focus. | <ul style="list-style-type: none"> ● Adjust focus of the projector. ● Make sure the projection screen is at least 5.3' (1.6m) from the projector. ● Check the Projection Lens to see if it needs cleaning. <p>NOTE : Moving the projector from a cool temperature location to a warm temperature location may result in moisture condensation on the Projection Lens. In such an event, leave the projector OFF and wait until condensation disappears.</p> |
| Picture is Left/Right reversed. | <ul style="list-style-type: none"> ● Check Ceiling / Rear feature. (See the "SETTING" section on page 34.) |
| Picture is Top/Bottom reversed. | <ul style="list-style-type: none"> ● Check Ceiling feature. (See the "SETTING" section on page 34.) |
| Some displays are not seen during the Operation. | <ul style="list-style-type: none"> ● Check Display feature.(See the "SETTING" section on page 34.) |
| No image. | <ul style="list-style-type: none"> ● Check the connection between your computer or video equipment and the projector. ● When turning the projector on, it takes about 30 seconds to display an image. ● Check the system that you select is corresponding with your computer or video equipment. ● Make sure the temperature is not out of Operating Temperature (5°C ~ 35°C). |
| No sound. | <ul style="list-style-type: none"> ● Check audio cable connection from audio input source. ● Adjust the audio source. ● Press the VOLUME (+) button. ● Press the MUTE button. |

| Problem: | Try these Solutions |
|---|--|
| Remote Control does not work. | <ul style="list-style-type: none"> ● Check the batteries. ● Check ALL-OFF switch on the Remote Control is set to "ON." ● Make sure there is no obstructions between the projector and the Remote Control. ● Make sure you are not too far from the projector when using the Remote Control. Maximum operating range is 16.4' (5m). ● Make sure the code of the Remote Control is set to conform to the projector. (See "SETTING" section on page 34, 35.) |
| Wireless Mouse function does not work. | <ul style="list-style-type: none"> ● Check cable connection between the projector and your computer. ● Check the mouse setting on your computer. ● Turn the projector on before turning on the computer. |

WARNING :

High voltages are used to operate this projector. Do not attempt to open the cabinet.

If the problem still persists after following all operating instructions, contact the sales dealer where you purchased the projector or the service center. Give the model number and explain about the problem. We will advise you how to obtain service.



This symbol on the nameplate means the product is Listed by Underwriters Laboratories Inc. It is designed and manufactured to meet rigid U.L. safety standards against risk of fire, casualty and electrical hazards.



The CE Mark is a Directive conformity mark of the European Community (EC).

INDICATORS AND PROJECTOR CONDITION

Check the Indicators for projector condition.

| Indicators | | | | Projector Condition |
|------------------------|----------------------|----------------|-------------|---|
| LAMP REPLACE yellow | WARNING TEMP. red | READY green | LAMP red | |
| ● | ● | ● | ● | The projector is OFF. (The AC Power Cord is unplugged.) |
| * | ● | ○ | ○ | The projector is READY to be turned on with the POWER ON-OFF button. |
| * | ● | ○ | ● | The projector is operating normally. |
| * | ⊙ | ● | ○ | The temperature inside the projector is abnormally high. The projector cannot be turned on. When the projector is cooled down enough and the temperature returns to normal, the READY indicator lights green and the WARNING TEMP. indicator goes off. Then the projector can be turned on. |
| * | ● | ● | ○ | The projector is being cooled down. It cannot be turned on until the READY indicator lights green. |
| * | ● | ⊙ | ● | The projector is in the Power management mode. |

○ ... on ⊙ ... flashing ● ... dim ● ... off

* When the life of the projection lamp draws to an end, the LAMP REPLACE indicator lights yellow. When this indicator lights yellow, replace the projection lamp with a new one promptly. Reset the Lamp Replace Counter after replacement of the lamp.

COMPATIBLE COMPUTER SPECIFICATIONS

Basically this projector can accept the signal from all computers with the V, H-Frequency below mentioned and less than 140 MHz of Dot Clock.

| ON-SCREEN DISPLAY | RESOLUTION | H-Freq. (kHz) | V-Freq. (Hz) | ON-SCREEN DISPLAY | RESOLUTION | H-Freq. (kHz) | V-Freq. (Hz) |
|-------------------|------------|---------------|---------------------------------|-------------------|-------------|---------------|---------------------------------|
| VGA 1 | 640 x 480 | 31.47 | 59.88 | XGA 11 | 1024 x 768 | 61.00 | 75.70 |
| VGA 2 | 720 x 400 | 31.47 | 70.09 | XGA 12 | 1024 x 768 | 35.522 | ^{86.96} (Interlace) |
| VGA 3 | 640 x 400 | 31.47 | 70.09 | XGA 13 | 1024 x 768 | 46.90 | 58.20 |
| VGA 4 | 640 x 480 | 37.86 | 74.38 | XGA 14 | 1024 x 768 | 47.00 | 58.30 |
| VGA 5 | 640 x 480 | 37.86 | 72.81 | XGA 15 | 1024 x 768 | 58.03 | 72.00 |
| VGA 6 | 640 x 480 | 37.50 | 75.00 | MAC 19 | 1024 x 768 | 60.24 | 75.08 |
| VGA 7 | 640 x 480 | 43.269 | 85.00 | MAC 21 | 1152 x 870 | 68.68 | 75.06 |
| MAC LC13 | 640 x 480 | 34.97 | 66.60 | SXGA 1 | 1152 x 864 | 64.20 | 70.40 |
| MAC 13 | 640 x 480 | 35.00 | 66.67 | SXGA 2 | 1280 x 1024 | 62.50 | 58.60 |
| RGB | ———— | 15.625 | ⁵⁰ (Interlace) | SXGA 3 | 1280 x 1024 | 63.90 | 60.00 |
| RGB | ———— | 15.734 | ⁶⁰ (Interlace) | SXGA 4 | 1280 x 1024 | 63.34 | 59.98 |
| SVGA 1 | 800 x 600 | 35.156 | 56.25 | SXGA 5 | 1280 x 1024 | 63.74 | 60.01 |
| SVGA 2 | 800 x 600 | 37.88 | 60.32 | SXGA 6 | 1280 x 1024 | 71.69 | 67.19 |
| SVGA 3 | 800 x 600 | 46.875 | 75.00 | SXGA 7 | 1280 x 1024 | 81.13 | 76.107 |
| SVGA 4 | 800 x 600 | 53.674 | 85.06 | SXGA 8 | 1280 x 1024 | 63.98 | 60.02 |
| SVGA 5 | 800 x 600 | 48.08 | 72.19 | SXGA 9 | 1280 x 1024 | 79.976 | 75.025 |
| SVGA 6 | 800 x 600 | 37.90 | 61.03 | SXGA 10 | 1280 x 960 | 60.00 | 60.00 |
| SVGA 7 | 800 x 600 | 34.50 | 55.38 | SXGA 11 | 1152 x 900 | 61.20 | 65.20 |
| SVGA 8 | 800 x 600 | 38.00 | 60.51 | SXGA 12 | 1152 x 900 | 71.40 | 75.60 |
| SVGA 9 | 800 x 600 | 38.60 | 60.31 | SXGA 13 | 1280 x 1024 | 50.00 | ^{86.00} (Interlace) |
| SVGA 10 | 800 x 600 | 32.70 | 51.09 | SXGA 14 | 1280 x 1024 | 50.00 | ^{94.00} (Interlace) |
| SVGA 11 | 800 x 600 | 38.00 | 60.51 | SXGA 15 | 1280 x 1024 | 63.37 | 60.01 |
| MAC 16 | 832 x 624 | 49.72 | 74.55 | SXGA 16 | 1280 x 1024 | 76.97 | 72.00 |
| XGA 1 | 1024 x 768 | 48.36 | 60.00 | SXGA 17 | 1152 x 900 | 61.85 | 66.00 |
| XGA 2 | 1024 x 768 | 68.677 | 84.997 | SXGA 18 | 1280 x 1024 | 46.43 | ^{86.70} (Interlace) |
| XGA 3 | 1024 x 768 | 60.023 | 75.03 | SXGA 19 | 1280 x 1024 | 63.79 | 60.18 |
| XGA 4 | 1024 x 768 | 56.476 | 70.07 | MAC | 1280 x 960 | 75.00 | 75.08 |
| XGA 5 | 1024 x 768 | 60.31 | 74.92 | MAC | 1280 x 1024 | 80.00 | 75.08 |
| XGA 6 | 1024 x 768 | 48.50 | 60.02 | 720p (HDTV) | ———— | 45.00 | 60.00 |
| XGA 7 | 1024 x 768 | 44.00 | 54.58 | 1035i (HDTV) | ———— | 33.75 | ^{60.00} (Interlace) |
| XGA 8 | 1024 x 768 | 63.48 | 79.35 | 1080i 60(HDTV) | ———— | 33.75 | ^{60.00} (Interlace) |
| XGA 9 | 1024 x 768 | 36.00 | ^{87.17} (Interlace) | 1080i 50(HDTV) | ———— | 28.125 | ^{50.00} (Interlace) |
| XGA 10 | 1024 x 768 | 62.04 | 77.07 | | | | |

When an input signal is digital from DVI terminal, refer to the chart below.

| ON-SCREEN DISPLAY | RESOLUTION | H-Freq. (kHz) | V-Freq. (Hz) | ON-SCREEN DISPLAY | RESOLUTION | H-Freq. (kHz) | V-Freq. (Hz) |
|-------------------|------------|---------------|--------------|-------------------|-------------|---------------|--------------|
| D-VGA | 640 x 480 | 31.469 | 59.940 | D-SXGA 1 | 1280 x 1024 | 63.981 | 60.020 |
| D-SVGA | 800 x 600 | 37.879 | 60.317 | D-SXGA 2 | 1280 x 1024 | 60.276 | 58.069 |
| D-XGA | 1024 x 768 | 48.363 | 60.004 | D-SXGA 3 | 1280 x 1024 | 31.65 | 29.8 |

NOTE : Specifications are subject to change without notice.

TECHNICAL SPECIFICATIONS

| | |
|---|--|
| Projector Type | Multi-media Projector |
| Dimensions (W x H x D) | 13.11" x 3.52" x 9.96" (333mm x 89.5mm x 253mm) (not including Adjustable Feet) |
| Net Weight | 9.3 lbs (4.2 kg) |
| LCD Panel System | 0.9" TFT Active Matrix type, 3 panels |
| Panel Resolution | 1024 x 768 dots |
| Number of Pixels | 2,359,296 (1024 x 768 x 3 panels) |
| Color System | PAL, SECAM, NTSC, NTSC4.43, PAL-M and PAL-N |
| High Definition TV Signal | 480i, 480p, 575i, 575p, 720p, 1035i, and 1080i |
| Scanning Frequency | H-sync. 15 ~ 100 KHz, V-sync. 50 ~ 100 Hz |
| Projection Image size (Diagonal) | Adjustable from 31" to 300" |
| Horizontal Resolution | 800 TV lines |
| Projection Lens | F 1.7 ~ 2.0 lens with f 37.4 mm ~ 48.3 mm with motor zoom and focus |
| Throw Distance | 5.3' ~ 40.0' (1.6 m ~ 12.2 m) |
| Projection Lamp | 200 W |
| Video Input Jacks | RCA Type x 3 (Video/Y, Pb/Cb, Pr/Cr) and Mini DIN 4 pin x 1 (S-Video) |
| Audio Input Jacks | RCA Type x 2 |
| Computer Input Terminal | DVI-I Terminal (Digital/Analog) |
| Monitor Out Terminal | (VGA) HDB 15 Terminal x 1 |
| Computer Audio Input Jack | Mini Jack (stereo) x 1 |
| Control Port Connector | Mini DIN 8 pin x 1 |
| USB Connector | USB Series B receptacle x 1 |
| Audio Output Jacks | RCA Type x 2 |
| Internal Audio Amp | 1.0 W RMS |
| Built-in Speaker | 1 speaker, 1.18" x 1.57" (30mm x 40mm) |
| Feet Adjustment | 0° to 15.6° |
| Voltage and Power Consumption | AC 100 ~ 120 V (3.6 A Max. Ampere), 50 / 60 Hz (The U.S.A and Canada) AC 200 ~ 240 V (1.8 A Max. Ampere), 50 / 60 Hz (Continental Europe and The U.K.) |
| Operating Temperature | 41 °F ~ 95 °F (5 °C ~ 35 °C) |
| Storage Temperature | 14 °F ~ 140 °F (-10 °C ~ 60 °C) |
| Remote Control | Power Source : AA, UM3 or R06 Type x 2 Operating Range : 16.4' (5m) / ±30° Dimensions : 2.2" x 1.3" x 7.6" (55mm x 34mm x 192mm) Net Weight : 0.36 lbs (165 g) (including batteries) Laser Pointer : Class II Laser (Max. Output : 1mW / Wave length : 650±20nm) |
| Accessories | Owner's Manual AC Power Cord Remote Control and Batteries Control Cable for PS/2 port DVI-VGA Cable Carrying Bag Lens Cover |

- The specifications are subject to change without notice.
- LCD panels are manufactured to the highest possible standards. Even though 99.99% of the pixels are effective, a tiny fraction of the pixels (0.01% or less) may be ineffective by the characteristics of the LCD panels.
- The ON-SCREEN MENU and figures in this manual may differ slightly from the product.

CONFIGURATIONS OF TERMINALS

MONITOR OUT TERMINAL (ANALOG)

Terminal : HDB15-PIN

Pin Configuration

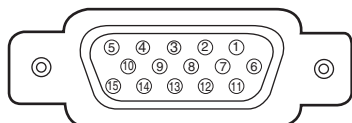

| | | | |
|---|----------------------|----|---------------------|
| 1 | Red Input | 9 | +5V Power |
| 2 | Green Input | 10 | Ground (Vert.sync.) |
| 3 | Blue Input | 11 | Sense 0 |
| 4 | Sense 2 | 12 | DDC Data |
| 5 | Ground (Horiz.sync.) | 13 | Horiz. sync. |
| 6 | Ground (Red) | 14 | Vert. sync. |
| 7 | Ground (Green) | 15 | DDC Clock |
| 8 | Ground (Blue) | | |

DVI-I TERMINAL (DIGITAL/ANALOG)

Pin Configuration

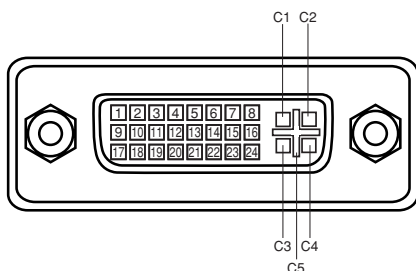

| | |
|-----------|-----------------------|
| C1 | Analog Red Input |
| C2 | Analog Green Input |
| C3 | Analog Blue Input |
| C4 | Analog Horiz. sync |
| C5 | Analog Ground (R/G/B) |

| | | | | | |
|---|-------------------------|----|-------------------------|----|-------------------------|
| 1 | T.M.D.S. Data2- | 9 | T.M.D.S. Data1- | 17 | T.M.D.S. Data0- |
| 2 | T.M.D.S. Data2+ | 10 | T.M.D.S. Data1+ | 18 | T.M.D.S. Data0+ |
| 3 | T.M.D.S. Data2/4 Shield | 11 | T.M.D.S. Data1/3 Shield | 19 | T.M.D.S. Data0/5 Shield |
| 4 | +3.3V MCI | 12 | +5V MCI | 20 | Viewer RXD |
| 5 | W-LAN | 13 | Card In | 21 | Viewer TXD |
| 6 | DDC Clock | 14 | +5V Power | 22 | T.M.D.S. Clock Shield |
| 7 | DDC Data | 15 | Ground (for +5V) | 23 | T.M.D.S. Clock+ |
| 8 | Analog Vert. sync | 16 | Hot Plug Detect | 24 | T.M.D.S. Clock- |

CONTROL PORT CONNECTOR

Terminal : Mini DIN 8-PIN

Pin Configuration

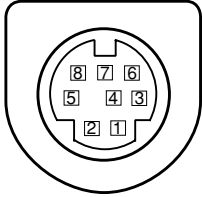

| | PS/2 | Serial | ADB |
|---|-------|-----------|-------|
| 1 | ----- | R X D | ----- |
| 2 | CLK | ----- | ADB |
| 3 | DATA | ----- | ----- |
| 4 | GND | GND | GND |
| 5 | ----- | RTS / CTS | ----- |
| 6 | ----- | T X D | ----- |
| 7 | GND | GND | ----- |
| 8 | ----- | GND | GND |

USB CONNECTOR (Series B)

Pin Configuration

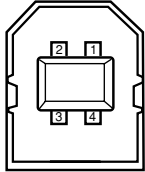

| | |
|---|--------|
| 1 | Vcc |
| 2 | - Data |
| 3 | + Data |
| 4 | Ground |

OPTIONAL PARTS

The parts listed below are optionally supplied. When ordering those parts, give the name and Type No. to the sales dealer.

- **Control Cable (Serial Port)** **Type No. : POA-MCSRL**
- **Control Cable (ADB Port)** **Type No. : POA-MCMAC**
- **MAC Adapter** **Type No. : POA-MACAP**
- **Media Card Imager Kit** **Type No. : POA-MD07MCI**
- **Wireless Imager Kit** **Type No. :** Available models are different in each country. Contact the sales dealer for details.

When using Wireless Imager, set the following model name to PJ Controller.

Model Name : 09-2-1

