

## **Copyright**

This publication, including all photographs, illustrations and software, is protected under international copyright laws, with all rights reserved. Neither this manual, nor any of the material contained herein, may be reproduced without written consent of the author.

© Copyright June, 2006

## **Disclaimer**

The information in this document is subject to change without notice. The manufacturer makes no representations or warranties with respect to the contents hereof and specifically disclaims any implied warranties of merchantability or fitness for any particular purpose. The manufacturer reserves the right to revise this publication and to make changes from time to time in the content hereof without obligation of the manufacturer to notify any person of such revision or changes.

## **Trademark Recognition**

Kensington is a U.S. registered trademark of ACCO Brand Corporation with issued registrations and pending applications in other countries throughout the world.

All other product names used in this manual are the properties of their respective owners and are acknowledged.

## Important Safety Information

Congratulations on purchasing the DLP projector!

**Important:**

*It is strongly recommended that you read this section carefully before using the projector. These safety and usage instructions will ensure that you enjoy many years of safe use of the projector. Keep this manual for future reference.*

### Symbols Used

Warning symbols are used on the unit and in this manual to alert you of hazardous situations.

The following styles are used in this manual to alert you to important information.

**Note:**

*Provides additional information on the topic at hand.*

**Important:**

*Provides additional information that should not be overlooked.*

**Caution:**

*Alerts you to situations that may damage the unit.*

**Warning:**

*Alerts you to situations that may damage the unit, create a hazardous environment, or cause personal injury.*

Throughout this manual, component parts and items in the OSD menus are denoted in bold font as in this example:

“Push the **Menu** button on the remote control to open the **Main** menu.”

### Remote Control

Some remote controls have a laser for pointing out items on a screen.

**DANGER: Do not point the laser in the eyes. Doing so can damage the eyes permanently.**

### General Safety Information

- Do not open the unit case. Aside from the projection lamp, there are no user-serviceable parts in the unit. For servicing, contact qualified service personnel.
- Follow all warnings and cautions in this manual and on the unit case.
- The projection lamp is extremely bright by design. To avoid damage to eyes, do not look into the lens when the lamp is on.
- Do not place the unit on an unstable surface, cart, or stand.
- Avoid using the system near water, in direct sunlight, or near a heating device.
- Do not place heavy objects such as books or bags on the unit.

---

### **Power Safety**

- Only use the supplied power cord.
- Do not place anything on the power cord. Place the power cord where it will not be in the way of foot traffic.
- Remove the batteries from the remote control when storing or not in use for a prolonged period.

### **Replacing the Lamp**

Replacing the lamp can be hazardous if done incorrectly. Refer to “Replacing the Projection Lamp” on page 36 for clear and safe instructions for this procedure. Before replacing the lamp:

- Unplug the power cord.
- Allow the lamp to cool for about one hour.

### **Spent Lamp Management**

- This product contains a metal halide lamp, which contains mercury. Dispose of it as required by local ordinances and regulations.
- The USA restricts or prohibits the disposal of some or all mercury containing lamps in the municipal waste stream. Please visit [www.lamprecycle.org](http://www.lamprecycle.org) for more information on specific state disposal requirements and recycling facilities.
- The following states have laws that deal with information that wholesalers must provide to contractors for lamp disposal.  
Connecticut  
Maine  
Minnesota  
Rhode Island
- For users in Connecticut, please call our toll free number 1-888-657-5267 to place an order for the delivery of a kit for returning a used lamp. The kit includes a box for the lamp, tape, and a return shipping label. To return a lamp:
  1. Place the lamp in the box, complete the enclosed form, and seal the box with the provided tape.
  2. Affix the return shipping label to the box and call 1.800.463.3339 (FedEx Ground Service) for box pickup.

### **Cleaning the Projector**

- Unplug the power cord before cleaning. Refer to “Cleaning the Projector” on page 38.
- Allow the lamp to cool for about one hour.

### **Regulatory Warnings**

Before installing and using the projector, read the regulatory notices in the “Regulatory Compliance” section on page 53.

## **Main Features**

- *Lightweight unit, easy to pack away and transport*
- *Compatible with all major video standards including NTSC, PAL, and SECAM*
- *A high brightness rating allows for presentations in daylight or in lit rooms*
- *Supports resolutions up to SXGA at 16.7 million colors to deliver crisp, clear images*
- *Flexible setup allows for front, rear, and ceiling projections*
- *Line-of-vision projections remain square, with advanced keystone correction for angled projections*
- *Input source automatically detected*
- *“Off-to-go” cooling system allows this projector to shut down without a long cooling time*

## **About this manual**

This manual is intended for end users and describes how to install and operate the DLP projector. Wherever possible, relevant information—such as an illustration and its description—has been kept on one page. This printer-friendly format is both for your convenience and to help save paper, thereby protecting the environment. It is suggested that you only print sections that are relevant to your needs.

## Table of contents

<b>GETTING STARTED .....</b>	<b>1</b>
PACKING CHECKLIST .....	1
ACCESSORIES.....	2
VIEWS OF PROJECTOR PARTS .....	3
<i>Front-right View</i> .....	3
<i>Top view—On-screen Display (OSD) buttons and LEDs</i> .....	4
<i>Rear view</i> .....	5
<i>Bottom view</i> .....	6
REMOTE CONTROL PARTS (DS125/AB110) .....	7
REMOTE CONTROL PARTS (DX125/DX130).....	9
REMOTE CONTROL OPERATING RANGE.....	11
PROJECTOR AND REMOTE CONTROL BUTTONS .....	11
<i>Remote Control (DS125/AB110)</i> .....	11
<i>Remote Control (DX125/DX130)</i> .....	12
<b>SETUP AND OPERATION .....</b>	<b>13</b>
INSERTING THE REMOTE CONTROL BATTERIES (DS125/AB110) .....	13
INSERTING THE REMOTE CONTROL BATTERIES (DX125/DX130) .....	14
CONNECTING INPUT DEVICES.....	15
STARTING AND SHUTTING DOWN THE PROJECTOR .....	16
SETTING AN ACCESS PASSWORD (SECURITY LOCK) .....	18
ADJUSTING THE PROJECTOR LEVEL.....	19
ADJUSTING THE ZOOM, FOCUS AND KEYSTONE.....	20
ADJUSTING THE VOLUME.....	21
<b>ON-SCREEN DISPLAY (OSD) MENU SETTINGS .....</b>	<b>22</b>
OSD MENU CONTROLS.....	22
<i>Navigating the OSD</i> .....	22
SETTING THE OSD LANGUAGE .....	24
MAIN MENU .....	25
<i>Main Menu Functions Available for Connected Source</i> .....	26
SETUP MENU .....	27
<i>Setup Menu Functions Available for Connected Source</i> .....	27
<i>Advance Feature</i> .....	28
<i>User Color</i> .....	30
CONFIG MENU .....	31
UTILITY MENU .....	32
<i>Utility Menu Functions Available for Connected Source</i> .....	33
LANGUAGE MENU.....	34
STATUS MENU .....	35
<b>MAINTENANCE AND SECURITY.....</b>	<b>36</b>
REPLACING THE PROJECTION LAMP .....	36
<i>Resetting the Lamp</i> .....	38
CLEANING THE PROJECTOR.....	38
<i>Cleaning the Lens</i> .....	39
<i>Cleaning the Case</i> .....	39
USING THE KENSINGTON® LOCK.....	39
<b>TROUBLESHOOTING.....</b>	<b>40</b>
COMMON PROBLEMS AND SOLUTIONS .....	40
TIPS FOR TROUBLESHOOTING.....	40
LED ERROR MESSAGES.....	41
IMAGE PROBLEMS.....	41
LAMP PROBLEMS .....	42
REMOTE CONTROL PROBLEMS .....	42
AUDIO PROBLEMS.....	42
HAVING THE PROJECTOR SERVICED .....	43

<b>SPECIFICATIONS</b> .....	<b>44</b>
SPECIFICATIONS.....	44
<i>Input/output connectors</i> .....	46
PROJECTION DISTANCE V.S. PROJECTION SIZE.....	47
<i>DX130</i> .....	47
<i>DX125/DS125</i> .....	48
<i>AB110</i> .....	49
TIMING MODE TABLE .....	50
PROJECTOR DIMENSIONS.....	52
<b>REGULATORY COMPLIANCE</b> .....	<b>53</b>
FCC WARNING.....	53
CANADA .....	53
SAFETY CERTIFICATIONS .....	53
EN 55022 WARNING .....	53

## GETTING STARTED

### Packing Checklist

The remote control that ships with the projector depends on the model you purchased.

Carefully unpack the projector and check that the following items are included:

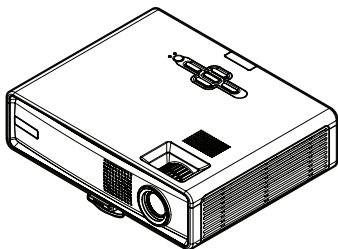

*DLP PROJECTOR*

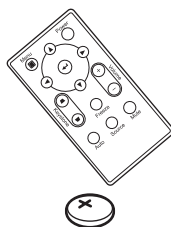

**Models: DS125/AB110**

*REMOTE CONTROL  
(WITH ONE 3V CR2025  
BATTERY)*

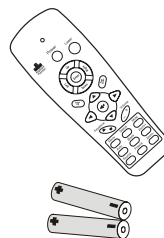

**Models: DX125/DX130**

*REMOTE CONTROL  
(WITH TWO AAA BATTERIES)*

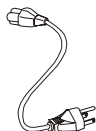

*POWER CORD*

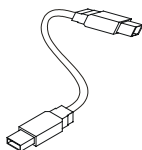

*USB CABLE*

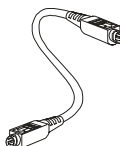

*S-VIDEO CABLE*

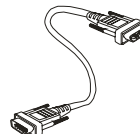

*COMPUTER CABLE  
(DVI-DB15)*

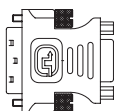

*DVI-TO-RGB  
ADAPTER*

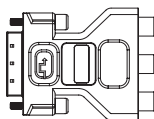

*DVI-TO-YPbPr  
ADAPTER*



*CD-ROM (THIS  
USER'S MANUAL)*

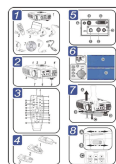

*QUICK START GUIDE*

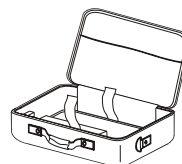

*CARRYING CASE*

Contact your dealer immediately if any items are missing, appear damaged, or if the unit does not work.

**Caution:**

*Avoid using the projector in dusty environments.*

## Accessories

You can purchase the following accessories from your dealer:



*AUDIO CABLE*

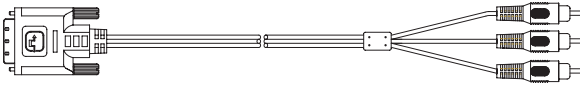

*DVI-TO-YPBPR CABLE*



*DVI-TO-DVI COMPUTER CABLE*



*VIDEO CABLE*

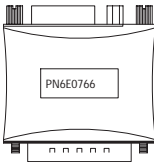

*MAC ADAPTER*

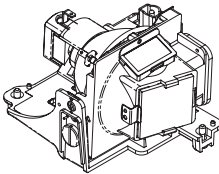

*REPLACEMENT LAMP*



## Views of Projector Parts

### Front-right View

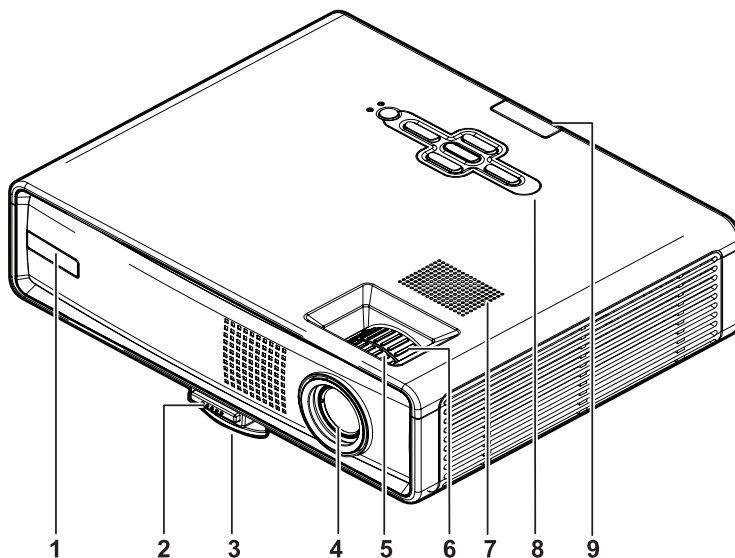

ITEM	LABEL	DESCRIPTION	SEE PAGE:
1.	Front IR receiver	Receiver for IR signal from remote control	11
2.	Height-adjuster button	Push to release height adjuster	19
3.	Height adjuster	Adjusts level of projector	
4.	Lens	Adjust focus/zoom on top opening	20
5.	Focus	Focuses the projected image	
6.	Zoom	Enlarges the projected image	
7.	Speaker	Built-in mono speaker	
8.	See “Top view—OSD buttons and LEDs” on next page		
9.	Rear IR receiver	Receiver for IR signal from remote control	11

**Important:**

Ventilation openings on the projector allow for good air circulation, which keeps the projector lamp cool. Do not obstruct any of the ventilation openings.

*Top view—On-screen Display (OSD) buttons and LEDs*

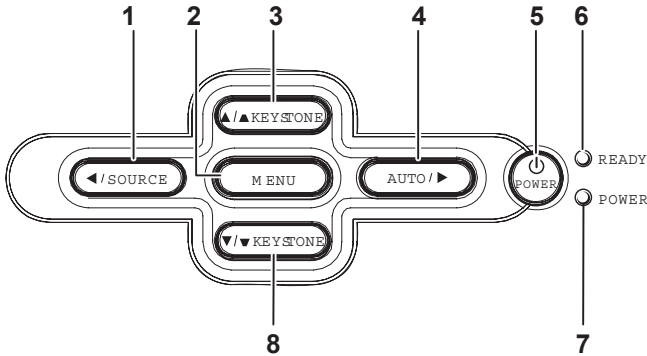

ITEM	LABEL	DESCRIPTION		SEE PAGE:
1.	Source/ Left cursor	Detects the input device Navigates and changes settings in the OSD		16
2.	Menu	Opens and exits the OSD		22
3.	Keystone/ Up cursor	Corrects image-trapezoid (wider top) effect ▲ Navigates and changes settings in the OSD		20
4.	Auto/ Right cursor	Optimizes image size, position, and resolution Navigates and changes settings in the OSD		
5.	Power button	Turns the projector on or off		16
6.	Ready LED	Orange	Lamp ready—you can safely turn on or off the projector	
		Flashing	Lamp not ready—do not press the power button	
7.	Power LED	Green	Unit is powered on and working correctly	
		Off	Unit is powered off	
		Flashing	Operational error code (refer to “LED Error Messages” on page 41)	
8.	Keystone/ Down cursor	Corrects image-trapezoid (wider bottom) effect ▼ Navigates and changes settings in the OSD		20

Rear view

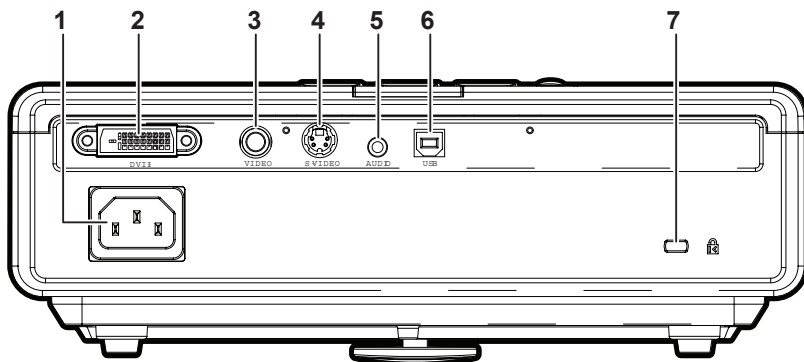

ITEM	LABEL	DESCRIPTION	SEE PAGE:
1.	Power	Connect the supplied power cord	16
2.	DVI-I	Connect the computer cable (supplied) from a computer	15
3.	Video	Connect a composite video cable from a video device	
4.	S-video	Connect the S-video cable (supplied) from a video device	
5.	Audio-in	Connect the audio cable (not supplied) from the input device	
6.	USB	Connect the USB cable (supplied) from a computer	39
7.	Security Lock	Secure to permanent object with a Kensington® Lock system	

**Note:**

*If your video equipment has both S-video and RCA jacks (composite video) connect to the S-video connector.*

*S-video provides a better quality signal.*

*Bottom view*

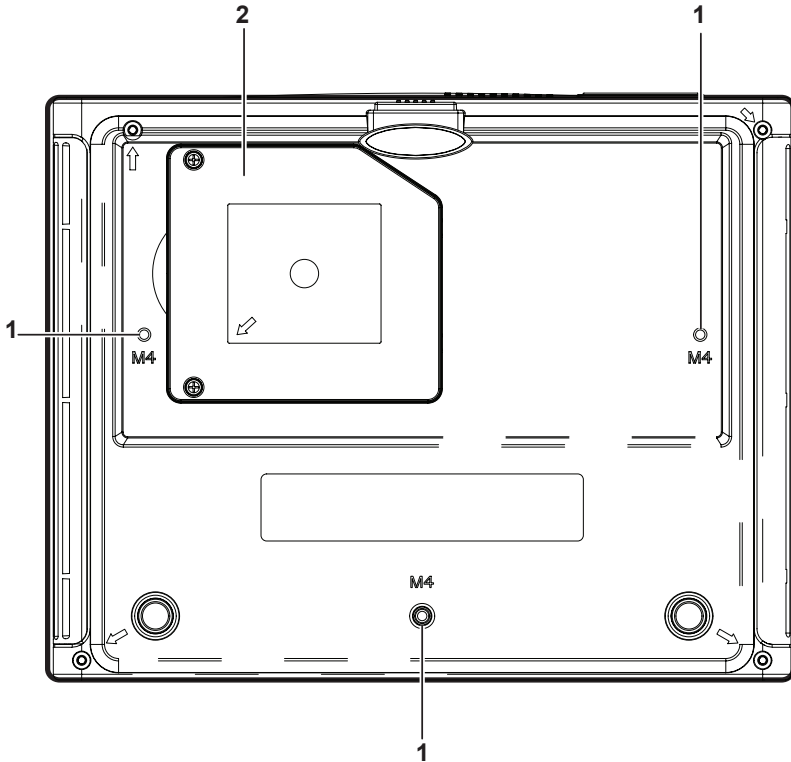

ITEM	LABEL	DESCRIPTION	SEE PAGE:
1.	Ceiling support holes	Contact your dealer for information on mounting the projector on a ceiling.	
2.	Projection lamp cover	Remove when changing lamp	36

**Caution:**

*For ceiling installations, use approved mounting hardware and M4 screws with a maximum screw depth of 6 mm (1/4 inch). To allow for proper ventilation, keep a distance of 50 cm (20 inches) from walls and ceiling. For permanent installations, follow local codes.*

Remote Control Parts (DS125/AB110)

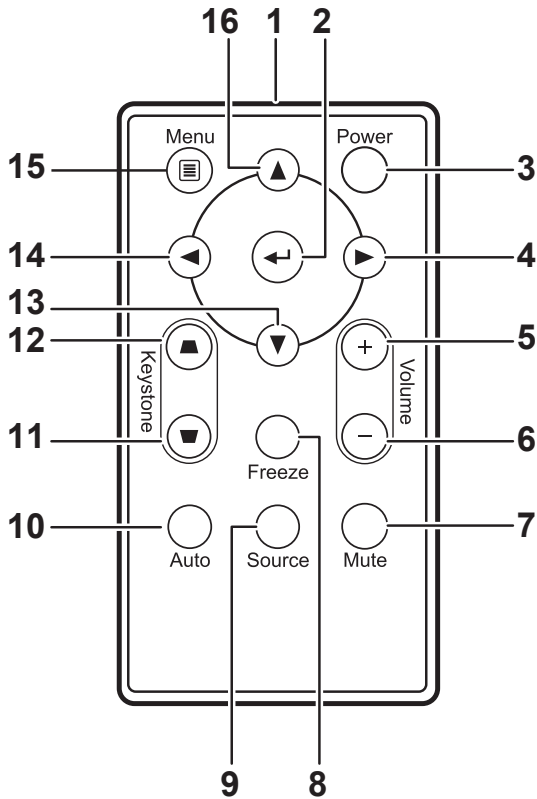

**Important:**

1. Avoid using the projector with bright fluorescent lighting turned on. Certain high-frequency fluorescent lights can disrupt remote control operation.

2. Be sure nothing obstructs the path between the remote control and the projector. If the path between remote control and the projector is obstructed, you can bounce the signal off certain reflective surfaces such as projector screens.

3. The buttons and keys on the projector have the same functions as the corresponding buttons on the remote control. This user’s manual describes the functions based on the remote control.

ITEM	LABEL	DESCRIPTION	SEE PAGE:
1.	IR transmitter	Transmits signals to projector	
2.	Enter	Changes settings in the OSD	22
3.	Power	Turns the projector on or off	16
4.	Right cursor	Navigates and changes settings in the OSD Right arrow when connected through USB to a PC and OSD is Off	22
5.	Volume up	Adjusts volume	21
6.	Volume down	Adjusts volume	
7.	Mute	Mutes the built-in speaker	
8.	Freeze	Freeze/unfreezes the on-screen picture	
9.	Source	Detects the input device	16
10.	Auto	Auto adjustment for phase, tracking, size, position	
11.	Keystone bottom	Corrects image-trapezoid (wider bottom) effect	20
12.	Keystone top	Corrects image-trapezoid (wider top) effect	
13.	Down cursor	Navigates and changes settings in the OSD Down arrow when connected through USB to a PC and OSD is Off	22
14.	Left cursor	Navigates and changes settings in the OSD Left arrow when connected through USB to a PC and OSD is Off	
15.	Menu	Opens the OSD	
16.	Up cursor	Navigates and changes settings in the OSD Up arrow when connected through USB to a PC and OSD is Off	

**Note:**

*The remote control can only interface with a computer when connected to the computer through a USB cable connection. The computer cable connects a computer to the projector for display purposes only.*

Remote Control Parts (DX125/DX130)

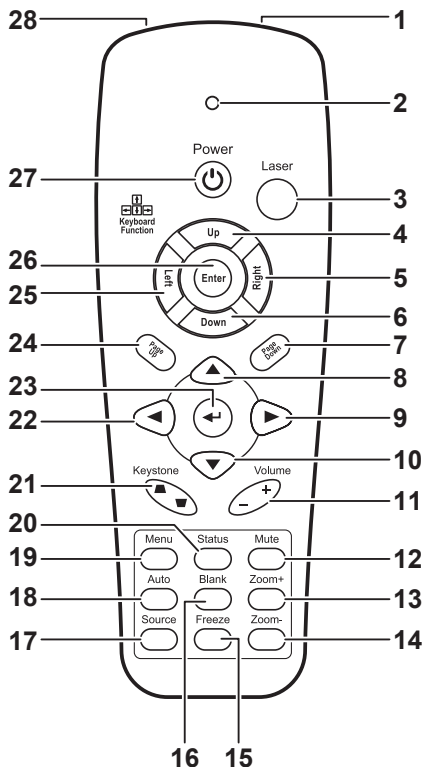

**Important:**

1. Avoid using the projector with bright fluorescent lighting turned on. Certain high-frequency fluorescent lights can disrupt remote control operation.

2. Be sure nothing obstructs the path between the remote control and the projector. If the path between the remote control and the projector is obstructed, you can bounce the signal off certain reflective surfaces such as projector screens.

3. The buttons and keys on the projector have the same functions as the corresponding buttons on the remote control. This user’s manual describes the functions based on the remote control.

ITEM	LABEL	DESCRIPTION	SEE PAGE:
1.	IR transmitter	Transmits signals to projector	
2.	Status LED	Lights when the remote control is used	
3.	Laser	Press to operate the on-screen pointer	

ITEM	LABEL	DESCRIPTION	SEE PAGE:
4.	Up	Up arrow when connected through USB to a PC	
5.	Right	Right arrow when connected through USB to a PC	
6.	Down	Down arrow when connected through USB to a PC	
7.	Page Down	Page down when connected through USB to a PC	
8.	Up cursor	Navigates and changes settings in the OSD	22
9.	Right cursor		
10.	Down cursor		
11.	Volume +/-	Adjusts volume	21
12.	Mute	Mutes the built-in speaker	
13.	Zoom+	Zoom in	
14.	Zoom-	Zoom out	
15.	Freeze	Freeze/unfreezes the on-screen picture	
16.	Blank	Makes the screen blank	
17.	Source	Detects the input device	
18.	Auto	Auto adjustment for phase, tracking, size, position	
19.	Menu	Opens the OSD	22
20.	Status	Opens the OSD Status menu (the menu only opens when an input device is detected)	35
21.	Keystone top/bottom	Corrects image-trapezoid (wider top/bottom) effect	20
22.	Left cursor	Navigates and changes settings in the OSD	22
23.	Enter	Changes settings in the OSD	
24.	Page Up	Page up when connected through USB to a PC	
25.	Left	Left arrow when connected through USB to a PC	
26.	Enter	Enter key when connected through USB to a PC	
27.	Power	Turns the projector on or off	16
28.	Laser	Use as on-screen pointer. <b>DO NOT POINT IN EYES.</b>	



**Note:**

The remote control can only interface with a computer when connected to the computer through a USB cable connection. The computer cable connects a computer to the projector for display purposes only.

**Remote Control Operating Range**

The remote control uses infrared transmission to control the projector. It is not necessary to point the remote directly at the projector. Provided you are not holding the remote perpendicular to the sides or the rear of the projector, the remote will function well within a radius of about 10 meters (33 feet) and 30 degrees above or below the projector level. If the projector does not respond to the remote control, move a little closer.

**Projector and Remote Control Buttons**

The projector can be operated using the remote control or the buttons on the top of the projector. All operations can be carried out with the remote control; however the buttons on the projector are limited in use. The following illustration shows the corresponding buttons on the remote control and on the projector.

Remote Control (DS125/AB110)

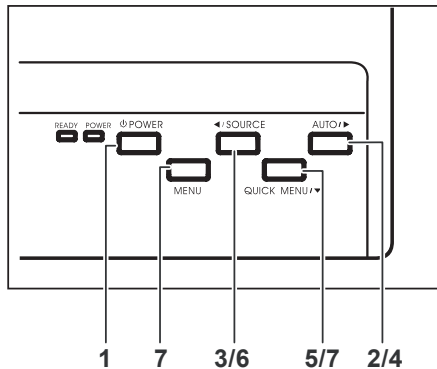
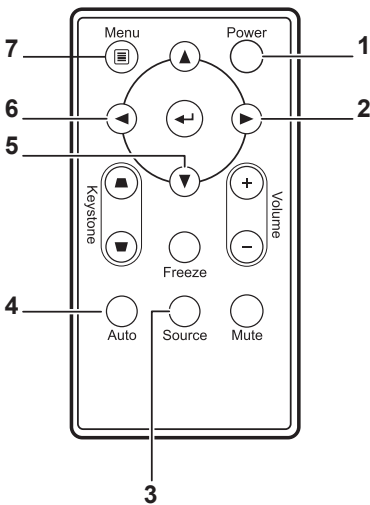

Some buttons on the projector have two functions. For example, item 3/6 on the projector functions both as the source button and as the left cursor key in OSD menus.

**Remote Control (DX125/DX130)**

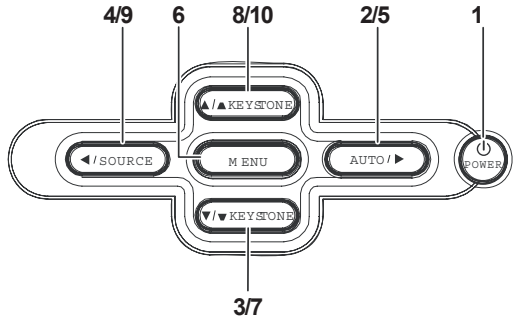
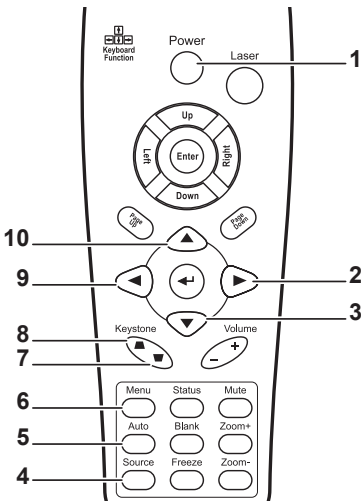

Some buttons on the projector have two functions. For example, item 8/10 on the projector functions both as the keystone button and as the up cursor key in OSD menus.

### Inserting the Remote Control Batteries (DS125/AB110)

1. Remove the battery compartment cover by sliding the cover in the direction of the arrow.

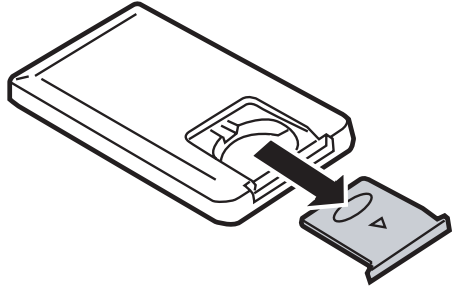

2. Insert the supplied battery with the positive side facing up.

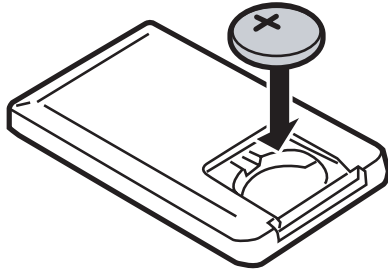

3. Replace the cover.

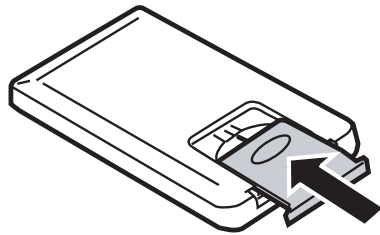

**Caution:**

1. Only use a 3V lithium battery (CR2025).
2. Dispose of used batteries according to local ordinance regulations.
3. Remove the battery when not using the projector for prolonged periods.

## Inserting the Remote Control Batteries (DX125/DX130)

1. Remove the battery compartment cover by sliding the cover in the direction of the arrow.

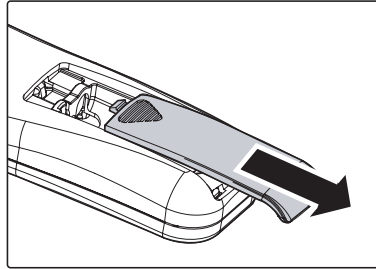

2. Insert the supplied batteries taking note of the polarity (+/-) as shown here.

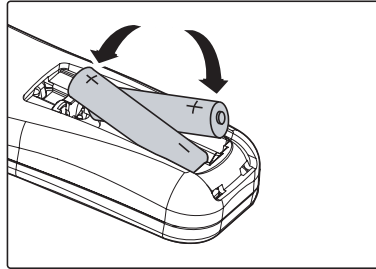

3. Replace the cover.

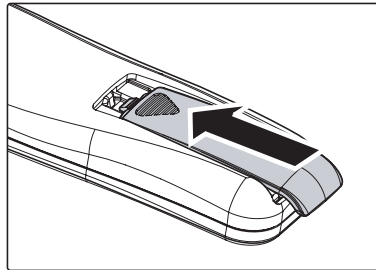

**Caution:**

1. Only use AAA alkaline batteries.
2. Dispose of used batteries according to local ordinance regulations.
3. Remove the batteries when not using the projector for prolonged periods.

## Connecting Input Devices

A PC or notebook computer as well as video devices can be connected to the projector at the same time. Video devices include DVD, VCD, and VHS players, as well as movie camcorders and digital still cameras. Check the user manual of the connecting device to confirm it has the appropriate output connector.

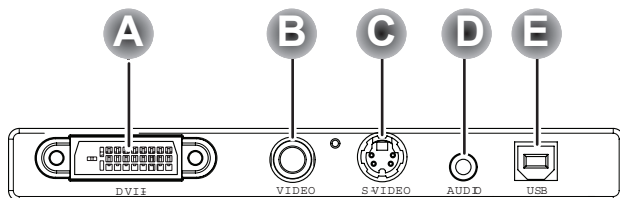

ITEM	LABEL	DESCRIPTION
A	DVI-I	Connect the supplied computer cable from a computer.
	DVI-I + DVI-to-RGB adapter	Connect the DVI-to-RGB adapter to the DVI-I connector. Connect a VGA cable from a computer to the DVI-to-RGB adapter.
	DVI-I + DVI-to-YPbPr adapter	Connect the DVI-to-YPbPr adapter to the DVI-I connector. Connect a component video cable from a video device to the DVI-to-YPbPr adapter.
B	Video	Connect a composite video cable from a video device.
C	S-video	Connect the supplied S-video cable from a video device.
D	Audio-in	Connect an audio cable (not supplied) from the computer’s audio-out connector. Connect an audio cable - mini jack-to-RCA x 2(not supplied) from a video device.
E	USB	Connect the supplied USB cable from a computer.

**Warning:**

As a safety precaution, disconnect all power to the projector and connecting devices before making connections.

## Starting and Shutting down the Projector

1. Connect the power cord to the projector. Connect the other end to a wall outlet. The POWER and READY LEDs on the projector turn on.
2. Turn on the connected devices.
3. Ensure the Ready LED is on a steady (not flashing) orange and then press the **Power** button to turn on the projector.

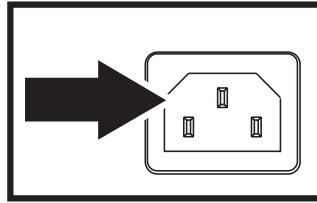

The projector splash screen displays and connected devices are detected. If the connected device is a PC, press the appropriate keys on the computer keyboard to switch the display output to the projector. (Check the user manual of the PC to determine the appropriate Fn key combination to change display output.)

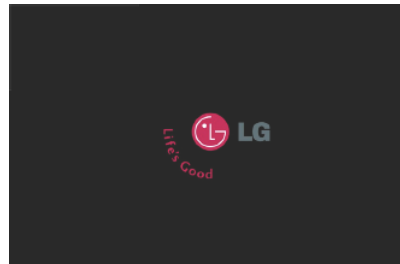

See “Setting an Access Password (Security Lock)” on page 18 if Security Lock is enabled.

4. If more than one input device is connected, press the **Source** button repeatedly to switch among devices. (DVD and HDTV are supported through the DVI-I connector.)



DX125/DX130



AB110



DS125

(Above screens depend on the input and projector model)

5. To turn off the projector, press the **Power** button. The projector prepares for shut-down and a “Wait a moment please...” message appears.



6. When the “Power Off?/Press Power again” message appears, press the **Power** button. The projector turns off.



**Caution:**

*Do not unplug the power cord until the Ready LED stops flashing, indicating the projector has cooled down.*

## Setting an Access Password (Security Lock)

You can use the four cursor (arrow) buttons to set a password and prevent unauthorized use of the projector. When enabled, the password must be entered after you power on the projector. (See “Navigating the OSD” on page 22 and “Setting the OSD Language” on page 24 for help on using OSD menus.)

**Important:**

Keep the password in a safe place. Without the password, you will not be able to use the projector. If you lose the password, contact your reseller for information on clearing the password.

1. Press the **Menu** button to open the OSD menu.
2. Press the cursor **◀▶** button to move to the **Setup** menu.
3. Press the cursor **▲▼** button to select **Advance Feature** and press **Enter** or **▶**.
4. Press the cursor **▲▼** button to select **Security Lock**.
5. Press the cursor **◀▶** button to select **Enable**. (White text is selected.)  
A password dialog box automatically appears.
6. You can only use the cursor buttons **▼▲◀▶** in the password fields. You can use any combination including the same arrow four times, but not less than four.  
Press the cursor buttons in any order to set the password. When you confirm the password, **OK** appears.

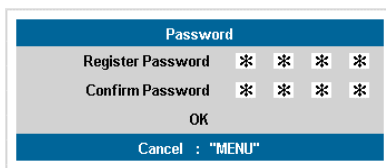
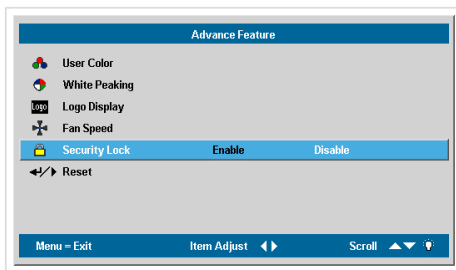
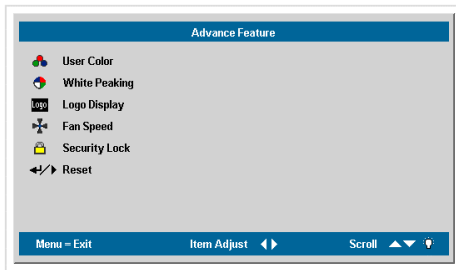

Every time you start the projector, a password dialog box appears.

Enter the password in the order you set it at step 6. (Press the **Menu** button to cancel if you enter the wrong password.)

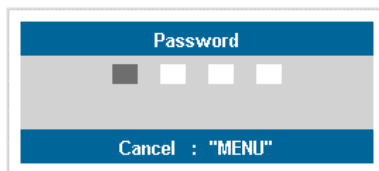



## Adjusting the Projector Level

Take note of the following when setting up the projector:

- *The projector table or stand should be level and sturdy.*
- *Position the projector so that it is perpendicular to the screen.*
- *Be sure cables are not in the way or can cause the projector to be knocked over.*

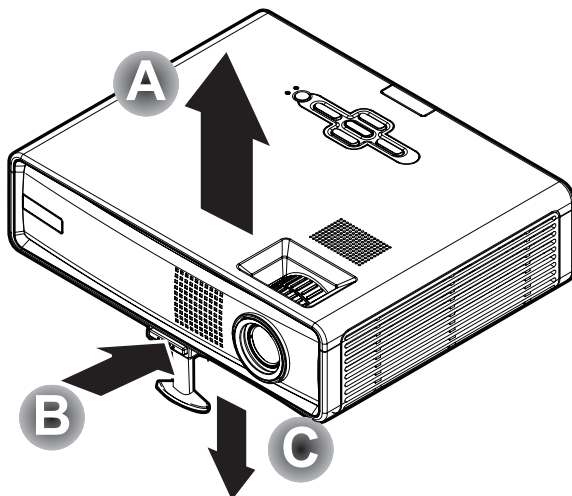

1. To raise the level of the projector, lift the projector [A] and press the height-adjuster button [B].

The height adjuster drops down [C].

2. To lower the level of the projector, press the height-adjuster button and push down on the top of the projector.

## Adjusting the Zoom, Focus and Keystone

1. Use the **Image-focus** control (on the projector only) to sharpen the projected image **A**.
2. Use the **Image-zoom** control (on the projector only) to resize the projected image and screen size **B**.
3. Use the **Keystone** buttons (on the projector or the remote control) to correct image-trapezoid (wider top or bottom) effect.

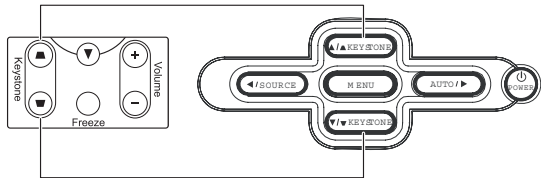
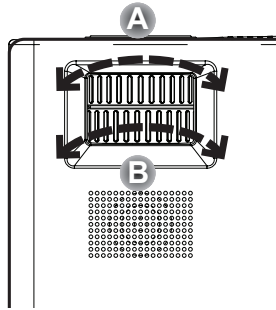

(DS125/AB110)

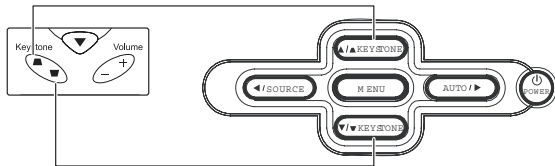

(DX125/DX130)

The keystone control appears on the display.

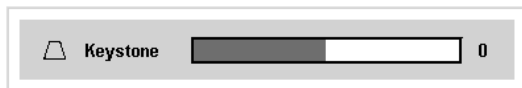

## Adjusting the Volume

1. Press the **Volume +/-** buttons on the remote control.  
The volume control appears on the display.

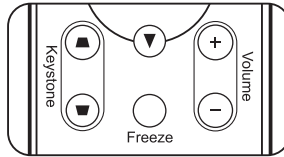

(DS125/AB110)

2. Use the **Volume +/-** buttons to adjust the level.

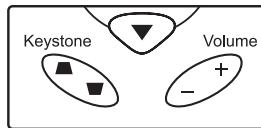

(DX125/DX130)

3. Press the **Mute** button to turn off the volume.



# ON-SCREEN DISPLAY (OSD) MENU SETTINGS

## OSD Menu Controls

The projector has an OSD that lets you make image adjustments and change various settings.

### Navigating the OSD

You can use the remote control cursor buttons or the buttons on the top of the projector to navigate and make changes to the OSD. The following illustration shows the corresponding buttons on the remote control and on the projector.

(DS125/AB110)

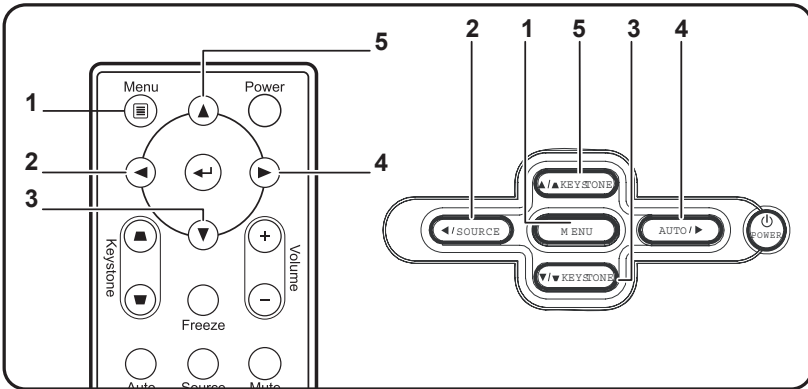

(DX125/DX130)

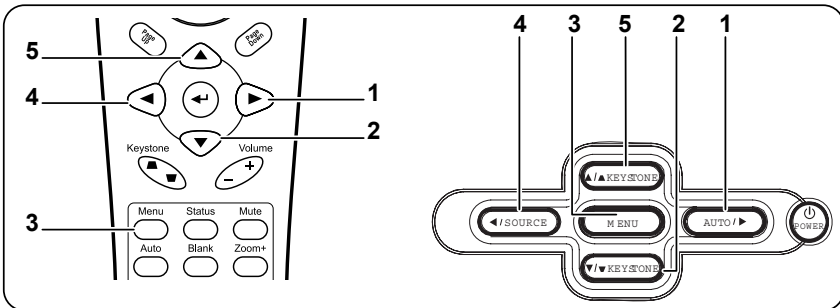

1. To open the OSD, press the **Menu** button.
2. There are six menus. Press the cursor ◀▶ button to move through the menus.
3. Press the cursor ▲▼ button to move up and down in a menu.
4. Press ◀▶ to change values for settings, and then press **Enter** or ▶ to confirm the new setting.
5. Press **Menu** to close the OSD or leave a sub-menu.

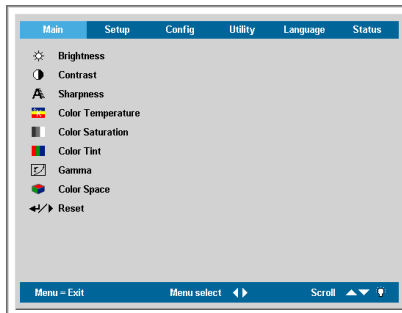

**Note:**

Depending on the video source not all items in the OSD are available. For example, the **Horizontal/Vertical Position** items in the Setup menu can only be modified when connected to a PC. Items that are not available cannot be accessed and are grayed out.

## Setting the OSD Language

You may want to reference the OSD on your projector while reading this section. Set the OSD language to your preference before continuing. (The default language is English.)

1. Press the **Menu** button. The **Main** menu appears.

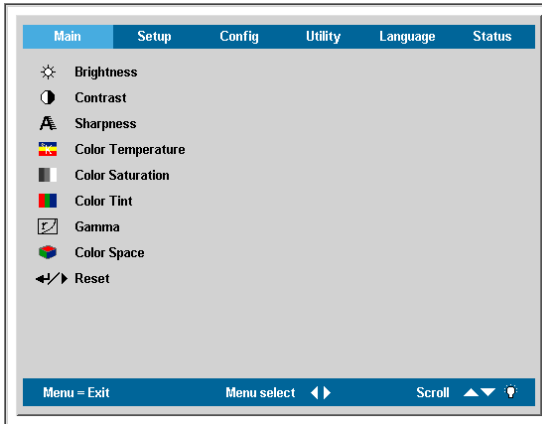

2. Press the cursor ◀▶ button until **Language** is highlighted.



3. Press the cursor ▲▼ button until the language you want is highlighted.
4. Press the cursor ▶ or **Enter** button to confirm the language.
5. Press the **Menu** button twice to close the OSD.

## Main Menu

Press the **Menu** button to open the **OSD** menu. Press the cursor ◀▶ button to move to the **Main** menu. Press the cursor ▲▼ button to move up and down in the **Main** menu. Press ◀▶ to change values for settings, and then press **Enter** or ▶ to confirm the new setting.

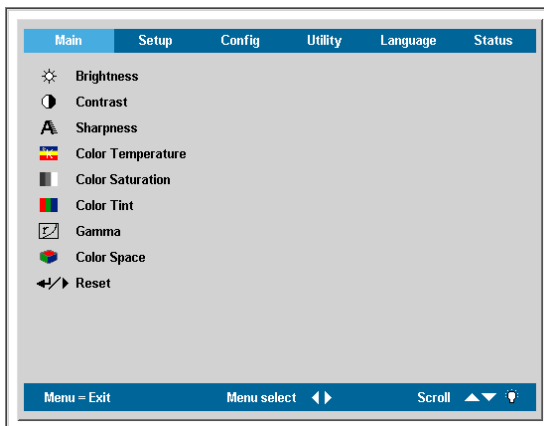

ITEM	DESCRIPTION	DEFAULT																		
Brightness	Press the cursor ◀▶ button to adjust the brightness. (Range: 0 – 100)	50																		
Contrast	Press the cursor ◀▶ button to adjust the contrast. (Range: 0 – 100)	50																		
Sharpness	Press the cursor ◀▶ button to adjust the display sharpness (Range: 1-5)	3																		
Color Temperature	Press the cursor ◀▶ button to adjust the video tint/hue. (Range: Cool/Normal/Warm)	Normal																		
Color Saturation	Press the cursor ◀▶ button to adjust the video saturation. (Range: 0 – 100)	50																		
Color Tint	Press the cursor ◀▶ button to adjust the video tint/hue. (Range: 0 – 100)	50																		
Gamma	Press the cursor ◀▶ button to adjust the gamma correction of the display.  <table border="1" style="margin-left: auto; margin-right: auto;"> <thead> <tr> <th>Input</th> <th>Gamma</th> <th>Brightness</th> </tr> </thead> <tbody> <tr> <td>PC</td> <td>2.2</td> <td>High</td> </tr> <tr> <td>MAC</td> <td>1.8</td> <td>High</td> </tr> <tr> <td>Video</td> <td>2.4</td> <td>Low</td> </tr> <tr> <td>Chart</td> <td>2.2</td> <td>Low</td> </tr> <tr> <td>B&amp;W</td> <td>2.4</td> <td>High</td> </tr> </tbody> </table>	Input	Gamma	Brightness	PC	2.2	High	MAC	1.8	High	Video	2.4	Low	Chart	2.2	Low	B&W	2.4	High	PC
Input	Gamma	Brightness																		
PC	2.2	High																		
MAC	1.8	High																		
Video	2.4	Low																		
Chart	2.2	Low																		
B&W	2.4	High																		
Color Space	Press the cursor ◀▶ button to adjust the color space. (Range: Auto – RGB – YPbPr- YCbCr )	Auto																		

ITEM	DESCRIPTION	DEFAULT
Reset	Resets all <b>Main</b> settings to default values	—

*Main Menu Functions Available for Connected Source*

Function/Source	RGB	DVI	Component Video	Composite Video	S-video
Brightness	○	○	○	○	○
Contrast	○	○	○	○	○
Sharpness	○	○	○	○	○
Color Temp	○	○	○	○	○
Color Saturation			○	○	○
Color Tint			○	○	○
Gamma	○	○	○	○	○
Color Space	○	○	○	○	○
Reset	○	○	○	○	○

○ = User adjustable



## Setup Menu

Press the **Menu** button to open the **OSD** menu. Press the cursor **◀▶** button to move to the **Setup** menu. Press the cursor **▲▼** button to move up and down in the **Setup** menu. Press **◀▶** to change values for settings, and then press **Enter** or **▶** to confirm the new setting.

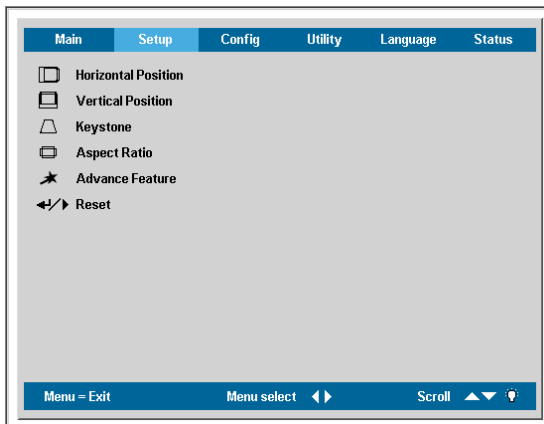

ITEM	DESCRIPTION	DEFAULT
Horizontal Position	Press the cursor <b>◀▶</b> button to move the image left or right. (Range: 0 – 100)	50
Vertical Position	Press the cursor <b>◀▶</b> button to move the image up or down. (Range: 0 – 100)	50
Keystone	Press the cursor <b>◀▶</b> button to correct distortion of the projected image. (Range: -50 – +50)	0
Aspect Ratio	Press the cursor <b>◀▶</b> button to toggle between the 4:3 standard format and the 16:9 High Definition TV (HDTV) format.	DS125 4:3 DX125 4:3 DX130 4:3 AB110 16:9
Advance Feature	See “Advance Feature” on page 28.	—
Reset	Resets Keystone and Aspect Ratio to default values	—

### Setup Menu Functions Available for Connected Source

Function/Source	RGB	DVI	Component Video	Composite Video	S-video
H Position	O				
V Position	O				

Function/Source	RGB	DVI	Component Video	Composite Video	S-video
Keystone correction	O	O	O	O	O
Aspect Ratio	O	O	O	O	O
Advance Feature	O	O	O	O	O
Reset	O	O	O	O	O

O = User adjustable

Advance Feature

Press the **Menu** button to open the **OSD** menu. Press ◀▶ to move to the **Setup** menu. Press ▲▼ to move to the **Advance Feature** menu and then press **Enter** or ▶. Press ▲▼ to move up and down in the **Advance Feature** menu. Press ◀▶ to change values for settings, and then press **Enter** or ▶ to confirm the new setting.

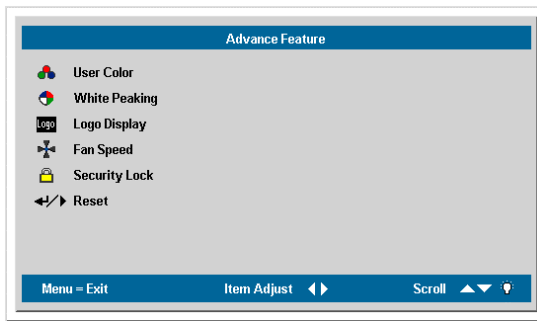

ITEM	DESCRIPTION	DEFAULT	
User Color	<p>This feature adjusts the color balance in each color of RGB (red, green, blue), and their neutral colors (cyan, magenta, yellow, white) by using color correction adjustment. Increasing a color’s setting heightens the intensity of that color on the screen, while a lower setting makes the color less intense.</p> <p>Press ▲▼ to select a color.</p> <p>Press ◀▶ to adjust the selected color. (Range: 0 – 100)</p>		80
White Peaking	<p>White Peaking increases the output in the brightest whites without changing the blacks and dark grays. It crushes the whites slightly, but it does not appear to clip them or seriously obscure white detail. If you prefer a stronger image, adjust toward the maximum setting. For a smoother, more natural image, adjust toward the minimum setting.</p> <p>Press ◀▶ to adjust the value of white peaking. (Range: 0 – 10)</p>	<p>Data source:</p> <p>Video source:</p>	<p>DX125 10 0</p> <p>DX130 10 0</p> <p>DS125 10 0</p> <p>AB110 5 0</p>

ITEM	DESCRIPTION	DEFAULT
Logo Display	Press ◀▶ to enable or disable if the logo displays when the projector starts, and when no source is detected. (Range: On – Off)	On
Fan Speed	Press the cursor ◀▶ button to toggle between Normal and High fan speeds.  Set Fan Speed to <b>High</b> in altitudes over 3,000 meters (10,000 feet).	Normal
Security Lock	<p>Press the cursor ◀▶ button to enable or disable Security Lock. When you enable Security Lock a Register Password dialog box appears:</p> <p>You can only use the cursor buttons ▼▲◀▶ in the password fields. Press the cursor buttons in any order and confirm to set the password. When the password is enabled, it must be entered every time after you power on the projector. See “Setting an Access Password (Security Lock)” on page 18 for steps on setting the password.</p>	No password
Reset	Resets White Peaking, Logo Display and Auto Keystone settings to default values	—

**Note:**

*If Security Lock is enabled, you must enter the password every time the projector is turned on. However, if the projector is already turned on, Security Lock can be disabled without knowing the current password.*

User Color

Press the **Menu** button to open the **OSD** menu. Press ◀▶ to move to the **Setup** menu. Press ▲▼ to move to the **Advance Feature** menu and then press **Enter** or ▶. Press ▲▼ to move to the **User Color** menu and then press **Enter** or ▶. Press ▲▼ to move up and down to select a color. Press ◀▶ to change values for settings, and then press **Enter** or ▶ to confirm the new setting.

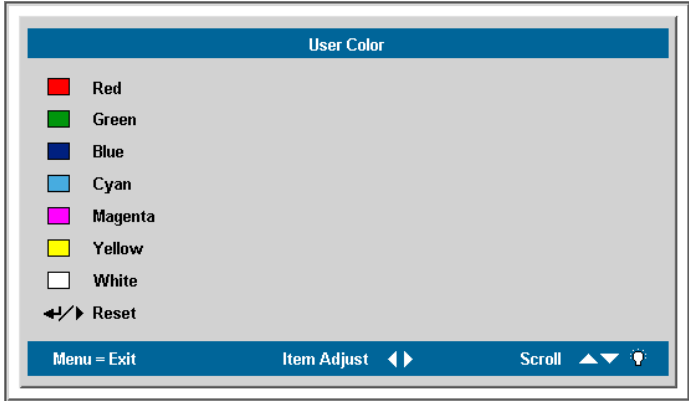

ITEM	DESCRIPTION	DEFAULT
Red	Press the cursor ◀▶ button to adjust the red color level. (Range: 0 - 100)	80
Green	Press the cursor ◀▶ button to adjust the green color level. (Range: 0 - 100)	80
Blue	Press the cursor ◀▶ button to adjust the blue color level. (Range: 0 - 100)	80
Cyan	Press the cursor ◀▶ button to adjust the cyan color level. (Range: 0 - 100)	80
Magenta	Press the cursor ◀▶ button to adjust the magenta color level. (Range: 0 - 100)	80
Yellow	Press the cursor ◀▶ button to adjust the yellow color level. (Range: 0 - 100)	80
White	Press the cursor ◀▶ button to adjust the white color level. (Range: 0 - 100)	80
Reset	Resets all User Color settings to default values	—

## Config Menu

Press the **Menu** button to open the **Main** menu. Press the cursor ◀▶ button to move to the **Config** menu. Press the cursor ▲▼ button to move up and down in the **Config** menu. Press ◀▶ to change values for settings, and then press **Enter** or ▶ to confirm the new setting.

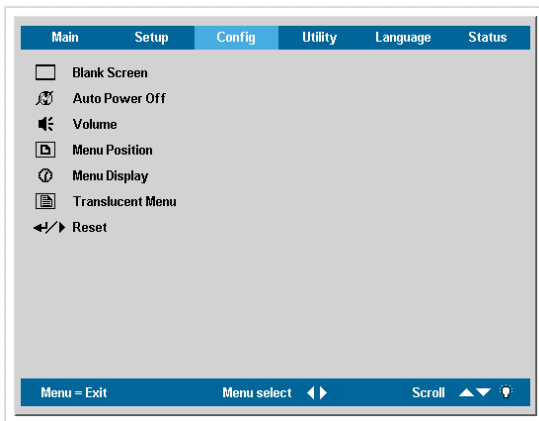





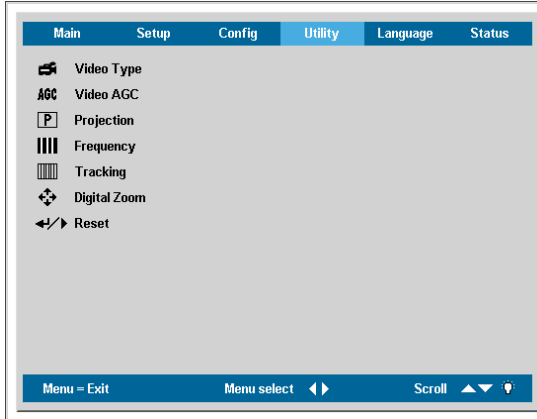

ITEM	DESCRIPTION	DEFAULT
Blank Screen	Press the cursor ◀▶ button to select a background color for the blank screen. (Range: Black – Red – Green – Blue – White)	Blue
Auto Power Off	Press the cursor ◀▶ button to enable or disable automatic shut-down of lamp after 10 minutes of inactivity. (Range: On – Off)	Off
Volume	Press the cursor ◀▶ button to adjust the audio volume level. (Range: 0 - 8)	4
Menu Position	Press the cursor ◀▶ button to position the OSD on screen. (Range: Left – Right – Center – Down – Up)	Center
Menu Display	Press the cursor ◀▶ button to determine the timeout delay of the OSD. (Range: 10 – 20 sec.)	15
Translucent Menu	Press the cursor ◀▶ button to set menu screen translucency. (Range: 0% – 100%)	0%
Reset	Resets all Config items to default values	—

*Note:*  
The Config menu functions are available to all video sources.

## Utility Menu

Press the **Menu** button to open the **Main** menu. Press the cursor **◀▶** button to move to the **Utility** menu. Press the cursor **▲▼** button to move up and down in the **Utility** menu. Press **◀▶** to change values for settings, and then press **Enter** or **▶** to confirm the new setting.



ITEM	DESCRIPTION	DEFAULT
Video Type	Press the cursor <b>◀▶</b> button to select the video standard (Range: Auto – NTSC – PAL – SECAM)	Auto
Video AGC	Press the cursor <b>◀▶</b> button to enable or disable automatic gain control for the video source. (Range: On – Off)	On
Projection	Press the cursor <b>◀▶</b> button to choose from four projection methods: <div style="display: flex; flex-direction: column; gap: 10px;"> <div> Desktop mount, front of screen</div> <div> Desktop mount, rear of screen</div> <div> Ceiling mount, front of screen</div> <div> Ceiling mount, rear of screen</div> </div>	Desktop front 
Frequency	Press the cursor <b>◀▶</b> button to adjust the A/D sampling clock. (Range: 0° - 180°)	Auto detected
Tracking	Press the cursor <b>◀▶</b> button to adjust the A/D sampling number. (Range: 1 - 100)	Auto detected

ITEM	DESCRIPTION	DEFAULT
Digital Zoom	<p>Digital operation for zoom and pan adjustment. Press <b>Enter</b> or <b>▶</b>. The Zoom menu appears.</p> <div data-bbox="325 296 666 459" style="border: 1px solid gray; padding: 5px; margin: 10px 0;"> <p style="text-align: center;">Zoom : ▲▼ Pan : ◀/▶ Exit : "MENU"</p> </div> <p>Press <b>▲</b> to zoom in; press <b>▼</b> to zoom out. Press <b>Enter</b> or <b>▶</b> to open the Pan menu. (You must zoom in before you can open the Pan menu.)</p> <div data-bbox="325 579 666 703" style="border: 1px solid gray; padding: 5px; margin: 10px 0;"> <p style="text-align: center;">Pan : ◀▶ Exit : "MENU"</p> </div> <p>Use the cursor buttons to pan the zoomed image. Press the <b>Menu</b> button to exit.</p>	—
Reset	Resets Video Type, Video AGC, Projection, and Digital Zoom to default values	—

*Utility Menu Functions Available for Connected Source*

Function/Source	RGB	DVI	Component Video	Composite Video	S-video
Video Type				○	○
Video AGC				○	○
Projection	○	○	○	○	○
Frequency	○		○		
Tracking	○				
Digital Zoom	○		○	○	○
Reset	○	○	○	○	○

○ = User adjustable

## Language Menu

Press the **Menu** button to open the **Main** menu. Press the cursor ◀▶ button to move to the **Language** menu. Press the cursor ▲▼ button to move up and down in the **Language** menu. Press **Enter** or ▶ to confirm the new setting.



ITEM	DESCRIPTION	DEFAULT
English		English
Français		
Dtsch		
Italiano		
Español	Press the cursor ▲▼ button to move up and down in the menu.	
Svenska		
简体中文		
繁體中文	Press the <b>Enter</b> or ▶ to confirm the language.	
日本語		
한국어		
Português		
Р у с с к о		



## Status Menu

Press the **Menu** button to open the **Main** menu. Press the cursor **◀▶** button to move to the **Status** menu. Press the cursor **▲▼** button to move up and down in the **Status** menu.

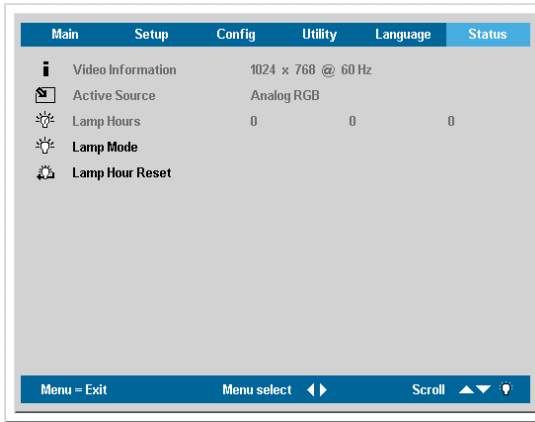

ITEM	DESCRIPTION	DEFAULT
Video Information	Displays the resolution and refresh rate for RGB/DVI mode. Displays the color standard for video mode.	These items are display only.
Active Source	Displays the active source.	
Lamp Hours	Shows the number of hours the lamp has been in use for Low; Middle; and High modes.	
Lamp Mode	Press the cursor <b>◀▶</b> button to choose the lamp mode. Range: Low; Middle; and High.  Low mode uses less power and extends lamp life, but decreases lamp brightness. High mode uses more power and increases lamp brightness, but shortens lamp life.	Middle
Lamp Hour Reset	After replacing the lamp, this item should be reset. Refer to “Replacing the Projection Lamp” on page 36.	—

### Replacing the Projection Lamp

The projection lamp should be replaced when it burns out. It should only be replaced with a certified replacement part, which you can order from your local dealer.

**Important:**

1. The lamp contains a certain amount of mercury and should be disposed of according to local ordinance regulations.

2. Avoid touching the glass surface of the new lamp: Doing so may shorten its operation life.

**Warning:**

Be sure to turn off and unplug the projector at least an hour before replacing the lamp. Failure to do so could result in a severe burn.

1. Loosen the two captive screws on the lamp compartment cover (A).
2. Remove the lamp compartment cover (B).

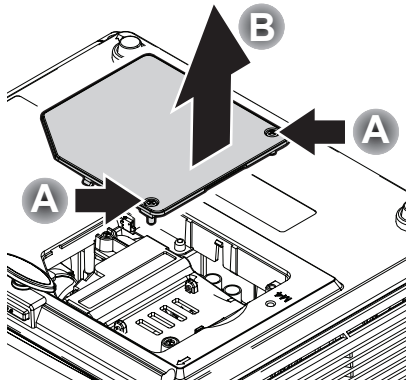

3. Remove the two screws from the lamp module (A).

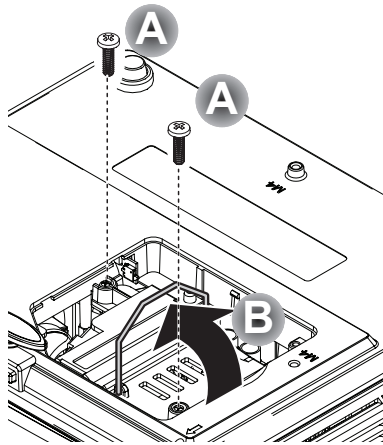

4. Lift the module handle up (B).

5. Pull firmly on the module handle to remove the lamp module.

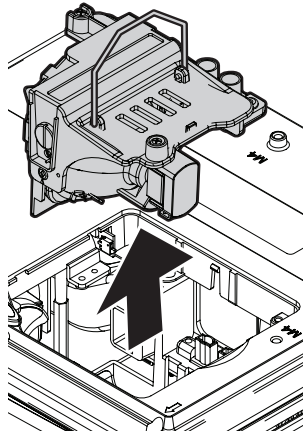

6. Reverse steps 1 to 5 to install the new lamp module.

### Resetting the Lamp

After replacing the lamp, you should reset the lamp hour counter to zero. Refer to the following:

1. Press the **Menu** button to open the Main menu.
2. Press the cursor **◀▶** button to move to the **Status** menu.
3. Press the cursor **▲▼** button to move down to **Lamp Hour Reset**.

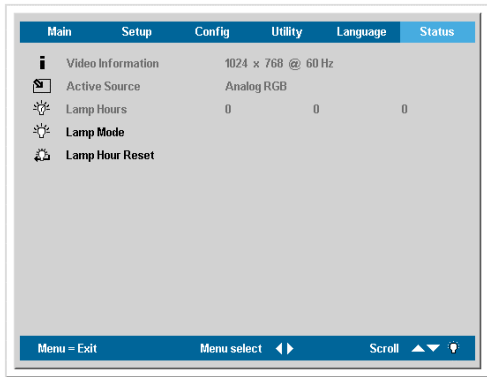

4. Press the cursor **▶** or **Enter** button.

A message screen appears.

5. Press the cursor buttons in this order: **▼; ▲; ◀; ▶**.  
The **Status** menu appears again showing the **Lamp Hours** reset to zero.



## **Cleaning the Projector**

Cleaning the projector to remove dust and grime will help ensure trouble-free operation.

**Warning:**

1. Be sure to turn off and unplug the projector at least an hour before cleaning. Failure to do so could result in a severe burn.
2. Use only a dampened cloth when cleaning. Do not allow water to enter the ventilation openings on the projector.
3. If a little water gets into the projector interior while cleaning, leave unplugged in a well-ventilated room for several hours before using.
4. If a lot of water gets into the projector interior when cleaning, have the projector serviced.

### Cleaning the Lens

You can purchase optic lens cleaner from most camera stores. Refer to the following to clean the projector lens.

1. Apply a little optic lens cleaner to a clean soft cloth. (Do not apply the cleaner directly to the lens.)
2. Lightly wipe the lens in a circular motion.

**Caution:**

1. Do not use abrasive cleaners or solvents.

2. To prevent discoloration or fading, avoid getting cleaner on the projector case.

### Cleaning the Case

Refer to the following to clean the projector case.

1. Wipe off dust with a clean dampened cloth.
2. Moisten the cloth with warm water and mild detergent (such as used to wash dishes), and then wipe the case.
3. Rinse all detergent from the cloth and wipe the projector again.

**Caution:**

To prevent discoloration or fading of the case, do not use abrasive alcohol-based cleaners.

## Using the Kensington® Lock

If you are concerned about security, attach the projector to a permanent object with the Kensington slot and a security cable.

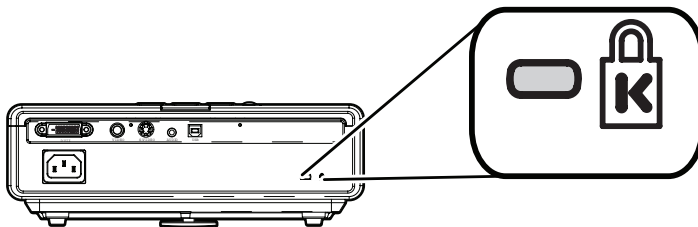

**Note:**

Contact your vendor for details on purchasing a suitable Kensington security cable.

The security lock corresponds to Kensington’s MicroSaver Security System. If you have any comment, contact: Kensington, 2853 Campus Drive, San Mateo, CA94403, U.S.A. Tel: 800-535-4242, <http://www.Kensington.com>.

## Common problems and solutions

These guidelines provide tips to deal with problems you may encounter while using the projector. If the problem remains unsolved, contact your dealer for assistance.

Often after time spent troubleshooting, the problem is traced to something as simple as a loose connection. Check the following before proceeding to the problem-specific solutions.

- *Use some other electrical device to confirm that the electrical outlet is working.*
- *Ensure the projector is turned on.*
- *Ensure all connections are securely attached.*
- *Ensure the attached device is turned on.*
- *Ensure a connected PC is not in suspend mode.*
- *Ensure a connected notebook computer is configured for an external display. (This is usually done by pressing an Fn-key combination on the notebook.)*

## Tips for Troubleshooting

In each problem-specific section, try the steps in the order suggested. This may help you to solve the problem more quickly.

Try to pin point the problem and thus avoid replacing non-defective parts.

For example, if you replace batteries and the problem remains, put the original batteries back and go to the next step.

Keep a record of the steps you take when troubleshooting: The information may be useful when calling for technical support or for passing on to service personnel.

## LED Error Messages

LED	STATUS/ NUMBER OF FLASHES	DESCRIPTION
Ready	Flashing	Lamp not ready—do not press the power button
	1	Burner Fan error
	2	Ballast Fan error
	3	Lamp Fan error
	5	Power Fan error
Power	2	System task created error
	3	System overheating
	4	System interface error
	5	Lamp error
	6	Fan error (refer to Ready LED status to determine which fan)
	7	Lamp cover open
	8	DLP driver error
	9	Color wheel error

## Image Problems

### **Problem: No image appears on the screen**

1. Verify the settings on your notebook or desktop PC.
2. Turn off all equipment and power up again in the correct order.

### **Problem: The image is blurred**

1. Adjust the **Focus** on the projector.
2. Press the **Auto** button on the remote control or projector.
3. Ensure the projector-to-screen distance is within the 10-meter (33-feet) specified range.
4. Check that the projector lens is clean.

### **Problem: The image is wider at the top or bottom (trapezoid effect)**

1. Position the projector so it is as perpendicular to the screen as possible.
2. Use the **Keystone** button on the remote control or projector to correct the problem.

### **Problem: The image is reversed or upside down**

Check the **Projection** setting on the **Utility** menu of the OSD.

### **Problem: The image is streaked**

1. Set the **Frequency** and **Tracking** settings on the **Utility** menu of the OSD to the default settings.

2. To ensure the problem is not caused by a connected PC's video card, connect to another computer.

***Problem: The image is flat with no contrast***

Adjust the **Contrast** setting on the **Main** menu of the OSD.

***Problem: The color of the projected image does not match the source image.***

Adjust the **Color Temperature** and **Gamma** settings on the **Main** menu of the OSD.

## **Lamp Problems**

***Problem: There is no light from the projector***

1. Check that the power cable is securely connected.
2. Ensure the power source is good by testing with another electrical device.
3. Restart the projector in the correct order and check that the Power LED is green.
4. If you have replaced the lamp recently, try resetting the lamp connections.
5. Replace the lamp module.
6. Put the old lamp back in the projector and have the projector serviced.

***Problem: The lamp goes off***

1. Power surges can cause the lamp to turn off. Press the power button twice to turn off the projector. When the Ready LED is on, press the power button.
2. Replace the lamp module.
3. Put the old lamp back in the projector and have the projector serviced.

## **Remote Control Problems**

***Problem: The projector does not respond to the remote control***

1. Direct the remote control towards remote sensor on the projector.
2. Ensure the path between remote and sensor is not obstructed.
3. Turn off any fluorescent lights in the room.
4. Check the battery polarity.
5. Replace the batteries.
6. Turn off other Infrared-enabled devices in the vicinity.
7. Have the remote control serviced.

## **Audio Problems**

***Problem: There is no sound***

1. Adjust the volume on the remote control.
2. Adjust the volume of the audio source.
3. Check the audio cable connection.
4. Test the source audio output with other speakers.
5. Have the projector serviced.

***Problem: The sound is distorted***

1. Check the audio cable connection.
2. Test the source audio output with other speakers.
3. Have the projector serviced.



## **Having the Projector Serviced**

If you are unable to solve the problem, you should have the projector serviced. Pack the projector in the original carton. Include a description of the problem and a checklist of the steps you took when trying to fix the problem: The information may be useful to service personnel. For servicing, return the projector to the place you purchased it.

## Specifications

Display type	DX130	TI DMD 0.7-inch x 1, 12 degrees, DDR DLP w/DDP2000	
	DX125	TI DMD 0.55-inch x 1, 12 degrees, DDR DLP w/DDP2000	
	DS125	TI DMD 0.55-inch x 1, 12 degrees, DDR DLP w/DDP2000	
	AB110	TI DMD 0.53-inch x 1, 12 degrees, DDR DLP w/DDP2000	
Resolution	DX130	Native	XGA 1024 x 768
	DX125		XGA 1024 x 768
	DS125		SVGA 800 x 600
	AB110		480P 854 x 480
Bandwidth	DX130	Up to SXGA 1280x 1024 @ 75 Hz <140MHz >	
	DX125	Up to SXGA 1280x 1024 @ 75 Hz <140MHz >	
	DS125	Up to SXGA 1280x 1024 @ 60 Hz <110MHz >	
	AB110	Up to 1920 x 1080i @60Hz	
Color	DX130 DX125 DS125 AB110	16.7 Million (24-bits/Pixel)	
Brightness Uniformity	DX130 DX125	Min.:	75%
	DS125 AB110	Typical:	85%
Color	DX130 DX125	16.7 Million (24-bits/Pixel)	
Projection distance(Wide/Tele)	DS125 AB110	1.5 to 7 meters (overdrive 1m to 10m)	
Projection screen size	DX130	100"@3.66m 1.04m~4.86m(Wide) 0.89m~4.17m(Tele)	
	DX125	100"@3.94m 0.97m~4.15m(Wide) 0.83m~3.85m(Tele)	
	DS125	100"@3.94m 0.97m~4.15m(Wide) 0.83m~3.85m(Tele)	
	AB110	100"@4.30m 0.89m~4.14m(Wide) 0.76m~3.54m(Tele)	

Projection lens	DX130 DX125 DS125 AB110	Manual Zoom and Focus	
Zoom ratio	DX130 DX125 DS125 AB110	1.16:1	
Keystone correction	DX130	+/- 15°	
Projection methods	DX125 DS125 AB110	Desktop front/rear; Ceiling front/rear	
Data compatibility	DX130 DX125 DS125 AB110	RGB Digital	Up to 110MHz SXGA 1280x1024@60Hz
		RGB Analog	Up to 140 MHz SXGA+ 1400x1050@60Hz
Video compatibility	DX130	SDTV	480i (thru DVI_I)
	DX125	EDTV	480p (thru DVI_I)
	DS125	HDTV	720p, 1080i (thru DVI_I)
	AB110	NTSC/NTSC 4.43, PAL (B/G/H/I/M/N 60), SECAM	
H-Sync	DX130 DX125	15, 31 - 90 kHz	
	DS125 AB110	15, 31 - 70 kHz	
V-Sync	DX130	50 - 85 Hz	
Operating temperature	DX125	5° ~ 35°C @ sea level	
Dimensions (WxDxH)	DS125	See “Projector Dimentions” on page 49	
Weight	AB110	2.05Kg ( 4.5 lbs)	
Power consumption	DX130	Middle Mode :	typical 255 watts @ 110Vac
		Low Mode :	typical 230 watts @ 110Vac
		High Mode :	typical 290 watts @ 110Vac
Stand-By Power	DX125	< 8 watts	
Lamp Power	DS125	Middle Mode :	200 watts
	AB110	Low Mode :	180 watts
		High Mode :	230 watts
Audio speaker		1W mono speaker	

Input/output connectors

PC	DVI-I
	USB
Video	Composite video (RCAx1)
	S-video (Mini-DIN)
Audio	Mini-jack
Security	Kensington slot

## Projection Distance V.S. Projection Size

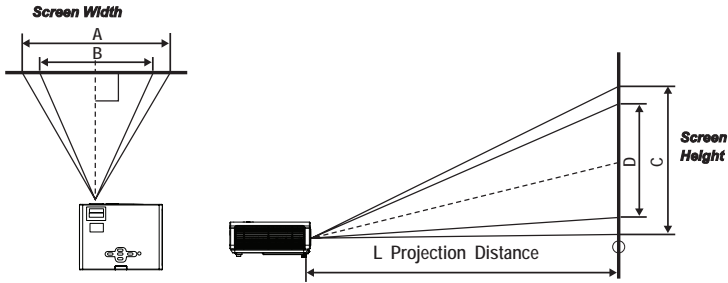

### *DX130*

Projection Distance L	Max. Screen Size (Wide)		1.8	Max. Screen Size (Tele)		2.1
	Diagonal	Width A	Height C	Diagonal	Width B	Height D
1.00 m	0.69 m	0.56 m	0.42 m	0.60 m	0.48 m	0.36 m
3.28'	27.34"	21.87"	16.40"	23.43"	18.75"	14.06"
1.50 m	1.04 m	0.83 m	0.63 m	0.89 m	0.71 m	0.54 m
4.92'	41.01"	32.81"	24.61"	35.15"	28.12"	21.09"
2.40 m	1.67 m	1.33 m	1.00 m	1.43 m	1.14 m	0.86 m
7.87'	65.62"	52.49"	39.37"	56.24"	44.99"	33.75"
2.80 m	1.94 m	1.56 m	1.17 m	1.67 m	1.33 m	1.00 m
9.18'	76.55"	61.24"	45.93"	65.62"	52.49"	39.37"
3.20 m	2.22 m	1.78 m	1.33 m	1.90 m	1.52 m	1.14 m
10.50'	87.49"	69.99"	52.49"	74.99"	59.99"	44.99"
3.60 m	2.50 m	2.00 m	1.50 m	2.14 m	1.71 m	1.29 m
11.81'	98.43"	78.74"	59.06"	84.36"	67.49"	50.62"
4.00 m	2.78 m	2.22 m	1.67 m	2.38 m	1.90 m	1.43 m
13.12'	109.36"	87.49"	65.62"	93.74"	74.99"	56.24"
4.40 m	3.06 m	2.44 m	1.83 m	2.62 m	2.10 m	1.57 m
14.43'	120.30"	96.24"	72.18"	103.11"	82.49"	61.87"
4.80 m	3.33 m	2.67 m	2.00 m	2.86 m	2.29 m	1.71 m
15.74'	131.23"	104.99"	78.74"	112.49"	89.99"	67.49"
5.20 m	3.61 m	2.89 m	2.17 m	3.10 m	2.48 m	1.86 m
17.06'	142.17"	113.74"	85.30"	121.86"	97.49"	73.12"
5.60 m	3.89 m	3.11 m	2.33 m	3.33 m	2.67 m	2.00 m
18.37'	153.11"	122.48"	91.86"	131.23"	104.99"	78.74"
7.00 m	4.86 m	3.89 m	2.92 m	4.17 m	3.33 m	2.50 m
22.96'	191.38"	153.11"	114.83"	164.04"	131.23"	98.43"
10.00 m	6.94 m	5.56 m	4.17 m	5.95 m	4.76 m	3.57 m
32.80'	273.40"	218.72"	164.04"	234.35"	187.48"	140.61"

Shaded rows are equivalent measurement in feet and inches

*DX125/DS125*

Projection Distance L	Max. Screen Size (Wide)		1.94	Max. Screen Size (Tele)		2.27
	Diagonal	Width A	Height C	Diagonal	Width B	Height D
1.00 m	0.64 m	0.52 m	0.39 m	0.55 m	0.44 m	0.33 m
3.28 ' <i>Shaded</i>	25.37 " <i>Shaded</i>	20.29 " <i>Shaded</i>	15.22 " <i>Shaded</i>	21.68 " <i>Shaded</i>	17.34 " <i>Shaded</i>	13.01 " <i>Shaded</i>
1.50 m	0.97 m	0.77 m	0.58 m	0.83 m	0.66 m	0.50 m
4.92 ' <i>Shaded</i>	38.05 " <i>Shaded</i>	30.44 " <i>Shaded</i>	22.83 " <i>Shaded</i>	32.52 " <i>Shaded</i>	26.02 " <i>Shaded</i>	19.51 " <i>Shaded</i>
2.40 m	1.55 m	1.24 m	0.93 m	1.32 m	1.06 m	0.79 m
7.87 ' <i>Shaded</i>	60.88 " <i>Shaded</i>	48.71 " <i>Shaded</i>	36.53 " <i>Shaded</i>	52.03 " <i>Shaded</i>	41.62 " <i>Shaded</i>	31.22 " <i>Shaded</i>
2.80 m	1.80 m	1.44 m	1.08 m	1.54 m	1.23 m	0.93 m
9.18 ' <i>Shaded</i>	71.03 " <i>Shaded</i>	56.82 " <i>Shaded</i>	42.62 " <i>Shaded</i>	60.70 " <i>Shaded</i>	48.56 " <i>Shaded</i>	36.42 " <i>Shaded</i>
3.20 m	2.06 m	1.65 m	1.24 m	1.76 m	1.41 m	1.06 m
10.50 ' <i>Shaded</i>	81.18 " <i>Shaded</i>	64.94 " <i>Shaded</i>	48.71 " <i>Shaded</i>	69.37 " <i>Shaded</i>	55.50 " <i>Shaded</i>	41.62 " <i>Shaded</i>
3.60 m	2.32 m	1.86 m	1.39 m	1.98 m	1.59 m	1.19 m
11.81 ' <i>Shaded</i>	91.32 " <i>Shaded</i>	73.06 " <i>Shaded</i>	54.79 " <i>Shaded</i>	78.05 " <i>Shaded</i>	62.44 " <i>Shaded</i>	46.83 " <i>Shaded</i>
4.00 m	2.58 m	2.06 m	1.55 m	2.20 m	1.76 m	1.32 m
13.12 ' <i>Shaded</i>	101.47 " <i>Shaded</i>	81.18 " <i>Shaded</i>	60.88 " <i>Shaded</i>	86.72 " <i>Shaded</i>	69.37 " <i>Shaded</i>	52.03 " <i>Shaded</i>
4.40 m	2.84 m	2.27 m	1.70 m	2.42 m	1.94 m	1.45 m
14.43 ' <i>Shaded</i>	111.62 " <i>Shaded</i>	89.29 " <i>Shaded</i>	66.97 " <i>Shaded</i>	95.39 " <i>Shaded</i>	76.31 " <i>Shaded</i>	57.23 " <i>Shaded</i>
4.80 m	3.09 m	2.47 m	1.86 m	2.64 m	2.11 m	1.59 m
15.74 ' <i>Shaded</i>	121.76 " <i>Shaded</i>	97.41 " <i>Shaded</i>	73.06 " <i>Shaded</i>	104.06 " <i>Shaded</i>	83.25 " <i>Shaded</i>	62.44 " <i>Shaded</i>
5.20 m	3.35 m	2.68 m	2.01 m	2.86 m	2.29 m	1.72 m
17.06 ' <i>Shaded</i>	131.91 " <i>Shaded</i>	105.53 " <i>Shaded</i>	79.15 " <i>Shaded</i>	112.73 " <i>Shaded</i>	90.19 " <i>Shaded</i>	67.64 " <i>Shaded</i>
5.60 m	3.61 m	2.89 m	2.16 m	3.08 m	2.47 m	1.85 m
18.37 ' <i>Shaded</i>	142.06 " <i>Shaded</i>	113.65 " <i>Shaded</i>	85.23 " <i>Shaded</i>	121.41 " <i>Shaded</i>	97.12 " <i>Shaded</i>	72.84 " <i>Shaded</i>
7.00 m	4.51 m	3.61 m	2.71 m	3.85 m	3.08 m	2.31 m
22.96 ' <i>Shaded</i>	177.57 " <i>Shaded</i>	142.06 " <i>Shaded</i>	106.54 " <i>Shaded</i>	151.76 " <i>Shaded</i>	121.41 " <i>Shaded</i>	91.05 " <i>Shaded</i>
10.00 m	6.44 m	5.15 m	3.87 m	5.51 m	4.41 m	3.30 m
32.80 ' <i>Shaded</i>	253.67 " <i>Shaded</i>	202.94 " <i>Shaded</i>	152.20 " <i>Shaded</i>	216.80 " <i>Shaded</i>	173.44 " <i>Shaded</i>	130.08 " <i>Shaded</i>

*Shaded rows are equivalent measurement in feet and inches*

AB110

Projection Distance L	Max. Screen Size (Wide)		1.94	Max. Screen Size (Tele)		2.27
	Diagonal	Width A	Height C	Diagonal	Width B	Height D
1.00 m	0.59 m	0.52 m	0.29 m	0.51 m	0.44 m	0.25 m
3.28 ' <i>Shaded</i>	23.28 " <i>Shaded</i>	20.29 " <i>Shaded</i>	11.42 " <i>Shaded</i>	19.89 " <i>Shaded</i>	17.34 " <i>Shaded</i>	9.76 " <i>Shaded</i>
1.50 m	0.89 m	0.77 m	0.43 m	0.76 m	0.66 m	0.37 m
4.92 ' <i>Shaded</i>	34.92 " <i>Shaded</i>	30.44 " <i>Shaded</i>	17.12 " <i>Shaded</i>	29.84 " <i>Shaded</i>	26.02 " <i>Shaded</i>	14.63 " <i>Shaded</i>
2.40 m	1.42 m	1.24 m	0.70 m	1.21 m	1.06 m	0.59 m
7.87 ' <i>Shaded</i>	55.86 " <i>Shaded</i>	48.71 " <i>Shaded</i>	27.40 " <i>Shaded</i>	47.74 " <i>Shaded</i>	41.62 " <i>Shaded</i>	23.41 " <i>Shaded</i>
2.80 m	1.66 m	1.44 m	0.81 m	1.41 m	1.23 m	0.69 m
9.18 ' <i>Shaded</i>	65.18 " <i>Shaded</i>	56.82 " <i>Shaded</i>	31.96 " <i>Shaded</i>	55.70 " <i>Shaded</i>	48.56 " <i>Shaded</i>	27.32 " <i>Shaded</i>
3.20 m	1.89 m	1.65 m	0.93 m	1.62 m	1.41 m	0.79 m
10.50 ' <i>Shaded</i>	74.49 " <i>Shaded</i>	64.94 " <i>Shaded</i>	36.53 " <i>Shaded</i>	63.66 " <i>Shaded</i>	55.50 " <i>Shaded</i>	31.22 " <i>Shaded</i>
3.60 m	2.13 m	1.86 m	1.04 m	1.82 m	1.59 m	0.89 m
11.81 ' <i>Shaded</i>	83.80 " <i>Shaded</i>	73.06 " <i>Shaded</i>	41.10 " <i>Shaded</i>	71.62 " <i>Shaded</i>	62.44 " <i>Shaded</i>	35.12 " <i>Shaded</i>
4.00 m	2.36 m	2.06 m	1.16 m	2.02 m	1.76 m	0.99 m
13.12 ' <i>Shaded</i>	93.11 " <i>Shaded</i>	81.18 " <i>Shaded</i>	45.66 " <i>Shaded</i>	79.57 " <i>Shaded</i>	69.37 " <i>Shaded</i>	39.02 " <i>Shaded</i>
4.40 m	2.60 m	2.27 m	1.28 m	2.22 m	1.94 m	1.09 m
14.43 ' <i>Shaded</i>	102.42 " <i>Shaded</i>	89.29 " <i>Shaded</i>	50.23 " <i>Shaded</i>	87.53 " <i>Shaded</i>	76.31 " <i>Shaded</i>	42.93 " <i>Shaded</i>
4.80 m	2.84 m	2.47 m	1.39 m	2.43 m	2.11 m	1.19 m
15.74 ' <i>Shaded</i>	111.73 " <i>Shaded</i>	97.41 " <i>Shaded</i>	54.79 " <i>Shaded</i>	95.49 " <i>Shaded</i>	83.25 " <i>Shaded</i>	46.83 " <i>Shaded</i>
5.20 m	3.07 m	2.68 m	1.51 m	2.63 m	2.29 m	1.29 m
17.06 ' <i>Shaded</i>	121.04 " <i>Shaded</i>	105.53 " <i>Shaded</i>	59.36 " <i>Shaded</i>	103.44 " <i>Shaded</i>	90.19 " <i>Shaded</i>	50.73 " <i>Shaded</i>
5.60 m	3.31 m	2.89 m	1.62 m	2.83 m	2.47 m	1.39 m
18.37 ' <i>Shaded</i>	130.35 " <i>Shaded</i>	113.65 " <i>Shaded</i>	63.93 " <i>Shaded</i>	111.40 " <i>Shaded</i>	97.12 " <i>Shaded</i>	54.63 " <i>Shaded</i>
7.00 m	4.14 m	3.61 m	2.03 m	3.54 m	3.08 m	1.73 m
22.96 ' <i>Shaded</i>	162.94 " <i>Shaded</i>	142.06 " <i>Shaded</i>	79.91 " <i>Shaded</i>	139.25 " <i>Shaded</i>	121.41 " <i>Shaded</i>	68.29 " <i>Shaded</i>
10.00 m	5.91 m	5.15 m	2.90 m	5.05 m	4.41 m	2.48 m
32.80 ' <i>Shaded</i>	232.77 " <i>Shaded</i>	202.94 " <i>Shaded</i>	114.15 " <i>Shaded</i>	198.93 " <i>Shaded</i>	173.44 " <i>Shaded</i>	97.56 " <i>Shaded</i>

*Shaded rows are equivalent measurement in feet and inches*

## Timing Mode Table

The projector can display several resolutions. The following table outlines the resolutions that can be displayed by the projector.

Signal	Resolution	Frequency H. (KHz)	Refresh Rate (Hz)	Video	Digital	Analog
<b>Video Source</b>						
NTSC	—	15.734	60.0	○	—	—
PAL/SECAM	—	15.625	50.0	○	—	—
SDTV	480i	15.8	60.0	○	—	—
	576i	15.6	50.0	○	—	—
EDTV	480p	31.5	60.0	○	—	—
	576p	31.3	50.0	○	—	—
HDTV	720p	45.0	60.0	○	—	—
	1080i	33.8	60.0	○	—	—
	1080i	28.1	50.0	○	—	—
<b>Data Source</b>						
VESA	640 x 400	37.9	85.0	—	○	○
	640 x 480	31.5	60.0	—	○	○
	640 x 480	37.9	72.0	—	○	○
	640 x 480	37.5	75.0	—	○	○
	640 x 480	43.3	85.0	—	○	○
	800 x 600	35.2	56.0	—	○	○
	800 x 600	37.9	60.0	—	○	○
	800 x 600	46.9	75.0	—	○	○
	800 x 600	48.1	72.0	—	○	○
	800 x 600	53.7	85.0	—	○	○
	1024 x 768	48.4	60.0	—	○	○
	1024 x 768	56.5	70.0	—	○	○
	1024 x 768	60.0	75.0	—	○	○
	1024 x 768	68.7	85	—	○	○
	1440 x 900	55.6	60	—	○	○
	1280 x 1024	63.98	60.0	—	○	○



Signal	Resolution	Frequency H. (KHz)	Refresh Rate (Hz)	Video	Digital	Analog
	1280 x 1024	79.98	75.0	–	–	○
	1400 x 1050	65.3	60	–	–	○
	1400 x 1050	64.7	60	–	–	○
Apple Macintosh	640 x 480	34.98	66.66	–	○	○
	640 x 480	35.0	66.68	–	○	○
	832 x 624	49.725	74.55	–	○	○
	1024 x 768	60.24	75	–	○	○
	1152 x 870	68.68	75.06	–	○	○

○: Frequency supported

–: Frequency not supported

### Projector Dimensions

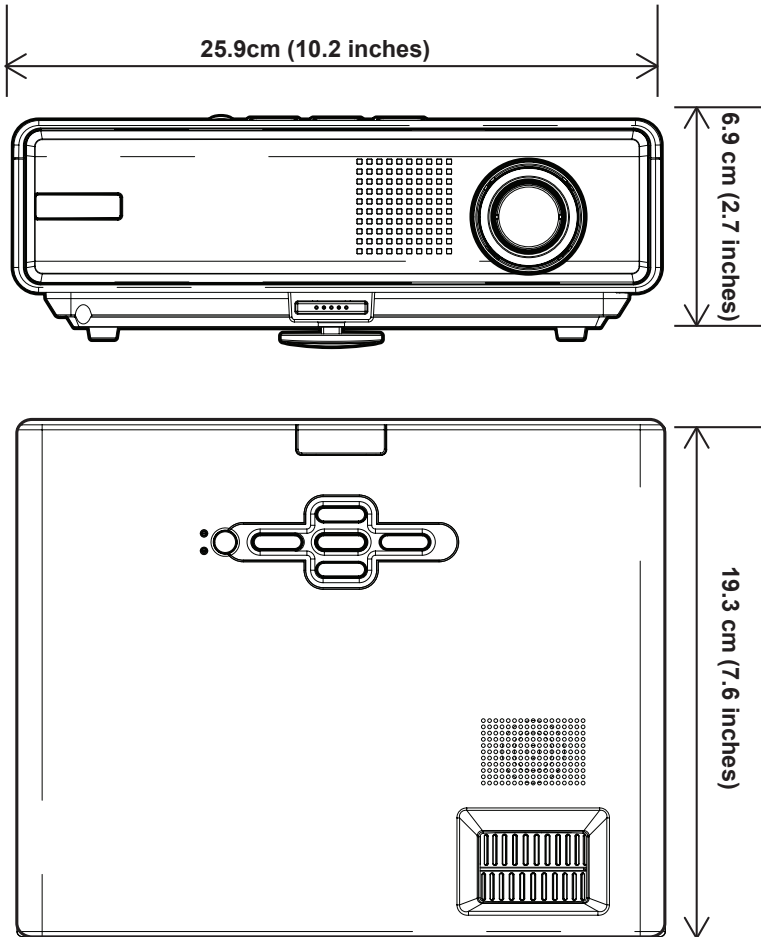

### **FCC Warning**

This equipment has been tested and found to comply with the limits for a Class B digital device pursuant to Part 15 of the FCC Rules. These limits are designed to provide reasonable protection against harmful interference when the equipment is operated in a commercial environment.

This equipment generates, uses, and can radiate radio frequency energy and, if not installed and used in accordance with the instruction manual, may cause harmful interference to radio communications. Operation of this equipment in a residential area is likely to cause harmful interference in which case the user will be required to correct the interference at his own expense.

Changes or modifications not expressly approved by the parties responsible for compliance could void the user's authority to operate the equipment.

### **Canada**

This class B digital apparatus complies with Canadian ICES-003.

### **Safety Certifications**

FCC Class B, UL, CE, CB, GOST, MIC, SABS, C-TICK

### **EN 55022 Warning**

This is a Class B product. In a domestic environment, it may cause radio interference, in which case the user may be required to take adequate measures. The typical use is in a conference room, meeting room, or auditorium.