

Panasonic®

LCD Projector Commercial Use

Operating Instructions

Model No. **PT-LC80U**
PT-LC76U
PT-LC56U

ENGLISH

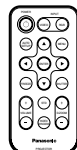
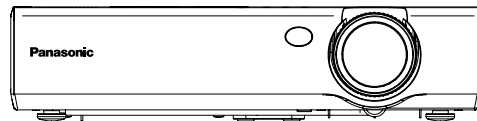

ProSelecta

View :: Compare :: Select - www.ProSelecta.com

Dear Panasonic Customer:

This instruction booklet provides all the necessary operating information that you might require. We hope it will help you to get the most performance out of your new product, and that you will be pleased with your Panasonic LCD projector.

The serial number of your product may be found on its bottom. You should note it in the space provided below and retain this booklet in case service is required.

Model number: **PT-LC80U / PT-LC76U / PT-LC56U**

Serial number: _____

IMPORTANT SAFETY NOTICE

WARNING: TO REDUCE THE RISK OF FIRE OR ELECTRIC SHOCK, DO NOT EXPOSE THIS PRODUCT TO RAIN OR MOISTURE.

Power Supply: This LCD Projector is designed to operate on 100 V – 240 V, 50 Hz/60 Hz AC, house current only.

CAUTION: The AC power cord which is supplied with the projector as an accessory can only be used for power supplies up to 125 V, 7 A. If you need to use higher voltages or currents than this, you will need to obtain a separate 250 V power cord. If you use the accessory cord in such situations, fire may result.



The lightning flash with arrowhead symbol, within an equilateral triangle, is intended to alert the user to the presence of uninsulated "dangerous voltage" within the product's enclosure that may be of sufficient magnitude to constitute a risk of electric shock to persons.



The exclamation point within an equilateral triangle is intended to alert the user to the presence of important operating and maintenance (servicing) instructions in the literature accompanying the product.

WARNING:

This equipment has been tested and found to comply with the limits for a Class B digital device, pursuant to Part 15 of the FCC Rules. These limits are designed to provide reasonable protection against harmful interference in a residential installation. This equipment generates, uses, and can radiate radio frequency energy and, if not installed and used in accordance with the instructions, may cause harmful interference to radio communications. However, there is no guarantee that interference will not occur in a particular installation. If this equipment does cause harmful interference to radio or television reception, which can be determined by turning the equipment off and on, the user is encouraged to try to correct the interference by one or more of the following measures:

- Reorient or relocate the receiving antenna.
- Increase the separation between the equipment and receiver.
- Connect the equipment into an outlet on a circuit different from that to which the receiver is connected.
- Consult the dealer or an experienced radio/TV technician for help.

CAUTION: Any unauthorized changes or modifications to this equipment will void the users authority to operate.

FCC CAUTION: To assure continued compliance, follow the attached installation instructions, which includes using the provided power cord and shielded interface cables when connecting to computer or peripheral device. If you use serial port to connect PC for external control of projector, you must use optional RS-232C serial interface cable with ferrite core. Any unauthorized changes or modifications to this equipment will void the user's authority to operate.

Declaration of Conformity

Model Number: PT-LC80U / PT-LC76U / PT-LC56U

Trade Name: **Panasonic**

Responsible party: Matsushita Electric Corporation of America.

Address: One Panasonic Way Secaucus New Jersey 07094

Telephone number: 1-800-528-8601 or 1-800-222-0741

Email: pbtsservice@panasonic.com

This device complies with Part 15 of the FCC Rules, Operation is subject to the following two conditions: (1) This device may not cause harmful interference, and (2) this device must accept any interference received, including interference that may cause undesired operation.

Contents

Preparation

IMPORTANT SAFETY NOTICE ...2

Precautions with regard to safety5

Accessories9

Before use10

Location and function of each part.....12

Getting started

Setting-up17

Projection methods, Projector position, Projection distances

Connections19

Example of connecting to video equipments, Example of connecting to computer

Preparation for the remote control unit.....21

Basic Operation

Turning on the power22

Turning off the power24

Useful functions

Correcting keystone distortion and automatic positioning.....26

Turning off the picture and sound momentarily27

Pausing a picture.....27

Enlarging the picture.....28

Adjusting the volume28

Displaying two screens.....29

Adjustments and settings

On-screen menus30

Menu screens, Menu operation guide, Returning a setting to the factory default

Correcting keystone distortion34

Adjusting the picture.....35

PICTURE MODE, CONTRAST, BRIGHT, COLOR, TINT, SHARPNESS, Color Hue Setting, WHITE BALANCE R/G/B,

TV-SYSTEM, STILL MODE, SIGNAL MODE, Projecting sRGB-compatible pictures

Adjusting the position.....38

POSITION, DOT CLOCK, CLOCK PHASE, ASPECT, RESIZING, FRAME LOCK

Changing the display language.....41

Option settings42

OSD, AUTO SIGNAL, AUTO KEYSTN, AUTO RGB IN, RGB2 SELECT, RGB/YPbPr, VGA60/525P, SXGA MODE, BLACKBOARD, BACK COLOR, FRONT/REAR, DESK/CEILING, FAN CONTROL, LAMP POWER, LAMP RUNTIME, FUNC 1, CONTROL KEY, AUTO POW.OFF

Setting up the SECURITY function45

INPUT/AMEND PASSWD, TEXT DISPLAY/CHANGE

Care and maintenance

When the TEMP indicator and the LAMP indicator are illuminated.....47

Cleaning and replacing the air filter49

Replacing the lamp unit50

Before calling for service.....53

Cleaning and maintenance55

Others

Specifications56

Appendix58

List of compatible signals, Connector pin wiring, Projection dimensions calculation methods, Using the SERIAL connector

Dimensions62

Trademark acknowledgements62

NOTES IMPORTANTES

CONCERNANT LA SÉCURITÉ...62

Précautions de sécurité.....63

Précautions de manipulation.....67

Remplacement du bloc de lampe...69

Precautions with regard to safety

WARNING

If a problem occurs (such as no image or no sound) or if you notice smoke or a strange smell coming from the projector, turn off the power and disconnect the power cord from the wall outlet.

- Do not continue to use the projector in such cases, otherwise fire or electric shocks could result.
- Check that no more smoke is coming out, and then contact an Authorised Service Center for repairs.
- Do not attempt to repair the projector yourself, as this can be dangerous.

Do not install this projector in a place which is not strong enough to take the full weight of the projector.

- If the installation location is not strong enough, it may fall down or tip over, and severe injury or damage could result.

Installation work (such as ceiling suspension) should only be carried out by a qualified technician.

- If installation is not carried out correctly, there is the danger that injury or electric shocks may occur.

If foreign objects or water get inside the projector, or if the projector is dropped or the cabinet is broken, turn off the power and disconnect the power cord from the wall outlet.

- Continued use of the projector in this condition may result in fire or electric shocks.
- Contact an Authorised Service Center for repairs.

Do not overload the wall outlet.

- If the power supply is overloaded (for example, by using too many adapters), overheating may occur and fire may result.

Do not remove the cover or modify it in any way.

- High voltages which can cause fire or electric shocks are present inside the projector.
- For any inspection, adjustment and repair work, please contact an Authorised Service Center.

Clean the power cord plug regularly to prevent it from becoming covered in dust.

- If dust builds up on the power cord plug, the resulting humidity can damage the insulation, which could result in fire. Pull the power cord out from the wall outlet and wipe it with a dry cloth.
- If not using the projector for an extended period of time, pull the power cord plug out from the wall outlet.

Do not do anything that might damage the power cord or the power cord plug.

- Do not damage the power cord, make any modifications to it, place it near any hot objects, bend it excessively, twist it, pull it, place heavy objects on top of it or wrap it into a bundle.
- If the power cord is used while damaged, electric shocks, short-circuits or fire may result.
- Ask an Authorised Service Center to carry out any repairs to the power cord that might be necessary.

Do not handle the power cord plug with wet hands.

- Failure to observe this may result in electric shocks.

Insert the power cord plug securely into the wall outlet.

- If the plug is not inserted correctly, electric shocks or overheating could result.
- Do not use plugs which are damaged or wall outlets which are coming loose from the wall.

Do not place the projector on top of surfaces which are unstable.

- If the projector is placed on top of a surface which is sloped or unstable, it may fall down or tip over, and injury or damage could result.

Do not place the projector into water or let it become wet.

- Failure to observe this may result in fire or electric shocks.

Do not place liquid containers on top of the projector.

- If water spills onto the projector or gets inside it, fire or electric shocks could result.
- If any water gets inside the projector, contact an Authorised Service Center.

Do not insert any foreign objects into the projector.

- Do not insert any metal objects or flammable objects into the projector or drop them onto the projector, as doing so can result in fire or electric shocks.

Do not place the projector on soft materials such as carpets or sponge mats.

- Doing so may cause the projector to overheat, which can cause burns, fire or damage to the projector.

After removing the battery from the remote control unit, keep the battery out of the reach of small children and infants.

- The battery can cause death by suffocation if swallowed.
- If the battery is swallowed, seek medical advice straight away.

Do not allow the + and - terminals of the batteries to come into contact with metallic objects such as necklaces or hairpins.

- Failure to observe this may cause the batteries to leak, overheat, explode or catch fire.
- Store the batteries in a plastic bag and keep them away from metallic objects.

During a thunderstorm, do not touch the projector or the cable.

- Electric shocks can result.

Do not use the projector in a bath or shower.

- Fire or electric shocks can result.

Do not look into the lens while the projector is being used.

- Strong light is emitted from the projector's lens. If you look directly into this light, it can hurt and damage your eyes.
- Be especially careful not to let young children look into the lens. In addition, turn off the power when you are away from the projector.

Do not place your hands or other objects close to the air outlet port.

- Heated air comes out of the air outlet port. Do not place your hands or face, or objects which cannot withstand heat close to this port, otherwise burns or damage could result.

Replacement of the lamp unit should only be carried out by a qualified technician.

- The lamp unit has high internal pressure. If improperly handled, explosion might result.
- The lamp unit can easily become damaged if struck against hard objects or dropped, and injury or malfunctions may result.

When replacing the lamp, allow it to cool for at least one hour before handling it.

- The lamp cover gets very hot, and contact with it can cause burns.

Before replacing the lamp, be sure to unplug the power cord from the power outlet.

- Electric shocks or explosions can result if this is not done.

Caution

Do not cover the air inlet or the air outlet.

- Doing so may cause the projector to overheat, which can cause fire or damage to the projector.
- Do not place the projector in narrow, badly ventilated places such as closets or bookshelves.
- Do not place the projector on cloth or papers, as these materials could be drawn into the air inlet port.

Do not set up the projector in humid or dusty places or in places where the projector may come into contact with smoke or steam.

- Using the projector under such conditions may result in fire or electric shocks.

When disconnecting the power cord, hold the plug, not the cord.

- If the power cord itself is pulled, the cord will become damaged, and fire, short-circuits or serious electric shocks may result.

Always disconnect all cables before moving the projector.

- Moving the projector with cables still attached can damage the cables, which could cause fire or electric shocks to occur.

Do not place any heavy objects on top of the projector.

- Failure to observe this may cause the projector to become unbalanced and fall, which could result in damage or injury.

Do not short-circuit, heat or disassemble the batteries or place them into water or fire.

- Failure to observe this may cause the batteries to overheat, leak, explode or catch fire, and burns or other injury may result.

When inserting the batteries, make sure the polarities (+ and -) are correct.

- If the batteries are inserted incorrectly, they may explode or leak, and fire, injury or contamination of the battery compartment and surrounding area may result.

Use only the specified batteries.

- If incorrect batteries are used, they may explode or leak, and fire, injury or contamination of the battery compartment and surrounding area may result.

Insulate the battery using tape or similar before disposal.

- If the battery comes into contact with metallic objects or other batteries, it may catch fire or explode.

Do not put your weight on this projector.

- You could fall or the projector could break, and injury may result.
- Be especially careful not to let young children climb onto the projector.

Disconnect the power cord plug from the wall outlet as a safety precaution before carrying out any cleaning.

- Electric shocks can result if this is not done.

Ask an Authorised Service Center to clean inside the projector at least once a year.



- If dust is left to build up inside the projector without being cleaned out, it can result in fire or problems with operation.
- It is a good idea to clean the inside of the projector before the season for humid weather arrives. Ask your nearest Authorised Service Center to clean the projector when required. Please discuss with the Authorised Service Center regarding cleaning costs.

We are constantly making efforts to preserve and maintain a clean environment. Please take non repairable units back to your dealer or a recycling company.**NOTICE:**

- This product has a High Intensity Discharge (HID) lamp that contains a small amount of mercury. It also contains lead in some components. Disposal of these materials may be regulated in your community due to environmental considerations. For disposal or recycling information please contact your local authorities, or the Electronics Industries Alliance: <<http://www.eiae.org>>

Accessories

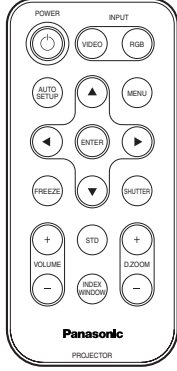
Check that all of the accessories shown below have been included with your projector.

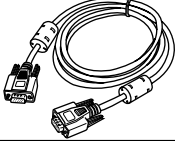
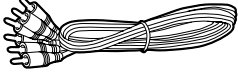
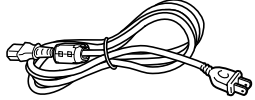
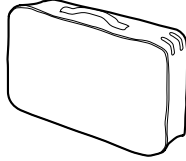
<p>Card remote control unit (TNQE239 x1)</p> 	<p>Lithium battery for remote control unit (CR2025 x1)</p> 	<p>RGB signal cable [3.0 m (9'10"), K1HA15FA0002 x1]</p> 
	<p>Video/Audio cable [3.0 m (9'10"), K2KA2FA00002 x 1]</p> 	<p>Power cord (TXFSX01PSZZ x 1)</p> 
<p>Carrying bag (TPEP009 x1)</p> 		

Before use

Cautions when moving the projector

Be sure to attach the lens cover before moving the projector.

The projection lens is extremely susceptible to vibration and shocks. When moving the projector, use the accessory carrying bag. When placing the projector inside the carrying bag, position it so that the lens is facing upward.

Cautions regarding setting-up

Avoid setting up in places which are subject to vibration or shocks.

The internal parts can be damaged, which may cause malfunctions or accidents.

Do not set up the projector near high-voltage power lines or near motors.

The projector may be subject to electromagnetic interference.

If installing the projector to the ceiling, ask a qualified technician to carry out all installation work.

You will need to purchase the separate installation kit (Model No.ET-PKC80). Furthermore, all installation work should only be carried out by a qualified technician.

If using this projector at high elevations (above 1400 m), set the FAN CONTROL to HIGH. (Refer to page 43.)

Failure to observe this may result in malfunctions.

Notes on use

In order to get the best picture quality

Draw curtains or blinds over any windows and turn off any fluorescent lights near the screen to prevent outside light or light from indoor lamps from shining onto the screen.

Do not touch the surfaces of the lens with your bare hands.

If the surface of the lens becomes dirty from fingerprints or anything else, this will be magnified and projected onto the screen. Moreover, when not using the projector, retract the lens and then cover it with the accessory lens cover.

About the screen

Do not apply any volatile substances which may cause discolouration to the screen, and do not let it become dirty or damaged.

About the lamp

The lamp may need to be replaced earlier due to variables such as individual lamp characteristics, usage conditions and the installation environment, especially when the projector is subjected to continuous use for more than 10 hours or the power is frequently turned on and off.

Location and function of each part

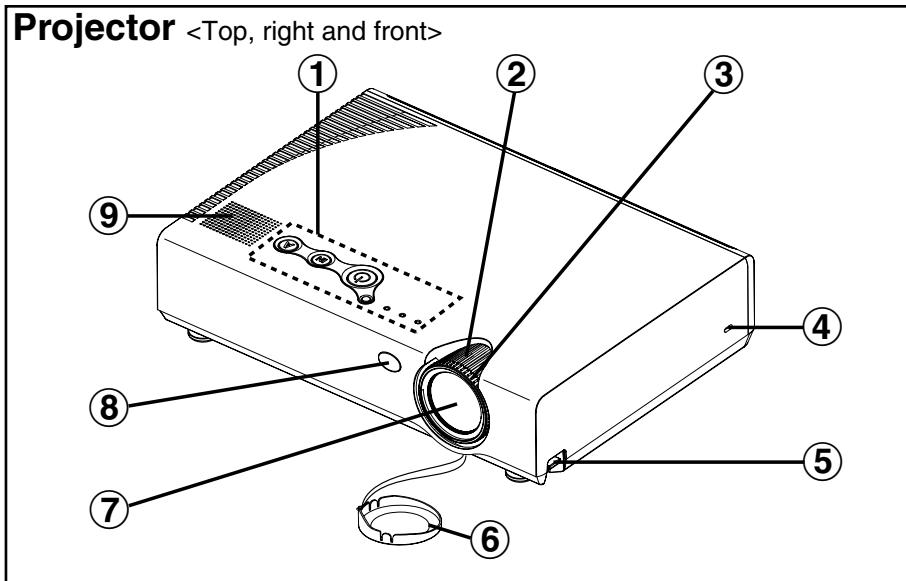

① Projector control panel(Top)

(page 14)

② Zoom ring

(page 23)

③ Focus ring

(page 23)

④ Security lock

This can be used to connect a commercially-available theft-prevention cable (manufactured by Kensington). This security lock is compatible with the Microsaver Security System from Kensington. Contact details for this company are given below.

Kensington Technology Group
ACCO Brands Inc.
2855 Campus Drive
San Mateo, CA 94403 USA
Tel (650)572-2700
Fax (650)572-9675
<http://www.kensington.com/>

<http://www.gravis.com/>

NOTE:

- Information given above may be changed in future.

⑤ Leg adjuster buttons(L/R)

(page 23)

These buttons are used to unlock the front adjustable legs. Press to adjust the angle of tilt of the projector.

⑥ Lens cover

⑦ Projection lens

⑧ Remote control signal receptor

(page 21)

⑨ Speaker

Projector <Back and bottom>

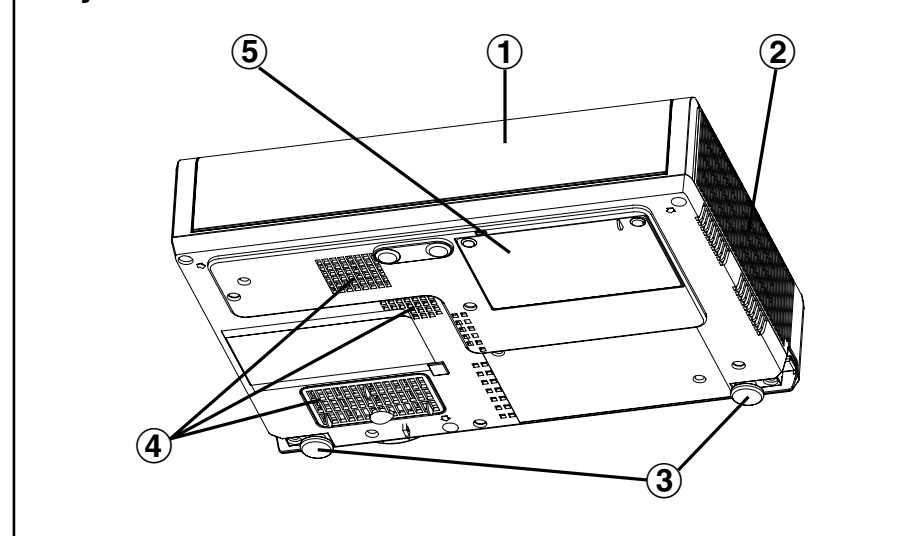

① Connector panel cover

(page 16)

② Air outlet port

Do not cover this port.

③ Front adjustable legs(L/R)

(page 23)

④ Air inlet ports, Air filter

Do not cover these ports.

⑤ Lamp unit holder

(page 50)

WARNING

Do not place your hands or other objects close to the air outlet port.

- Heated air comes out of the air outlet port. Do not place your hands or face, or objects which cannot withstand heat close to this port, otherwise burns or damage could result.

NOTE:

- During projection of an image, the cooling fan will operate, emitting a small noise as it operates. Turning the lamp on or off will cause this noise to increase a little.
- By using the OPTION2 menu to set "LAMP POWER" to "LOW", the operating sound of the fan can be reduced. (Refer to page 43.)

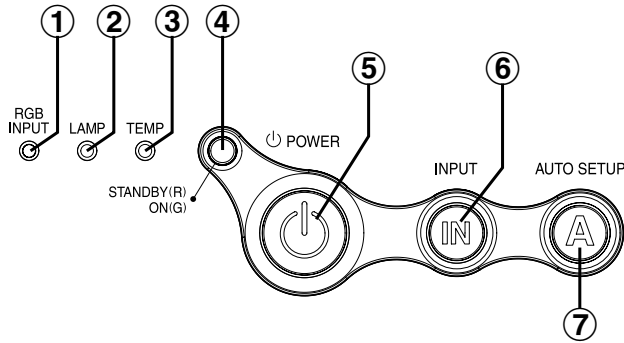
Projector control panel <Top>**Menu operation**

<on connector panel:page 16>

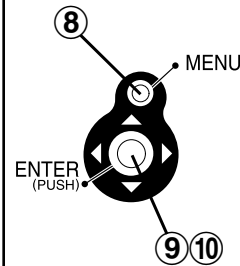
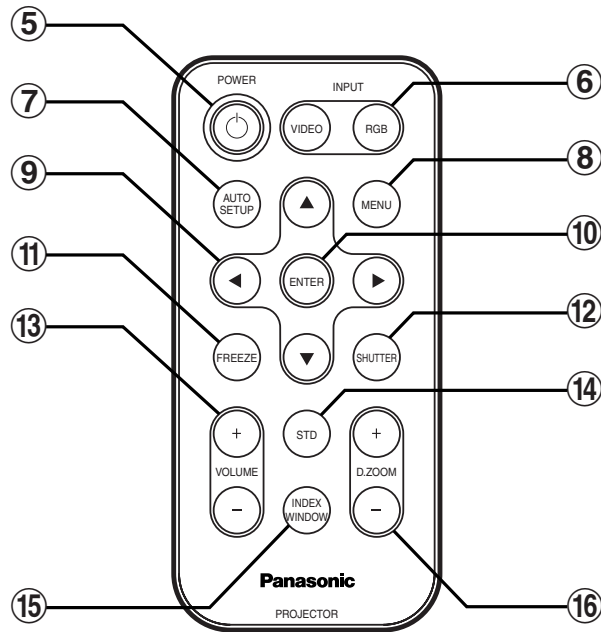
**Remote control unit****① RGB INPUT indicator**
(page 25)

This indicator shows whether a signal is being input to the RGB input connectors (RGB 1 IN/RGB 2 IN). When an input signal is detected, the indicator illuminates.

② LAMP indicator
(page 48)

This indicator illuminates when it is time to replace the lamp unit. It flashes if a circuit abnormality is detected.

③ TEMP indicator
(page 47)

This indicator illuminates if an abnormally high temperature is detected inside the projector or around it. If the temperature rises above a certain level, the power supply will be turned off automatically and the indicator will illuminate or flash.

④ Power indicator
(page 25)

This indicator illuminates red when the MAIN POWER switch is turned on (standby mode), and illuminates green when the power is turned on and a picture starts to be projected.

⑤ POWER button
(pages 22 and 24)**⑥ Input select (INPUT, VIDEO, RGB) buttons**
(page 23)**⑦ AUTO SETUP button**
(pages 23 and 26)

If this button is pressed while a picture is being projected, the projection settings will be adjusted automatically in accordance with the signal being input. In addition, the angle of tilt of the projector will be automatically detected and adjusted in order to correct any keystone distortion.

⑧ MENU button
(pages 30 and 32)

This button is used to display the menu screens. When a menu screen is being displayed, this button can be used to return to a previous screen or to clear the screen.

⑨ Arrow (▲▼◀ and ▶) buttons
(page 32)

These buttons are used to select and adjust items in the menu screens.

⑩ ENTER button
(page 32)

This button is used to accept and to activate items selected in the on-screen menus.

⑪ FREEZE button
(page 27)

This button is used to momentarily freeze projection so that a still picture is displayed.

⑫ SHUTTER button
(page 27)

This button is used to momentarily turn off the picture and sound.

⑬ VOLUME +/- buttons
(page 28)

These buttons are used to adjust the volume of the sound output from the projector's built-in speaker. Refer to page 31 for details on how to adjust the volume using the buttons on the projector control panel.

⑭ STD (standard) button
(page 33)

This button is used to reset the projector adjustment values to the factory default settings.

⑮ INDEX WINDOW button
(page 29)

This button can be used to split the image projection area into a still image and a moving image.

⑯ D.ZOOM +/- buttons
(page 28)

These buttons are used to enlarge the projected image.

Connector panel

How to open

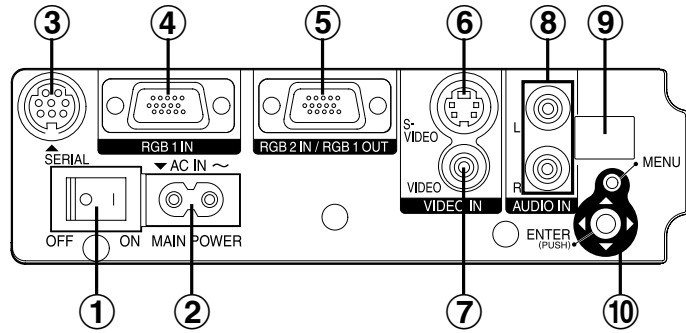
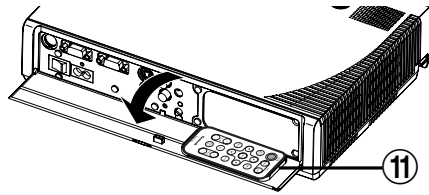

① **MAIN POWER switch**
(pages 22 and 24)

② **Power input socket (AC IN)**
(page 22)

The accessory power cord is connected here.
Do not use any power cord other than the accessory power cord.

③ **SERIAL connector**
(pages 19, 20 and 60)

This connector is used to connect a personal computer to the projector in order to externally control the projector. (RS-232C compatible)

④ **RGB1 IN connector**
(pages 19 and 20)

This connector is used to input RGB signals and YPBPr signals.

⑤ **RGB2 IN/RGB1 OUT connector**
(pages 19, 20 and 42)

This connector is used to input or output RGB signals and YPBPr signals. Use the RGB2 SELECT item in the OPTION1 menu to select whether you want input or output with this connector.

⑥ **S-VIDEO IN connector**
(pages 19 and 39)

This connector is used to input signals from a S-VIDEO-compatible equipment such as a video deck. The connector is S1 signal compatible, and it automatically switches between 16:9 and 4:3 aspect ratios in accordance with the type of signal being input.

⑦ **VIDEO IN jack**
(page 19)

This jack is used to input video signals from a video equipment such as a video deck.

⑧ **AUDIO IN L-R jacks**
(pages 19 and 20)

⑨ **Remote control signal receptor**
(page 21)

⑩ **Menu operation (on connector panel)**
(page 14)

⑪ **Remote control unit holder**
Store the remote control unit as shown in the figure above.

Setting-up

Projection methods

In way of installing projector, any one of the following four projection methods are used. Select whichever projection method matches the setting-up method. (The projection method can be set from the OPTION2 menu. Refer to page 43 for details.)

● Front-desk projection

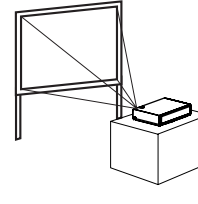

Menu items	Setting
FRONT/REAR	FRONT
DESK/CEILING	DESK

● Front-ceiling projection

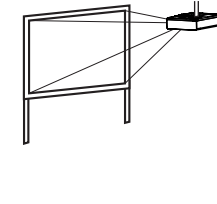

Menu items	Setting
FRONT/REAR	FRONT
DESK/CEILING	CEILING

● Rear-desk projection
(Using a translucent screen)

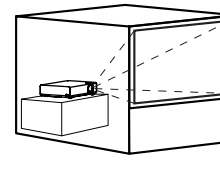

Menu items	Setting
FRONT/REAR	REAR
DESK/CEILING	DESK

● Rear-ceiling projection
(Using a translucent screen)

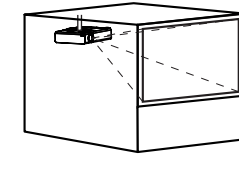

Menu items	Setting
FRONT/REAR	REAR
DESK/CEILING	CEILING

NOTE:

- You will need to purchase the separate ceiling bracket (ET-PKC80) when using the ceiling installation method.
- If you set up the projector vertically, it may cause to damage the projector.
- It is recommended that you set up the projector in a place that is tilted at less than $\pm 30^\circ$. Setting up the projector in places that are tilted at more than $\pm 30^\circ$ may cause malfunctions.

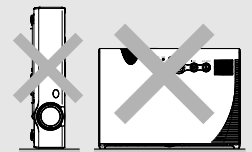

Projector position

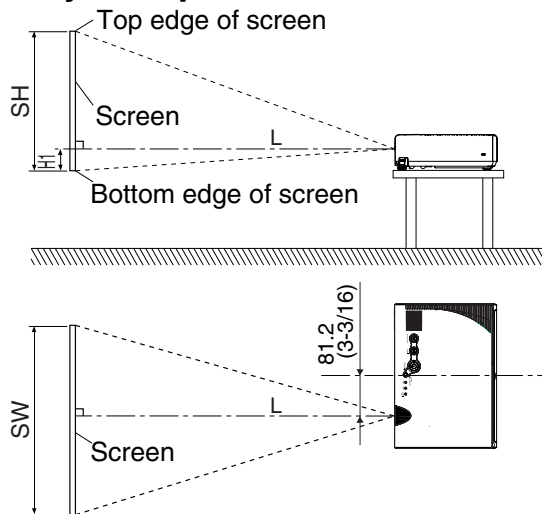

<Units: mm (inch)>

- L: Projection distance
- SH: Image height
- SW: Image width
- H1: Distance from center of lens to bottom edge of projected image

Projection distances

4:3 Screen size (diagonal)	Projection distance (L)				Height position (H1)
	PT-LC80U		PT-LC76U/PT-LC56U		
	Wide (LW)	Telephoto (LT)	Wide (LW)	Telephoto (LT)	
0.84 m(33")		1.1 m(3'7")		1.1 m(3'7")	0.08 m(3-1/8")
1.02 m(40")	1.2 m(3'11")	1.4 m(4'7")	1.2 m(3'11")	1.4 m(4'7")	0.09 m(3-17/32")
1.27 m(50")	1.5 m(4'11")	1.7 m(5'6")	1.5 m(4'11")	1.8 m(5'10")	0.11 m(4-5/16")
1.52 m(60")	1.8 m(5'10")	2.1 m(6'10")	1.8 m(5'10")	2.1 m(6'10")	0.14 m(5-1/2")
1.78 m(70")	2.1 m(6'10")	2.4 m(7'10")	2.1 m(6'10")	2.5 m(8'2")	0.16 m(6-9/32")
2.03 m(80")	2.4 m(7'10")	2.8 m(9'2")	2.4 m(7'10")	2.9 m(9'6")	0.18 m(7-1/16")
2.29 m(90")	2.7 m(8'10")	3.2 m(10'5")	2.8 m(9'2")	3.2 m(10'5")	0.20 m(7-27/32")
2.54 m(100")	3.0 m(9'10")	3.5 m(11'5")	3.0 m(9'10")	3.6 m(11'9")	0.22 m(8-21/32")
3.05 m(120")	3.6 m(11'9")	4.2 m(13'9")	3.7 m(12'1")	4.3 m(14'1")	0.26 m(10-7/32")
3.81 m(150")	4.5 m(14'9")	5.3 m(17'4")	4.6 m(15'1")	5.4 m(17'8")	0.33 m(12-31/32")
5.08 m(200")	6.0 m(19'8")	7.1 m(23'3")	6.1 m(20")	7.3 m(23'11")	0.44 m(17-5/16")
6.35 m(250")	7.5 m(24'7")	8.9 m(29'2")	7.6 m(24'11")	9.1 m(29'10")	0.55 m(21-5/8")
7.62 m(300")	9.0 m(29'6")	10.7 m(35'1")	9.2 m(30'2")	11.0 m(36'1")	0.66 m(25-31/32")

NOTE:

- The dimensions in the table above are approximate.
- If you use the projection distance for the 16:9 screen, the 4:3 projection image overflows the screen at the top and bottom.
- For details about projected image distances, refer to page 59.

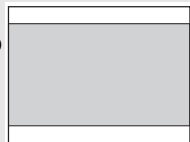

Connections

Notes on connections

- Read the instruction manual for each system component carefully before connecting it.
- Turn off the power supply for all components before making any connections.
- If the cables necessary for connecting a component to the system are not included with the component or available as an option, you may need to fashion a cable to suit the component concerned.
- If there is a lot of jitter in the video signal which is input from the video source, the picture on the screen may flicker. In such cases, it will be necessary to connect a TBC (time base corrector).
- Refer to the list on page 58 for details on compatible signals which can be input to the projector.
- Only one audio system circuit is available for the AUDIO IN L-R jacks, so if you wish to change the audio input source, you will need to remove and insert the appropriate plugs.

Example of connecting to video equipments

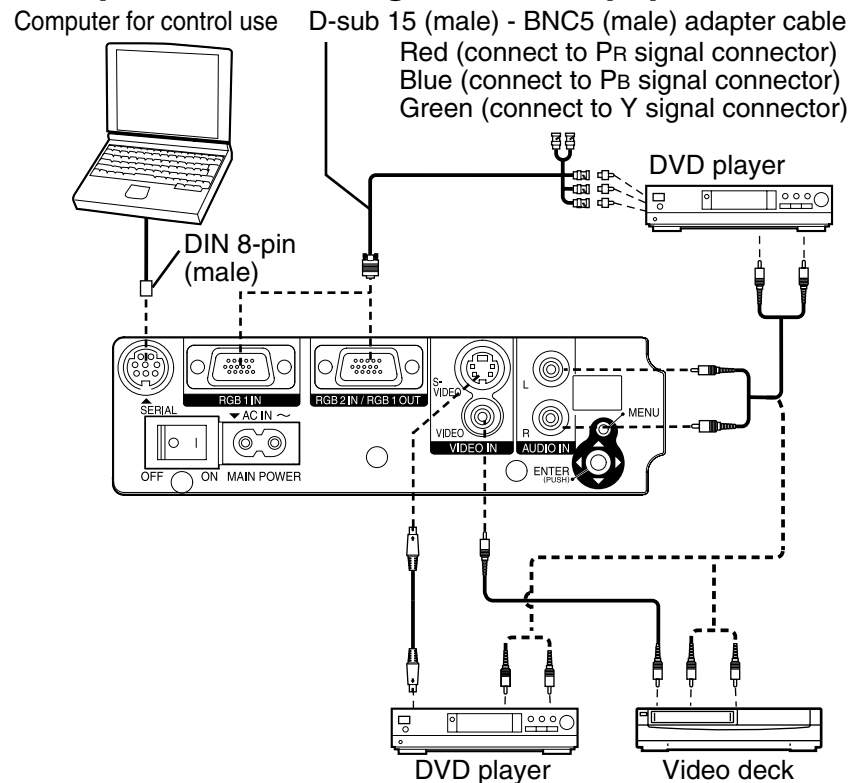

NOTE:

- If the video signal source is connected using a cable with a BNC connector plug, use a BNC/RCA adapter (sold separately) to convert the cable end to an RCA plug-type jack.
- If the signal cables are disconnected or if the power supply for the computer or video deck is turned off while the digital zoom or index window functions are being used, these functions will be cancelled.

Example of connecting to computer

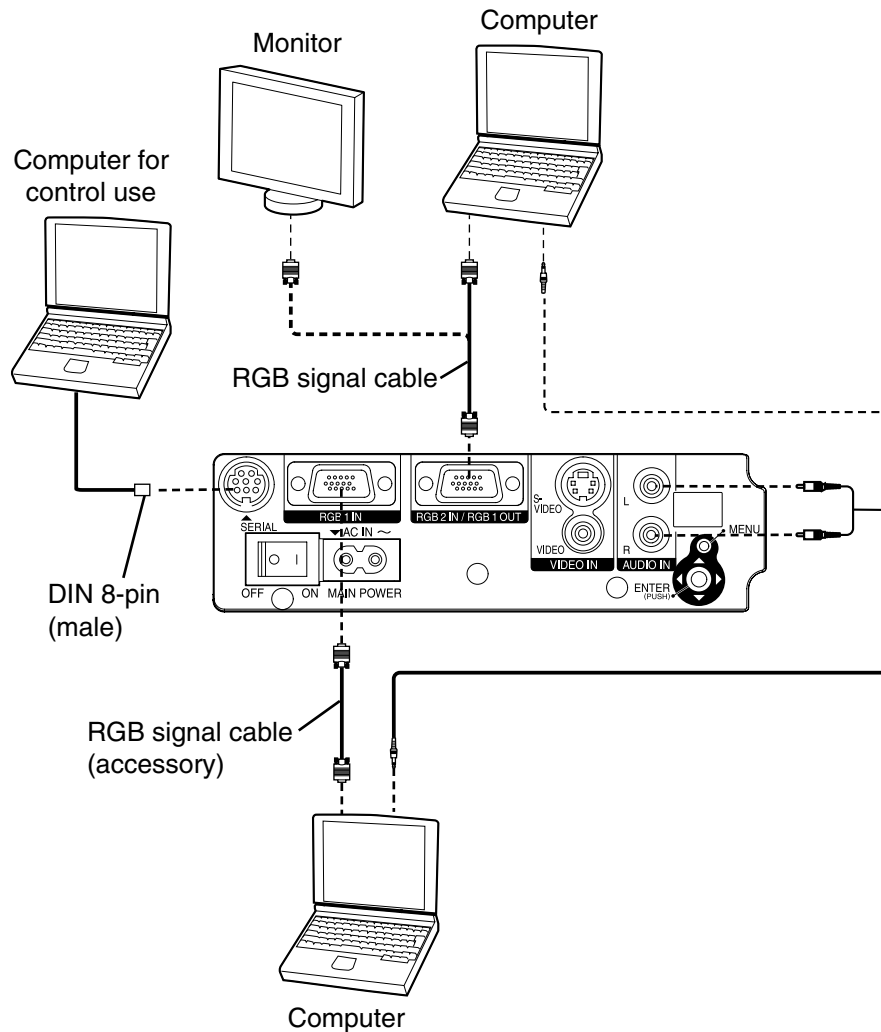

NOTE:

- It is better to shut down the computer before turning off the MAIN POWER switch of the projector.
- Do not input the signal to the RGB2 IN/RGB1 OUT connector when the RGB2 SELECT item in the OPTION1 menu is set to OUTPUT. (Refer to page 42.)

Preparation for the remote control unit

Insert the lithium battery which is supplied with the remote control unit, making sure that the polarities are correct.

- ① While pushing the battery holder tab to the right, pull out the battery holder.

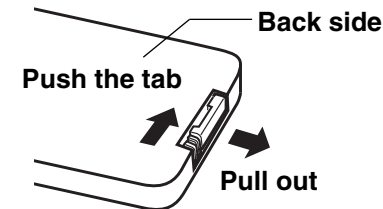

- ② Insert the battery into the battery holder so that the + side is facing upward.

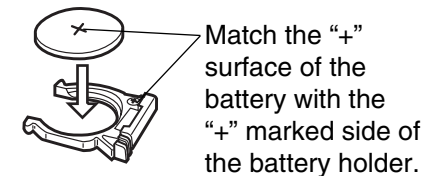

- ③ Insert the battery holder.

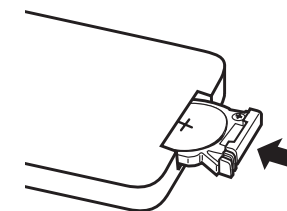

NOTE:

- Do not drop the remote control unit.
- Keep the remote control unit away from liquids.
- Remove the battery if not using the remote control unit for long periods.
- Use only CR2025 batteries as replacement batteries.

NOTE:

- If the remote control unit is held so that it is facing directly in front of the front or rear remote control signal receptors, the operating range is within approximately 7 m (23') from the surfaces of the receptors. Furthermore, the remote control unit can be operated from an angle of $\pm 30^\circ$ to the left or right and $\pm 15^\circ$ above or below the receptors.
- If there are any obstacles in between the remote control unit and the receptors, the remote control unit may not operate correctly.
- If strong light is allowed to shine onto the remote control signal receptor, correct projector operation may not be possible. Place the projector as far away from light sources as possible.
- If facing the remote control unit toward the screen to operate the projector, the operating range of the remote control unit will be limited by the amount of light reflection loss caused by the characteristics of the screen used.

Turning on the power

Before turning on the power

- 1, Ensure that all components are connected properly.
- 2, Connect the accessory power cord.
- 3, Remove the lens cover.

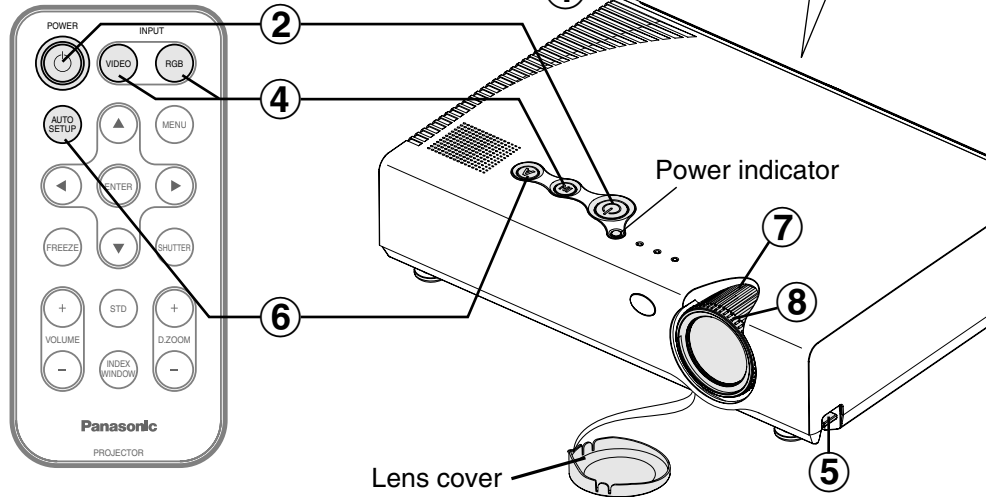
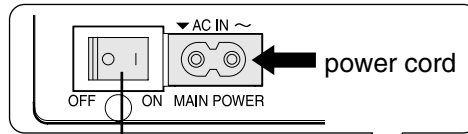

1 Press the MAIN POWER switch to turn on the power.

- The power indicator on the projector will illuminate red.

2 Press the POWER button.

- The power indicator on the projector will flash green. After a short period, the indicator will illuminate green, and a picture will be projected.

3 Turn on the power of all connected devices.

- Start the Play function of a device such as a DVD player.

NOTE:

- A tinkling sound may be heard while the power indicator is turned off, but this is not a sign of a malfunction.

4 Press the input select button to select the input signal.

Input select buttons	IN	VIDEO	RGB
Changing signals	<div style="display: flex; justify-content: space-around;"> <div style="border: 1px solid black; padding: 2px;">RGB 1</div> <div style="font-size: 1em;">→</div> <div style="border: 1px solid black; padding: 2px;">RGB 2</div> </div> <div style="display: flex; justify-content: space-around; margin-top: 5px;"> <div style="border: 1px solid black; padding: 2px;">S-VIDEO</div> <div style="font-size: 1em;">←</div> <div style="border: 1px solid black; padding: 2px;">VIDEO</div> </div>	<div style="border: 1px solid black; padding: 2px; text-align: center;">VIDEO</div> <div style="font-size: 1.5em; margin: 2px 0;">↕</div> <div style="border: 1px solid black; padding: 2px; text-align: center;">S-VIDEO</div>	<div style="border: 1px solid black; padding: 2px; text-align: center;">RGB 1</div> <div style="font-size: 1.5em; margin: 2px 0;">↕</div> <div style="border: 1px solid black; padding: 2px; text-align: center;">RGB 2</div>

- A picture will be projected in accordance with the selected input signal.

Follow the procedure below when you set the projector up first, and when you change the setup place.

5 Adjusting the angle

- While pressing the adjuster buttons, adjust the forward/back angle of tilt of the projector. Adjust so that the projector is as vertical to the screen as possible.

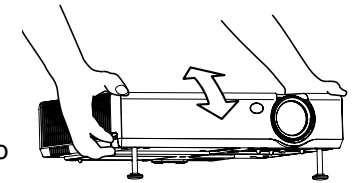

6 Press the AUTO SETUP button to initiate automatic positioning.

- The tilt of the projector and the input signal will be detected and keystone distortion and the position of the image will be corrected. (Refer to page 26 for details.)

AUTO SETUP

7 Adjusting the size

- Turn the zoom ring to adjust the size of the projected image.

8 Adjusting the focus

- Turn the focus ring to adjust the focus of the projected image.

Turning off the power

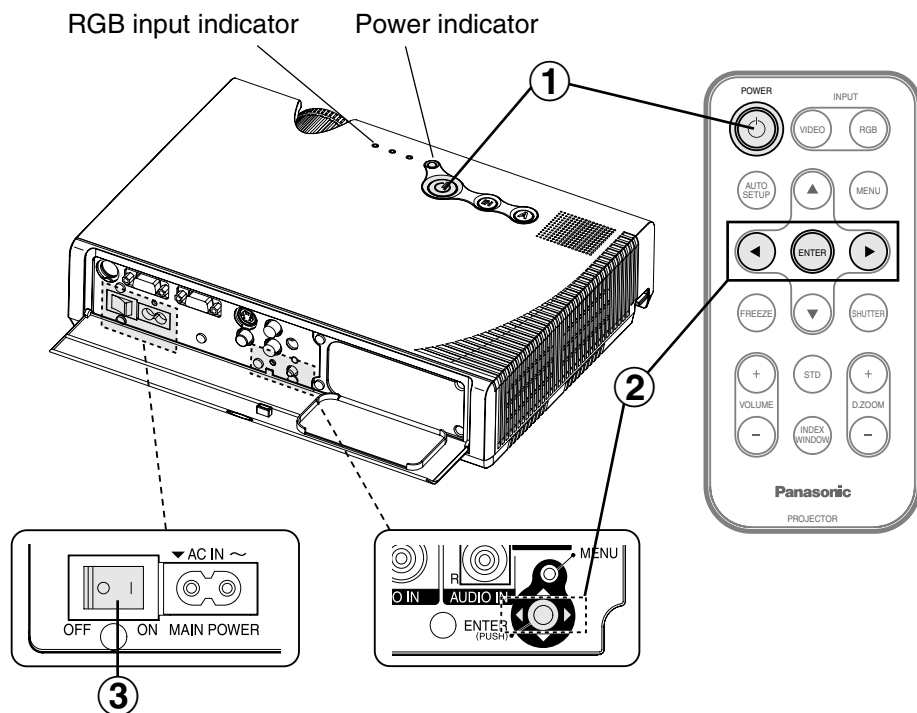

1 Press the POWER button.

- "POWER OFF" is displayed on the screen.



2 Select "OK" using the ◀ and ▶ buttons and then press the ENTER button.

- The lamp unit will switch off and the picture will stop being projected. (The power indicator on the projector will illuminate orange.)

3 Press the MAIN POWER switch to turn off the power after the power indicator on the projector illuminates red.

- Do not cut power to the projector in any way while the cooling fan is still operating. Be careful not to switch off the MAIN POWER switch of the projector or unplug the power cord from the electrical outlet.

NOTE:

- You can also turn off the power by pressing the POWER button twice or by holding down it for at least 0.5 seconds.
- When the projector is in standby mode (the power indicator on the projector is illuminated red), the projector will still draw a maximum 3 W of power, even when the cooling fan has stopped.

Power indicator

Power indicator status		Projector status
Red	Illuminated	The projector is in standby mode and image projection is possible by pressing the POWER button.
Green	Flashing	The projector is preparing for projection after the power is turned on while the power indicator is illuminated red. (After a short period, a picture will be projected.)
	Illuminated	A picture is being projected.
Orange	Illuminated	The lamp is cooling down after the power is turned off. (The cooling fan is operating.)
	Flashing	The projector is preparing for projection after the power is turned on while the power indicator is illuminated orange. (After a short period, a picture will be projected.)

RGB INPUT indicator

RGB INPUT indicator status	Projector status
Illuminated during standby mode	A signal is being input to either the RGB1 IN or RGB2 IN connector.
Illuminated during projection	A signal is being input to the connector selected using the input select buttons.

Correcting keystone distortion and automatic positioning (AUTO SET UP)

This projector detects its degree of tilt and the input signal. Keystone distortion and the position of the image can then be corrected automatically in accordance with the input signal.

Press the AUTO SETUP button.

(When the projected image has caused keystone distortion)



Projector control panel

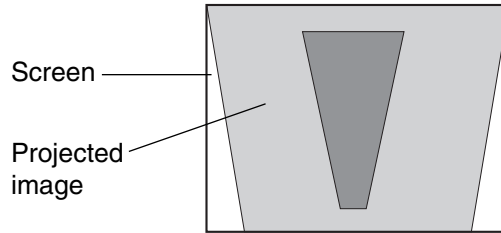
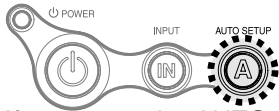

- Automatic positioning will be carried out.

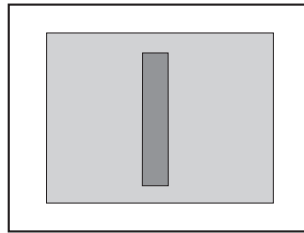

If you press the AUTO SETUP button, the items given in the table below will be set automatically in addition to keystone distortion being corrected. The setting details change according to the signal which is being input.

Input signal	Contents set up automatically	Page
RGB signals	POSITION, DOT CLOCK, CLOCK PHASE (If the dot clock frequency is 100 MHz or higher, the DOT CLOCK and CLOCK PHASE will not be set automatically.)	38
	AUTO RGB IN	42
YPbPr signals	AUTO RGB IN	42

NOTE:

- If the edges of the projected picture are indistinct, or if a dark picture is being projected, the automatic setup processing may stop automatically before it is complete. If this happens, project a different picture and then press the AUTO SETUP button once more, or make the above adjustments manually.
- If you would like to make further adjustments to the picture, use the menu commands which are listed on page 30 and subsequent pages.
- Set "AUTO KEYSTN" in the OPTION1 menu to "OFF" to prevent any deterioration of the picture as a result of keystone correction. (Refer to page 42.)

Turning off the picture and sound momentarily (SHUTTER)

The shutter function can be used to momentarily turn off the picture and sound from the projector when the projector is not being used for short periods of time, such as during breaks in meetings or when carrying out preparation. The projector uses less power in shutter mode than it does in normal projection mode.

Press the SHUTTER button.

- The picture and sound will be turned off.
- Press any button on either the projector or remote control unit to return to normal operating mode.

NOTE:

- "SHUTTER" on the MAIN MENU is the same function.



Pausing a picture (FREEZE)

Press the FREEZE button.

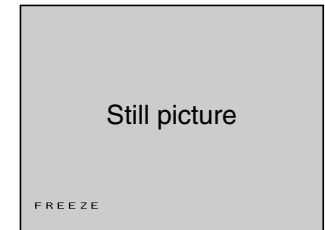
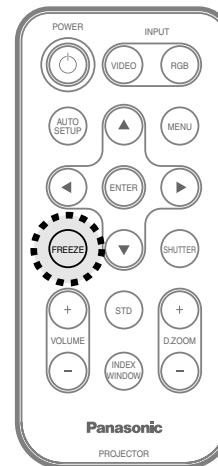

- The picture being projected will be paused.
- Press the FREEZE button again to cancel the still picture.

Enlarging the picture (D.ZOOM)



Press a D.ZOOM +/- button.

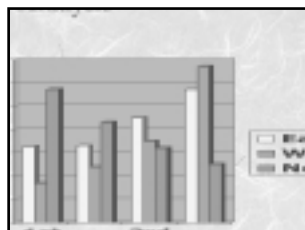
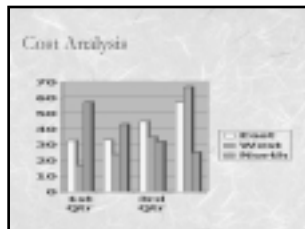

- The picture will then be enlarged to 1.5 times the normal size.

The remote control unit functions during D.ZOOM (digital zoom)

Use the ▲, ▼, ◀ and ▶ buttons to move the enlarged area which you want to project.

Use the D.ZOOM +/- buttons to change the enlargement ratio.

Press the MENU button to return to the normal screen.

NOTE:

- The enlargement ratio can be changed within the range of x1 to x2, in steps of 0.1. When RGB signals are being input, the enlargement ratio can be changed within the range of x1 to x3, except when the FRAME LOCK is set to "ON".
- If the type of signal being input changes while the digital zoom function is being used, the digital zoom function will be cancelled.

Adjusting the volume (VOLUME)

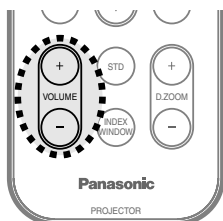

Press the VOLUME +/- button.

- Press the + button to raise the volume.
- Press the - button to lower the volume.

NOTE:

- You can also select "VOLUME" from the MAIN MENU to adjust the volume.

Displaying two screens (INDEX WINDOW)

This function lets you store a picture which is being projected into memory, so that you can display a still picture and a moving picture on the screen.



Press the INDEX WINDOW button.

- The aspect ratio of the screen changes and the image is vertically elongated in comparison to a normal image.

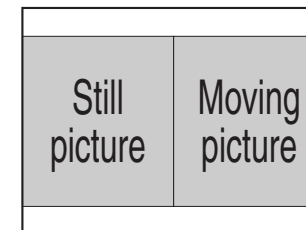

The remote control unit functions during INDEX WINDOW

Use the ▲ and ▼ buttons to select a screen size.

It can switch to three stages.

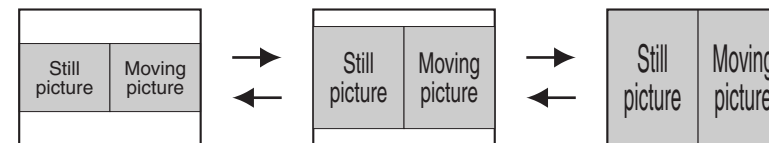

Use the ◀ and ▶ buttons to switch between the still picture screen and moving picture screen.

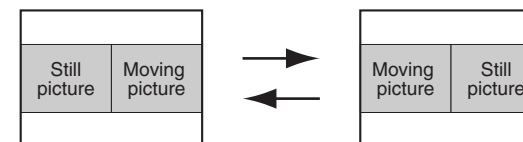

Press the ENTER button to capture the present moving picture in a still window.

Press the MENU button to return to the previous screen.

NOTE:

- When the screen size is changed, the picture's aspect ratio will also change. Make sure that you fully understand the notes on ASPECT which are given on page 40 before using the index window function.
- "INDEX WINDOW" on the MAIN MENU is the same function.

On-screen menus

Menu screens

The various settings and adjustments for this projector can be carried out by selecting the operations from on-screen menus.

The general arrangement of these menus is shown below.

MAIN MENU

MENU	
⏏	KEYSTONE
🖼️	PICTURE
📏	POSITION
🪞	INDEX WINDOW
🔇	SHUTTER
🔊	VOLUME
🌐	LANGUAGE
🔒	OPTION1
🔒	OPTION2
🔒	SECURITY
⏏	SELECT ENTER ENTER MENU EXIT

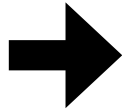

🖼️ PICTURE menu (page 35)

When an RGB signal is being input

PICTURE	
PICTURE MODE (STANDARD)	
CONTRAST	32
BRIGHT	32
SHARPNESS	0
COLOR TEMP.	(STANDARD)
W-BAL R	32
W-BAL G	32
W-BAL B	32
SIGNAL MODE	XGA
STANDARD	
⏏ SELECT ↔ ADJ MENU RETRN	

When a YPbPr signal is being input

PICTURE	
PICTURE MODE (STANDARD)	
CONTRAST	32
BRIGHT	32
COLOR	32
TINT	32
SHARPNESS	2
COLOR TEMP.	(STANDARD)
SIGNAL MODE	525P
STANDARD	
⏏ SELECT ↔ ADJ MENU RETRN	

When an S-VIDEO/VIDEO signal is being input

PICTURE	
PICTURE MODE (STANDARD)	
CONTRAST	32
BRIGHT	32
COLOR	32
TINT	32
SHARPNESS	8
COLOR TEMP.	(STANDARD)
TV-SYSTEM	(AUTO1)
STILL MODE	(OFF)
STANDARD	
⏏ SELECT ↔ ADJ MENU RETRN	

📏 POSITION menu (page 38)

When an RGB/YPbPr signal is being input

POSITION	
POSITION	
DOT CLOCK	32
CLOCK PHASE	16
ASPECT	(4:3)
RESIZING	(ON)
FRAME LOCK	(OFF)
STANDARD	
⏏ SELECT ENTER ENTER MENU RETRN	

When an S-VIDEO/VIDEO signal is being input

POSITION	
POSITION	
ASPECT	(4:3)
RESIZING	(ON)
STANDARD	
⏏ SELECT ENTER ENTER MENU RETRN	

🪞 INDEX WINDOW function (page 29)

🔇 SHUTTER function (page 27)

🔊 Volume adjustment

Press the ENTER button, and then press the ◀ and ▶ buttons to adjust the volume.

🌐 LANGUAGE menu (page 41)

LANGUAGE	
ENGLISH	
ENGLISH	
DEUTSCH	
FRANÇAIS	
ESPAÑOL	
ITALIANO	
日本語	
中文	
⏏ SELECT ENTER ENTER MENU RETRN	

🔒 OPTION1 menu (page 42)

OPTION1	
OSD	(ON)
AUTO SIGNAL	(ON)
AUTO KEYSTN	(ON)
AUTO RGB IN	(ON)
RGB2 SELECT	(INPUT)
RGB/YPbPr	(AUTO)
VGA60/525P	(525P)
SXGA MODE	(SXGA)
BLACKBOARD	(OFF)
⏏ SELECT ↔ ADJ MENU RETRN	

- BLACKBOARD is for the PT-LC80U only.

🔒 OPTION2 menu (page 42)

OPTION2	
BACK COLOR (BLUE)	
FRONT/REAR	(FRONT)
DESK/CEILING	(DESK)
FAN CONTROL	(STANDARD)
LAMP POWER	(HIGH)
LAMP RUNTIME	(100H)
FUNC 1	(INDEX)
CONTROL KEY	(ON)
AUTO POW. OFF	(DISABLE)
⏏ SELECT ↔ ADJ MENU RETRN	

🔒 SECURITY menu (page 45)

SECURITY	
INPUT PASSWD (OFF)	
AMEND PASSWD	
TEXT DISPLAY	(ON)
TEXT CHANGE	
⏏ SELECT ↔ ADJ MENU RETRN	

⏏ Keystone correction

(page 34)

For PT-LC76U/PT-LC56U

KEYSTONE	0
----------	---

For PT-LC80U

KEYSTONE	H 0
	V 0

- Keystone distortion of the on-screen display will not be corrected.

Menu operation guide



Menu operation (on connector panel)

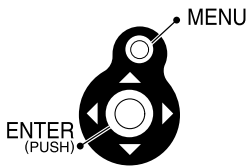

① Press the MENU button.

The MAIN MENU screen will be displayed.

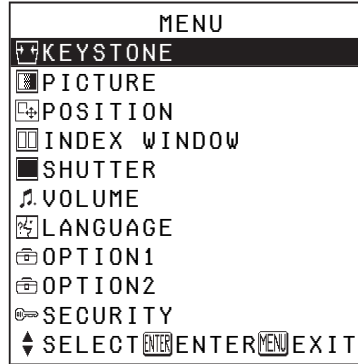

② Press the ▲ or ▼ arrow buttons to select an item.

Selected items will be displayed in blue.

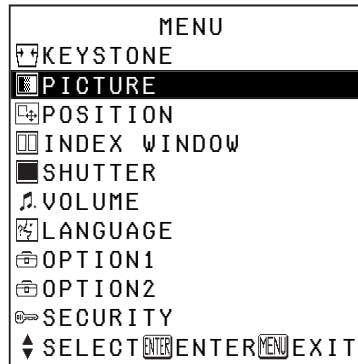

③ Press the ENTER button to accept the selection.

The selected menu screen or adjustment screen will then be displayed. (Example: PICTURE menu)

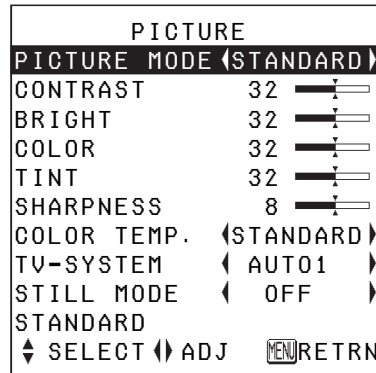

NOTE:

- If you press the MENU button while a menu screen is being displayed, the display will return to the previous screen.

④ Press the ▲ or ▼ buttons to select an item, and then press the ◀ or ▶ buttons to change or adjust the setting.

An individual adjustment screen such as the one shown below will be displayed for bar-scale items.



The bar scale will turn green when any adjustment changes the setting from the factory set value.

Returning a setting to the factory default

If you press the STD (standard) button on the remote control unit, you can return settings to the factory default settings. However, the operation of this function varies depending on which screen is being displayed.

- When a menu screen is being displayed

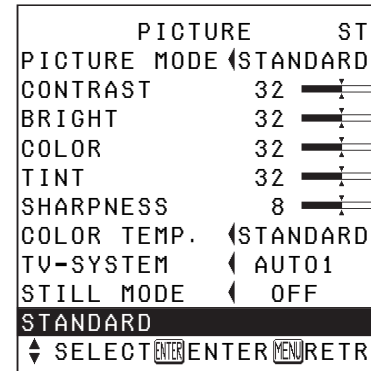

All items displayed will be returned to their factory default settings, "STD" will be displayed in the top-right screen and the bar scale will appear white.

NOTE:

- You can also select STANDARD from the menu screen and then press the ENTER button.

Unavailable on-screen menu items

This projector has unadjustable items and unusable functions depending on the signal being input.

When an item cannot be adjusted or a function cannot be used, the corresponding on-screen menu display does not appear, and the item or function will not work even if the ENTER button is pressed.

- When an individual adjustment screen is being displayed



Only the item displayed will be returned to the factory default setting, and the bar scale will appear white.

NOTE:

- Triangle symbols above and below a menu bar indicate the factory default setting. Items which do not have these triangle symbols cannot be returned to the factory default setting.

Indicates the standard factory default setting



Indicates the current adjustment value

- The positions of triangle symbols vary depending on the type of signal being input.

Correcting keystone distortion

Keystone distortion is corrected automatically when the projector's automatic setup function is used, but this correction will not apply if the screen itself is tilted. In such cases, you can correct the keystone distortion manually with the following procedure.

For PT-LC76U/PT-LC56U (Vertical keystone distortion correction only)

KEYSTONE 0

Vertical keystone distortion correction		
	Operation	Press the ► button.

For PT-LC80U

KEYSTONE H 0
V 0

Horizontal keystone distortion correction		
	Operation	Press the ► button.

Vertical keystone distortion correction		
	Operation	Press the ▲ button.

- Press the MENU button to return to the previous screen.

NOTE:

- If you press the AUTO SETUP button after correcting the keystone distortion manually, the automatic keystone correction function will operate and the corrected picture will return to its previous incorrect condition. To prevent this from happening, you can set "AUTO KEYSTN" in the OPTION1 menu to "OFF". (Refer to page 42.)
- Vertical keystone distortion can be corrected to $\pm 30^\circ$ of the angle of tilt. Horizontal keystone distortion can be corrected to $\pm 20^\circ$ of the angle of tilt for the PT-LC80U. However, the greater the correction amount, the more the picture quality will deteriorate, and the harder it will become to achieve a good level of focus. To obtain the best picture quality, set up the projector and screen in such a way that the amount of keystone correction required is as minimal as possible.
- The picture size will also change when correction of keystone distortion is carried out.

Adjusting the picture

Use the ▲ and ▼ buttons on the projector or remote control unit to select an item, and then use the ◀ and ► buttons to change the setting for that item.

For items with bar scales, press the ENTER button or the ◀ or ► buttons to display the adjustment screen, and then use the ◀ or ► buttons to make the adjustment.

When an RGB signal is being input

PICTURE	
PICTURE MODE (STANDARD)	
CONTRAST	32
BRIGHT	32
SHARPNESS	0
COLOR TEMP.	(STANDARD)
W-BAL R	32
W-BAL G	32
W-BAL B	32
SIGNAL MODE	XGA
STANDARD	
◄ SELECT ► ADJ	

When an YPbPr signal is being input

PICTURE	
PICTURE MODE (STANDARD)	
CONTRAST	32
BRIGHT	32
COLOR	32
TINT	32
SHARPNESS	2
COLOR TEMP.	(STANDARD)
SIGNAL MODE	525P
STANDARD	
◄ SELECT ► ADJ	

When an S-VIDEO/VIDEO signal is being input

PICTURE	
PICTURE MODE (STANDARD)	
CONTRAST	32
BRIGHT	32
COLOR	32
TINT	32
SHARPNESS	8
COLOR TEMP.	(STANDARD)
TV-SYSTEM	(AUTO1)
STILL MODE	(OFF)
STANDARD	
◄ SELECT ► ADJ	

PICTURE MODE

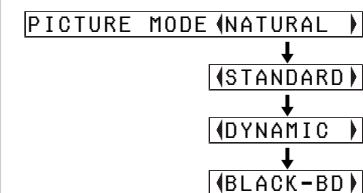

Select the picture mode that best matches the image source and room conditions.

The mode best used in dark rooms is NATURAL. For rooms having regular lighting conditions in use, select STANDARD. For exceptionally bright rooms, use DYNAMIC.

BLACK-BD is for the PT-LC80U only. This item is available only when BLACKBOARD in the OPTION1 menu is set to "ON". Select BLACK-BD when projecting onto blackboards.

CONTRAST

This adjusts the contrast of the picture. Press the ► button to make the picture brighter, and press the ◀ button to make the picture darker. (Adjust the BRIGHT setting first if required before adjusting the CONTRAST setting.)

BRIGHT

This adjusts the darker areas (black areas) in the picture. Press the ► button if dark areas are too solid (for example, if hair is difficult to see), and press the ◀ button if black areas are too light (grey rather than black).

COLOR

(S-VIDEO/VIDEO/YPbPr only)
Press the ► button to make the color more vivid in tone, and press the ◀ button to make the color more pastel in tone.

TINT

(NTSC/NTSC 4.43/YPbPr only)
This adjusts the flesh tones in the picture. Press the ► button to make flesh tones more greenish, and press the ◀ button to make the flesh tones more reddish.

SHARPNESS

Press the ► button to make the picture details sharper, and press the ◀ button to make the picture details softer.

Color Hue Setting (color temperature)

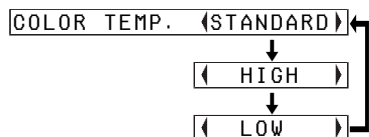

This is used to adjust the white areas of the picture if they appear bluish or reddish.

WHITE BALANCE R/G/B

(RGB only)
This is used to adjust the white areas of the picture if they appear coloured. Press the ◀ button to make the selected color lighter.

Press the ► button to make the selected color stronger.

TV-SYSTEM

(S-VIDEO/VIDEO only)

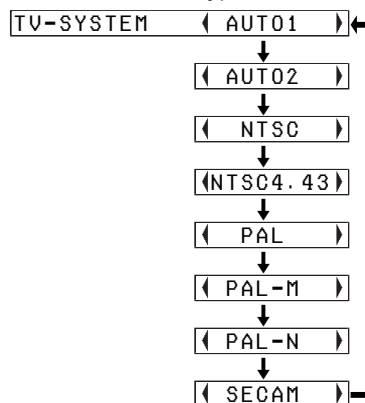

AUTO1

The projector automatically distinguishes between NTSC/NTSC 4.43/PAL/PAL60/SECAM signals.

AUTO2

The projector automatically distinguishes between NTSC/PAL-M/PAL-N signals.

NOTE:

- This should normally be set to "AUTO1" or "AUTO2". If the signal is of such poor quality that the correct format cannot be automatically distinguished, change the setting manually to the required TV system.

STILL MODE

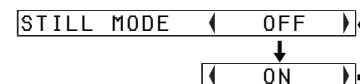

To reduce flickering of still images (vertical flicker), set "STILL MODE" to "ON" by pressing the ◀ or ► buttons.

NOTE:

- Do not set "STILL MODE" to "ON" when playing back moving images.

SIGNAL MODE

(RGB/YPbPr only)

This displays the type of signal which is currently being projected.

Refer to the table on page 58 for details on each type of signal.

Projecting sRGB-compatible pictures

sRGB is an international color reproduction standard (IEC61966-2-1) established by the International Electrotechnical Commission (IEC). If you would like the colors in sRGB-compatible pictures to be reproduced more faithfully, make the following settings.

- ① Press the ▲ or ▼ button to select "PICTURE MODE", and then use the ◀ or ► button to select "NATURAL".
- ② Press the STANDARD (STD) button on the remote control unit.
- ③ Press the ▲ or ▼ button to select "COLOR TEMP.", and then use the ◀ or ► button to select "STANDARD".

NOTE:

- sRGB is only enabled when RGB signals are being input (when LAMP POWER has been set to "HIGH").

Adjusting the position

When the input signal is RGB, first press the AUTO SETUP button to initiate automatic positioning. If the optimum setting is not obtained when AUTO SETUP is carried out, adjust by the following procedure.

Use the ▲ and ▼ buttons on the projector or remote control unit to select an item, and then use the ◀ and ▶ buttons to change the setting for that item.

For items with bar scales, press the ENTER button or the ◀ or ▶ buttons to display the adjustment screen, and then use the ◀ or ▶ buttons to make the adjustment.

When an RGB/YPbPr signal is being input

POSITION	
POSITION	
DOT CLOCK	32
CLOCK PHASE	16
ASPECT	◀ 4:3 ▶
RESIZING	◀ ON ▶
FRAME LOCK	◀ OFF ▶
STANDARD	
⏴ SELECT ENTER RETRN	

When an S-VIDEO/VIDEO signal is being input

POSITION	
POSITION	
ASPECT	◀ 4:3 ▶
RESIZING	◀ ON ▶
STANDARD	
⏴ SELECT ENTER RETRN	

POSITION

Moves the picture position. Press the ENTER button to display the POSITION screen. Press the ◀ or ▶ buttons to move the picture horizontally. Press the ▲ or ▼ buttons to move the picture vertically.

POSITION	H	64
	V	32

DOT CLOCK

(RGB only)
Periodic striped pattern interference (noise) may occur when a striped pattern such as the one below is projected. If this happens, use the ◀ and ▶ buttons to adjust so that any such noise is minimised.

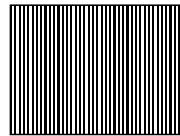

CLOCK PHASE

(RGB/YPbPr only)
Adjust the DOT CLOCK setting first before carrying out this adjustment. Use the ◀ and ▶ buttons to adjust so that the noise level is least noticeable.

NOTE:

- If signals with a dot clock frequency of 100 MHz or higher are being input, interference may not be completely eliminated when the DOT CLOCK and CLOCK PHASE adjustments are carried out.

ASPECT

This setting is only for an S-VIDEO/VIDEO signal and a YPbPr signal in 525i (480i), 525p (480p) and 625i format.

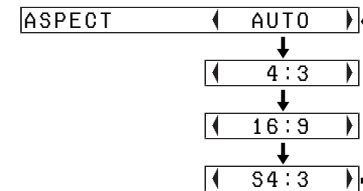

AUTO

(S-VIDEO only)
When an S1 video signal is input to the S-VIDEO terminal, the aspect ratio is changed automatically to project a 16:9 picture.

4:3

The input signal is projected without change.

16:9

The picture is compressed to a ratio of 16:9 and projected.

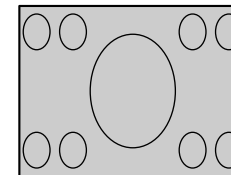

When a squeezed signal is being input. (The projected image is contracted vertically)

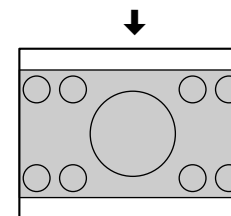

S4:3

The size of the input signal is compressed to 75% and projected. (This is useful for projecting a picture with a 4:3 aspect ratio onto a 16:9 screen.)

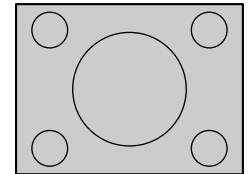

When a 4:3 signal is being input

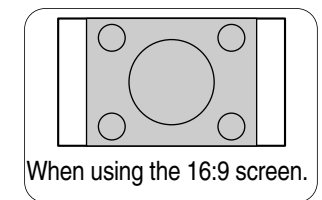
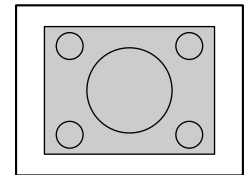

When using the 16:9 screen.

S1 video signals

- S1 video signals are a type of video signal with an aspect ratio of 16:9 which include a detector signal. This detector signal is output by some sources such as wide-vision video decks. If the AUTO setting above is selected, this projector will recognise the detector signal and automatically switch the aspect ratio to 16:9 in order to project the picture.

NOTE:

- This projector is equipped with an aspect ratio selection function. However, if a mode which does not match the aspect ratio of the input signal is selected, it may affect the quality of viewing of the original picture. Keep this in mind when selecting the aspect ratio.
- If using this projector in places such as cafes or hotels with the aim of displaying programs for viewing for a commercial purpose or for public presentation, note that if the aspect ratio (16:9) selection function is used to change the aspect ratio of the screen picture, you may be infringing the rights of the original copyright owner for that program under copyright protection laws.
- If a normal (4:3) picture which was not originally intended for wide-screen viewing is projected onto a wide screen, distortion may occur around the edges of the picture so that part of the picture is no longer visible. Such programs should be viewed in 4:3 mode to give proper consideration to the aims and intentions of the original program's creator.

RESIZING

This should normally be set to "ON". (This setting is only for signals which have lower resolutions than the LCD panels. Refer to page 58 for details.)

ON

The pixel resolution of the input signal is converted to the same resolution as the LCD panels before being projected. For signals with lower resolutions, gaps in the pixels are automatically interpolated into the picture before it is projected.

This may sometimes cause problems with the quality of the picture.

OFF

The picture signal is projected at its original resolution, with no pixel conversion. The projected picture will be smaller than normal, so adjust the zoom setting or move the projector forwards or backwards to adjust the picture size if necessary. If set to "OFF", some features, such as D.ZOOM (digital zoom), keystone distortion correction or INDEX WINDOW will not function.

FRAME LOCK

If the picture's condition is bad while a RGB moving picture signal is projected, set the FRAME LOCK to "ON". Refer to page 58 on compatible RGB signals.

Changing the display language

Use the ▲ and ▼ buttons on the projector or remote control unit to select a language, then press the ENTER button to accept the setting.

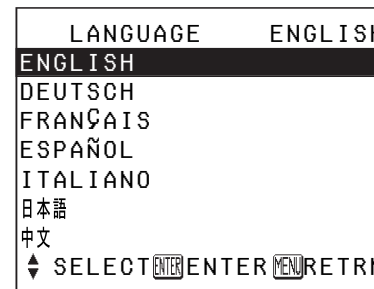

Indicates the language which is currently set

Option settings

Use the ▲ and ▼ buttons on the projector or remote control unit to select an item, then press the ◀ or ▶ buttons to change the setting.

OPTION1	
OSD	ON
AUTO SIGNAL	ON
AUTO KEYSTN	ON
AUTO RGB IN	ON
RGB2 SELECT	INPUT
RGB/YPbPr	AUTO
VGA60/525P	525P
SXGA MODE	SXGA
BLACKBOARD	OFF
SELECT	ADJ
	MENU/RETRN

OPTION2	
BACK COLOR	BLUE
FRONT/REAR	FRONT
DESK/CEILING	DESK
FAN CONTROL	STANDARD
LAMP POWER	HIGH
LAMP RUNTIME	100H
FUNC 1	INDEX
CONTROL KEY	ON
AUTO POW. OFF	DISABLE
SELECT	ADJ
	MENU/RETRN

OSD

ON

The current input name is displayed in the top-right corner of the screen when the input signal is changed.

OFF

Use this setting when you do not want the current input name to be displayed.

AUTO SIGNAL

This should normally be set to ON.

ON

AUTO SETUP will be carried out automatically when the input signal is changed.

42-ENGLISH

OFF

AUTO SETUP will not function when the input signal is changed.

AUTO KEYSTN

This should normally be set to ON.

ON

During automatic setup, the angle of tilt of the projector is detected and keystone distortion is corrected automatically.

OFF

Use this setting when you do not want automatic keystone correction to be carried out during automatic setup, such as when the screen itself is at an angle.

AUTO RGB IN

This should normally be set to ON.

ON

During automatic setup, the projector selects whichever one of the RGB1 IN or RGB2 IN connectors has a signal being input, and uses that signal for projection. (If a picture is being projected, the signal source is not automatically changed.)

OFF

Use this setting when you do not want the signal source to be changed automatically during automatic setup.

RGB2 SELECT

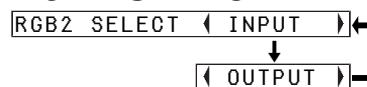

This setting is used to select the function of the RGB2 IN/RGB1 OUT connector.

RGB/YPbPr

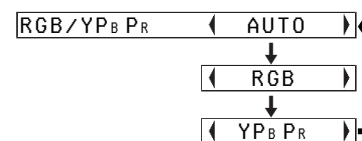

This should normally be set to AUTO. RGB or YPbPr is selected automatically depending on the synchronising signal status. When HDTV, 525p (480p), 525i (480i), 625i, 750p, and some VGA480 signals are being input, select "RGB" or "YPbPr" in accordance with the input signal.

VGA60/525P

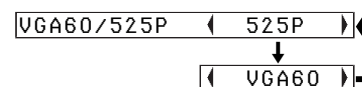

When a VGA60 or 525p RGB signal is being input, select the signal in accordance with the input signal.

SXGA MODE

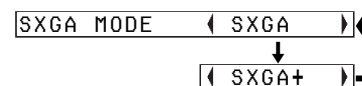

This setting is only for an SXGA signal.

SXGA

Select this item normally.

SXGA+

When the projected image is contracted vertically, select this item.

BLACKBOARD (PT-LC80U only)

Set to "ON" when PICTURE MODE is set to BLACK-BD. (Refer to page 35.)

BACK COLOR

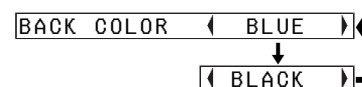

This sets the color which is projected onto the screen when no signal is being input to the projector.

FRONT/REAR

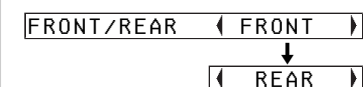

This setting should be changed in accordance with the projector setting-up method.

Set to "FRONT" when using a normal reflective screen with the projector positioned in front of the screen, and set to "REAR" when using a translucent screen with the projector positioned behind the screen.

DESK/CEILING

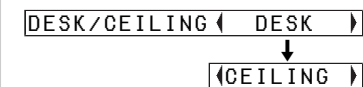

This setting should be changed in accordance with the projector setting-up method.

Set to "DESK" when setting up the projector on a desk or similar, and set to "CEILING" when suspending the projector from the ceiling using the ceiling bracket which is sold separately.

FAN CONTROL

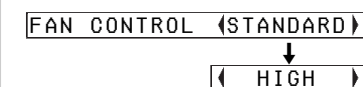

Set FAN CONTROL to "HIGH", when using this projector at high elevations (above 1400 m) only.

LAMP POWER

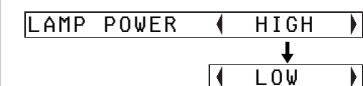

This setting changes the lamp brightness. When set to "LOW", the

luminance of the lamp is reduced, but the projector uses less power, and the operating noise is also reduced. This can help to extend the lamp's operating life. If using the projector in small rooms where high luminance is not required, it is recommended that you set the LAMP POWER to "LOW".

LAMP RUNTIME

This setting displays the usage time for the lamp unit which is currently being used.

NOTE:

- The lamp's operating life varies depending on the usage conditions (such as the LAMP POWER setting and the number of times the power is turned on and off).

FUNC 1



This assigns a function to the FUNC1 button of the ET-RM200 wireless remote control unit (sold separately).

INDEX

Functions in the same way as the INDEX WINDOW button on the accessory card remote control unit. (page 29)

KEYSTONE

Functions in the same way as when "KEYSTONE" is selected from the MAIN MENU screen. (page 34)

CONTROL KEY

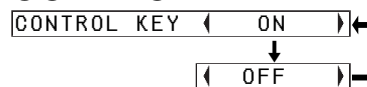

To disable the buttons on the projector, set CONTROL KEY to "OFF". A confirmation screen will then be displayed. Select "OK" by using ◀ and ▶ buttons. To use the buttons on the projector, set to "ON" by using the remote control unit. (page 14)

AUTO POW.OFF

If any signal is not input into the projector during the time that you set up, the projector will return to standby mode. The auto power off time can be set to, from 15 minutes to 60 minutes in 5 minute intervals. If you don't use this feature, set it to "DISABLE".

This feature will not function when using the freeze function.

Setting up the SECURITY function

This projector is equipped with a security function. A password input screen can be displayed, or a company URL can be set up and displayed at the bottom of the projected image.

Use the ▲ and ▼ buttons on the projector or remote control unit to select SECURITY, then press the ENTER button.

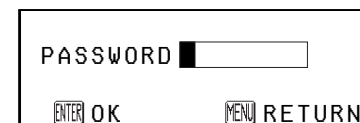
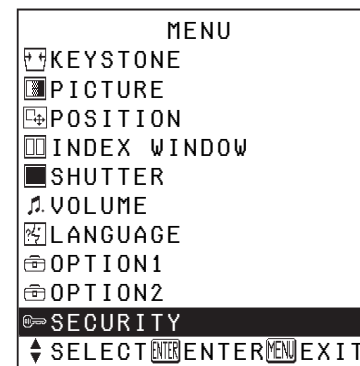

(When you use the SECURITY function for the first time)

Press the ▲, ▶, ▼, ◀, ▲, ▶, ▼ and ◀ buttons in order, then press the ENTER button.

(When a password change has been made before)

Type in the changed password, then press the ENTER button.

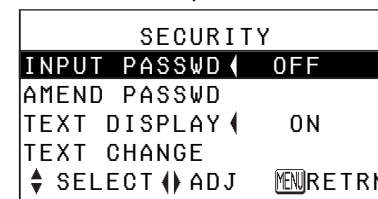

INPUT PASSWD

The password input screen can be displayed when the power is turned on. All of the controls other than the POWER button are disabled unless the password is entered correctly.

ON

INPUT PASSWD is enabled.

OFF

INPUT PASSWD is disabled. The password input screen will not be displayed when the power is turned on.

AMEND PASSWD

Passwords can be changed. Press the ENTER button to display the AMEND PASSWD screen.



- ① Set a password by pressing the ▲, ▼, ◀, and ▶ buttons on the remote control unit. (A maximum of 8 buttons can be set.)
- ② Press the ENTER button.
- ③ Enter the password again for confirmation.
- ④ Press the ENTER button. (Password change will be completed.)

NOTE:

- The entered password will appear as *. It will not be displayed on the screen.
- If you enter the wrong password, the letters "PASSWORD" and "NEW" will become red. Enter the correct password again.

TEXT DISPLAY

The setup letters can be displayed at the bottom of the projected image while an image is projected.

ON

TEXT DISPLAY is enabled.

OFF

TEXT DISPLAY is disabled.

TEXT CHANGE

The setup letters which will be displayed when TEXT DISPLAY is set to "ON" can be changed. Press the ENTER button to display the TEXT CHANGE screen.

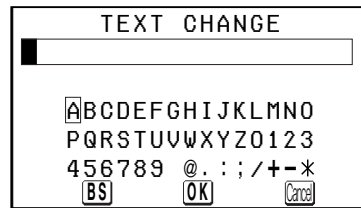

- ① Use the ▲, ▼, ◀ and ▶ buttons to select the characters, then press the ENTER button. (You can enter 22 characters continuously.)
 - Press "BS" on the screen to delete a character.
- ② Use the ▲, ▼, ◀ and ▶ buttons to select "OK", then press the ENTER button.
 - Select "Cancel" to cancel the change.

When the TEMP indicator and the LAMP indicator are illuminated

There are two indicators on the control panel of the projector which give information about the operating condition of the projector. These indicators illuminate or flash to warn you about problems that have occurred inside the projector, so if you notice that one of the indicators is on, turn off the power and check the table below for the cause of the problem.

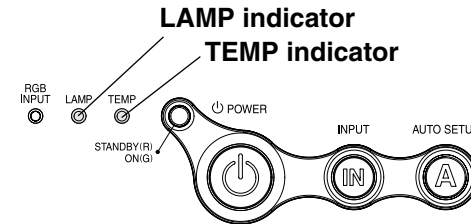

TEMP indicator			
Indicator display	Illuminated (red) (Lamp unit on)	Flashing (red) (Lamp unit on)	Flashing (red) (Lamp unit off)
Problem	The surrounding temperature or the temperature inside the projector has become unusually high.	The temperature inside the projector has become dangerously high, or the temperature has suddenly changed.	The surrounding temperature or the temperature inside the projector has become dangerously high, causing the lamp unit to be automatically shut off.
Possible cause	<ul style="list-style-type: none"> • The ventilation holes may be covered. • The ambient temperature in the place of use may be too high. • The air filter may be blocked. 		
Remedy	<ul style="list-style-type: none"> • Uncover the ventilation holes. • Set up the projector in a place where the temperature is between 0 °C (32 °F) and 40 °C (104 °F) and the humidity is between 20% and 80% (with no condensation). [If you set the FAN CONTROL to "HIGH" (page 43), set up the projector in a place where the temperature is between 0 °C (32 °F) and 35 °C (95 °F) and the humidity is between 20% and 80% (with no condensation).] • Turn off the MAIN POWER switch by following the procedure on page 24, and then clean the air filter (refer to page 49). 		

LAMP indicator		
Indicator display	Illuminated (red)	Flashing (red)
Problem	It is nearly time to replace the lamp unit.	An abnormality has been detected in the lamp circuit.
Possible cause	<ul style="list-style-type: none"> Does “REPLACE LAMP” appear on the screen after the projector is turned on? 	<ul style="list-style-type: none"> The power may have been turned on straight away after it was turned off. There may be an abnormality in the lamp circuit.
Remedy	<ul style="list-style-type: none"> This occurs when the operation time for the lamp unit is nearing 1800 hours. (when LAMP POWER has been set to “HIGH”) Ask your dealer or an Authorised Service Center to replace the lamp unit. 	<ul style="list-style-type: none"> Wait for a while until the lamp unit cools down before turning the power back on again. Turn off the MAIN POWER switch by following the procedure given on page 24, and then contact an Authorised Service Center.

NOTE:

- Be sure to turn off the MAIN POWER switch by following the procedure given in “Turning off the power” on page 24 before carrying out any of the procedures in the “Remedy” column.
- If the main power turns off after the TEMP indicator starts flashing, it means that an abnormality has occurred. Please contact an Authorised Service Center so that the necessary repairs can be made.

Cleaning and replacing the air filter

If the air filter becomes clogged with dust, the internal temperature of the projector will rise, the TEMP indicator will flash and the projector power will turn off. **The air filter should be cleaned every 100 hours of use,** depending on the location where the projector is being used.

Cleaning

Use a vacuum cleaner to clean off any accumulated dust.

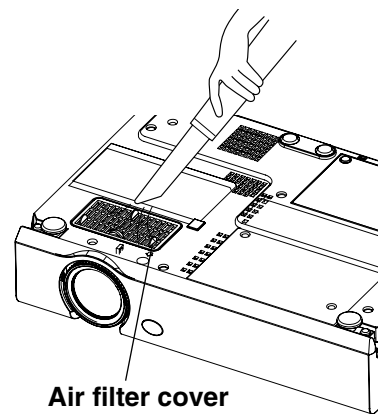

Air filter cover

NOTE:

- If the dust cannot be removed by cleaning, it is time to replace the air filter. Please consult your dealer. Furthermore, if the lamp unit is being replaced, replace the air filter at this time also.

Replacement procedure

- Turn off the MAIN POWER switch and disconnect the power cord plug from the wall outlet.
Turn off the MAIN POWER switch according to the procedure given in “Turning off the power” on page 24 before disconnecting the plug from the wall outlet.

- Gently turn the projector upside down, and then remove the air filter cover.

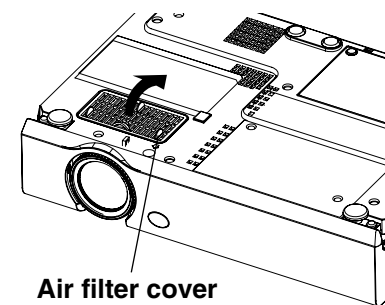

Air filter cover

- Replace the air filter, and then install the air filter cover.

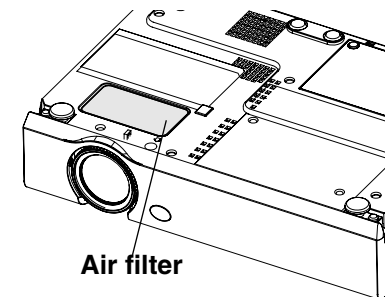

Air filter

NOTE:

- Be sure to install the air filter cover before using the projector. If the projector is used without the air filter cover installed, dust and other foreign particles will be drawn into the projector, and malfunctions will result.

Replacing the lamp unit

Warning

The lamp unit should only be replaced by a qualified technician.

When replacing the lamp, allow it to cool for at least one hour before handling it.

- The lamp cover gets very hot, and contact with it can cause burns.

Notes on replacing the lamp unit

- The light generating lamp is made of glass, so dropping it or allowing it to hit hard objects may cause it to burst. Be careful when handling the lamp.
- After having removed the old lamp, carelessly discarding it can cause the lamp to burst. Dispose of the lamp with the same care that would be taken with a fluorescent light.
- A Phillips screwdriver is necessary for removing the lamp unit. Make sure that your hands are not slippery when using the screwdriver.

NOTE:

- The projector is not supplied with a replacement lamp unit. Please ask your dealer for details. Lamp unit product no.: **ET-LAC80**

CAUTION:

- Do not use any lamp unit other than the one with the product number indicated above.

Lamp unit replacement period



The lamp is a consumable product. Even when the full life of the bulb has not been exhausted, the brightness of the light will gradually decline. Therefore periodic replacement of the lamp is necessary.

The intended lamp replacement interval is 2000 hours, but it is possible that the lamp may need to be replaced earlier due to variables such as a particular lamp's characteristics, usage conditions and the installation environment. Early preparation for lamp replacement is encouraged.

A lamp that has exceeded 2000 hours of use has a much greater chance of exploding. In order to prevent the lamp from exploding, the lamp will be automatically shut off when 2000 hours of use have been reached.

NOTE:

- The usage hours explained above are for use when the HIGH setting has been selected for LAMP POWER in the OPTION2 menu. If the LOW setting is selected, the brightness of the lamp will be less and life of the lamp can be extended.
- While 2000 hours is the intended replacement interval, it is not a period of time covered by warranty.

	On-screen display 	Lamp indicator warning light 
More than 1800 hours	Displayed for 30 seconds. Pressing any button will clear the display.	The projector will enter Standby Mode and the red indicator lamp will illuminate.
More than 2000 hours	This display cannot be cleared at all, no matter which button is pressed.	

Lamp unit replacement procedure

NOTE:

- If the lamp usage time has passed 2000 hours (when LAMP POWER has been set to "HIGH"), the projector will switch to standby mode after approximately 10 minutes of operation. The steps ⑦ to ⑾ on the next page should thus be completed within 10 minutes.

- ① Turn off the MAIN POWER switch according to the procedure given in "Turning off the power" on page 24, and then disconnect the power cord plug from the wall outlet and check that the area around the lamp unit has cooled down.
- ② Use a Phillips screwdriver to turn the lamp unit cover fixing screws at the bottom of the projector, and then remove the lamp unit cover from the projector.

Lamp unit cover

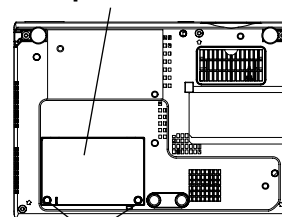

Lamp unit cover fixing screws

- ③ Use a Phillips screwdriver to loosen the two lamp unit fixing screws until the screws turn freely. Then hold the handle of the lamp unit and gently pull it out from the projector.

Handle

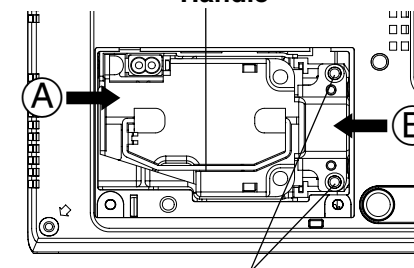

Lamp unit fixing screws

- ④ Insert the new lamp unit while making sure that the direction of insertion is correct, and then use a Phillips screwdriver to securely tighten the lamp unit fixing screws.

When inserting the new lamp unit, be sure to push it in at the point (A) and (B).

- ⑤ Install the lamp unit cover, and then use a Phillips screwdriver to securely tighten the lamp unit cover fixing screws.

NOTE:

- Be sure to install the lamp unit and the lamp unit cover securely. If they are not securely installed, it may cause the protection circuit to operate so that the power cannot be turned on.

- ⑥ Insert the power cord plug into the wall outlet and then press the MAIN POWER switch.

NOTE:

- If the POWER indicator on the projector does not illuminate red when the MAIN POWER switch is turned on, turn the MAIN POWER switch off again, unplug the power cord from the electrical outlet, and check that the lamp unit and the lamp unit cover are securely installed. Then turn the MAIN POWER switch back on.

- ⑦ Press the POWER button so that a picture is projected onto the screen.

- ⑧ Press the MENU button to display the MAIN MENU screen, and then press the ▲ and ▼ buttons to move the cursor to select “OPTION2”.

MENU	
⏏	KEYSTONE
🖼️	PICTURE
📐	POSITION
🪟	INDEX WINDOW
🔒	SHUTTER
🔊	VOLUME
🌐	LANGUAGE
⚙️	OPTION1
⚙️	OPTION2
🔒	SECURITY
⬇️	SELECT
👉	ENTER
👈	EXIT

- ⑨ Press the ENTER button to display the OPTION2 screen, and then use the ▲ and ▼ buttons to select LAMP RUNTIME.

OPTION2	
BACK COLOR	◀ BLUE ▶
FRONT/REAR	◀ FRONT ▶
DESK/CEILING	◀ DESK ▶
FAN CONTROL	◀ STANDARD ▶
LAMP POWER	◀ HIGH ▶
LAMP RUNTIME	1820H
FUNC 1	◀ INDEX ▶
CONTROL KEY	◀ ON ▶
AUTO POW. OFF	◀ DISABLE ▶
⬇️	SELECT
	👉RETRN

- ⑩ Press and hold the ENTER button for approximately 3 seconds.

OPTION2	
BACK COLOR	◀ BLUE ▶
FRONT/REAR	◀ FRONT ▶
DESK/CEILING	◀ DESK ▶
FAN CONTROL	◀ STANDARD ▶
LAMP POWER	◀ HIGH ▶
TIME RESET [POWER OFF]	
FUNC 1	◀ INDEX ▶
CONTROL KEY	◀ ON ▶
AUTO POW. OFF	◀ DISABLE ▶
⬇️	SELECT
	👉RETRN

The “LAMP RUNTIME” will change to “TIME RESET [POWER OFF]”.

NOTE:

- If the MENU button is pressed, the lamp time resetting screen will be cancelled.

- ⑪ Turn off the power.

This will reset the cumulative usage time for the lamp unit to zero.

Refer to page 24 for details on how to turn off the power.

Before calling for service

Before calling for service, check the following points.

Problem	Possible cause	Page
Power does not turn on.	● The power cord may not be connected.	–
	● The MAIN POWER switch is turned off.	–
	● The main power supply is not being supplied to the wall outlet.	–
	● TEMP indicator is illuminated or flashing.	47
	● LAMP indicator is illuminated or flashing.	48
	● The lamp unit cover has not been securely installed.	–
No picture appears.	● The video signal input source may not be connected properly.	–
	● The input selection setting may not be correct.	23
	● The BRIGHT adjustment setting may be at the minimum possible setting.	36
	● The shutter function may be in use.	27
The picture is fuzzy.	● The lens cover may still be attached to the lens.	–
	● The lens focus may not have been set correctly.	23
	● The projector may not be at the correct distance from the screen.	18
	● The lens may be dirty.	–
	● The projector may be tilted too much.	18
COLOR is too light or TINT is poor.	● COLOR or TINT adjustment may be incorrect.	36
	● The input source which is connected to the projector may not be adjusted correctly.	–
No sound can be heard.	● The audio signal source may not be connected properly.	–
	● The volume adjustment may be at the lowest possible setting.	28, 31
The remote control unit does not operate.	● The battery may be weak.	–
	● The battery may not be inserted correctly.	21
	● The remote control signal receptor on the projector may be obstructed.	21
	● The remote control unit may be out of the operation range.	21
The buttons on the projector do not function.	● The CONTROL KEY may be set to “OFF”.	44
	In order to set the CONTROL KEY to “ON” without using the remote control unit, keep holding down the ENTER button on the projector and press the MENU button for more than 2 seconds. It will then be turned ON.	

Problem	Possible cause	Page
The picture does not display correctly.	● The signal format (TV system) may not be set correctly.	36
	● There may be a problem with the video tape or other signal source.	–
	● A signal which is not compatible with the projector may be being input.	58
Picture from computer does not appear.	● The cable may be too long.	–
	● The external video output for the laptop computer may not be set correctly. (You may be able to change the external output settings by pressing the [Fn]+[F3] or [Fn]+[F10] keys simultaneously. The actual method varies depending on the type of computer, so refer to the documentation provided with your computer for further details.)	–
	● If an RGB input indicator is turned off, the video signals may not be output from the computer.	14, 25
	● RGB2 SELECT in the OPTION1 menu is set to OUTPUT when the signals are input to RGB2 IN / RGB1 OUT connector.	42

Cleaning and maintenance

Before carrying out cleaning and maintenance, be sure to disconnect the power cord plug from the wall outlet.

Wipe the cabinet with a soft, dry cloth.

If the cabinet is particularly dirty, soak the cloth in water with a small amount of neutral detergent in it, squeeze the cloth very well, and then wipe the cabinet. After cleaning, wipe the cabinet dry with a dry cloth.

If using a chemically-treated cloth, read the instructions supplied with the cloth before use.

Do not wipe the lens with a cloth that is dusty or which produces lint.

If any dust or lint gets onto the lens, such dust or lint will be magnified and projected onto the screen. Use a blower to clean any dust and lint from the lens surface, or use a soft cloth to wipe off any dust or lint.

Specifications

Power supply:	100 V–240 V ~, 50 Hz/60 Hz
Power consumption:	220 W (During standby (when fan is stopped): Approx. 3 W)
Amps:	2.5 A–1.0 A
LCD panel:	
Panel size (diagonal):	0.7 type (17.78 mm)
Aspect ratio:	4:3 (16:9 compatible)
Micro lens array:	
PT-LC80U/PT-LC76U:	Available
PT-LC56U:	Not available
Display method:	3 transparent LCD panels (RGB)
Drive method:	Active matrix method
Pixels:	
PT-LC80U/PT-LC76U:	786 432 (1024 x 768) x 3 panels
PT-LC56U:	480 000 (800 x 600) x 3 panels
Lens:	
PT-LC80U:	Manual zoom (1 - 1.2) / focus lens F 1.7 - 1.9, f 21.5 mm - 25.8 mm
PT-LC76U/PT-LC56U:	F 2.0 - 2.3, f 22.0 mm - 26.2 mm
Lamp:	
	UHM lamp (160 W)
Luminosity:	
PT-LC80U:	2 000 lm/ANSI
PT-LC76U/PT-LC56U:	1 600 lm/ANSI
Scanning frequency(for RGB signals):	
Horizontal scanning frequency:	15 kHz–91 kHz
Vertical scanning frequency:	50 Hz–85 Hz
Dot clock frequency:	Less than 100 MHz
YPbPr signals:	525i (480i), 525p (480p), 625i (576i), 750p (720p), 1125i (1080i)
Color system:	7 (NTSC/NTSC 4.43/PAL/PAL-M/PAL-N/PAL60/SECAM)
Projection size:	838.2 mm - 7620 mm (33" - 300")
Throw distance:	
PT-LC80U:	1.1 m - 10.7 m (3'7" - 35'1")
PT-LC76U/PT-LC56U:	1.1 m - 11.0 m (3'7" - 36'1")
Optical axis shift:	6:1 (fixed)
Screen aspect ratio:	4:3
Installation:	Front/Rear/Ceiling/Desk (Menu selection method)
Speaker:	4 cm x 3 cm oval x 1
Max. useable volume output:	2 W (mono)
Connectors	
RGB IN/OUT:	Dual-line D-SUB HD 15-pin (female) (One-line is available for input and output)

During YPbPr input/output:	
Y:	1.0 V [p-p], 75 Ω
Pb,Pr :	0.7 V [p-p], 75 Ω
During RGB input/output:	
R.G.B.:	0.7 V [p-p], 75 Ω
G.SYNC:	1.0 V [p-p], 75 Ω
HD/SYNC:	TTL, automatic plus/minus polarity compatible
VD:	TTL, automatic plus/minus polarity compatible
VIDEO IN:	Single-line, RCA pin jack 1.0 V [p-p], 75 Ω
S-VIDEO IN:	Single-line, Mini DIN 4-pin Y 1.0 V [p-p], C 0.286 V [p-p], 75 Ω
AUDIO IN:	0.5 V [rms] RCA pin jack x 2 (L-R)
Serial connector:	DIN 8-pin RS-232C compatible
Cabinet:	Moulded plastic (ABS/PC)
Dimensions:	
Width:	297 mm (11-11/16")
Height:	72 mm (2-13/16")
Length:	209 mm (8-7/32") (without lens cover)
Weight:	2.2 kg (4.9 lbs.)
Operating environment:	
Temperature:	0 °C–40 °C (32 °F–104 °F) [When the FAN CONTROL is set to "HIGH" (page 43); 0 °C–35 °C (32 °F–95 °F)]
Humidity:	20%–80% (no condensation)
Certifications:	UL60950, C-UL FCC Class B

<Remote control unit>

Power supply:	3 V DC (Lithium CR2025 battery x1)
Operating range:	Approx. 7 m (23') (when operated directly in front of signal receptor)
Weight:	18 g (0.6 ozs.) (including battery)
Dimensions:	
Width:	40 mm (1-9/16")
Length:	6.5 mm (1/4")
Height:	86 mm (3-3/8")

<Options>

Ceiling bracket	ET-PKC80
Wireless remote control unit	ET-RM200
Serial adapter (DIN 8-pin/D-sub 9-pin)	ET-ADSER

Appendix

List of compatible signals

Mode	Display resolution (dots)*1	Scanning frequency		Dot clock frequency (MHz)	Picture quality*2		Resizing*3		Format
		H (kHz)	V (Hz)		LC80 LC76	LC56	LC80 LC76	LC56	
NTSC/NTSC4.43/ PAL-M/PAL60	720 x 480i	15.734	59.940		A	A	OK	OK	Video/S-Video
PAL/PAL-N/SECAM	720 x 576i	15.625	50.000		A	A	OK	OK	Video/S-Video
525i	720 x 480i	15.734	59.940	13.500	A	A	OK	OK	YPbPr/RGB
625i	720 x 576i	15.625	50.000	13.500	A	A	OK	OK	YPbPr/RGB
525p	720 x 483	31.469	59.940	27.000	A	A	OK	OK	YPbPr/RGB
HDTV60	1 920 x 1 080i	33.750	60.000	74.250	A	A			YPbPr/RGB
HDTV50	1 920 x 1 080i	28.125	50.000	74.250	A	A			YPbPr/RGB
750p	1 280 x 720	45.000	60.000	74.250	A	A			YPbPr/RGB
VGA400	640 x 400	31.469	70.086	25.175	A	A	OK	OK	RGB
	640 x 400	37.861	85.081	31.500	A	A	OK	OK	RGB
VGA480	640 x 480	31.469	59.940	25.175	A	A	OK	OK	RGB
	640 x 480	35.000	66.667	30.240	A	A	OK	OK	RGB
	640 x 480	37.861	72.809	31.500	A	A	OK	OK	RGB
	640 x 480	37.500	75.000	31.500	A	A	OK	OK	RGB
	640 x 480	43.269	85.008	36.000	A	A	OK	OK	RGB
SVGA	800 x 600	35.156	56.250	36.000	A	AA	OK		RGB
	800 x 600	37.879	60.317	40.000	A	AA	OK		RGB
	800 x 600	48.077	72.188	50.000	A	AA	OK		RGB
	800 x 600	46.875	75.000	49.500	A	AA	OK		RGB
	800 x 600	53.674	85.061	56.250	A	AA	OK		RGB
MAC16	832 x 624	49.725	74.550	57.283	A	A	OK		RGB
XGA	1 024 x 768	48.363	60.004	65.000	AA	A			RGB
	1 024 x 768	56.476	70.069	75.000	AA	A			RGB
	1 024 x 768	60.023	75.029	78.750	AA	A			RGB
	1 024 x 768	68.678	84.997	94.500	AA	A			RGB
	1 024 x 768i	35.520	86.952	44.897	AA	A			RGB
MXGA	1 152 x 864	63.995	71.184	94.200	A	A			RGB
	1 152 x 864	67.500	74.917	108.000	B	B			RGB
	1 152 x 864	76.705	85.038	121.500	B	B			RGB
MAC21	1 152 x 870	68.681	75.062	100.000	B	B			RGB
MSXGA	1 280 x 960	60.000	60.000	108.000	B	B			RGB
SXGA	1 280 x 1 024	63.981	60.020	108.000	B	B			RGB
	1 280 x 1 024	79.977	75.025	135.001	B	B			RGB
	1 280 x 1 024	91.146	85.024	157.500	B	B			RGB
	1 400 x 1 050	63.981	60.020	108.000	B	B			RGB
UXGA	1 600 x 1 200	75.000	60.000	162.000	B	B			RGB

*1 The "i" appearing after the resolution indicates an interlaced signal.

*2 The following symbols are used to indicate picture quality.

AA Maximum picture quality can be obtained.

A Signals are converted by the image processing circuit before picture is projected

B Some loss of data occurs to make projection easier.

*3 Signals with "OK" in the Resizing column can be set using the RESIZING command in the POSITION menu. (Refer to page 40.)

*4 Signals that are compatible with the FRAME LOCK function. (page 40.)

Connector pin wiring

- The pin layout and signal names for the S-VIDEO IN connector are shown below.

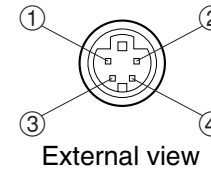

Pin No.	Signal
①	Earth (Luminance signal)
②	Earth (Color signal)
③	Luminance signal
④	Color signal

- The pin layout and signal names for the RGB/YPbPr (RGB1 IN/RGB2 IN) connector are shown below.

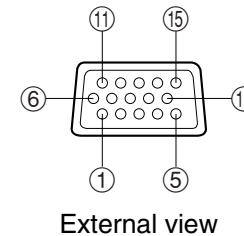

Pin No.	Signal
①	R/Pr
②	G/G.SYNC/Y
③	B/Pb
⑫	SDA
⑬	HD/SYNC
⑭	VD
⑮	SCL

Pin ⑨ is spare.

Pins ④—⑧, ⑩ and ⑪ are for earth.

Pins ⑫ and ⑮ functions are only valid when supported by the computer

Projection dimensions calculation methods

If the screen size (diagonal) is SD (m), then the following formula is used to calculate the projection distance for the wide lens position (LW) and the projection distance for the telephoto lens position (LT).

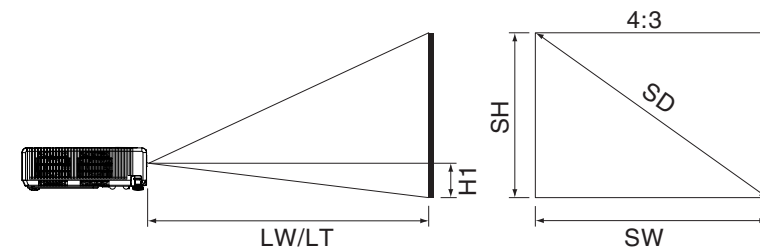

PT-LC80U	PT-LC76U / PT-LC56U
$LW=0.030 \times SD / 0.0254 - 0.037$	$LW=0.031 \times SD / 0.0254 - 0.038$
$LT=0.036 \times SD / 0.0254 - 0.037$	$LT=0.037 \times SD / 0.0254 - 0.038$

For 16:9 aspect ratios, the following formula can be used to calculate the projection distance.

PT-LC80U	PT-LC76U / PT-LC56U
$LW=0.032 \times SD / 0.0254 - 0.037$	$LW=0.033 \times SD / 0.0254 - 0.038$
$LT=0.039 \times SD / 0.0254 - 0.037$	$LT=0.040 \times SD / 0.0254 - 0.038$

Using the SERIAL connector

The serial connector which is on the side connector panel of the projector conforms to the RS-232C interface specification, so that the projector can be controlled by a personal computer which is connected to this connector.

Connection

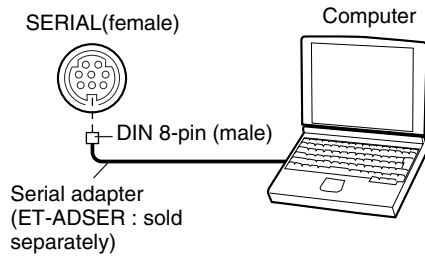

You must use only RS-232C Serial Interface Cable with ferrite core, type ET-ADSER.

Pin layout and signal names for SERIAL connector

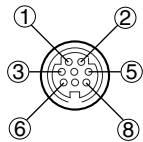

DIN 8-PIN connector seen from outside

Pin No.	Signal name	Contents
③	RXD	Received data
④	GND	
⑤	TXD	Transmitted data
①		Connected internally
②		
⑥		
⑦		NC
⑧		NC

Communications settings

Signal level	RS-232C
Sync. method	Asynchronous
Baud rate	9600 bps
Parity	None
Character length	8 bits
Stop bit	1 bit
X parameter	None
S parameter	None

Basic format

The data sent from the computer to the projector is transmitted in the format shown below.

STX	Command	:	Parameter	ETX
Start byte (02h)	1 byte 3 bytes		1 byte-5 bytes	End byte (03h)

NOTE:

- The projector can not receive the command for 10 seconds after the lamp is switched on. Wait 10 seconds before sending the command.
- If sending multiple commands, check that a response has been received from the projector for one command before sending the next command.
- When a command which does not require parameters is sent, the colon (:) is not required.
- If an incorrect command is sent from the personal computer, the "ER401" command will be sent from the projector to the personal computer.

Control commands

The commands which the personal computer can use to control the projector are shown in the following table.

Command	Control Contents	Remarks
PON	Power ON	In standby mode, all commands other than the PON command are ignored. <ul style="list-style-type: none"> • The PON command is ignored during lamp ON control. • If a PON command is received while the cooling fan is operating after the lamp has switched off, the lamp is not turned back on again straight away, in order to protect the lamp.
POF	Power OFF	
AVL	Volume	Parameter 000-063(Adjustment value 0-63)
IIS	Input signal selection	Parameter VID=VIDEO SVD=S-VIDEO RG1=RGB1(YPBPR1) RG2=RGB2(YPBPR2)
Q\$\$	Lamp ON condition query	Parameter 0 = Standby 1 = Lamp ON control active 2 = Lamp ON 3 = Lamp OFF control active

Cable specifications

(When connected to a personal computer)

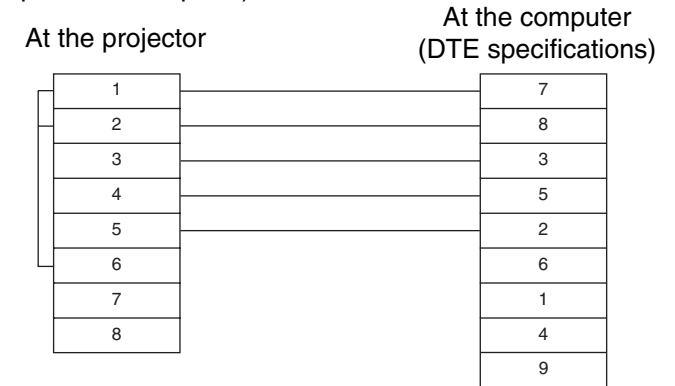

Dimensions

<Units: mm (inch)>

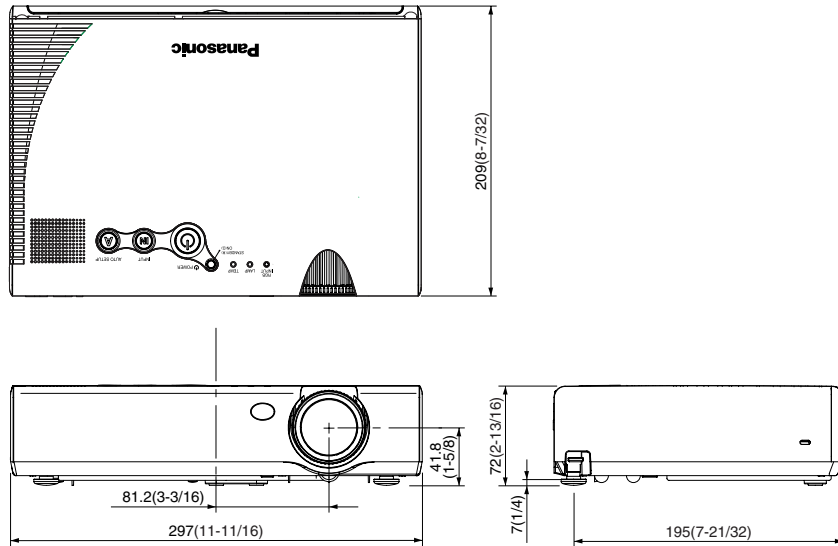

Trademark acknowledgements

- VGA and XGA are trademarks of International Business Machines Corporation.
 - Macintosh is a registered trademark of Apple Computer, Inc.
 - S-VGA is a registered trademark of the Video Electronics Standards Association.
- All other trademarks are the property of the various trademark owners.

NOTES IMPORTANTES CONCERNANT LA SÉCURITÉ

AVERTISSEMENT: POUR REDUIRE LES RISQUES DE FEU OU DE CHOC ÉLECTRIQUE, NE PAS EXPOSER CE PRODUIT À L'EAU OU À L'HUMIDITÉ

Alimentation: Ce projecteur LCD est conçu pour fonctionner sur secteur de 100 V - 240 V, 50 Hz/60 Hz seulement.

ATTENTION: Le cordon d'alimentation secteur fourni avec le projecteur peut être utilisé uniquement pour une alimentation électrique de 125 V, 7 A maximum. Si on veut l'utiliser avec une tension ou un courant plus forts, on doit se procurer un autre cordon d'alimentation de 250 V. Si on utilise le cordon fourni sous ces conditions, risque de provoquer un incendie.

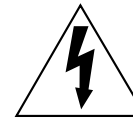

Le symbole de la flèche en forme d'éclair, dans un triangle, avertit l'utilisateur de la présence de "tensions dangereuses" à l'intérieur du produit qui peuvent être de force suffisante pour constituer un risque de choc électrique aux personnes.



Le point d'exclamation dans un triangle avertit l'utilisateur de la présence d'instructions importantes concernant l'utilisation et l'entretien (réparation) dans la littérature accompagnant le produit.

These Operating Instructions are printed on recycled paper.

Précautions de sécurité

AVERTISSEMENT

En cas de problème (pas d'image ou de son), ou si le projecteur dégage de la fumée ou une odeur étrange, éteindre l'appareil et débrancher immédiatement la fiche d'alimentation de la prise de courant.

- Ne pas continuer d'utiliser le projecteur dans ces cas, autrement cela peut entraîner un incendie ou des chocs électriques.
- Après s'être assuré que de la fumée ne se dégage plus, s'adresser à un centre technique agréé et demander que les réparations nécessaires soient faites.
- Le fait de réparer le projecteur soi-même est très dangereux, et ne doit jamais être fait.

Ne pas installer ce projecteur dans un endroit qui n'est pas assez résistant pour supporter le poids du projecteur.

- Si l'emplacement d'installation n'est pas assez résistant, le projecteur risque de tomber et causer de graves blessures et (ou) des dommages.

Demander à un technicien qualifié d'installer le projecteur par exemple s'il est installé au plafond.

- Si l'installation n'est pas faite correctement, cela peut entraîner des blessures ou des chocs électriques.

Si de l'eau ou des objets étrangers entrent dans le projecteur, si le projecteur tombe, ou si le boîtier est endommagé, éteindre l'appareil et débrancher immédiatement la fiche d'alimentation de la prise de courant.

- Si l'on continue d'utiliser le projecteur dans cette condition, cela peut entraîner un incendie ou des chocs électriques.
- S'adresser à un centre technique agréé pour que les réparations nécessaires puissent être faites.

Ne pas surcharger la prise de courant.

- Si l'alimentation est surchargée (par exemple, par l'utilisation de trop d'adaptateurs), cela risque de faire surchauffer le projecteur et peut entraîner un incendie.

Ne pas retirer le capot ou le modifier.

- Des hautes tensions qui peuvent causer de graves blessures sont présentes à l'intérieur du projecteur.
- Pour toute inspection, réglage ou réparation, s'adresser à un centre technique agréé.

Nettoyer la fiche du cordon d'alimentation régulièrement afin d'éviter toute accumulation de poussière.

- Si de la poussière s'accumule sur la fiche du cordon d'alimentation, l'humidité peut endommager l'isolant et entraîner un incendie. Débrancher le cordon d'alimentation de la prise de courant et l'essuyer avec un chiffon sec.

- Si le projecteur n'est pas utilisé pendant une période prolongée, débrancher le cordon d'alimentation de la prise de courant.

Faire attention à ne pas endommager le cordon d'alimentation.

- Ne pas endommager le cordon d'alimentation, ne pas le modifier, ne pas le placer sous des objets lourds, ne pas le chauffer, ne pas le placer près d'objets chauffants, ne pas le tordre, ne pas le plier ou le tirer excessivement et ne pas le rouler en boule.
- Si le cordon d'alimentation est endommagé, cela peut entraîner un incendie et des chocs électriques.
- Si le cordon d'alimentation est endommagé, le faire réparer par un centre technique agréé.

Ne pas manipuler le cordon d'alimentation avec les mains mouillées.

- Cela peut entraîner des chocs électriques.

Brancher la fiche du cordon d'alimentation fermement dans la prise de courant.

- Si la fiche n'est pas complètement insérée, cela peut entraîner des chocs électriques ou la faire surchauffer.
- Si la fiche est endommagée ou la plaque de la prise est desserrée, elles ne devraient pas être utilisées.

Ne pas placer le projecteur sur des surfaces instables.

- Si le projecteur est placé sur une surface qui est inclinée ou instable, il risque de tomber ou de se renverser et cela peut causer des blessures ou des dommages.

Ne pas placer le projecteur dans l'eau ou ne pas le laisser se mouiller.

- Sinon cela peut causer un incendie ou des chocs électriques.

Ne pas placer des récipients de liquide sur le projecteur.

- Si de l'eau se renverse sur le projecteur, s'adresser à un centre technique agréé.
- Si de l'eau entre à l'intérieur du projecteur, entrer en contact avec un centre technique agréé.

Ne pas mettre d'objets étrangers dans le projecteur.

- Ne pas insérer d'objets métalliques ou inflammables dans les orifices de ventilation ou les faire tomber sur le projecteur, car cela peut causer un incendie ou des chocs électriques.

Ne pas placer le projecteur sur des matériaux comme du tapis ou du tissu éponge.

- Cela peut provoquer une surchauffe du projecteur, pouvant entraîner des brûlures, un incendie ou endommager le projecteur.

Après avoir retiré la pile de la télécommande, la garder hors de la portée des enfants et des bébés.

- Si avalée, la pile peut causer la mort par suffocation.
- Si la pile est avalée, s'adresser à un médecin immédiatement.

Veiller à ce que les bornes + et - des piles n'entrent pas en contact avec des objets métalliques tels que colliers ou épingles à cheveux.

- Sinon, les piles risqueront de fuir, de surchauffer, d'exploser ou de prendre feu.
- Ranger les piles dans un sac en plastique, et ne pas les ranger à proximité d'objets métalliques.

Pendant un orage, ne pas toucher le projecteur ou le câble.

- Il y a risque d'électrocution.

Ne pas utiliser l'appareil dans un bain ou une douche.

- Il y a risque d'incendie ou d'électrocution.

Ne pas regarder directement dans la lentille pendant que le projecteur fonctionne.

- Une lumière intense est émise par la lentille du projecteur. Si l'on regarde directement dans cette lumière, elle risque de causer des blessures et de graves lésions aux yeux.
- Veiller particulièrement à ce que les enfants ne regardent pas dans l'objectif. En outre, éteindre le projecteur si on le laisse sans surveillance.

Ne pas placer ses mains ou autres objets près de la sortie d'air.

- De l'air chaud sort par l'ouverture de sortie d'air. Ne pas placer les mains ou la figure, ou d'autres objets qui ne peuvent résister à la chaleur près de cette sortie d'air, sinon cela peut causer des blessures ou des dommages.

Le remplacement de l'unité de lampe ne devrait être effectué que par un technicien qualifié.

- Le bloc de lampe a une haute pression interne. S'il est mal manipulé, une explosion peut s'ensuivre
- Le bloc de lampe peut être facilement endommagé s'il est cogné contre des objets durs ou si on le laisse tomber, pouvant entraîner des blessures ou des mauvais fonctionnements.

Lors du remplacement de la lampe, la laisser refroidir pendant au moins une heure avant de la manipuler.

- Le couvercle de la lampe devient très chaud, et on risque de se brûler si on le touche.

Avant de remplacer la lampe, veiller à débrancher le cordon d'alimentation de la prise de courant.

- Il y a risque d'électrocution ou d'explosion.

Attention

Ne pas obstruer les orifices d'entrée et de sortie d'air.

- Cela risque de faire surchauffer le projecteur, et causer un incendie ou endommager le projecteur.
- Ne pas installer le projecteur dans des endroits étroits, mal ventilés tels que des placards ou des rayons à livres.
- Ne pas placer le projecteur sur des tissus ou du papier, ces matériaux peuvent être aspirés dans l'orifice d'entrée d'air.

Ne pas installer le projecteur dans des endroits humides ou poussiéreux ou dans des endroits où le projecteur peut entrer en contact avec de la fumée ou la vapeur.

- L'utilisation du projecteur dans de telles conditions peut causer un incendie ou des chocs électriques.

Pour débrancher le cordon d'alimentation, tenir la fiche et non pas le cordon.

- Si le cordon d'alimentation est tiré, le cordon sera endommagé et cela peut causer un incendie, des courts-circuits ou des chocs électriques sérieux.

Débrancher toujours tous les câbles avant de déplacer le projecteur.

- Le fait de déplacer le projecteur avec des câbles branchés peut endommager les câbles, ce qui pourrait causer un incendie ou des chocs électriques.

Ne pas placer d'objets lourds sur le projecteur.

- Cela peut déséquilibrer le projecteur et le faire tomber, ce qui peut entraîner des dommages ou des blessures.

Ne pas court-circuiter, chauffer ou démonter les piles, et ne pas les mettre dans l'eau ou dans le feu.

- Sinon, les piles risqueront de surchauffer, de fuir, d'exploser ou de prendre feu, et donc de causer des brûlures ou d'autres blessures.

Lorsqu'on insère les piles, veiller à ce que les polarités (+ et -) soient bien respectées.

- Si l'on insère les piles incorrectement, elles risqueront d'exploser ou de fuir, ce qui peut causer un incendie, des blessures ou une contamination du logement des piles et de la zone environnante.

Utiliser uniquement les piles spécifiées.

- Si l'on utilise des piles incorrectes, elles risqueront d'exploser ou de fuir, ce qui peut causer un incendie, des blessures ou une contamination du logement des piles et de la zone environnante.

Isoler la pile à l'aide d'adhésif ou autre avant de la mettre au rebut.

- Si la pile entre en contact avec des objets métalliques ou d'autres piles, elle peut prendre feu ou éclater.

Ne pas peser de tout son poids sur ce projecteur.

- On risque de tomber ou de casser l'appareil, ce qui peut causer des blessures.
- Veiller tout particulièrement à ce que des enfants ne montent pas sur l'appareil.

Débrancher la fiche du cordon d'alimentation de la prise de courant comme mesure de sécurité avant d'effectuer tout nettoyage.

- Sinon cela peut causer des chocs électriques.

Demander à un centre technique agréé de nettoyer l'intérieur du projecteur au moins une fois par an.

- S'il n'est pas nettoyé et que de la poussière s'accumule à l'intérieur du projecteur, cela peut causer un incendie ou des problèmes de fonctionnement.
- Il est recommandé de nettoyer l'intérieur du projecteur avant que la saison humide n'arrive. Demander au centre technique agréé le plus proche de nettoyer le projecteur lorsque cela est requis. Se renseigner auprès du centre technique agréé pour le coût du nettoyage.

Nous faisons tous les efforts possibles afin de préserver l'environnement. Prière d'apporter l'appareil, s'il n'est pas réparable, à votre revendeur ou à un centre de recyclage.

Avant l'utilisation

Précautions à prendre lors du déplacement du projecteur

Veiller à bien mettre le capuchon d'objectif en place avant de déplacer le projecteur.

L'objectif de projection est très sensible aux vibrations et aux chocs. Lorsqu'on déplace le projecteur, utiliser la sacoche de transport fournie. Lorsqu'on place le projecteur dans la sacoche de transport, le placer de façon que l'objectif soit orienté vers le haut.

Avertissements concernant l'installation

Éviter de l'installer dans les endroits sujets à des vibrations ou à des chocs.

Les pièces internes peuvent être endommagées, ce qui peut causer des pannes ou des accidents.

Ne pas installer le projecteur près de lignes d'alimentation électrique à haute tension ou de moteurs.

Le projecteur peut être soumis à des interférences électromagnétiques.

Si le projecteur est installé au plafond, demander à un technicien qualifié de faire tous les travaux d'installation.

Il faut acheter le kit d'installation séparé (numéro de modèle: ET-PKC80). En outre, tous les travaux d'installation doivent être exécutés uniquement par un technicien qualifié.

Si l'on utilise ce projecteur à un endroit élevé (au-dessus de 1400 m), régler le VENTILATEUR à FORT. (Se référer à la page 43.)

Sinon, des anomalies pourront se produire.

Notes sur l'utilisation

Afin d'obtenir la meilleure qualité d'image

Fermer les rideaux ou les volets de toutes les fenêtres et éteindre les lampes fluorescentes situées à proximité de l'écran afin que la lumière extérieure ou la lumière des lampes intérieures n'éclaire pas l'écran.

Ne pas toucher aux surfaces de la lentille avec les mains nues.

Si la surface de la lentille est salie par des empreintes digitales ou autre, ceci sera agrandi et projeté sur l'écran. D'ailleurs, lorsque le projecteur n'est pas utilisé, rétracter la lentille, puis la couvrir à l'aide du capuchon d'objectif fourni.

À propos de l'écran

N'appliquer aucun produit volatil qui risque de décolorer l'écran, et veiller à ce que l'écran ne soit pas sale ou endommagé.

A propos de la lampe

Il est possible qu'il faille remplacer la lampe plus tôt en raison de facteurs variables comme les caractéristiques de la lampe, des conditions d'utilisation et un environnement d'installation particuliers, en particulier si elle est utilisée de façon continue pendant plus de 10 heures ou si l'alimentation est fréquemment mise en et hors circuit.

Remplacement du bloc de lampe

AVERTISSEMENT

Le bloc de lampe ne devrait être remplacé que par un technicien qualifié.

Lors du remplacement de la lampe, la laisser refroidir pendant au moins une heure avant de la manipuler.

- Le couvercle de la lampe devient très chaud, et on risque de se brûler si on le touche.

Notes sur le remplacement du bloc de lampe

- Faire très attention en manipulant le bloc de lampe retiré, car il contient du gaz sous haute pression et peut facilement s'endommager s'il est cogné contre des objets durs ou s'il tombe.
- La lampe produisant la lumière est en verre; elle risque donc d'éclater si on la laisse tomber ou si elle heurte des objets durs. Faire bien attention en manipulant la lampe.
- La lampe usagée qu'on a retirée risque d'éclater si on la jette sans prendre de précautions. Jeter la lampe de la même manière qu'une lampe fluorescente.

REMARQUE:

- Le projecteur n'est pas fourni avec un bloc de lampe de rechange. Demander les détails au revendeur. Numéro de produit du bloc de lampe: **ET-LAC80**

ATTENTION:



- Ne pas utiliser un bloc de lampe avec un numéro de pièce autre que celui indiqué ci-dessus.

Période de remplacement du bloc de lampe

La lampe est un produit qui doit être remplacé. Même si la durée de vie complète de l'ampoule n'est pas encore épuisée, la luminosité de la lampe diminuera progressivement. Il faut donc remplacer périodiquement la lampe. L'intervalle de remplacement de la lampe prévu est de 2000 heures; il est toutefois possible qu'il faille remplacer la lampe avant ce délai en raison d'éléments variables comme les caractéristiques particulières de la lampe, les conditions d'utilisation et l'environnement d'installation. Il est recommandé de toujours avoir un bloc de lampe de rechange prêt à l'emploi. Une lampe qui a dépassé la limite de 2000 heures d'utilisation risque beaucoup plus d'exploser. Afin d'éviter que la lampe explose, celle-ci est éteinte automatiquement lorsque la limite de 2000 heures d'utilisation est atteinte.

REMARQUE:

- Les heures d'utilisation expliquées ci-dessus concernent l'utilisation lorsque le réglage FORTE a été sélectionné pour PUIS.LAMPE dans le menu OPTION2. Si le réglage FAIBLE est sélectionné, la luminosité de la lampe sera moindre et la durée de vie de la lampe sera allongée.
- Bien que le délai de 2000 heures soit l'intervalle de remplacement prévu, l'obtention de cette durée n'est pas couverte par la garantie.

	Affichage à l'écran 	Témoin d'alarme de l'indicateur de la lampe 
Plus de 1800 heures	Affiché pendant 30 secondes. L'affichage disparaît si l'on appuie sur n'importe quelle touche.	Le projecteur passe en mode d'attente et l'indicateur rouge s'allume.
Plus de 2000 heures	L'affichage ne peut pas être effacé, quelle que soit la touche sur laquelle on appuie.	

Méthode de remplacement du bloc de lampe

REMARQUE:

- Si le temps d'utilisation de la lampe a dépassé 2000 heures (lorsque PUIS.LAMPE a été mis sur "FORTE"), le projecteur passe en mode d'attente après environ dix minutes de fonctionnement. Dès lors, faire les étapes) 7 à) 11 à la page suivante dans les 10 minutes.

- 1 Mettre hors circuit l'interrupteur d'alimentation principale (MAIN POWER) suivant la méthode donnée dans "Mise hors circuit de l'alimentation" à la page 24, puis débrancher la fiche du cordon d'alimentation de la prise de courant et vérifier que les pièces autour du bloc de lampe se sont refroidies.
- 2 Utiliser un tournevis Phillips pour desserrer les vis de fixation du couvercle du bloc de lampe sur le fond du projecteur, puis enlever le couvercle du bloc de lampe.

Couvercle de l'unité de lampe

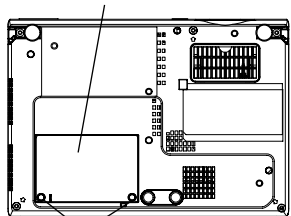

Vis de fixation du couvercle du bloc de lampe

- 3 Utiliser un tournevis Phillips pour desserrer les deux vis de fixation du bloc de lampe jusqu'à ce que les vis tournent librement. Tenir la poignée du bloc de lampe et tirer doucement pour le sortir du projecteur.

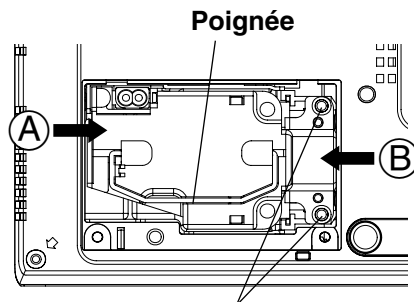

Vis de fixation du bloc de lampe

- 4 Insérer le nouveau bloc de lampe tout en s'assurant que le sens d'insertion est correct, puis utiliser un tournevis Phillips pour resserrer fermement les vis de fixation du bloc de lampe. Lors de l'insertion du bloc de lampe neuf, veiller à le pousser aux points A et B.

- 5 Installer le couvercle du bloc de lampe, puis utiliser un tournevis Phillips pour resserrer fermement les vis de fixation du couvercle du bloc de lampe.

REMARQUE:

- S'assurer de bien installer le bloc de lampe et le couvercle du bloc de lampe. S'ils ne sont pas bien installés, cela peut déclencher le circuit de protection et le projecteur ne pourra pas être allumé.

- 6 Insérer la fiche du cordon d'alimentation dans la prise de courant, puis appuyer sur l'interrupteur d'alimentation principale (MAIN POWER).

REMARQUE:

- Si l'indicateur d'alimentation (POWER) ne s'allume pas en rouge lorsque l'interrupteur d'alimentation principale (MAIN POWER) est mis sur la position de marche, remettre l'interrupteur d'alimentation principale (MAIN POWER) sur la position d'arrêt, débrancher le cordon d'alimentation de la prise murale et s'assurer que le bloc de lampe et que le couvercle du bloc de lampe sont bien installés. Puis remettre l'interrupteur d'alimentation principale (MAIN POWER) sur la position de marche.

- 7 Appuyer sur la touche d'alimentation (POWER) pour projeter une image sur l'écran.
- 8 Appuyer sur la touche de menu (MENU) pour afficher l'écran de MENU PRINCIPAL, puis appuyer sur les touches ▲ et ▼ pour déplacer le curseur et sélectionner "OPTION2".

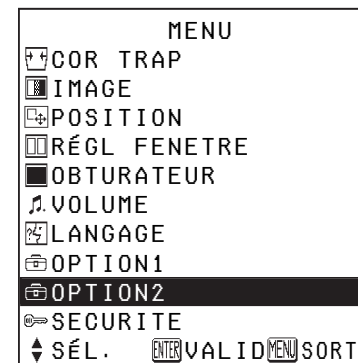

- 9 Appuyer sur la touche d'entrée (ENTER) pour afficher le menu OPTION2, puis utiliser les touches ▲ et ▼ pour sélectionner DURÉE LAMPE.

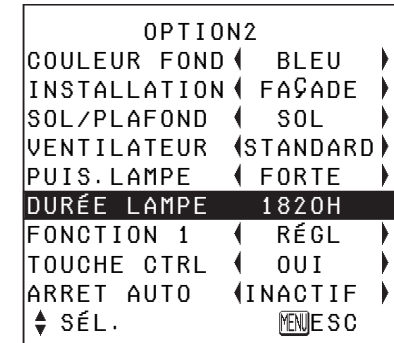

- 10 Maintenir la touche d'entrée (ENTER) enfoncée pendant environ 3 secondes.

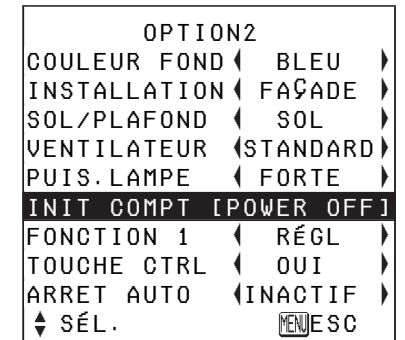

"DUREE LAMPE" changera à "INIT COMPT [POWER OFF]".

REMARQUE:

- Si la touche de menu (MENU) est pressée, l'écran de remise à zéro de la durée de lampe sera annulé.

- 11 Couper l'alimentation électrique. Le temps d'utilisation total du bloc de lampe est alors remis à zéro. Pour plus de détails concernant la mise hors tension, se reporter à la page 24.

Panasonic[®]

Professional/Industrial Video

Panasonic Broadcast & Television Systems Company

Division of Matsushita Electric Corporation of America

One Panasonic Way 4E-7 Secaucus, NJ 07094 (201) 392-4443
3330 Cahuenga Blvd West Los Angeles, CA 90068 (323) 436-3500

Technical Support:

(800) 524-1448

(800) 526-6610

FAX: (201) 392-6514

E-Mail: pbtssupport@panasonic.com

Printed in Japan
S0303-3053D