

**COMPAQ**

**Compaq iPAQ Microportable  
Projector MP3800**  
User's Guide

Document Part Number: 281124-001

**June 2002**

© 2002 Compaq Information Technologies Group, L.P.

Compaq, the Compaq logo, and iPAQ are trademarks of Compaq Information Technologies Group, L.P. in the United States and/or other countries.

Microsoft, MS-DOS, Windows, Windows NT are trademarks of Microsoft Corporation in the United States and other countries.

All other product names mentioned herein may be trademarks of their respective companies.

Compaq shall not be liable for technical or editorial errors or omissions contained herein. The information in this document is provided “as is” without warranty of any kind and is subject to change without notice. The warranties for Compaq products are set forth in the express limited warranty statements accompanying such products. **Nothing herein should be construed as constituting an additional warranty.**

Compaq service tool software, including associated documentation, is the property of and contains confidential technology of Compaq Computer Corporation. Service customer is hereby licensed to use the software only for activities directly relating to the delivery of, and only during the term of, the applicable services delivered by Compaq or its authorized service provider. Customer may not modify or reverse engineer, remove, or transfer the software or make the software or any resultant diagnosis or system management data available to other parties without Compaq’s or its authorized service provider’s consent. Upon termination of the services, customer will, at Compaq’s or its service provider’s option, destroy or return the software and associated documentation in its possession.



**WARNING:** Text set off in this manner indicates that failure to follow directions could result in bodily harm or loss of life.

---



**CAUTION:** Text set off in this manner indicates that failure to follow directions could result in damage to equipment or loss of information.

---

Compaq iPAQ Microportable Projector MP3800 User’s Guide  
First Edition June 2002  
Document Part Number: 281124-001

---

# Getting Started

## Product Features

The Compaq *iPAQ*<sup>™</sup> Microportable Projector MP3800 generates crisp, clear images onto a projection screen by using Digital Light Processing (DLP) technology. The microportable projector offers the latest in portable projection technology, including:

- 1024 x 768 native XGA resolution
- Maximum resolution: 1280 x 1024 (SXGA)
- High Definition Television (HDTV) capable 720p, 1080i, 480p, and 480i via VGA port
- User replaceable high-efficiency, long-life lamp
- Zoom lens
- High brightness with lamp saver mode for longer lamp life
- Mono speaker
- Screw for either tripod or ceiling mount
- Optimum weight (under 4.0 pounds/2.0 kg)
- Convenient resync capability
- 16.7 million displayable colors

- Available interfaces:
  - Standard analog VGA
  - DVI
  - S-video/composite video via DVI connector
  - Component/HDTV via VGA connector
  - Audio-in
  - USB for remote mouse functions
- Full-featured remote control with remote mouse and laser pointer
- Home Theater Kit [available option]
  - DVI-Composite/S-video cable
  - VGA-to-HDTV/Component video cable
  - PC/RCA stereo audio cables
- Multilingual on-screen adjustment menu
- Plug and Play capability
- Security lock slot

## Introduction

Before setting up your Compaq Microportable Projector, be sure your shipping box includes the following items:

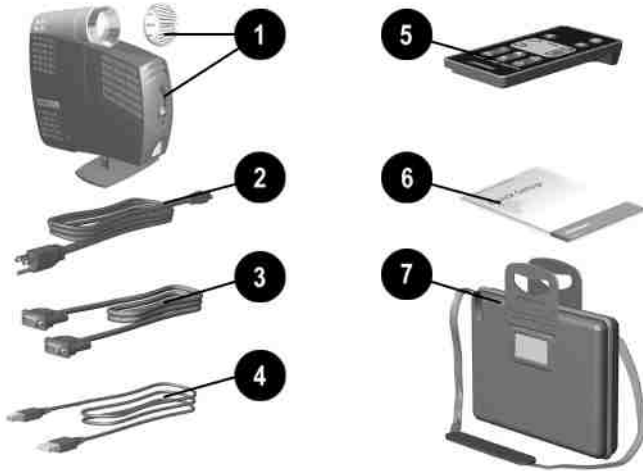

- ❶ Projector and lens cap
- ❷ 10-foot power cable
- ❸ VGA signal cable for use with computers, notebooks, and some handheld products
- ❹ USB cable
- ❺ Remote control (battery included)

*(Continued)*

- ⑥ Documentation kit:
  - Projector Setup Guide
  - CD-ROM containing the multilingual *User's Guide*
  - *Important Safety Information* booklet
  - *Worldwide Limited Warranty and Technical Support* booklet
  - *Worldwide Telephone Numbers* booklet
  - Program License Agreement
- ⑦ ■ Carrying case

If your shipping box does not contain all of the listed items, please contact your Compaq authorized dealer, reseller, or service provider.

## Identifying the Projector Buttons

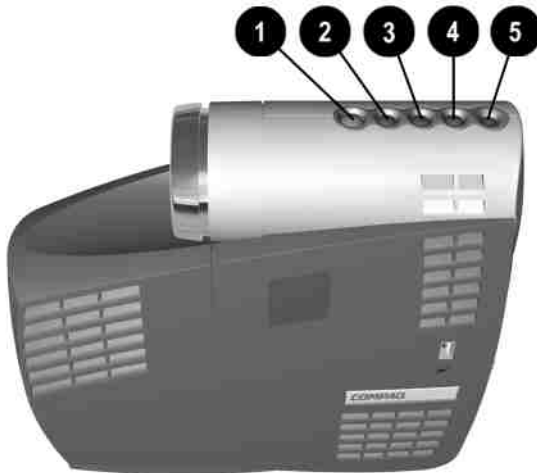





### Identifying the Projector Buttons

Item	Symbol	Control	Function
1		<b>Power/Standby</b> button	<p>Powers the projector lamp on and off. The Power/Standby LED changes color modes to indicate the following operating modes:</p> <ol style="list-style-type: none"> <li>1. Flashing green indicates the projector is going into standby mode and cannot be restarted until the LED glows amber steadily.</li> <li>2. The LED button rapidly flashing green indicates the lamp has automatically shut down due to an overtemperature event.</li> <li>3. A steady amber LED indicates the projector is ready to power-up.</li> <li>4. A steady green LED indicates the projector is on and operating properly.</li> </ol>

---

## Identifying the Projector Buttons (*Continued*)

---

Item	Symbol	Control	Function
②		<b>Menu</b> button	<ol style="list-style-type: none"> <li>1. Press this button once to start the on-screen display menu.</li> <li>2. Press it again to select an item on the menu.</li> <li>3. If pressed after selecting “yes” or “no” to a question, the request will be processed and the menu will go one level higher.</li> <li>4. If pressed after changing an adjustment scale, the new information will be saved and the menu will go one level higher.</li> </ol>
③		<b>Plus</b> button	Selects and adjusts the on-screen scroll-up menu functions.
④		<b>Minus</b> button	Selects and adjusts the on-screen scroll-down menu functions.
⑤		<b>Resync</b> button	Automatically synchronizes the projector to track the input source.

---

To use standby mode, press the **Power/Standby** button and, after a six to ten second delay, the unit enters Standby mode and the projector lamp turns off. A “Going to Standby” message appears on the screen for the duration of the six to ten second delay. When the message disappears from the screen, there is a 45 second delay before the lamp can be turned back on. Wait 45 seconds to allow the lamp to cool before pressing the **Power/Standby** button again. To avoid going to Standby, press the **Power/Standby** button again within the first five seconds.



## Identifying the Projector Components

A variety of cables can be connected to the projector, allowing the use of various audio and video sources.

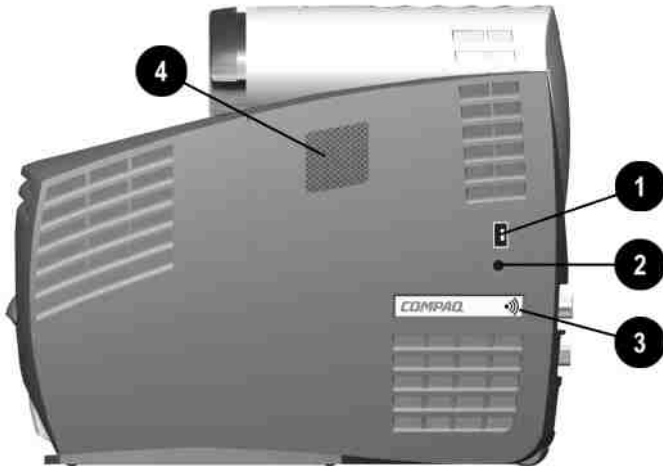

### Identifying the Side Projector Components

Item	Symbol	Component	Function
①	⏏	USB connector	Connects back to the computer allowing remote mouse functionality.
②	🔊	Audio-in connector	Connects audio equipment, videocassette recorders, DVD players, personal computers, etc., allowing sound to be played through the projector speaker.
③	📡	Infrared receiver (both sides of projector)	Receives infrared signals from the remote control. Point the remote control at these spots to make it work.
④		Speaker	Allows audio equipment to play through the projector.

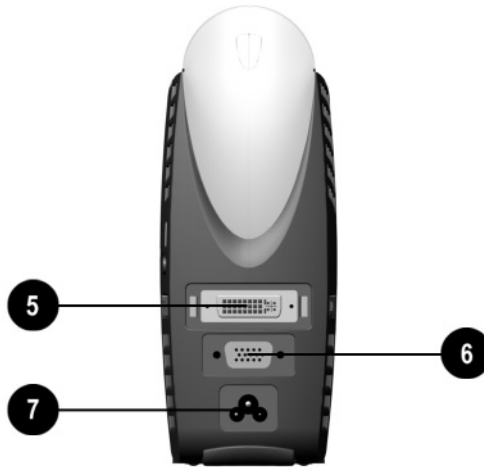

---

### Identifying the Rear Projector Components

---

Item	Symbol	Component	Function
5	DVI	DVI connector	Connects digital equipment.
6	□	VGA Connector	Connects desktop or notebook computers, or pocket PCs.
7	~	Power connector	Connects the power cable.

---

The optional Home Theater Kit provides standard video and HDTV connections using the DVI and VGA ports. Refer to Chapter 6, “Using the Home Theater Kit,” for more information.

---

## Using the Projector

### Setting Up the Projector

Follow the instructions below and on the following pages to set up the projector. Separate setup instructions are described for the following products:

- Notebook computers
- Desktop computers
- Compaq iPAQ Pocket PC with VGA capability

The projector is hot pluggable and can be connected to any input source while the source is in use.

Place the projector on a stable desk, table, tripod, or ceiling mount at a distance not less than 3.7 feet (1.1 meters) and not greater than 32.8 feet (10.0 meters) from the projection screen.



**WARNING:** To reduce the risk of electric shock or damage to your equipment:

- Do not disable the power cord grounding plug. The grounding plug is an important safety feature.
  - Plug the power cord into a grounded (earthed) electrical outlet that is easily accessible at all times.
  - Disconnect power from the projector by unplugging the power cord from the electrical outlet.
  - Do not place anything on power cords or cables. Arrange them so that no one may accidentally step on or trip over them. Do not pull on a cord or cable. When unplugging from the electrical outlet, grasp the cord by the plug.
-

## Balancing the Projector

The projector has a built-in elevator foot used to balance and elevate the projector. Always balance the projector before connecting any device to it.

Turn the elevator foot sideways to balance the projector.



**WARNING:** To reduce the risk of the projector tipping or overturning, always turn the elevator foot 90° from its original position before pressing the elevator button. Refer to the “Adjusting the Projector Height” section later in this chapter.

---



**CAUTION:** If the projector is mounted to a tripod, do not use the elevator foot.

---

## Connecting the Projector to a Notebook Computer

1. Connect one end of the projector signal cable into the back of the projector and the other end to the DVI connector **1A** or the VGA connector **1B** on the notebook computer and tighten the screws.



Be sure the signal cable aligns with the connector. Do not force the cable onto the connector or you may damage the signal cable or the projector.

2. Connect one end of the power cord **2** into the back of the projector, and the other end to an electrical outlet that is easily accessible and close to the projector.

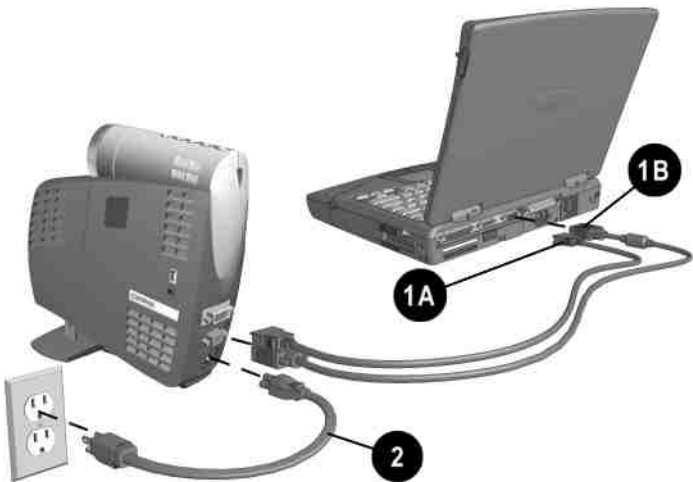

## Connecting the Projector to a Desktop Computer

1. Connect one end of the projector signal cable into the back of the projector and the other end to the DVI connector **1A** or the VGA connector **1B** on the desktop computer and tighten the screws.



Be sure the signal cable aligns with the connector. Do not force the cable onto the connector or you may damage the signal cable or the projector.

---

2. Connect one end of the power cord **2** into the back of the projector, and the other end to an electrical outlet that is easily accessible and close to the projector.

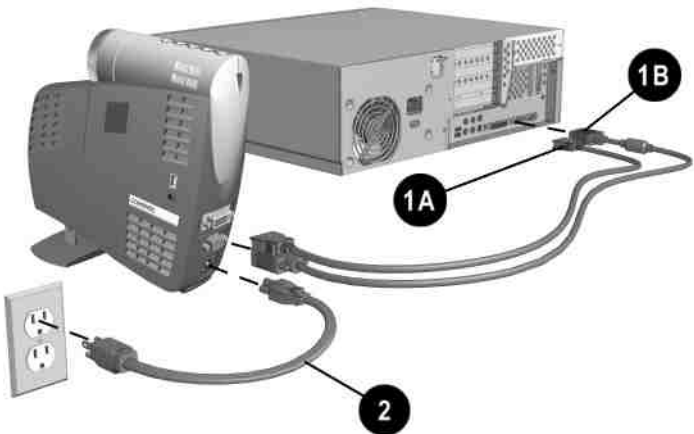

## Connecting the Projector to a Compaq iPAQ Pocket PC

To connect the projector to a Compaq iPAQ Pocket PC, the Pocket PC must have a male connector adapter and a VGA-out PC Card with a 15-pin connector.

The VGA-out PC Card with the 15-pin connector is not included with the Compaq iPAQ Pocket PC. For information on purchasing the optional VGA-out PC Card, contact your Compaq authorized dealer or reseller. To locate a reseller near you, refer to the *Worldwide Telephone Numbers* booklet that came with your projector or, to purchase directly from Compaq, refer to the Compaq website at <http://www.compaq.com/products/iPAQ>.

1. Connect one end of the signal cable ❶ into the back of the projector and connect the other end to the VGA-out PC Card. The VGA-out PC Card may be inserted into the PC slot on the Compaq Pocket PC before or after connecting the signal cable.



Be sure the signal cable aligns with the connector. Do not force the cable onto the connector or you may damage the signal cable or the projector.

2. Connect one end of the power cord ❷ into the back of the projector, and the other end to an electrical outlet that is easily accessible and close to the projector.

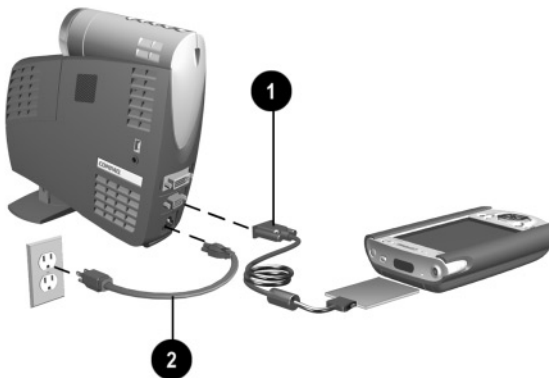

## Powering On the Projector

1. Make sure the power cord and signal cable are securely connected.
2. Make sure the projector is perpendicular to the projection screen.



---

If the projector cannot be placed perpendicular to the screen, use the Image Control adjustment in the OSD menu to adjust horizontal keystoneing. Refer to Chapter 3, “Using the On-Screen Display Menu,” for more information

---

3. Remove the lens cap **1** from the projector by pressing in on the tabs on either side of the lens cap and pulling it straight out.
4. Press the **Power/Standby** button **2** on the top of the projector.

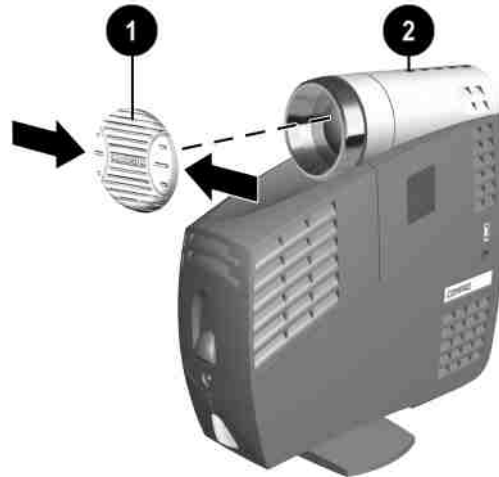

When the projector has warmed up, the Compaq startup screen displays and the LED on the **Power/Standby** button turns green.



5. Power on your source (computer, Pocket PC, VCR, etc.) and launch the software application being used to display images on the projection screen. If applicable, press the Function key on the computer designated for external display.



When the startup screen disappears, the video from the attached computer displays. If there is no incoming video, the “No Source Found. Please Check Signal Cable” message will display on the projection screen.

---

## Powering Off the Projector

1. Press the **Power/Standby** button **1** to turn off the projector lamp.

The message “Going to Standby” displays and the LED on the **Power/Standby** button blinks amber. Allow the projector to cool down.



**CAUTION:** Wait until you see a steady amber LED (approximately 45 seconds) before turning the projector back on. Failure to follow this caution can result in damage to the projector.

---

2. Once the **Power/Standby** LED has turned steady amber, disconnect the power cord from the electrical outlet and the projector **2**.

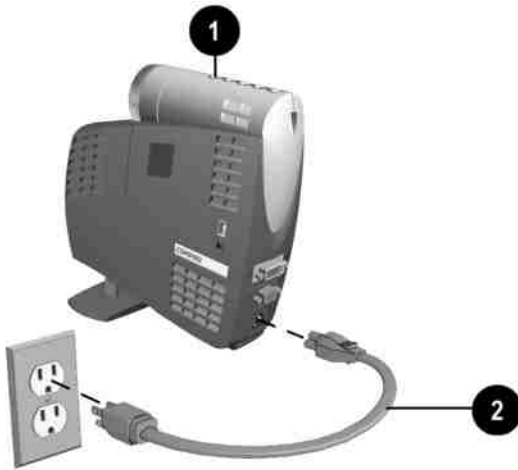

## Adjusting the Projected Image

There are three ways to adjust the projected image:

- Adjusting the projector height
- Adjusting the image size
- Adjusting the projector focus

## Adjusting the Projector Height

The projector has a built-in elevator foot that can raise the projector approximately 1 inch (2.54 cm).



**CAUTION:** If the projector is mounted to a tripod, do not use the elevator foot.

To adjust the height:

1. Raise the projector to the desired display angle, then press the elevator button **1** to release the elevator foot **2**.

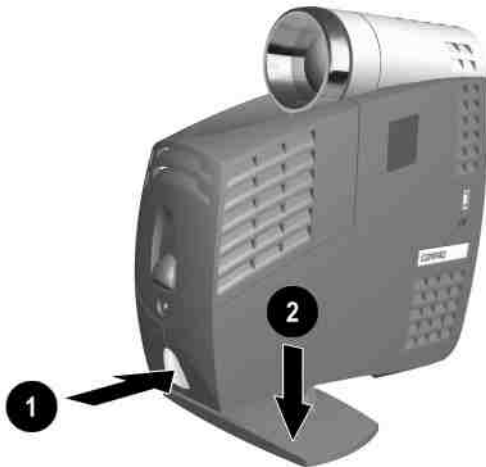

2. To lower the display angle, press the elevator button again and press down on the projector to lower it.



**CAUTION:** Failure to press the elevator button before adjusting the elevator foot can result in damage to the elevator mechanism.

---

The projector is capable of correcting for vertical keystone (trapezoidal) distortion caused when the projector is tilted upward or downward from its normal horizontal position. This feature corrects keystone by making the width of the top and bottom of the screen the same. Access this feature using the Image Control selection of the on-screen display (OSD) menu. Refer to Chapter 3, “Using the On-Screen Display Menu,” for more information. The keystone effect can be corrected when the projector is tilted upward up to 30 degrees or downward up to 40 degrees.

The projector can also correct for horizontal keystone (trapezoidal) distortion caused when the projector is not placed perpendicular to the screen. This correction can also be made using the Image Control selection of the OSD menu.

## Adjusting the Image Size

The projector zoom feature is capable of increasing the image size up to 20%. To increase or decrease the image size, turn the projector zoom ring left or right.

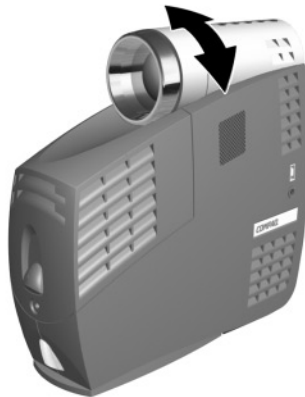

## Adjusting the Projector Focus

To focus the projected image, rotate the focus ring ❶ until the image is clear. The projector will focus at distances from 3.7 feet (1.1 meters) to 32.8 feet (10.0 meters).

If vertical bars appear on the display after adjusting the focus, press the **Resync** button ❷ to automatically synchronize and track the display. If the button does not correct the display, use the Image Control menu item in the on-screen display menu to manually adjust the synchronization and tracking. Refer to Chapter 3, “Using the On-Screen Display Menu,” for more information.



## Image Size Adjustment

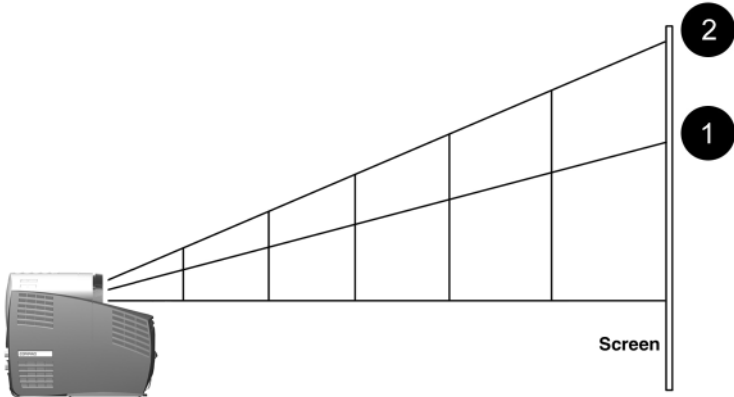

### Projected Image Sizes at Minimum Zoom ①

<b>Projection Distance</b>	3.7'	6.5'	13.1'	16.4'	23.0'	26.3'	32.8'
	1.1 m	2.0 m	4.0 m	5.0 m	7.0 m	8.0 m	10.0 m
<b>Screen Diagonal</b>	1.9'	3.3'	6.7'	8.4'	11.8'	13.4'	16.8'
	0.6 m	1.0 m	2.0 m	2.6 m	3.9 m	4.1 m	5.1 m
<b>Screen Width</b>	1.5'	2.7'	5.4'	6.7'	9.4'	10.8'	13.5'
	0.5 m	0.8 m	1.6 m	2.0 m	2.9 m	3.3 m	4.1 m
<b>Screen Height</b>	1.1'	2.0'	4.0'	5.0'	7.1'	8.1'	10.1'
	0.3 m	0.6 m	1.2 m	1.5 m	2.2 m	2.5 m	3.1 m

### Projected Image Sizes at Maximum Zoom ②

<b>Projection Distance</b>	3.7'	6.5'	13.1'	16.4'	23.0'	26.3'	32.8'
	1.1 m	2.0 m	4.0 m	5.0 m	7.0 m	8.0 m	10.0 m
<b>Screen Diagonal</b>	2.3'	4.0'	8.0'	10.0'	14.1'	16.1'	20.2'
	0.7 m	1.2 m	2.5 m	3.1 m	4.3 m	4.9 m	6.2 m
<b>Screen Width</b>	1.8'	3.2'	6.4'	8.0'	11.3'	12.9'	16.1'
	0.6 m	1.0 m	2.0 m	2.5 m	3.4 m	3.9 m	5.0 m
<b>Screen Height</b>	1.4'	2.4'	4.8'	6.0'	8.5'	9.7'	12.1'
	0.4 m	0.7 m	1.5 m	1.8 m	2.6 m	3.0 m	3.7 m

---

## Using the On-Screen Display Menu

### Introducing the On-Screen Display Menu

The adjustments for screen settings are located in the on-screen display (OSD) menu and can be viewed in one of the available languages. You can change these settings whenever you like by accessing the OSD. All settings are stored in Electrically Erasable Programmable Read Only Memory (EEPROM), a memory device which stores data even when the projector is turned off.



The projector does not require a battery to store your settings.

---

## Adjusting the On-Screen Display Menu

To launch and make adjustments to the OSD menu:

1. Press the **Menu** button **1** on the projector or the remote control. The Main menu will display on the projection screen.
2. To select a function, press the **Plus (+)** button **2** to scroll up the OSD menu. To reverse the scroll direction, press the **Minus (-)** button **3**.
3. Highlight the function to be adjusted and press the **Menu** button **1** again.

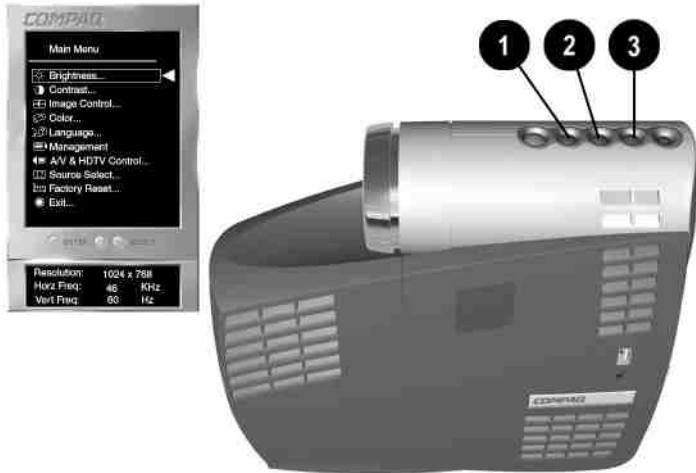

The bar on the bottom of the on-screen display menu shows the current operating resolution as well as horizontal and vertical frequency.



## Sample On-Screen Display Menu Adjustment

Below is an example of how to operate the on-screen display menu.

1. To select the **Image Control** function, press the **Minus (-)** button until **Image Control** is highlighted, then press the **Menu** button on the projector to display the level 2 menu for **Image Control**. The level 2 menu displays expanded menu items.
2. To make a selection from the level 2 menu, press the **Minus (-)** button to scroll down the level 2 menu, or press the **Plus (+)** button to reverse the scroll direction.
3. Highlight the selection and press the **Menu** button to confirm the selection. The level 3 menu displays.
4. Level 3 for **Image Control** functions display the adjustment scales. Use the **Minus (-)** button to decrease and the **Plus (+)** button to increase the screen Horizontal and Vertical positions.



Some menu functions display adjustment scales in the level 2 menu, while others display adjustment scales in the level 3 or level 4 menus.

---

5. After making the adjustment, select **Save and Return**. To void any changes made, select **Cancel** instead of **Save and Return**.

If the buttons remain untouched for 5 seconds, all current settings will be saved and the on-screen display menu will exit.

---

## On-Screen Display Menu Adjustments

---

Main Menu	Menu Level 2	Menu Level 3		
Brightness	Adjustment Scale			
Contrast	Adjustment Scale			
Image Control	Horizontal Position	Adjustment Scale		
	Vertical Position	Adjustment Scale		
	Clock	Adjustment Scale		
	Clock Phase	Adjustment Scale		
	Zoom		Zoom	
			Panning Left-Right	
			Panning Up-Down	
			Save and Return	
			Cancel	
		Vertical Keystone	Adjustment Scale	
		Horizontal Keystone	Adjustment Scale	
		Flip Image		Horizontal
				Vertical
				Both
	Save and Return			
	Cancel			
	Save and Return			
	Cancel			

---

---

**On-Screen Display Menu Adjustments (Continued)**

---

<b>Main Menu</b>	<b>Menu Level 2</b>	<b>Menu Level 3</b>
Color	7400 K (default)	
	Custom Color	Red
		Green
		Blue
		Sharpness
		Save and Return
		Cancel
	Video Adjustments	Saturation
		Sharpness
		Tint
		Save and Return
		Cancel
		Save and Return
	Cancel	
Language	Deutsch	
	English	
	Español	
	Français	
	Italiano	
	Nederlands	
	Japanese	
	Chinese	
	Save and Return	
	Cancel	
Management	Lamp Hours	Display lamp hours
	Horizontal OSD Position	Adjustment Scale
	Vertical OSD Position	Adjustment Scale
	OSD Timeout	Adjustment Scale
	OSD Transparency	Adjustment Scale
	Save and Return	
	Cancel	

---

---

### On-Screen Display Menu Adjustments (*Continued*)

---

Main Menu	Menu Level 2	Menu Level 3
A/V & HDTV Control	HDTV/Video	Fill to Screen
		Fill to Aspect Ratio
	Color Space	Center Image
		RGB
		Y Pb Pr
Audio	Y Cb Cr	Y Cb Cr
		Mute
	Volume	
	Bass	
	Treble	
Gamma	Save and Return	Save and Return
		Cancel
	Adjustment Scale	Adjustment Scale
Input Source Select	Analog RGB (VGA)	
	Composite Video	
	Super Video	
	Component Video 480i	
	HDTV 480p 720p 1080i	
	Digital RGB (DVI)	
Factory Reset	Yes	
	No	
Exit		

---

## Explaining Functions in the On-Screen Display Menu

- **Brightness**—Adjusts the displayed image brightness. The default brightness value is 50%, and the settings range from 0 to 100. Press the **Minus** (-) button to darken the image. Press the **Plus** (+) button to brighten the image.
- **Contrast**—Adjusts the displayed image contrast by changing the amount of black and white in the image. The default contrast value is 50%, and the settings range from 0 to 100. Press the **Minus** (-) button to decrease the contrast. Press the **Plus** (+) button to increase the contrast.
- **Image Control**—Improves picture stability of user modes by adjusting:
  - ❑ Horizontal and Vertical Position—Fine-tunes the horizontal and vertical positions of the display.
  - ❑ Clock—Increases/decreases the value to stretch or shrink the image on the screen. This selection is not available when a source is connected to the DVI connector.
  - ❑ Clock Phase—Increases/decreases the value to minimize video distortion or video jitter. This selection is not available when a source is connected to the DVI connector.



If the projector image becomes distorted when adjusting the Clock and Clock Phase values, continue adjusting the values until the distortion disappears. To restore the factory settings, select Factory Reset in the on-screen display menu, or press the **Resync** button to get the optimal parameters for the selected display mode.

---

- ❑ **Zoom**—Magnifies an image up to a factor of 32 on the projection screen (zooms in to a specific area on the screen, and pans left, right, up, and down).

- Vertical Keystone**—Adjusts image distortion at the top and bottom widths of the screen caused by the projector being at an angle to the screen.
- Horizontal Keystone**—Adjusts image distortion at the left and right sides of the screen caused by tilting the projector.
- Flip Image**—Allows the projected image to be rotated or mirrored.
- **Color**—Adjusts color balance to compensate for ambient conditions using three submenus:
  - 7400 K**—Factory default
  - Custom Color**—Modifies the color temperature balance. Displayed only when VGA sources are displayed. You can independently adjust the red, green, and blue colors using this selection.



If Custom Color is modified and saved, this selection will not be reset if the Factory Reset selection is later used. To restore factory color settings, select 7400 K.

---

- Video Adjustments**—Modifies the color intensity. Displayed only when video sources are displayed.
- **Language**—Allows you to change the on-screen display to one of the languages in their native spelling. The current language is highlighted. Select another language to display all menu functions in that language.

- **Management**—Allows you to control vertical and horizontal keystoneing, view the cumulative lamp hours, or set the OSD horizontal and vertical position, timeout, and transparency.



By default, the OSD menu is on top of the displayed image. Selecting OSD Transparency from the Management menu allows you to adjust this setting so the displayed image can be seen behind the OSD menu. Changes can be seen as they are being made.

- **A/V & HDTV Control**—Allows you to stretch the format to fill the screen or to use the original aspect ratio and fill the screen, using HDTV (High Definition Television) format. Refer to the “HDTV Modes” section of Chapter 6 for more information. Also allows color space selection, audio preference selection, and Gamma adjustment.
- **Input Source Select**—Allows you to select which source to display. If the selected source is not available, the original source will be displayed again. You may also cycle through available sources by pressing the **Source** button on the remote control.
- **Factory Reset**—Resets all previously saved user settings to the original factory settings.

## Special On-Screen Messages

Special on-screen messages will appear on the projection display to identify the following conditions:

- **No Source Found. Please Check Signal Cable**—Indicates the video cable may not be plugged into the projector or the selected video input is not accurate.
- **Input Signal Out of Range. Please Change Display Mode**—Indicates the projector is unable to access the appropriate input signal.
- **Going to Standby**—Indicates the projector is entering a sleep mode or is powering off the lamp.

- **Adjusting**—Indicates the **Resync** button has been pressed or the Factory Reset option has been selected from the OSD menu. The message will disappear when the appropriate mode is detected and displayed by the projector.
- **Multiple inputs are active. Use the OSD to select the alternate sources**—The projector has detected multiple inputs. This message may appear when powering up, returning from Standby, or when the **Source** button is pressed on the remote control. If no selection is made within 10 seconds, the currently displayed source will remain as the active source. Press the **Source** button on the remote control to review and select from the active video sources.
- **Lamp May Fail Soon. Replacement Suggested**—Indicates the lamp is approaching failure. The message will remain on the screen for 10 seconds or until the on-screen **Menu** button is pressed. This message appears once when powering up or returning from Standby until the lamp is replaced. After the lamp is changed, access the Service menu to reset the lamp hours counter. Refer to the “Replacing the Projector Lamp Module” section of Chapter 7 for information on resetting the lamp hours counter.



The 10-second timeout is the default value. To change the timeout value, select the Management menu, select the OSD Timeout menu, and change the timeout from 1 to 40 seconds.

---



When the projector is started, the Compaq banner displays for approximately 10 seconds. To skip this banner display, turn off the function using the OSD menu.

---



---

## Using the Tripod Mount

The Compaq Microportable Projector includes standard tripod mount capability on the bottom of the projector. This allows the projector to be mounted on tripods readily available at camera and other electronic stores.



**WARNING:** The tripod should be capable of supporting a weight of at least five pounds. Refer to the owner's manual that came with your tripod for more information.

---



**CAUTION:** Do not overtighten the tripod mount screw. Doing so could strip the screw and cause the projector to fall off the tripod.

---

To connect the projector to the tripod:

1. If necessary, remove the tripod mounting block from the tripod.
2. If there is a guide pin on the tripod mounting block, align it with the guide pin hole ❶ on the bottom of the projector.
3. Attach the tripod mounting block to the tripod mount hole ❷ on the bottom of the projector.

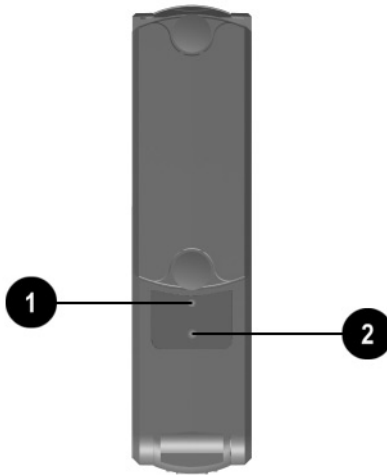

4. Attach the projector and tripod mounting block to the tripod according to the tripod manufacturer's instructions.

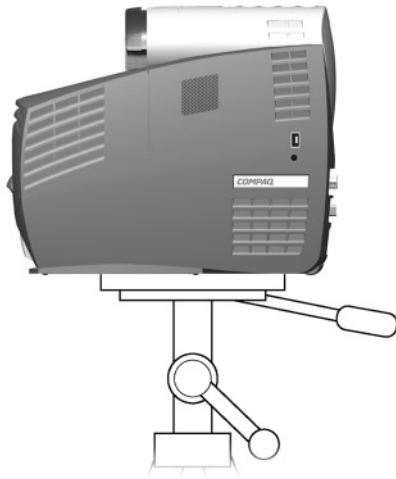

The projector can also be used in a ceiling-mount application using the tripod mount screws.

---

---

## Using the Remote Control

The optional remote control has many convenient features. It combines some of the functions of the projector buttons with some of the functions of the computer mouse.

Before using the remote control, be sure steps 1 through 3 have been completed under “Powering On the Projector” in Chapter 2.

## Identifying the Remote Control Components

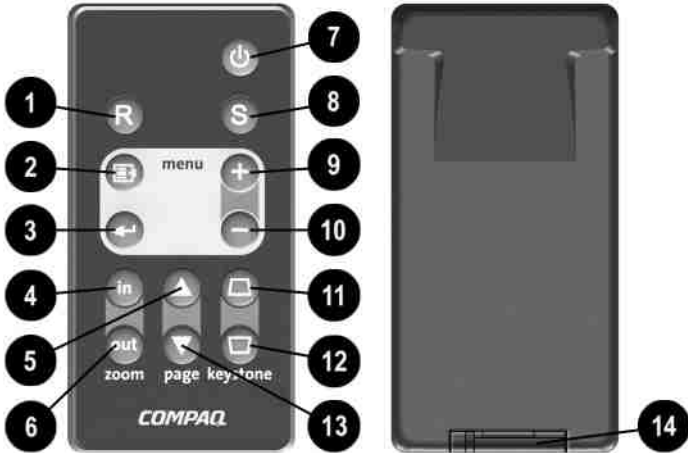

### Identifying the Remote Control Components

Item	Component	Function
❶	<b>Resync</b> button	Re-synchronizes the projector with the input source
❷	On-screen <b>Menu</b> button	Launches the on-screen display menu
❸	<b>Enter/Accept</b> button	Accepts the current selection and/or displays the next OSD menu level
❹	<b>Zoom in</b> button	Zooms in to a specific area on the screen
❺	<b>Page up</b> button	Scrolls projected image up
❻	<b>Zoom out</b> button	Zooms out to include a larger screen area

---

## Identifying the Remote Control Components (*Continued*)

---

Item	Component	Function
7	<b>Power/Standby</b> button	Turns the projector on and off OR powers the projector into and out of Standby mode
8	<b>Source</b> button	Selects the input source
9	On-screen menu adjustments +	Adjusts the on-screen display menu up
10	On-screen menu adjustments -	Adjusts the on-screen display menu down
11	Top <b>Keystone Correction</b> button	Increases or decreases keystone (trapezoidal) distortion at the top of the screen
12	Bottom <b>Keystone Correction</b> button	Increases or decreases keystone (trapezoidal) distortion at the bottom of the screen
13	<b>Page down</b> button	Scrolls projected image down
14	<b>Battery</b> compartment	Holds batteries needed for remote control operation

---

Follow the instructions in the “Adjusting the On-Screen Display Menu” section of Chapter 3 to make adjustments to the on-screen display menu.

## Remote Control Functions

The remote control performs duplicates the functions of the projector buttons including adjusting the on-screen buttons.

There are two remote control receiver sensors on the projector. They are located on the Compaq logo plates on either side of the projector. When using the remote control, be sure these sensors are not blocked. The remote control will work up to 21.0 feet (6.4 meters) from the projector when pointed at one of the sensors.

The Page Up and Page Down functions of the remote control will not work unless a desktop or notebook computer is connected to the projector with the USB cable. These functions are not available when a Compaq iPAQ Pocket PC is connected to the projector.

To use the Page Up and Page Down functions on the remote control, the USB cable (included with the projector) must be used. Connect one end of the USB cable to the USB connector on the projector and the other end to the USB connector on the computer.



Microsoft Windows XP, Windows ME, Windows 2000, and Windows 98 support USB connections. Microsoft Windows NT and early versions of Windows 95 do not support USB connections.

---

---

## Using the Home Theater Kit

The Compaq Microportable Projector has been designed to integrate video decoding functionality into the projector itself. The optional Home Theater kit uses this video decoding functionality to offer a complete home theater solution.

The optional Home Theater Kit is not included with the Compaq Microportable Projector. For information on purchasing the optional Home Theater Kit, call your Compaq authorized dealer or reseller. To locate a dealer or reseller near you, refer to the *Worldwide Telephone Numbers* booklet that came with your projector or, to purchase directly from Compaq, refer to the Compaq website at <http://www.compaq.com/products/projectors>.



## Contents of the Home Theater Kit

The home theater kit contains four cables:

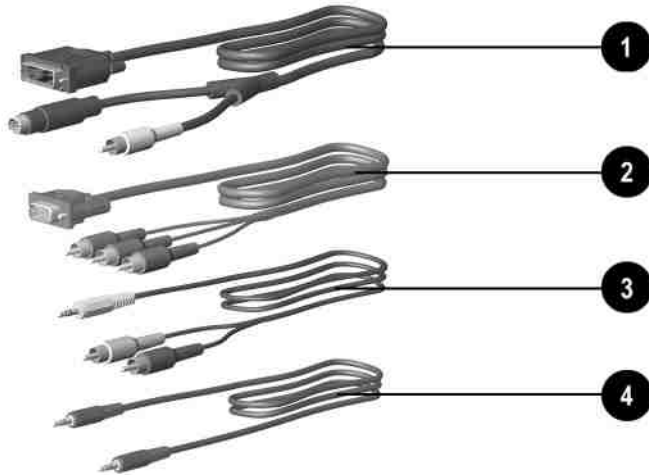

- ❶ DVI-Composite/S-video cable—connects the projector to a video source using either an S-video connector or a composite video connector. The video source can come with super video capabilities (e.g., DVD player, video cassette recorder, laser disc player, camcorder, satellite dish receiver, etc.) or without super video capabilities (e.g., videocassette recorder).
- ❷ VGA-to-HDTV/Component video cable—connects the projector to a video source for high quality video playback. The component video cable connects directly to a standard VGA connector. In addition, this cable can be used to connect the projector to a High Definition TV (HDTV) source. For details on HDTV support, refer to “HDTV Modes” later in this chapter.
- ❸ Home Theater audio cable—connects a home theater device with stereo speakers to the projector.
- ❹ PC audio cable—connects a personal computer with a single audio input connector to the projector.

## Connecting a DVD Player

1. Connect the S-video connector on the split end of the DVI-Composite/S-video cable **1** to the DVD player.
2. Connect the DVI connector end of the DVI-Composite/S-video cable to the DVI connector connector on the back of the projector **2**.

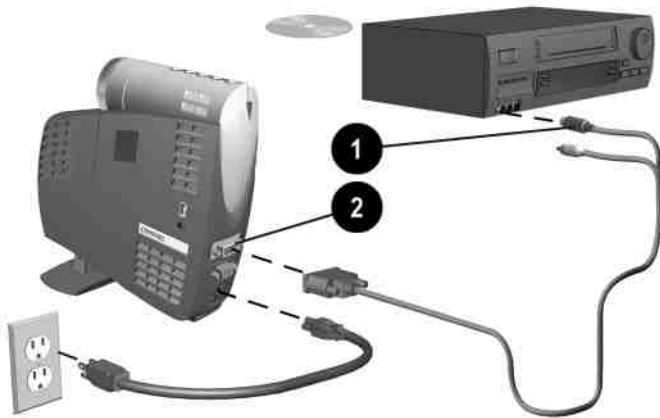

3. Connect one end of the power cord into the back of the projector and the other end to an electrical outlet that is easily accessible and close to the projector.

## Connecting a Videocassette Recorder (VCR)

1. Connect the composite video connector on the split end of the DVI-Composite/S-video cable ❶ to the VCR.
2. Connect the DVI connector end of the DVI-Composite/S-video cable to the DVI connector on the back of the projector ❷.

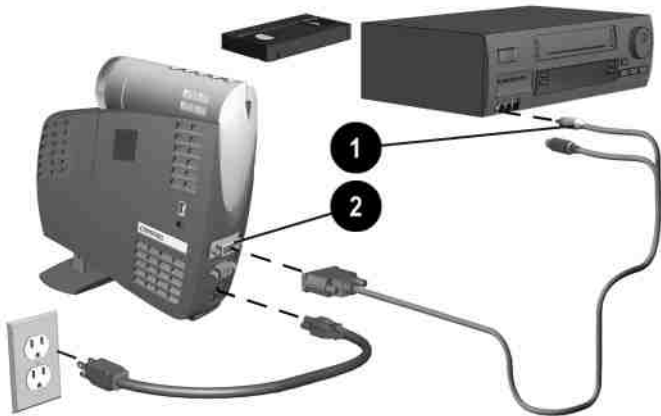

3. Connect one end of the power cord into the back of the projector and the other end to an electrical outlet that is easily accessible and close to the projector.

## Connecting a Camcorder

1. Connect the S-video connector on the split end of the DVI-Composite/S-video cable **1** to the camcorder.
2. Connect the DVI connector end of the DVI-Composite/S-video cable to the DVI connector on the back of the projector **2**.

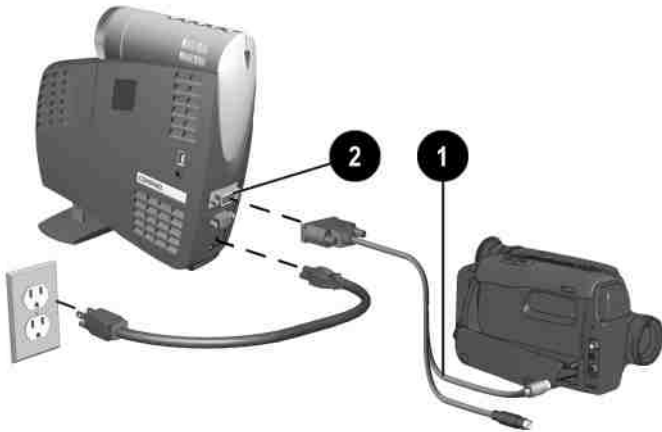

3. Connect one end of the power cord into the back of the projector and the other end to an electrical outlet that is easily accessible and close to the projector.

## Connecting an HDTV Device

1. Connect one end of the VGA-to-HDTV/component video cable ❶ to the HDTV device.
2. Connect the other end of the VGA-to-HDTV/component video cable to the VGA connector ❷ on the back of the projector.
3. Connect the dual end of the Home Theater audio cable to the HDTV device ❸.
4. Connect the single end of the Home Theater audio cable to the audio connector on the side of the projector ❹.

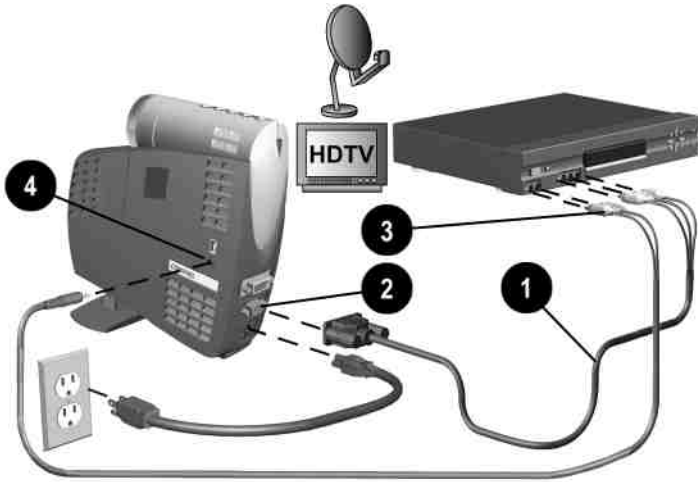

5. Connect one end of the power cord into the back of the projector and the other end to an electrical outlet that is easily accessible and close to the projector.

## Connecting a Personal Computer (PC)

1. Connect one end of the VGA cable that came with the projector to the VGA connector **1** on the back of the projector.
2. Connect the other end of the VGA cable to the PC **2**.
3. Connect one end of the PC audio cable to the audio connector **3** on the side of the projector **3**.
4. Connect the other end of the PC audio cable to the PC **4**.

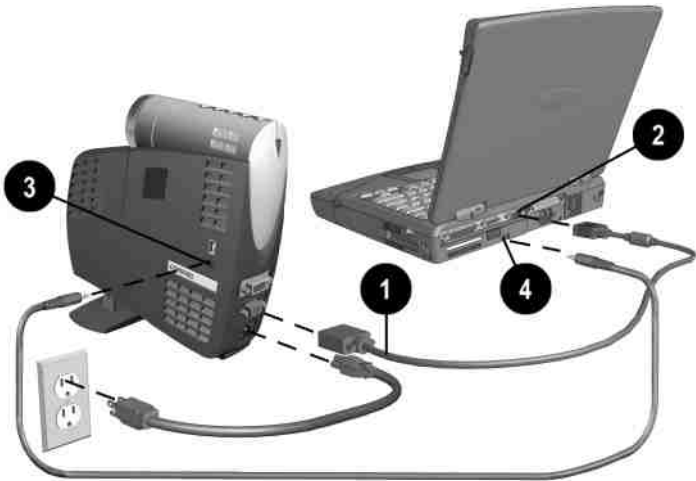

5. Connect one end of the power cord into the back of the projector and the other end to an electrical outlet that is easily accessible and close to the projector.

## HDTV Modes

The Compaq Microportable Projector is capable of displaying various High Definition TV (HDTV) display modes. A variety of sources can be used to provide HDTV data to the projector for display. Some of these sources are:

- Digital-VHS (D-VHS) player
- HDTV-DVD player
- Satellite Dish HDTV receiver
- A variety of DTV tuners (to receive programming over the airwaves)
- Game stations

Most of these sources will provide an analog component video output, a standard VGA output, or a standard digital DVI output. The color information can be either in YPrPb (default) format or RGB format. The user can switch between these using the on-screen display menu adjustments by selecting “A/V & HDTV Control.” Refer to “Introducing the On-Screen Display Menu” in Chapter 3 for more information.

The projector is capable of processing HDTV data provided either on the standard VGA connector or the DVI interface. Use the VGA-to-HDTV/Component video cable that comes with the optional Home Theater Kit to feed the component outputs to the VGA input connector.

The following modes are supported on the DVI interface:

- HD0
  - 640 x 480p (480 progressive)
  - 640 x 480i (component video)
  - 1280 x 720p
- HD1—1920 x 1080i

When displaying HDTV content, it is recommended that you display it in its native 16:9 widescreen mode. For this, you may need to select the HDTV **Fill to Aspect Ratio** mode on the projector to preserve the height-to-width relationship of the material. Note that in this mode, you will have black stripes on top and bottom of the projected image, just as you see on a standard TV set when viewing widescreen content.

A desktop or notebook computer can also be used to generate a HDTV video stream. Capable computers should be able to read/acquire the HDTV data and blend it into the desktop graphics. The composite image is then sent to the projector for display. In this case, the projector displays the image at the standard 4:3 aspect ratio, just as it would any other computer graphics mode. The projector processes the data as it comes from the computer.

When displaying HDTV content in a window as part of your desktop environment, it is recommended to project it in the computer's native 4:3 mode since the computer has already embedded the HDTV video stream in widescreen format within the window. To do so, you may need to select the **Fill to Screen** mode on your projector to preserve the height-to-width relationship of the material.

Regardless of the source, the HDTV formats are generally of higher resolution than that of the projector (XGA, or 1024 x 768). Therefore, the projector will normally downscale the HDTV data to fit the complete image within the displayable 1024 x 768 resolution.



---

## Care and Maintenance

This section explains how to care for and maintain your Compaq projector during normal everyday use.

### Protecting the Projector

To protect your projector from overheating and other types of damage, follow these suggestions:

- Use only a power source and connection appropriate for this projector as indicated on the product label located on the bottom of the projector on the elevator foot.
- Do not overload an electrical outlet, power strip, or convenience receptacle. The overall system load must not exceed 80% of the branch circuit rating. If an extension cord or power strip is used, make sure that the cord or strip is rated for the product and that the total ampere ratings of all products plugged into the extension cord or power strip do not exceed 80% of the extension cord or strip ampere ratings limit. Refer to the product label located on the bottom of the projector on the elevator foot.
- Install the projector near an outlet that you can easily reach. Disconnect the power cord by grasping the plug firmly and pulling it from the electrical outlet.
- Unplug the projector from the wall outlet before cleaning. Do not use liquid cleaners or aerosol cleaners.
- Slots and openings in the cabinet are provided for ventilation. These openings must not be blocked or covered. Never push objects of any kind into cabinet slots or other openings.

- Do not drop the projector or place it on an unstable surface.
- Do not expose the projector to rain or moisture.
- Do not allow anything to rest on the power cord. Do not walk on the cord.
- Do not allow the projector to be exposed to high temperatures.
- Do not open the projector or attempt to service this product for any reason other than to replace the lamp module. Adjust only those controls that are covered by the operating instructions. If the projector is not operating properly or has been dropped or damaged, contact your Compaq authorized dealer, reseller, or service provider.

## Cleaning the Lens

To minimize the risk of damaging or scratching the lens surface, follow this cleaning procedure. First, remove any dust particles from the lens by blowing them off with clean, dry, deionized air. However, this may not be a convenient method, and an alternate method is described below.

To clean the lens, use only a **clean** cloth and follow these steps:



**CAUTION:** Do not spray any type of fluid or cleaner directly on the lens surface. Do not use liquid cleaners.

---

1. Wipe the lens in a single direction with a **clean, dry** cloth. Do not wipe back and forth across the lens surface.
  2. If the cloth is dirty or smears the lens, wash the cloth. If the cloth is still dirty after washing it or the fabric is damaged, replace it. **Do not** use fabric softener when washing a cleaning cloth or softener sheets when drying the cloth.
- 



**CAUTION:** Do not store a cleaning cloth in contact with the lens for a long time as doing so may contaminate the lens with dye from the cloth. The cloth can be contaminated if left in the open air.

---

## Replacing the Projector Lamp Module

---



**WARNING:** When the lamp reaches its end of life, it may pop or rupture. To reduce the risk of personal injury, be careful when removing the lamp cover as broken glass may be present. Never open the lamp cover while the projector is operating or when the lamp is hot.

---

The projector will alert you when the lamp approaches its failure mode or end of life. When the message “Lamp May Fail Soon. Replacement Suggested” displays on the projection screen, you should change the lamp as soon as possible. Contact your local Compaq authorized dealer, seller, or reseller to purchase a spare lamp or have the lamp changed. To locate a reseller near you, refer to the *Worldwide Telephone Numbers* booklet that came with your projector. You can also purchase a lamp directly through <http://www.compaq.com/products/projectors>.

Follow these steps to replace the projector lamp module:

1. Turn off the projector by pressing the **Power/Standby** button on the top of the projector.
2. Allow the projector to cool down for at least 30 minutes.



**WARNING:** The lamp assembly operates at a very high temperature. To reduce the risk of personal injury, allow the projector to cool down for at least 30 minutes before opening the lamp cover. Never open the lamp cover while the projector is operating or when the lamp is hot.

---

3. Disconnect the power cord.
4. Use a coin to remove the screw ❶ from the lamp cover.
5. Remove the cover ❷.

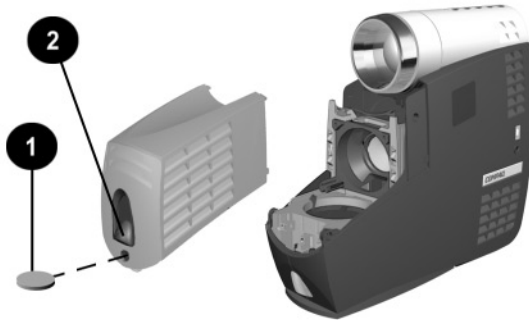

**WARNING:** To reduce the risk of personal injury, do not drop the lamp module or touch the glass bulb. The glass may shatter and cause an injury if it is dropped.

---

Reverse the previous steps to replace the lamp module.

---



**WARNING:** The lamp contains < 0.125% mercury by weight. If the projection lamp breaks, the mercury may be released into the atmosphere. Please follow applicable federal, state, and local regulations for disposal and/or recycling.

---

After the lamp module has been replaced, reset the lamp hours in the on-screen display menu to prevent the “Lamp May Fail Soon. Replacement Suggested” message from appearing again. To reset the lamp hours:

1. Be sure the projector is turned off.
2. Make sure all connections except the power cable are disconnected.
3. Press and hold the **Menu** button on top of the projector while turning the projector on.
4. Connect the VGA cable to the projector. “Service” will now be displayed as an option in the Main menu.
5. Select Service and press the **Menu** button on the top of the projector.
6. Select Reset Lamp Hours from the Service menu and press the **Menu** button.
7. Select Yes from the Confirm Reset menu and press the **Menu** button.
8. Select Save and Return.

---

# Troubleshooting

---

---

## Troubleshooting

---

Problem	Solutions
Image does not appear on the projection screen.	<ol style="list-style-type: none"><li data-bbox="529 602 836 657">1. Make sure the projector is powered on.</li><li data-bbox="529 667 878 722">2. Ensure the lens cap has been removed.</li><li data-bbox="529 732 902 787">3. Press the <b>Power/Standby</b> button again.</li><li data-bbox="529 797 884 852">4. Ensure that the power cable is securely connected.</li><li data-bbox="529 862 923 917">5. Ensure the pins on the connectors are not crooked or broken.</li><li data-bbox="529 927 926 1015">6. Turn off or disable the notebook or desktop computer screen saver function.</li><li data-bbox="529 1024 942 1079">7. Ensure the projector lamp has been securely installed.</li><li data-bbox="529 1089 948 1209">8. Ensure your notebook computer's external video port is turned on. On some notebooks, for example, toggle the <b>Fn + F4</b> function keys.</li></ol> <p data-bbox="559 1243 944 1386">Activate CRT/LCD "ON" at the same time. To identify any alternate function keys to be used, refer to your notebook computer's user manual.</p>

---

---

## Troubleshooting (*Continued*)

---

Problem	Solutions
Scrolling, cut-off, or incorrect image displayed.	<ol style="list-style-type: none"><li data-bbox="529 326 823 347">1. Press the <b>Resync</b> button.</li><li data-bbox="529 367 932 472">2. Turn everything off, then power on the projector first and power on the notebook or desktop computer second.</li><li data-bbox="529 492 948 597">3. If the above steps do not correct the display image, adjust the resolution of the notebook or desktop computer to 1024 x 768.</li><li data-bbox="529 617 939 753">4. Access the OSD and ensure the Zoom mode is set to 1. For more information on using the OSD, refer to Chapter 3, "Using the On-Screen Display Menu"</li></ol>
Image is flickering or unstable.	Press the <b>Resync</b> button on the projector panel to adjust the tracking. If that does not stop the flickering, adjust the Clock Phase function in the Image Control menu.

---

---

## Troubleshooting (*Continued*)

---

Problem	Solutions
<p>Notebook computer or iPAQ Pocket PC screen is not displaying the presentation.</p>	<p>Notebook computer:</p> <p>Most notebook computers have a monitor loop-through or simultaneous viewing function. Press the <b>Fn + F4</b> function keys on the notebook computer to switch the image from the notebook screen to the projection screen or to toggle through the following three options:</p> <ol style="list-style-type: none"> <li>1. LCD: Output displays only on the notebook screen.</li> <li>2. CRT: Output displays only on the projection screen.</li> <li>3. CRT/LCD: Output displays on the notebook screen and the projection screen.</li> </ol> <p>Activate CRT/LCD “ON” at the same time. To identify any alternate function keys to be used, refer to your notebook computer’s user manual.</p> <p>Mac PowerBooks:</p> <ol style="list-style-type: none"> <li>1. To control video mirroring, click Control Panel &gt; Display, then set Video Mirroring to ON for both internal and external viewing.</li> <li>2. Set Video Mirroring OFF for image on external monitor only or internal only, depending on monitor selection in Monitors.</li> </ol>

---



---

## Troubleshooting (*Continued*)

---

Problem	Solutions
Image is out of focus.	<ol style="list-style-type: none"><li data-bbox="529 326 868 380">1. Adjust the Focus Ring on the projection lens.</li><li data-bbox="529 391 926 505">2. Make sure the projection screen is within the required distance (3.7 to 40.7 feet, 1.1 to 12.4 meters) from the projector.</li><li data-bbox="529 516 948 626">3. Check the projection lens to see if it needs cleaning. Follow the “Cleaning the Lens” procedure in Chapter 7 to clean the lens.</li></ol>
Projected colors do not match computer or camcorder color.	<ol style="list-style-type: none"><li data-bbox="529 651 948 789">1. Adjust the Brightness, Contrast, or Color functions in the on-screen display menu. Refer to Chapter 3, “Using the On-Screen Display Menu” for more information.</li><li data-bbox="529 800 900 854">2. Make sure the pins on the cable connectors are not bent or broken.</li></ol>
Black or gray border visible outside the usable area of the projection screen.	<p data-bbox="511 878 937 1081">The black border surrounding the active area of the projection screen is part of the total projected image; however, it is an inactive area and cannot display any part of the image. This black border reduces the amount of extraneous light, producing a cleaner, sharper image.</p>
When the projector is in HDTV mode, the colors are incorrect.	<p data-bbox="511 1097 942 1260">Access the on-screen display menu, select A/V &amp; HDTV Control, select Color Space, then change to the correct color space. Refer to Chapter 3, “Using the On-Screen Display Menu” for more information.</p>

---

---

## Troubleshooting (*Continued*)

---

Problem	Solutions
Only the Compaq startup screen displays.	<ol style="list-style-type: none"> <li>1. Check that the cables are connected securely.</li> <li>2. Verify that the proper input source is connected.</li> <li>3. Make sure your notebook computer's external video port is activated.</li> </ol>
A blue screen displays on the projection screen when a videocassette recorder, DVD player, or other video source is connected to the projector.	<ol style="list-style-type: none"> <li>1. Check the Play or TV/Video buttons on the video source.</li> <li>2. If that does not work, refer to the owner's manual that came with the video source.</li> </ol>
Screen is dimmer than normal.	<p>The projector is in lamp saver mode. Press the lamp saver button on the top of the projector to turn lamp saver on or off. If the LED is green, lamp saver is on. If the LED is not lit, lamp saver is off.</p>
Lamp shuts off.	<ol style="list-style-type: none"> <li>1. If the Standby LED flashes green rapidly, the projector has overheated and will automatically shut down. Wait five to ten minutes until the LED stops flashing and the <b>Power/Standby</b> button turns amber before restarting the projector again.</li> <li>2. A minor power surge may cause the lamp to shut off. Wait a few minutes, then turn it back on.</li> <li>3. When the lamp has reached the end of its life, the system will automatically turn off to prevent possible lamp rupture. Replace the lamp as described in the "Replacing the Projector Lamp Module" section of Chapter 7.</li> </ol>

---

---

## Troubleshooting (*Continued*)

---

Problem	Solutions
Lamp burns out or makes a popping sound.	When the lamp reaches its end of life, it will burn out and may make a loud popping sound. If this happens, the projector will not turn back on until the lamp module has been replaced. Contact your local Compaq authorized dealer, seller, or reseller to purchase a replacement lamp module. To replace the lamp, follow the procedures in the "Replacing the Projector Lamp Module" section of Chapter 7.
Projector suddenly shuts down and the power button LED blinks rapidly.	An over-temperature event has been detected. This usually occurs when either the airflow to the unit has been obstructed or a fan has failed. If airflow is obstructed, remove the obstruction, unplug the projector, re-plug the projector, and restart. If a fan has failed or an over-temperature event occurs a second time, have the projector serviced or repaired.
Speaker does not operate.	<ol style="list-style-type: none"><li data-bbox="529 969 937 1050">1. Make sure the audio cable is correctly connected to the projector and the audio source.</li><li data-bbox="529 1062 937 1118">2. Make sure the audio source is operating properly.</li><li data-bbox="529 1130 937 1182">3. Make sure the <b>Mute</b> button on the audio source is off.</li></ol>

---

---

## Troubleshooting (*Continued*)

---

Problem	Solutions
Remote control does not operate.	<ol style="list-style-type: none"> <li>1. Ensure the remote control is pointed at the sensor and is within 21.0 feet (6.4 meters) of the projector.</li> <li>2. The battery may need to be replaced.</li> <li>3. Verify that the battery is installed properly.</li> </ol>
Compatibility issues with equipment attached to the projector.	<p>Contact your Compaq authorized service provider or call Compaq Customer Support for help. Refer to the <i>Worldwide Telephone Numbers</i> booklet included in the projector documentation kit for a complete list of customer support numbers to call.</p>
Image size is too small or too large.	<ol style="list-style-type: none"> <li>1. Adjust the digital zoom or move the camera until the image is the desired size.</li> <li>2. The projector may be set to display in the center of the display area without any expansion. To change the setting, access the on-screen display menu, select A/V &amp; HDTV Control, select HDTV/Video, then select how the image should be shown in the display area. Refer to Chapter 3, "Using the On-Screen Display Menu" for more information.</li> </ol>

---

---

## Troubleshooting (*Continued*)

---

Problem	Solutions
The image is upside down or a mirror image is displayed.	The projector has been set for operation in rear screen mode or ceiling mount mode. To display the image properly, access the on-screen display menu, select Image Control, select Flip Image, then restore the displayed image to the correct setting. Refer to Chapter 3, "Using the On-Screen Display Menu" for more information.
The desired source is not displayed.	Press the <b>Source</b> button on the remote control or use the OSD menu to review and select from the active video sources.

---

# Appendix

---

## Agency Regulatory Notices

### Federal Communications Commission Notice

This equipment has been tested and found to comply with the limits for a Class B digital device, pursuant to Part 15 of the FCC Rules. These limits are designed to provide reasonable protection against harmful interference in a residential installation. This equipment generates, uses, and can radiate radio frequency energy and, if not installed and used in accordance with the instructions, may cause harmful interference to radio communications. However, there is no guarantee that interference will not occur in a particular installation. If this equipment does cause harmful interference to radio or television reception, which can be determined by turning the equipment off and on, the user is encouraged to try to correct the interference by one or more of the following measures:

- Reorient or relocate the receiving antenna.
- Increase the separation between the equipment and the receiver.
- Connect the equipment into an outlet on a circuit different from the circuit that the receiver is connected.
- Consult the dealer or an experienced radio or television technician for help.

## Modifications

The FCC requires the user to be notified that if any changes or modifications are made to this device, not expressly approved by Compaq Computer Corporation, this may void the user's authority to operate the equipment.

## Cables

Connections to this device must be made with shielded cables with metallic RFI/EMI connector hoods to maintain compliance with FCC Rules and Regulations.

## Declaration of Conformity for Products Marked with the FCC Logo—United States Only

This device complies with Part 15 of the FCC Rules. Operation is subject to the following two conditions: (1) this device may not cause harmful interference, and (2) this device must accept any interference received, including interference that may cause undesired operation.

For questions regarding your product, contact:

Compaq Computer Corporation  
P.O. Box 692000, Mail Stop 530113  
Houston, Texas 77269-2000

Or, call 1-800-652-6672 (1-800-OK COMPAQ)

For questions regarding this FCC declaration, contact:

Compaq Computer Corporation  
P.O. Box 692000, Mail Stop 510101  
Houston, Texas 77269-2000

Or, call (281) 514-3333

To identify this product, refer to the Part, Series, or Model number found on the product.

## Canadian Notice

This Class B digital apparatus meets all requirements of the Canadian Interference-Causing Equipment Regulations.

## Avis Canadien

Cet appareil numérique de la classe B respecte toutes les exigences du Règlement sur le matériel brouilleur du Canada.

## European Union Notice



Products bearing the CE Marking comply with the EMC Directive (89/336/EEC) and the Low Voltage Directive (73/23/EEC) issued by the Commission of the European Community and if this product has telecommunication functionality, the R&TTE Directive (1999/5/EC).

Compliance with these directives implies conformity to the following European norms (in parentheses are the equivalent international standards and regulations):

- EN 55022 (CISPR 22)—Electromagnetic Interference
- EN55024 (IEC6100-4-2, 3, 4, 5, 6, 8, 11)—Electromagnetic Immunity
- EN61000-3-2 (IEC6100-3-2)—Power Line Harmonics
- EN61000-3-3 (IEC61000-3-3)—Power Line Flicker
- EN 60950 (IEC 60950)—Product Safety



## Japanese Notice

この装置は、情報処理装置等電波障害自主規制協議会（VCCI）の基準に基づくクラスB情報技術装置です。この装置は、家庭環境で使用することを目的としていますが、この装置がラジオやテレビジョン受信機に近接して使用されると、受信障害を引き起こすことがあります。

取扱説明書に従って正しい取り扱いをして下さい。

## Power Cords

The power cord set (flexible cord or wall plug) received with the projector meets the requirements for use in the country where you purchased the equipment.

If you need to obtain a power cord for a different country, you should purchase a power cord that is approved for use in that country.

The power cord must be rated for the product and for the voltage and current marked on the product electrical ratings label. The voltage and current rating of the cord should be greater than the voltage and current rating marked on the product. In addition, the diameter of the wire must be a minimum of 0.75 mm<sup>2</sup> or 18AWG, and the length of the cord must be between 6 feet (1.8m) and 12 feet (3.6m). If you have questions about the type of power cord to use, contact your Compaq authorized service provider.

A power cord should be routed so that it is not likely to be walked on or pinched by items placed upon it or against it. Particular attention should be paid to the plug, electrical outlet, and the point where the cord exits from the product.