

# Panasonic

ideas for life

## PT-D5000ES PT-D5000ELS

DLP™ Based Projector



Communicate more effectively  
with crisp, vibrant images

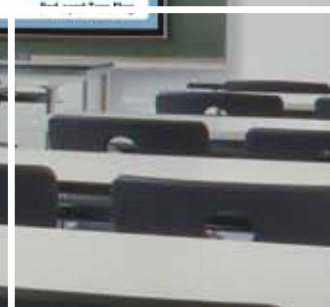
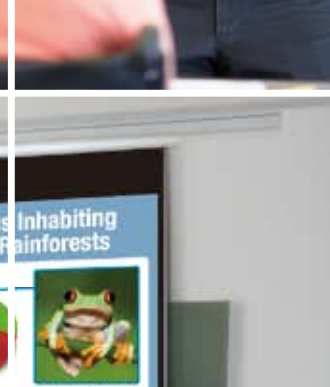

# ProSelecta

View :: Compare :: Select - [www.ProSelecta.com](http://www.ProSelecta.com)

# A New Standard for 1-chip DLP™ Projectors

## Refined Image Quality with Reliability and Easy Maintenance

Panasonic's PT-D5000ES/D5000ELS\* 1-chip DLP™ projectors bring excellent image quality and natural, lifelike colours to your images. They also have a wealth of unique technologies, like our newly developed RGB Booster, which combines high brightness with superb colour reproduction, a Dual-Lamp System for solid reliability, and the Auto Cleaning Filter, which eliminates the need for filter maintenance for approximately 10,000 hours. These all-round projectors are extremely well suited to use in schools or training facilities, presentations, and business meetings or conferences.

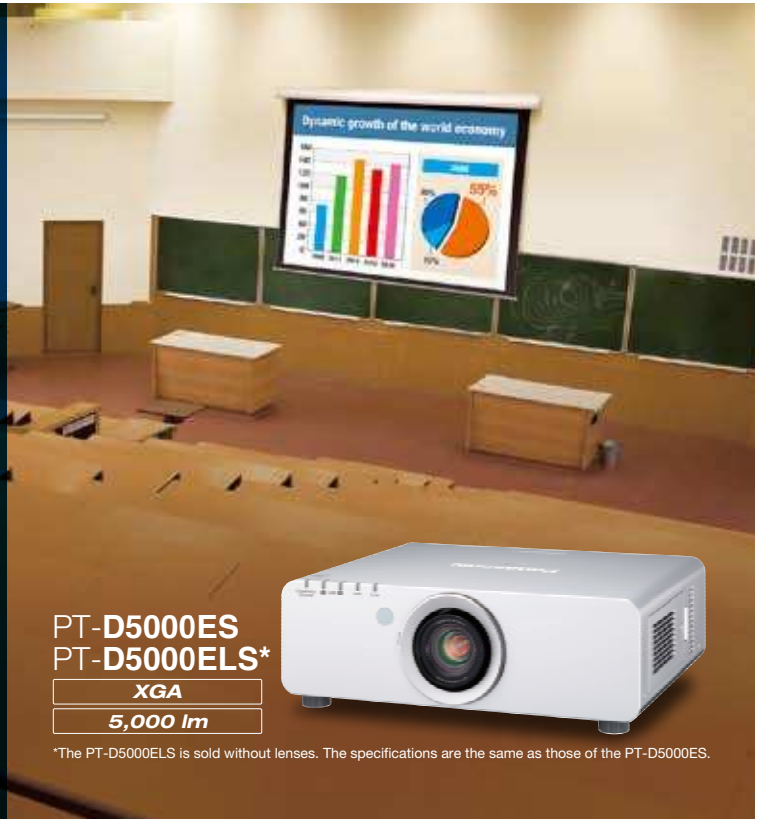

**PT-D5000ES**  
**PT-D5000ELS\***

**XGA**

**5,000 lm**

\*The PT-D5000ELS is sold without lenses. The specifications are the same as those of the PT-D5000ES.

## Vivid Picture Quality with High Brightness

### RGB Booster Significantly Improves Colour Reproduction

The RGB Booster achieves high image quality with levels of colour reproduction (up to 145% that of conventional models) and brightness that make each colour stand out. It combines Panasonic's proprietary Vivid Colour Control technology with a newly engineered Lamp Modulation Drive System for a 1-chip DLP™ projector that produces bright and vivid colours.

#### ■ Vivid Color Control

This unique control technology optimises the use of the colour segment areas of the colour wheel. It increases the brightness of each RGB colour by minimising the unallocated portions between the colours, to achieve truly vivid colouring.

#### ■ Lamp Modulation Drive System

With the new lamp modulation technology, the projector is now able to control the lamp intensity for each of the red, green, blue, and white segments of the colour wheel separately. Because the actual light output is controlled in relation to each colour segment, light usage is optimised and colour balance is obtained without lowering the brightness. This results in bright vivid images with increased colour fidelity.

#### Conventional System



##### Conventional Colour Wheel

Conventional technology was unable to use the boundaries between colours.

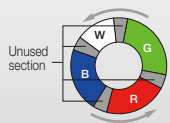

##### Conventional Lamp Drive System

Colour Wheel **B W G R**

Lamp Power

Because the lamp power was fixed in conventional projectors, colour reproduction was enhanced by sacrificing brightness.

#### RGB Booster



##### Vivid Colour Control

Ensures maximum utilisation of the colour wheel by minimising unused section.

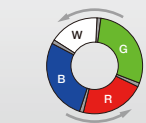

##### Lamp Modulation Drive System

Colour Wheel **B W G R**

Lamp Power

By modulating the lamp power, we can maximise the colour reproduction of each colour without sacrificing brightness.

### High Brightness with AC Lamp

High-efficiency light convergence technology and a colour wheel work together to achieve an outstanding 5,000 lm of brightness. It reproduces clear, crisp images even in bright rooms.

### Detail Clarity Processor Brings Depth and Clarity to Details

This advanced image-processing circuit analyses the video signal frequency range for each scene by extracting data on the distribution of high, mid, and low-frequency components, and brings out fine details accordingly. The resulting images have a more natural, three-dimensional appearance with crisp, clear detail.

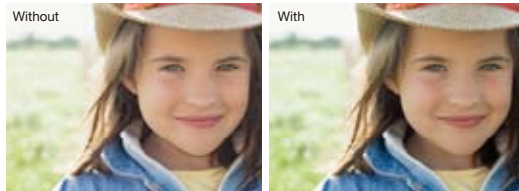

**Conventional sharpness control:** Sharpness is applied uniformly, which can cause a halo or ring effect and diminish the sense of depth.

**Detail Clarity Processor:** Signal frequency is extracted real-time and necessary sharpness is applied at varying degrees for natural, life-like images.

### System Daylight View 2 for Enhanced Colour Perception

Image details are less clear when a projector is used in a room with the lights on. Panasonic's System Daylight View 2 improves brightness perception by adjusting sharpness, gamma curves, and colour corrections. This produces crisper, more stunning images with vivid colours even under bright conditions.

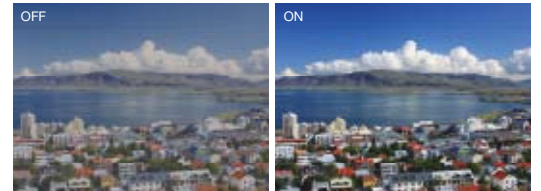

## Easy Maintenance and Superior Reliability

### Dual-Lamp System Prevents Image Interruptions

The Dual-Lamp System increases brightness and eliminates the need to interrupt a presentation if a lamp should burn out (in dual-lamp operation mode). The Lamp Relay mode also operates the lamps alternately to enable 24/7 projector operation.

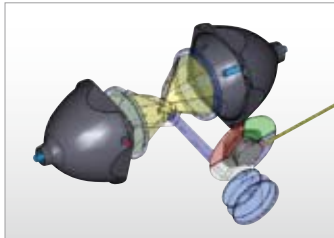

### Liquid Cooling System Attains a High Level of Reliability

The liquid cooling system directly cools the DLP™ chip to improve performance and enable operation up to 45°C/113°F. This allows use in a wider variety of environments, while stabilising performance and keeping the unit quiet even in harsh conditions.

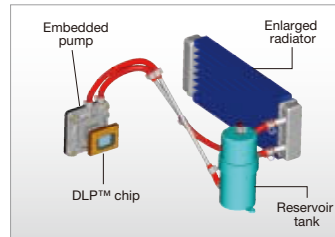

### Auto Cleaning Filter Reduces Maintenance Hassles



The Auto Cleaning Filter (ACF) provides a clean filter surface whenever it senses clogging, and brushes dust from the filter. This enhances the Micro Cut Filter's performance, so no filter replacement is needed for over 10,000 hours\*, reducing maintenance.

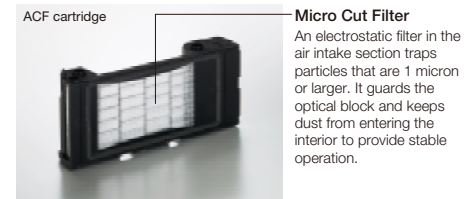

\*The replacement cycle given here is a guideline. It may differ depending on the usage environment.

## System Integration Flexibility

### Flexible Installation

The wide adjustment range of the powered horizontal/vertical lens shift function assures virtually distortion-free images and adds convenience and versatility. It lets you easily make adjustments with the remote control. The unit can also be rotated 360° vertically. This means you can install it at any angle you want, to accommodate different installation conditions.

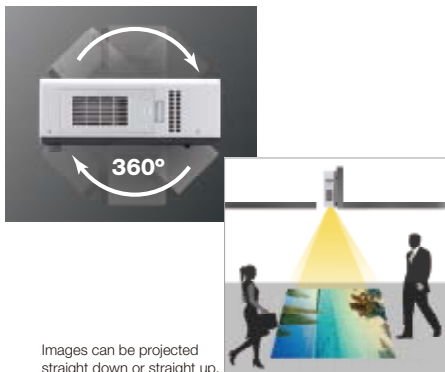

Images can be projected straight down or straight up.

### Mechanical Lens Shutter

The mechanical lens shutter completely blocks annoying light leakage when the PT-D5000ES is on standby or temporarily not in use, such as during a meeting.

### Web Browser Control/Monitoring and E-mail Message Alert

The PT-D5000ES can be easily operated remotely over a LAN network, because it is all done using the computer's familiar web browser. Furthermore, the projector sends an e-mail message to notify the operator when an error has occurred, or a lamp needs to be replaced.

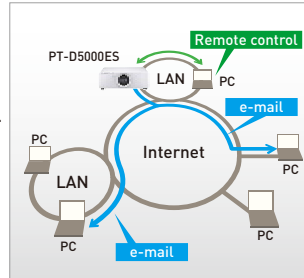

### PJLink™ Compatibility



The LAN terminals support PJLink™ Class 1 connection, which is highly convenient for system construction.

### Multi Projector Monitoring & Control Software

Panasonic's original "Multi Projector Monitoring & Control" freeware allows the user to control and monitor multiple projectors at the same time via LAN. Projectors can be scheduled to turn on and off at a certain hour everyday. When a problem occurs, an alarm message is sent to the monitoring/controlling PC.

### Eco Standby Mode\*

The PT-D5000ES has attained a low standby power level of 0.3 W, which is a top-class level in its class. It also helps to slash running costs, and reduces environmental impact.

\* In Eco standby mode, LAN-based network functions such as the standby ON function will not operate.

### Other Features

- Full 10-bit Signal Processing
- 3D Colour Management System
- HD IP Converting Circuitry
- Digital Signal Noise Reduction Circuitry
- Dynamic Sharpness Control Circuitry
- 30m Long Range Wireless Remote Control
- Direct Power Off

### Ecology-conscious Design

Panasonic works from every angle to minimize environmental impact in the product design, production and delivery processes, and in the performance of the product during its life cycle. The PT-D5000ES reflects the following ecological considerations.

- No halogenated flame retardants are used in the cabinet.
- Lamp power switching further reduces power consumption.
- Auto Power Save activates standby mode when no signal is input.
- Standby power consumption of only 0.2 W\*\* has been achieved.

## Recommended Applications

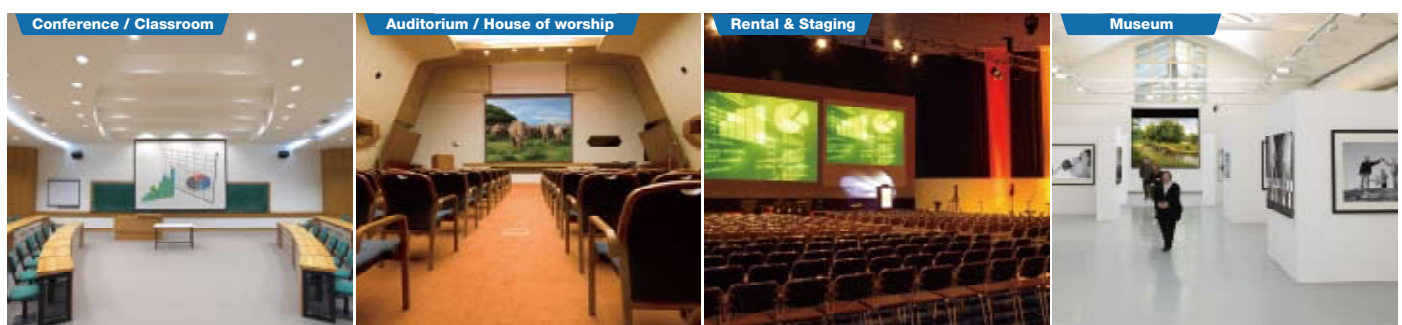









The PT-D5000ES boasts superior image quality, flexible installation, and easy maintenance, making either model an ideal choice for use in classrooms, auditoriums, houses of worship, museums, and much more.

## Specifications

Power supply	220-240 V AC 50/60 Hz	
Power consumption	600 W (670 VA) (Eco standby mode*: 0.3 W, Standby mode normal: 9 W. Both with fan stopped.)	
DLP™ chip	Panel size	0.7" diagonal (4:3 aspect ratio)
	Display method	DLP™ chip x 1, DLP™ system
Lens	Pixels	786,432 (1,024 x 768) x 1, total of 786,432 pixels
	PT-D5000ES	Powered zoom/focus lenses (1.8-2.4:1), F 1.7-2.0, f 25.6-33.8 mm
PT-D5000ELS	Optional powered zoom/focus lenses	
Lamp	240 W UHM lamps (x 2) (dual-lamp system)	
Screen size	50-600 inches (50-200 inches with the ET-DLE055), 4:3 aspect ratio	
Brightness*2	5,000 lumens (dual-lamp)	
Centre-to-corner uniformity*2	90 %	
Contrast*2	1,000:1 (full on/full off)	
Resolution	1,024 x 768 pixels (Input signals that exceed this resolution will be converted to 1,024 x 768 pixels.)	
Scanning frequency	DVI-D	Horizontal: 15-91 kHz, Vertical: 50-85 Hz, Dot clock: 162 MHz or lower
	RGB	Horizontal: 15-91 kHz, Vertical: 50-85 Hz, Dot clock: 150 MHz or lower
	YPbPr (Y/Ca/Cb)	525i (480p), 625i (576p), 525p (480p), 625p (576p), 750 (720)/60p, 750 (720)/50p, 1035/60i, 1125 (1080)/60i, 1125 (1080)/50i, 1080/25p, 1080/24p, 1080/24sF, 1080/30p, 1080/60p, 1080/50p
S-Video/Video	Horizontal: 15.75/15.63 kHz, Vertical: 50/60 Hz, NTSC, NTSC4.43, PAL, PAL60, PAL-N, PAL-M, SECAM	
Optical axis shift	Vertical: +50 % (powered), horizontal: ±10 % (powered)	
Keystone correction range	Vertical: ±40° (±30° with the ET-DLE055)	
Installation	Ceiling/floor, front/rear	
Terminals*3	DVI-D IN	DVI-D 24-pin
	RGB 1/YPbPr IN	BNC x 5
	RGB 2/YPbPr IN	D-sub HD 15-pin
	VIDEO IN	BNC
	S-VIDEO IN	Mini DIN 4-pin
	SERIAL IN	D-sub 9-pin (RS-232C compliant)
	SERIAL OUT	D-sub 9-pin
	REMOTE 1 IN	M3 jack
	REMOTE 1 OUT	M3 jack
	REMOTE 2 IN	D-sub 9-pin
LAN	RJ-45 for network connection, 10Base-T/100Base-TX, compliant with PLink™	
Power cord length	3.0 m (9'10")	
Cabinet material	Molded plastic	
Dimensions (W x H x D)	PT-D5000ES	498 mm x 175 mm** x 440 mm** (19-19/32" x 6-7/8"** x 17-5/16"**) (with supplied lens)
	PT-D5000ELS	498 mm x 175 mm** x 432 mm (19-19/32" x 6-7/8"** x 17") (without lens)
Weight*6	PT-D5000ES	Approx. 16.0 kg (35.3 lbs) (with supplied lens)
	PT-D5000ELS	Approx. 15.2 kg (33.5 lbs) (without lens)
Operating temperature	0-45°C (32-113°F)	
Operating humidity	20-80 % (no condensation)	
Supplied accessories	Power cord, Wireless/wired remote control unit, Batteries for remote control (x 2), Wire rope	

\*1 In Eco standby mode, LAN-based network functions such as the standby ON function will not operate.  
\*2 Measurement, measuring conditions, and method of notation all comply with ISO 21118 international standards.  
\*3 The HD/SYNC and VD inputs do not accept the tri-level sync signal.  
\*4 With leg at shortest position.  
\*5 Including the supplied lens.  
\*6 Average value. May differ depending on models.

## Optional accessories

Lenses				
Zoom lens ET-DLE150 (1.3-2.0:1)	Zoom lens ET-DLE250 (2.4-3.7:1)	Zoom lens ET-DLE350 (3.7-5.6:1)	Zoom lens ET-DLE450 (5.5-8.9:1)	Fixed-focus lens ET-DLE055 (0.8:1)
				
Lamp	Filter	Ceiling mount bracket		
Replacement lamp unit ET-LAD60 ET-LAD60W (twin pack)	Replacement filter unit ET-ACF100	ET-PKD56H (for high ceilings) ET-PKD55S (for low ceilings)		
		 		

## Multiple terminals

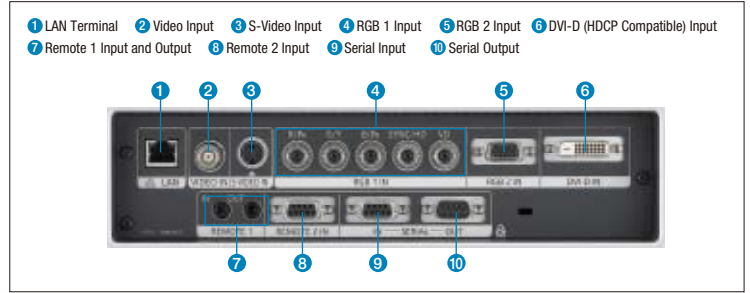

## Dimensions

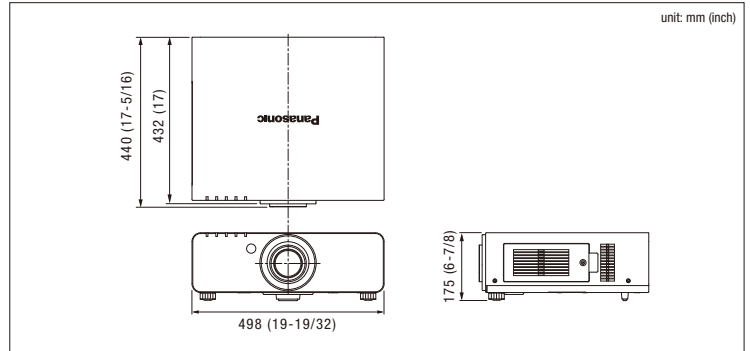

## Projection distance

Screen size (4:3)	With ET-DLE150 1.3-2.0:1		With supplied lens 1.8-2.4:1		With ET-DLE250 2.4-3.7:1		With ET-DLE350 3.7-5.6:1		With ET-DLE450 5.5-8.9:1		With ET-DLE055 0.8:1
	min.	max.	min.	max.	min.	max.	min.	max.	min.	max.	
50"	1,344mm 4.5'	1,967mm 6.5'	1,785mm 5.9'	2,376mm 7.8'	2,361mm 7.8'	3,777mm 12.4'	3,713mm 12.2'	5,681mm 18.7'	5,525mm 18.2'	8,912mm 29.3'	808mm 2.7'
80"	2,183mm 7.2'	3,177mm 10.5'	2,895mm 9.5'	3,840mm 12.6'	3,826mm 12.6'	6,090mm 20.0'	6,023mm 19.8'	9,170mm 30.1'	9,020mm 29.6'	14,438mm 47.4'	1,322mm 4.4'
100"	2,742mm 9.0'	3,983mm 13.1'	3,635mm 12.0'	4,816mm 15.9'	4,803mm 15.8'	7,633mm 25.1'	7,562mm 24.9'	11,496mm 37.8'	11,351mm 37.3'	18,123mm 59.5'	1,664mm 5.5'
150"	4,140mm 13.6'	6,000mm 19.7'	5,485mm 18.0'	7,256mm 23.9'	7,244mm 23.8'	11,489mm 37.7'	11,411mm 37.5'	17,312mm 56.8'	17,177mm 56.4'	27,333mm 89.7'	2,519mm 8.3'
200"	5,537mm 18.2'	8,016mm 26.3'	7,335mm 24.1'	9,696mm 31.9'	9,686mm 31.8'	15,344mm 50.4'	15,259mm 50.1'	23,127mm 75.9'	23,004mm 75.5'	36,544mm 119.9'	3,375mm 11.1'
300"	8,333mm 27.4'	12,049mm 39.6'	11,035mm 36.3'	14,576mm 47.9'	14,568mm 47.8'	22,956mm 75.7'	22,956mm 75.4'	34,758mm 114.1'	34,656mm 113.8'	54,966mm 180.4'	—
400"	11,129mm 36.6'	16,082mm 52.8'	14,735mm 48.4'	19,456mm 63.9'	19,451mm 63.9'	30,768mm 101.0'	30,653mm 100.6'	46,389mm 152.2'	46,309mm 152.0'	73,387mm 240.8'	—
500"	13,924mm 45.7'	20,115mm 66.0'	18,435mm 60.5'	24,336mm 79.9'	24,334mm 79.9'	38,480mm 126.3'	38,350mm 125.9'	58,020mm 190.4'	57,961mm 190.2'	91,809mm 301.3'	—
600"	16,720mm 54.9'	24,148mm 79.3'	22,135mm 72.7'	29,216mm 95.9'	29,217mm 95.9'	46,192mm 151.6'	46,047mm 151.1'	69,651mm 228.6'	69,614mm 228.4'	110,231mm 361.7'	—

## NOTES ON USE

- Do not install the projector in locations that are subject to excessive water, humidity, steam, or oily smoke. Doing so may result in fire, malfunction, or electric shock.
- The projector uses a high-voltage mercury lamp that contains high internal pressure. This lamp may break, emitting a large amount of light, or fail to illuminate, due to impact or extended use.
- The projector uses a high-wattage lamp that becomes very hot during operation. Please observe the following precautions.
  - Never place objects on top of the projector while it is in operation.
  - Make sure there is an unobstructed space of 500 mm (1.64 feet) or more around the projector's exhaust openings.
  - Do not stack projector units directly on top of one another for the purpose of multiple (stacked) projection. When stacking projector units, be sure to provide the amount of space indicated between them. These space requirements also apply to installation where only one projector unit is operating at one time and the other unit is used as a backup.
  - If the projector is placed in a box or enclosure, temperature of the air surrounding the projector must be between 0°C (32°F) and 40°C (104°F). Also make sure the projector's intake and exhaust openings are not blocked. Take particular care to ensure that hot air from the exhaust openings is not sucked into the intake openings.
    - Even when the ambient temperature near the intake opening is 40°C (104°F) or lower, an accumulation of hot air inside the cabinet may cause the protective circuit to activate and shut down the projector. Please give ample consideration to the design with regard to ambient temperature conditions.
- If the projector is to be operated continuously 24 hours a day, use the dual-lamp optical system's alternating lamp operation (lamp changer) function. The projector cannot be operated continuously 24 hours a day in dual-lamp mode. Allow a minimum of two hours per day of non-operation time per lamp if using the dual-lamp mode.
- The lamp replacement cycle duration becomes shorter if the projector is operated repeatedly for short periods.
  - The length of time that it takes for the lamp to break or fail to illuminate varies greatly depending on individual lamp characteristics and usage conditions.
  - The brightness of the lamp will gradually decrease with use.

# Panasonic®

For more information about Panasonic projectors —  
<http://panasonic.net/avc/projector>

Please contact Panasonic or your dealer for a demonstration.



Weights and dimensions shown are approximate. Specifications are subject to change without notice.  
This product may be subject to export regulations.  
An application has been filed for trademark rights, or trademark rights have been granted,  
for PLink in Japan, United States of America and other countries and area.  
XGA is trademark of International Business Machines Corporation.  
All other trademarks are the property of their respective trademark owners. Projection images simulated.  
DLP, DLP logo and DLP Medallion logo are trademarks or registered trademarks of Texas Instruments.  
(C) 2009 Panasonic Corporation All rights reserved.

All information included here is valid as of May 2009.  
PT-D5KE1 Printed in Japan.