



Please read this manual carefully before operating your set.

Retain it for future reference.

Record model number and serial number of the set. See the label attached on the bottom of the set and quote this information to your dealer when you require service.

Model number :

Serial number :

# LG DLP PROJECTOR

## BX401C OWNER'S MANUAL

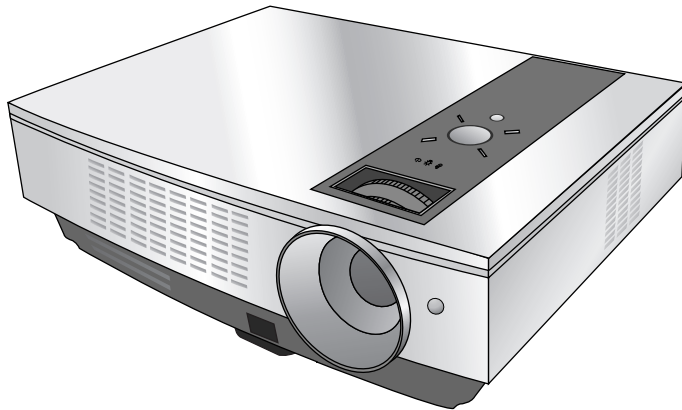

# DLP PROJECTOR

**Warning**

This is a class A product. In a domestic environment this product may cause radio interference, in which case the user may be required to take adequate measures.

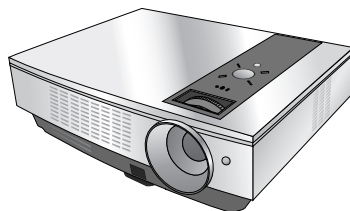

# Contents

|   |    |  |    |
|---|----|--|----|
| <b>Safety Instructions</b> .....            | 4  | <b>Special Menu Options</b>                    |    |
| <b>Names of parts</b>                       |    | Selecting Language .....                       | 23 |
| Main Body .....                             | 7  | Using Aspect Ratio Function.....               | 23 |
| Connecting Part .....                       | 7  | Overscan Function.....                         | 23 |
| Control Panel .....                         | 8  | Flip horizontal Function.....                  | 24 |
| Remote Control.....                         | 9  | Flip vertical Function .....                   | 24 |
| Installing Batteries.....                   | 9  | Sleep time Function .....                      | 24 |
| Projector Status Indicators.....            | 10 | Auto sleep Function .....                      | 25 |
| Accessories.....                            | 11 | Presentation timer Function .....              | 25 |
| Optional Extras .....                       | 11 | Using Digital Zoom Function.....               | 26 |
| <b>Installing and Composition</b>           |    | Using Keystone Function .....                  | 27 |
| Installation Instructions .....             | 12 | Using Blank Function .....                     | 27 |
| Basic Operation of the Projector.....       | 13 | Selecting Blank image .....                    | 28 |
| Using Kensington Security System.....       | 14 | Captured Image Function .....                  | 28 |
| Turning on the Projector .....              | 15 | Lamp mode Function .....                       | 28 |
| Turning off the Projector .....             | 15 | Using Monitor out Function.....                | 29 |
| Focus and Position of the Screen Image..... | 16 | Checking lamp time .....                       | 29 |
| Selecting source mode .....                 | 16 | Using Still Function .....                     | 29 |
| <b>Connection</b>                           |    | <b>Screen Menu Options</b>                     |    |
| Connecting to a Desktop PC .....            | 17 | Auto configure Function .....                  | 30 |
| Connecting to a Notebook PC .....           | 17 | Using Phase Function.....                      | 30 |
| Connecting to a Video Source .....          | 18 | Using Clock Function .....                     | 30 |
| Connecting to a DVD .....                   | 18 | Using Horizontal Function.....                 | 31 |
| Connecting to a D-TV Set-Top Box .....      | 18 | Using Vertical Function .....                  | 31 |
| <b>Function</b>                             |    | <b>RS-232C</b>                                 |    |
| <b>Video Menu Options</b>                   |    | External Control Device Setup.....             | 32 |
| Adjusting Video .....                       | 19 | <b>Information</b>                             |    |
| Picture mode.....                           | 19 | Supported Monitor Display.....                 | 37 |
| Color Temperature Control.....              | 20 | Maintenance.....                               | 37 |
| Gamma Function .....                        | 20 | Replacing the Lamp.....                        | 38 |
| Gamma curve shift Function.....             | 20 | How to fix the lens cap to the projector ..... | 40 |
| Brilliant color™ Function .....             | 21 | Specifications .....                           | 41 |
| White peaking Function .....                | 21 |  |    |
| Black level Function .....                  | 21 |  |    |
| Expert color Function .....                 | 22 |  |    |
| Reset.....                                  | 22 |  |    |

## Disposal of your old appliance



1. When this crossed-out wheeled bin symbol is attached to a product it means the product is covered by the European Directive 2002/96/EC.
2. All electrical and electronic products should be disposed of separately from the municipal waste stream via designated collection facilities appointed by the government or the local authorities.
3. The correct disposal of your old appliance will help prevent potential negative consequences for the environment and human health.
4. For more detailed information about disposal of your old appliance, please contact your city office, waste disposal service or the shop where you purchased the product.

# Safety Instructions

Please take note of the safety instructions to prevent any potential accident or misuse of the projector.

→ Safety Instructions are given in two forms as detailed below.

 **WARNING** : The violation of this instruction may cause serious injuries and even death.

 **NOTES** : The violation of this instruction may cause light injuries or damage to the projector.

→ After reading this manual, keep it in the place that the user always can contact easily.

## Indoor Installation

### WARNING

Do not place the Projector in direct sunlight or near heat sources such as radiators, fires and stove etc.

This may cause a fire hazard !

Do not place inflammable materials beside the projector

This may cause a fire hazard !

Do not allow children to hang on the installed projector.

It may cause the projector to fall, causing injury or death.

## Indoor Installation

### NOTES

Disconnect from the mains and remove all connections before moving.

Do not place the projector close to sources of steam or oil such as a humidifier.

This may create a fire hazard or an electric shock hazard !

Do not place the projector where it might be exposed to dust.

This may cause a fire hazard or damage to the unit!

When installing the projector on a table, be careful not to place it near the edge.

This may cause the projector to fall causing serious injury to a child or adult and serious damage to the projector.

**Only use a suitable stand.**

Only use the projector on a level and stable surface.

It may fall and cause injury and/or damage to the unit.

Ensure good ventilation around the projector. The distance between the projector and the wall should be more than 30cm/12 inches.

An excessive increase in its internal temperature may cause a fire hazard or damage to the unit!

Do not block the vents of the projector or restrict air-flow in any way.

This would cause the internal temperature to increase and could cause a fire hazard or damage to the unit!

Do not place the projector directly on a carpet, rug or place where ventilation is restricted.

This would cause its internal temperature to increase and might create a fire hazard or damage the unit.

## Outdoor Installation

### WARNING

Do not use the projector in a damp place such as a bathroom where it is likely to get wet.

This may cause a fire or an electric shock hazard !

## Power

### WARNING

Earth wire should be connected.

If the earth wire is not connected, there is a possible danger of electric shock caused by the current leakage.

If grounding methods are not possible, a separate circuit breaker should be installed by a qualified electrician.  
Do not connect ground to telephone wires, lightning rods or gas pipe.

The mains plug should be inserted fully into the power outlet to avoid a fire hazard !

This may cause a fire hazard or damage the unit.

Do not place heavy objects on the power cord.

This may cause a fire or an electric shock hazard !

**Power**

 **WARNING**

Do not use too many plugs on the Mains multi-outlet.  
It may result in overheating of the outlet and causes a fire hazard !

**Power**

 **NOTES**

Never touch the power plug with a wet hand  
This may cause an electric shock hazard !

Hold the plug firmly when unplugging. If you pull the cord, it may be damaged.  
This may cause a fire hazard !

Prevent dust collecting on the power plug pins or outlet.  
This may cause a fire hazard !

Do not plug when the power cord or the plug is damaged or any part of the power outlet is loose.  
This may cause a fire or an electric shock hazard or damage to the unit!

Ensure the power cord does not come into contact with sharp or hot objects such as a heater.  
This may cause a fire or an electric shock hazard or damage to the unit!

Place the projector where people will not trip or tread on the power lead.  
This may cause a fire or an electric shock hazard or damage to the unit!

Do not turn the projector On/Off by plugging-in or unplugging the power plug to the wall outlet. (Do not use the power plug for switch.)  
It may cause mechanical failure or could cause an electric shock.

**Using**

 **WARNING**

Do not place anything containing liquid on top of the projector such as flowerpot, cup, cosmetics or candle.  
This may cause a fire hazard or damage to the unit!

In case of impact shock or damage to the projector switch it off and unplug it from the mains outlet and contact your service center.  
This may cause a fire or an electric shock hazard or damage to the unit!

Do not allow any objects to fall into the projector.  
This may cause an electric shock hazard or damage to the unit!

If water is spilt into the projector unplug it from the mains supply outlet immediately and consult your Service Agent.  
This may cause an electric shock hazard or damage to the unit!

Dispose of used batteries carefully and safely.  
In the case of a battery being swallowed by a child please consult a doctor immediately.

In the event that an image does not appear on the screen please switch it off and unplug it from the mains supply and contact your Service Agent.  
This may cause a fire or an electric shock hazard or damage to the unit!

Do not remove any covers (except lens cover). High risk of Electric Shock!

Don't look directly onto the lens when the projector is in use. Eye damage may occur!

Do not touch metal parts during or soon after operation since the vents and lamp cover will remain very hot!

**CAUTION concerning the Power Cord**

Most appliances recommend they be placed upon a dedicated circuit; that is, a single outlet circuit which powers only that appliance and has no additional outlets or branch circuits. Check the specification page of this owner's manual to be certain.

Do not overload wall outlets. Overloaded wall outlets, loose or damaged wall outlets, extension cords, frayed power cords, or damaged or cracked wire insulation are dangerous. Any of these conditions could result in electric shock or fire. Periodically examine the cord of your appliance, and if its appearance indicates damage or deterioration, unplug it, discontinue use of the appliance, and have the cord replaced with an exact replacement part by an authorized service personnel.

Protect the power cord from physical or mechanical abuse, such as being twisted, kinked, pinched, closed in a door, or walked upon. Pay particular attention to plugs, wall outlets, and the point where the cord exits the appliance.

Using

 WARNING

Never touch the wall outlet when there is leakage of gas, open the windows and ventilate.

It can cause a fire or a burn by a spark.

Do not drop the projector or allow impact shock.

This may cause mechanical failure or personal injury !

Don't look at laser beam directly as it can cause eye damage!

Always open the lens door or remove the lens cap when the projector lamp is on.

Using

 NOTES

Do not place heavy objects on top of projector.

This may cause mechanical failure or personal injury!

Take care not to impact the lens particularly when moving the projector.

Do not touch the lens of the projector. It is delicate and easily damaged.

Do not use any sharp tools on the projector as this will damage the casing.

Cleaning

 WARNING

Do not use water while cleaning the projector

This may cause damage to the projector or an electric shock hazard.

In the unlikely event of smoke or a strange smell from the projector, switch it off , unplug it from the wall outlet and contact your dealer or service centre.

This may cause a fire or an electric shock hazard or damage to the unit!

Use an air spray or soft cloth that is moist with a neutral detergent and water for removing dust or stains on the projection lens.

Cleaning

 NOTES

Contact the Service Center once a year to clean the internal parts of the projector.

Accumulated dust can cause mechanical failure.

When cleaning the plastic parts such as projector case, unplug the power and wipe it with a soft cloth. Do not use cleanser, spray water or wipe with a wet cloth. Especially, never use cleanser (glass cleaner), automobile or industrial shiner, abrasive or wax, benzene, alcohol etc., which can damage the product. Use an air spray or soft cloth that is moist with a neutral detergent and water for removing dust or stains on the projection lens.

It can cause fire, electric shock or product damage (deformation, corrosion and damage).

Others

 WARNING

Do not attempt to service the projector yourself. Contact your dealer or service centre.

This may cause damage to the projector and could give an electric Shock as well as invalidating the warranty !

Others

 NOTES

Be sure to unplug if the projector is not to be used for a long period.

Accumulated dust may cause a fire hazard or damage to the unit!

Refer lamp servicing to qualified service personnel.

Do not mix new batteries with old batteries.

This may cause the batteries to over-heat and leak.

Only use the specified type of battery.

This could cause damage to the remote control.

# Names of parts

## Main Body

\* The projector is manufactured using high-precision technology. You may, however, see on the Projector screen tiny black points and/or bright points (red, blue, or green). This can be a normal result of the manufacturing process and does not always indicate a malfunction.

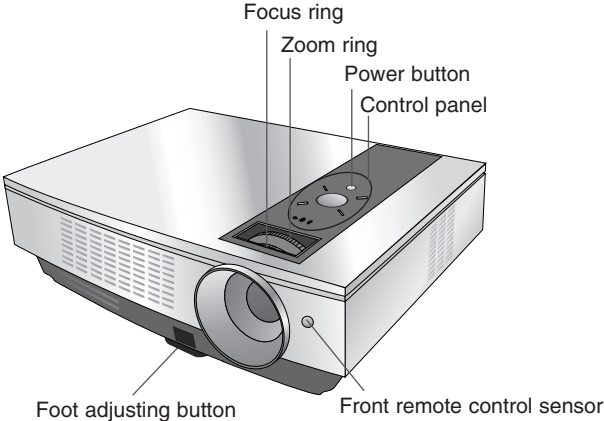

## Connecting Part

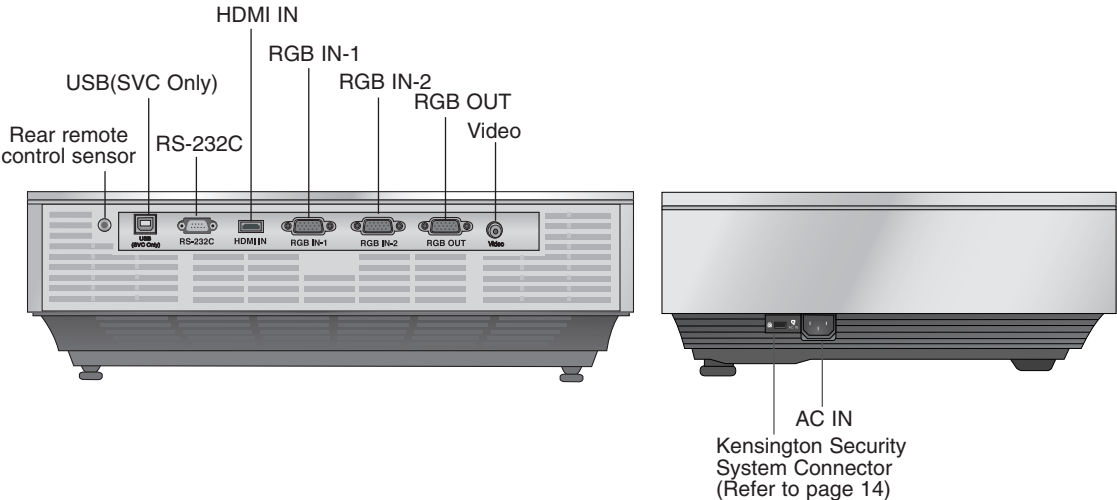

## Control Panel

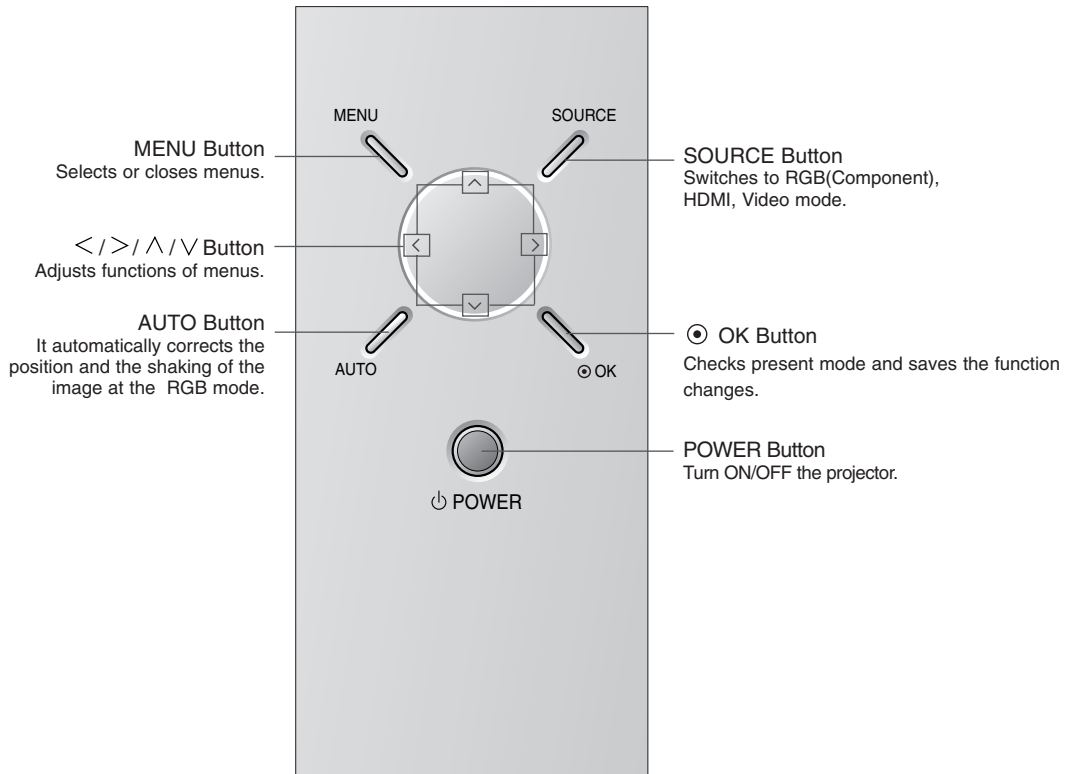



## Remote Control

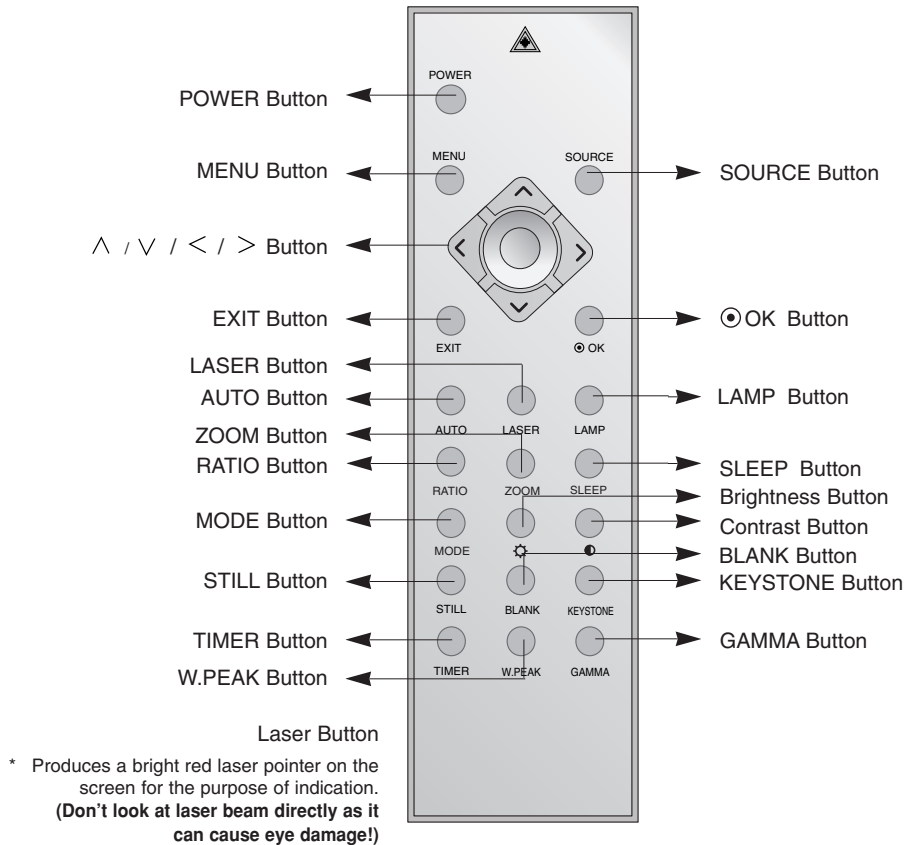

## Installing Batteries

### CAUTION

RISK OF EXPLOSION IF BATTERY IS REPLACED WITH AN INCORRECT TYPE.  
DISPOSE OF USED BATTERIES ACCORDING TO THE INSTRUCTIONS.

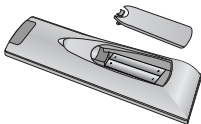

- Open the battery compartment cover on the back of the remote control.
- Insert the specified type of batteries with correct polarity, match "+" with "+", and match "-" with "-".
- Install two 1.5V AAA batteries. Don't mix used batteries with new batteries.

## Projector Status Indicators

\* Lamp indicator, operation indicator and temperature indicator at the top of the projector show the user the operating status of the projector.

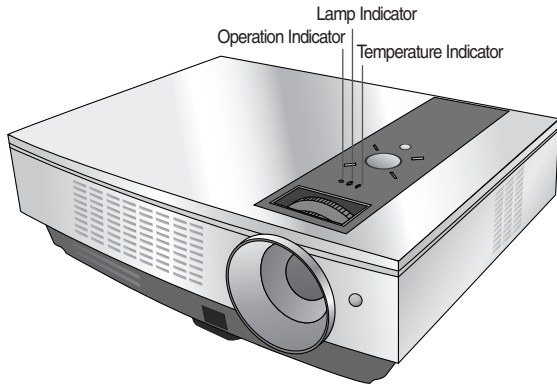

|                       |                  |  |
|-----------------------|------------------|--|
| Operation Indicator   | Red              | Standby.   |
|                       | Green(flashing)  | Lamp is starting up.   |
|                       | Green            | Unit is in operation (Lamp is turned on)   |
|                       | Orange(flashing) | Projector lamp is cooling (10 sec.)  |
|                       | Off              | Power off.   |
|                       | Orange           | Standby-This mode cools the projector naturally for 4 minutes after it is turned off.  |
| Lamp Indicator        | Red(flashing)    | This indicates a Colour Wheel problem.Please contact your local service centre.  |
|                       | Red              | Projector lamp is reaching the end of its life and needs to be replaced with a new lamp.   |
|                       | Red(flashing)    | The projector is experiencing an error. Retry Power On again later. If lamp indicator is red (flashing) again, contact the service center. |
| Temperature Indicator | Green(flashing)  | The lamp cover is open.  |
|                       | Orange           | A high temperature state has been detected. Turn the Projector off.  |
|                       | Red              | The Projector has turned off due to excessive heat.  |
|                       | Red (flashing)   | Power has turned off due to problem with the internal cooling fan. Contact your service center.  |

## Accessories



Remote Control

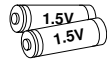

2 Batteries

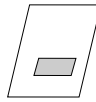

Owner's manual



CD Owner's manual



Power Cord



Computer Cable



Lens cap and Strap

## Optional Extras

\* Contact your dealer to purchase these items.

\* Contact your service personnel for replacing of lamp.

\* The lamp is consumable and needs to be replaced with a new one when it is burned out.

\* Optional parts can be changed without notice to improve the quality of the product, and new optional parts can be added.

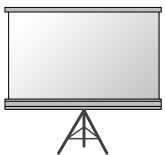

Projection Screen

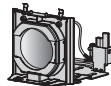

Lamp



HDMI Cable



Component Cable



Video Cable



RS-232C Cable



RCA to D-Sub Adapter



HDMI to DVI Cable

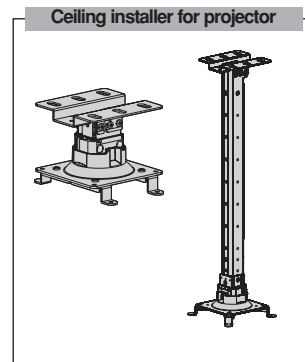

# Installing and Composition

## Installation Instructions

\* Don't place the projector in the following conditions. It may cause malfunction or product damage.

### ● Provide proper ventilation for this projector.

- The projector is equipped with ventilation holes(intake) on the bottom and ventilation holes(exhaust) on the front. Do not block or place anything near these holes, or internal heat build-up may occur, causing picture degradation or damage to the projector.

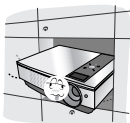

- Do not place the projector on a carpet, rug or other similar surface. It may prevent a adequate ventilation of the projector bottom. This product should be mounted to a wall or ceiling only.

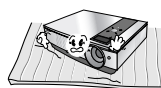

- Never push projector or spill any kind of liquid into the projector.



- Leave an adequate distance(30cm/12 inches or more) around the projector.

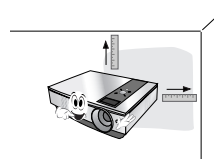

### ● Place this projector in adequate temperature and humidity conditions.

- Install this projector only in a location where adequate temperature and humidity is available. (refer p.41)

### ● Don't place the projector where it can be covered with dust.

- This may cause overheating of the projector.

### ● Do not obstruct the slots and openings of the projector. This may cause overheating and create a fire hazard.

### ● The projector is manufactured using high-precision technology. You may, however, see tiny black points and/or bright points (red, blue, or green) that continuously appear on the projector Screen. This is a normal result of the manufacturing process and does not indicate a malfunction.

### ● To display DTV programs, it is necessary to purchase a DTV receiver (Set-top Box) and connect it to the projector.

### ● When the remote control does not work during operation.

- The remote control may not work when a lamp equipped with electronic ballast or a three-wavelength lamp is installed. Replace those lamps with international standard products to use the remote control normally.

## Basic Operation of the Projector

1. Place the projector on a sturdy and horizontal surface with the PC or AV source.
2. Place the projector with the desired distance from the screen. The distance between the projector and the screen determines the actual size of the image.
3. Position the projector so that the lens is set at a right angle to the screen. If the projector is not set at a right angle, the screen image will be crooked. If this is so then the keystone adjustment may correct this (Refer to page 27.).
4. Connect the cables of the projector to a wall power socket and other connected sources.

### projection distance based on the picture format

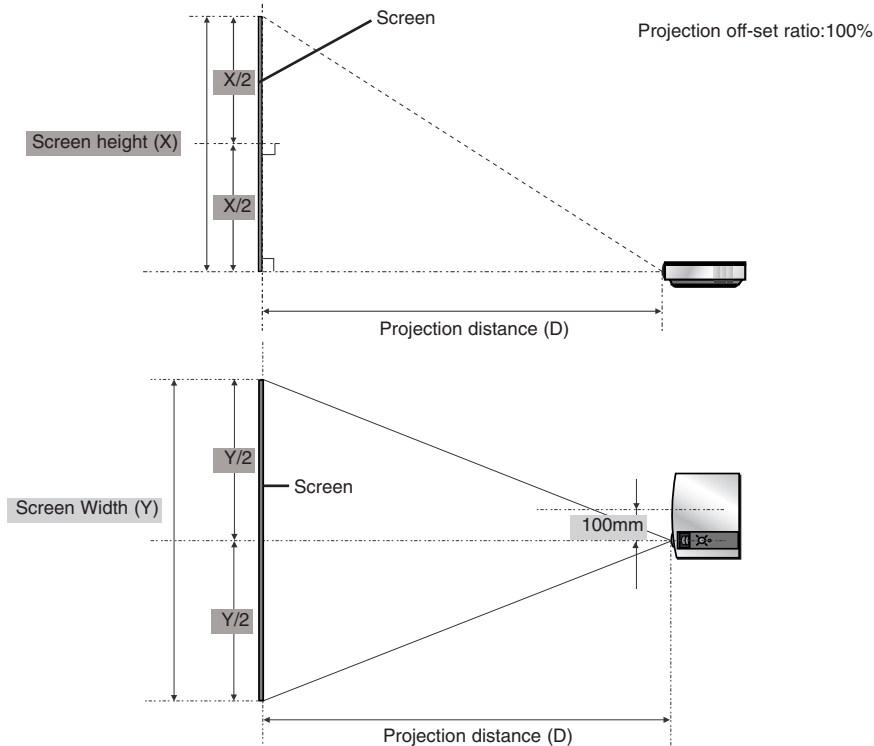

| 4 : 3 Scale          |                    |                      |                    |                     |                    |
|----------------------|--------------------|----------------------|--------------------|---------------------|--------------------|
| Image                |                    |                      |                    | Projection Distance |                    |
| Diagonal Size (inch) | Diagonal Size (mm) | Horizontal Size (mm) | Vertical Size (mm) | Wide Distance (mm)  | Tele Distance (mm) |
| 40                   | 1016               | 813                  | 610                | 1265                | 1506               |
| 50                   | 1270               | 1016                 | 762                | 1586                | 1889               |
| 60                   | 1524               | 1219                 | 914                | 1906                | 2272               |
| 70                   | 1778               | 1422                 | 1067               | 2230                | 2656               |
| 80                   | 2032               | 1626                 | 1219               | 2552                | 3039               |
| 90                   | 2286               | 1829                 | 1372               | 2873                | 3422               |
| 100                  | 2540               | 2032                 | 1524               | 3195                | 3805               |
| 120                  | 3048               | 2438                 | 1829               | 3839                | 4571               |
| 140                  | 3556               | 2845                 | 2134               | 4482                | 5338               |
| 160                  | 4064               | 3251                 | 2438               | 5125                | 6104               |
| 180                  | 4572               | 3658                 | 2743               | 5769                | 6870               |
| 200                  | 5080               | 4064                 | 3048               | 6412                | 7636               |
| 220                  | 5588               | 4470                 | 3353               | 7056                | 8403               |
| 240                  | 6096               | 4877                 | 3658               | 7699                | 9169               |
| 260                  | 6604               | 5283                 | 3962               | 8343                | 9935               |
| 280                  | 7112               | 5690                 | 4267               | 8986                | 10701              |
| 300                  | 7620               | 6096                 | 4572               | 9630                | 11468              |

\* The longest/shortest distance show status when adjusted by the zoom function.

### Using Kensington Security System

- The projector has a 'Kensington' Security System Connector on the side panel. Connect the 'Kensington' Security System cable as below.
- For the detailed installation and use of the Kensington Security System, refer to the user's guide attached to the Kensington Security System set.  
And for further information, contact <http://www.kensington.com>, the internet homepage of the Kensington company that deals with expensive electronic equipment such as notebook PCs or projectors.
- Kensington Security System is an optional item.

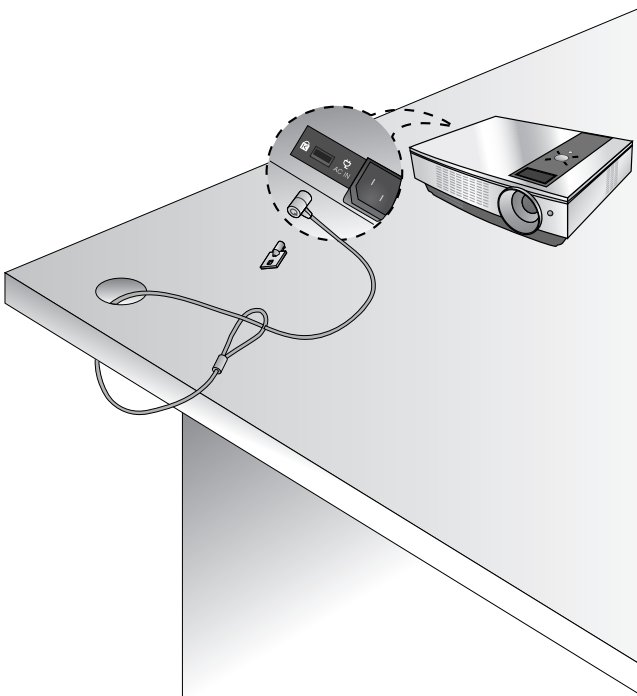

## Turning on the Projector

1. Connect power cord correctly.
2. Remove the lens cap. If it is left on, it could become deformed due to the heat produced by the projection lamp.
3. Press the **POWER** button on the remote control or top cover.  
(Green operation indicator flashes if lamp is in start-up cycle.)
  - An image will appear after the operation indicator light turns (Green).
  - Select the source mode with the SOURCE button.

### Note!

\* Do not disconnect the power cord during the suction/discharge fan in operation. If the power cord is disconnected during the suction/ discharge fan in operation, it may takes longer to activate the lamp after turning on the power and the lifespan of the lamp may be shortened.

## Turning off the Projector

1. Press the **POWER** button on the top cover or remote control.
2. Press the **POWER** button on the top cover or remote control again to turn off the power.
3. If the operation indicator LED is orange and blinking, do not disconnect(10 sec.) the supply until the operation indicator LED is lit constantly (orange).
  - If the operation indicator LED is orange and blinking, the power button on the top cover or on the remote control will not operate.
  - This projector features the Quick Power On/Off function that allows a user to turn it on and off quickly.

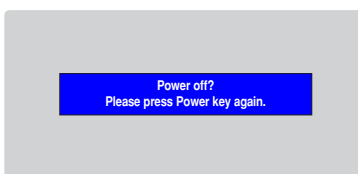

\* What is the **Quick Power On/Off** function?

The projector enters into Standby mode without waiting it is cooled.

If Standby mode continues for a certain amount of time, the projector can operate without cooling when it is turned on.

## Focus and Position of the Screen Image

When an image appears on the screen, check if it is in focus and fits well to the screen.

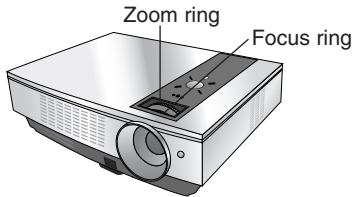

- To adjust the focus of the image, rotate the focus ring which is the outer ring on the lens.
- To adjust the size of the image, rotate the zoom ring which is the inner ring on the lens.

To raise or lower the image on the screen, extend or retract the foot at the bottom of the projector by pushing foot adjusting button as below.

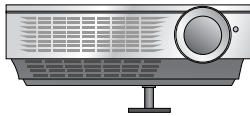

1. While pressing the foot adjusting button, raise or lower the projector to place the screen image in the proper position.
2. Release the button to lock the foot in its new position.
3. Turn the foot at the back left or right to make a fine tune of the length of the projector.  
After raising the front foot, do not press down on the projector.

## Selecting source mode

1. Press the **SOURCE** button on the remote control or the control panel.

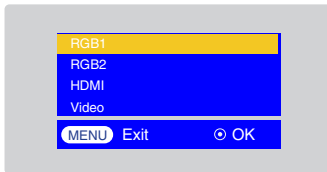

2. After moving into desiring input by pressing \*,\*button,please press the confirm button.

- When a signal cable is plugged in and there 's a signal,the selecting item is activated as white,and if there 's no signal,the selecting item is deactivated as gray.
- If pressing the input selection button,it is possible to select activated item.
- It is possible to watch by selecting RGB 1 for Component 1 input and RGB 2 for Component 2 input,and in case of Component,even though there 's an input signal,the OSD item is not activated.



# Connection

## Connecting to a Desktop PC

- \* You can connect the projector to a computer of VGA, SVGA, XGA and SXGA output.
- \* Refer to page 40 for the supported monitor displays of the projector.
- \* You can select an RGB input from the Monitor Out menu that will be output to RGB OUT(RGB1 or RGB2).

### <To use by connecting to RGB>

Connect the **RGB IN-1** of the projector and the computer output port with computer cable.

- \* You can also connect to the RGB IN-2 port.

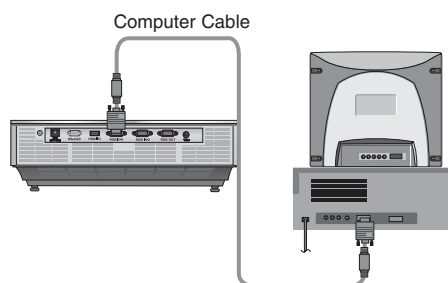

### <To use by connecting to HDMI terminal>

Please connect projector's HDMI IN terminal and computer's output terminal by using HDMI to DVI cable.

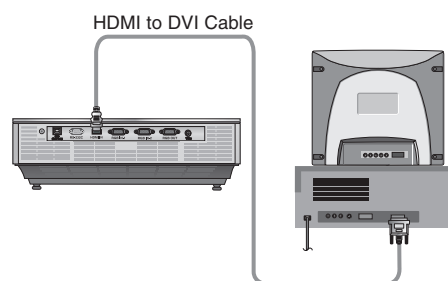

## Connecting to a Notebook PC

### < How to connect >

Connect the **RGB IN-1** of the projector and the computer output port with computer cable.

- \* If you set your computer to output the signal to both the display of your computer and the external projector, the picture of the external projector may not appear properly. In such cases, set the output mode of your computer to output the signal only to the external projector. For details, refer to the operating instructions supplied with your computer.

- \* You can also connect to the RGB IN-2 port.

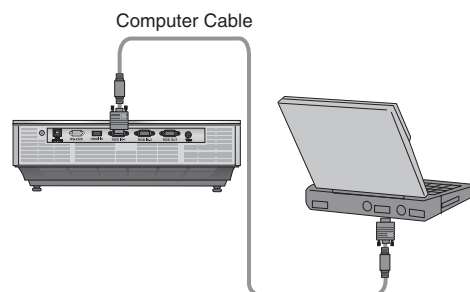

## Connecting to a Video Source

\* You can connect a VCR, a camcorder or any other compatible video image source to the projector.

### < How to connect >

- a. Connect the Video input jacks of the projector to the output jacks of the A/V source with Video cable.

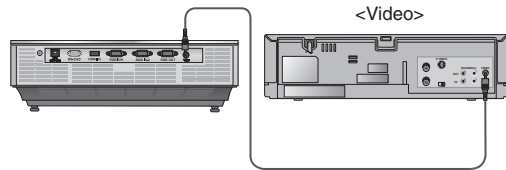

## Connecting to a DVD

\* The output jacks (Y, Pb, Pr) of the DVD might be labeled as Y, Pb, Pr / Y, B-Y, R-Y / Y, Cb, Cr according to the equipment.

### < How to connect >

- a. Connect the DVD Component cable to the **RCA to D-Sub Adapter** and then connect the **RCA to D-Sub Adapter to RGB IN-1** of the projector.

\* When connecting the component cable, match the jack colors with the component cable. (Y=green, Pb=blue, Pr=red)

\* You can also connect to the RGB IN-2 port.

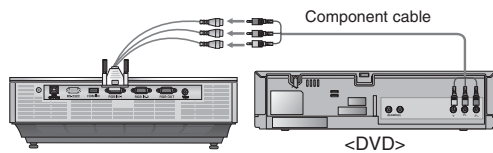

| Signal | Component |
|--------|-----------|
| 480i   | ○         |
| 480p   | ○         |
| 720p   | ○         |
| 1080i  | ○         |
| 576i   | ○         |
| 576p   | ○         |

## Connecting to a D-TV Set-Top Box

\* To receive D-TV programmes, it is necessary to purchase a D-TV receiver (Set-Top Box) and connect it to the projector.  
 \* Please refer to the owner's manual of the D-TV Set-Top Box for the connection between projector and D-TV Set-Top Box.

### < How to connect a HDMI source >

- a. Connect the **HDMI IN** terminal of the projector to the **HDMI** output terminal of the D-TV Set-Top Box via HDMI cable.

- b. Use a DTV receiver with DTV 480p(576p)/720p/1080i mode.

\* No support of audio.

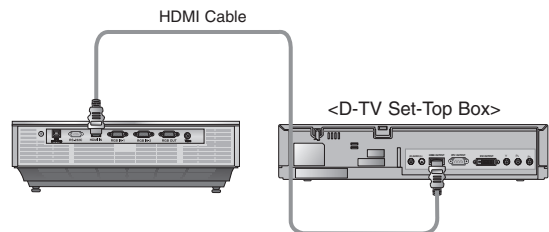

### < How to connect a Component source >

- a. Connect the D-TV Set-Top Box Component cable to the **RCA to D-Sub Adapter** and then connect the **RCA to D-Sub Adapter to RGB IN-1** of the projector.

\* When connecting the component cable, match the jack colors with the component cable. (Y=green, Pb=blue, Pr=red)

\* You can also connect to the RGB IN-2 port.

\* No support of audio.

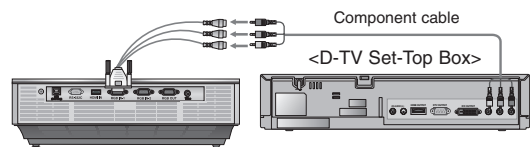





# Function

\* In this manual, the OSD(On Screen Display) may be different from your Projector's because it is just an example to help with the Projector operation.

\* This operating guide explains operation of RGB(PC) mode mainly.

## Video Menu Options

### Adjusting Video

1. Press the **MENU** button and then use < , > button to select the  menu.
2. Press the ^ , v button to select a video item you want to adjust.
3. Press the < , > button to adjust the screen condition as you want.
  - Each adjustment of  menu options will not affect other inputs.
  - When receiving an NTSC signal, the picture item **Tint** is displayed and can be adjusted.(60Hz only)
  - You can adjust contrast by pressing the  button on the remote control.
  - You can adjust brightness by pressing the  button on the remote control.
  - Press the **MENU** button twice or the **EXIT** button to exit the menu screen.

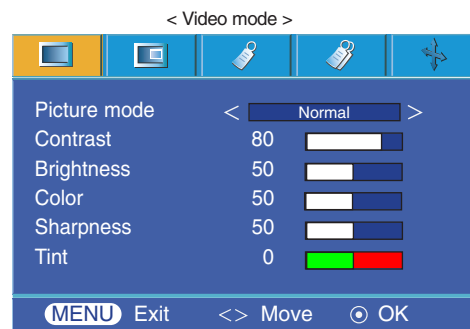
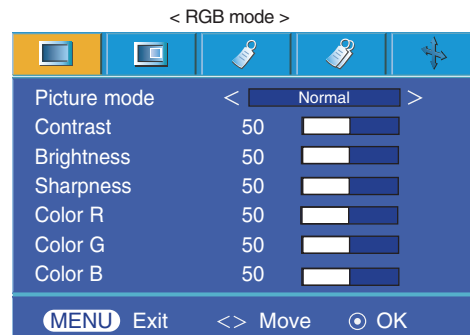

### Picture mode

\* Use Picture mode function to set the projector for the best picture appearance.

1. Press the **MODE** button on the remote control.
2. Press the < , > button to adjust the screen condition as you want.
  - Each press of the < , > button changes the screen as shown below.

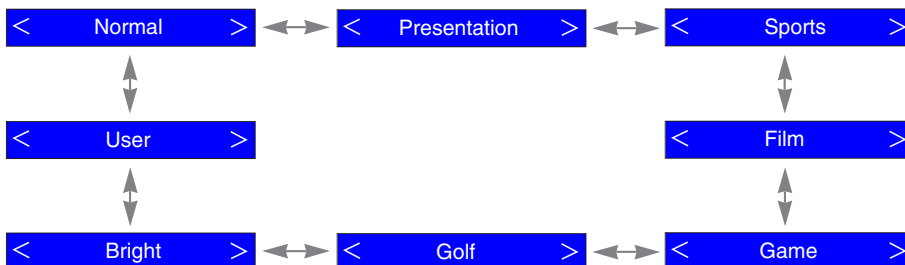

- You can use this function through the **MENU** button.
- To exit the menu display, press the **EXIT** button.

## Color Temperature Control

- To initialize values (reset to default settings), select the **Natural** option.

1. Press the **MENU** button and then use **<** , **>** button to select the  menu.
2. Press the **^** , **v** button to select **Color temp.** item.
3. Press the **<** , **>** button to make desired adjustments.

- Each press of the **<** , **>** button changes the screen as shown below.

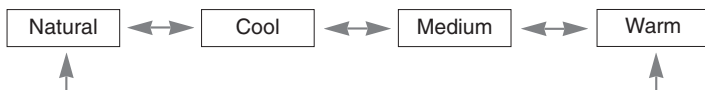

- This function can be inactivated depends on the Picture mode. When the Picture mode is set in Bright or Golf, you can't adjust Color temperature function.
- Press the **MENU** button twice or the **EXIT** button to exit the menu screen.

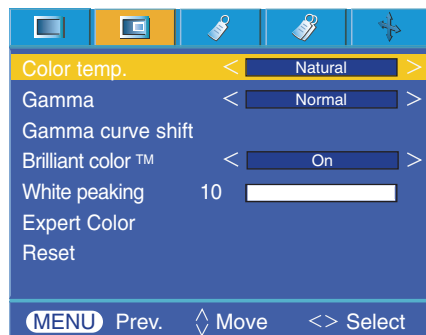

## Gamma Function

1. Press the **GAMMA** button on the remote control.
2. Press the **<** , **>** button to select the screen condition you want.

- Each press of the **<** , **>** button changes the screen as shown below.

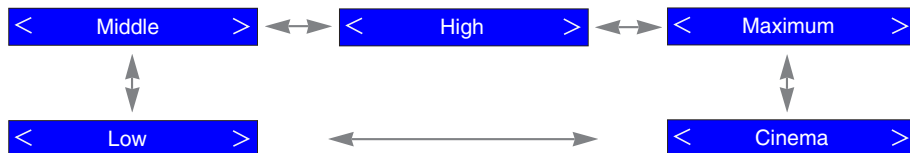

- You can use this function through the **MENU** button.
- To exit the menu display, press the **EXIT** button.

## Gamma curve shift Function

- This function shifts the gamma curves for Red, Green and Blue individually to adjust brightness.

1. Press the **MENU** button and then use **<** , **>** button to select the  menu.
2. Press the **^** , **v** button to select **Gamma curve shift** item.
3. Press the **OK** button.
4. When the window below appears, press **^** , **v** button to move between the items and the **<** , **>** buttons to adjust the screen as you want.

- **Gamma curve shift Red, Green, Blue** can be adjusted between -20 and 20.
- Press the **MENU** button twice or the **EXIT** button to exit the menu screen.

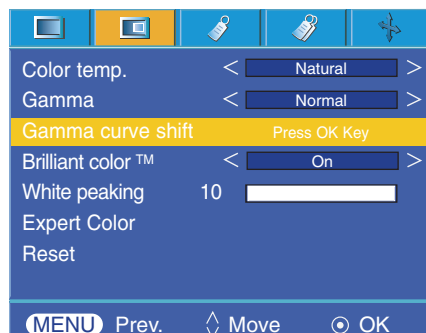
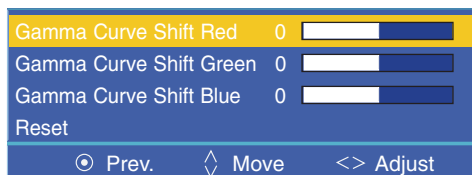

## Brilliant color™ Function

1. Press the **MENU** button and then use < , > button to select the  menu.
2. Press the ^ , v button to select **Brilliant color™** item.
3. Press the < , > button to select On or Off.
  - Press the **MENU** button twice or the **EXIT** button to exit the menu screen.

\* What is the **Brilliant color™** function?

This function increases the entire brightness of the screen or decreases it a little to make the rich grayscale color.

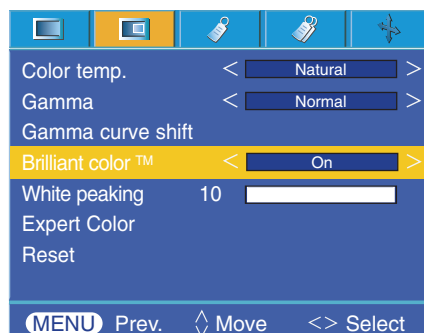

## White peaking Function

1. Press the **W.PEAK** button on the remote control.
2. Press the < , > button to select the screen condition you want.
  - The default value may change depending on input mode.
  - **White peaking** can be adjusted from 0 to 10.
  - Adjust to higher setting to achieve brighter picture. Adjust to lower setting for darker picture.
  - You can use this function through the **MENU** button.
  - To exit the menu display press the **EXIT** button.

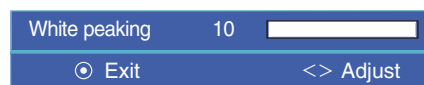

## Black level Function

1. Press the **MENU** button and then use < , > button to select the  menu.
2. Press the ^ , v button to select **Black level** item.
3. Press the < , > button to select Low or High.
  - This function works in the following mode : HDMI(Only activates in DTV signal), Video
  - To exit the menu display, repeatedly press the **MENU** button.

\* What is the **Black level** function?

When you watch the movie, this function adjusts the set to the best picture appearance. Adjusting the contrast and the brightness of the screen using the black level of the screen.

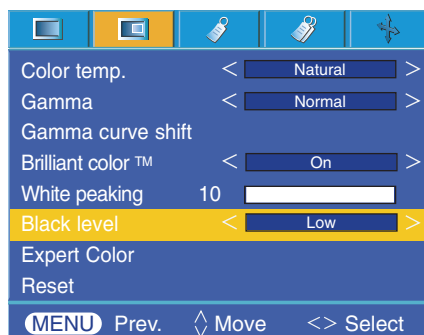

## Expert color Function

- This function allows a user to adjust the Gain, Saturation and Hue for Red, Green, Blue, Cyan, Magenta and Yellow individually.

1. Press the **MENU** button and then use  $\leftarrow$ ,  $\rightarrow$  button to select the  menu.
2. Press the  $\wedge$ ,  $\vee$  button to select **Expert Color** item.
3. Press the  $\odot$  **OK** button.

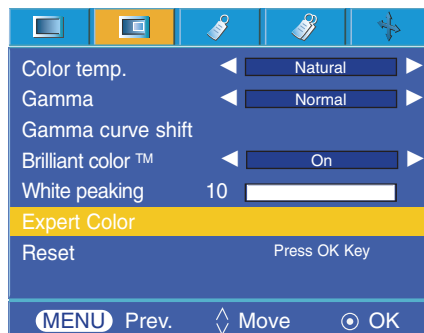
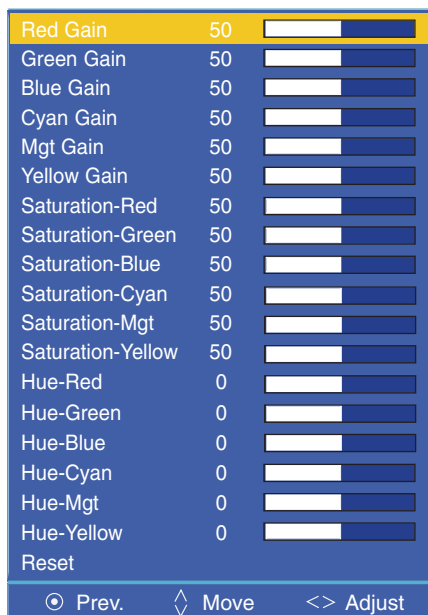

4. When the window above appears, press  $\leftarrow$ ,  $\rightarrow$  button.



5. Press the  $\wedge$  or  $\vee$  button to move between the items and the  $\leftarrow$  or  $\rightarrow$  buttons to adjust the screen as you want.

- **Red, Green, Blue, Cyan, Magenta** and **Yellow Gain** can be adjusted between 0 and 100.
- **Saturation-Red, Green, Blue, Cyan, Magenta** and **Yellow** can be adjusted between 0 and 100.
- **Hue-Red, Green, Blue, Cyan, Magenta** and **Yellow** can be adjusted between -50 and 50.
- Press the **MENU** button twice or the **EXIT** button to exit the menu screen.
- An advanced settings function is possible to be saved according to an image mode.

## Reset

- To return to the factory default settings, select [**Reset**] with  $\wedge$ ,  $\vee$  buttons and press  $\odot$  **OK** button.

## Special Menu Options

### Selecting Language

1. Press the **MENU** button and then use < , > button to select the  menu.
2. Press the  $\wedge$  ,  $\vee$  button to select **Language** item.
3. Press the < , > button to select the language you want to use.
  - On-Screen-Display (OSD) is displayed in the selected language.
  - Press the **MENU** button twice or the **EXIT** button to exit the menu screen.

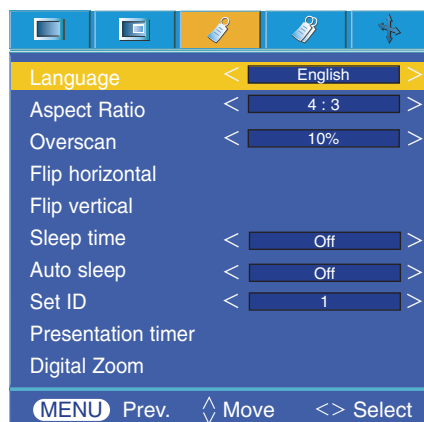

### Using ARC Function

1. Press the **RATIO** button.  
Each press of the button changes the display as below.

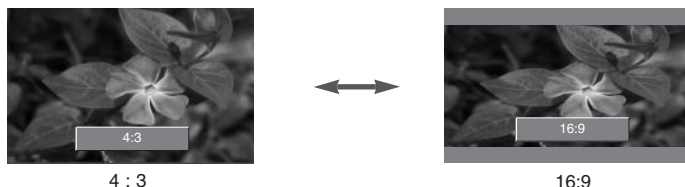

- You can also use this function by using the **MENU** button.

### Overscan Function

1. Press the **MENU** button and then use < , > button to select the  menu.
2. Press the  $\wedge$  ,  $\vee$  button to select **Overscan** item.
3. Press the < , > buttons.
  - The **Overscan** function can be adjusted only in RGB, HDMI and Component modes.
  - The **Overscan** function can be adjusted between Off and 10%.
  - The **Overscan** function can not be adjusted if the Zoom +/- in Digital Zoom is set to a value other than 100%.
  - Press the **MENU** button twice or the **EXIT** button to exit the menu screen.

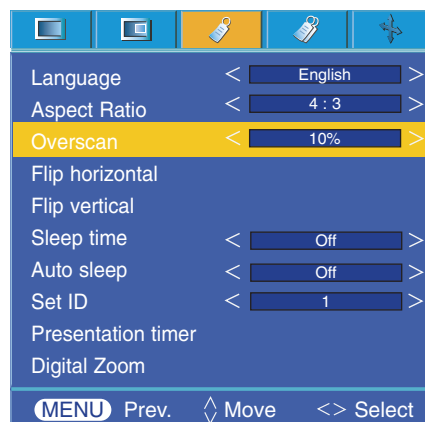

### Flip horizontal Function

\* This function reverses the projected image horizontally.  
Use this function when rear projecting an image.

1. Press the **MENU** button and then use < , > button to select the  menu.
2. Press the ^ , v button to select **Flip horizontal** item.
3. Press the **OK** button to see reversed image.
  - Each time you press the **OK** button, the image will be reversed.
  - Press the **MENU** button twice or the **EXIT** button to exit the menu screen.



### Flip vertical Function

\* This function reverses the projected image vertically.  
\* When you hang the projector upside down from the ceiling, you will need to reverse the image vertically and horizontally.

1. Press the **MENU** button and then use < , > button to select the  menu.
2. Press the ^ , v button to select **Flip vertical** item.
3. Press the **OK** button to see reversed image.
  - Each time you press the **OK** button, the image will be reversed.
  - Press the **MENU** button twice or the **EXIT** button to exit the menu screen.

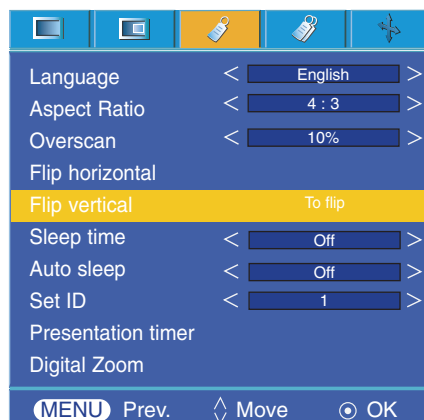

### Sleep time Function

\* The sleep timer turns the projector off at the preset time.

1. Press the **SLEEP TIME** button of remote control.
2. Press the < , > button to select the desired preset time.
  - Each press of the < , > button changes the screen as shown below.

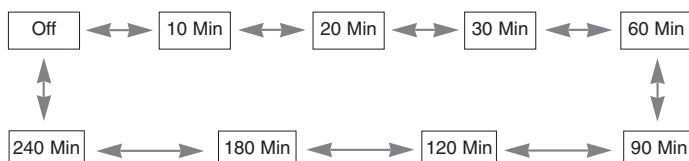

- You can use this function through the **MENU** button.
- To exit the menu display press the **EXIT** button.



## Auto sleep Function

\* This function turns the projector off automatically after the preset time is passed when there is no signal.

1. Press the **MENU** button and then use < , > button to select the  menu.
2. Press the ^ , v button to select **Auto sleep** item.
3. Press the < , > button to select the desired preset time.

- Press the **MENU** button twice or the **EXIT** button to exit the menu screen.

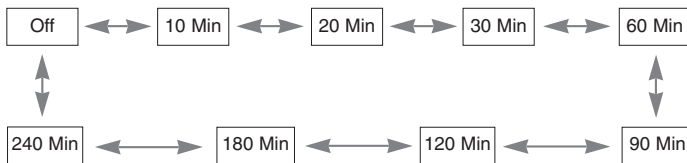

## Presentation timer Function

1. Press the **TIMER** button of remote control.
2. Press the ^ , v button to select **Time alarm** or **Time keeper** item.

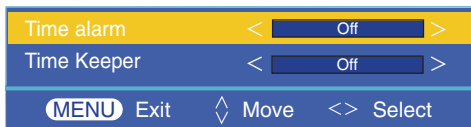

3. Press the < , > button to select the desired preset time.
4. The timer starts to operate if you select specific time.

- Time alarm function : If you select a specific time, it is displayed in minute units. After 1 minute, the remaining time is displayed at the bottom right of the screen, and then disappears after 5 seconds. When the remaining time is displayed, other OSD windows are closed. When the set time is reached, '0 minute' flickers 10 times at 1 second intervals, and then disappears.
- Time keeper function : If you select a specific time, it continues to be displayed in minute(') and second(") units. Even though other OSD windows appear, the remaining time is displayed again after the windows are closed. When the set time is reached, '0' 00" flickers 10 times at 1 second intervals, and then disappears.

5. If the set time disappears because of the use of other menus, press the **TIMER** button on a remote to display the set time again.

- The **Time alarm** function and the **Time keeper** function cannot be used at the same time.
- The **Time alarm** function can be set from 5 to 60 minutes at 5 minute intervals (Off, 5, 10, 15, 20, ..... 55, 60 minutes).
- The **Time keeper** function can be set from 1 to 10 minutes at 1 minute intervals, and from 10 to 60 minutes at 5 minute intervals (Off, 1, 2, 3, 4, ..... 8, 9, 10, 15, 20, 25, ..... 55, 60 minutes).
- You can use this function through the **MENU** button.
- Press the **EXIT** button to exit the menu screen.

## Using Digital Zoom Function

\* This function is available only in RGB input mode. The Zoom -/+ and Position values return to their defaults when you change the SOURCE or input signal, or turn the power off.

### Adjusting the Zoom

1. Press the **ZOOM** button on the remote control.
2. Press the  $\wedge$  ,  $\vee$  button to select **Zoom -/+** item.

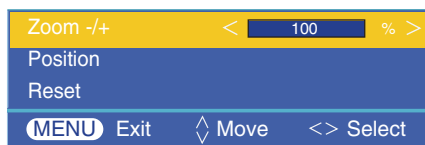

3. Press the  $<$  ,  $>$  button to adjust Zoom -/+ to your choice.

- You can adjust Zoom -/+ in 5% increments from 100% to 250%.
- You can also use this function by using the **MENU** button.
- Press the **EXIT** button to exit the menu screen.

### Adjusting the Position

1. Press the **ZOOM** button on the remote control.
2. Press the  $\wedge$  ,  $\vee$  button to select **Position** item.

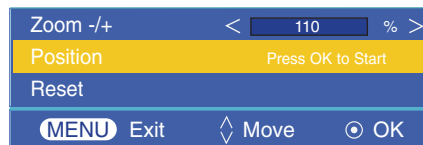

3. Press the  $\odot$  **OK** button. When the window below appears at the bottom right corner of the screen, press the  $\wedge$  /  $\vee$  /  $\wedge$  /  $\vee$  to adjust the position. When the arrow turns black, maximum adjustment has been reached and no further adjustment can be made.



- Position is activated only when Zoom -/+ is set to more than 105%.
- You can also use this function by using the **MENU** button.
- Press the **EXIT** button to exit the menu screen.

### To use keystone function

1. Press the **KEYSTONE** button on the remote control.

2. Press the < , > button to select a item.

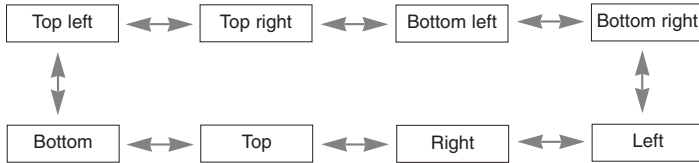

3. Press the  $\wedge$  ,  $\vee$  button to select the item (H or V) you want, and press the < , > button to adjust it.

- You can adjust each item from 0 to 100.
- The default value may change depending on input mode.
- You can also use this function by using the **MENU** button.
- Press the **MENU** button to exit the menu screen.

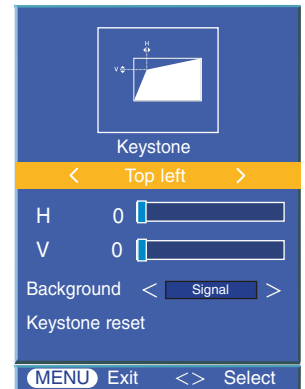

### To select a background image

1. Press the **KEYSTONE** button on the remote control.

2. Please select a **Background** image by  $\wedge$  ,  $\vee$  button.

3. Please select desiring item by < , > button.

- If there 's no input signal, it is possible to adjust keystone by using the adjusting pattern.

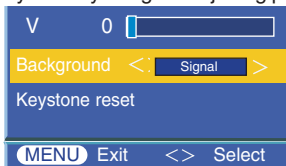

### To initialize keystone

1. Press the **KEYSTONE** button on the remote control.

2. Please select keystone initialization by  $\wedge$  ,  $\vee$  button.

3. Press the **OK** button. Keystone adjusting figure returns to the factory price.



### Using Blank Function

\* This function may be effective if you need to get the attention of the audience during presentations, meetings or briefings.

1. Press the **BLANK** button.

- The screen turns off to a background color.
- You can choose the background color.  
(Refer to 'Selecting blank image color')

2. Press any button to cancel the blank function.

- To temporarily turn off the lamp, press BLANK on the remote control. Do not block the projection lens with any objects when the projector is under operation as this could cause the objects to become heated and deformed or even cause a fire.

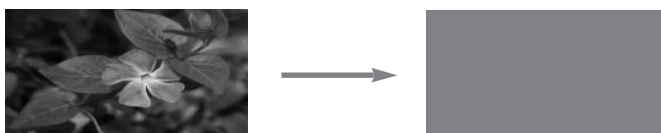



### Selecting Blank image

1. Press the **MENU** button and then use < , > button to select the  menu.
2. Press the ^ , v button to select **Blank image** item.
3. Press the < , > button to select the color you want to use.

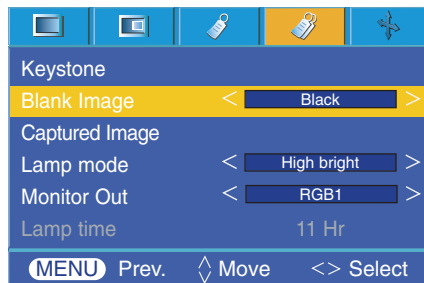
- Background image will be altered to the selected Blank image function.
- You can choose blue, black, green, or captured image for the Blank image.
- If you have a captured image, you can use it as a blank image instead of logo image. And you only have one last captured image.
- When you select the Captured image, displays a logo, if you don't have a captured image.
- Press the **MENU** button twice or the **EXIT** button to exit the menu screen.



### Captured Image Function

1. Press the **MENU** button and then use < , > button to select the  menu.
2. Press the ^ , v button to select **Captured Image** item.
3. Press the  **OK** button to capture actual screen image.

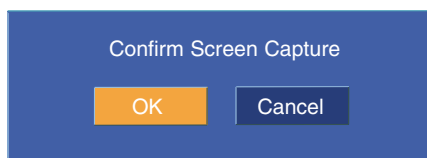

4. Press the  **OK** button again to save Screen capture image.
- You can use the captured image as a Blank image.
  - You can not use the remote control when this function is in use.
  - If you want see your captured image, select Captured image in the Blank image function.
  - Press the **MENU** button twice or the **EXIT** button to exit the menu screen.

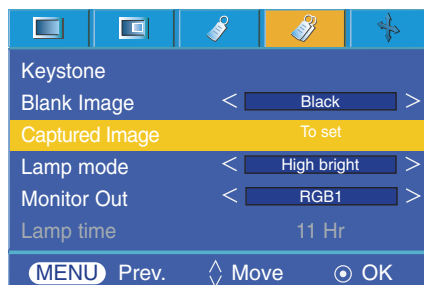

### Lamp mode Function

1. Press the **LAMP** button of remote control.
  2. Press the < , > button to adjust the screen condition as you want.
- Each press of the < , > button changes the screen as shown below.



- The menu automatically disappears at specific temperature (more than 35°C).
- It is automatically changed into power saving mode at specific temperature (more than 35°C).
- You can use this function through the **MENU** button.
- To exit the menu display, press the **EXIT** button.

## Using Monitor out Function

\* You can select either of the two RGB inputs.

1. Press the **MENU** button and then use < , > button to select the  menu.
2. Press the ^ , v button to select **Monitor Out** item.
3. Press the < , > button to select **RGB1, RGB2** or **Auto**.
  - Press the **MENU** button twice or the **EXIT** button to exit the menu screen.
  - Auto mode is the mode to output an image of currently seeing input among RGB1 or RGB2 input.

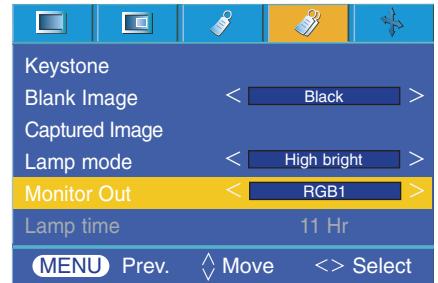

## Checking lamp time

1. Press the **MENU** button and then use < , > button to select the  menu.
2. The used lamp time is displayed.
  - When projector lamp is reaching the end of its life, the lamp indicator will turn red. (Refer to the page 10.)
  - The lamp warning LED illuminates red continuously in the case of excessive lamp time.
  - Press the **MENU** button twice or the **EXIT** button to exit the menu screen.

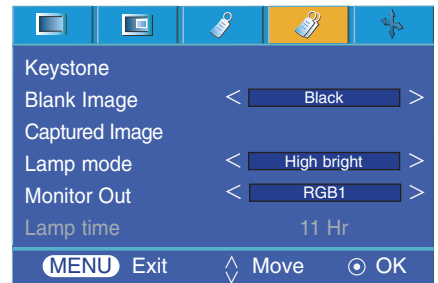

## Using Still Function

1. Press the **STILL** button of remote control.

\* You can freeze the input image.



2. To exit STILL, press any button .

\* The STILL function will release automatically after approximately 10 minutes.

## Screen Menu Options

### Auto configure Function

\* This function assures you of getting the best video quality by automatically adjusting the horizontal size and synchronization of the image.

\* Auto Tracking function works in RGB PC input only.

1. Press the **AUTO** button of the remote controller.
  - Image positioning and synchronization are automatically adjusted.
2. If any more manual adjustment is needed according to the various PC mode inputs even after the auto-correction, execute **Phase, Clock, Horizontal** and **Vertical** function in  menu. In certain circumstances, you can't get the best picture quality by only using auto-correction.

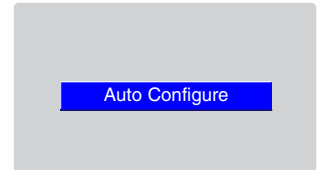

### Note!

You can also use this function by using the MENU button. (Only in RGB mode)  
For best results, perform this function while displaying a still image.

### Using Phase Function

1. Press the **MENU** button and then use **<**, **>** button to select the  menu.
2. Press the **^**, **v** button to select **Phase** item.
3. Press the **<**, **>** button to make desired adjustments.

- **Phase** adjustment range is 0 ~63.
- The variable range can be different depends on input resolutions.
- Press the **MENU** button twice or the **EXIT** button to exit the menu screen.



### Using Clock Function

1. Press the **MENU** button and then use **<**, **>** button to select the  menu.
2. Press the **^**, **v** button to select **Clock** item.
3. Press the **<**, **>** button to make desired adjustments.

- **Clock** adjustment range is -20 ~ 20.
- The variable range can be different depends on input resolutions.
- Press the **MENU** button twice or the **EXIT** button to exit the menu screen.

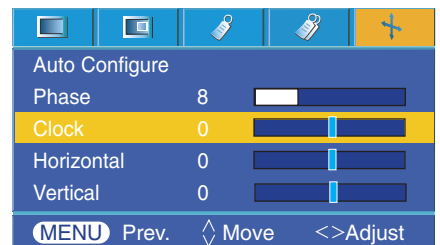

### Using Horizontal Function

1. Press the **MENU** button and then use < , > button to select the menu. ✚
2. Press the ^ , v button to select **Horizontal** item.
3. Press the < , > button to make desired adjustments.

- **Horizontal** adjustment range is -50 ~ 50.
- The variable range can be different depends on input resolutions.
- Press the **MENU** button twice or the **EXIT** button to exit the menu screen.

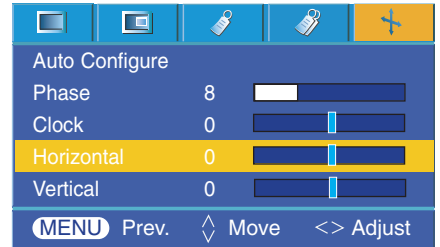

### Using Vertical Function

1. Press the **MENU** button and then use < , > button to select the menu. ✚
2. Press the ^ , v button to select **Vertical** item.
3. Press the < , > button to make desired adjustments.

- **Vertical** adjustment range is -25 ~ 25.
- The variable range can be different depends on input resolutions.
- Press the **MENU** button twice or the **EXIT** button to exit the menu screen.

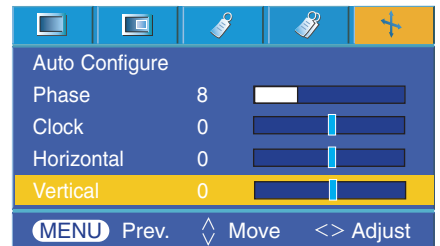

# External Control Device Setup

\* Connect the RS-232C input jack to an external control device (such as a computer) and control the Projector's functions externally.

## SET ID

1. Press the **MENU** button and then use **<** , **>** button to select the  menu.
2. Press the **OK** button and then use **^** , **v** button to select **Set ID** item.
3. Press the **<** , **>** button to select your desired number.  
Press the **OK** button to save the selected number.

- The adjustment range of **Set ID** is 1~99.
- Only the projector with the specified ID number will operate from the remote control.
- Press the **MENU** button twice or the **EXIT** button to exit the menu screen.



## How to connect external control equipment

- Connect the serial port of the PC to the RS-232C jack on the projector back panel.
- RS-232C cable is not supplied with the projector.

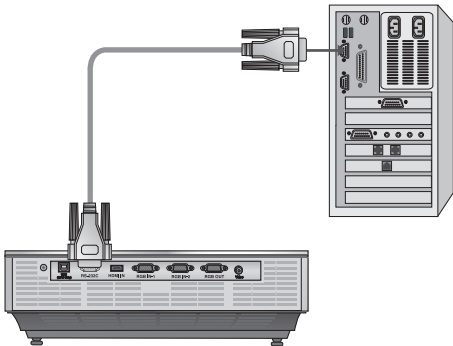

- Use the RS232C cable to control the projector externally (Refer to Fig.1).

<Fig.1, RS-232 Interface Cable>

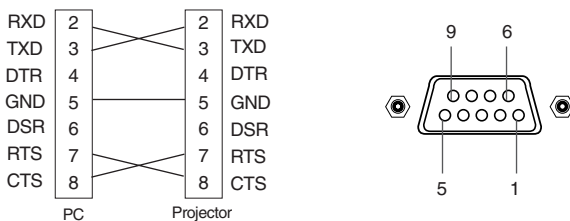

\* 1, 9 Pin No Connection

## Communication Parameter Setup

- Baud Rate : 9600 bps(UART)
- Data Length : 8 bit
- Parity : none
- Stop bit : 1 bit
- Flow Control : none
- Communication code : ASCII code



## Command Reference List

|                                    | Command1 | Command2 | Data<br>(Hexadecimal) |
|------------------------------------|----------|----------|-----------------------|
| 01. Power                          | k        | a        | 0 ~ 1                 |
| 02. Aspect Ratio                   | k        | c        | 1 ~ 2                 |
| 03. Screen Mute                    | k        | d        | 0 ~ 1                 |
| 04. Contrast                       | k        | g        | 0 ~ 64                |
| 05. Brightness                     | k        | h        | 0 ~ 64                |
| 06. Color                          | k        | i        | 0 ~ 64                |
| 07. Tint                           | k        | j        | 0 ~ 64                |
| 08. Sharpness                      | k        | k        | 0 ~ 64                |
| 09. OSD Select                     | k        | l        | 0 ~ 1                 |
| 10. Remote Control Lock / Key Lock | k        | m        | 0 ~ 1                 |
| 11. Color Temperature              | k        | u        | 0 ~ 3                 |
| 12. Red ADC gain adjustment        | j        | w        | 0 ~ 64                |
| 13. Green ADC gain adjustment      | j        | y        | 0 ~ 64                |
| 14. Blue ADC gain adjustment       | j        | z        | 0 ~ 64                |
| 15. Low Power                      | j        | q        | 0 ~ 1                 |
| 16. Auto configuration             | j        | u        | 1                     |
| 17. Input Select                   | x        | b        | *                     |
| 18. Key                            | m        | c        | Key code              |

\* Refer to the detailed information for data with [\*] mark.

## □ Communication Protocol

\* Real data mapping 1

| Decimal | Hexadecimal | Decimal | Hexadecimal | Decimal | Hexadecimal | Decimal | Hexadecimal | Decimal | Hexadecimal |
|---------|-------------|---------|-------------|---------|-------------|---------|-------------|---------|-------------|
| 0       | 0           |         |             |         |             |         |             |         |             |
| 1       | 1           | 21      | 15          | 41      | 29          | 61      | 3d          | 81      | 51          |
| 2       | 2           | 22      | 16          | 42      | 2a          | 62      | 3e          | 82      | 52          |
| 3       | 3           | 23      | 17          | 43      | 2b          | 63      | 3f          | 83      | 53          |
| 4       | 4           | 24      | 18          | 44      | 2c          | 64      | 40          | 84      | 54          |
| 5       | 5           | 25      | 19          | 45      | 2d          | 65      | 41          | 85      | 55          |
| 6       | 6           | 26      | 1a          | 46      | 2e          | 66      | 42          | 86      | 56          |
| 7       | 7           | 27      | 1b          | 47      | 2f          | 67      | 43          | 87      | 57          |
| 8       | 8           | 28      | 1c          | 48      | 30          | 68      | 44          | 88      | 58          |
| 9       | 9           | 29      | 1d          | 49      | 31          | 69      | 45          | 89      | 59          |
| 10      | a           | 30      | 1e          | 50      | 32          | 70      | 46          | 90      | 5a          |
| 11      | b           | 31      | 1f          | 51      | 33          | 71      | 47          | 91      | 5b          |
| 12      | c           | 32      | 20          | 52      | 34          | 72      | 48          | 92      | 5c          |
| 13      | d           | 33      | 21          | 53      | 35          | 73      | 49          | 93      | 5d          |
| 14      | e           | 34      | 22          | 54      | 36          | 74      | 4a          | 94      | 5e          |
| 15      | f           | 35      | 23          | 55      | 37          | 75      | 4b          | 95      | 5f          |
| 16      | 10          | 36      | 24          | 56      | 38          | 76      | 4c          | 96      | 60          |
| 17      | 11          | 37      | 25          | 57      | 39          | 77      | 4d          | 97      | 61          |
| 18      | 12          | 38      | 26          | 58      | 3a          | 78      | 4e          | 98      | 62          |
| 19      | 13          | 39      | 27          | 59      | 3b          | 79      | 4f          | 99      | 63          |
| 20      | 14          | 40      | 28          | 60      | 3c          | 80      | 50          | 100     | 64          |

\* Real data mapping 2

| Decimal | Hexadecimal | Decimal | Hexadecimal | Decimal | Hexadecimal | Decimal | Hexadecimal | Decimal | Hexadecimal |
|---------|-------------|---------|-------------|---------|-------------|---------|-------------|---------|-------------|
| -50     | 0           |         |             |         |             |         |             |         |             |
| -49     | 1           | -29     | 15          | -9      | 29          | 11      | 3d          | 31      | 51          |
| -48     | 2           | -28     | 16          | -8      | 2a          | 12      | 3e          | 32      | 52          |
| -47     | 3           | -27     | 17          | -7      | 2b          | 13      | 3f          | 33      | 53          |
| -46     | 4           | -26     | 18          | -6      | 2c          | 14      | 40          | 34      | 54          |
| -45     | 5           | -25     | 19          | -5      | 2d          | 15      | 41          | 35      | 55          |
| -44     | 6           | -24     | 1a          | -4      | 2e          | 16      | 42          | 36      | 56          |
| -43     | 7           | -23     | 1b          | -3      | 2f          | 17      | 43          | 37      | 57          |
| -42     | 8           | -22     | 1c          | -2      | 30          | 18      | 44          | 38      | 58          |
| -41     | 9           | -21     | 1d          | -1      | 31          | 19      | 45          | 39      | 59          |
| -40     | a           | -20     | 1e          | 0       | 32          | 20      | 46          | 40      | 5a          |
| -39     | b           | -19     | 1f          | 1       | 33          | 21      | 47          | 41      | 5b          |
| -38     | c           | -18     | 20          | 2       | 34          | 22      | 48          | 42      | 5c          |
| -37     | d           | -17     | 21          | 3       | 35          | 23      | 49          | 43      | 5d          |
| -36     | e           | -16     | 22          | 4       | 36          | 24      | 4a          | 44      | 5e          |
| -35     | f           | -15     | 23          | 5       | 37          | 25      | 4b          | 45      | 5f          |
| -34     | 10          | -14     | 24          | 6       | 38          | 26      | 4c          | 46      | 60          |
| -33     | 11          | -13     | 25          | 7       | 39          | 27      | 4d          | 47      | 61          |
| -32     | 12          | -12     | 26          | 8       | 3a          | 28      | 4e          | 48      | 62          |
| -31     | 13          | -11     | 27          | 9       | 3b          | 29      | 4f          | 49      | 63          |
| -30     | 14          | -10     | 28          | 10      | 3c          | 30      | 50          | 50      | 64          |

# External control device setup

## 1. Transmission

```
[Command1][Command2][Set ID][Data][Cr]
```

- \* [Command 1] : First command to control the set.(k, j, x, ASCII code, 1 Character)
- \* [Command 2] : Second command to control the set..(ASCII code, 1 Character)
- \* [Set ID] : You can adjust the set ID to choose desired projector ID number in special menu. See previous page. Adjustment range is 1 ~ 99. When selecting Set ID '0', every connected projector set is controlled. Refer to 'Real data mapping 1'.
- \* [DATA] : To transmit command data. Transmit 2 character when organized ASCII code.  
\* Transmit 'FF' data to read status of command.
- \* [Cr] : Carriage Return  
ASCII code '0x0D'
- \* [ ] : ASCII code character correspond to "Space Bar" which is in order to classify command, set ID and Data.

## 2. OK Acknowledgement

```
[Command2] [ ] [Set ID] [ ] [OK] [Data] [x]
```

- \* The Projector transmits ACK (acknowledgement) based on this format when receiving normal data. At this time, if the data is data read mode, it indicates present status data. If the data is data write mode, it returns the data of the PC computer.

## 3. Error Acknowledgement

```
[Command2] [ ] [Set ID] [ ] [NG] [Data] [x]
```

- \* The Projector transmits ACK (acknowledgement) based on this format when receiving abnormal data from non-viable functions or communication errors.

Data : [1] : illegal code(This command is not supported.)  
 [2] : not support function(This function doesn't work.)  
 [3] : wait and retry(Try again a few minute later.)

## 01. Power (Command:ka)

→ To control Power On/Off of the Projector.

### Transmission

```
[k] [a] [ ] [Set ID] [ ] [Data] [Cr]
```

Data 0 : Power Off  
 1 : Power On

### Ack

```
[a] [ ] [Set ID] [ ] [OK] [Data] [x]
```

Data 0 : Power Off  
 1 : Power On

→ To show Power On/Off status.

### Transmission

```
[k] [a] [ ] [Set ID] [ ] [FF] [Cr]
```

### Ack

```
[a] [ ] [Set ID] [ ] [OK] [Data] [x]
```

Data 0 : Power Off  
 1 : Power On

- \* In like manner, if other functions transmit '0xFF' data based on this format, Acknowledgement data feed back presents status about each function.

## 02. Aspect Ratio (Command:kc)

→ To adjust the screen format.

### Transmission

```
[k] [c] [ ] [Set ID] [ ] [Data] [Cr]
```

Data 1 : 4:3  
 2 : 16:9

### Ack

```
[c] [ ] [Set ID] [ ] [OK] [Data] [x]
```

Data 1 : 4:3  
 2 : 16:9

**03. Screen Mute (Command:kd)**

→ To select screen mute on/off.

Transmission

[k] [d] [ ] [Set ID] [ ] [Data] [Cr]  
 Data 0 : Screen Mute Off (Picture On)  
 1 : Screen Mute On (Picture Off)

Ack

[d] [ ] [Set ID] [ ] [OK] [Data] [x]  
 Data 0 : Screen Mute Off (Picture On)  
 1 : Screen Mute On (Picture Off)

**04. Contrast (Command:kg)**

→ To adjust screen contrast.

Transmission

[k] [g] [ ] [Set ID] [ ] [Data] [Cr]  
 Data Min : 0 ~ Max : 64  
 \* Refer to 'Real data mapping 1'.

Ack

[g] [ ] [Set ID] [ ] [OK] [Data] [x]  
 Data Min : 0 ~ Max : 64

**05. Brightness (Command:kh)**

→ To adjust screen brightness.

Transmission

[k] [h] [ ] [Set ID] [ ] [Data] [Cr]  
 Data Min : 0 ~ Max : 64  
 \* Refer to 'Real data mapping 1'.

Ack

[h] [ ] [Set ID] [ ] [OK] [Data] [x]  
 Data Min : 0 ~ Max : 64

**06. Color (Command:ki)**

→ To adjust the screen color. (Video/Component)

Transmission

[k] [i] [ ] [Set ID] [ ] [Data] [Cr]  
 Data Min : 0 ~ Max : 64  
 \* Refer to 'Real data mapping 1'.

Ack

[i] [ ] [Set ID] [ ] [OK] [Data] [x]  
 Data Min : 0 ~ Max : 64

**07. Tint (Command:kj)**

→ To adjust the screen tint.(Video/Component 60Hz or NTSC signal)

Transmission

[k] [j] [ ] [Set ID] [ ] [Data] [Cr]  
 Data Red : 0 ~ Green : 64  
 \* Refer to 'Real data mapping2'.

Ack

[j] [ ] [Set ID] [ ] [OK] [Data] [x]  
 Data Red : 0 ~ Green : 64

**08. Sharpness (Command:kk)**

→ To adjust the screen sharpness.(Video/Component)

Transmission

[k] [k] [ ] [Set ID] [ ] [Data] [Cr]  
 Data Min : 0 ~ Max : 64  
 \* Refer to 'Real data mapping 1'.

Ack

[k] [ ] [Set ID] [ ] [OK] [Data] [x]  
 Data Min : 0 ~ Max : 64

**09. OSD Select (Command:kl)**

→ To select OSD On/Off.

Transmission

[k] [l] [ ] [Set ID] [ ] [Data] [Cr]  
 Data 0 : OSD Select Mode Off  
 1 : OSD Select Mode On

Ack

[l] [ ] [Set ID] [ ] [OK] [Data] [x]  
 Data 0 : OSD Select Mode Off  
 1 : OSD Select Mode On

**10. Remote Control Lock/Key Lock (Command:km)**

→ To lock the front panel controls on the projector and remote control.

Transmission

[k] [m] [ ] [Set ID] [ ] [Data] [Cr]  
 Data 0 : Lock Off  
 1 : Lock On

Ack

[m] [ ] [Set ID] [ ] [OK] [Data] [x]  
 Data 0 : Lock Off  
 1 : Lock On

\* If you're not using the remote control, use this mode.  
 When main power is On/Off, external control lock is released.

**11. Color Temperature (Command:ku)**

→ Adjust the color temperature.

Transmission

[k] [u] [ ] [Set ID] [ ] [Data] [Cr]  
 Data 0 : Normal 1 : Cool 2:Warm 3 : Natural

Ack

[u] [ ] [Set ID] [ ] [OK] [Data] [x]  
 Data 0 : Normal 1 : Cool 2:Warm 3 : Natural

# External control device setup

## 12. Red ADC gain Adjustment (Color R) (Command:jw)

→ Adjust the Red gain of ADC part.(RGB)

### Transmission

```
[j][w][ ][ ][Set ID][ ][ ][Data][Cr]
```

Data Min : 0 ~ Max : 64

\* Refer to 'Real data mapping 1'.

### Ack

```
[w][ ][ ][Set ID][ ][ ][OK][Data][x]
```

Data Min : 0 ~ Max : 64

## 13. Green ADC gain Adjustment (Color G) (Command: jy)

→ Adjust the Green gain of ADC part.(RGB)

### Transmission

```
[j][y][ ][ ][Set ID][ ][ ][Data][Cr]
```

Data Min : 0 ~ Max : 64

\* Refer to 'Real data mapping 1'.

### Ack

```
[y][ ][ ][Set ID][ ][ ][OK][Data][x]
```

Data Min : 0 ~ Max : 64

## 14. Blue ADC gain Adjustment (Color B) (Command: jz)

→ Adjust the Blue gain of ADC part.(RGB)

### Transmission

```
[j][z][ ][ ][Set ID][ ][ ][Data][Cr]
```

Data Min : 0 ~ Max : 64

\* Refer to 'Real data mapping 1'.

### Ack

```
[z][ ][ ][Set ID][ ][ ][OK][Data][x]
```

Data Min : 0 ~ Max : 64

## 15. Low Power (Command:jq)

→ To reduce the power consumption of the projector.

### Transmission

```
[j][q][ ][ ][Set ID][ ][ ][Data][Cr]
```

Data 0 : Low Power Off  
1 : Low Power On

### Ack

```
[q][ ][ ][Set ID][ ][ ][OK][Data][x]
```

Data 0 : Low Power Off  
1 : Low Power On

## 16. Auto Configure (Command:ju)

→ To adjust picture position and minimize image shaking automatically. It works only in RGB mode.

### Transmission

```
[j][u][ ][ ][Set ID][ ][ ][Data][Cr]
```

Data 1 : To set

### Ack

```
[u][ ][ ][Set ID][ ][ ][OK][Data][x]
```

Data 1 : To set

## 17. Input Select (Command:xb)

→ To select input source for the Set.

### Transmission

```
[x][b][ ][ ][Set ID][ ][ ][Data][Cr]
```

Data 20 : Video 60 : RGB1  
61 : RGB2 80 : HDMI

### Ack

```
[b][ ][ ][Set ID][ ][ ][OK][Data][x]
```

Data 20 : Video 60 : RGB1  
61 : RGB2 80 : HDMI

## 18. Key (Command:mc)

→ To send Key code of IR remote control.

### Transmission

```
[m][c][ ][ ][Set ID][ ][ ][Data][Cr]
```

Data Key code

### Ack

```
[b][ ][ ][Set ID][ ][ ][OK][Data][x]
```

Key code

| Button | Key code | Button    | Key code |
|--------|----------|-----------|----------|
| ^      | 40       | BLANK     | 84       |
| ∇      | 41       | TIMER     | 26       |
| >      | 02       | W.PEAK    | 69       |
| <      | 03       | KEYSTONE  | A4       |
| POWER  | AD       | GAMMA     | 6E       |
| SOURCE | EF       | MODE      | 4D       |
| MENU   | 43       | ☼         | 4F       |
| EXIT   | 5B       | ●         | 4E       |
| ⊙ OK   | 44       | ZOOM      | 5C       |
| STILL  | BC       | LAMP MODE | 68       |
| RATIO  | 79       | SLEEP     | 0E       |
|        |          | AUTO      | 92       |

# Supported Monitor Display

\* The following table lists the display formats supported by the projector.

| Sources | Format    | Vertical Freq.(Hz) | Horizontal Freq.(kHz) |
|---------|-----------|--------------------|-----------------------|
| EGA     | 640X350   | 70.09Hz            | 31.468kHz             |
|         | 640X350   | 85.08Hz            | 37.861kHz             |
| PC98    | 640X400   | 85.08Hz            | 37.861kHz             |
| DOS     | 720X400   | 70.08Hz            | 31.469kHz             |
|         | 720X400   | 85.03Hz            | 37.927kHz             |
| VGA     | 640X480   | 59.94Hz            | 31.469kHz             |
|         | 640X480   | 72.80Hz            | 37.861kHz             |
|         | 640X480   | 75.00Hz            | 37.500kHz             |
|         | 640X480   | 85.00Hz            | 43.269kHz             |
| SVGA    | 800X600   | 56.25Hz            | 35.156kHz             |
|         | 800X600   | 60.31Hz            | 37.879kHz             |
|         | 800X600   | 72.18Hz            | 48.077kHz             |
|         | 800X600   | 75.00Hz            | 46.875kHz             |
|         | 800X600   | 85.06Hz            | 53.674kHz             |
| XGA     | 1024X768  | 60.00Hz            | 48.363kHz             |
|         | 1024X768  | 70.06Hz            | 56.476kHz             |
|         | 1024X768  | 75.02Hz            | 60.023kHz             |
|         | 1024X768  | 84.99Hz            | 68.677kHz             |
| SXGA    | 1152X864  | 60.05Hz            | 54.348kHz             |
|         | 1152X864  | 70.01Hz            | 63.995kHz             |
|         | 1152X864  | 75.00Hz            | 67.500kHz             |
|         | 1280X960  | 60.00Hz            | 60.000kHz             |
|         | 1280X960  | 85.00Hz            | 85.940kHz             |
|         | 1280X1024 | 60.02Hz            | 63.981kHz             |
| SXGA+   | 1280X1024 | 75.025Hz           | 79.976kHz             |
|         | 1400X1050 | 60.00Hz            | 65.317kHz             |

\* If the projector does not support the input signal, "Out of Range" message appears on the screen.

\* The projector supports DDC1/2B type as Plug & Play function. (Auto recognition of PC monitor)

\* The Synchronization input form for horizontal and vertical frequencies are Separate.

\* According to PC, the optimum vertical frequency may not be displayed up to the optimum frequency of set in 'Registration information (Display registration information)'. (ex, The optimum vertical frequency may be displayed up to 85Hz or under in the resolution of 640X480 or 800X600.)

## <DVD/DTV Input>

| Signal       | Component-*1 | HDMI(DTV)-*2 |
|--------------|--------------|--------------|
| 59.94 / 60Hz | 480i         | O            |
|              | 480p         | O            |
|              | 720p         | O            |
|              | 1080i        | O            |
| 50Hz         | 576i         | X            |
|              | 576p         | O            |
|              | 720p         | O            |
|              | 1080i        | O            |
| 24/25/30Hz   | 1080p        | O            |

\* Cable type

1- RCA to D-Sub Adapter

2- HDMI to HDMI Cable

# Maintenance

\* The projector needs little maintenance. You should keep the lens clean because any dirt or stains may appear on the screen. If any parts need to be replaced, contact your dealer. When cleaning any part of the projector, always turn the power off and unplug the projector first.

## Cleaning the lens

Clean the lens whenever you notice dirt or dust on the surface of it. Wipe the lens surface gently with an air spray or a soft, dry lint-free cloth.

To remove dirt or stains on the lens, moisten a soft cloth with water and a neutral detergent and wipe the lens surface gently.

## Cleaning the Projector Case

To clean the projector case, first unplug the power cable. To remove dirt or dust, wipe the casing with a soft, dry, lint-free cloth. To remove stubborn dirt or stains, moisten a soft cloth with water and a neutral detergent and then wipe the casing.

Do not use alcohol, benzene, thinners or other chemical detergents as these can cause the casing to be warped or discolored.

# Replacing the Lamp

## Lamp Replacement

The change interval of lamp may depend on the use environment of Projector. You can see the used lamp time in the CHECKING LAMP TIME section of the Menu (page.29). You must replace the lamp when:

- The projected image gets darker or starts to deteriorate.
- The lamp indicator is red.
- The message “Replace the lamp” appears on the screen when turning the projector on.

<Front panel of the Projector>

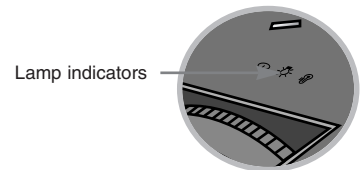

## Be careful when replacing lamp

- Press the POWER button on the control panel or remote control to turn off power.
- If the operation indicator LED is orange and blinking, do not disconnect the main supply until the operation indicator LED is lit up constantly (orange).
- Allow the lamp to cool for 1 hour before replacing it.
- Replace only with the same type lamp from an LG Electronics Service Center. Using another manufacturers lamp may cause damage to the Projector and lamp.
- Pull out the lamp only when replacing the lamp.
- Keep the lamp unit out of reach of children. Keep the Lamp away from heat sources such as radiators, stoves etc.
- To reduce the risk of fire do not expose the lamp to liquids or foreign materials.
- Do not place the lamp near any heat source.
- Make sure the new lamp is securely tightened with screws. If not, the image may be dark or there could be an increased risk of fire.
- Never touch the lamp unit glass otherwise image quality may be compromised or lamp life maybe reduced.

## To obtain a replacement Lamp unit

Lamp model number is on page 42. Check the lamp model and then purchase it from an LG Electronics Service Center. Using another manufacturers lamp may cause damage to the projector.

## Lamp unit disposal

Dispose of the used lamp by returning it to the LG Electronics Service Center.

## Replacing the Lamp

- 1 Turn off the projector and unplug the power cable. Carefully place on a cushioned surface.

(Allow the lamp to cool for 1 hour before removing the used lamp from the projector.)

- 3 After lifting the lamp cover off, remove the two retaining screws on the lamp case with a screwdriver.

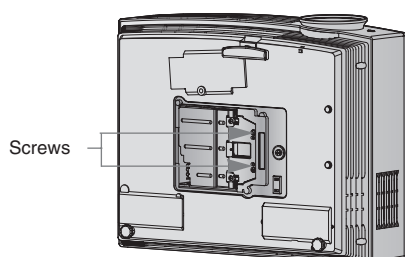

- 5 Pull out the handle slowly and remove the lamp case.

- 7 Tighten the screws you removed in step 3.

(Make sure they are fixed firmly.)

- 2 Unscrew the screw from the lamp cover using a screwdriver.

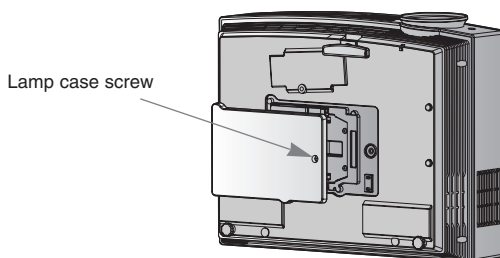

- 4 Lift the lamp up from the projector.

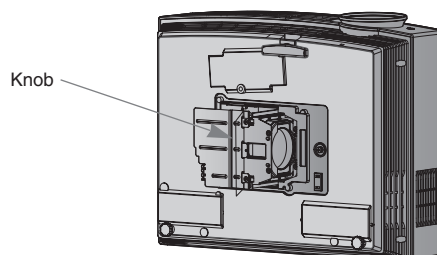

- 6 Insert the new lamp gently into the correct position. Make sure it is inserted correctly.

- 8 Close the lamp cover and install the screws from step 2 to install the cover.

(If the lamp cover is not installed correctly the unit will not power on.)

### Note!

Using another manufacturer's lamp may cause damage to the projector or lamp. Make sure the lamp cover is securely fastened. If the lamp cover is not installed correctly the unit will not power on. If this fault persists contact an LG Authorized Service Center.

## Regarding the projector lamp control

### WARNING

- Don't turn off the projector at least in 5 minutes after activating it.
  - The frequent On/Off changes may cause the lamp function to deteriorate.
- Don't pull out the power cord while activating the projector and the cooling fan.
  - It may cause the lamp life-span to shorten and get damaged.
- The life-span of projector may considerably depend on the use environment and treatment conditions.
- The projector uses the high pressure mercury lamp so that the serious caution is essential. The shock or abuse while using may cause lamp to blow off with explosion.
- When you continue to use the projector after an interval of lamp replacement, the lamp may be blown off with explosion.
- The following treatment should be done, in case of lamp blow-off.
  - Pull off the power cord immediately.
  - Let some fresh air in immediately (Ventilation).
  - Check the product condition at the nearer service center and replace it with new lamp, if necessary.
  - Don't try to disassemble the product without the authorized technician.

## How to fix the lens cap to the projector

### How to fix the lens cap

- 1** Prepare the lens cap and the strap supplied as accessories.

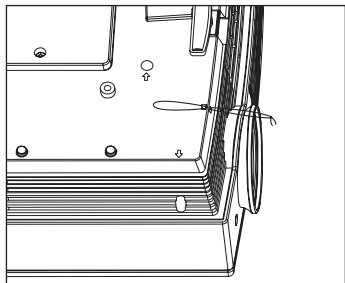

- 2** Insert the non-knot end of the strap into the hole at the bottom of the lens section of the projector.

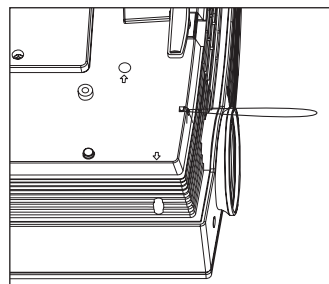

- 3** Fix the strap at the hole of the projector into the hole of the lens cap, and then pass the lens cap through the strap lasso.

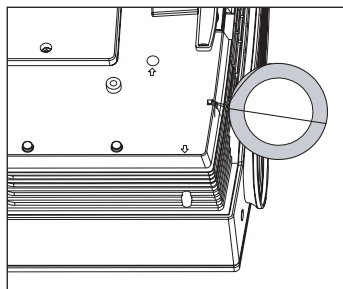

- 4** They are completely assembled as shown at the below figure.

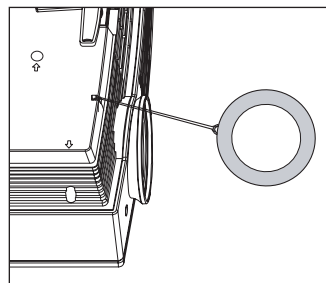



# Specifications

| MODEL                                | BX401C (BX401C-JD)  |
|--------------------------------------|---|
| Resolution                           | 1024(Horizontal) x 768(Vertical)pixel   |
| Horizontal / Vertical Ratio          | 4:3(horizontal:vertical)  |
| DLP panel size                       | 0.7 inches  |
| Screen size<br>(Projection distance) | Wide : 1.26 ~ 9.63m(40 ~ 300 inches)<br>Tele : 1.50 ~ 11.47m(40 ~ 300 inches) |
| Projection off-set ratio             | 100%  |
| Remote control distance              | 12m   |
| Zoom ratio                           | 1:1.2   |
| Video compatibility                  | NTSC/PAL/SECAM/NTSC4.43/PAL-M/PAL-N   |
| Power                                | AC 100 - 240V~ 50/60Hz, 3.7A-1.5A   |
| Height(mm/inches)                    | 114/4.5   |
| Breadth(mm/inches)                   | 346/13.6  |
| Length(mm/inches)                    | 263/10.4  |
| Weight(kg/pound)                     | 4.5/9.92  |

## Operating Condition

### Temperature

In operation : 32~104°F(0°C~40°C)  
In storage and transit : -4~140°F(-20°C~60°C)

### Humidity

In operation : 0 ~ 75% relative humidity by dry hygrometer  
Not in operation : 0 ~ 85% relative humidity by dry hygrometer

## Projector Lamp

### Lamp model

AJ-LDX5

### Lamp power consumption

300W

