

Panasonic®

Operating Instructions Basic Manual

LCD Projector Commercial Use

Model No. **PT-ST10U**

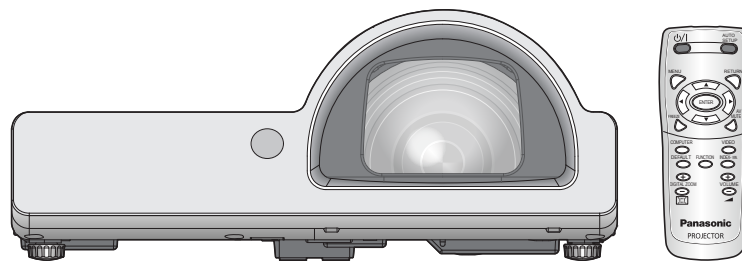

Thank you for purchasing a Panasonic Projector.

- Before operating this product, please read the instructions carefully, and save this manual for future use.
- **Before using your projector, be sure to read “Precautions with regard to safety” (pages 5 to 9).**
- For network operation, please read the Network Operation Manual.

Important Safety Notice

Dear Panasonic Customer:

The following information should be read and understood as it provides details, which will enable you to operate the projector in a manner which is both safe to you and your environment, and conforms to legal requirements regarding the use of projectors. Keep this booklet with your Panasonic LCD projector for future reference. The serial number of your product may be found on its bottom. Write it in the space provided below and retain this booklet in case service is required.

Model number: PT-ST10U

Serial number:

WARNING: TO REDUCE THE RISK OF FIRE OR ELECTRIC SHOCK, DO NOT EXPOSE THIS PRODUCT TO RAIN OR MOISTURE.

Power Supply: This LCD Projector is designed to operate on 100 V - 240 V, 50 Hz/60 Hz AC, house current only.

CAUTION: The AC power cord which is supplied with the projector as an accessory can only be used for power supplies up to 125 V, 7 A. If you need to use higher voltages or currents than this, you will need to obtain a separate 250 V power cord. If you use the accessory cord in such situations, fire may result.



The lightning flash with arrowhead symbol, within an equilateral triangle, is intended to alert the user to the presence of uninsulated "dangerous voltage" within the product's enclosure that may be of sufficient magnitude to constitute a risk of electric shock to persons.



The exclamation point within an equilateral triangle is intended to alert the user to the presence of important operating and maintenance (servicing) instructions in the literature accompanying the product.

CAUTION: This equipment is equipped with a three-pin grounding-type power plug. Do not remove the grounding pin on the power plug. This plug will only fit a grounding-type power outlet. This is a safety feature. If you are unable to insert the plug into the outlet, contact an electrician. Do not defeat the purpose of the grounding plug.

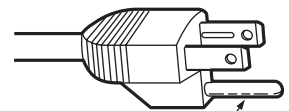

Do not remove

Pursuant to at the directive 2004/108/EC, article 9(2)

Pursuant to at the directive 2005/32/EC amended by 2008/28/EC, article 14

Panasonic Testing Center

Panasonic Service Europe, a division of Panasonic Marketing Europe GmbH

Winsbergring 15, 22525 Hamburg, F.R. Germany

NOTICE:

This product has a High Intensity Discharge (HID) lamp that contains mercury. Dispose may be regulated in your community due to environmental considerations. For disposal or recycling information, please contact your local authorities, or the Electronic Industries Alliance: <http://www.eiae.org>

Important Safety Notice (continued)**WARNING:**

This equipment has been tested and found to comply with the limits for a Class B digital device, pursuant to Part 15 of the FCC Rules. These limits are designed to provide reasonable protection against harmful interference in a residential installation. This equipment generates, uses and can radiate radio frequency energy and, if not installed and used in accordance with the instructions, may cause harmful interference to radio communications. However, there is no guarantee that interference will not occur in a particular installation. If this equipment does cause harmful interference to radio or television reception, which can be determined by turning the equipment off and on, the user is encouraged to try to correct the interference by one or more of the following measures:

- Reorient or relocate the receiving antenna.
- Increase the separation between the equipment and receiver.
- Connect the equipment into an outlet on a circuit different from that to which the receiver is connected.
- Consult the dealer or an experienced radio/TV technician for help.

FCC CAUTION: To assure continued compliance, follow the attached installation instructions and use only shielded interface cables when connecting to computer and/or peripheral devices. Any changes or modifications not expressly approved by Panasonic Corp. of North America could void the user's authority to operate this device.

WARNING:

- Not for use in a computer room as defined in the Standard for the Protection of Electronic Computer/Data Processing Equipment, ANSI/NFPA 75.
- For permanently connected equipment, a readily accessible disconnect device shall be incorporated in the building installation wiring.
- For pluggable equipment, the socket-outlet shall be installed near the equipment and shall be easily accessible.

Declaration of Conformity

Model Number: PT-ST10U
 Trade Name: **Panasonic**
 Responsible party: Panasonic Solutions Company
 Address: 3 Panasonic Way, Secaucus, NJ 07094
 Telephone number: (877) 803 - 8492
 E-mail: projectorsupport@us.panasonic.com

This device complies with Part 15 of the FCC Rules. Operation is subject to the following two conditions: (1) This device may not cause harmful interference, and (2) this device must accept any interference received, including interference that may cause undesired operation.

Information on Disposal in other Countries outside the European

These symbols are only valid in the European Union.
 If you wish to discard this product, please contact your local authorities or dealer and ask for the correct method of disposal.

**Environment care information for users in China**

This symbol is only valid in China.

TABLE OF CONTENTS

Essential information		PROJECTOR SETUP MENU 36
Important Safety Notice	2	SECURITY MENU 40
Precautions with regard to safety	5	NETWORK MENU 42
Preparation		Maintenance
Start-up display	10	LAMP and TEMP indicators 43
Details of your projector	11	Care and replacement 44
Getting started		References
Set up your projector	14	Troubleshooting 48
Connections	16	Dimensions 49
Basic operations		Trademark acknowledgements 49
Turn the projector ON or OFF	18	Technical information 50
Project an image.....	22	Specifications 53
Remote control operation.....	23	Ceiling mount bracket safeguards 55
Settings		INSTALLING THE SAFETY CABLE 55
Menu operation.....	26	Index 57
PICTURE MENU	28	Informations essentielles
POSITION MENU	30	Avis important concernant la sécurité 58
LANGUAGE MENU	33	Précautions concernant la sécurité 60
DISPLAY OPTION MENU	33	Remplacement de l'unité de la lampe 64

Projection on a large screen in a limited space

Since the short-focus lens is employed, images can be thrown on a screen of the same size from a distance less than 1/2 of the ordinary projector. (⇒ page 14)

60 inch: Approx. 1.7 m (PT-LB2U)



60 inch: Approx. 0.6 m (PT-ST10U)

(This projector can be installed to Electronic Whiteboard "elite Panaboard" and they can be used as one unit. Some parts sold separately are necessary for installation. For details, please contact your dealer.)

Lengthened lamp replacement cycle

The lamp replacement cycle is longer than the former model. (⇒ page 45)

Approx. 3 000 hours (PT-LB90NTU)



Approx. 5 000 hours (PT-ST10U)
(LAMP POWER: In "ECO")

User logo display function

You can project your company's logo when projection starts. (⇒ page 34)

Precautions with regard to safety

WARNING

POWER

The wall outlet or the circuit breaker shall be installed near the equipment and shall be easily accessible when problems occur. If the followings problems occur, cut off the power supply immediately.

Continued use of the projector in these conditions will result in fire or electric shock.

- If foreign objects or water get inside the projector, cut off the power supply.
- If the projector is dropped or the cabinet is broken, cut off the power supply.
- If you notice smoke, strange smells or noise coming from the projector, cut off the power supply.

Please contact an Authorized Service Center for repairs, and do not attempt to repair the projector yourself.

During a thunderstorm, do not touch the projector or the cable.

Electric shocks can result.

Do not do anything that might damage the power cord or the power plug.

If the power cord is used while damaged, electric shocks, short-circuits or fire will result.

- Do not damage the power cord, make any modifications to it, place it near any hot objects, bend it excessively, twist it, pull it, place heavy objects on top of it or wrap it into a bundle.

Ask an Authorized Service Center to carry out any repairs to the power cord that might be necessary.

Insert the power plug securely into the wall outlet.

If the plug is not inserted correctly, electric shocks or overheating will result.

- Do not use anything other than the provided power cord.
- Do not use the provided power cord for other electrical equipment.
- Do not use plugs which are damaged or wall outlets which are coming loose from the wall.

Clean the power plug regularly to prevent it from becoming covered in dust.

Failure to observe this will cause a fire.

- If dust builds up on the power plug, the resulting humidity can damage the insulation.
- If not using the projector for an extended period of time, pull the power plug out from the wall outlet.

Pull the power plug out from the wall outlet and wipe it with a dry cloth regularly.

Do not handle the power plug with wet hands.

Failure to observe this will result in electric shocks.

Do not overload the wall outlet.

If the power supply is overloaded (ex., by using too many adapters), overheating may occur and fire will result.

ON USE/INSTALLATION

Do not place liquid containers on top of the projector.

If water spills onto the projector or gets inside it, fire or electric shocks will result.

If any water gets inside the projector, contact an Authorized Service Center.

Do not place the projector on soft materials such as carpets or sponge mats.

Doing so will cause the projector to overheat, which can cause burns, fire or damage to the projector.

Do not set up the projector in humid or dusty places or in places where the projector may come into contact with oily smoke or steam, ex. a bathroom.

Using the projector under such conditions will result in fire, electric shocks or components deterioration. Components deterioration (such as ceiling mount brackets) may cause the projector which is mounted on the ceiling to fall down.

Do not install this projector in a place which is not strong enough to take the full weight of the projector or on top of a surface which is sloped or unstable.

Failure to observe this will cause projector to fall down or tip over the projector, and severe injury or damage could result.

Do not place another projector or other heavy objects on top of the projector.

Failure to observe this will cause the projector to become unbalanced and fall, which could result in damage or injury. The projector will be damaged or deformed.

Installation work (such as ceiling suspension) should only be carried out by a qualified technician.

If installation is not carried out and secured correctly it can cause injury or accidents, such as electric shocks.

- Do not use anything other than an Authorized ceiling mount bracket.

Do not cover the air inlet port or the air outlet port.

Doing so will cause the projector to overheat, which can cause fire or damage to the projector.

- Do not place the projector in narrow, badly ventilated places such as closets or bookshelves.
- Do not place the projector on cloth or papers, as these materials could be drawn into the air inlet port.

Do not place your hands or other objects close to the air outlet port.

Doing so will cause burns or damage your hands or other objects.

- Heated air comes out of the air outlet port. Do not place your hands or face, or objects which cannot withstand heat close to this port.

Precautions with regard to safety (continued)

Do not look and place your skin into the lights emitted from the lens while the projector is being used.

Doing so can cause burns or loss of sight.

- Strong light is emitted from the projector's lens. Do not look or place your hands directly into this light.
- Be especially careful not to let young children look into the lens. In addition, turn off the power and disconnect the power plug when you are away from the projector.

Do not insert any foreign objects into the projector.

Doing so will cause fire or electric shocks.

- Do not insert any metal objects or flammable objects into the projector or drop them onto the projector.

Never attempt to remodel or disassemble the projector.

High voltages can cause fire or electric shocks.

For any inspection, adjustment and repair work, please contact an Authorized Service Center.

Do not project an image with the supplied lens cover attached.

Doing so can cause fire.

ACCESSORIES

Do not use or handle the batteries improperly, and refer to the following.

Failure to observe this will cause burns, batteries to leak, overheat, explode or catch fire.

- Do not use unspecified batteries.
- Use manganese batteries but not rechargeable batteries.
- Do not disassemble dry cell batteries.
- Do not heat the batteries or place them into water or fire.
- Do not allow the + and – terminals of the batteries to come into contact with metallic objects such as necklaces or hairpins.
- Do not store batteries together with metallic objects.
- Store the batteries in a plastic bag and keep them away from metallic objects.
- Make sure the polarities (+ and –) are correct when inserting the batteries.
- Do not use a new battery together with an old battery or mix different types of batteries.
- Do not use batteries with the outer cover peeling away or removed.
- Remove the empty batteries from the remote control at once.
- Insulate the battery using tape or something similar before disposal.

Do not allow children to reach the attached screws or AAA/R03 batteries.

- The battery can cause personal injury if swallowed.
- If swallowed, seek medical advice immediately.

If the battery fluid leaks, do not touch it with bare hands, and take the following measures if necessary.

- Battery fluid on your skin or clothing could result in skin inflammation or injury.
Rinse with clean water and seek medical advice immediately.
- Battery fluid coming in contact with your eyes could result in loss of sight.
In this case, do not rub your eyes. Rinse with clean water and seek medical advice immediately.

Do not disassemble the lamp unit.

If the lamp breaks, it could cause injury.

Lamp replacement

The lamp has high internal pressure. If improperly handled, an explosion and severe injury or accidents will result.

- Replacement of the lamp should be carried out by a qualified technician.
- The lamp can easily explode if struck against hard objects or dropped.
- Before replacing the lamp, be sure to disconnect the power plug from the wall outlet.
Electric shocks or explosions can result if this is not done.
- When replacing the lamp, allow it to cool for at least one hour before handling it otherwise it can cause burns.

Do not allow infants or pets to touch the remote control unit.

- Keep the remote control unit out of the reach of infants and pets after using it.

CAUTION

POWER

When disconnecting the power cord, be sure to hold the power plug and power connector.

If the power cord itself is pulled, the lead will become damaged, and fire, short-circuits or serious electric shocks will result.

When not using the projector for an extended period of time, disconnect the power plug from the wall outlet and remove the batteries from the remote control.

Disconnect the power plug from the wall outlet before carrying out any cleaning.

Electric shocks can result if this is not done.

Precautions with regard to safety (continued)

ON USE/INSTALLATION

Do not put your weight on this projector.

You could fall or the projector could break, and injury will result.

- Be especially careful not to let young children stand or sit on the projector.

Do not place the projector in extremely hot locations.

Doing so will cause the outer casing or internal components to deteriorate, or result in fire.

- Take particular care in locations exposed to direct sunlight or near stoves.

Always disconnect all cables before moving the projector.

Moving the projector with cables still attached can damage the cables, which will cause fire or electric shocks to occur.

ACCESSORIES

Do not use the old lamp unit.

If used it could cause lamp explosion.

If the lamp has broken, ventilate the room immediately. Do not touch or bring your face close to the broken pieces.

Failure to observe this will cause the user to absorb the gas which was released when the lamp broke and which contains nearly the same amount of mercury as fluorescent lamps, and the broken pieces will cause injury.

If you believe that you have absorbed the gas or that the gas has got into your eyes or mouth, seek medical advice immediately.

Ask your dealer about replacing the lamp unit and check the inside of the projector.

CAUTIONS WHEN TRANSPORTING

When transporting the projector, the leg adjusters must be housed and do not hold them.

When transporting, keep the projector with the lens cover on it.

- Please take care to keep them away from vibration and impacts, both the projector and the lens are precision-made and easily susceptible to damage.

CAUTIONS WHEN INSTALLING

DO NOT USE UNDER THE FOLLOWING CONDITIONS.

- **Do not set up the projector outdoors.**
The projector is designed for indoor use only.
- **Avoid setting up in places which are subject to vibration or shocks.**
If the projector is installed in a place where vibrations are transmitted or mounted in a car or a vessel, vibrations or impacts will result in damage to the internal parts, causing failure. Install the product in a place free from vibrations and impacts.
- **Avoid setting up in places which are subject to sudden temperature changes, such as near an air conditioner or lighting equipment.**
Failure to observe this will result in malfunctions or the lamp life will be shortened.
See "TEMP INDICATOR" on page 43.
- **Avoid setting up in places which are near high-voltage power lines or near motors.**
The product will be exposed to interference if it is installed in the vicinity of high-voltage electrical power lines or power sources.
- **Do not install the projector at elevations higher than 2 700 m (8 858 ft) above sea level.**
If using this projector at high elevations 1 400 - 2 700 m (4 593 - 8 858 ft) above sea level, set the **HIGH ALTITUDE MODE to ON.**
If using this projector at elevations lower than 1 400 m (4 593 ft) above sea level, set the **HIGH ALTITUDE MODE to OFF.**
Failure to observe this will result in malfunctions or the lamp life or life of other components will be shortened.

BE SURE TO ASK A SPECIALIZED TECHNICIAN WHEN INSTALLING THE PRODUCT TO A CEILING.

If the product is to be installed hanging from the ceiling, purchase an optional hanging attachment (Model No. ET-PKB2). Please call a specialized technician or contact an Authorized Service Center for installation.

LENS FOCUS

Do not adjust the lens focus in the initial period after switching the projector on. The high clarity projector lens is thermally affected by the light from the light source, making the focus unstable in the period just after switching on. Please allow a warm-up time of at least 30 minutes before adjusting the lens focus.

Precautions with regard to safety (continued)**CAUTIONS ON USE****IN ORDER TO GET THE PICTURE QUALITY**

Draw curtains or blinds over windows and turn off any lights near the screen to prevent outside light or light from indoor lamps from shining onto the screen. Depending on where the projector is used, air exhaust vents or the warm air from air conditioning can cause a shimmering effect on the screen. For this reason, take care not to shield the air exhaust vents and consider the direction of the air flowing from air conditioning.

DO NOT TOUCH THE SURFACE OF THE PROJECTOR LENS WITH YOUR BARE HAND.

If the surface of the lens becomes dirty from fingerprints or anything else, this will be magnified and projected onto the screen. Please put the standard lens cover on the projector when you do not use it.

DO NOT MOVE THE PROJECTOR WHILE IT IS OPERATING OR SUBJECT IT TO VIBRATION OR IMPACT.

The service life of its internal components will be shortened.

THE PROJECTOR HAS A HIGH PRESSURE MERCURY LAMP THAT IS CHARACTERIZED AS FOLLOWS:

- The brightness of the lamp will decrease over time.
- The lamp may explode or shorten the lamp life by shocks or chipping damage.
- In rare cases, it may burst shortly after the first use.
- The possibility of its bursting increases when the lamp is used beyond the replacement time.
- If the lamp bursts, gas inside the lamp is released in the form of smoke.
- The life of a mercury lamp varies according to the individual difference or conditions of use.
- In particular, turning the power on and off frequently and/or repeatedly as well as continuous use for 10 hours will greatly affect the life cycle. Provide a lamp for replacement in advance.

CONNECTION TO EXTERNAL DEVICE

When connecting the projector to a computer or external device, use the power cord supplied with the corresponding device and a commercially available shielded interface cable.

OPTICAL COMPONENTS

It may be necessary to replace the optical components such as Liquid crystal panels and Polarizing plates in less than 1 year if using the projector in a high temperature environment or in a very dusty, oily smoke or tobacco smoke environment. For more details, please contact your dealer.

LIQUID CRYSTAL PANEL

The Liquid crystal panels are precision-made. Note that in rare cases, pixels of high precision could be missing or always lit, but this is not a malfunction. Do not project the same image for long periods of time, as this may remain as an afterimage on the liquid crystal panel. Display the white screen test pattern for more than an hour to remove it. See "TEST PATTERN" on page 39.

SECURITY**TAKE SAFETY MEASURES AGAINST FOLLOWING INCIDENTS.**

- Personal information being leaked via this product.
- Unauthorized operation of this product by a malicious third party.
- Interfering or stopping of this product by a malicious third party.

SECURITY INSTRUCTION

- The connecting network must be secured by firewall or others.
- Change your password regularly.
- Do not use a password that is simple to guess.
- Panasonic and its affiliate companies would never directly inquire about your password.
- Do not share your password with the general public.
- Set a password, and place restrictions on the users who can log in.

Precautions with regard to safety (continued)

CLEANING AND MAINTENANCE

ASK AN AUTHORIZED SERVICE CENTER TO CLEAN THE INSIDE OF THE PROJECTOR AT LEAST ONCE A YEAR.

If dust is left to build up inside the projector without being cleaned out, it can result in fire or problems with operation. It is a good idea to clean the inside of the projector before the season when humid weather arrives.

Ask your nearest Authorized Service Center to clean the projector when required.

Please discuss with the Authorized Service Center regarding cleaning costs.

DISPOSAL

When discarding this product, please contact your local authorities or dealer and ask for the correct method of disposal.

SUPPLIED ACCESSORIES

Make sure that the following accessories are provided with your projector.

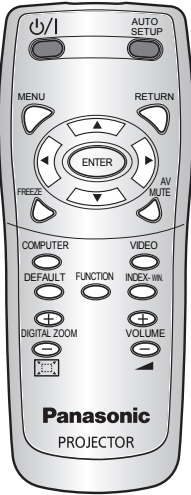
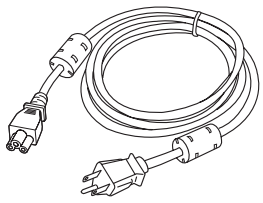
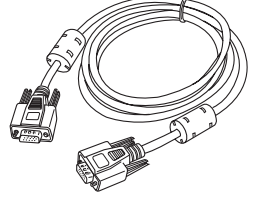
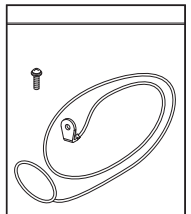
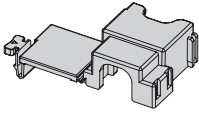
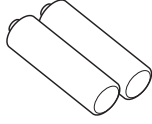
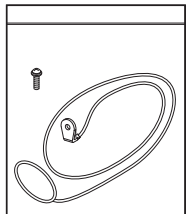
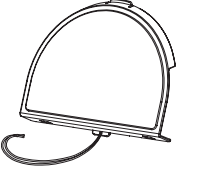
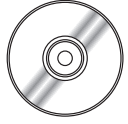
<p>Remote control (×1) (N2QAYA000011)</p> 	<p>Power cord (×1) (K2CG3YY00073)</p> 	<p>RGB signal cable (×1) 1.8 m (5' 10") (K1HY15YY0009)</p> 
<p>Safety cable (1 set) (TTRA0141) Attachment screw (x1) Safety cable (x1)</p> 	<p>Power cord secure lock (×1) (TTRA0185)</p> 	<p>AAA/R03 batteries for Remote control (×2)</p> 
<p>Safety cable (1 set) (TTRA0141) Attachment screw (x1) Safety cable (x1)</p> 	<p>Lens cover (×1) (TKKL5503) (Attached to the projector by default.)</p> 	<p>CD-ROM (×1) (TXFQB02VKN8)</p> 

NOTE:

- The protectors for the enclosed products, such as a plug cover or foam cartons, must be handled appropriately.
- Contact an Authorized Service Center for any lost accessories.
- Keep the accessories away from children.
- The model Nos. of the accessories and parts sold separately are subject to change without notice.

NOTE:

This product contains a CR Coin Cell Lithium Battery which contains Perchlorate Material - special handling may apply. See www.dtsc.ca.gov/hazardouswaste/perchlorate.

Start-up display

The **LANGUAGE** and **INITIAL SETTING** menu will be displayed when the projector is turned on for the first time or after it has been initialized. (⇒ page 39)

Navigate the **DISPLAY OPTION** menu to set the menus in accordance to its application and environment settings.

NOTE:

- When the projector is turned on for the first time, you may be required to adjust the “focus ring” (⇒ page 11) on the top of the projector body to make the menu screen clearer.
For details, see POSITION THE IMAGE. (⇒ page 22)

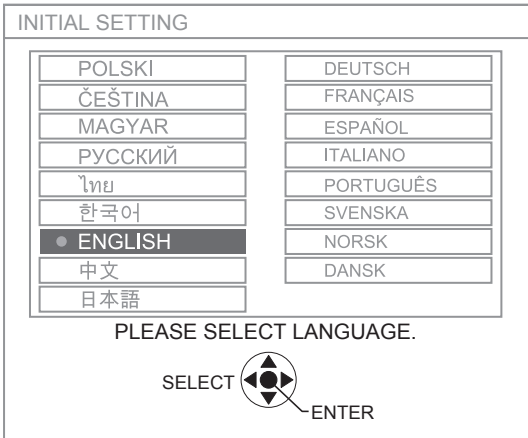

LANGUAGE

- 1**  **To select the desired language.**



- 2**  **To proceed to INITIAL SETTING menu.**

INITIAL SETTING

- 1**  **To select the desired menu.**
→ INSTALLATION
→ HIGH ALTITUDE MODE
- 2**  **To change the settings in the menu.**

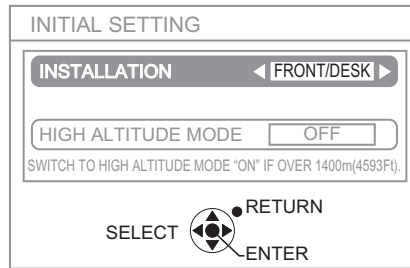

INSTALLATION (⇒ page 15, 37)	
FRONT/DESK	Put it on a desk or floor and project from the front
FRONT/CEILING	Mount it on the ceiling with a ceiling mount bracket (sold separately) and project from the front
REAR/DESK	Put it on a desk or floor and project from the rear (a translucent screen is required)
REAR/CEILING	Mount it on the ceiling with a ceiling mount bracket (sold separately) and project from the rear (a translucent screen is required)

HIGH ALTITUDE MODE (⇒ page 7, 37)	
OFF	Use in normal environment (below 1 400 m (4 593 ft) above sea level)
ON	Use at high altitude (at 1 400 - 2 700 m (4 593 - 8 858 ft) above sea level)

- 3** 

NOTE:

- To return to **LANGUAGE** menu, press **[RETURN]** in **INITIAL SETTING** menu.

Details of your projector

PROJECTOR'S MAIN UNIT

Top and front view

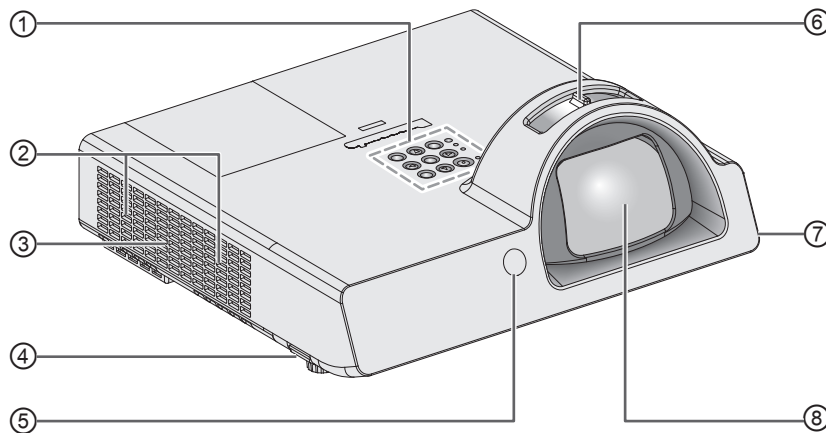

① **Control Panel / Indicators**

② **Air outlet port**

Hot air comes out from this opening.

③ **Speaker**

④ **Leg adjuster button** (⇒ page 22)

⑤ **Remote control signal receptor**

⑥ **Focus ring** – To adjust the focus. (⇒ page 22)

⑦ **Leg adjuster button** (⇒ page 22)

⑧ **Projection lens**

NOTE:

- Do not cover the air outlet port.
- Putting a finger in the projector can cause injury.
- Do not place your hands or other objects close to the air outlet port as this may cause damage or injury.
- Do not place your hands or face, or objects which cannot withstand heat near the air outlet port. Hot air comes out from this port.

Control Panel / Indicators

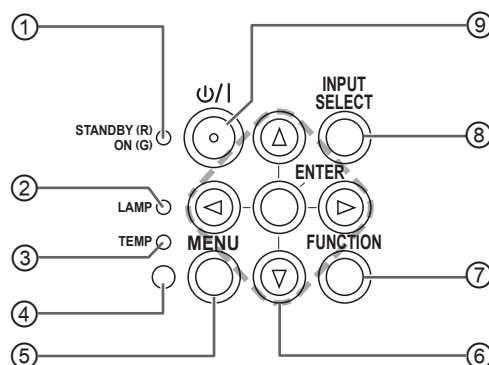

① Indicate the power supply's status.
(⇒ page 19)

② Indicate the lamp unit's status.
(⇒ page 43)

③ Indicate the temperature's status.
(⇒ page 43)

④ Ambient Luminance sensor (ALS).

⑤ Display the Main menu.

⑥ Navigate through the menus.
Confirm selection.

⑦ Create shortcut assigned to certain selected function. (⇒ page 25, 38)

⑧ Switch the input connections.
(⇒ page 22)

⑨ Switch between standby mode and projection mode. (⇒ page 20)

Details of your projector (continued)

Rear and bottom view

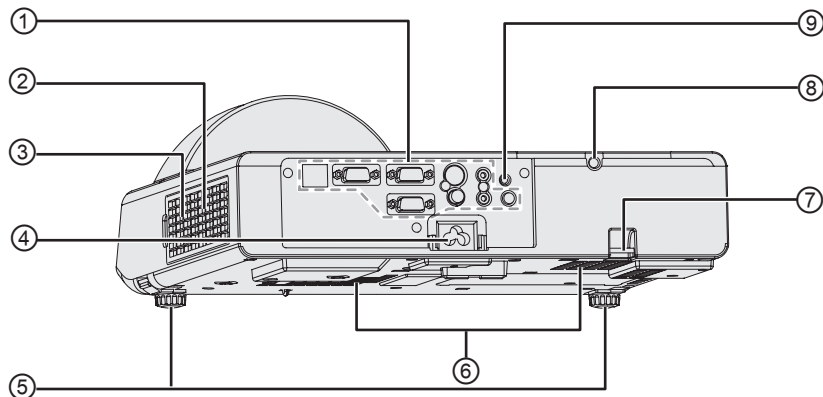

- ① **Terminals**
- ② **Air filter compartment** (⇒ page 44)
- ③ **Air intake port**
- ④ **AC IN**
Connect the power cord to supply electric power to the projector. (⇒ page 18)
- ⑤ **Leg adjuster**
To adjust the projection angle. (⇒ page 22)
- ⑥ **Air intake port**
- ⑦ **Burglar hook port**
Attach a commercial burglar prevention cable.
- ⑧ **Lamp unit compartment** (⇒ page 46)
- ⑨ **Remote control signal receptor**

NOTE:

- Do not connect any power cable other than the attached one.
- Do not cover the ventilation openings of the air intake port.

Terminals

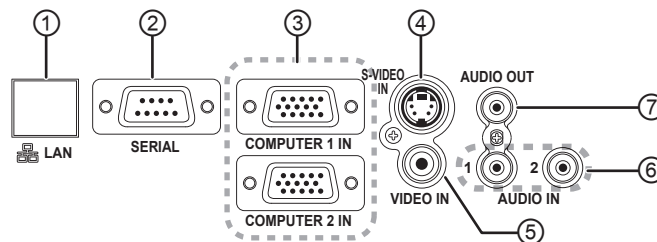

- ① Connect to a network cable.
(See "Network Operation Manual".)
- ② Connect to a computer to control the projector's operation.
(⇒ page 17, 51)
- ③ Connect to a computer or YP_BP_R signal cable.
(⇒ page 17)
- ④ Connect to an S-VIDEO signal cable.
(⇒ page 16)
- ⑤ Connect to a VIDEO signal cable.
(⇒ page 16)
- ⑥ Connect audio cables for inputting audio signal.
(⇒ page 16,39)
- ⑦ Connect an audio cable for audio signal output to the connected equipment. If it is connected to this terminal, no sound comes out of the built-in speaker.
(⇒ page 16)

Details of your projector (continued)

PROJECTOR'S REMOTE CONTROL

Top and rear view

Remote control signal emitters

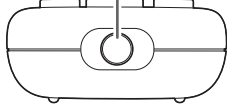

Installing/removing batteries

Press the tab and lift up the cover.

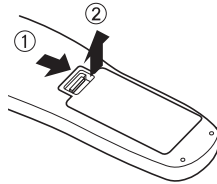

Insert the batteries according to the polarity diagram indicated inside or remove.

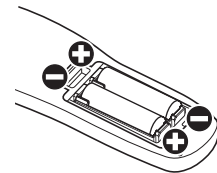

Remove the batteries in the reverse order to setting.

Use only manganese batteries.

Front view

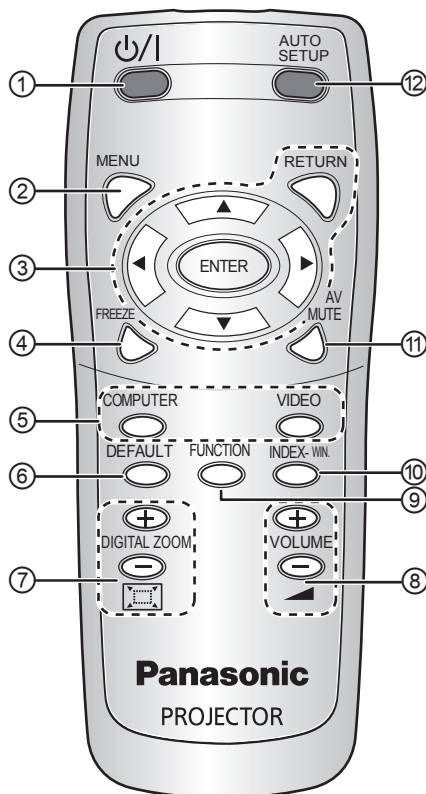

- ① **POWER**
Switch between standby mode and projection mode. (⇒ page 20, 21)
- ② Display the Main menu. (⇒ page 27)
- ③ Navigate through the menus with [**▲▼◀▶**] and confirm the selection with [**ENTER**]. (⇒ page 26)
- ④ Capture the projected image as a frozen picture. (⇒ page 23)
- ⑤ Switch the required input signal button to select. (⇒ page 23)
- ⑥ Reset some of the settings to the factory default settings. (⇒ page 24)
- ⑦ Control the zoom size. (⇒ page 25)
- ⑧ Control speaker volume. (⇒ page 24)
- ⑨ Create shortcut assigned to certain selected function. (⇒ page 25, 38)
- ⑩ Display frozen image while the display of subsequent images continues. (⇒ page 24)
- ⑪ Turn off the projection temporarily. (⇒ page 23)
- ⑫ Detect the input signal.
Adjust the settings of **SHIFT**, **DOT CLOCK** and **CLOCK PHASE** in the **POSITION** menu automatically for **COMPUTER** signals. (⇒ page 23)

NOTE:

- Do not drop the remote control.
- Avoid contact with liquids or moisture.
- Do not attempt to modify or disassemble the remote control.
- Do not let strong light shine onto the signal receptor which will cause a malfunction.
- The remote control operates within the range of 7 m (23' 0"), approximately ±30 ° vertically and horizontally from the projector avoiding any obstacles.
- The operating range may differ due to the screen material and may not be effective with a translucent screen.

Set up your projector

SCREEN SIZE AND THROW DISTANCE

You can calculate and define the throw distance as follows.

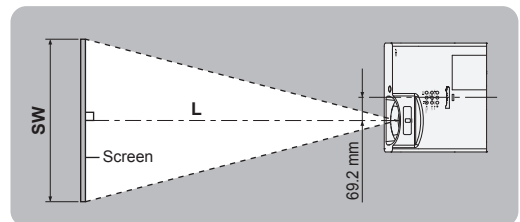
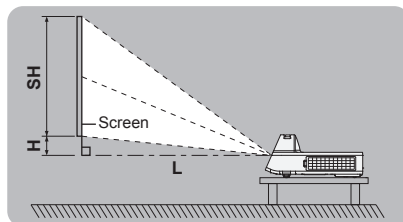
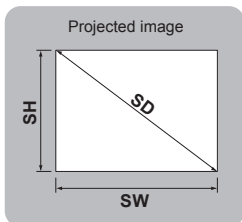

(All measurements below are approximate and may differ slightly from the actual measurements.)

Projection size	For 4:3 aspect ratio		For 16:9 aspect ratio	
Screen diagonal (SD)	Throw distance (L)	Settable height (H)	Throw distance (L)	Settable height (H)
1.52 m (60")	0.60 m (2' 0")	0.05 m (0' 2")	0.66 m (2' 2")	0.17 m (0' 7")
1.78 m (70")	0.71 m (2' 4")	0.05 m (0' 2")	0.78 m (2' 7")	0.20 m (0' 8")
2.03 m (80")	0.82 m (2' 8")	0.06 m (0' 2")	0.90 m (2' 11")	0.23 m (0' 9")
2.29 m (90")	0.92 m (3' 0")	0.07 m (0' 3")	1.01 m (3' 4")	0.26 m (0' 10")
2.54 m (100")	1.03 m (3' 4")	0.08 m (0' 3")	1.13 m (3' 8")	0.29 m (0' 11")
2.79 m (110")	1.14 m (3' 9")	0.08 m (0' 3")	—	—

You can calculate detailed screen dimensions from the "Screen diagonal". The unit of all the calculation results is m. (The results below differ slightly from the actual measurements.)

If the projection size is SD,

	For 4:3 aspect ratio	For 16:9 aspect ratio
Screen height (SH)	= SD (") × 0.0152	= SD (") × 0.0125
Screen width (SW)	= SD (") × 0.0203	= SD (") × 0.0221
Throw distance (L)	= 0.0107 × SD (") – 0.0389	= 0.0117 × SD (") – 0.0395

NOTE:

- For best projection image quality, install a screen where sunlight or room lightings do not shine directly onto the screen. Close window shades or curtains to block the light and turn off the lightings.
- Do not use the projector at a raised or horizontally tilted position. It may cause the projector to malfunction.
However, you can tilt the projector's body approximately ±30° vertically and ±10° horizontally.
Over tilting may result in shortening the component's life.
- Do not cover the air outlet port and air intake ports or place anything within 50 cm (20") near them as this may cause damage or injury.

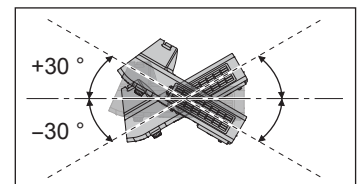

Set up your projector (continued)

PROJECTION METHOD

See "INSTALLATION" on page 37 to select the projection method.

■ Put it on a desk or floor and project from the front

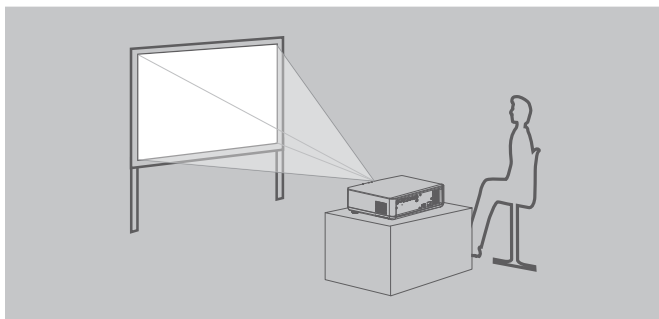

Menu	Method
INSTALLATION	FRONT/DESK

■ Mount it on the ceiling and project from the front

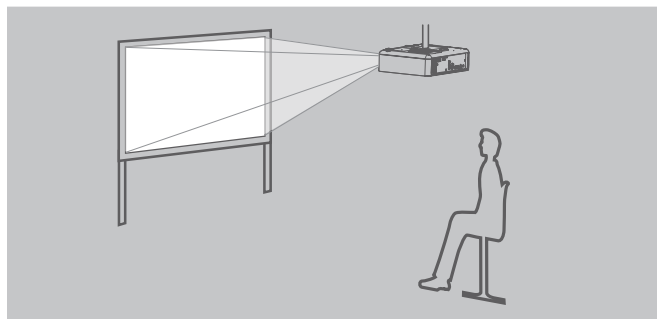

Menu	Method
INSTALLATION	FRONT/CEILING

■ Put it on a desk or floor and project from the rear (Use translucent screen)

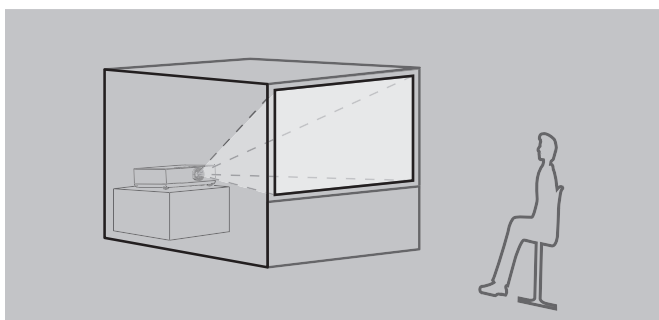

Menu	Method
INSTALLATION	REAR/DESK

■ Mount it on the ceiling and project from the rear (Use translucent screen)

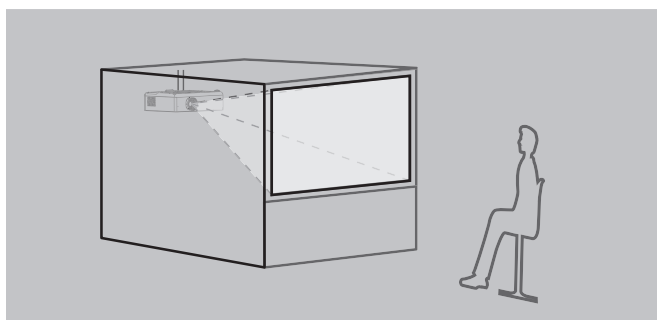

Menu	Method
INSTALLATION	REAR/CEILING

NOTE:

- Use the optional ceiling mount bracket (ET-PKB2) when mounting the projector on the ceiling.
- You can adjust the projection angle in the vertical direction by adjusting the leg adjuster button. (⇒ page 22)

Connections

Preparations

- Read and follow the operating instructions of each peripheral device and turn the peripheral devices off prior to making any connections.
- Prepare the selected peripheral devices with the connection cables that correspond to the projector's terminals.
- All peripheral devices and cables used for the connections are sold separately unless indicated otherwise.
- If the input signal is affected by signal jitter, the projected image may have poor image quality and timebase correction is effective.
- Confirm the types of video signals, see "LIST OF COMPATIBLE SIGNALS". (⇒ page 50)

Example: AV equipment

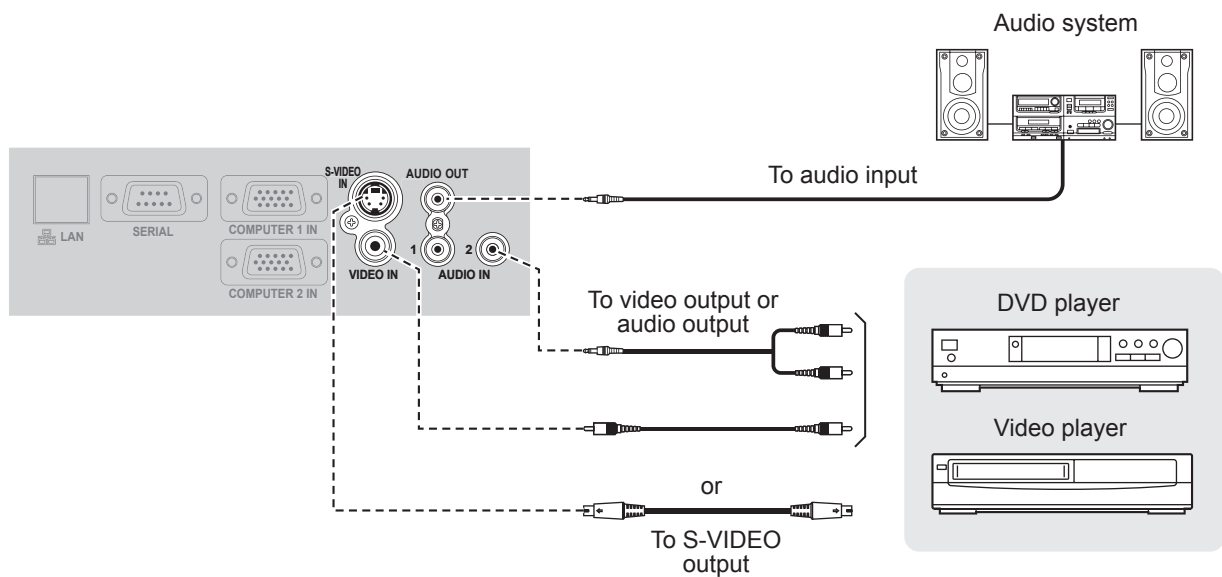

NOTE:

- Switch the audio connection manually for more than one AV equipment connections.

Connections (continued)

Example: Computers

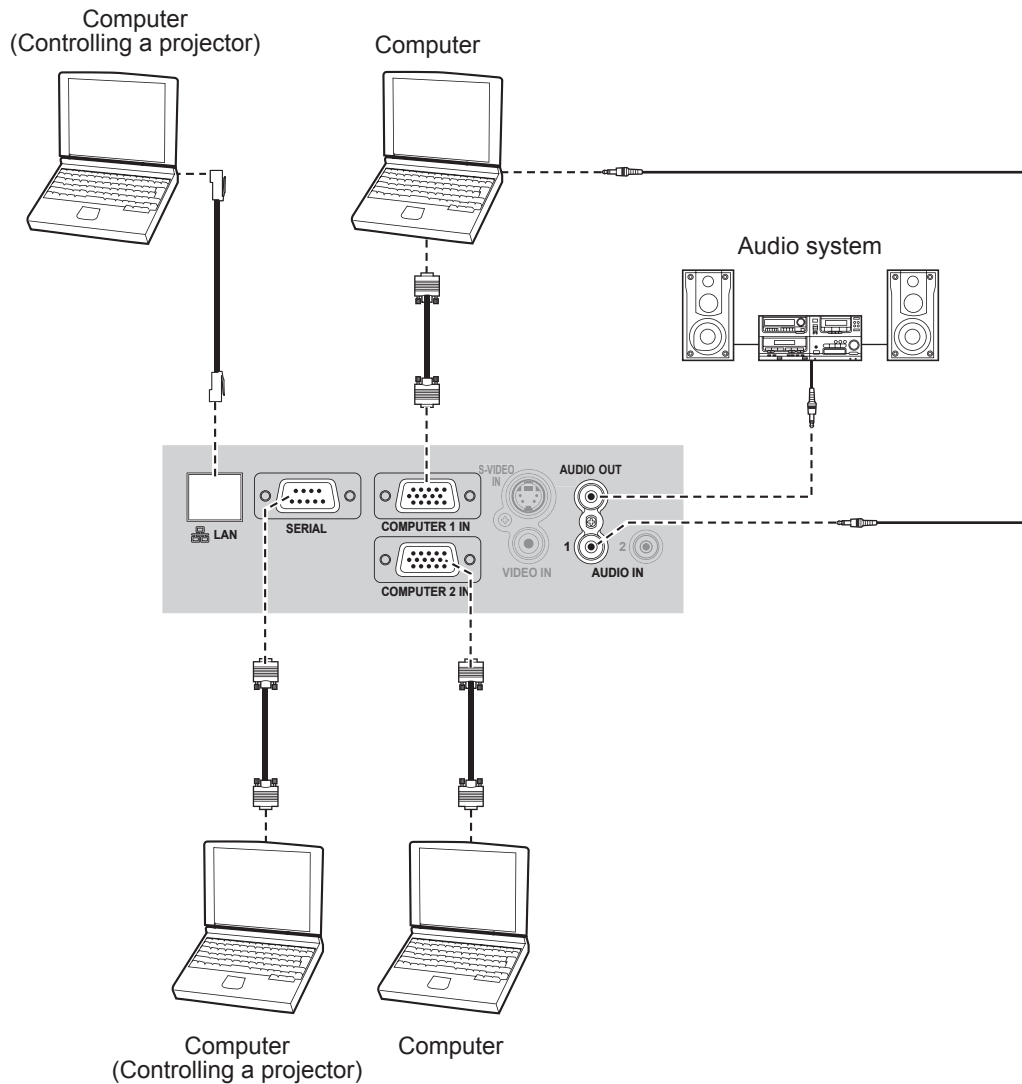

NOTE:

- For the network connection between the projector and computers, see “Network Operation Manual” in the CD-ROM provided.
- Only the RGB signal cable (1 piece) is attached. If any other cables are necessary, purchase them from the market.

Turn the projector ON or OFF

POWER CORD

Fix the provided “power cord secure lock” to the power cord on the projector to prevent the cord from coming off.

For details, see “Precautions with regard to safety”. (⇒ pages 5 to 9)

Install the “power cord secure lock”

- 1 Push the connector all the way into the AC IN terminal ensuring that the shape of the connector matches that of the terminal.

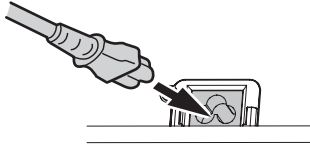

- 2 Align the side of the “power cord secure lock” with the side of the “Rail guide” of the AC IN terminal and slide it in.

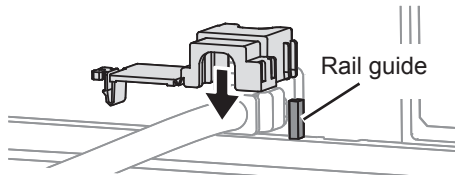

- 3 Latch to the latch catcher and press until it clicks.

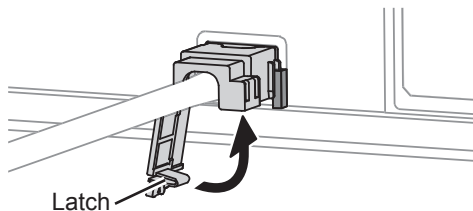

- 4 Connect the power plug to a wall outlet.

Detach the “power cord secure lock”

- 1 Unplug the power plug from the wall outlet.
- 2 Depress the latch and slide off the lock.

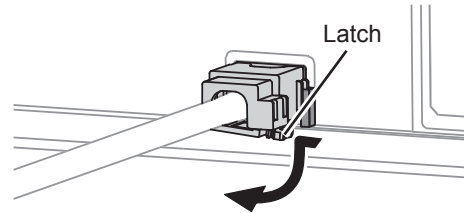

- 3 Slide up the “power cord secure lock” and remove it.

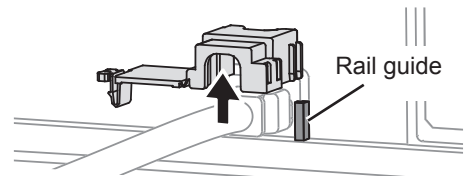

- 4 Hold the connector firmly and detach it from the AC IN terminal.

Direct power on function

If the power cord is connected to a wall outlet with INITIAL START UP (PROJECTOR SETUP menu) is set to ON, projection will start even when the control panel is disabled. (⇒ page 37)

Direct power off function

You can switch off the electric power supply any time by unplugging the power plug from the wall outlet.
The internal cooling fan keeps operating using the internal power supply and automatically stops when cooled.

NOTE:

- Do not put the projector into the bags with the **POWER** indicator lit.

Turn the projector ON or OFF (continued)

POWER INDICATOR

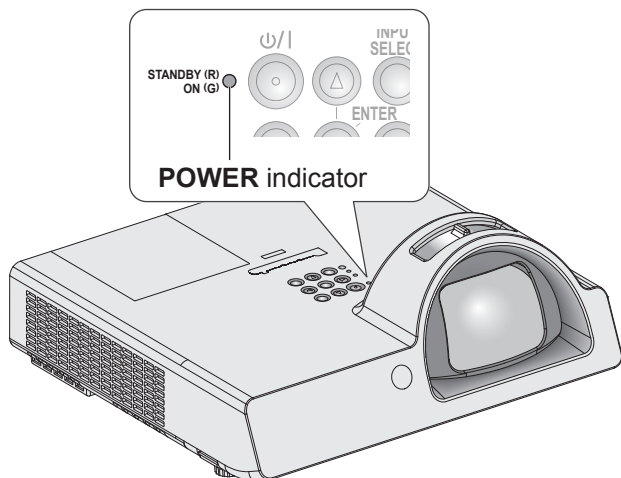

POWER indicator

→ shows status of the projector's power

When the **TEMP** indicator flashes, the **POWER** indicator lights red and you cannot turn the projector on.

POWER indicator status

Indicator status		Status
No illumination or flashing		No power is supplied and the internal cooling fan is not operating.
Red	Lit	The power is turned off (when STANDBY MODE is set to ECO). If [POWER] button is pressed, projection starts.
	Flashing	The power is turned off (when STANDBY MODE is set to NORMAL). If [POWER] button is pressed, projection starts.
Green	Flashing	The power is on and preparing for projection.
	Lit	The projector is projecting.
Orange	Lit	No power supply and the power is preparing for being turned off. It is turned off (The projection is set in STANDBY MODE) after a while.
	Flashing	The power is switched on again while cooling the lamp and recovering to the projection mode. Recovery may take a while.

NOTE:

- When the power is turned off, the internal fan cools the lamp using internal power supply.
- The power is turned on again while cooling the lamp and recovers to the projection mode. Recovery may take a while.
- While the power is turned off (when **STANDBY MODE** is set to **ECO**, the **POWER** indicator is lit red), power of about 0.4 W is consumed.

Turn the projector ON or OFF (continued)

Before switching on the projector, remove the lens cap.

How to install and remove lens cap

- 1 Match the lens cap with the lens from underside.
- 2 Push in the front part (A) of the claw until it clicks.
- 3 To remove, pull the claw (B) in the opposite direction to installation.

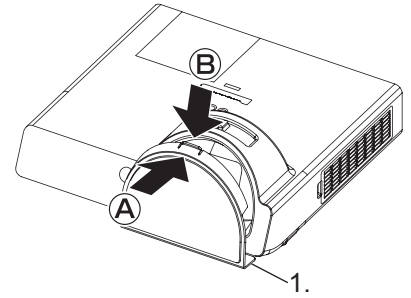

TURN THE PROJECTOR ON

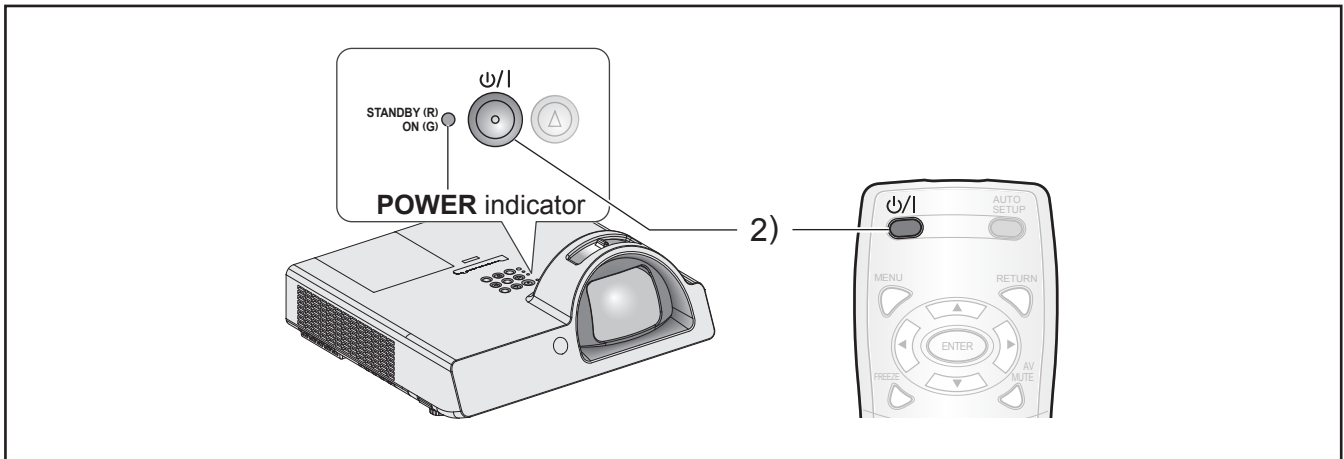

Before switching on the projector, make sure the mains lead and all the other devices are connected correctly. (⇒ page 16)

- 1 **Connect the power cord.** (⇒ page 18)
After a while the “power indicator” lights or flashes in red.
- 2 **Press the POWER button.**
 - **POWER** indicator flashes green several times before it lights up and the **STARTUP LOGO** is displayed. See **STARTUP LOGO** in **DISPLAY OPTION** menu. (⇒ page 34)

NOTE:

- Confirm that **CONTROL PANEL** (when operating with the projector body) or **REMOTE CONTROLLER** (when operating with the remote control) under **CONTROL DEVICE SETUP** in the **SECURITY** menu is set to **ENABLE**. (⇒ page 42)
When setting the **SECURITY** menu, you will be asked to input the password. (⇒ page 40)
- When starting up the projector, some small rattling or tinkling sound may be heard. These are normal and will not affect the performance of the projector.
- When the internal cooling fan is operating, some operational sound may be heard. The loudness of the operational sound depends on the external temperature.
- If **INITIAL START UP (PROJECTOR SETUP** menu) is set to **ON**, the projector starts projecting when the power cord is connected to a wall outlet. (⇒ page 37)
- If the projector is turned on again while the internal cooling fan is still operating by the internal power supply, the display may flicker due to the specifications of the lamp. These are normal and will not affect the performance of the projector.

Turn the projector ON or OFF (continued)

TURN THE PROJECTOR OFF

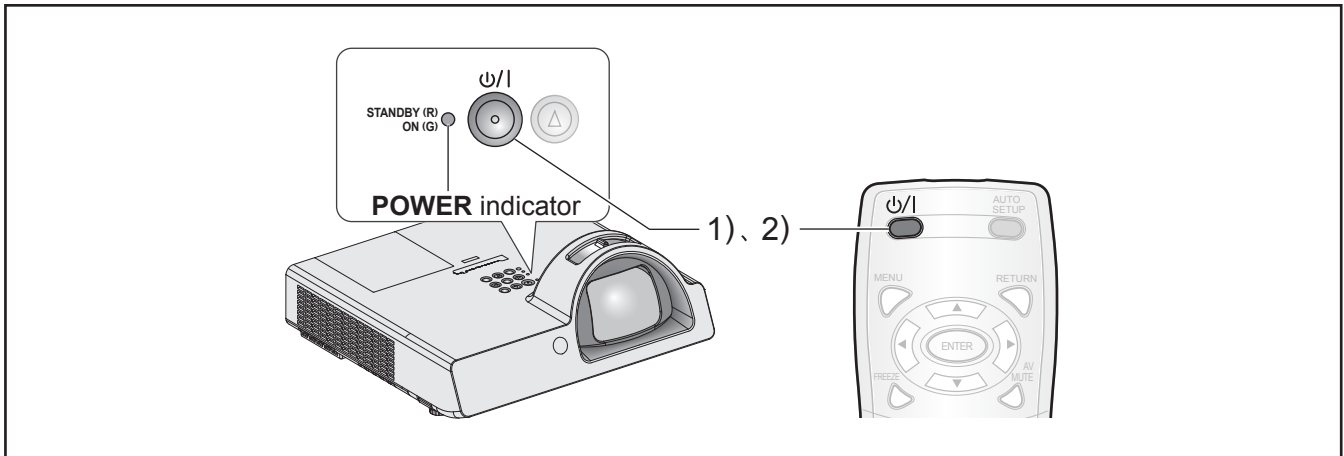

When operating the projector, check the status of the **POWER** indicator. (⇒ page 19)

1 Press the **POWER** button.

A confirmation screen will be displayed – the screen will go off and return to projection if there is no operation for approximately 10 seconds.

2 Press the button again.

The lamp goes off and the projection stops.

- The cooling fan continues its rotation and **POWER** indicator lights orange. Wait until the **POWER** indicator turns red.
- If **STANDBY MODE** is set to **NORMAL**, the **POWER** indicator flashes red. (⇒ page 37)

3 After the **POWER** indicator lights or flashes in red, disconnect the power plug from the socket. (⇒ page 18)

- For urgency, you may disconnect the power plug immediately since the **DIRECT POWER OFF** function is installed.

NOTE:

- Confirm that **CONTROL PANEL** (when operating with the projector body) or **REMOTE CONTROLLER** (when operating with the remote control) under **CONTROL DEVICE SETUP** in the **SECURITY** menu is set to **ENABLE**. (⇒ page 42)
- Power can be turned off by pressing [**POWER**] for at least 0.5 seconds.

Project an image

Preparations

- Confirm the connections of the peripheral devices (⇒ page 16, 17) and power cord (⇒ page 18).
- Switch on the power (⇒ page 20) to start projecting.
- Select the input signal and adjust the image.

SELECT THE INPUT SIGNAL

1 Switch on the connected devices.

When playing a connected DVD player, if **SIGNAL SEARCH (DISPLAY OPTION menu)** is set to **ON**, the input signal is detected and projected automatically when the projector is switched on. (⇒ page 35)

- Set the **INPUT GUIDE (DISPLAY OPTION → ON-SCREEN DISPLAY menu)** to **DETAILED**. If the projector cannot detect any input signal, the "Computer connection guide" will be displayed. (⇒ page 33)

2 Select an input signal.

The image selected with any of the **[INPUT SELECT]** button is projected.

NOTE:

- Change the settings in the **PICTURE** menu according to the connected device for example DVD, video tape, etc., to be played. (⇒ page 28)
- Confirm the aspect ratio of the screen and image. Select the optimum aspect ratio. (⇒ page 31)

POSITION THE IMAGE

When setting up the projector for the first time or setting up at a new place, you must perform the following operations.

1 Adjust the vertical angle of the projector.

- Place the projector at the right angle from the screen.

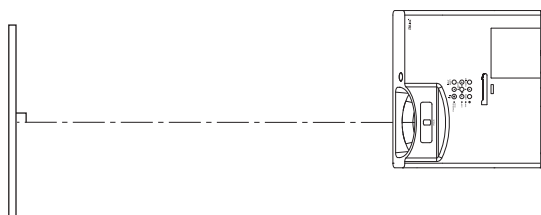

- Press the leg adjuster button **(A)** and adjust the vertical projection angle. Then, adjust the projected image to the center of the screen.

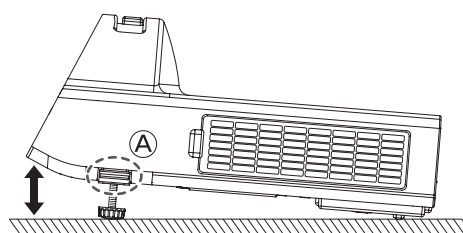
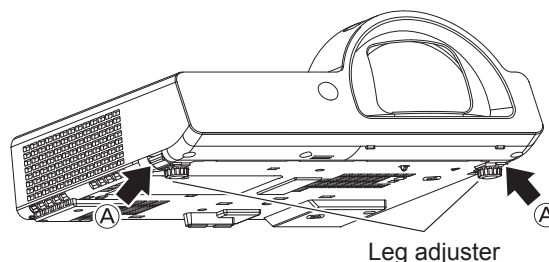

2 Adjust the projection focus.

- Turn the focus ring to adjust the projected image.

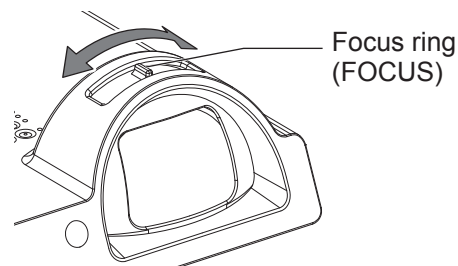

NOTE:

- If keystone distortion occurs, see **KEystone**. (⇒ page 30)
- If the focus is adjusted, the shape (distortion) of the projected image changes. Adjust while checking the balance between the general focus of the projected image and shape (distortion).

Remote control operation



You can confirm the selected input terminal (from the graphical input terminal guide on the upper right of the screen), if **INPUT GUIDE (DISPLAY OPTION → ON-SCREEN DISPLAY menu)** is set to **DETAILED**. (⇒ page 33)

You can change the input with [**▲▼◀▶**]. It may take some time to change the image after the input signal is switched.

NOTE:

- Input a compatible signal shown in the “LIST OF COMPATIBLE SIGNALS”. (⇒ page 50)
- For the input terminals, see “Connections”. (⇒ page 16)
- The input guide automatically disappears when it is left idle.

Press [**INPUT SELECT**] on the control panel to switch the input in the following order. (⇒ page 11)

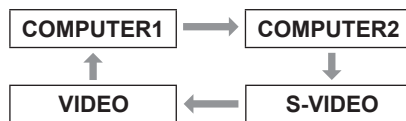

CAPTURE AN IMAGE

You can freeze the projected image and temporarily stop the sound, regardless of the playing condition of the connected device.



Press the button again to cancel it. The image is distorted momentarily when the projection is stopped and restarted.

STOP THE PROJECTION TEMPORARILY

You can temporarily stop the projection and the sound from the projector.



Press the button again to cancel it.

SWITCH THE INPUT SIGNAL

You can switch the input signal to be projected.

COMPUTER



The options below are displayed each time you press this button.

COMPUTER1	Signal input to COMPUTER1 IN terminal
COMPUTER2	Signal input to COMPUTER2 IN terminal

VIDEO



The options below are displayed each time you press this button.

S-VIDEO	Signal input to S-VIDEO IN terminal
VIDEO	Signal input to VIDEO IN terminal

SET UP THE IMAGE POSITION AUTOMATICALLY

The projector automatically adjusts the **SHIFT**, **DOT CLOCK** and **CLOCK PHASE** when an RGB signal is input.

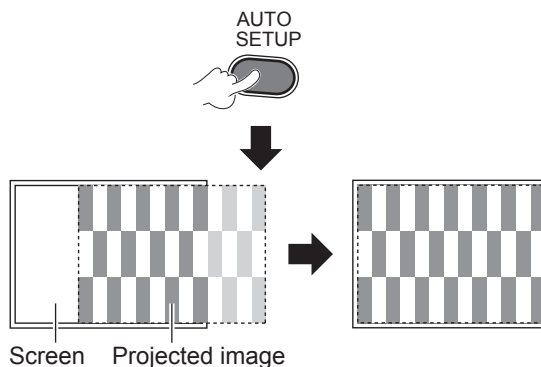

NOTE:

- The **SIGNAL SEARCH** will be in operation when it is set to **ON**. (⇒ page 35)
- If the dot clock frequency is higher than 162 MHz, **DOT CLOCK** and **CLOCK PHASE** can not be adjusted automatically. (⇒ page 30, 31)
- If the projected signal or image is too dark or blurred around the edge, **AUTO SETUP** may stop the process before completing the adjustment or adjust abnormally. Project a much clearer or lighter image and try again.

Remote control operation (continued)

RESET TO FACTORY DEFAULT SETTINGS

You can reset most of the customized settings to the factory default settings.

DEFAULT



For details, see “Reset to factory default settings”.
(⇒ page 26)

CONTROL SPEAKER VOLUME

You can control the volume of the built-in speakers and output audio sound.



+ : increases the volume
- : decreases the volume

PROJECT AN IMAGE USING INDEX-WINDOW

You can split a projected image into 2 windows using **INDEX-WINDOW**. One frozen image is stored in memory and displayed on the left side of the screen. Projection continues for the other image on the right side.

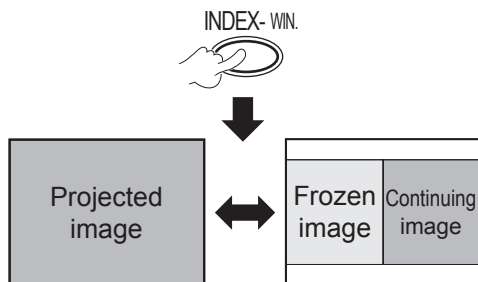

Press **[RETURN]** to escape.

INDEX-WINDOW display

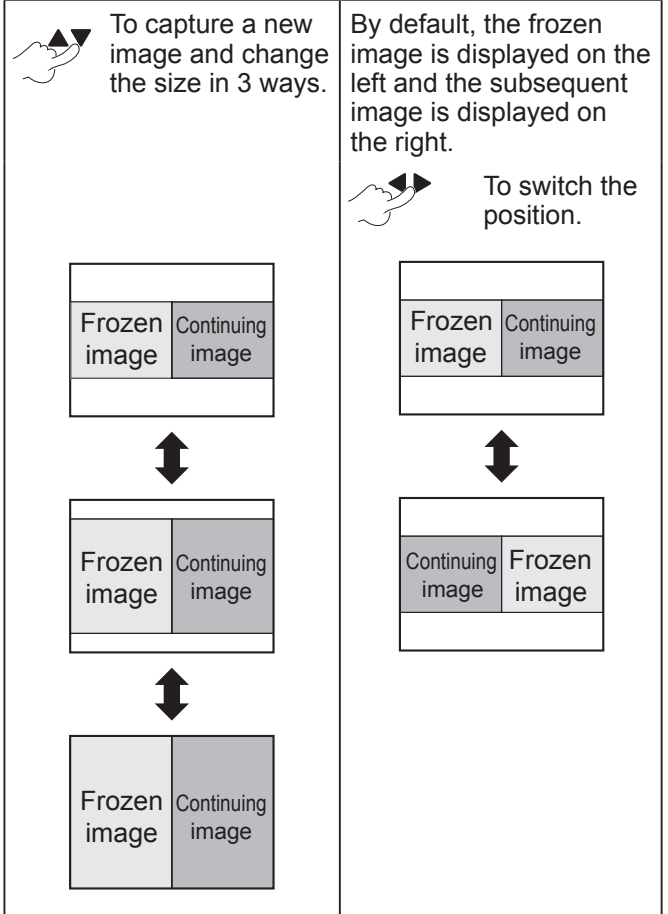

NOTE:

- The aspect ratio of the image is changed and becomes vertically elongated.
- If you change the window size, the aspect ratio of the image is changed. (⇒ page 31)
- While in **INDEX-WINDOW** mode, press **[ENTER]** to capture a new image and the frozen image's window will be updated.
- When capturing a quick moving picture, repeat several times to get a stable picture.

Remote control operation (continued)

ENLARGE THE IMAGE

You can enlarge the projected image to the center position by emphasizing within the range of 1× to 2×.

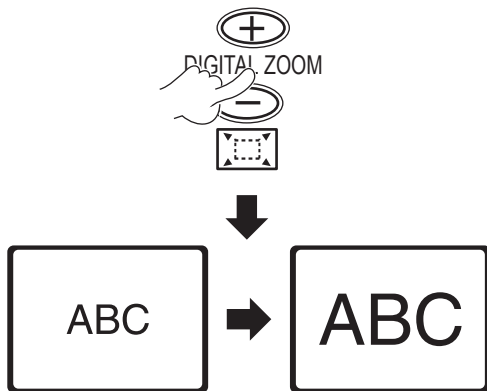

Press [RETURN] or [MENU] to escape.

[DIGITAL ZOOM] button operation

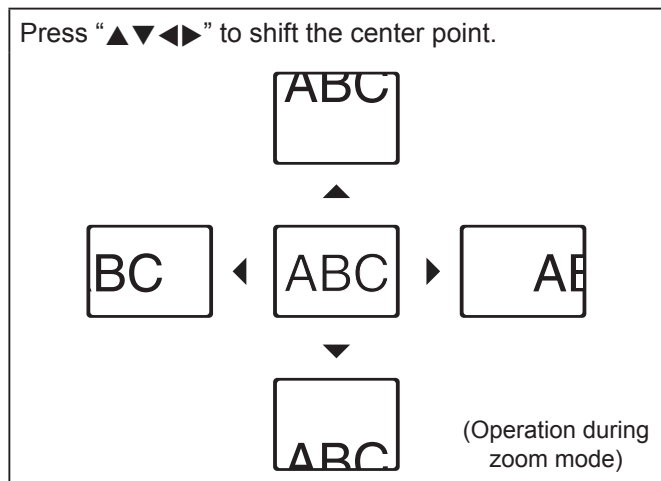
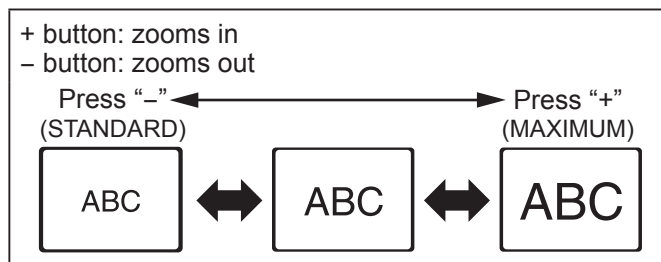

NOTE:

- When the **COMPUTER** signal is input, if **FRAME LOCK** in the **POSITION** menu is **OFF**,
→ enlargement range is 1× to 3×.
- When the **COMPUTER** signal is input, if **FRAME LOCK** in the **POSITION** menu is **ON**,
→ enlargement range is 1× to 2×.
- When another signal is input, the enlargement range is from 1× to 2× by 0.1.
- **DIGITAL ZOOM** mode is canceled when the input signal is changed.
- During **DIGITAL ZOOM** mode, [AUTO SETUP], [FREEZE], [DEFAULT], [INDEX-WINDOW] and [FUNCTION] (except when **AV MUTE** is assigned) buttons are not available.
- The image is distorted momentarily when the image is zoomed.

USE AN ASSIGNED FUNCTION

You can select a useful function from the list and assign it to [FUNCTION] button as a shortcut.

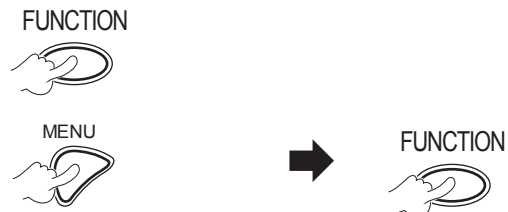

To display the on-screen menu (main menu, sub-menu or detailed menu).

For the menu operation, see “OPERATE THE MENU”. (⇒ page 26)

Press and hold for at least 3 seconds.

When not using the [FUNCTION] button

- 1 Select **DISABLE** in **FUNCTION BUTTON** (**PROJECTOR SETUP** menu).
- 2 Press [ENTER].
- 3 Select **OK**.
- 4 Press [ENTER].

NOTE:

- For details, see **FUNCTION BUTTON** in **PROJECTOR SETUP** menu. (⇒ page 38)

Menu operation

OPERATE THE MENU

Depending on the selected input signals, some items and functions may not be adjusted or available. Some can be adjusted without any signals.

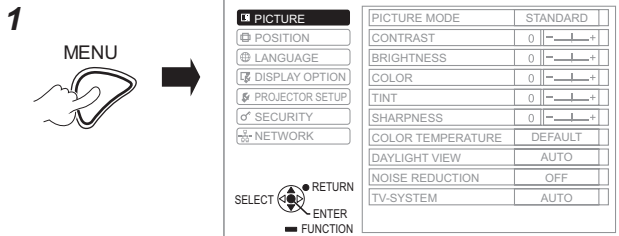

2 Select the main menu item.

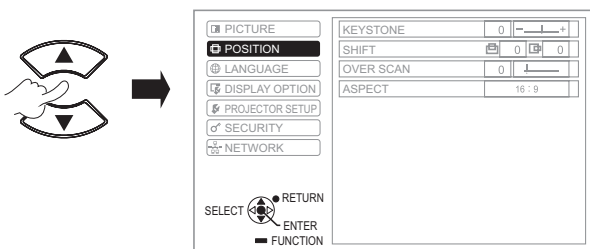

3 Select the sub-menu item.

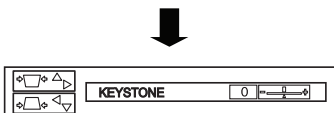
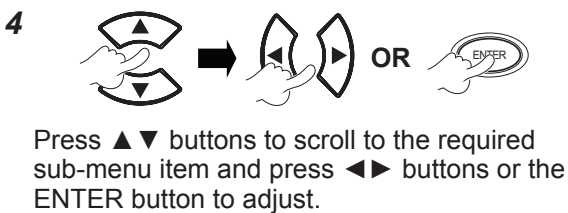
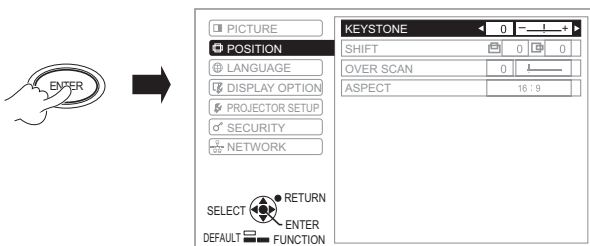

The selected menu is called up while other menu item disappears from the screen.

NOTE:

- Press [MENU] or [RETURN] to return to the previous menu. Press repeatedly to exit from the menu mode and return to the projection.
- Called up item will disappear after 5 seconds without any operation and return to the menu mode.
- For the sub-menu items, see "SUB MENU" in the ON-SCREEN MENU (⇒ page 27).

Reset to factory default settings

DEFAULT During sub-menu screen display:
The items of the sub-menu currently displayed are reset to the factory default settings.



During called up item screen display:
Only the item adjusted currently is reset to the factory default setting.

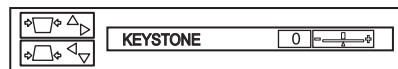

NOTE:

- You cannot reset all the settings at one time to the factory default settings.
- For resetting all the settings, see INITIALIZE ALL (PROJECTOR SETUP menu). (⇒ page 39)
- Not all menu items can be reset by pressing [DEFAULT]. Adjust each menu item manually.

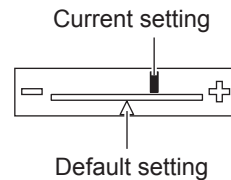

ON-SCREEN MENU

You can access other functions from operating this menu by referring to "OPERATE THE MENU". (⇒ see left)

MENU The **ON-SCREEN MENU** displayed consists of the main menu and sub-menu.

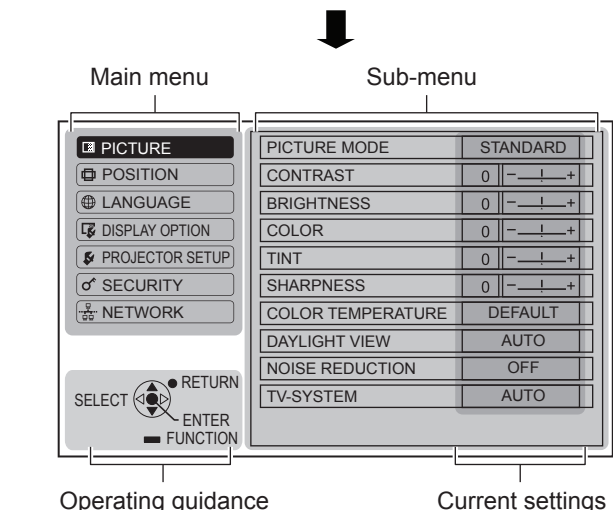

Menu operation (continued)

MAIN MENU

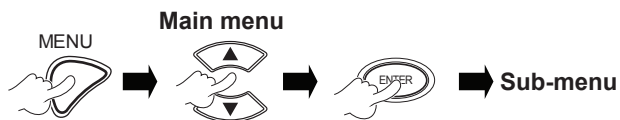

	PICTURE
	POSITION
	LANGUAGE
	DISPLAY OPTION
	PROJECTOR SETUP
	SECURITY
	NETWORK

SUB MENU

Select the required sub-menu item and press **ENTER** to display the detailed menu.

PICTURE menu

S-VIDEO/VIDEO/RGB (Moving image)*1/YP_BP_R signal is input.

Sub-menu item	Default	Page
PICTURE MODE	STANDARD	28
CONTRAST	0	28
BRIGHTNESS	0	28
COLOR	0	29
TINT	0	29
SHARPNESS	0	29
COLOR TEMPERATURE	DEFAULT	29
DAYLIGHT VIEW	AUTO	29
NOISE REDUCTION*2	OFF	29
TV-SYSTEM*2	AUTO	29
RGB/YP _B P _R *3	AUTO	30

*1 RGB moving images can be projected only when the following signals:

480i, 576i, 480p, 576p, 1 080/60i,
1 080/50i, 1 080/60p, 1 080/50p, 720/60p,
720/50p

*2 Input signal is S-VIDEO/VIDEO.

*3 Input signal is RGB/YP_BP_R.

RGB (Still image) is input.

Sub-menu item	Default	Page
PICTURE MODE	DYNAMIC	28
CONTRAST	0	28
BRIGHTNESS	0	28
SHARPNESS	0	29
WHITE BALANCE RED*1	0	29
WHITE BALANCE GREEN*1	0	29
WHITE BALANCE BLUE*1	0	29
COLOR TEMPERATURE	DEFAULT	29
DAYLIGHT VIEW	AUTO	29
RGB/YP _B P _R *2	AUTO	30

*1 Input signal is RGB.

*2 Input signal is RGB (VGA60).

NOTE:

- The factory default values vary depending on the **PICTURE MODE** setting.

POSITION menu

Sub-menu item	Default	Page
REALTIME KEYSTONE	OFF	30
KEYSTONE	0	30
SHIFT*1	0	30
DOT CLOCK*1	0	30
CLOCK PHASE*1	0	31
OVER SCAN*1	0	31
ASPECT	16:9	31
FRAME LOCK*1	OFF	32

*1 The setting is activated or deactivated depending on the input signal and the specific setting.

LANGUAGE menu

For details, see "LANGUAGE MENU". (⇒page 33)

DISPLAY OPTION menu

Sub-menu item	Default	Page
ON-SCREEN DISPLAY	—	33
CLOSED CAPTION SETTING	OFF	34
STARTUP LOGO	ON	34
AUTO SETUP	AUTO	35
SIGNAL SEARCH	ON	35
BACK COLOR	BLUE	35
WIDE MODE*1	AUTO	36
SXGA MODE*1	SXGA	36
OTHER FUNCTIONS	—	36

*1 The setting is activated or deactivated depending on the input signal and the specific setting.

Menu operation (continued)

PROJECTOR SETUP menu

Sub-menu item	Default	Page
STATUS	—	36
NO SIGNAL SHUT-OFF	DISABLE	37
INITIAL START UP	LAST MEMORY	37
INSTALLATION	FRONT/DESK	37
HIGH ALTITUDE MODE	OFF	37
STANDBY MODE	ECO	37
LAMP POWER	NORMAL	37
LAMP RUNTIME	—	38
EMULATE	DEFAULT	38
FUNCTION BUTTON	STATUS	38
AUDIO SETTING	—	38
TEST PATTERN	—	39
INITIALIZE ALL	—	39

SECURITY menu

Sub-menu item	Default	Page
PASSWORD	OFF	40
PASSWORD CHANGE	—	40
TEXT DISPLAY	OFF	40
TEXT CHANGE	—	40
MENU LOCK	OFF	41
MENU LOCK PASSWORD	—	41
CONTROL DEVICE SETUP	—	42

NETWORK menu

For details of items, see “Network Operation Manual”.

Sub-menu item	Default
WIRED LAN	—
NAME CHANGE	—
NETWORK CONTROL	ON
STATUS	—
INITIALIZE	—

NOTE:

- Sub-menu items and the factory default settings vary according to the selected input signal.

PICTURE MENU

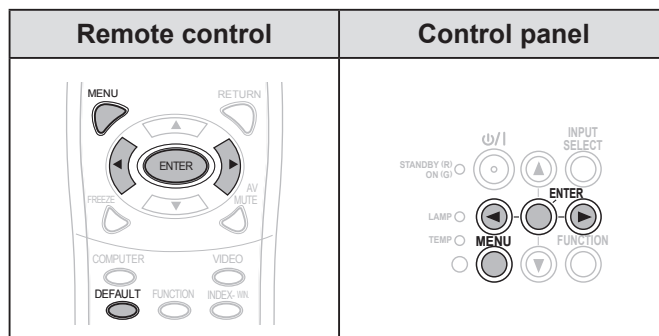

Set the selected item with [◀▶].

PICTURE MODE

You can optimize the projected image depending on the projection's environment.

Change setting   Change setting

STANDARD	Setting for general image
DYNAMIC	Setting for brightness and sharpness
BLACKBOARD	Setting for when projecting on a blackboard
WHITE BOARD	Setting for when projecting on a white board
NATURAL	Reproducing the original color of the image

NOTE:

- It may take a while until the selected mode is stabilized.

CONTRAST

You can adjust the contrast of the projected image.

Lower   Higher

BRIGHTNESS

You can adjust the brightness of the projected image.

Darker   Brighter

Menu operation (continued)

COLOR

You can adjust the color saturation of the projected image. (For **S-VIDEO/VIDEO/RGB** (Moving image)/**YPbPr** input signal only)



TINT

You can adjust the skin tone of the projected image. (For **S-VIDEO/VIDEO/RGB** (Moving image)/**YPbPr** input signal only)



SHARPNESS

You can adjust the sharpness of the projected image.



NOTE:

- The adjustable range depends on the input signal.

WHITE BALANCE

You can adjust the white balance in 3-color temperature. (For **RGB** (Still image) input signal only)



Advanced menu item	Default
WHITE BALANCE RED	0
WHITE BALANCE GREEN	0
WHITE BALANCE BLUE	0

COLOR TEMPERATURE

You can adjust the white balance of the projected image.



DEFAULT	Balanced white
HIGH	More bluish
LOW	More reddish

DAYLIGHT VIEW

You can keep the projected image bright and vivid even in well-lit rooms where the ambient light sources cannot be controlled.



AUTO	Automatic adjustment
ON	Active
OFF	Deactive

NOTE:

- Do not cover the Ambient Luminance Sensor(ALS) of the projector, otherwise the **AUTO** mode may not function properly.
- AUTO** is not available when **INSTALLATION** in **PROJECTOR SETUP** menu is set to **REAR/DESK** or **REAR/CEILING**.

NOISE REDUCTION

You can switch the automatic noise reduction system on/off. (For **S-VIDEO/VIDEO** input signal only)



OFF	No noise reduction
ON	Automatic noise reduction

NOTE:

- If **NOISE REDUCTION** is set active when the selected input signal has less noise, the image may look different from the true image. If so, set to **OFF**.

TV-SYSTEM

Switch the setting manually to match the video data. (For **S-VIDEO/VIDEO** input signal only)

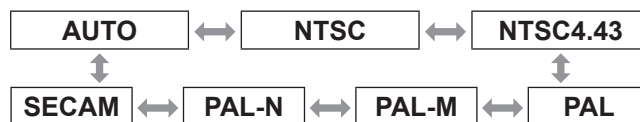

NOTE:

- AUTO** mode is selected by default.
- When the projector is not working properly in **AUTO** mode, change the setting according to each TV system type.
- AUTO** setting will automatically select the compatible signal from **NTSC/NTSC 4.43/PAL/PAL60/PAL-M/PAL-N/SECAM**.

Menu operation (continued)

RGB/YPbPr

(For RGB/YPbPr input signal only)
Select the signals to be input to the **COMPUTER 1 IN** and **COMPUTER 2 IN** terminals.

Change setting  Change setting

AUTO	Automatic adjustment
RGB	For RGB signals
YPbPr	For YPbPr signals

NOTE:

- **AUTO** mode is selected by default.
- Select **RGB** or **YPbPr** according to the input signal if the image is not normally projected during **AUTO** mode. The function only becomes effective when certain signals are input:
(VGA60, 480i, 576i, 480p, 576p, 1 080/60i, 1 080/50i, 1 080/60p, 1 080/50p, 720/60p, 720/50p)

POSITION MENU

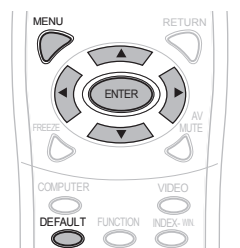
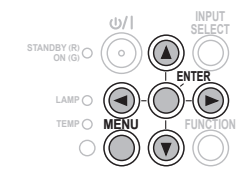
Remote control	Control panel
	

Set the selected item with [**▲▼◀▶**].

REALTIME KEYSTONE

If the projector is aligned non-perpendicularly to the screen, or if the projection screen has an angled surface; the keystone will be automatically corrected.

Change setting  Change setting





OFF	Deactive
ON	Active

NOTE:

- If the detected inclination of the projector is within 5 degrees upward/downward from the level, the **KEYSTONE** correction is not carried out automatically even if the **REALTIME KEYSTONE** is **ON**.
- If you need to correct the keystone, you can correct the distortion manually by adjusting the **KEYSTONE**.

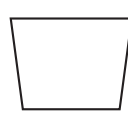
KEYSTONE

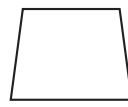
If you need to correct the angle of the projection even when the **REALTIME KEYSTONE** is activated, you can correct the keystone manually.

Image	Operation
	
	

NOTE:

- You can correct the distortion $\pm 10^\circ$ from the plane.
- For a better image quality, install the projector to minimize distortion.
- The result of the keystone correction will affect the aspect ratio and the size of the image.
- The image is distorted momentarily when the keystone is corrected.

SHIFT

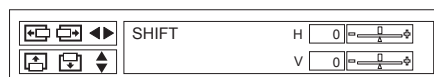

Horizontal (H): Press [**◀▶**] to move the image horizontally.

Vertical (V): Press [**▲▼**] to move the image vertically.

NOTE:

- This function can be adjusted by pressing the **◀▶▲▼** buttons directly.

DOT CLOCK

If there are interference patterns on the projected image (referred as moire or noise), minimize it by pressing [**◀▶**] to adjust the clock frequency. (For **RGB** (Still image) input signal only)

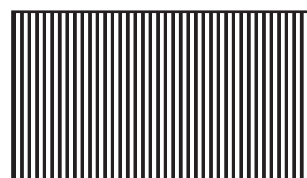

NOTE:

- **DOT CLOCK** needs to be adjusted before adjusting the **CLOCK PHASE**.

Menu operation (continued)

CLOCK PHASE

If you require further adjustment for the same reason as the **DOT CLOCK** adjustment, you can further adjust the timing of the clock. (For **RGB/YPbPr** input signal only)
Press ◀▶ buttons to adjust.

NOTE:

- If the projecting signal's dot clock frequency is higher than 162 MHz, adjusting **DOT CLOCK** or **CLOCK PHASE** may not make any difference. Refer to "LIST OF COMPATIBLE SIGNALS". (⇒ page 50)

OVER SCAN

Use this function when characters or pictures are cropped near the periphery of the projected image.
(For **S-VIDEO/VIDEO/RGB** (Moving image)/**YPbPr** input signal only)



Setting range: 0 to +3

ASPECT

You can manually switch to the desired aspect ratio.
Selectable options vary according to input signal.

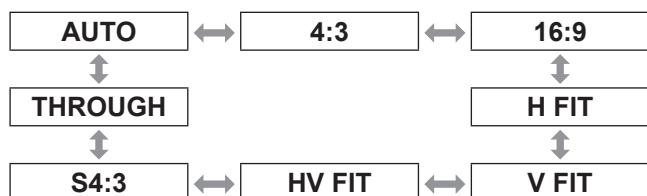

NOTE:

- **AUTO** mode is displayed only when NTSC/480i signal is input.
- **THROUGH** mode is displayed only for certain signals.
- For the wide signal*2, the aspect ratio option cycles through 16:9 ↔ V FIT ↔ HV FIT.

AUTO (For NTSC/480i input signal only)

The signal which contains an identifying signal will be detected and will automatically project the image in the most optimal aspect setting.

4:3

Standard input signal*1 → projection is 4:3 aspect ratio.

Input signal: XGA

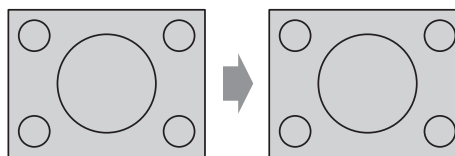

Image:

16:9

Standard input signal*1 → projection is 16:9 aspect ratio.

Wide input signal*2 → projection is the current aspect ratio.

Input signal: 1 080/60i

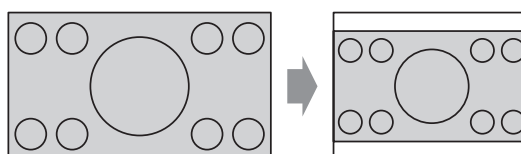

Image: Panel:

H FIT

Standard input signal*1 → projection without changing the aspect ratio uses all the panel pixels in the horizontal direction to crop the top and bottom of the image.

Input signal: SXGA

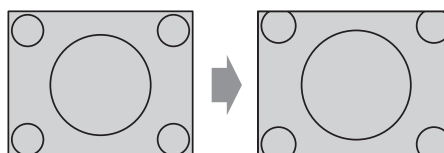

Image:

*1 A standard signal has an aspect ratio of 4:3 or 5:4.

*2 A wide signal has an aspect ratio of 16:10, 16:9 or 15:9.

Menu operation (continued)

V FIT

Wide input signal*2 → projection without changing the aspect ratio uses all the panel pixels in the vertical direction to crop the right and left of the image.

Input signal: 1 080/60i

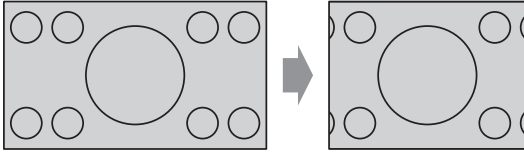

Image:

HV FIT

The image is projected all over the panel pixels (screen). The input signal is projected at the aspect ratio of the panel screen.

Input signal: 1 080/60i

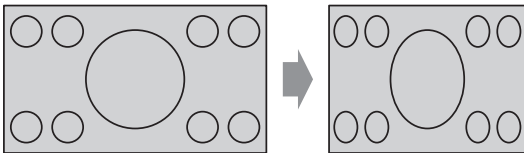

Image:

S4:3

Standard input signal*1 → the input signal will be sized down 75% and projected. S4:3 mode is effective when projecting 4:3 image onto a 16:9 screen.

Input signal: XGA

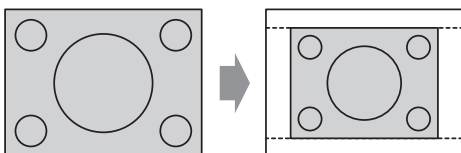

Image: Panel: Screen:

*1 A standard signal has an aspect ratio of 4:3 or 5:4.

*2 A wide signal has an aspect ratio of 16:10, 16:9 or 15:9.

THROUGH

The image will be projected without any size adjustment.

This function can be set when the input signal is smaller than the number of the LCD panel pixels (1024 x 768).

Input signal: NTSC

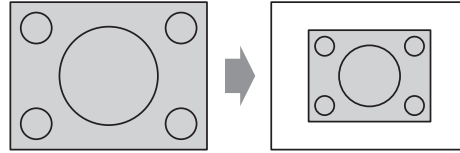

Image: Panel:

NOTE:

- When a 4:3 image is projected to 16:9 screen, the image may be distorted or some portions may be cropped. Select an aspect ratio (4:3) which retains the creator's intended image.
- The order of **ASPECT** types is defined not only by the input method but also by the input signals.
- If you project an enlarged or distorted copyrighted image using the **ASPECT** function for commercial use in a public place, you might infringe the copyright of the creator which is protected by the copyright law.

FRAME LOCK

If the projected image is bad, you can activate **FRAME LOCK** for synchronization. (For **RGB** input signal only)

Change setting  Change setting

ON	Active
OFF	Deactive

Menu operation (continued)

LANGUAGE MENU

Select the required language.

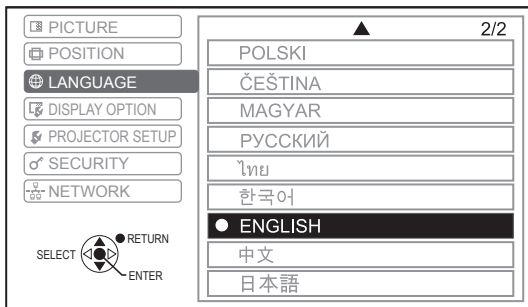
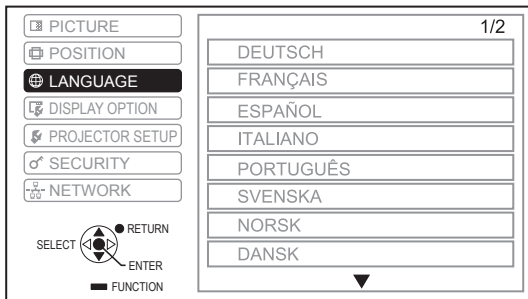
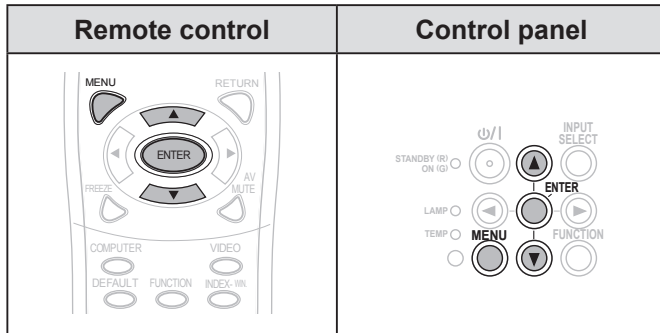

The set language is highlighted.

DISPLAY OPTION MENU

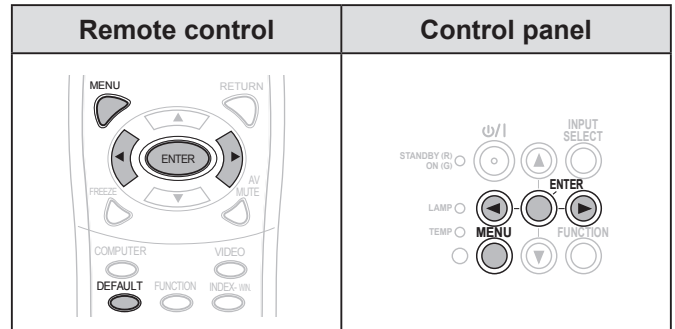

Set the selected item with [◀▶].

ON-SCREEN DISPLAY

You can set the on-screen display.



INPUT GUIDE

Set the display method of the input terminal name currently selected in the upper right corner of the screen.

DETAILED	Display the input method using graphic. The INPUT GUIDE will go off if there is no operation after 10 seconds.
OFF	Turn off the guide.
SIMPLE	Display the input method using text. The INPUT GUIDE will go off if there is no operation after 5 seconds.

Menu operation (continued)

Computer connection guide

You can switch the output signals from **COMPUTER1/COMPUTER2** terminal by pressing the following computer command keys.

Manufacturer	Image output selection command	Manufacturer	Image output selection command
Panasonic NEC	Fn + F3	lenovo LG SONY	Fn + F7
SAMSUNG HP	Fn + F4	DELL EPSON	Fn + F8
acer SHARP TOSHIBA	Fn + F5	FUJITSU	Fn + F10
		Apple	F7

NOTE:

- The command keys depend on the manufacturers. For detailed information, please refer to the instructions provided with the computers.
- If you want to turn off the computer connection guide, select **SIMPLE** or **OFF**.

OSD DESIGN

You can change the background of the on-screen menu (OSD).

TYPE1	Semi transparent black
TYPE2	Solid blue
TYPE3	Semi transparent dark blue

WARNING MESSAGE

You can choose to or not to display the warning messages.

ON	Warning messages will be displayed
OFF	No display

NOTE:

- When the **WARNING MESSAGE** is set to **OFF**, use the projector with utmost care as most of the warning messages will not be displayed.

CLOSED CAPTION SETTING

If the input signal contains closed captions, you can turn on the feature and switch channels.

CLOSED CAPTION

OFF	Deactive
ON	Active

MODE

CC1 - 4	Change the channels CC1 - 4
----------------	-----------------------------

NOTE:

- VCR with TBC (Time Base Corrector) function is recommended for video cassette tapes.

STARTUP LOGO

You can set the Panasonic logo, your own image or Pre-set letters to be displayed at the start of the projection.



ON	Display "Panasonic" logo
TEXT	Display the original text
USER	Display the image registered by the user
OFF	No display

NOTE:

- If **TEXT** is selected, the input letters are displayed at the start of the projection. You can display 2 lines of original text which contains up to 40 characters each.
- If **USER** is selected, the image transferred by the Logo Transfer Software is displayed at the start of the projection. (You can install the Logo Transfer Software from the provided CD-ROM.)
- STARTUP LOGO** will be displayed for 30 seconds.

Menu operation (continued)

Editing the original text

- 1 Press [◀▶] to select TEXT and then press [ENTER].
- 2 Press [▲▼] to select the desired line and then press [ENTER].

You can input and edit the text for the first line in **TEXT1** and the text for the second line in **TEXT2**.

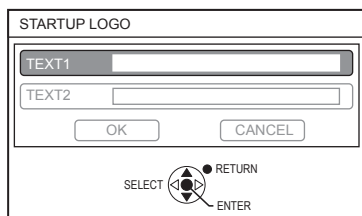

- 3 Press [▲▼◀▶] to select the desired character and then press [ENTER].

To delete all the input characters, move the cursor to **ALL DELETE** and then press [ENTER].

To delete a character, press [DEFAULT] or move the cursor to select the character then press [DEFAULT].

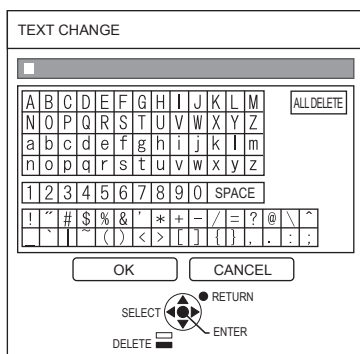

- 4 Select OK and then press [ENTER] to set the input text in the box.
- 5 Select OK again and then press [ENTER]. Select CANCEL or press [MENU/RETURN] to return to the previous menu without any setting.

AUTO SETUP

AUTO mode is selected by default.

If you do not need to perform automatic correction, select "**BUTTON**".



AUTO	When the projector detects COMPUTER signal, SHIFT , DOT CLOCK and CLOCK PHASE in the POSITION menu is automatically set.
BUTTON	Only when [AUTO SETUP] is pressed, SHIFT , DOT CLOCK and CLOCK PHASE in POSITION menu will be automatically set for COMPUTER signals. (⇒ page 23)

SIGNAL SEARCH

You can turn off the auto signal detection.



ON	Detects the input signal from the terminals and projects the image
OFF	Deactive

NOTE:

- **SIGNAL SEARCH** is not available during any input signal projection.

BACK COLOR

You can choose **BLUE** or **BLACK** screen for the projector when it is idle.



BLUE	Display blue screen
BLACK	Display black screen

Menu operation (continued)

WIDE MODE

Set this mode when projecting wide signals (16:9, 16:10, 15:9).



AUTO	Automatic setting
OFF	For 4:3 signals
ON	For WIDE signals

SXGA MODE

Set this mode when an **SXGA** signal is input and the projected image is trimmed.



SXGA	For normal projection
SXGA+	For projection when image is cropped

OTHER FUNCTIONS

You can perform some of the remote control button operations from the sub-menu.

AUTO SETUP

For details, see "SET UP THE IMAGE POSITION AUTOMATICALLY". (⇒ page 23)

FREEZE

You can capture the projected image as a still picture. While the image is frozen, the audio sound through the projector will stop.

Press **[RETURN]** to escape.

The image is distorted momentarily when the projection is stopped and restarted.

AV MUTE

You can temporarily stop projection and audio sound when the projector is left idle.



Press **[MENU]** to escape.

INDEX-WINDOW

For details, see "INDEX-WINDOW display". (⇒ page 24)

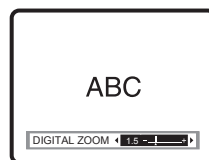
DIGITAL ZOOM



 button: zoom in
 button: zoom out

Press **[ENTER]** to select the enlargement.

Press **[MENU]** to escape.

The image is distorted momentarily when the image is zoomed.

PROJECTOR SETUP MENU

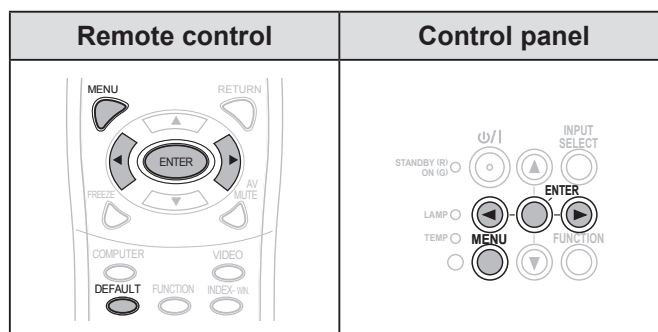

Set the selected item with **[◀▶]**.

STATUS

You can check the projector's status.

SIGNAL

NAME → Name of input signal

FREQUENCY → Scanning frequency of input signal

RUNTIME

PROJECTOR → Display the projector's current usage time

LAMP → Display the lamp's current usage time

Menu operation (continued)

NO SIGNAL SHUT-OFF

If no image signal is input for the time set using the timer, the projector will automatically enter into standby mode.

Change setting  Change setting

DISABLE	NO SIGNAL SHUT-OFF is disabled
15 – 60 MIN.	Timer can be set at a 5-minute intervals

INITIAL START UP

You can set the starting method when the power plug is connected to wall outlet.

Change setting  Change setting

LAST MEMORY	Projector starts from the last image before the power plug was disconnected
STANDBY	Projector starts in the standby mode
ON	Projector starts immediately

INSTALLATION

When installing the projector, select the projection method according to the projector's position.
(⇒ page 15)

Change setting  Change setting

HIGH ALTITUDE MODE

If you use the projector at high elevation, the **HIGH ALTITUDE MODE** setting need to be **ON** to set the fan speed to high.

Change setting  Change setting

OFF	Use in normal environment (below 1 400 m (4 593 ft) above sea level)
ON	Use at high altitude (at 1 400 m – 2 700 m (4 593 - 8 858 ft) above sea level)

NOTE:

- The loudness of fan noise depends on the **HIGH ALTITUDE MODE** setting.

STANDBY MODE

You can change the standby mode setting.

Change setting  Change setting

ECO	The standby power is reduced to 0.4 W to save power
NORMAL	The power of the projector can be turned ON and the audio output can be set active by controlling the computer connected via wired LAN in standby mode

LAMP POWER

You can adjust the power of the lamp to save electricity, prolong the lamp life and reduce the noise.

Change setting  Change setting

NORMAL	When higher luminance is required
ECO	When lower luminance is sufficient

NOTE:

- This function is disabled when no input signal is detected.
- ECO** setting is recommended when higher luminance is not required such as in a small room.

Menu operation (continued)

LAMP RUNTIME

You can check how long the lamp has been used.

NOTE:

- **LAMP RUNTIME** is important for lamp replacement timing. See "REPLACE THE LAMP UNIT". (⇒ page 45)
- Check the lamp unit replacement time. (⇒ page 45)
- If the lamp runtime has reached 3 800 hours, the red and gray marks appear alternately to notify you of the lamp replacement time.
- The lamp life varies depending on the usage condition (number of power-on times, etc.).

EMULATE

When the projector is controlled by a computer through serial input terminal, you can change the setting to use the former projector control commands.

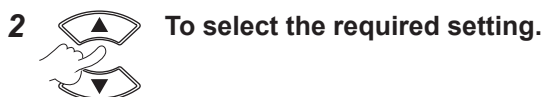

• DEFAULT	ST10 Series LB2 Series LB1 Series LB75 Series LB78 Series LB80 Series LB90 Series
D3500	D3500
D4000	D4000
D/W5K series	D5500 Series DW5000 Series D5600 Series DW5100 Series D5700 Series
D/W/Z6K series	D5000 Series D6000 Series DW6300 Series DZ6700 Series DZ6710 Series
L730	L520 Series L720 Series L730 Series
L780	L750 Series L780 Series
L735	L735 Series
L785	L785 Series
F/W series	F100 Series FW100 Series F200 Series F300 Series FW300 Series

NOTE:

- Some commands are not available. For details, please contact your dealer.

FUNCTION BUTTON

You can select a useful function from the list and assign it to **[FUNCTION]** button as a short-cut.



To display the on-screen menu (main menu, sub-menu or detailed menu).

For the menu operation, see "OPERATE THE MENU".

(⇒ page 26)

Press and hold for at least 3 seconds.

When not using the **[FUNCTION]** button (⇒ page 25)

NOTE:

- The text and button color will change once the setting has completed.

AUDIO SETTING

You can perform detailed setting for Audio.

VOLUME

You can adjust the volume of the built-in speakers and audio output sound.



BALANCE

You can adjust to listen to the sound played equally from both right and left external stereo speakers, or adjust the balance so that more sound plays from either the left or right side.



Menu operation (continued)

IN STANDBY MODE

You can turn **ON** or **OFF** the audio output in standby mode.

Change setting  Change setting

OFF	Deactive
ON	Active

NOTE:

- When **STANDBY MODE** is set to **ECO**, the audio output cannot be activated in the standby mode, even if **ON** is selected.

AUDIO IN SELECT

You can select the **AUDIO IN 1** or **AUDIO IN 2** terminal to connect the audio output of the devices connected to **COMPUTER 1 IN** or **COMPUTER 2 IN**.

Change setting  Change setting

AUDIO IN SELECT	
COMPUTER1 IN	Select AUDIO IN 1 or AUDIO IN 2 terminal
COMPUTER2 IN	Select AUDIO IN 1 or AUDIO IN 2 terminal

TEST PATTERN

You can use the 7 different test patterns to adjust the focus of the image.

 To display the test pattern.

Change pattern  Change pattern

Press **[MENU]** or **[RETURN]** to return to the **PROJECTOR SETUP** menu, or press repeatedly to escape the menu mode.

NOTE:

- The initial screen is an all white pattern. Only when **TEST PATTERN** is assigned to the **[FUNCTION]** button, the lattice pattern will be displayed as the initial screen.

INITIALIZE ALL

You can reset all of the customized settings in **MENU** to the factory default.

- If the **[ENTER]** is pressed in the **INITIALIZE ALL** menu, "**INITIALIZE ALL**" will be displayed. Select **OK** and press **[ENTER]**, "**NOW INITIALIZING...**" is displayed followed by "**POWER OFF**" display. Select **OK** and turn the power off according to the instruction. (All other buttons are deactivated.)
- The **LANGUAGE** and **INITIAL SETTING** menu screen will be displayed when the power is connected. (⇒ page 10)

NOTE:

- The usage time of the projector, lamp runtime and the **NETWORK** settings will not be initialized.
- When **PASSWORD** in **SECURITY** menu is activated, ensure to enter the correct password when initializing.
- After **INITIALIZE ALL** operation is completed, the password is reset to the factory default setting and **PASSWORD** setting is turned **OFF**.

Menu operation (continued)

SECURITY MENU

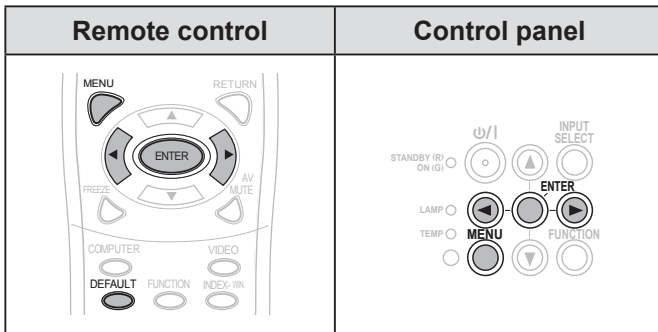

Set the selected item with [◀▶].

When you use **SECURITY** menu for the first time, you will be asked to perform the password operation. Input the *initial password* by pressing [▲▶▼◀▲▶▼◀] in this order and then press [ENTER].

NOTE:

- If you have changed the password, input the new password and press [ENTER].

PASSWORD

You can activate the security system and the password operation will be asked to perform when projection mode starts.

Change setting Change setting

OFF	Deactive
ON	Active

NOTE:

- PASSWORD** is set to **OFF** by default and when initialized.
- Change your password regularly. Do not use a simple password that is easy to decode.
- Unless you perform the correct password operation, all of the control buttons will be disabled except the [POWER] button.

PASSWORD CHANGE

You can change the password.

- To change the password.
(Up to 8 button operations can be set.)



- Input the password again and press the button.

NOTE:

- The entered password operations will appear as asterisks in the box.
- If the password input second does not match with the password input first, an error message is displayed. In this case, input the correct password again.

TEXT DISPLAY

You can set your original text to display regularly at the bottom of the projected image during projection.

Change setting Change setting

OFF	Deactive
ON	Active

- When **CLOSED CAPTION SETTING** is set to **ON**, **SECURITY TEXT** will not be displayed.

TEXT CHANGE

You can enter your original text to be displayed when **TEXT DISPLAY** is turned **ON**.



- To select the characters
(You can input up to 22 characters.)

To delete all the entered characters, move the cursor to **ALL DELETE** and press [ENTER].

Menu operation (continued)

To delete a character, press **[DEFAULT]** or move the cursor to the required character then press **[DEFAULT]**.

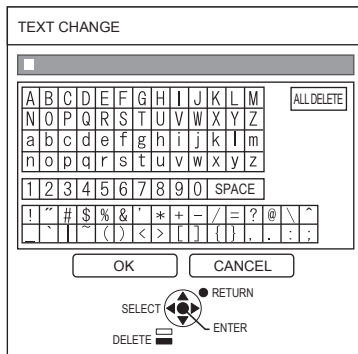

**To select
OK**

Select **CANCEL** or press **[MENU/RETURN]** to return to the previous menu without setting.

MENU LOCK

Press **[MENU]** to display the menu. You can lock or unlock the menu operation.

Change setting  Change setting

OFF	Unlock the menu operation
ON	Lock the menu operation

NOTE:

- Once **MENU LOCK** is set to **ON**, you cannot use the **[MENU]** button unless you input the correct password.
- The **MENU LOCK** is set to **OFF** by default and when initialized.

MENU LOCK PASSWORD

You can set a **MENU LOCK PASSWORD**.



**To select
the characters**

(You can input up to 16 characters.)

To delete all the entered characters, move the cursor to **ALL DELETE** and press **[ENTER]**.

To delete a character, press **[DEFAULT]** or move the cursor to the required character then press **[DEFAULT]**.

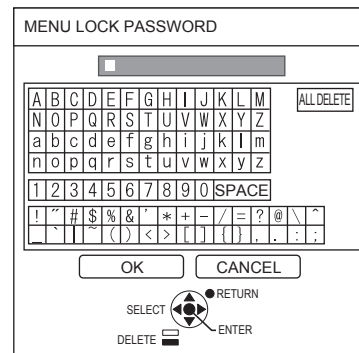

**To select
OK**

Select **CANCEL** or press **[MENU/RETURN]** to return to the previous menu without setting.

NOTE:

- When using the projector for the first time or after **INITIALIZE ALL** operation is activated, the initial password is set to **AAAA**.
- Change your password regularly. Do not use a simple password that is easy to decode.
- To reset the password to the initial password, see **MENU LOCK PASSWORD**. (⇒ page 52)

Menu operation (continued)

CONTROL DEVICE SETUP

You can enable/disable the button operations of the control panel and remote control.

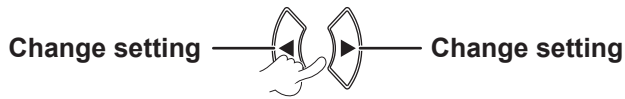

CONTROL PANEL

ENABLE	Enable the button operations
DISABLE	Disable the button operations

REMOTE CONTROLLER

ENABLE	Enable the button operations
DISABLE	Disable the button operations

NOTE:

- If **DISABLE** is selected and **[ENTER]** is pressed, the confirmation screen appears. Select **OK** and press **[ENTER]**.
- If any button is pressed after **CONTROL PANEL** is set to **DISABLE**, the password screen appears. Input the password which is set in the **SECURITY** menu. (If no operation is done, the password screen disappears in 10 seconds.)
- If you set both **CONTROL PANEL** and **REMOTE CONTROLLER** to **DISABLE**, all buttons' operations of the control panel and remote control are disabled and you cannot turn off the power.

How to clear **DISABLE**:

During the standby mode or projection, press and hold **[ENTER]** and **[MENU]** for at least 2 seconds, and **CONTROL PANEL** is set to **ENABLE**.

Change the setting of **REMOTE CONTROLLER** with the control panel.

NETWORK MENU

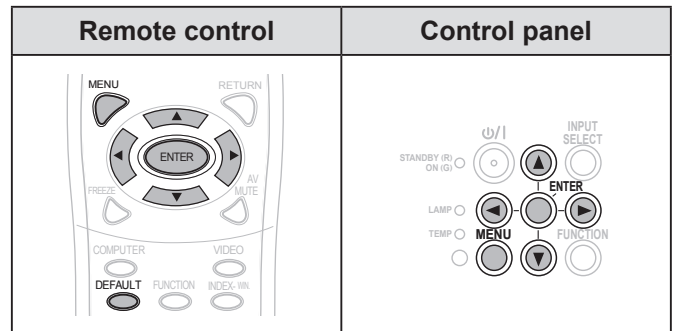

Set the selected item with **[◀▶]**.

NOTE:

- These items are set for network connection with a computer. For details of the PJ Link and network, see "Network Operation Manual".

WIRED LAN

You can set up a wired LAN.

NAME CHANGE

You can change the name of the projector.

NETWORK CONTROL

When controlling the projector with a computer on the network, you must turn this function **ON**.

STATUS

You can display the status of the network setting.

INITIALIZE

You can reset the settings of the network to the factory default settings.

NOTE:

- If **PASSWORD** (**SECURITY** menu) is activated, when the network setting is initialized, you will be required to input the password.

LAMP and TEMP indicators

The **LAMP** and/or **TEMP** indicators will light up to indicate that the projector has some problems.

NOTE:

- Make sure to turn off the power (see “TURN THE PROJECTOR OFF” on page 21) and confirm the power supply status with the **POWER** indicator. (⇒ page 19)

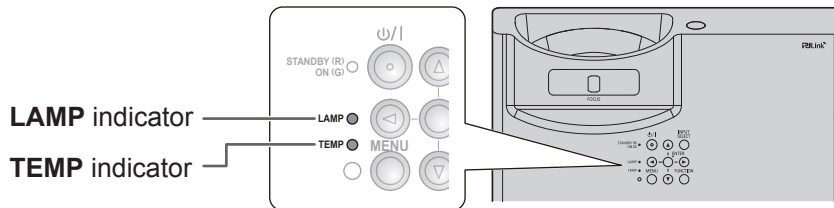

Manage the problem as follows:

LAMP INDICATOR

Indicator	• Illuminating red	• Flashing red		
Problem	LAMP RUNTIME has reached 3 800 hours.	LAMP circuit failure, abnormal function or the lamp unit is damaged.		
Cause	Lamp unit will run out soon and needs to be replaced.	The projector is turned on again too soon.	LAMP circuit failure, abnormal function.	Lamp unit is damaged.
Remedy	See “REPLACE THE LAMP UNIT”. (⇒ page 45)	Let the lamp unit cool down and turn on the projector after 90 seconds.	Turn the projector off (⇒ page 21) and contact an Authorized Service Center.	See “REPLACE THE LAMP UNIT”. (⇒ page 45)

NOTE:

- If the **LAMP** indicator still lights or flashes after the above remedy, contact an Authorized Service Center.

TEMP INDICATOR

Indicator	<ul style="list-style-type: none"> • Illuminating red while projecting and the alert will be displayed. • Flashing red and power is turned off. 			
Problem	<ul style="list-style-type: none"> The temperature inside and/or outside the projector is abnormally high. The projection may become darker than usual. The internal fan's operational noise may be louder than usual. 			
Cause	The air outlet port and air intake ports are covered.	The room temperature is too high.	The filter is excessively dirty and the ventilation is poor.	The projector is located at 1 400 - 2 700 m (4 593 - 8 858 ft).
Remedy	Remove object(s) from the air outlet port and air intake ports or clear around the projector.	Reinstall the projector in temperature controlled place. (⇒ page 54)	Clean the filter in a proper method. (⇒ page 44)	Turn on the projector* ¹ and set the HIGH ALTITUDE MODE to ON . (⇒ page 37)

*¹ The projector will operate for 2 minutes with **OFF** set at high elevation.

NOTE:

- Perform the above remedy; disconnect the power plug, and then supply the power again. If the **TEMP** indicator still lights or flashes after the above remedy, contact an Authorized Service Center.
- If temperature in the projector rises, the fan speed increases and the sound becomes louder.

Care and replacement

Preparations

Before cleaning, be sure to turn off the power and disconnect the power plug from the wall outlet. (⇒ page 18, 21)

CLEANING THE PROJECTOR

Cabinet

Wipe off dirt and dust gently with a soft cloth.

- If it is difficult to remove the dirt, wipe the projector with a damp cloth. Dry off the projector with dry cloth.
- Do not use petroleum benzine, thinner, any alcoholic solvent, kitchen detergents or chemical cloths. Failure to observe these may result in altered or damaged surfaces of the projector.

Projector lens

Make sure no dirt or dust remains on the surface of the projector lens glass. It will be enlarged and projected onto the screen.

Wipe off dirt and dust gently with a lint-free cloth. Do not wipe the projector lens with a cloth which has collected dust.

NOTE:

- Clean the projector lens with special care.

Air filter

If the air filter is excessively dirty, the internal temperature of the projector increases, the **TEMP** indicator lights, and the power is turned off.

If the power is turned off, the **TEMP** indicator flashes.

Clean the air filter regularly every 100 hours of usage.

1 Remove the air filter.

While pressing the tab of the air filter, pull the air filter open slowly.

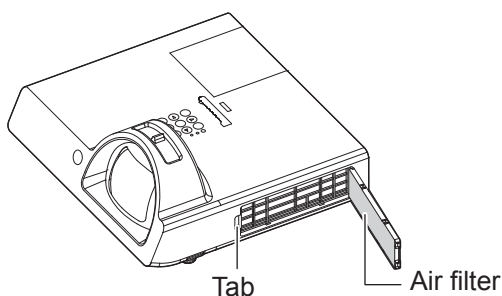

2 Clean the air filter.

Vacuum dirt and dust from the air filter.

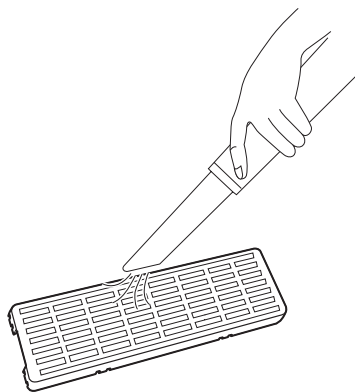

3 Install the air filter.

Install in the reverse order to 1).

NOTE:

- Do not use the projector without attaching the air filter. Otherwise, it will suck in dirt and dust which can cause malfunction.
- The TEMP indicator may flash because of clogging within 100 hours, depending on the using environment. In that case, clean the air filter at shorter intervals.

Care and Replacement (continued)

REPLACE THE LAMP UNIT

Air filter

The air filter should be replaced when cleaning is ineffective and when replacing the lamp unit. A replacement air filter is provided with a replacement lamp unit (ET-LAB2). Contact an Authorized Service Center for the air filter (TXFKN01VKN5).

Lamp unit

The lamp unit, ET-LAB2 is consumable and you must replace it regularly. It is recommended that a qualified technician carry the lamp unit replacement. Consult with an Authorized Service Center.

Note on lamp unit replacement

- Handle the lamp unit with special care as the lamp is made of glass. Dropping or giving it a shock may cause it to burst or damaged.
- If you wish to discard the used lamp, please contact your local authorities or dealer and ask for the correct method of disposal.
- Prepare a Phillips-head screwdriver.
- When replacing the lamp unit, be sure to hold it by the handle.
- Hold the lamp unit horizontally to prevent broken pieces from scattering. When the projector is mounted in the ceiling, do not work directly under the projector or put your face close to the projector. Pull out the lamp vertically.

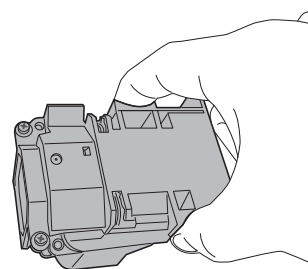



NOTE:

- Prior to replacing the lamp unit, allow it to cool down to prevent the risk of burns, damage and other hazards.
- Do not attempt replacement of an unauthorized lamp unit.
- The model Nos. of the accessories and the parts sold separately are subject to change without notice.

Lamp unit replacement time

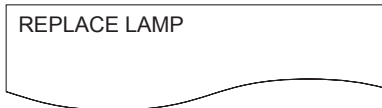
When the lamp has expired, the brightness may decrease over time. 4 000 hours of use is a rough guide of the replacing time and that might be shortened due to usage conditions, specifications of the lamp unit or environmental conditions. You can check the duration of usage time by checking **LAMP RUNTIME** in the **PROJECTOR SETUP** menu. Do not use a lamp unit over 5 000 hours. Failure to observe this may result in explosion of the lamp.

	ON-SCREEN DISPLAY	LAMP indicator
		
3 800 hours	Display " REPLACE LAMP " at the upper left of the screen for 30 seconds. If any button is pressed within 30 seconds, the message disappears.	Illuminates red, even in the standby mode.
5 000 hours	Display " REPLACE LAMP " at the upper left of the screen, and it will stay until you respond. The power is turned off automatically in 10 minutes.	

NOTE:

- The guide time, 4 000 hours, is a rough estimate based on certain conditions and is not a guaranteed time.

Care and Replacement (continued)

Lamp replacement procedure

- When the projector is mounted in the ceiling, do not work directly under the projector or put your face close to the projector.
- Be sure to install the lamp unit and attach the lamp unit cover securely. If they are not securely installed, it may cause the protection circuit to operate and the power cannot be turned on.

1 Disconnect the power plug from the wall outlet according to “TURN THE PROJECTOR OFF” (⇒ page 21), wait for at least 1 hour and check the bottom if the lamp unit has cooled.

2 Use a Phillips-head screwdriver to loosen the 1 lamp unit cover screw on the back of the projector until the screw loosen and remove the lamp unit cover.

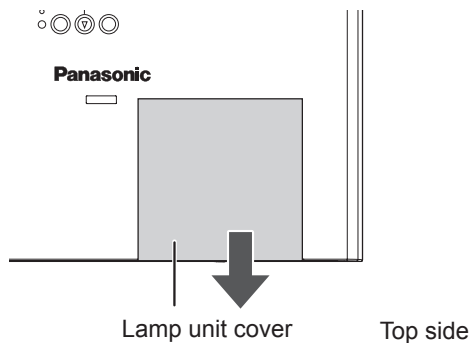
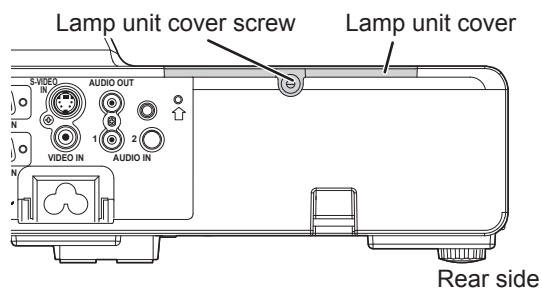

3 Use a Phillips-head screwdriver to loosen the 2 lamp unit screws. Pull the used lamp unit gently from the projector.

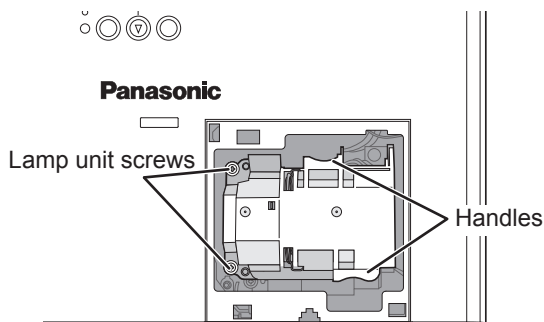

4 Press in the lamp unit until it clicks and make sure the unit is installed securely. Tighten the 2 lamp unit screws securely with a Phillips-head screwdriver.

During insertion, particularly press the (A) portion securely.

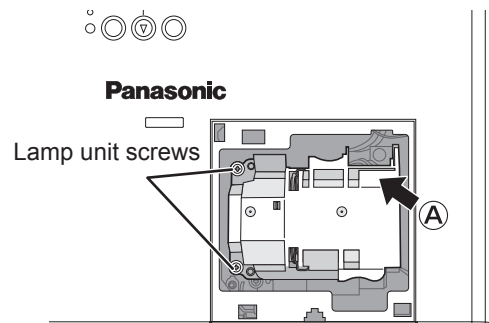

5 Attach the lamp unit cover and tighten the 1 lamp unit cover screw securely with a Phillips-head screwdriver.

6 Connect the power cord to a wall outlet.

7 Press [POWER] to begin projection.

NOTE:

- If INITIAL START UP in the PROJECTOR SETUP menu is set to ON, the projector starts projecting when the power cord is connected to a wall outlet. (⇒ page 37)

8



To display the main menu.



To scroll to the PROJECTOR SETUP menu.

Care and Replacement (continued)

9



To select the
PROJECTOR SETUP
menu.



To select **LAMP**
RUNTIME.

10



Press and hold for
approximately
3 seconds.

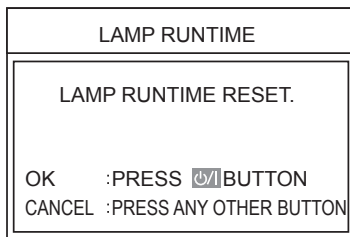

NOTE:

- If any button other than the **[POWER]** is pressed, the **LAMP RUNTIME** screen disappears and the lamp runtime is not reset. (Repeat from step 8 again).

11



After the lamp goes off,
projection stops and the
[POWER] button on the main
unit lit red. Disconnect the power
plug.
The lamp runtime has been
reset to "0".

Troubleshooting

Confirm the following problem and cause.

If the suggested solutions do not solve the problem, contact an Authorized Service Center.

Problem	Cause	Page
Power does not turn on.	● The power cord may not be connected securely.	18
	● No electric supply at the wall outlet.	—
	● The circuit breakers have tripped.	—
	● TEMP or LAMP indicator is lit or flashes.	43
	● The lamp unit cover has not been securely installed.	46
	● CONTROL PANEL in the PROJECTOR SETUP menu is invalidated.	42
No picture appears.	● The lens cover is not removed.	—
	● The input terminal may not be connected properly.	16, 17
	● The input selection setting may not be correct.	22
	● The BRIGHTNESS adjustment setting may be at the minimum setting.	28
	● The signal input source may not be operating properly.	—
● The AV MUTE function may be in use.	23	
The picture is fuzzy.	● The lens focus may not have been set correctly.	22
	● The projector may not be at the correct distance from the screen.	14
	● The lens may be dirty.	44
	● The projector may be tilted too much.	22
Color is pale or grayish.	● COLOR or TINT adjustment may be incorrect.	29
	● The input source which is connected to the projector may not be adjusted correctly.	—
No sound can be heard from the internal speaker.	● The audio signal source may not be connected properly.	16, 17
	● The volume adjustment may be at the lowest possible setting.	24, 38
	● A cable may be connected to the AUDIO OUT terminal.	12
The remote control does not operate.	● The batteries may be weak.	—
	● The batteries may not have been inserted correctly.	13
	● The remote control signal receptor on the projector may be obstructed.	13
	● The remote control unit may be out of the operation range.	13
	● REMOTE CONTROLLER in the PROJECTOR SETUP menu is invalidated.	42
● The remote control is under a strong light such as fluorescent.	13	
The control buttons of the projector do not operate.	● CONTROL PANEL in the PROJECTOR SETUP menu is invalidated. (If you have a loss of the remote control while the CONTROL PANEL is invalidated, press and hold [MENU] for 2 seconds by pressing [ENTER] .)	42
The picture does not display correctly.	● The signal format (TV-SYSTEM, RGB/YPbPr) may not have been set correctly.	29, 30
	● There may be a problem with the VCR or other signal source.	—
	● A signal which is not compatible with the projector is being input.	50
Picture from a computer does not appear.	● The RGB signal cable is too long. (Limit to 10 m (32' 10").)	—
	● The external video output from a laptop computer may not be correct. (You may be able to change the external output settings by pressing the [Fn] + [F3] or [Fn] + [F10] keys simultaneously. The actual method varies depending on the type of computer; refer to the documentation provided with your computer for further details.)	34
The projector cannot be controlled through serial terminal.	● EMULATE in the PROJECTOR SETUP menu is not set correctly. (If you fail to select your product series, ask your dealer for repair.)	38

Dimensions

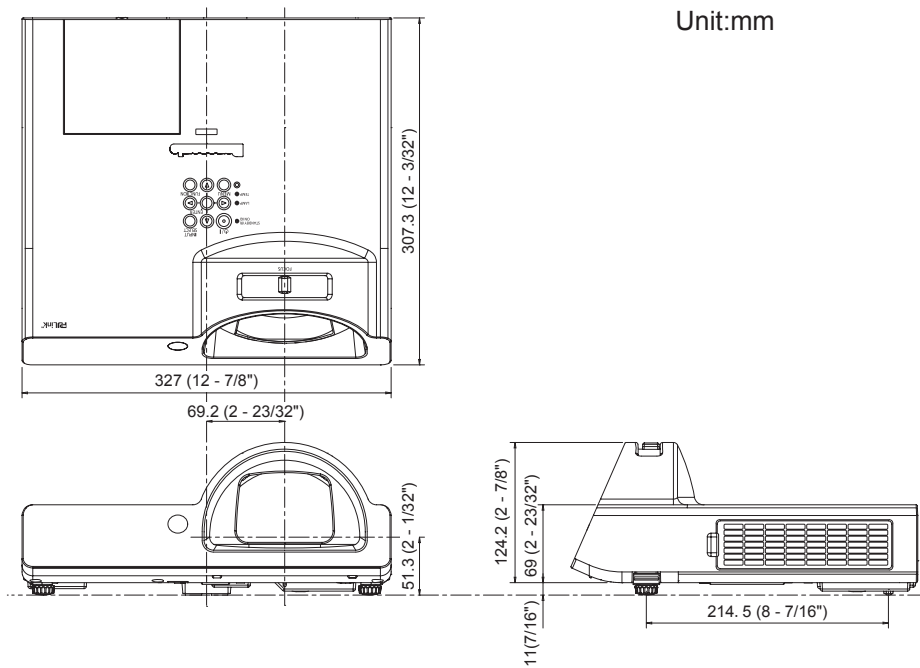

Trademark acknowledgements

- VGA and XGA are trademarks of International Business Machines Corporation.
- S-VGA is a registered trademark of the Video Electronics Standards Association.
- HDMI, the HDMI logo and High-Definition Multimedia Interface are trademarks or registered trademarks of HDMI Licensing LLC.
- The font used in the on-screen displays is a Ricoh bitmap font, which is manufactured and sold by Ricoh Company, Ltd.

All other trademarks are the property of the various trademark owners.

Technical information

LIST OF COMPATIBLE SIGNALS

This projector can project the following image signals.

Mode	Display resolution (dots)*1	Scanning frequency		Dot clock frequency (MHz)	Picture quality*2	PnP availability*3	Terminals
		H (kHz)	V (Hz)				
NTSC/NTSC4.43/ PAL-M/PAL60	720 × 480i	15.7	59.9	—	A		VIDEO/S-VIDEO
PAL/PAL-N/SECAM	720 × 576i	15.6	50	—	A		
525i (480i)	720 × 480i	15.7	59.9	13.5	A		RGB/YPbPr
625i (576i)	720 × 576i	15.6	50	13.5	A		
525p (480p)	720 × 483	31.5	59.9	27	A		
625p (576p)	720 × 576	31.3	50	27	A		
1 125 (1 080)/60i	1 920 × 1 080i	33.8	60	74.3	A		
1 125 (1 080)/50i	1 920 × 1 080i	28.1	50	74.3	A		
1 125 (1 080)/60p	1 920 × 1 080p	67.5	60.0	148.5	A	O	
1 125 (1 080)/50p	1 920 × 1 080p	56.3	50.0	148.5	A	O	
750 (720)/60p	1 280 × 720	45	60	74.3	A		
750 (720)/50p	1 280 × 720	37.5	50	74.3	A		
VESA	640 × 400	31.5	70.1	25.2	A		
	640 × 400	37.9	85.1	31.5	A		
VGA	640 × 480	31.5	59.9	25.2	A	O	
	640 × 480	35	66.7	30.2	A	O	
	640 × 480	37.9	72.8	31.5	A	O	
	640 × 480	37.5	75	31.5	A	O	
	640 × 480	43.3	85	36	A		
SVGA	800 × 600	35.2	56.3	36	A	O	
	800 × 600	37.9	60.3	40	A	O	
	800 × 600	48.1	72.2	50	A	O	
	800 × 600	46.9	75	49.5	A	O	
	800 × 600	53.7	85.1	56.3	A		
MAC	832 × 624	49.7	74.6	57.3	A	O	
XGA	1 024 × 768	39.6	50.1	51.9	AA		
	1 024 × 768	48.4	60	65	AA	O	
	1 024 × 768	56.5	70.1	75	AA	O	
	1 024 × 768	60	75	78.8	AA	O	
	1 024 × 768	68.7	85	94.5	AA		
MXGA	1 152 × 864	64	71.2	94.2	A	O	
	1 152 × 864	67.5	74.9	108	A		
	1 152 × 864	77.1	85	119.7	A		
MAC	1 152 × 870	68.7	75.1	100	A	O	
MSXGA	1 280 × 960	60	60	108	A	O	
SXGA	1 280 × 1 024	64	60	108	A		
	1 280 × 1 024	80	75	135	A	O	
	1 280 × 1 024	91.1	85	157.5	A		
SXGA60+	1 400 × 1 050	64	60	108	A		
	1 400 × 1 050	65.1	59.9	122.4	A	O	
UXGA	1 600 × 1 200	75	60	162	A	O	
WIDE750 (720)	1 280 × 720	44.8	59.9	74.5	A	O	
	1 280 × 720	37.1	49.8	60.5	A		
WXGA768	1 280 × 768	39.6	49.9	65.3	A		
	1 280 × 768	47.8	59.9	79.5	A	O	
WXGA800	1 280 × 800	41.3	50	68	A		
	1 280 × 800	49.1	60.2	69.1	A	O	
	1 280 × 800	49.7	59.8	83.5	A		
WXGA+	1 440 × 900	55.9	59.9	106.5	A	O	
WSXGA+	1 680 × 1 050	65.3	60	146.3	A	O	
WUXGA	1 920 × 1 200	74.6	59.9	193.3	B		

*1 The "i" appearing after the resolution indicates an interlaced signal.

*2 The following symbols are used to indicate picture quality.

AA : Maximum picture quality can be obtained.

A : Signals are converted by the image processing circuit before picture is projected.

B : Some loss of data occurs to make projection easier.

*3 The signals marked with circles (O) can be applied by plug-and-play device.

Technical Information (continued)

SERIAL TERMINAL

The serial connector which is on the connector panel of the projector conforms to the RS-232C interface specifications. The projector can be controlled by a personal computer which is connected to this connector.

Connection

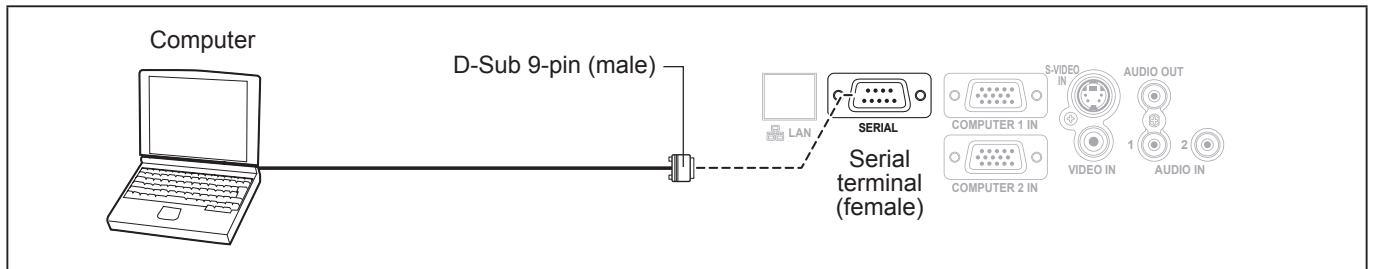

Pin assignments and signal names

	Pin No.	Signal name	Contents
	①		NC
	②	TXD	Transmitted data
	③	RXD	Received data
	④		NC
	⑤	GND	Earth
	⑥		NC
	⑦	RTS	Connected internally
	⑧	CTS	
	⑨		NC

Communication settings

Signal level	RS-232C
Sync.method	Asynchronous
Baud rate	9 600 bps
Parity	None

Character length	8 bits
Stop bit	1 bit
X parameter	None
S parameter	None

Basic format

<table border="1" style="width: 100%; text-align: center;"> <tr> <td>STX</td> <td>Command</td> <td>:</td> <td>Parameter</td> <td>ETX</td> </tr> <tr> <td>Start byte (02 h)</td> <td>3 bytes</td> <td>1 byte</td> <td>1 bytes - 4 bytes</td> <td>End (03 h)</td> </tr> </table>	STX	Command	:	Parameter	ETX	Start byte (02 h)	3 bytes	1 byte	1 bytes - 4 bytes	End (03 h)	<p>The data streaming from the computer will start with STX, and proceed to Command, Parameter and end with ETX. You can add the required parameter.</p>
STX	Command	:	Parameter	ETX							
Start byte (02 h)	3 bytes	1 byte	1 bytes - 4 bytes	End (03 h)							

NOTE:

- The projector cannot receive any command for 10 seconds after the lamp is switched on. Wait for 10 seconds before sending the command.
- For multiple commands, check the projector if the response has been sent for one command before sending the next command.
- When a command which does not require parameters to be sent, the colon (:) is not required.
- If an incorrect command is sent from the personal computer, an ER401 command will be sent from the projector to the personal computer.

Technical Information (continued)

Cable specifications

(When connected to a personal computer)

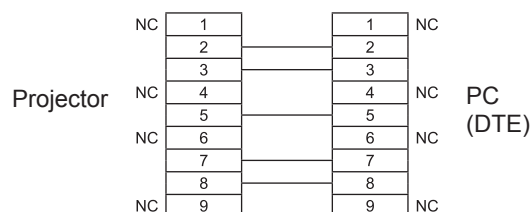

Control commands

The following commands are used for control of the projector with a computer. (Operation commands)

Command	Control contents	Remarks
PON	Power on	<ul style="list-style-type: none"> The PON command is ignored during lamp ON control. If a PON command is received while the cooling fan is operating after the lamp has switched off, the lamp is not turned back on again straight away in order to protect the lamp.
POF	Power off	
AVL	Volume	Parameter: 000 - 063 (Adjustment value 0 - 63)
IIS	Input	Parameter: VID = VIDEO SVD = S-VIDEO RG1 = COMPUTER 1 IN RG2 = COMPUTER 2 IN
Q\$\$	Lamp condition query	Call back: 0 = Standby 1 = Lamp on control active 2 = Lamp on 3 = Lamp off control active
OSH	AV mute	Turn off the projection and sound temporarily. Send the command to switch between off and on. (⇒ page 23) Do not send the command consecutively. 0 = Off 1 = On

NOTE:

- If **STANDBY MODE** is set to **ECO**, only **PON** and **Q\$\$** command can be used in the standby mode.

MENU LOCK PASSWORD

To reset the password to the default setting **AAAA**, perform the following when the **MENU LOCK PASSWORD** request screen is displayed.

- 1) Press and hold the **<AUTO SETUP>** button of the remote control or the **<INPUT SELECT>** button of the control panel and the **▲** button of the control panel together for at least 2 seconds.
- 2) Press and hold **▼** button for at least 2 seconds.
PASSWORD HAS BEEN INITIALIZED. is displayed on the **MENU LOCK PASSWORD** request screen.

Specifications

Power supply		AC 100 - 240 V 50 Hz/60 Hz
Power consumption		300 W During standby (when fan is stopped): 0.4 W (STANDBY MODE: ECO) 15 W *1 (STANDBY MODE: NORMAL)
Current		3.5 A - 1.2 A
LCD panel	Panel size (diagonal)	0.63 type (16.00 mm)
	Aspect ratio	4:3
	Display method	3 transparent LCD panels (RGB)
	Drive method	Active matrix method
	Pixels	786 432 (1 024 × 768) × 3 panels
Lens		Fixed focus/Manual focus F 1.80, f 6.74 mm
Lamp		UHM lamp (220 W)
Luminosity *2		2 800 lm
Scanning frequency *3 (for RGB signal)	Horizontal scanning frequency	15 kHz - 91 kHz
	Vertical scanning frequency	50 Hz - 85 Hz
	Dot clock frequency	Less than 170 MHz
COMPONENT (YP_BPR) signals		525i (480i), 525p (480p), 625i (576i), 625p (576p), 750 (720)/60p, 750 (720)/50p, 1 125 (1 080)/60i, 1 125 (1 080)/50i, 1 125(1 080)/60p, 1 125(1 080)/50p
Color system		7 (NTSC/NTSC4.43/PAL/PAL-M/PAL-N/PAL60/SECAM)
Projection size		60" - 110" (1 524 mm - 2 794 mm)
Optical axis		10:-0.5 fixed
Throw distance		0.60 m - 1.14 m (2' 0" - 3' 9")
Screen aspect ratio		4:3
Installation		FRONT/DESK, FRONT/CEILING, REAR/DESK, REAR/CEILING (Menu selection method)
Speaker		1 piece 4 cm × 2 cm (1 5/8" × 3/4")
Max. useable volume output		1.0 W (Monaural)
Terminals	S-VIDEO IN	Single - line, Mini DIN 4p Y: 1.0 V [p-p], C: 0.286 V [p-p], 75 Ω
	VIDEO IN	Single - line, RCA pin jack 1.0 V [p-p], 75 Ω
	COMPUTER IN	Dual - line, D-Sub HD 15-pin (female) ● RGB input R.G.B.: 0.7 V [p-p], 75 Ω G-SYNC: 1.0 V [p-p], 75 Ω HD, VD/SYNC: TTL high impedance, automatic positive/negative polarity compatible
		● YP _B PR/YC _B CR input Y: 1.0 V [p-p] (include sync), 75 Ω P _B /C _B , P _R /C _R : 0.7 V [p-p], 75 Ω
	AUDIO IN	Dual - line, 0.5 V [rms], M3 jack (Stereo MINI)
	AUDIO OUT	Single - line, M3 jack (Stereo MINI) Monitor output/stereo compatible 0 V [rms] - 2.0 V [rms] (variable)
	SERIAL	Single - line, D-Sub 9-pin RS-232C compatible
	LAN (RJ-45)	Single - line, 10Base-T/100Base-TX

*1 When "IN STANDBY MODE" in AUDIO SETTING menu is ON: 18 W.

*2 Measurement, measuring conditions and method of notation all comply with ISO21118 international standards.

*3 See "LIST OF COMPATIBLE SIGNALS" on page 50 for available signals.

Specifications (continued)

Cabinet	Moulded plastic (PC+ABS)	
Dimensions	<ul style="list-style-type: none"> ● Width: 327 mm (12 7/8") ● Height: 124 mm (4 7/8") ● Length: 307 mm (12 3/32") (not including surface projection parts) 	
Weight	Approx. 3.1 kg (6.8 lbs.) *4 (Excluding lens cap)	
Operating environment	<ul style="list-style-type: none"> ● Temperature: 0 °C - 40 °C (32 °F - 104 °F) When the HIGH ALTITUDE MODE (⇒ page 37) is set to ON: 0 °C - 35 °C (32 °F - 95 °F) ● Humidity: 20 % - 80 % (no condensation) 	
Certifications	UL60950-1 FCC Class B	C-UL ICES-003
Remote control	Power supply	3 V DC (AAA/R03 battery × 2)
	Operating range	Approx. 7 m (23' 0") (when operated directly in front of signal receptor)
	Weight	Approx. 64 g (2.3 ozs.) (including batteries)
	Dimensions	<ul style="list-style-type: none"> ● Width: 45.6 mm (1 25/32") ● Length: 115 mm (4 17/32") ● Height: 21.4 mm (27/32") (not including surface projection parts)
Options *5	Ceiling bracket	ET-PKB2
	Air Filter Unit	ET-KFB2

*4 Average value. Each product has an individual variability in weight.

*5 The model Nos. of the accessories and parts sold separately are subject to change without notice.

Ceiling mount bracket safeguards

When installing the ceiling mount bracket to the projector, install the accessory Drop-prevention bracket (Safety cables) to the projector.

(The projector will still be safe if they are not used, however they will help prevent the possibility of accidents caused by the projector falling down if the screws happen to become loose.)

Model No. of ceiling mount bracket: ET-PKB2

Installation work of the ceiling mount bracket should only be carried by a qualified technician according to the following procedure.

- Panasonic takes no responsibility for any losses or damage occurring as a result of using a ceiling mount bracket not manufactured by Panasonic, or if damage to the projector occurs as a result of an inappropriate location used for installing the ceiling mount bracket, even if the projector's warranty period has not yet expired.
- Use a torque screwdriver or similar tool to tighten the screws. Do not use tools such as electric screwdrivers or impact screwdrivers.
- An unused ceiling mount bracket should be removed promptly by qualified technician.
- Do not use the screw holes of the front leg adjusters for the projector installation.
- Do not attach the safety cable to the burglar hook port and suspend the projector on it.
- For how to install wire ropes to the ceiling, see the installation manual for the ceiling mount bracket.
- The part numbers of accessories and separately sold components are subject to change without notice.

INSTALLING THE SAFETY CABLE

1 Install the ceiling mount bracket according to the installation instructions.

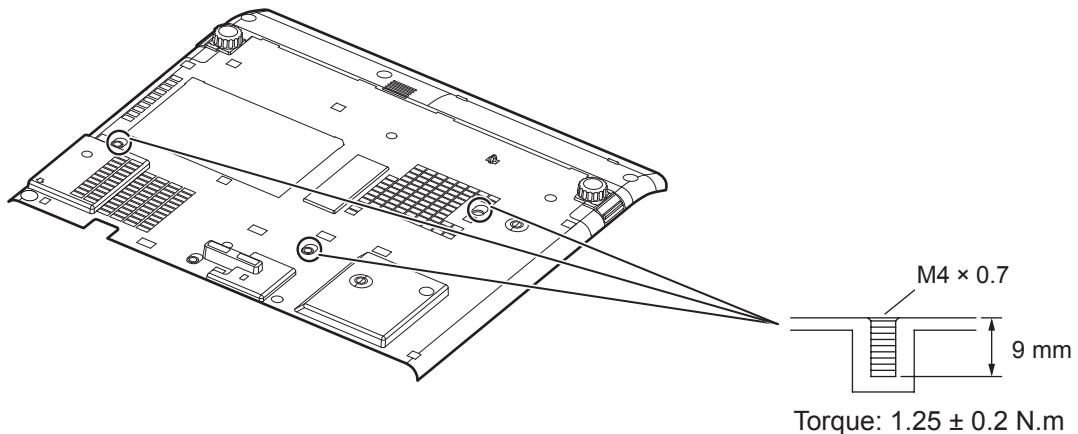

2 Loop the security cable around the ceiling mount bracket with less slack.

Lace the cable of the end with a latch through the loop on the other end of the cable.

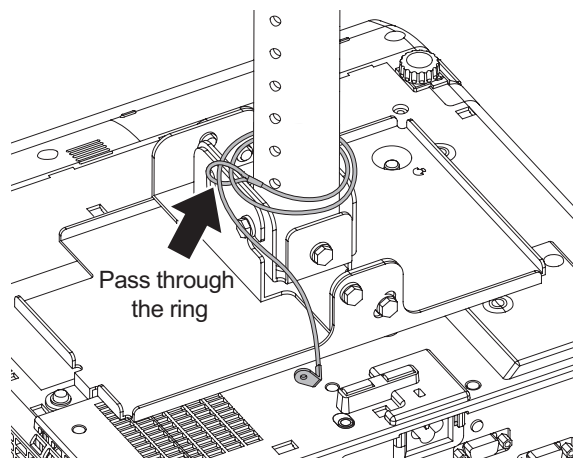

Ceiling mount bracket safeguards (continued)

- 3 Attach the latch on to the projector with a provided screw.**
Torque: 1.25 ± 0.2 N.m

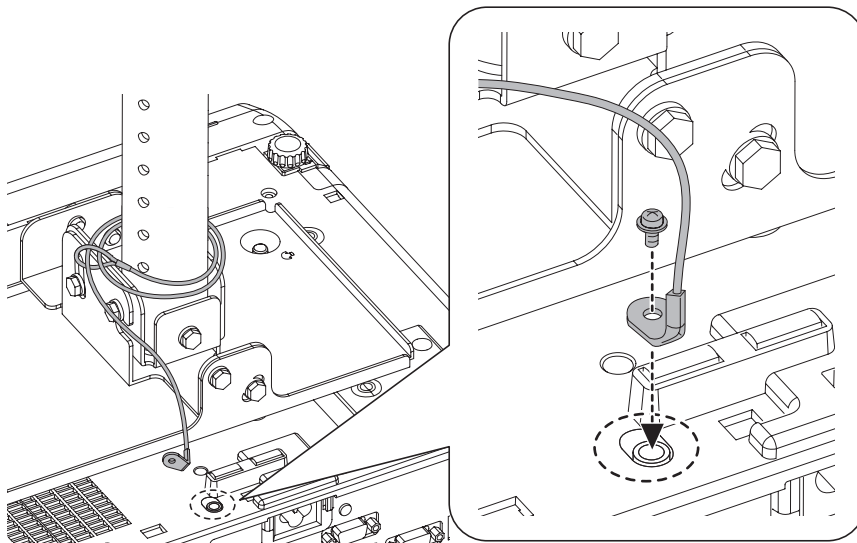

Index

A		K		S	
ASPECT	31	KEystone	30	SCREEN SIZE AND THROW	
AUDIO SETTING	38			DISTANCE	14
AUTO SETUP	35	L		SECURITY	8
AV MUTE	23	LAMP INDICATOR	43	SECURITY MENU	40
B		LAMP POWER	37	SELECT THE INPUT SIGNAL	22
BACK COLOR	35	LAMP RUNTIME	38	SERIAL TERMINAL	51
BRIGHTNESS	28	LANGUAGE MENU	33	SHARPNESS	29
C		LANGUAGE	10	SHIFT	30
CAUTIONS ON USE	8	LIST OF COMPATIBLE SIGNALS	50	SIGNAL SEARCH	35
CAUTIONS WHEN INSTALLING	7	M		Specifications	53
CAUTIONS WHEN TRANSPORTING	7	MAIN MENU	27	STANDBY MODE	37
CLEANING AND MAINTENANCE	9	MENU LOCK	41	STARTUP LOGO	34
CLEANING THE PROJECTOR	44	MENU LOCK PASSWORD	41, 52	STATUS	36
CLOCK PHASE	31	N		SUB MENU	27
CLOSE CAPTION SETTING	34	NETWORK MENU	42	SUPPLIED ACCESSORIES	9
COLOR	29	NOISE REDUCTION	29	SXGA MODE	36
COLOR TEMPERATURE	29	NO SIGNAL SHUT-OFF	37	T	
COMPUTER	23	O		TABLE OF CONTENTS	4
Connections	16	ON-SCREEN DISPLAY	33	TEMP INDICATOR	43
CONTRAST	28	ON-SCREEN MENU	26	TEST PATTERN	39
CONTROL DEVICE SETUP	42	OPERATE THE MENU	26	TEXT CHANGE	40
D		OTHER FUNCTIONS	36	TEXT DISPLAY	40
DAYLIGHT VIEW	29	OVER SCAN	31	TINT	29
DEFAULT	24	P		Troubleshooting	48
Dimensions	49	PASSWORD	40	TURN THE PROJECTOR OFF	21
DISPLAY OPTION MENU	33	PASSWORD CHANGE	40	TURN THE PROJECTOR ON	20
DISPOSAL	9	PICTURE MENU	28	TV-SYSTEM	29
DOT CLOCK	30	PICTURE MODE	28	V	
E		POSITION MENU	30	VOLUME	24
EMULATE	38	POSITION THE IMAGE	22	W	
ENLARGE THE IMAGE	25	POWER CORD	18	WHITE BALANCE	29
F		POWER indicator status	19	WIDE MODE	36
FRAME LOCK	32	PROJECTION METHOD	15		
FREEZE	23	PROJECTOR SETUP MENU	36		
FUNCTION BUTTON	25, 38	PROJECTOR'S MAIN UNIT	11		
H		PROJECTOR'S REMOTE			
HIGH ALTITUDE MODE	37	CONTROL	13		
I		R			
Important Safety Notice	2	REALTIME KEystone	30		
INDEX-WINDOW	24	Remote control operation	23		
INITIALIZE ALL	39	REPLACE THE LAMP UNIT	45		
INITIAL SETTING	10	RGB/YP _B Pr	30		
INITIAL START UP	37				
INSTALLATION	37				

Avis important concernant la sécurité

Cher client Panasonic :

Les informations qui suivent doivent être lues et comprises, car elles fournissent des détails qui vous permettront d'opérer le projecteur de façon sécurisée, à la fois pour vous et votre environnement, tout en étant conforme aux exigences locales concernant l'utilisation de projecteurs. Conserver ce manuel pour référence future avec votre projecteur Panasonic. Le numéro de série se trouve au bas de l'appareil. Le noter dans l'espace prévu ci-dessous et conserver ce manuel pour le cas où des réparations s'avèreraient nécessaires à l'avenir.

Numéro de modèle : PT-ST10U

Numéro de série :

AVERTISSEMENT : POUR REDUIRE LES RISQUES D'INCENDIE OU D'ELECTROCUTION, NE PAS EXPOSER CE PRODUIT A LA PLUIE OU A L'HUMIDITE.

Alimentation électrique : ce projecteur LCD est conçu pour fonctionner sur un courant domestique ca de 100 V à 240 V, 50 Hz/60 Hz uniquement.

MISE EN GARDE : la fiche électrique CA qui est fournie avec le projecteur en tant qu'accessoire ne peut être utilisée que pour des alimentations électriques atteignant 125 V, 7 A. Si vous devez utiliser des tensions ou des courants plus élevés, vous devrez vous procurer une fiche d'alimentation 250 V séparée. Si vous utilisez la fiche d'accessoire dans de telles situations, cela peut entraîner un incendie.



Le symbole éclair avec une tête en forme de flèche à l'intérieur d'un triangle équilatéral, est destiné à alerter l'utilisateur de la présence de tensions dangereuses non isolées à l'intérieur du produit. Ces tensions peuvent être d'une puissance suffisante pour constituer un risque d'électrocution pour les individus.



Le point d'exclamation dans un triangle équilatéral a pour but d'alerter l'utilisateur de la présence d'importantes instructions de fonctionnement et de maintenance (entretien) dans les documents accompagnant l'appareil.

MISE EN GARDE : cet appareil est équipé d'une fiche d'alimentation de type mise à la terre à trois broches. Ne pas enlever la broche de mise à la terre sur la prise d'alimentation. Cette fiche ne s'adapte que sur une prise de secteur de type mise à la terre. Il s'agit d'une caractéristique de sécurité. S'il n'est pas possible d'insérer la fiche dans la prise, contacter un électricien. Ne pas invalider le but de la mise à la terre.

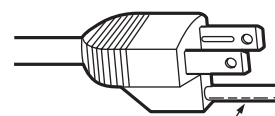

Ne pas enlever

Conformément à la directive 2004/108/EC, article 9(2)

Conformément à la directive 2005/32/EC, amendée par la directive 2008/28/EC, article 14

Centre d'essai Panasonic

**Panasonic Service Europe, une division de Panasonic Marketing Europe GmbH
Winsbergring 15, 22525 Hambourg, F.R. Allemagne**

AVIS :

Ce projecteur est équipé d'une lampe au mercure sous haute pression. La mise au rebut peut être réglementée dans votre communauté pour des considérations environnementales. Pour toute information sur la mise au rebut ou le recyclage, veuillez contacter vos autorités locales ou l'alliance des industries de l'électronique: <http://www.eiae.org>

Avis important concernant la sécurité (suite)

AVERTISSEMENT :

Cet équipement a été testé et déclaré conforme aux limites d'un dispositif numérique de la classe B, conformément à la partie 15 des règles de la FCC. Ces limites sont conçues pour fournir une protection raisonnable contre les interférences nocives dans une installation résidentielle. Cet équipement produit, utilise et peut émettre une énergie à fréquence radio et s'il n'est pas installé et utilisé conformément aux instructions, peut provoquer des interférences nocives aux communications radio. Cependant, il n'y a aucune garantie que des interférences ne se produiront pas dans une installation particulière. Si cet appareil provoque des interférences néfastes pour la réception de la radio ou de la télévision, ce qui peut être déterminé en éteignant puis en rallumant l'appareil, l'utilisateur est encouragé à tenter de corriger les interférences par une ou plusieurs des mesures suivantes :

- Réorienter ou déplacer l'antenne de réception.
- Augmenter la distance entre l'appareil et le récepteur.
- Connecter l'appareil sur une prise d'un circuit différent de celui sur lequel le récepteur est branché.
- Consulter le revendeur ou un technicien radio/télévision expérimenté pour l'aide.

MISE EN GARDE DE FCC : Afin d'assurer une conformité totale, veuillez respecter les instructions d'installation de l'appareil, qui recommandent l'utilisation de câbles d'interface à blindage pour toutes les connexions à votre ordinateur et/ou périphériques. Tous changements ou modifications non approuvés expressément par Panasonic Corp. en Amérique du Nord peuvent annuler l'autorité de l'utilisateur à opérer cet appareil.

AVERTISSEMENT :

- Ne pas utiliser dans une salle informatique telle que définie dans la norme pour la protection des appareils électroniques de traitement informatique / de données, ANSI/NFPA 75.
- Pour un appareil connecté en permanence, un système de déconnexion opérationnel et accessible devra être incorporé au le câblage du bâtiment.
- Pour des appareils enfichables, la prise de courant devra être installée à proximité des appareils et doit être facile d'accès.

Déclaration de conformité

Numéro de modèle : PT-ST10U
 Nom du produit : **Panasonic**
 Partie responsable : Panasonic Solutions Company
 Adresse : 3 Panasonic Way, Secaucus, NJ 07094
 Numéro de téléphone: (877) 803 - 8492
 Courriel: projectorsupport@us.panasonic.com

Cet appareil est conforme à l'article 15 des Règlements FCC. Son fonctionnement est sujet aux deux conditions suivantes: (1) Cet appareil ne peut pas provoquer d'interférence et (2) cet appareil doit accepter toute interférence reçue, y compris l'interférence que pourrait causer une opération non souhaitée.

Information relative à l'élimination des déchets dans les pays extérieurs à l'Union européenne



Ces symboles ne sont valables qu'à l'intérieur de l'Union européenne. Pour mettre ce produit au rebut, veuillez contacter les autorités locales ou votre revendeur et demandez la méthode de mise au rebut appropriée.



Informations relatives à la protection de l'environnement pour les utilisateurs en Chine



Ce symbole n'est valide qu'en Chine.

Précautions concernant la sécurité

AVERTISSEMENT

ALIMENTATION

La prise de courant ou le disjoncteur doivent être installés à proximité de l'appareil et doivent être d'accès facile en cas de problèmes. Si les problèmes suivants surviennent, couper immédiatement l'alimentation électrique.

Si l'on continue d'utiliser le projecteur dans ces conditions, cela peut entraîner un incendie ou des chocs électriques.

- Si des corps étrangers ou de l'eau pénètrent dans le projecteur, couper immédiatement l'alimentation électrique.
- Si le projecteur tombe ou si le cabinet est cassé, couper l'alimentation électrique.
- Si l'on remarque une émission de fumée, d'odeurs suspectes ou de bruits provenant du projecteur, couper l'alimentation électrique.

Veuillez contacter un centre technique agréé pour des réparations et ne pas tenter de réparer le projecteur soi-même.

Pendant un orage, ne pas toucher le projecteur ou le câble.

Il y a risque d'électrocution.

Ne rien faire qui puisse endommager le cordon d'alimentation ou la prise d'alimentation.

Si le cordon d'alimentation est utilisé quand il est endommagé, cela peut entraîner des chocs électriques, des court-circuits ou un incendie.

- Ne pas endommager le cordon d'alimentation, ne pas le modifier, ne pas le placer à proximité d'objets chauds, ne pas le tordre, ne pas tirer dessus, ne pas le placer sous des objets lourds ou le rouler en boule. Demandez à un centre technique agréé d'effectuer des réparations éventuellement nécessaires sur le cordon d'alimentation.

Insérez la prise d'alimentation fermement dans la prise de courant.

Si la prise n'est pas correctement insérée, cela peut entraîner des chocs électriques ou la faire surchauffer.

- Ne pas utiliser un câble électrique autre que celui fourni.
- Ne pas utiliser le cordon électrique pour d'autres appareils électriques.
- Ne pas utiliser de prises qui sont endommagées ou des prises murales desserrées.

Nettoyer la prise d'alimentation régulièrement afin d'éviter toute accumulation de poussière.

Le fait de ne pas respecter ces consignes peut entraîner un incendie.

- Si de la poussière s'accumule sur la fiche du cordon d'alimentation, l'humidité peut endommager l'isolant.
- Si le projecteur n'est pas utilisé pendant une période prolongée, débrancher la prise d'alimentation de la prise murale.

Débrancher la fiche du cordon d'alimentation de la prise de courant et l'essuyer régulièrement avec un tissu sec.

Ne pas manipuler la prise d'alimentation avec les mains mouillées.

Le fait de ne pas respecter ces consignes peut entraîner des chocs électriques.

Ne pas surcharger la prise murale.

Si l'alimentation est surchargée (par exemple, par l'utilisation de trop d'adaptateurs), cela risque de faire surchauffer le projecteur et peut entraîner un incendie.

LORS DE L'UTILISATION/INSTALLATION

Ne pas placer de récipients de liquide sur le projecteur.

Si de l'eau se renverse sur le projecteur ou pénètre dans celui-ci, il y aura risque d'incendie ou d'électrocution.

Si de l'eau pénètre à l'intérieur du projecteur, contactez avec un centre technique agréé.

Ne pas placer le projecteur sur des matériaux comme du tapis ou du tissu éponge.

Cela peut provoquer une surchauffe du projecteur, pouvant entraîner des brûlures, un incendie ou endommager le projecteur.

Ne pas installer le projecteur dans des endroits humides ou poussiéreux ou dans des endroits où le projecteur peut entrer en contact avec des fumées grasses ou de la vapeur, par exemple, une salle de bain.

L'utilisation du projecteur dans de telles conditions entraînera un incendie, des chocs électriques ou une détérioration des composants. La détérioration des composants (comme les supports de montage au plafond) risque d'entraîner une chute du projecteur installé au plafond.

Ne pas installer ce projecteur dans un endroit qui n'est pas assez résistant pour supporter le poids du projecteur ou sur une surface en pente ou instable.

Cela peut faire tomber le projecteur ou le faire basculer, ce qui peut entraîner des dommages ou des blessures.

Ne pas placer un autre projecteur ou d'autres objets lourds sur le projecteur.

Cela peut déséquilibrer le projecteur et le faire tomber, ce qui peut entraîner des dommages ou des blessures. Le projecteur sera endommagé ou déformé.

Demander à un technicien qualifié d'installer le projecteur par exemple s'il doit être installé au plafond.

Si l'installation n'est pas faite correctement, cela peut entraîner des blessures ou des accidents, comme des chocs électriques.

- Ne pas utiliser un support de montage au plafond qui n'est pas agréé.

Ne pas obstruer les orifices d'entrée et de sortie d'air.

Cela risque de faire surchauffer le projecteur et d'entraîner un incendie ou d'endommager le projecteur.

- Ne pas installer le projecteur dans des endroits étroits, mal ventilés tels que des placards ou des étagères.
- Ne pas placer le projecteur sur des tissus ou du papier, ces matériaux peuvent être aspirés dans l'orifice d'entrée d'air.

Ne pas placer les mains ou d'autres objets près de l'orifice de sortie d'air.

Cela peut entraîner des brûlures ou abîmer vos mains ou d'autres objets.

- De l'air chaud sort par l'orifice de sortie d'air. Ne pas placer les mains ou le visage ou des objets qui ne supportent pas la chaleur près de l'orifice de sortie d'air.

Précautions concernant la sécurité (suite)

Ne pas exposer vos yeux et votre peau aux faisceaux lumineux émis depuis l'objectif du projecteur lors de son utilisation.

Cela peut entraîner des brûlures ou une perte de la vue.

- Une lumière intense est émise par l'objectif du projecteur. Ne pas exposer vos yeux ou vos mains directement à cette lumière.
- Veiller particulièrement à ce que les enfants ne regardent pas dans l'objectif. En outre, éteindre le projecteur et le débrancher si vous vous en éloignez.

Ne pas insérer d'objets étrangers dans le projecteur.

Cela peut entraîner un incendie ou des chocs électriques.

- Ne pas insérer d'objets métalliques ou inflammables dans le projecteur ou les faire tomber dessus.

Ne jamais entreprendre de modification quelconque ou le démontage du projecteur.

Des hautes tensions peuvent entraîner un incendie ou des chocs électriques.

Pour toute inspection, réglage ou réparation, s'adresser à un centre technique agréé.

Ne pas projeter une image avec l'objectif fourni installé.

Cela peut entraîner un incendie ou des chocs électriques.

ACCESSOIRES

Ne pas utiliser ou manipuler les piles de manière inappropriée, se référer à ce qui suit.

Sinon, cela peut entraîner des brûlures, les piles risquent de fuir, de surchauffer, d'exploser ou de prendre feu.

- Utiliser uniquement les piles spécifiées.
- Utilisez des piles au manganèse, mais pas de piles rechargeables. Ne pas démonter des piles à anode sèche.
- Ne pas chauffer les piles ou ne pas les mettre dans de l'eau ou au feu.
- Veiller à ce que les bornes + et - des piles n'entrent pas en contact avec des objets métalliques tels que colliers ou épingles à cheveux.
- Ne pas ranger les piles avec des objets métalliques.
- Ranger les piles dans un sac en plastique, et ne pas les ranger à proximité d'objets métalliques.
- Lorsqu'on insère les piles, veiller à ce que les polarités (+ et -) soient bien respectées.
- Ne pas utiliser une pile neuve avec une ancienne, ni mélanger différents types de piles.
- Ne pas utiliser des piles dont le revêtement externe s'écaille ou a été retiré.
- Retirer les piles usées de la télécommande au plus vite.
- Isoler la pile à l'aide d'un ruban ou autre matériau similaire avant de la mettre au rebut.

Ne pas laisser les vis ou les piles AAA/R03 jointes à portée des enfants.

- La pile peut entraîner des blessures corporelles si elle est avalée.
- Si elle est avalée, consulter un médecin immédiatement.

Si le fluide de la pile fuit, ne pas le toucher à mains nues et prendre les mesures suivantes le cas échéant.

- Si du fluide de pile touche votre peau ou un vêtement, cela peut entraîner une inflammation cutanée ou des blessures. Rincer à l'eau claire et consulter un médecin immédiatement.
- Si du fluide de pile entre en contact avec vos yeux, cela peut entraîner une perte de la vue. Dans ce cas, ne pas se frotter les yeux. Rincer à l'eau claire et consulter un médecin immédiatement.

Ne pas démonter la lampe.

Si la lampe se casse, cela risque d'entraîner des blessures.

Remplacement de la lampe

La lampe a une pression interne élevée. Si elle est manipulée incorrectement, une explosion et de graves blessures ou des accidents peuvent s'ensuivre.

- Le remplacement de la lampe ne doit être effectué que par un technicien qualifié.
- La lampe peut facilement exploser si elle est heurtée contre des objets durs ou si on la laisse tomber.
- Avant de remplacer la lampe, veiller à débrancher la fiche du cordon d'alimentation de la prise de courant. Il y a risque d'électrocution ou d'explosion.
- Lors du remplacement de la lampe, la laisser refroidir pendant au moins une heure avant de la manipuler, sinon il y a des risques de brûlures.

Ne pas laisser des enfants ou des animaux domestiques toucher la télécommande.

- Après avoir utilisé la télécommande, la ranger hors de portée des enfants ou des animaux domestiques.

MISE EN GARDE

ALIMENTATION

Lors du débranchement du cordon d'alimentation, assurez-vous de tenir la prise et le connecteur d'alimentation.

Si vous tirez sur le cordon d'alimentation lui-même, il sera endommagé et cela peut causer un incendie, des courts-circuits ou des chocs électriques sérieux.

Si vous n'utilisez pas le projecteur pendant une longue période de temps, débrancher la fiche du cordon d'alimentation de la prise de courant et retirer les piles de la télécommande.

Débrancher la fiche du cordon d'alimentation de la prise de courant avant d'effectuer tout nettoyage. Sinon cela peut causer des chocs électriques.

Précautions concernant la sécurité (suite)

LORS DE L'UTILISATION/INSTALLATION

Ne pas peser de tout son poids sur ce projecteur.
Vous risquez de tomber ou le projecteur peut casser ce qui peut causer des blessures.

- Veiller tout particulièrement à ce que les enfants ne se tiennent pas debout ou ne s'asseyent pas sur le projecteur.

Ne pas utiliser le projecteur dans des lieux extrêmement chauds.

Cela peut entraîner la détérioration du boîtier externe ou des composants internes ou un incendie.

- Soyez particulièrement vigilant(e) dans des lieux exposés à la lumière solaire directe ou à proximité d'un four.

Débrancher toujours tous les câbles avant de déplacer le projecteur.

Le fait de déplacer le projecteur avec des câbles branchés peut endommager les câbles, ce qui pourrait causer un incendie ou des chocs électriques.

ACCESSOIRES

Ne pas utiliser l'ancienne lampe.

Cela risque d'entraîner une explosion de la lampe.

Si la lampe s'est cassée, ventiler immédiatement la pièce. Ne pas toucher ni approcher le visage des morceaux cassés.

Le non respect de cette consigne peut entraîner l'absorption du gaz par l'utilisateur. Ce gaz se dégage lorsque la lampe est cassée et il contient presque autant de mercure qu'une lampe fluorescente, de plus les morceaux cassés peuvent provoquer des blessures.

Si vous pensez avoir inhalé du gaz ou que du gaz a pénétré dans votre bouche ou dans vos yeux, contactez un médecin immédiatement.

S'adresser au revendeur pour le remplacement de la lampe et l'inspection de l'intérieur du projecteur.

PRECAUTIONS LORS DU TRANSPORT

Lors du transport du projecteur, ne pas porter le système de réglage des pieds, mais le placer dans sa sacoche.

Lors du transport, gardez le projecteur avec le capuchon de l'objectif sur lui.

- Veuillez prendre soin de les tenir à l'écart des vibrations et des impacts, le projecteur et la lentille sont fabriqués avec précision et sont susceptibles d'être endommagés facilement.

PRECAUTIONS LORS DE L'INSTALLATION

NE PAS UTILISER LE PROJECTEUR DANS LE CONDITIONS SUIVANTES.

- **Ne pas utiliser le projecteur en extérieur.**
Le projecteur a été conçu pour une utilisation en intérieur uniquement.
- **Ne pas soumettre le projecteur à des vibrations ou des chocs.**
Si le projecteur est installé dans un lieu où des vibrations sont transmises ou s'il est monté dans une voiture ou un bateau, les vibrations ou les impacts endommageront les pièces internes, entraînant une panne. Installer le produit dans un lieu sans vibrations et impacts.
- **Éviter d'installer le projecteur dans des lieux sujets à des changements de température brusques, comme à proximité d'un climatiseur ou d'un matériel d'éclairage.**
Cela entraînerait des dysfonctionnements ou la durée de vie de la lampe serait raccourcie.
Voir « VOYANT TEMP » à la page 43.
- **Éviter d'installer le projecteur près de lignes électriques à haute tension ou près de moteurs.**
Le projecteur sera exposé à des interférences s'il est installé à proximité de lignes électriques haute tension ou de sources d'alimentation.
- **Ne pas installer le projecteur à une altitude supérieure à 2 700 m (8 858 pi).**
Si le projecteur est utilisé à une altitude allant de 1 400 à 2 700 m (4 593 - 8 858 pi.) au-dessus du niveau de la mer, réglez l'option **MODE HAUTE ALTITUDE** sur **OUI**.
Si le projecteur est utilisé à une altitude de moins de 1 400 m (4 593 pi.) au-dessus du niveau de la mer, réglez l'option **MODE HAUTE ALTITUDE** sur **NON**.
Sinon, cela entraînera des dysfonctionnements ou la durée de vie de la lampe ou d'autres composants sera raccourcie.

VEILLEZ A FAIRE APPEL A UN TECHNICIEN SPECIALISE LORS DE L'INSTALLATION DU PROJECTEUR AU PLAFOND.

Si le projecteur doit être installé au plafond, acheter en option un système de fixation au plafond (modèle n° ET-PKB2). Veuillez appeler un technicien spécialisé ou contactez un centre technique agréé pour l'installation.

MISE AU POINT DE L'OBJECTIF

Ne pas régler la mise au point de l'objectif dans la période initiale après la mise en service du projecteur. L'objectif du projecteur à clarté élevée est affecté sur le plan thermique par l'éclairage de la source de lumière, ce qui déstabilise la mise au point immédiatement après la mise en route. Veuillez laisser un temps de chauffe d'au moins 30 minutes avant de régler la mise au point de l'objectif.

Précautions concernant la sécurité (suite)

Précautions lors de l'utilisation

POUR OBTENIR LA MEILLEURE QUALITÉ D'IMAGE

Fermer les rideaux ou les volets de toutes les fenêtres et éteindre les lampes situées à proximité de l'écran afin que la lumière extérieure ou la lumière des lampes intérieures n'éclaire pas l'écran.

Selon l'emplacement du projecteur, les aérations de sortie d'air ou la chaleur d'un climatiseur peuvent créer un effet chatoyant sur l'écran. Pour cette raison, veillez à ne pas bloquer les aérations de sortie d'air et prenez en compte le sens du courant d'air provenant du climatiseur.

NE PAS TOUCHER LA SURFACE DE L'OBJECTIF DU PROJECTEUR À MAINS NUES.

Si la surface de l'objectif présente des traces de doigt ou autres, celles-ci sont agrandies et projetées à l'écran. Veuillez installer la protection normale de l'objectif sur le projecteur quand vous ne l'utilisez pas.

NE PAS DÉPLACER LE PROJECTEUR EN COURS DE FONCTIONNEMENT OU LE SOUMETTRE À DES VIBRATIONS OU DES CHOCS.

La durée de vie de ses composants internes serait raccourcie.

LE PROJECTEUR EST ÉQUIPÉ D'UNE LAMPE AU MERCURE SOUS HAUTE PRESSION, DONT LES PRINCIPALES CARACTÉRISTIQUES SONT LES SUIVANTES :

- La luminosité de la lampe diminuera au fil du temps.
- Les chocs et éclats risquent d'endommager ou de réduire la durée de vie de la lampe.
- Dans de rares situations, elle peut exploser rapidement après la première utilisation.
- Les risques d'explosion augmentent si la lampe est utilisée après la date à laquelle elle est supposée être remplacée.
- Si la lampe explose, le gaz qu'elle contient se libère sous forme de fumée.
- La durée de vie d'une lampe à mercure varie selon le type de lampe ou les conditions d'utilisation.
- En particulier, le fait de la mettre fréquemment sous tension et hors tension et/ou de manière répétitive ainsi que de l'utiliser pendant 10 heures d'affilée affectera considérablement sa durée de vie. Prévoir une lampe de remplacement.

CONNEXION À UN APPAREIL EXTERNE

Lors de la connexion du projecteur à un ordinateur ou un appareil externe, utiliser le cordon d'alimentation fourni avec l'appareil en question et un câble d'interface à blindage disponible sur le marché.

COMPOSANTS OPTIQUES

Il peut être nécessaire de remplacer les composants optiques comme des affichages à cristaux liquides et des plaques polarisantes en moins d'un an si le projecteur est utilisé dans un environnement à haute température ou très poussiéreux, en contact avec des fumées grasses ou de tabac. Pour plus de détails, veuillez contacter votre revendeur.

ECRAN À CRISTAUX LIQUIDES

Les écrans à cristaux liquides sont fabriqués avec précision. Noter que dans quelques cas rares, des pixels haute précision peuvent manquer ou rester allumés en permanence, mais il ne s'agit pas d'un dysfonctionnement.

Ne pas projeter la même image pendant une longue durée, car elle risquerait de former une rémanence sur l'écran à cristaux liquides. Affichez la mire de l'écran blanc pendant plus d'une heure pour l'effacer. Voir « MIRE DE TEST » à la page 39.

SÉCURITÉ

PRENDRE DES MESURES DE SÉCURITÉ CONTRE LES INCIDENTS SUIVANTS.

- La fuite d'informations personnelles via ce projecteur.
- L'utilisation non autorisée de ce projecteur par un tiers malintentionné.
- L'interférence ou l'arrêt de ce projecteur par un tiers malintentionné.

INSTRUCTIONS DE SÉCURITÉ

- Le réseau de connexion doit être sécurisé par un pare-feu ou autre dispositif.
- Modifiez fréquemment votre mot de passe.
- N'utilisez pas un mot de passe facile à deviner.
- Panasonic et ses filiales ne vous demanderont jamais votre mot de passe de façon directe.
- Ne partagez pas votre mot de passe avec des personnes inconnues.
- Définissez un mot de passe et placez des restrictions sur les utilisateurs qui peuvent se connecter.

Remplacement de l'unité de la lampe

Filtre à air

Le filtre à air doit être remplacé lorsque le nettoyage ne donne pas de bons résultats ou lors du remplacement de l'unité de lampe. Un filtre à air ainsi qu'une lampe de rechange sont fournis (ET-LAB2). S'adresser à un centre technique agréé pour commander le filtre à air en option (TXFKN01VKN5).

L'unité de lampe

L'unité de lampe ET-LAB2 a une certaine durée de vie et vous devez la remplacer régulièrement. Il est recommandé de faire remplacer l'unité de lampe par un technicien qualifié. Consultez un centre technique agréé.

Remarque sur le remplacement de l'unité de la lampe

- Manipuler l'unité de la lampe avec prudence car elle contient du verre.
Si elle tombe ou qu'elle reçoit un choc, elle pourrait s'endommager ou éclater.
- Si vous souhaitez mettre la lampe usagée au rebut, veuillez contacter les autorités locales ou votre distributeur et demandez la méthode de mise au rebut correcte.
- Préparer un tournevis cruciforme.
- Lors du remplacement de l'unité de la lampe, veillez à la tenir par la poignée.
- Tenez l'unité de la lampe horizontalement pour éviter que les pièces cassées ne se répandent.

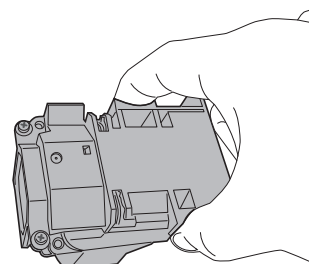

Quand le projecteur est monté au plafond, ne pas travailler directement en dessous ou approcher le visage du projecteur.
Retirez la lampe verticalement.

REMARQUE :

- Avant de remplacer la lampe, la laisser refroidir pour éviter les risques de brûlures, les dommages et autres dangers.
- Ne pas essayer de la remplacer par une lampe non recommandée.

Quand changer l'unité de la lampe

Lorsque la lampe est usée, la luminosité risque de diminuer. 4 000 heures d'utilisation est une référence approximative du moment où remplacer la lampe et cette durée peut être plus courte en fonction des conditions d'utilisation, des spécifications de l'unité de la lampe ou des conditions environnementales. Il est possible de contrôler l'état d'utilisation en consultant la **DURÉE DE LA LAMPE** dans le menu **RÉGLAGE PROJECTEUR** : N'utilisez pas de lampe plus de 5 000 heures. Sinon la lampe pourrait exploser.

	MENU À L'ÉCRAN	LAMPE voyant
3 800 heures	Affichage « REEMPLACER LA LAMPE » dans la partie supérieure gauche de l'écran pendant 30 secondes. Si vous appuyez sur une touche dans les 30 secondes le message disparaît.	S'allume en rouge, même en mode veille.
5 000 heures	Affichage « REEMPLACER LA LAMPE » dans la partie supérieure gauche jusqu'à ce que répondez. Le projecteur se met automatiquement sous tension au bout de 10 minutes.	

REMARQUE :

- La durée indiquée de 4 000 heures est une estimation basée sur certaines conditions et ne représente en aucun cas une durée garantie.

Remplacement de l'unité de la lampe (suite)

Procédure de remplacement de la lampe

- En cas d'installation du projecteur au plafond, ne jamais travailler directement dessous et éloigner le visage du projecteur.
- S'assurer d'installer l'unité de la lampe et de fixer la protection de l'unité fermement. Si elles ne sont pas installées fermement, le circuit de protection peut s'enclencher et bloquer la mise sous tension de l'appareil.

1 Débrancher la fiche du cordon d'alimentation de la prise de courant selon la section « MISE HORS TENSION DU PROJECTEUR » (⇒ page 21), attendez au moins 1 heure et contrôlez la base pour voir si la lampe s'est refroidie.

2 Utilisez un tournevis cruciforme pour dévisser la vis de fixation du couvercle de la lampe à l'arrière du projecteur jusqu'à ce que les vis tournent librement, puis retirez le couvercle de la lampe.

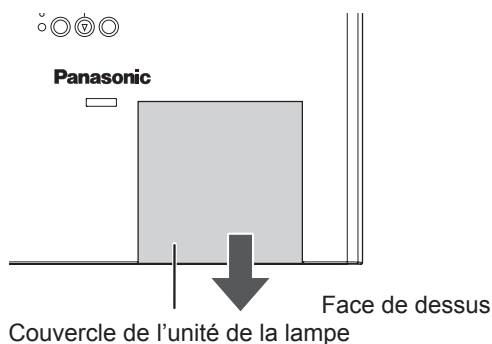
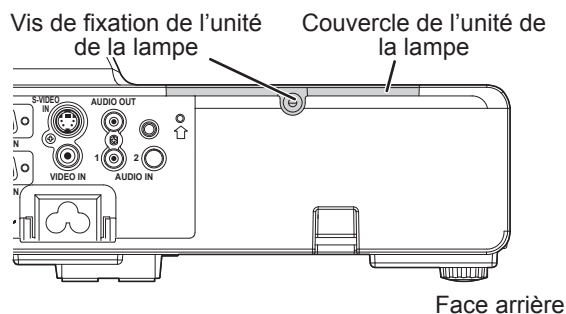

3 Utilisez un tournevis cruciforme pour desserrer les 2 vis de fixation de l'unité de lampe. Tenir l'unité de la lampe par la poignée puis débloquent le verrou de la lampe.

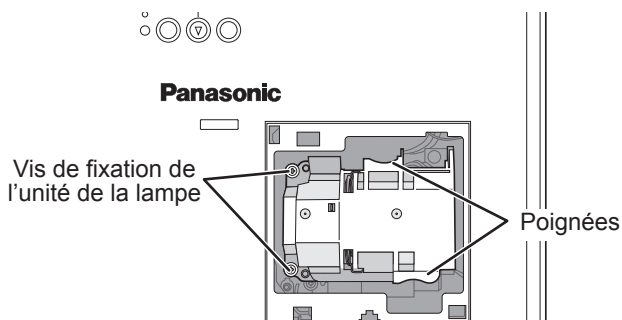

4 Appuyer sur l'unité de la lampe jusqu'à ce qu'elle s'encliquète et s'assurer qu'elle soit bien fixée en place. Resserrer les 2 vis de fixation de l'unité de lampe à l'aide du tournevis cruciforme. Lors de l'insertion, appuyez fermement sur la partie **A**.

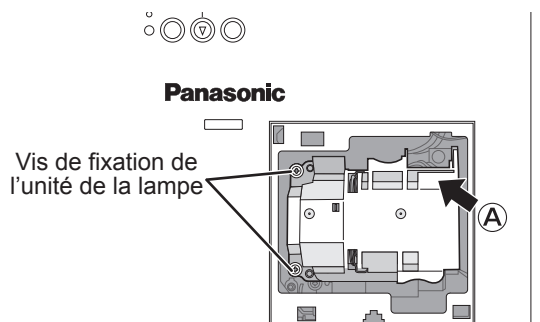

5 Remettre en place le couvercle de la lampe puis resserrer les vis de fixation du couvercle de la lampe à l'aide du tournevis cruciforme.

6 Insérer la prise d'alimentation dans une prise de courant.

7 Appuyer sur [ALIMENTATION] pour commencer la projection.

REMARQUE :

- Si le paramètre **DEMARRAGE INITIAL** dans le menu **RÉGLAGE PROJECTEUR** est réglé sur **OUI**, la projection commence quand le cordon d'alimentation est connecté à une prise secteur. (⇒ page 37)

8



Pour afficher le menu principal.



Pour accéder au menu RÉGLAGE PROJECTEUR.

Remplacement de l'unité de la lampe (suite)

9



Pour sélectionner le menu **RÉGLAGE PROJECTEUR**.



Pour sélectionner **DURÉE DE LA LAMPE**.

10



Maintenir enfoncée la touche pendant au moins 3 secondes.

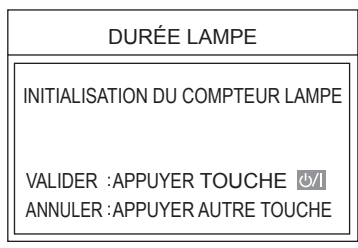

REMARQUE :

- Si vous appuyez sur une autre touche que **ALIMENTATION**, l'écran **DURÉE DE LA LAMPE** disparaît et la durée de la lampe n'est pas redéfinie. (Répéter à partir de l'étape 8).

11



Une fois que la lampe s'éteint, la projection s'arrête et la touche **ALIMENTATION** sur l'unité principale est allumée en rouge. Débranchez le cordon d'alimentation. La durée de la lampe a été remise à « 0 ».

NOTE:

This product contains a CR Coin Cell Lithium Battery which contains Perchlorate Material - special handling may apply.

See www.dtsc.ca.gov/hazardouswaste/perchlorate.

Panasonic Corporation

Web Site : <http://panasonic.net/avc/projector/>

© Panasonic Corporation 2010

Panasonic Solutions Company

3 Panasonic Way, Secaucus, NJ 07094

TEL: (877) 803 - 8492

Panasonic Canada Inc.

5770 Ambler Drive, Mississauga, Ontario L4W 2T3

TEL: (905) 624 - 5010

F0610-0
TQBJ0332