



**LG**

Life's Good

# OWNER'S MANUAL DLP PROJECTOR

Please read this manual carefully before operating your set and retain it for future reference.

BX327

# DLP PROJECTOR



## Warning - Class B

(b) For a Class B Digital device or peripheral, the instructions furnished the user shall include the following or similar statement, placed in a prominent location in the text of the manual:

NOTE: This equipment has been tested and found to comply with the limits for a Class B digital device, pursuant to part 15 of the FCC Rules. These limits are designed to provide reasonable protection against harmful interference in a residential installation. This equipment generates, uses and can radiate radio frequency energy and, if not installed and used in accordance with the instructions, may cause harmful interference to radio communications. However, there is no guarantee that interference will not occur in a particular installation. If this equipment does cause harmful interference to radio or television reception, which can be determined by turning the equipment off and on, the user is encouraged to try to correct the interference by one or more of the following measures:

- Reorient or relocate the receiving antenna.
- Increase the separation between the equipment and receiver.
- Connect the equipment into an outlet on a circuit different from that to which the receiver is connected.
- Consult the dealer or an experienced radio/TV technician for help.

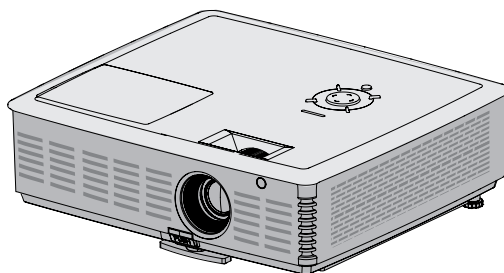

# Contents

<b>Safety Instructions</b> .....	4	<b>TIME Menu Options</b>	
<b>Names of parts</b>		Sleep time Function .....	27
Main Body .....	7	Auto Off Function .....	27
Control Panel .....	7	Presentation timer Function .....	28
Connecting Part .....	8	<b>OPTION Menu Options</b>	
Remote Control .....	9	Selecting Language .....	29
Installing Batteries .....	9	Using Blank Function .....	29
Projector Status Indicators .....	10	Selecting Blank image .....	29
Accessories .....	11	Screen Capture Function .....	30
Optional Extras .....	11	To adjust the brightness of the screen .....	30
<b>Installing and Composition</b>		Using Monitor out Function .....	30
Installation Precautions .....	12	SET ID .....	31
Basic Operation of the Projector .....	13	How to connect external control equipment .....	31
Kensington Security System .....	14	Network Setup .....	37
Turning on the Projector .....	14	High Altitude Mode .....	38
Turning off the Projector .....	14	<b>INFORMATION Menu Options</b>	
Focus and Position of the Screen Image .....	15	To See The Projector Information .....	38
Selecting input mode .....	15	<b>USB</b>	
<b>Connection</b>		<b>To use the USB device</b>	
Connecting to a Notebook PC .....	16	Connecting the USB device .....	39
Connecting to a Video Source .....	16	Eject USB .....	39
Connecting to a DVD Player .....	17	Precautions when using the USB device .....	39
Connecting to a D-TV Set-Top Box .....	17	<b>PHOTO LIST</b>	
<b>3D Video function.</b>		Screen Components .....	40
Before watch 3D image .....	18	Photo Selection and Popup Menu .....	40
To watch 3D image .....	19	Full Screen Menu .....	41
How to watch 3D image .....	19	<b>MUSIC LIST</b>	
<b>Function</b>		Screen Components .....	42
<b>PICTURE Menu Options</b>		Music Selection and Popup Menu .....	42
Picture mode .....	21	<b>MOVIE LIST</b>	
Adjusting Picture Mode .....	21	Supported Movie File .....	43
Advanced Control Function .....	22	Precautions when playing the DivX .....	44
Color Temperature Function .....	23	Screen Components .....	45
Picture Reset Function .....	23	Movie Selection and Popup Menu .....	45
<b>SCREEN Menu Options</b>		Playing the Movie .....	46
To Change PJT Mode .....	24	Option Menu Selection .....	46
Using Aspect Ratio Function .....	24	To See The DivX Registration Code .....	47
Using Keystone Function .....	24	Deactivation Function .....	47
Auto Configure Function .....	24	<b>FILE VIEWER</b>	
RGB Config. Function .....	25	Screen Components .....	48
Using Digital Zoom Function .....	25	View File .....	48
Using the Still Function .....	25	<b>Information</b>	
<b>AUDIO Menu Options</b>		Supported Monitor Display .....	49
Adjusting Volume .....	26	Maintenance .....	49
Function Audio .....	26	Replacing the Lamp .....	50
Adjusting Speaker Balance .....	26	How to fix the lens cap to the projector .....	52
Adjusting Treble .....	26	MEMO .....	53
Adjusting Bass .....	26	Specifications .....	54
		Open Source Software Notice .....	55



## Disposal of your old appliance

1. When this crossed-out wheeled bin symbol is attached to a product it means the product is covered by the European Directive 2002/96/EC.
2. All electrical and electronic products should be disposed of separately from the municipal waste stream through designated collection facilities appointed by your government or your local authorities.
3. The correct disposal of your old appliance will help prevent potential negative consequences for the environment and human health.
4. For more detailed information about disposal of your old appliance, please contact your city office, waste disposal service or the shop where you purchased the product.
5. The fluorescent lamp used in this product contains a small amount of mercury. Do not dispose of this product with general household waste. Disposal of this product must be carried out in accordance to the regulations of your local authority.

# Safety Instructions

Please take note of the safety instructions to prevent any potential accident or misuse of the projector.

- Safety Instructions are given in two forms as detailed below.

 **WARNING** : The violation of this instruction may cause serious injuries and even death.

 **NOTES** : The violation of this instruction may cause injuries or damage to the projector.

- After reading this manual, keep it in the place that you can access easily.

## Indoor Installation

### WARNING

Do not place the Projector in direct sunlight or near heat sources such as radiators, fires, stove etc.

This may cause a fire hazard or product defect.

Do not place flammable materials in, on or near the projector.

This may cause a fire hazard or product defect.

Do not hang on an installed projector.

It may cause the projector to fall, causing injury or death.

Do not block the vents of the projector or restrict air-flow in any way.

This would cause the internal temperature to increase and could cause a fire hazard or damage to the unit!

Do not place the projector close to sources of steam or oil such as a humidifier.

This may create a fire hazard or an electric shock hazard!

Do not place the projector where it might be exposed to dust.

This may cause a fire hazard or damage to the unit!

Do not use the projector in a damp place such as a bathroom where it is likely to get wet.

This may cause a fire or an electric shock hazard!

Do not place the projector directly on a carpet, rug or place where ventilation is restricted.

This would cause its internal temperature to increase and might create a fire hazard or damage the unit.

Ensure good ventilation around the projector. The distance between the projector and the wall should be more than 30 cm.

An excessive increase in its internal temperature may cause a fire hazard or damage to the unit!

## Indoor Installation

### NOTES

When installing the projector on a table, be careful not to place it near the edge.

The projector could fall causing injury and damage to the projector.  
**Only use a suitable stand.**

Disconnect from the power supply and remove all connections before moving, or cleaning.

Only use the projector on a level and stable surface.

It may fall and cause injury and/or damage to the unit.

## Power

### WARNING

Earth wire should be connected.

Ensure that you connect the earth ground wire to prevent possible electric shock (That is a Projector with a three-prong grounded AC plug must be connected to a three-prong grounded AC outlet).  
If grounding methods are not possible, have a qualified electrician install a separate circuit breaker.  
Do not try to ground the unit by connecting it to telephone wires, lightening rods, or gas pipes.

The power cord should be inserted fully into the power outlet to avoid a fire hazard!

This may cause a fire hazard or damage the unit.

Do not place heavy objects on the power cord.

This may cause a fire or an electric shock hazard!



**Power**  **WARNING**

Never touch the power plug with a wet hand.  This may cause an electric shock hazard!	Do not plug-in too many items into one power outlet.  It may result in overheating of the outlet and create a fire hazard!	Prevent dust from collecting on the power plug pins or outlet.  This may cause a fire hazard!
---	--	---

**Power**  **NOTES**

Hold the plug firmly when unplugging. If you pull the cord, it may be damaged.  This may cause a fire hazard!	Do not use if the power cord or the plug is damaged or any part of the power outlet is loose.  This may cause a fire or an electric shock hazard or damage to the unit!	Ensure the power cord does not come into contact with sharp or hot objects.  This may cause a fire or an electric shock hazard or damage to the unit!
---	---	---

Place the projector where people will not trip or tread on the power cord.  This may cause a fire or an electric shock hazard or damage to the unit!	Do not turn the projector On/Off by plugging-in or unplugging the power plug to the wall outlet. (Allow the unit to cool before removing power.)  It may cause mechanical failure or could cause an electric shock.
--	---

**Using**  **WARNING**

Do not place anything containing liquid on top of the projector such as flowerpot, cup, cosmetics or candle.  This may cause a fire hazard or damage to the unit!	In case of impact shock or damage to the projector switch it off and unplug it from the power outlet and contact an authorized service center.  This may cause a fire or an electric shock hazard or damage to the unit!	Do not allow any objects to fall into the projector.  This may cause an electric shock hazard or damage to the unit!
---	--	--

If water is spilt into the projector unplug it from the power supply immediately and consult your Service Agent.  This may cause an electric shock hazard or damage to the unit!	Dispose of used batteries carefully and safely.  In the case of a battery being swallowed by a child please consult a doctor immediately.
--	---

Do not remove any covers. High risk of Electric Shock!	Don't look directly into the lens when the projector is in use. Eye damage may occur!	Do not touch metal parts during or soon after operation since the vents will remain very hot!
--	---	---

**CAUTION concerning the Power Cord**  
It is recommend that most appliances be placed on a dedicated circuit, that is, a single outlet circuit which powers only that appliance and has no additional outlets or branch circuits. Check the specification page of this owner's manual to be certain.

Do not overload wall outlets. Overloaded wall outlets, loose or damaged wall outlets, extension cords, frayed power cords, or damaged or cracked wire insulation are dangerous. Any of these conditions could result in electric shock or fire. Periodically examine the cord of your appliance, and if its appearance indicates damage or deterioration, unplug it, discontinue use of the appliance, and have the cord replaced with an exact replacement part by authorized service personnel.

Protect the power cord from physical or mechanical abuse, such as being twisted, kinked, pinched, closed in a door, or walked upon. Pay particular attention to plugs, wall outlets, and the point where the cord exits the appliance.

**Using**  **WARNING**

<p>If the projector is in a room that experiences a gas leak, do not touch the projector.</p> <p>It can cause a fire or a burn by a spark.</p>	<p>Always open the lens door or remove the lens cap when the projector lamp is on.</p>
--	--

**Using**  **NOTES**

<p>Do not place heavy objects on top of projector.</p> <p>This may cause mechanical failure or personal injury!</p>	<p>Take care not to impact the lens particularly when moving the projector.</p>	<p>Do not touch the lens of the projector. It is delicate and easily damaged.</p>
<p>Do not use any sharp tools on the projector as this will damage the casing.</p>	<p>In the event that an image does not appear on the screen please switch it off and unplug it from the power outlet and contact your Service Agent.</p> <p>This may cause a fire or an electric shock hazard or damage to the unit!</p>	<p>Do not drop the projector or allow impact shock.</p> <p>This may cause mechanical failure or personal injury!</p>

**Cleaning**  **WARNING**

<p>Do not use water while cleaning the projector.</p> <p>This may cause damage to the projector or an electric shock hazard.</p>	<p>In the unlikely event of smoke or a strange smell from the projector, switch it off, unplug it from the wall outlet and contact your dealer or service center.</p> <p>This may cause a fire or an electric shock hazard or damage to the unit!</p>	<p>Use an air spray or soft cloth that is moist with a neutral detergent and water for removing dust or stains on the projection lens.</p>
--	---	--

**Cleaning**  **NOTES**

<p>Contact the Service Center once a year to clean the internal parts of the projector.</p> <p>Accumulated dust can cause mechanical failure.</p>	<p>When cleaning the plastic parts such as projector case, unplug the power and wipe it with a soft cloth. Do not use cleanser, spray water or wipe with a wet cloth. Especially, never use cleanser (glass cleaner), automobile or industrial shiner, abrasive or wax, benzene, alcohol etc., which can damage the product. Use an air spray or soft cloth that is moist with a neutral detergent and water for removing dust or stains on the projection lens.</p> <p>It can cause fire, electric shock or product damage (deformation, corrosion and damage).</p>
---	--

**Others**  **WARNING**

Do not attempt to service the projector yourself. Contact your dealer or service center.

This may cause damage to the projector and could give an electric Shock as well as invalidating the warranty!

**Others**  **NOTES**

<p>Do not mix new batteries with old batteries.</p> <p>This may cause the batteries to over-heat and leak.</p>	<p>Be sure to unplug if the projector is not to be used for a long period.</p> <p>Accumulated dust may cause a fire hazard or damage to the unit!</p>	<p>Only use the specified type of battery.</p> <p>This could cause damage to the remote control.</p>
--	---	--

# Names of parts

## Main Body

\* The projector is manufactured using high-precision technology. You may, however, see on the Projector screen tiny black points and/or bright points (red, blue, or green). This can be a normal result of the manufacturing process and does not always indicate a malfunction.

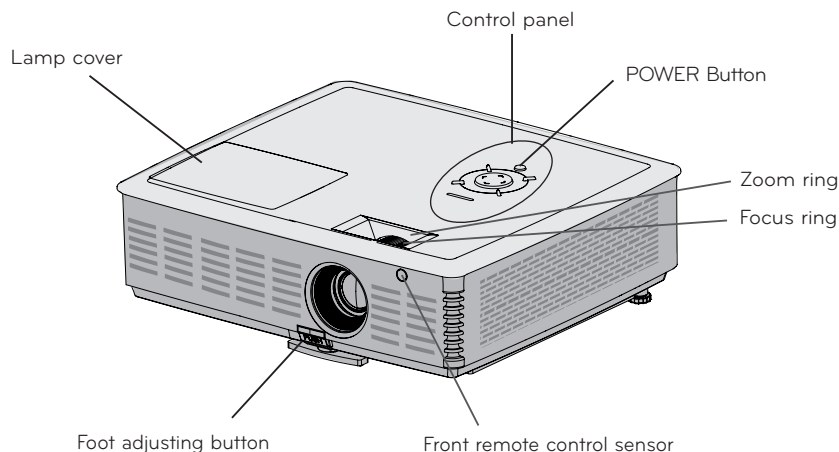

## Control Panel

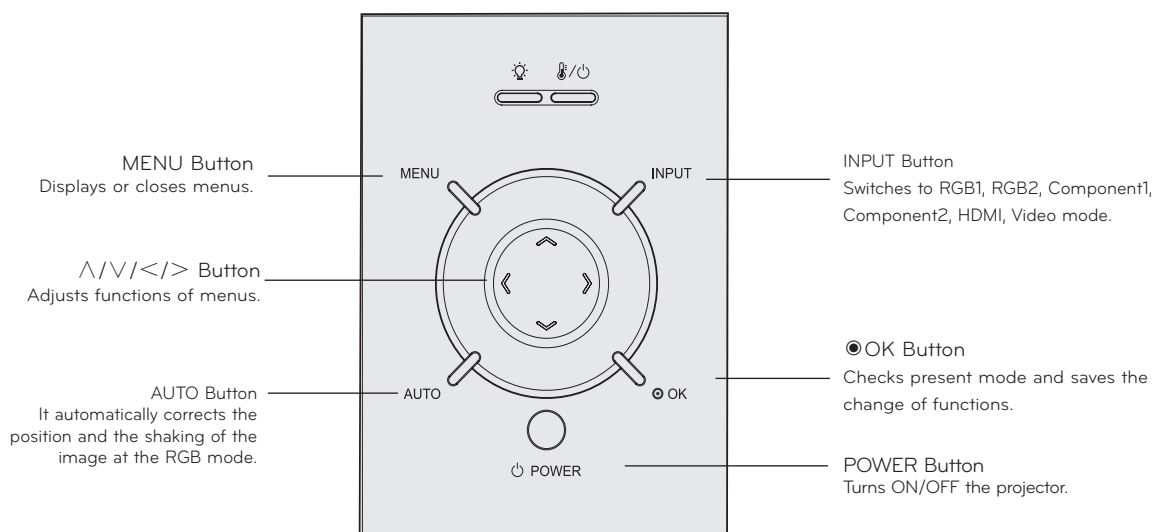

Connecting Part

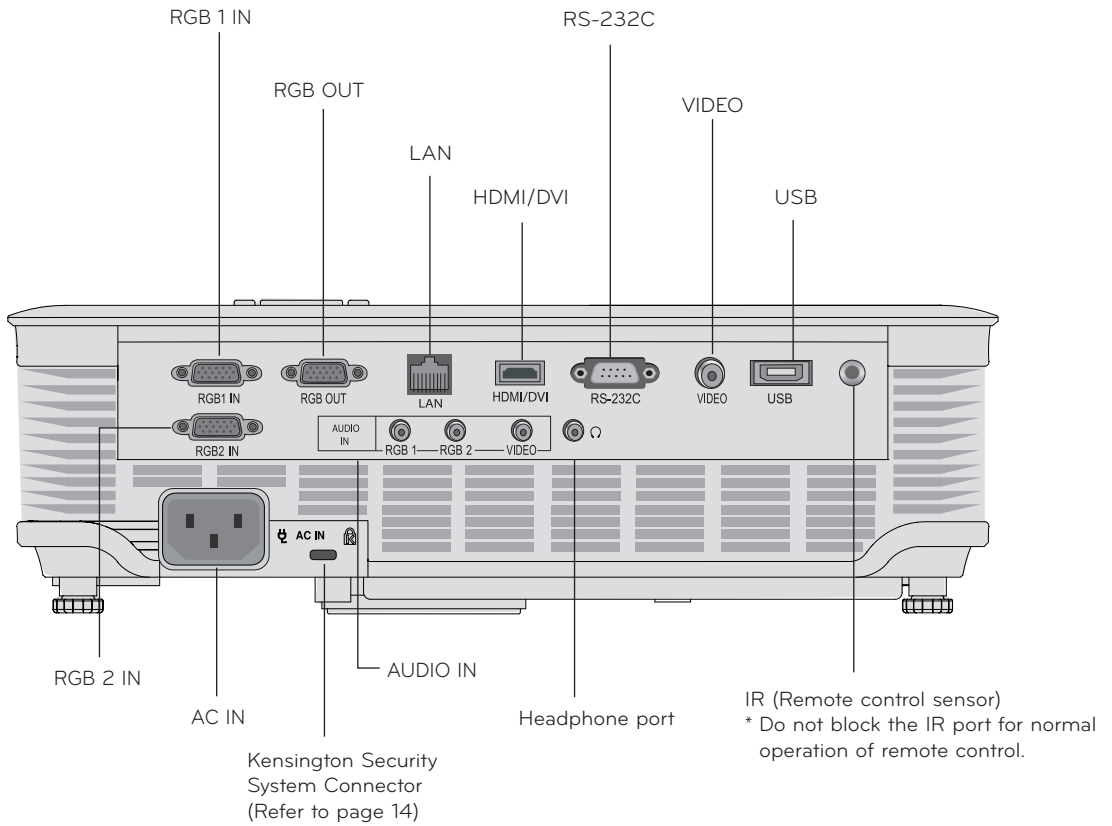

\*When using HDMI/USB connector, if the size of the jack connecting to the connector is too big, they may not be connected. Please use standard size jack.

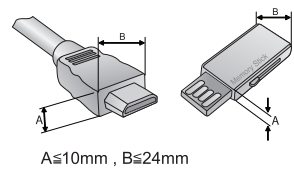

## Remote Control

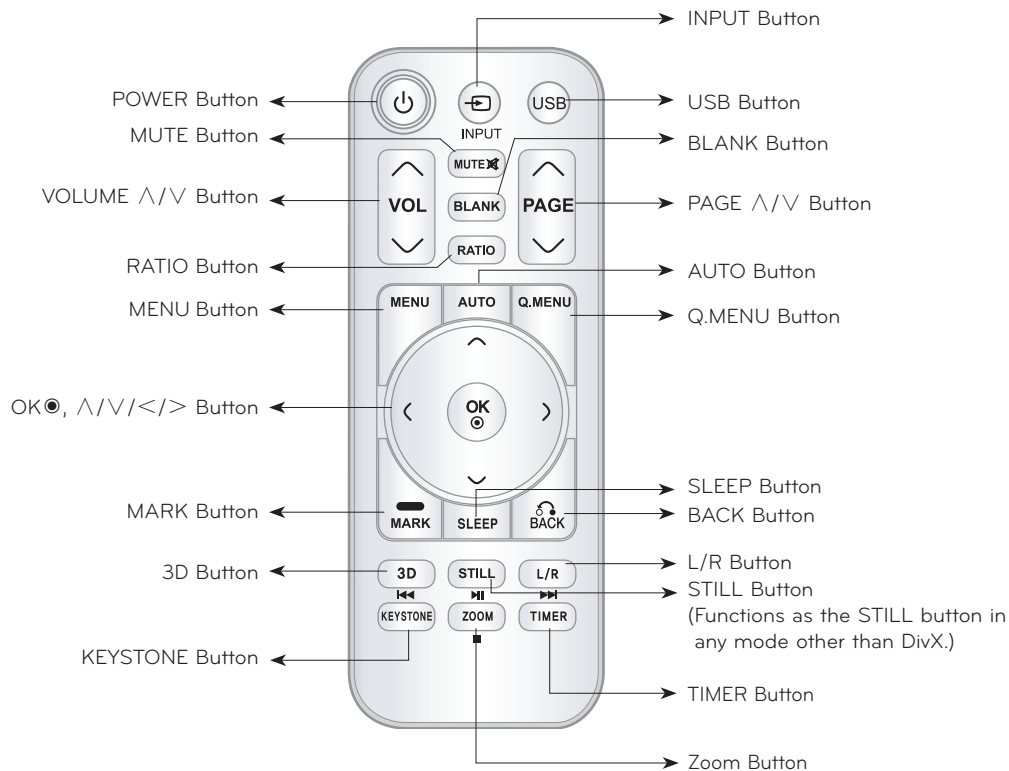

## Installing Batteries

**CAUTION**

RISK OF EXPLOSION IF BATTERY IS REPLACED WITH AN INCORRECT TYPE.  
DISPOSE OF USED BATTERIES ACCORDING TO THE INSTRUCTIONS.

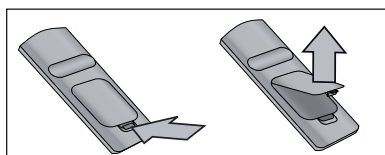

- Open the battery compartment cover on the back of the remote control.
- Insert the specified type of batteries with correct polarity, match "+" with "+", and match "-" with "-".
- Install two 1.5V AAA batteries. Don't mix used batteries with new batteries.

## Projector Status Indicators

\* Lamp indicator, operation indicator and temperature indicator at the top of the projector show the user the operating status of the projector.

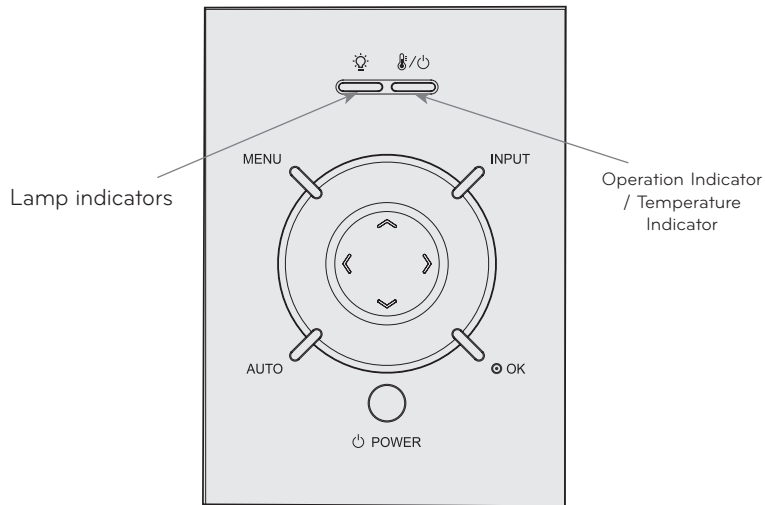

Operation Indicator / Temperature Indicator	Red	Standby.
	Green(flashing)	Lamp is starting up.
	Green	Unit is in operation (Lamp is turned on)
	Orange(flashing)	The lamp is cooling (10 seconds).
		The projector has been turned off due to excessive heat (1 minute and 30 seconds).
	Off	Power off.
	Orange	Standby-This mode cools the projector naturally for 4 minutes after it is turned off. This is the warning message of excessive heat when the projector is on. Turn the projector off and check the ventilator.
Red(flashing)	Power has turned off due to problem with the internal cooling fan. Contact your service center.	
Lamp Indicator	Red	Projector lamp is reaching the end of its life and needs to be replaced with a new lamp.
	Red(flashing)	An error has occurred in the projector lamp. Turn the projector on again after sufficient amount of time. If this indicator flashes red again, contact your local service center.
	Green (flashing)	The lamp cover is open.
	Orange(flashing)	This indicates Color Wheel Motor or Color Wheel Index problem. Please contact your local service center.

Accessories



Remote Control

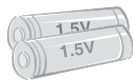

AAA Battery

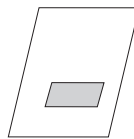

Owner's manual

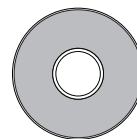

CD Owner's manual



Power Cord



Computer Cable



Lens cap and Strap

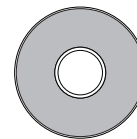

eZ-Net Manager CD

Optional Extras

\* Contact your dealer to purchase these items.

\* Optional parts can be changed without notice to improve the quality of the product, and new optional parts can be added.

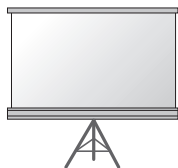

Projection Screen

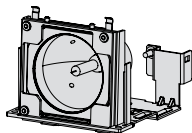

Lamp



LAN Cable



Component Cable



HDMI Cable



RS-232C Cable



RCA to D-Sub Adapter



Video Cable



3D Glasses  
(DLP-LINK or  
DLP-Ready Type)

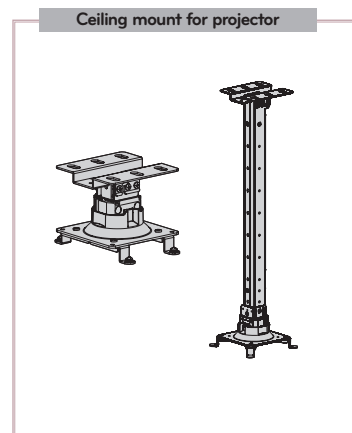

\* Please use M4xL10 MACHINE SCREW to tighten up the set if other product than recommended ceiling mount is used

# Installing and Composition

## Installation Precautions

### Provide proper ventilation for this projector.

- The projector is equipped with ventilation holes(intake) on the bottom and ventilation holes(exhaust) on the front. Do not block or place anything near these holes. Internal heat build-up may occur, causing picture degradation or damage to the projector.
- Do not place the projector on a carpet, rug or other similar surface. It may prevent a adequate ventilation of the projector bottom. This product should be mounted to a wall or ceiling only.

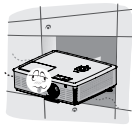

- Never push projector or spill any kind of liquid into the projector.
- Leave an adequate distance (30 cm or more) around the projector.

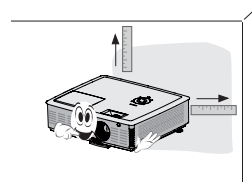
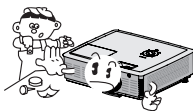

### Place this projector in adequate temperature and humidity conditions.

- Install this projector only in a location where adequate temperature and humidity is available. (refer page 54)

### Don't place the projector where it can be covered with dust.

- This may cause overheating of the projector.

### Do not obstruct the slots and openings of the projector. This may cause overheating and create a fire hazard.

This projector is manufactured using high-precision technology. You may, however, see tiny black points and/or bright points (red, blue or green) that continuously appear on the projector Screen. This is a normal result of the manufacturing process and does not indicate a malfunction.

To display DTV programs, it is necessary to purchase a DTV receiver (Set-top Box) and connect it to the projector.

The remote control may not work when a lamp equipped with electronic ballast or a three-wavelength lamp is installed. Replace those lamps with international standard products to use the remote control normally.



### Basic Operation of the Projector

1. Place the projector on a sturdy and horizontal surface with the PC or AV source.
2. Place the projector with the desired distance from the screen. The distance between the projector and the screen determines the actual size of the image.
3. Position the projector so that the lens is set at a right angle to the screen. If the projector is not set at a right angle, the screen image will be crooked. Although, slight angles can be counteracted using the Keystone adjustment. (Refer to page 24.)
4. Connect the power cable to the projector and the wall outlet after placing the projector in its desired location.

projection distance based on the picture format

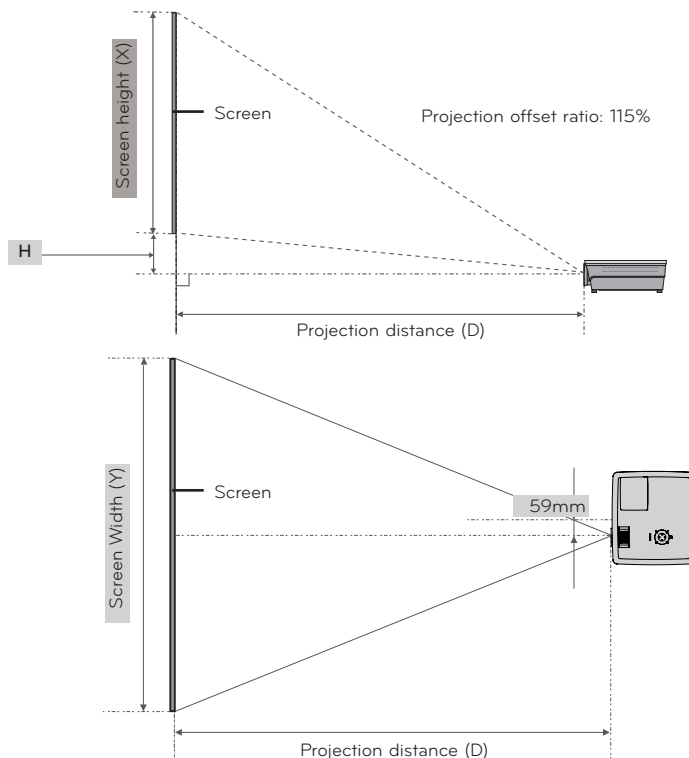

4 : 3 Scale					
Image(mm)				Projection Distance(mm)	
Diagonal Size	Horizontal Size	Vertical Size	H	Wide Distance	Tele Distance
1016	813	610	92	1595	1849
1270	1016	762	114	1999	2317
1524	1219	914	137	2403	2786
1778	1422	1067	160	2808	3254
2032	1626	1219	183	3212	3723
2286	1829	1372	206	3616	4191
2540	2032	1524	229	4020	4660
3048	2438	1829	274	4829	5597
3556	2845	2134	320	5637	6534
4064	3251	2438	366	6446	7471
4572	3658	2743	411	7254	8408
5080	4064	3048	457	8062	9345
5588	4470	3353	503	8871	10282
6096	4877	3658	549	9679	11219
6350	5080	3810	572	10084	11688

## Kensington Security System

- This projector has a Kensington Security System Connector on the side panel. Connect the Kensington Security System cable as below.
- For the detailed installation and use of the Kensington Security System, refer to the user's guide included with the Kensington Security System set. And for further information, contact <http://www.kensington.com>, the internet homepage of the Kensington company that deals with expensive electronic equipment such as notebook PCs or projectors.
- The Kensington Security System is an optional item.

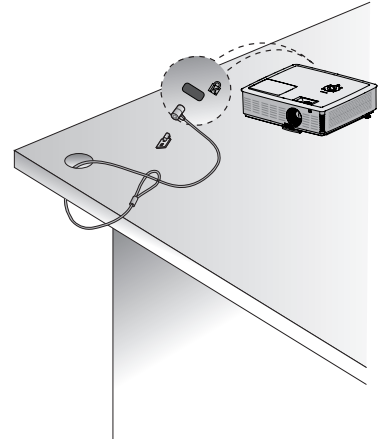

## Turning on the Projector

1. Connect power cord correctly.
  2. Remove the lens cap. If it is left on, it could become deformed due to the heat produced by the projection lamp.
  3. Press the **POWER** button on the remote control or top cover.  
(Green operation indicator flashes if lamp is in start-up cycle.)
- An image will appear after the operation indicator light turns (Green).
  - Select the source mode with the INPUT button.

### Note!

\* Do not disconnect the power cord during the suction/discharge fan in operation. If the power cord is disconnected during the suction/ discharge fan in operation, it may takes longer to activate the lamp after turning on the power and the lifespan of the lamp may be shortened.

## Turning off the Projector

1. Press the **POWER** button on the top cover or remote control.

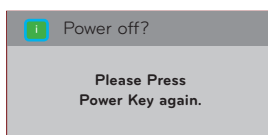

2. Press the **POWER** button on the top cover or remote control again to turn off the power.
  3. If the operation indicator LED is orange and blinking, do not disconnect(30 sec.) the supply until the operation indicator LED is lit constantly (orange).
- If the operation indicator LED is orange and blinking, the power button on the top cover or on the remote control will not operate.
  - This projector features the Quick Power On/Off function that allows a user to turn it on and off quickly.

\* What is the Quick Power On/Off function?

The projector enters into Standby mode without waiting it is cooled.

When standby mode is maintained for about 4 minutes after turning off the projector, it operates immediately without cooling when the set is turned on.

## Focus and Position of the Screen Image

When an image appears on the screen, check if it is in focus and fits well to the screen.

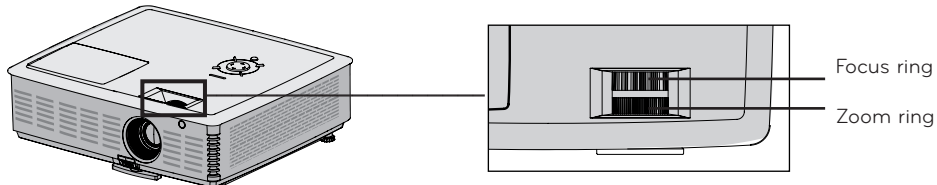

- To adjust the focus of the image, rotate the focus ring which is the outer ring on the lens.
- To adjust the size of the image, rotate the zoom ring which is the inner ring on the lens.

To raise or lower the image on the screen, extend or retract the foot at the bottom of the projector by pushing foot adjusting button as below.

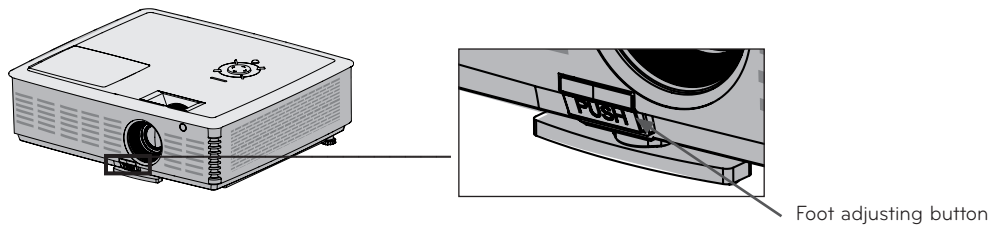

1. While pressing the foot adjusting button, raise or lower the projector to place the screen image in the proper position.
2. Release the button to lock the foot in its new position.
3. Turn the foot at the back left or right to make a fine tune of the length of the projector.
4. After raising the front foot, do not press down on the projector.

## Selecting input mode

1. Press the **INPUT** button on the remote control.
2. Selecting an input signal with the **INPUT** button will only change the projector only to connected inputs. You can change it to any inputs with the **<**, **>** button.

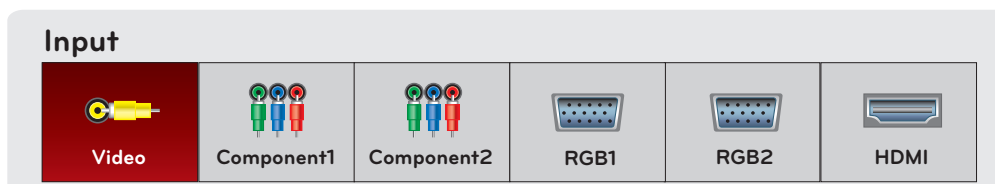

- The component input is always active, and it does not support plug &play function.

# Connection

## Connecting to a Notebook PC

\* You can connect the projector to a computer with VGA, SVGA, XGA, SXGA, UXGA output.

\* Refer to page 49 for resolutions the projector supports.

### < How to connect >

1. Connect the **RGB 1 IN** of the projector and the computer output port with a computer cable.
2. Connect the **AUDIO IN RGB 1** of the projector and the computer audio output port with an audio cable.

\* You may have to change the resolution that your PC exports to one supported by the projector. (Refer to page 49.) This projector may not support output from laptops when the laptop screen is on.

\* You can also connect to the **RGB 2 IN** port.

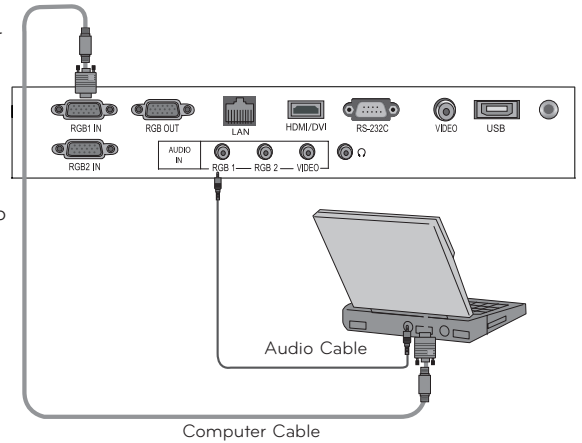

\* Please activate HDMI sound by changing Windows setting on desktop PC to play sound using PC-HDMI through projector speaker.

## Connecting to a Video Source

\* You can connect a VCR, a camcorder or any other compatible video image source to the projector.

### < How to connect >

1. Connect the **VIDEO IN** of the projector to the output jack of the video source with a video cable.
2. Connect the **AUDIO IN VIDEO** of the projector to the output jack of the audio source with an audio cable.

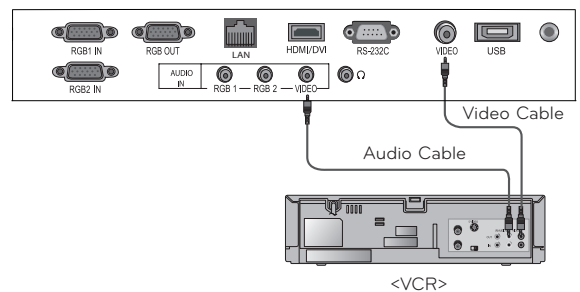

### Connecting to a DVD Player

\* Depending on the equipment, the component output jacks (Y, Pb, Pr) of the DVD Player may be labeled as Y, Pb, Pr/Y, B-Y, R-Y/Y, Cb, Cr.

#### < How to connect a HDMI source >

1. Connect the **HDMI** of the projector and the HDMI output port of the DVD Player with an HDMI cable.
2. Set the DVD Player's resolution to one of the following: 480p(576p)/720p/1080i/1080p mode.

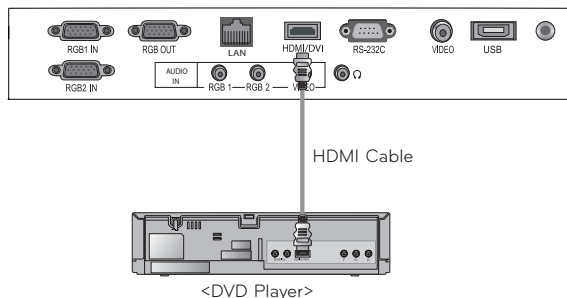

#### < How to connect a Component source >

1. After connecting the Component cable of DVD Player to the RGB to Component cable, connect it to the **RGB 1 IN** terminal of the projector.  
\* When connecting the component cable, match the jack colors with the component cable.(Y=green, Pb=blue, Pr =red)

2. Connect the **AUDIO IN RGB 1** of the projector to the output jacks of the audio source with an audio cable.

\* You can also connect to the RGB 2 IN port.

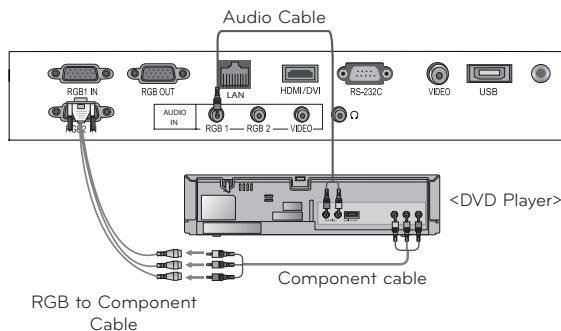

### Connecting to a D-TV Set-Top Box

\* To receive Digital TV (D-TV) programs, it is necessary to purchase a D-TV receiver (Set-Top Box) and connect it to the projector.

\* Please refer to the owner's manual of the D-TV Set-Top Box for the connection between the projector and D-TV Set-Top Box.

#### < How to connect a HDMI source >

1. Connect the **HDMI** of the projector and the HDMI output port of the DTV set-top box with an HDMI cable.
2. Set the DTV receiver's resolution to one of the following: 480p(576p)/720p/1080i/1080p mode.

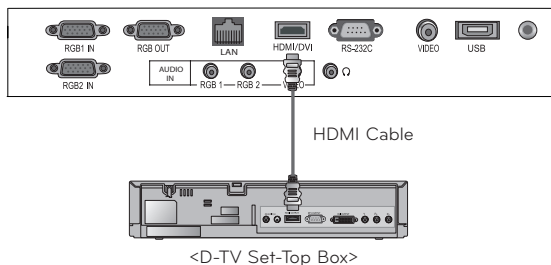

#### < How to connect a Component source >

1. Connect the D-TV Set-Top Box Component cable with RGB to Component cable and then connect it to **RGB 1 IN** of the projector.

\* When connecting the component cable, match the jack colors with the component cable.(Y=green, Pb=blue, Pr =red)

2. Connect the **AUDIO IN RGB 1** of the projector to the output jacks of the audio source with an audio cable.

\* You can also connect to the RGB 2 IN port.

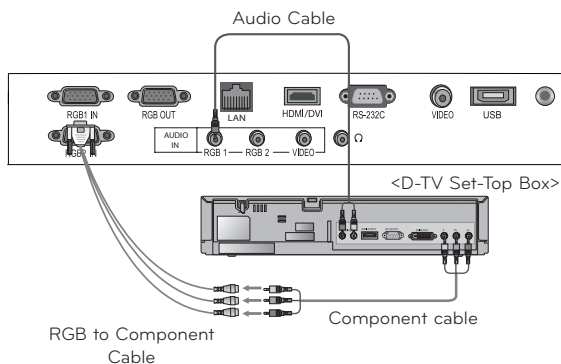

## 3D Video function.

\* 3D image is a technology that utilizes parallax of both eyes to make an image to be perceived solid.

### Before watch 3D image

#### While watching 3D image



#### Warning

- ▶ Do not watch 3D image at a close distance for a long time. It might impair visual acuity.
- ▶ It might cause dizziness if one watch projector screen or play video game while wearing 3D glasses for a long time.
- ▶ Please refrain from watching it if you are one of the following: a pregnant, an elderly, one who has a weak heart, one who often get nausea, or one who is drunk.
- ▶ 3D image can be misunderstood as a reality and cause astonishment or excitement.
- ▶ Do not put objects that are easily broken or can cause harm when watching 3D image.
- ▶ 3D image can be misunderstood as a reality and cause damage to the objects or human.
- ▶ Please prevent children under 5 from watching 3D image. It might hinder development of visual acuity.
- ▶ Warning of photosensitive seizure.

Some people might experience seizure when watching a specific image in the video game, a blinking image or an image with specific pattern. If you or your family have history of epilepsy or seizure, please consult with doctor before watch 3D image. If you feel the following symptoms while watching 3D image, please stop watching right away and take a rest.

- Fuzz feeling, sight change, instability in eye or face, unconscious motion, convulsions, loss of consciousness, confusion, loss of a sense of direction, or nausea. If one or more of these persist, please consult with doctor.

Following precautionary measure might reduce the risk of seizure due to watching 3D image.

- Take 5 to 15 minute rest after an hour of watching.
- Watch it after eyesight correction if each eye has different vision.
- Watch it on the line of eye and at the front side.
- If you feel headache, fatigue, or nausea, please stop watching and take a rest.
- Do not watch for a long time when sleepy, tired or sick.

#### While watching 3D image



#### Caution

- ▶ Please put extra care when children are watching

#### Check these when watching 3D image

- ▶ Please watch the image within effective angle and distance.
- ▶ It might not be seen in 3D if it is out of effective angle or distance. It will not be seen when lay down.
- ▶ There might be more image overlap during initial operation after turning on the power. It needs time for optimization.
- ▶ If you stare other spot and gaze back to 3D image, you might need some time to watch it in 3D.
- ▶ If you watch it under fluorescent light (50Hz ~ 60Hz), trichromatic light, or near a window, there can be blinking of the image. In this case, use curtains to block the sunlight and darken the lighting.
- ▶ Use DLP-LINK(DLP Ready) Type 3D glasses.
- ▶ If there are obstacles between the projector and 3D glasses, 3D image might not be fully appreciated.
- ▶ Please install the projector as far as possible from other devices.

To watch 3D image

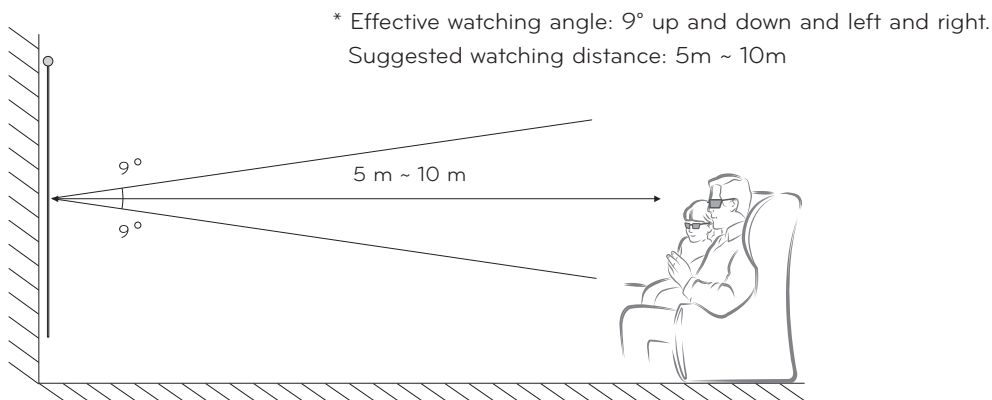

\* 3D watching condition is based on a darkroom

**Note!**

- Some menu might not work while watching 3D image
- Choose correct and supported 3D image format to fully enjoy 3D image.

**How to use DLP-LINK(DLP-Ready) Type 3D glasses**

- While watching 3D image from the projector, press a button on the glasses.
- When it is pressed, it will blink and synchronize with 3D image.  
(Blinking is operating method of DLP-LINK Type 3D glasses and it varies by its variety.)
- If it blinks or has other trouble while watching, turn off the light in the room. Please contact seller for questions regarding 3D glasses.

How to watch 3D image

- Play contents produced in 3D image. Please refer the following for 3D image input support format.

	Signal	Resolution	Vertical Frequency(Hz)	Playable 3D video format
HDMI	720p	1280x720	60	HDMI(V1.4 with HDMI 3D) Frame Packing, Side by Side, Top & Bottom, Frame Sequential
			50	HDMI(V1.4 with HDMI 3D) Frame Packing, Side by Side, Top & Bottom
	1080i	1920x1080	50/60	Side by Side, Top & Bottom
	1080p	1920x1080	24/30	HDMI(V1.4 with HDMI 3D) Frame Packing, Side by Side, Top & Bottom
			60	HDMI(V1.4 with HDMI 3D) Frame Packing, Side by Side, Top & Bottom, Frame Sequential
			50	HDMI(V1.4 with HDMI 3D) Frame Packing, Side by Side, Top & Bottom.
HDMI-PC RGB-PC	XGA	1024x768	60	Side by Side, Top & Bottom, Frame Sequential

- To play 3D image input in frame packing format, media contents and player should support HDMI (1.4 version 3D) frame packing format.
- Image input in HDMI (1.4 version 3D) frame packing format is automatically converted into 3D image.

2. **RGB-PC** should press auto correction button on remote controller before watch 3D image. (Please refer "PC connection" on page 17 for HDMI-PC sound output)
3. When watching 3D image with **HDMI-PC** or **RGB-PC**, non 3D part (wall paper, explorer, etc) will be shown in dual phase (overlap phenomenon). So it needs to play the image in "full screen" mode of the video player.

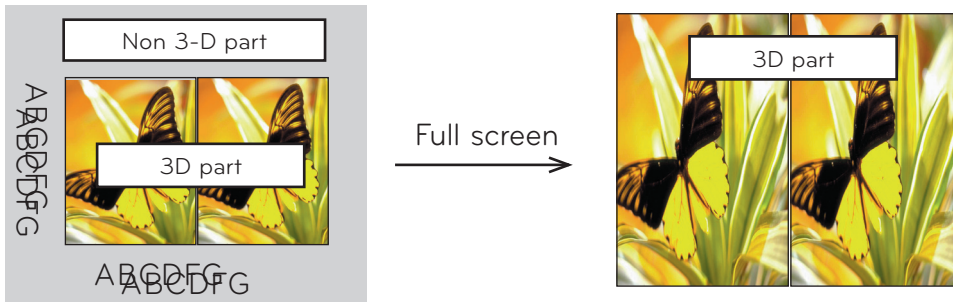

4. Press 3D image button
5. Press <, > button to select same shape on the projector screen and wear the 3D glasses.

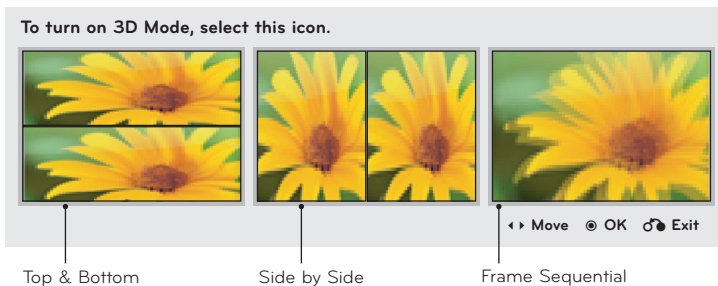

6. While watching 3D image from the projector, press a button on the glasses.
7. You can convert left/right image by pressing **L/R** selection button. Select the image that is seen better.
  - Pressing 3D image button while watching 3D image will convert to image to normal.
8. 3D image only supports 4:3 aspect ratio

< Remote Controller Function only operational in 3D mode >

3D Mode	Top & Bottom	Side by Side	Frame Sequential	Frame Packing
POWER	O	O	O	O
INPUT	X	X	X	O
3D	O	O	O	X
L/R	O	O	O	O
VOL ▲/▼	O	O	O	O
MUTE	O	O	O	O
USB	X	X	X	X
PAGE ▲/▼	X	X	X	X
RATIO	X	X	X	X
MENU	X	X	X	X
AUTO	X	X	X	X
Q.MENU	X	X	X	X
MARK	X	X	X	X
SLEEP	X	X	X	X
BACK	O	O	O	O
STILL	X	X	X	X
KEystone	X	X	X	X
ZOOM	X	X	X	X
TIMER	X	X	X	X



# Function

\* The On-Screen Display (OSD) in this manual may be slightly different from your projector.

\* This operating guide explains operation of RGB(PC) mode mainly.

## PICTURE Menu Options

### Picture mode

\* Use the Picture mode function to set the projector for the best picture appearance.

1. Press the **Q.MENU** button on the remote control.
2. Press the **<**, **>** buttons to move to **Picture mode**.
3. Press the **^**, **v** button to toggle through the preset picture settings.

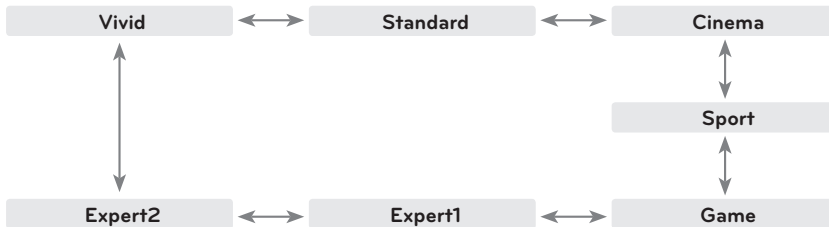

- You can use this function through the **MENU** button.
- Press the **BACK** button to exit the menu screen.

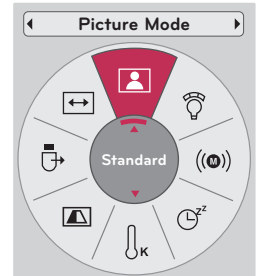

### Adjusting Picture Mode

1. Press the **MENU** button. Then, move to **PICTURE** with the **^**, **v**, **<**, **>** buttons and press the **OK** button.
2. Press the **^**, **v** buttons to move to a desired function and press the **OK** button.
3. Press the **<**, **>** buttons to make a desired adjustment and then press the **OK** button.

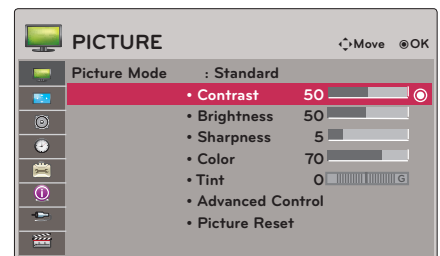

- You can set image values differently for each input and **Picture Mode**.
- Saving after making adjustments will display **(User)** in adjusted **Picture Mode**. (except **Expert 1/2**)
- Execute **Picture Reset** for **Picture Mode** to restore back to default factory settings.
- Press the **BACK** button to exit the menu screen.

## Advanced Control Function

1. Press the **MENU** button. Then, move to **PICTURE** with the  $\wedge$ ,  $\vee$ ,  $\lt$ ,  $\gt$  buttons and press the **OK** button.
2. Press the  $\wedge$ ,  $\vee$  buttons to move to **Advanced Control** and press the **OK** button.
3. Move to a desired item with the  $\wedge$ ,  $\vee$  buttons.
4. Press the  $\lt$ ,  $\gt$  buttons to make a desired adjustment and then press the **OK** button.

- You can set image values differently for each input and **Picture Mode**.
- Execute **Picture Reset** for **Picture Mode** to restore back to default factory settings.
- Press the **BACK** button to exit the menu screen.

< When **Picture Mode** is **Vivid/Standard/Cinema/Sport/Game** >

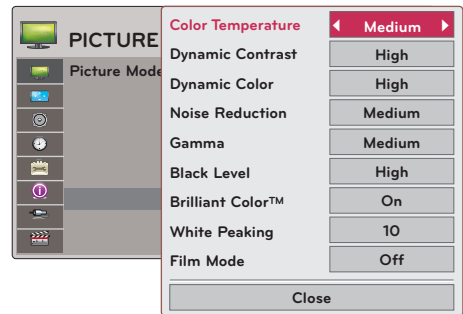

< When **Picture Mode** is **Expert 1/2** >

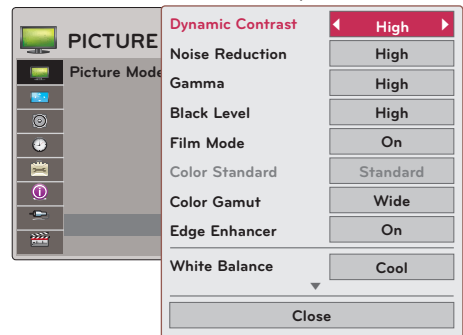

Color Temperature	<ul style="list-style-type: none"> <li>- This function enables <b>Vivid/Standard/Cinema/Sport/Game</b>.</li> <li>• Set to warm to enhance hotter colors such as red, or set to cool to make picture bluish.</li> </ul>
Dynamic Contrast	<ul style="list-style-type: none"> <li>• Adjusts the contrast to keep it at the best level according to the brightness of the screen. The picture is improved by making bright parts brighter and dark parts darker.</li> </ul>
Dynamic Color	<ul style="list-style-type: none"> <li>- This function enables <b>Vivid/Standard/Cinema/Sport/Game</b>.</li> <li>• Adjusts screen colors so that they look livelier, richer and clearer. This feature enhances hue, saturation and luminance so that red, blue, green and white look more vivid.</li> </ul>
Noise Reduction	<ul style="list-style-type: none"> <li>• Reduces screen noise without compromising video quality.</li> </ul>
Gamma	<ul style="list-style-type: none"> <li><b>Low</b> : Make dark and middle gray level area of the picture brighter.</li> <li><b>Medium</b>: Express original picture levels.</li> <li><b>High</b>: Make dark and middle gray level area of the picture darker.</li> <li>• You can adjust brightness of dark area and middle gray level area of the picture.</li> </ul>
Black Level	<ul style="list-style-type: none"> <li><b>Low</b>: The reflection of the screen gets darker.</li> <li><b>High</b>: The reflection of the screen gets brighter.</li> <li>• Set black level of the screen to proper level.</li> <li>• This feather is disables in <b>RGB</b> mode.</li> </ul>
Brilliant Color™	<ul style="list-style-type: none"> <li>This function increases the entire brightness of the screen or decreases it a little to make the rich grayscale color.</li> </ul>
White peaking	<ul style="list-style-type: none"> <li>- The default value may change depending on input mode.</li> <li>- White peaking can be adjusted from 0 to 10.</li> <li>- Adjust to higher setting to achieve brighter picture. Adjust to lower setting for darker picture.</li> </ul>
Film Mode	<ul style="list-style-type: none"> <li>• Makes video clips recorded in film look more natural by eliminating judger effect.</li> <li>• DVD and Blu-ray movies are filmed at 24 frames per second.</li> </ul>

Color Gamut	<p><b>Standard:</b> Displays standard color area.</p> <p><b>Wide:</b> Mode to use and set the rich color area of the display.</p> <ul style="list-style-type: none"> <li>Maximize the utilization of color to increase color quality.</li> </ul>
Edge Enhancer	<ul style="list-style-type: none"> <li>Show clearer and distinctive yet natural corners of the video.</li> </ul>
Color Standard	<ul style="list-style-type: none"> <li>Convert the color of a different video to HD color.</li> </ul>
White Balance	<ul style="list-style-type: none"> <li>This function enables <b>Expert 1/2</b>.</li> <li>This is the function to adjust the overall color of the screen to the feeling you want. <ul style="list-style-type: none"> <li><b>Method : 2 Points</b> <ul style="list-style-type: none"> <li><b>Pattern: Inner, Outer</b></li> <li><b>Red/Green/Blue Contrast, Red/Green/Blue Brightness:</b> The adjustment range is <b>-50 ~ +50</b>.</li> </ul> </li> <li><b>Method : 20 Points IRE</b> <ul style="list-style-type: none"> <li><b>Pattern: Inner, Outer</b></li> <li><b>IRE</b> (Institute of Radio Engineers) is the unit to display the size of the video signal and can be set among <b>5, 10, 15 - 95, 100</b>. You can adjust <b>Red, Green</b> or <b>Blue</b> according to each setting.</li> <li><b>Red/Green/Blue:</b> The adjustment range is <b>-50 - +50</b>.</li> </ul> </li> </ul> </li> </ul>
Color Management System	<ul style="list-style-type: none"> <li>This function enables <b>Expert 1/2</b>.</li> <li>As the tool used by the experts to make adjustments by using the test patterns, this does not affect other colors but can be used to selectively adjust the 6 color areas (Red/Green/Blue/Cyan/Mgt/Yellow).</li> </ul> <p>Color difference may not be distinctive even when you make the adjustments for the general video.</p> <p>Adjusts Red/Green/Blue/Yellow/Cyan, Magenta.</p> <ul style="list-style-type: none"> <li><b>Red/Green/Blue/Yellow/Cyan, Magenta Color:</b> The adjustment range is <b>-30 ~ +30</b>.</li> <li><b>Red/Green/Blue/Yellow/Cyan, Magenta Tint:</b> The adjustment range is <b>-30 ~ +30</b>.</li> <li>This feature is disable in PC mode.</li> </ul>

### Color Temperature Function

- Press the **Q.MENU** button on the remote control.
- Press the **<, >** buttons to move to **Color Temperature**.
- Press the **^, v** button to toggle through the preset picture settings.



- This function enables **Vivid/Standard/Cinema/Sport/Game**.
- You can use this function through the **MENU** button.
- Press the **BACK** button to exit the menu screen.

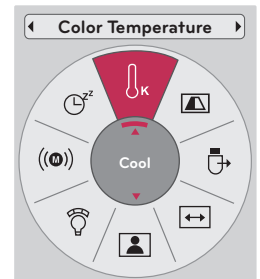

### Picture Reset Function

\* Settings of the selected **PICTURE** function for each input and **Picture Mode** return to the default factory settings.

- Press the **MENU** button. Then, move to **PICTURE** with the **^, v, <, >** buttons and press the **OK** button.
- Press the **^, v** buttons to move to **Picture Reset** and press the **OK** button.
- Press the **<, >** buttons to move to **Yes** and press the **OK** button.

- Press the **BACK** button to exit the menu screen.

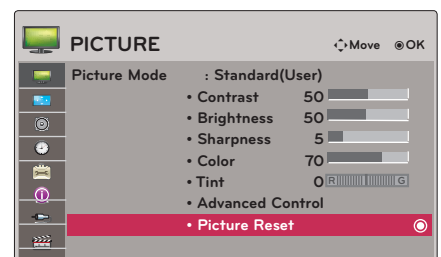

## SCREEN Menu Options

### To Change PJT Mode

\* This function turns the projected image upside down or flips horizontal.

1. Press the **Q.MENU** button on the remote control.
2. Press the **<**, **>** buttons to move to **PJT Mode**.
3. Press the **^**, **v** button to select a desired item.

- Select **Rear** when projecting from the back of the transparent screen purchased separately.
- Select **Ceiling** when installing the product on the ceiling.
- When **PJT Mode** is **Rear/Ceiling**, the left/right of the speaker changes automatically.
- You can use this function through the **MENU** button.
- Press the **BACK** button to exit the menu screen.

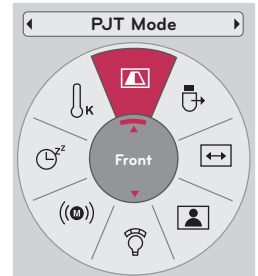

### Using Aspect Ratio Function

Press the **RATIO** button to select a desired screen size.

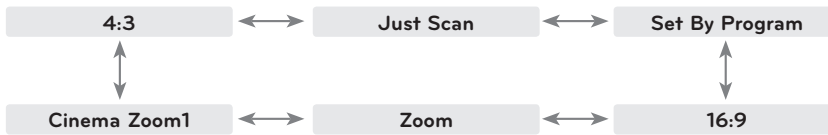

- Some options may not be available depending on input signals.
- You can use this function through the **MENU** button.
- Press the **BACK** button to exit the menu screen.

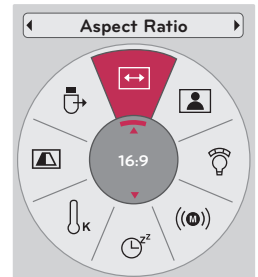

### Using Keystone Function

\* Use this function when the screen is not at a right angle to the projector and the image is a trapezoid shape.

\* Only use the **Keystone** function when you can't get the best angle of projection.

1. Press the **KEYSTONE** button of remote control.
2. Press the **<**, **>** button to adjust the screen condition as you want.

- **Keystone** can be adjusted from **-40** to **40**.
- You can use this function through the **MENU** button.
- Press the **BACK** button to exit the menu screen.

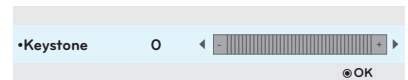

### Auto Configure Function

\* This function assures you of getting the best video quality by automatically adjusting the horizontal size and synchronization of the image.

\* Auto configure function works in RGB PC input only.

Press the **AUTO** button of the remote control.

- If you execute screen adjustment for a video from PC graphic signal, optimal state may not be found. Execute the **Auto Config.** function for a still image.
- You can use this function through the **MENU** button.

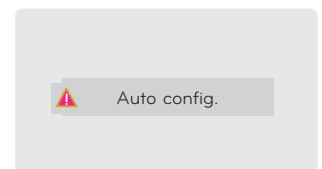

## RGB Config. Function

1. Press the **MENU** button. Then, move to **SCREEN** with the  $\wedge$ ,  $\vee$ ,  $\lt$ ,  $\gt$  buttons and press the **OK** button.
2. Press the  $\wedge$ ,  $\vee$  buttons to move to **RGB Config.** and press the **OK** button.
3. Move to a desired item with the  $\wedge$ ,  $\vee$  buttons and then press the  $\gt$  button.
4. Press the  $\wedge$ ,  $\vee$ ,  $\lt$ ,  $\gt$  button to adjust the screen condition as you want and then press the **OK** button.

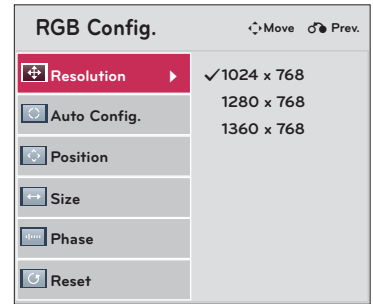

- **Resolution** can be chosen between 768 resolution (1024x768/1280x768/1360x768, 60Hz) and 1050 resolution (1400x1050/1600x1050, 60Hz).
- Press the **BACK** button to exit the menu screen.

## Using Digital Zoom Function

\* This function is available only in RGB input mode. The Zoom -/+ and Position values return to their defaults when you change the SOURCE or input signal, or turn the power off.

### Adjusting the Zoom

1. Press the **ZOOM** button on the remote control.
2. Press the  $\wedge$ ,  $\vee$  button to select **Zoom** item.
3. Press the  $\lt$ ,  $\gt$  button to adjust **Zoom** to your choice.
  - You can adjust Zoom -/+ in 5% increments from 100% to 250%.
  - Press the **BACK** button to exit the menu screen.

### Adjusting the Position

1. Press the **ZOOM** button on the remote control.
2. Press the  $\wedge$ ,  $\vee$  button to select **Position** item.
3. Press the **OK** button. When the window below appears at the bottom right corner of the screen, press the  $\wedge$ ,  $\vee$ ,  $\lt$ ,  $\gt$  to adjust the position. When the arrow turns black, maximum adjustment has been reached and no further adjustment can be made.
  - **Position** is activated only when **Zoom** is set to more than 105%. Press the **BACK** button to exit the menu screen.

## Using the Still Function

1. Press the **STILL** button on the remote control.
  - \* You can freeze the moving image.



< Moving Image >



< Still Image >

2. To exit STILL, press any button.
  - \* The STILL function will release automatically after approximately 10 minutes.

## AUDIO Menu Options

### Adjusting Volume

Press the **VOLUME**  $\wedge$ ,  $\vee$  button on the remote control.

### Function Audio

1. Press the **Q.MENU** button on the remote control.
2. Press the  $\leftarrow$ ,  $\rightarrow$  buttons to move to **Audio**.
3. Press the  $\wedge$ ,  $\vee$  button to select a desired item.



- This function enables if connected a headphone.
- Press the **BACK** button to exit the menu screen.



### Adjusting Speaker Balance

\* Adjust the left/right sound of speaker to suit your taste and room situations.

1. Press the **MENU** button. Then, move to **AUDIO** with the  $\wedge$ ,  $\vee$ ,  $\leftarrow$ ,  $\rightarrow$  buttons and press the **OK** button.
2. Press the  $\wedge$ ,  $\vee$  buttons to move to **Balance** and press the **OK** button.
3. Press the  $\leftarrow$ ,  $\rightarrow$  buttons to adjusting audio balance and press the **OK** button.

- Press the **BACK** button to exit the menu screen.

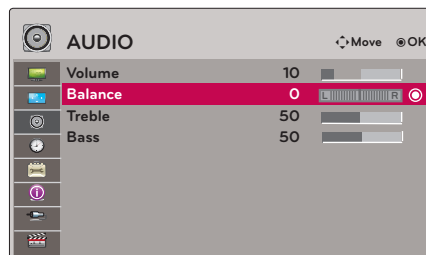

### Adjusting Treble

\* Adjust the treble your taste and room situations.

1. Press the **MENU** button. Then, move to **AUDIO** with the  $\wedge$ ,  $\vee$ ,  $\leftarrow$ ,  $\rightarrow$  buttons and press the **OK** button.
2. Press the  $\wedge$ ,  $\vee$  buttons to move to **Treble** and press the **OK** button.
3. Press the  $\leftarrow$ ,  $\rightarrow$  buttons to adjusting audio treble and press the **OK** button.

- Press the **BACK** button to exit the menu screen.

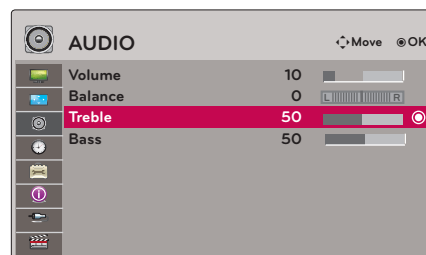

### Adjusting Bass

\* Adjust the treble your taste and room situations.

1. Press the **MENU** button. Then, move to **AUDIO** with the  $\wedge$ ,  $\vee$ ,  $\leftarrow$ ,  $\rightarrow$  buttons and press the **OK** button.
2. Press the  $\wedge$ ,  $\vee$  buttons to move to **Bass** and press the **OK** button.
3. Press the  $\leftarrow$ ,  $\rightarrow$  buttons to adjusting audio treble and press the **OK** button.

- Press the **BACK** button to exit the menu screen.

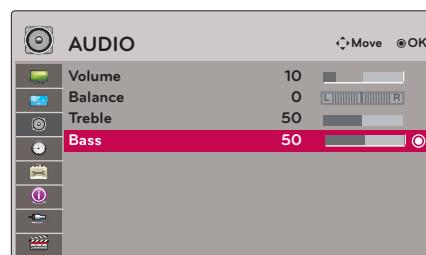

## TIME Menu Options

### Sleep time Function

\* The sleep timer turns the projector off at the preset time.

1. Press the **Q.MENU** button on the remote control.
2. Press the **<**, **>** buttons to move to **Sleep Timer**.
3. Press the **^**, **v** buttons to select a desired preset time.

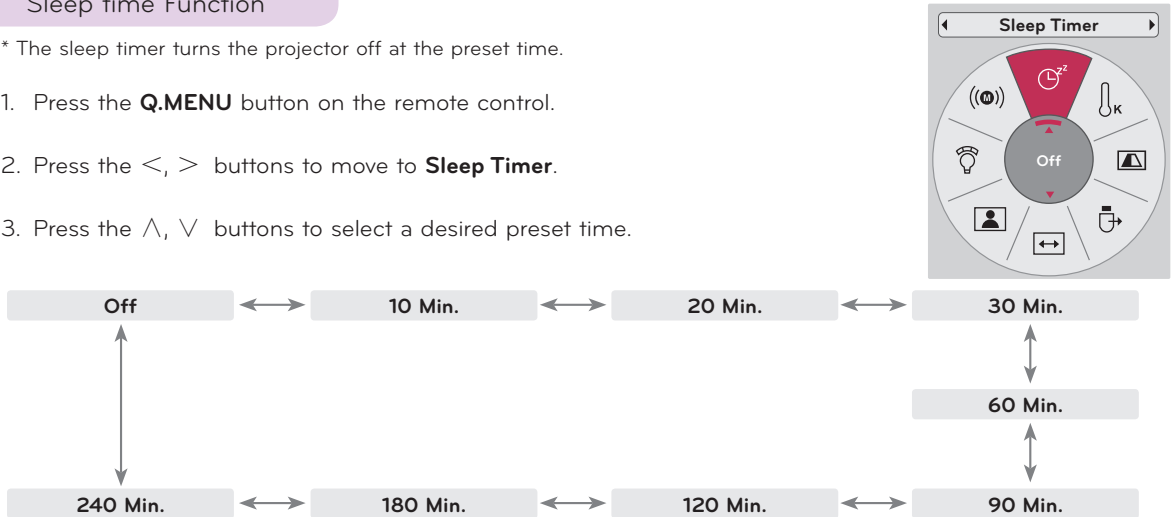

- You can use this function through the **MENU** button.
- Press the **BACK** button to exit the menu screen.

### Auto Off Function

\* This function turns the projector off automatically after the preset time is passed when there is no signal.

1. Press the **MENU** button. Then, move to **TIME** with the **^**, **v**, **<**, **>** buttons and press the **OK** button.
2. Press the **^**, **v** buttons to move to **Auto Off** and press the **OK** button.
3. Move to a desired item with the **^**, **v** buttons and then press the **OK** button.

- Press the **BACK** button to exit the menu screen.

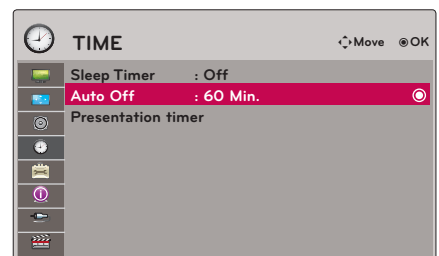

### Presentation timer Function

1. Press the **TIMER** button of remote control.
2. Press the  $\wedge$ ,  $\vee$  button to select **Time alarm** or **Time keeper** item.
3. Press the  $<$ ,  $>$  button to select the desired preset time.
4. The timer starts to operate if you select specific time.
  - Time alarm function : If you select a specific time, it is displayed in minute units. After 1 minute, the remaining time is displayed at the bottom right of the screen, and then disappears after 5 seconds. When the remaining time is displayed, other OSD windows are closed. When the set time is reached, '0 minute' flickers 10 times at 1 second intervals, and then disappears.
  - Time keeper function : If you select a specific time, it continues to be displayed in minute(') and second(") units. Even though other OSD windows appear, the remaining time is displayed again after the windows are closed. When the set time is reached, '0' 00" flickers 10 times at 1 second intervals, and then disappears.
5. If the set time disappears because of the use of other menus, press the **TIMER** button on a remote to display the set time again.
  - The Time alarm function and the Time keeper function cannot be used at the same time.
  - The Time alarm function can be set from 5 to 60 minutes at 5 minute intervals (Off, 5, 10, 15, 20, .....55, 60 minutes).
  - The Time keeper function can be set from 1 to 10 minutes at 1 minute intervals, and from 10 to 60 minutes at 5 minute intervals (Off, 1, 2, 3, 4, .....8, 9, 10, 15, 20, 25, .....55, 60 minutes).
  - Press the **BACK** button to exit the menu screen.

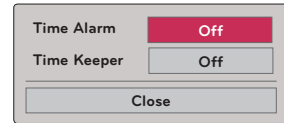



## OPTION Menu Options

### Selecting Language

1. Press the **MENU** button. Then, move to **OPTION** with the  $\wedge$ ,  $\vee$ ,  $<$ ,  $>$  buttons and press the **OK** button.
2. Press the  $\wedge$ ,  $\vee$  buttons to move to **Menu Language** and press the **OK** button.
3. Move to a desired item with the  $\wedge$ ,  $\vee$ ,  $<$ ,  $>$  buttons and then press the **OK** button.
  - On-Screen-Display (OSD) is displayed in the selected language.
  - Press the **BACK** button to exit the menu screen.

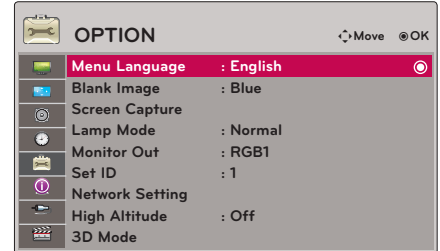

### Using Blank Function

\* This function may be effective if you need to get the attention of the audience during presentations, meetings or briefings.

1. Press the **BLANK** button on the remote control.
  - The screen turns off to a background color.
  - You can choose the background color. (Refer to 'Selecting Blank image')
2. Press any button to cancel the blank function.
  - To temporarily turn off the lamp, press **BLANK** on the remote control. Do not block the projection lens with any objects when the projector is under operation as this could cause the objects to become heated and deformed or even cause a fire.

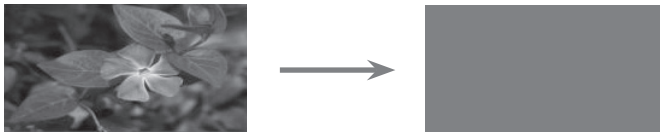

### Selecting Blank image

1. Press the **MENU** button. Then, move to **OPTION** with the  $\wedge$ ,  $\vee$ ,  $<$ ,  $>$  buttons and press the **OK** button.
2. Press the  $\wedge$ ,  $\vee$  buttons to move to **Blank Image** and press the **OK** button.
3. Move to a desired item with the  $\wedge$ ,  $\vee$  buttons and then press the **OK** button.
  - Background image will be altered to the selected Blank function image.
  - If there is no Screen Captured, selecting **Captured Image** will display the Logo.
  - Press the **BACK** button to exit the menu screen.

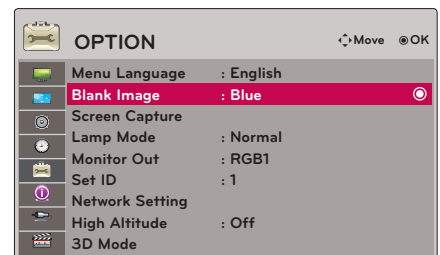

## Screen Capture Function

1. Press the **MENU** button. Then, move to **OPTION** with the  $\wedge$ ,  $\vee$ ,  $<$ ,  $>$  buttons and press the **OK** button.
2. Press the  $\wedge$ ,  $\vee$  buttons to move to **Screen Capture** and press the **OK** button.
  - It can only be elected when there is an input signal.
  - It takes up to 2 minutes when capturing screen.
  - Press the **BACK** button to exit the menu screen.

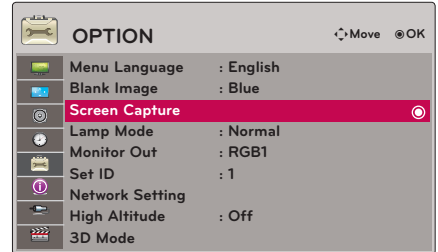

## To adjust the brightness of the screen

1. Press the **Q.MENU** button on the remote control.
2. Press the  $<$ ,  $>$  buttons to move to **Lamp mode**.
3. Press the  $<$ ,  $>$  button to select **Normal** or **Economic**.
  - This function is not available in 3D mode or when the lamp is over 35°C.
  - You can use this function through the **MENU** button.
  - Press the **BACK** button to exit the menu screen.

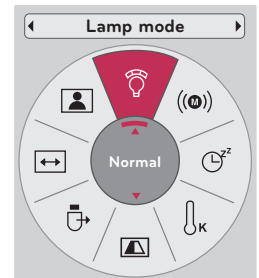

## Using Monitor out Function

\* You can select either of the two RGB inputs.

1. Press the **MENU** button. Then, move to **OPTION** with the  $\wedge$ ,  $\vee$ ,  $<$ ,  $>$  buttons and press the **OK** button.
2. Press the  $\wedge$ ,  $\vee$  buttons to move to **Monitor Out** and press the **OK** button.
3. Press the  $<$ ,  $>$  button to select **RGB1**, **RGB2** or **Auto**.
  - **Auto** mode is the mode to output an image of currently seeing input among **RGB1** or **RGB2** input.
  - Press the **BACK** button to exit the menu screen.

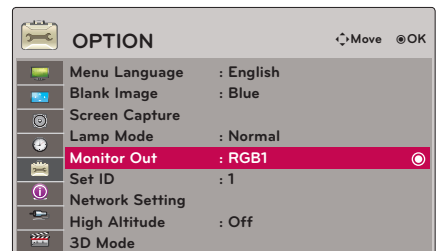

## SET ID

1. Press the **MENU** button. Then, move to **OPTION** with the  $\wedge$ ,  $\vee$ ,  $\leftarrow$ ,  $\rightarrow$  buttons and press the **OK** button.
2. Press the  $\wedge$ ,  $\vee$  buttons to move to **Set ID** and press the **OK** button.
3. Press the  $\leftarrow$ ,  $\rightarrow$  button to select your desired number. Press the **OK** button to save the selected number.

- The adjustment range of **Set ID** is 1-99.
- Only the projector with the specified ID number will operate from the remote control.
- Press the **BACK** button to exit the menu screen.

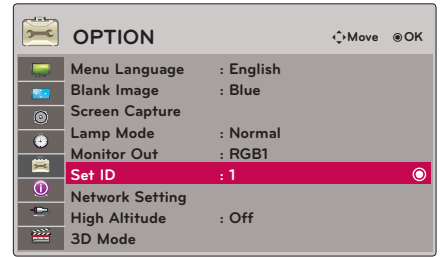

## How to connect external control equipment

- \* Connect the serial port of the PC to the RS-232C jack on the projector back panel.
- \* RS-232C cable is not supplied with the projector.

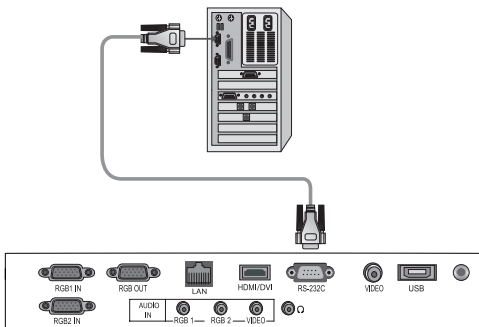

- \* Use the RS232C cable to control the projector externally (Refer to Fig.1).

<Fig.1, RS-232 Interface Cable>

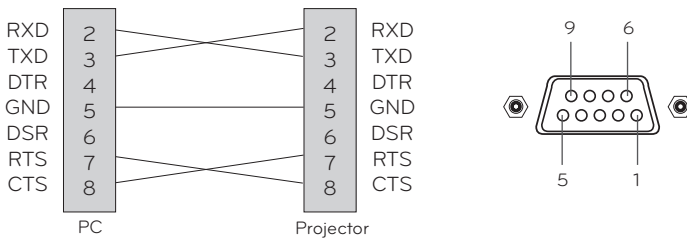

\* 1, 9 Pin No Connection

## Communication Parameter Setup

- Baud Rate : 9600bps(UART)
- Data Length : 8bit
- Parity : none
- Stop bit : 1bit
- Flow Control : none
- Communication code : ASCII code

## Command Reference List

	Command 1	Command 2	Data (Hexadecimal)	Real data mapping
01.Power	k	a	0 ~ 1	-
02.Aspect Ratio	k	c	*	-
03.Blank Image	k	d	0 ~ 1	-
04.Contrast	k	g	0 ~ 64	1
05.Brightness	k	h	0 ~ 64	1
06.Color	k	i	0 ~ 64	1
07.Tint	k	j	0 ~ 64	2
08.Sharpness	k	k	0 ~ 64	1
09.OSD Select	k	l	0 ~ 1	-
10.Remote Control Lock / Key Lock	k	m	0 ~ 1	-
11.Color Temp.	k	u	0 ~ 3	-
12.Lamp Mode	n	p	0 ~ 1	-
13.Auto Configure	j	u	1	-
14.Input Select	x	b	*	-
15.Key	m	c	Key code	-

- Refer to the detailed information for data with [\*] mark.

## Communication Protocol

\* Real data mapping 1

Decimal	Hexadecimal	Decimal	Hexadecimal	Decimal	Hexadecimal	Decimal	Hexadecimal	Decimal	Hexadecimal
0	0	21	15	41	29	61	3d	81	51
1	1	22	16	42	2a	62	3e	82	52
2	2	23	17	43	2b	63	3f	83	53
3	3	24	18	44	2c	64	40	84	54
4	4	25	19	45	2d	65	41	85	55
5	5	26	1a	46	2e	66	42	86	56
6	6	27	1b	47	2f	67	43	87	57
7	7	28	1c	48	30	68	44	88	58
8	8	29	1d	49	31	69	45	89	59
9	9	30	1e	50	32	70	46	90	5a
10	a	31	1f	51	33	71	47	91	5b
11	b	32	20	52	34	72	48	92	5c
12	c	33	21	53	35	73	49	93	5d
13	d	34	22	54	36	74	4a	94	5e
14	e	35	23	55	37	75	4b	95	5f
15	f	36	24	56	38	76	4c	96	60
16	10	37	25	57	39	77	4d	97	61
17	11	38	26	58	3a	78	4e	98	62
18	12	39	27	59	3b	79	4f	99	63
19	13	40	28	60	3c	80	50	100	64
20	14								

\* Real data mapping 1

Decimal	Hexadecimal	Decimal	Hexadecimal	Decimal	Hexadecimal	Decimal	Hexadecimal	Decimal	Hexadecimal
-50	0	15	-9	29	11	3d	31	51	
-49	1	16	-8	2a	12	3e	32	52	
-48	2	17	-7	2b	13	3f	33	53	
-47	3	18	-6	2c	14	40	34	54	
-46	4	19	-5	2d	15	41	35	55	
-45	5	20	-4	2e	16	42	36	56	
-44	6	21	-3	2f	17	43	37	57	
-43	7	22	-2	30	18	44	38	58	
-42	8	23	-1	31	19	45	39	59	
-41	9	24	0	32	20	46	40	5a	
-40	a	25	1	33	21	47	41	5b	
-39	b	26	2	34	22	48	42	5c	
-38	c	27	3	35	23	49	43	5d	
-37	d	28	4	36	24	4a	44	5e	
-36	e	29	5	37	25	4b	45	5f	
-35	f	30	6	38	26	4c	46	60	
-34	10	31	7	39	27	4d	47	61	
-33	11	32	8	3a	28	4e	48	62	
-32	12	33	9	3b	29	4f	49	63	
-31	13	34	10	3c	30	50	50	64	
-30	14								

### 1. Transmission

```
[Command1][Command2][Set ID][Data][Cr]
```

- \* [Command 1] : First command to control the set.(k, j, x, ASCII code, 1 Character)
- \* [Command 2] : Second command to control the set.(ASCII code, 1 Character)
- \* [Set ID] : You can adjust the set ID to choose desired projector ID number in special menu. See previous page.  
Adjustment range is 1 ~ 99. When selecting Set ID '0', every connected projector set is controlled.  
Refer to 'Real data mapping 1'!
- \* [DATA] : To transmit command data. Transmit 2 character when organized ASCII code.  
\* Transmit 'FF' data to read status of command.
- \* [Cr] : Carriage Return  
ASCII code '0x0D'
- \* [ ] : ASCII code character correspond to "Space Bar" which is in order to classify command, set ID and Data.

### 2. OK Acknowledgement

```
[Command2][Set ID][OK][Data][x]
```

- \* The Projector transmits ACK (acknowledgement) based on this format when receiving normal data. At this time, if the data is data read mode, it indicates present status data. If the data is data write mode, it returns the data of the PC computer.

### 3. Error Acknowledgement

```
[Command2][Set ID][NG][Data][x]
```

- \* The Projector transmits ACK (acknowledgement) based on this format when receiving abnormal data from non-viable functions or communication errors.

Data : [1] : illegal code(This command is not supported.)  
[2] : not support function(This function doesn't work.)  
[3] : wait and retry(Try again a few minute later.)

## 01. Power (Command:ka)

→ To control Power On/Off of the Projector.

### Transmission

```
[k][a][Set ID][Data][Cr]
```

Data 0 : Power Off  
1 : Power On

### Ack

```
[a][Set ID][OK][Data][x]
```

Data 0 : Power Off  
1 : Power On

→ To show Power On/Off status.

### Transmission

```
[k][a][Set ID][FF][Cr]
```

### Ack

```
[a][Set ID][OK][Data][x]
```

Data 0 : Power Off  
1 : Power On

\* In like manner, if other functions transmit '0xFF' data based on this format, Acknowledgement data feed back presents status about each function.

## 02. Aspect Ratio (Command:kc)

→ To adjust the screen format.

### Transmission

```
[k][c][Set ID][Data][Cr]
```

Data 1 : 4:3	2 : 16:9
4 : Zoom	6 : Set by Program
9: Just Scan	10: Cinema Zoom1
11: Cinema Zoom2	12: Cinema Zoom3
13: Cinema Zoom4	14: Cinema Zoom5
15: Cinema Zoom6	16: Cinema Zoom7
17: Cinema Zoom8	18: Cinema Zoom9
19: Cinema Zoom10	1A: Cinema Zoom11
1B: Cinema Zoom12	1C: Cinema Zoom13
1D: Cinema Zoom14	1E: Cinema Zoom15
1F: Cinema Zoom16	

### Ack

```
[c][Set ID][OK][Data][x]
```

Data 1 : 4:3	2 : 16:9
4 : Zoom	6 : Set by Program
9: Just Scan	10: Cinema Zoom1
11: Cinema Zoom2	12: Cinema Zoom3
13: Cinema Zoom4	14: Cinema Zoom5
15: Cinema Zoom6	16: Cinema Zoom7
17: Cinema Zoom8	18: Cinema Zoom9
19: Cinema Zoom10	1A: Cinema Zoom11
1B: Cinema Zoom12	1C: Cinema Zoom13
1D: Cinema Zoom14	1E: Cinema Zoom15
1F: Cinema Zoom16	

**03. Screen Mute (Command:kd)**

→ To select screen mute on/off.

Transmission

[k] [d] [ ] [Set ID] [ ] [Data] [Cr]

Data 0 : Screen Mute Off (Picture On)  
1 : Screen Mute On (Picture Off)

Ack

[d] [ ] [Set ID] [ ] [OK] [Data] [x]

Data 0 : Screen Mute Off (Picture On)  
1 : Screen Mute On (Picture Off)

**04. Contrast (Command:kg)**

→ To adjust screen contrast.

Transmission

[k] [g] [ ] [Set ID] [ ] [Data] [Cr]

Data Min : 0 ~ Max : 64

Ack

[g] [ ] [Set ID] [ ] [OK] [Data] [x]

Data Min : 0 ~ Max : 64

\* Refer to 'Real data mapping 1!'

**05. Brightness (Command:kh)**

→ To adjust screen brightness.

Transmission

[k] [h] [ ] [Set ID] [ ] [Data] [Cr]

Data Min : 0 ~ Max : 64

Ack

[h] [ ] [Set ID] [ ] [OK] [Data] [x]

Data Min : 0 ~ Max : 64

\* Refer to 'Real data mapping 1!'

**06. Color (Command:ki)**

→ To adjust the screen color. (Video/Component)

Transmission

[k] [i] [ ] [Set ID] [ ] [Data] [Cr]

Data Min : 0 ~ Max : 64

Ack

[i] [ ] [Set ID] [ ] [OK] [Data] [x]

Data Min : 0 ~ Max : 64

\* Refer to 'Real data mapping 1!'

**07. Tint (Command:kj)**

→ To adjust the screen tint.(Video/Component 60Hz or NTSC signal)

Transmission

[k] [j] [ ] [Set ID] [ ] [Data] [Cr]

Data Red : 0 ~ Green : 64

Ack

[j] [ ] [Set ID] [ ] [OK] [Data] [x]

Data Red : 0 ~ Green : 64

\* Refer to 'Real data mapping 1!'

**08. Sharpness (Command:kk)**

→ To adjust the screen sharpness.(Video/Component)

Transmission

[k] [k] [ ] [Set ID] [ ] [Data] [Cr]

Data Min : 0 ~ Max : 64

Ack

[k] [ ] [Set ID] [ ] [OK] [Data] [x]

Data Min : 0 ~ Max : 64

\* Refer to 'Real data mapping 1!'

**09. OSD Select (Command:kl)**

→ To select OSD On/Off.

Transmission

[k] [l] [ ] [Set ID] [ ] [Data] [Cr]

Data 0 : OSD Select Mode Off  
1 : OSD Select Mode On

Ack

[l] [ ] [Set ID] [ ] [OK] [Data] [x]

Data 0 : OSD Select Mode Off  
1 : OSD Select Mode On

**10. Remote Control Lock/Key Lock (Command:km)**

→ To lock the front panel controls on the projector and remote control.

Transmission

[k] [m] [ ] [Set ID] [ ] [Data] [Cr]

Data 0 : Lock Off  
1 : Lock On

Ack

[m] [ ] [Set ID] [ ] [OK] [Data] [x]

Data 0 : Lock Off  
1 : Lock On

\* If you're not using the remote control, use this mode.  
When main power is On/Off, external control lock is released.

**11. Color Temperature (Command:ku)**

→ Adjust the color temperature. But, color temperature cannot be adjusted if video mode is set to bright or golf.

Transmission

[k] [u] [ ] [Set ID] [ ] [Data] [Cr]

Data 0 : Normal 1 : Cool 2:Warm 4 : Natural

Ack

[u] [ ] [Set ID] [ ] [OK] [Data] [x]

Data 0 : Normal 1 : Cool 2:Warm 4 : Natural

**12. Lamp Mode (Command:np)**

→ To reduce the power consumption of the projector.

Transmission

[n] [p] [ ] [Set ID] [ ] [Data] [Cr]

Data 0 : Low Power Off  
1 : Low Power On

Ack

[p] [ ] [Set ID] [ ] [OK] [Data] [x]

Data 0 : Low Power Off  
1 : Low Power On

**13. Auto Configure (Command:ju)**

→ To adjust picture position and minimize image shaking automatically. It works only in RGB mode.

Transmission

[j] [u] [ ] [Set ID] [ ] [Data] [Cr]

Data 1: To set

Ack

[u] [ ] [Set ID] [ ] [OK] [Data] [x]

Data 1: To set

**14. Input Select (Command:xb)**

→ To select input source for the Set.

Transmission

[x] [b] [ ] [Set ID] [ ] [Data] [Cr]

Data 20 : Video	40 : Component1
41 : Component2	60 : RGB1
61 : RGB2	90 : HDMI

Ack

[b] [ ] [Set ID] [ ] [OK] [Data] [x]

Data 20 : Video	40 : Component1
41 : Component2	60 : RGB1
61 : RGB2	90 : HDMI

## 15.Key (Command:mc)

→ To send Key code of IR remote control.

### Transmission

[m] [c] [ ] [Set ID] [ ] [Data] [Cr]

Data    Key code

### Ack

[c] [ ] [Set ID] [ ] [OK] [Data] [x]

POWER	AD
INPUT	EF
3D	DC
L/R	DD
∧	40
∨	41
>	06
<	07
● OK	44
VOL ∧	02
VOL ∨	03
MUTE	09
USB	7C
PAGE ∧	00
PAGE ∨	01
RATIO	79
MENU	43
AUTO	92
Q.MENU	45
MARK	1E
SLEEP	0E
BACK	28
STILL	BC
KEYSTONE	A4
ZOOM	5C
TIMER	26
BLANK	84



## Network Setup

### < NOTICE >

- Use a standard LAN cable with this Projector. Cat5 or better with a RJ45 connector.
- Many network connection problems during set up can often be fixed by re-setting the router or modem. After connecting the player to the home network, quickly power off and/or disconnect the power cable of the home network router or cable modem. Then power on and/or connect the power cable again.
- A 10 Base-T or 100 Base-TX LAN port is required for connection to this Projector. If your internet service does not allow for such a connection, you will not be able to connect the Projector.
- To connect to the wireless router, a router that supports wireless connection is necessary, and the wireless connection function of the corresponding router must be activated.
- To connect to a wireless router, verify the SSID and security setting of the wireless router. Please refer to the user guide of the corresponding router for SSID and security setting of the wireless router.
- When Ad-hoc is used, it may not be able to connect according to the device (for example : notebook computer) that is connected.
- The connection method may vary according to the manufacturer of the wireless router.

### < How to connect >

Connect the **LAN** of the projector and the LAN port of the PC or network with a LAN cable (Cross cable).

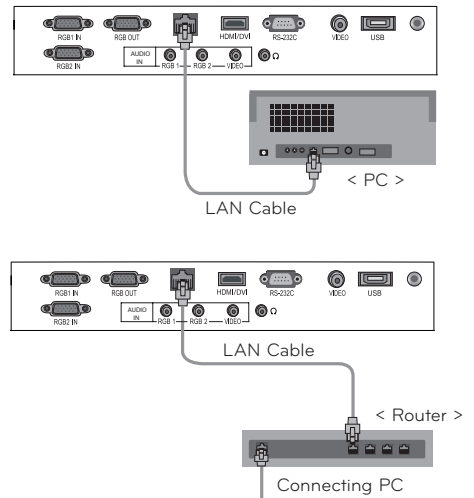

< How to use >

1. Press the **MENU** button. Then, move to **OPTION** with the  $\wedge$ ,  $\vee$ ,  $<$ ,  $>$  buttons and press the **OK** button.
2. Press the  $\wedge$ ,  $\vee$  buttons to move to **Network Setting** and press the **OK** button.
3. Press the  $<$ ,  $>$  buttons to move to **On** of **LAN** option.
4. Press the  $\wedge$ ,  $\vee$  buttons to move to **IP Auto Setting** or **IP Manual Setting** press the **OK** button.
  - In most cases, you should select Auto. If you are using a router it will automatically set the IP address.
  - Select IP Manual Setting for ordinary PC.
    - Setting PC: Set the Internet Protocol (TCP/IP) of the PC at your own discretion. Setting Projector: Set **IP Address** as the IP Address format of PC, and select **Close** after entering the **Gateway** as the same Gateway of PC. Please refer to eZ-Net Manager Guide for details of network setting.

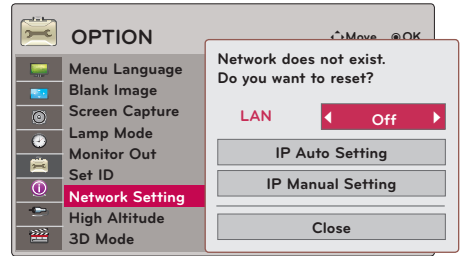

< When select IP Manual Setting >

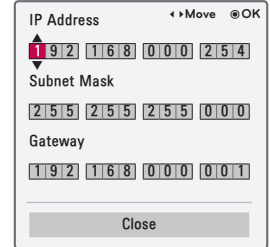

	IP Address	Subnet Mask	Gateway
PC	192.168.0.10	255.255.255.0	192.168.0.1
Projector	192.168.0.254	255.255.255.0	192.168.0.1

- If **Network Setting** is not working, check your network conditions. Check the LAN cable connection.
- If the **Network Setting** is not completed, network functions may not operate normally.
- **IP Auto Setting:** Select it if there is a DHCP (Dynamic Host Configuration Protocol) server on the local area network (LAN) via wired connection, the Projector will automatically be allocated an IP address. The IP address will automatically be determined. Connection to DHCP may not be possible when the fire-wall is installed or according to the model of the computer.
- **IP Manual Setting:** Select it if there is no DHCP server on the network and you want to set the IP address manually.
- Press the **BACK** button to exit the menu screen.

### High Altitude Mode

\* High Altitude Mode is used when the environment is higher than 1200 meters.

1. Press the **MENU** button. Then, move to **OPTION** with the  $\wedge$ ,  $\vee$ ,  $<$ ,  $>$  buttons and press the **OK** button.
2. Press the  $\wedge$ ,  $\vee$  buttons to move to **High Altitude** and press the **OK** button.
3. Press the  $<$ ,  $>$  buttons to move to **On** and press the **OK** button.
  - Press the **BACK** button to exit the menu screen.

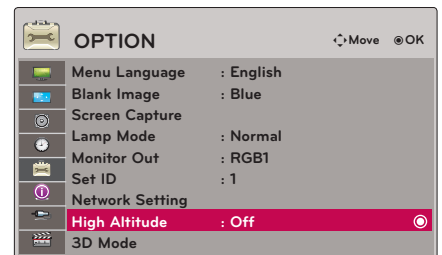

## INFORMATION Menu Options

### To See The Projector Information

1. Press the **MENU** button. Then, move to **INFORMATION** with the  $\wedge$ ,  $\vee$ ,  $<$ ,  $>$  buttons and press the **OK** button.
2. You can see the current information of the projector.
  - Press the **BACK** button to exit the menu screen.

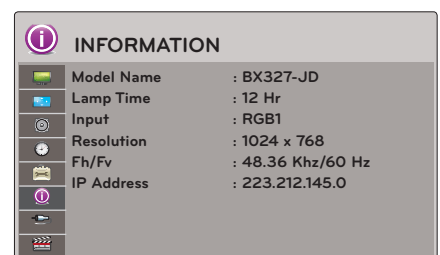

# USB

\* Image shown may differ from your projector.

## To use the USB device

### Connecting the USB device

\* When you connect a USB device, this screen is displayed, automatically.  
In USB device, you can not add a new folder or delete the existing folder.

1. Connect the USB device to the USB jack on the back of the set.
2. It turns automatically to DivX Home Menu.

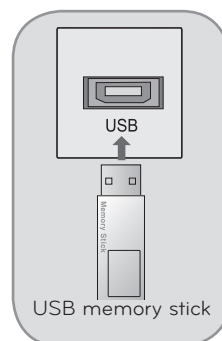
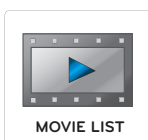
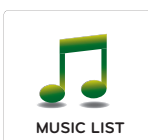

### Eject USB

\* Select "Eject" in order to eject a USB device.

1. Press the **Q.MENU** button on the remote control.
2. Press the **<**, **>** buttons to move to **USB Device**.
3. Press the **OK** button on the remote control.
  - After **Eject USB**, USB memory cannot be read. Remove USB memory, and connect again.
  - Press the **BACK** button to exit the menu screen.

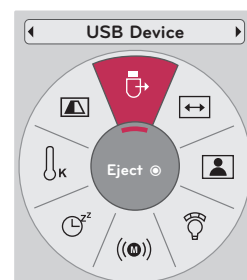

### Precautions when using the USB device

- ▶ Only a USB storage device is recognizable.
- ▶ If the USB storage device is connected through a USB hub, the device is not recognizable.
- ▶ A USB storage device using an automatic recognition programmed may not be recognized.
- ▶ A USB storage device which uses its own driver may not be recognized.
- ▶ The recognition speed of a USB storage device may depend on each device.
- ▶ Please do not turn off the projector or unplug the USB device when the connected USB storage device is working. When such device is suddenly separated or unplugged, the stored files or the USB storage device may be damaged.
- ▶ Please do not connect the USB storage device which was artificially maneuvered on the PC. The device may cause the product to malfunction or fail to be played. Never forget to use only a USB storage device which has normal music files, image files, movie files or text files.
- ▶ Please use only a USB storage device which was formatted as a FAT16, FAT32 and NTFS file system provided with the Windows operating system. In case of a storage device formatted as a different utility programmed which is not supported by Windows, it may not be recognized.
- ▶ Please connect power to a USB storage device which requires an external power supply. If not, the device may not be recognized.
- ▶ Please connect a USB storage device with cable is offered by USB maker. If connected with cable is not offered by USB maker or an excessively long cable, the device may not be recognized.
- ▶ Some USB storage devices may not be supported or operated smoothly.
- ▶ If the name of a folder or file is too long, it will not be displayed or recognized.
- ▶ File alignment method of USB storage device is similar to Window XP and filename can recognize up to 100 English characters.
- ▶ Please backup the important file because a data of USB device may be damaged. Data management is consumer's responsibility and in consequence the manufactures does not cover the product bearing data damage.
- ▶ The recommended capacity is 1TB or less for a USB external hard disk and 32GB or less for USB memory. Any device with more than the recommended capacity may not work properly.
- ▶ Only the FAT32 file system supports the delete function.
- ▶ If the USB memory device does not work properly, disconnect and reconnect it.
- ▶ If a USB external hard disk with a "Energy Saving" function does not work, turn the hard disk off and on again to make it work properly.
- ▶ USB storage devices below USB 2.0 are supported as well. But they may not work properly in the movie list.
- ▶ If your USB memory device has multiple partitions, or if you use a USB multi-card reader, you can use up to 4 partitions or USB memory devices.
- ▶ How fast a USB memory device is detected differs from device to device.
- ▶ If the USB is connected in Standby Mode, specific hard disk will automatically be loaded when the projector is turned on.
- ▶ Some USB storage devices may not be supported or operated smoothly.

## PHOTO LIST

\* It is available to playback the photo file(\*.jpg) in the USB device.

The On Screen Display may be different from your set. Images are an example to assist with the projector operation.

PHOTO(\*.JPEG) supporting file

Baseline : 64 x 64 ~ 15360 x 8640

Progressive : 64 x 64 ~ 1920 x 1440

- You can play JPEG files only.
- Non-supported files are displayed in the form of predefined icon.

### Screen Components

1. Moves to upper level file
2. Preview: Display the thumbnail/folder name of the photo in the selected folder
3. Current page/Total pages
4. Total number of marked photos
5. Corresponding buttons on the remote control

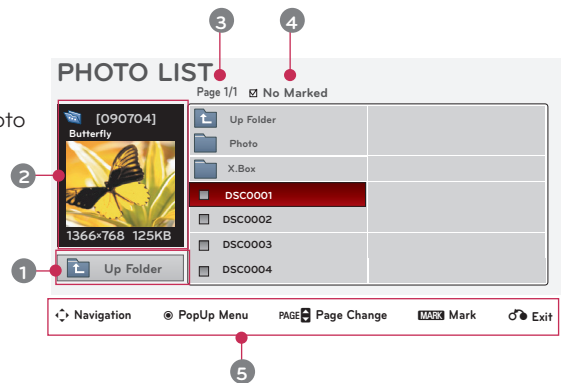

### Photo Selection and Popup Menu

1. Press the **USB** button. Then, move to **PHOTO LIST** with the <, > buttons and press the **OK** button.
2. Press the  $\wedge$ ,  $\vee$ , <, > buttons to move to a desired photo file and press the **OK** button.
3. Move to a desired item with the  $\wedge$ ,  $\vee$  buttons and then press the **OK** button.

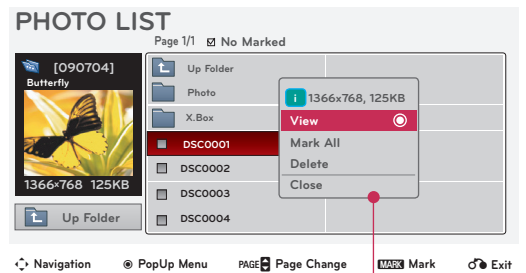

- **View:** Display the selected item.
- **Mark All:** Mark all photos on the screen.
- **Delete:** Delete the selected photo item.
- **Close:** Close the pop-up menu.

- If the picture file is damaged, it may not be displayed properly.
- High resolution pictures may take longer time to display on the entire screen.

## Full Screen Menu

1. Press the **USB** button. Then, move to **PHOTO LIST** with the <, > buttons and press the **OK** button.
2. Press the ^, v, <, > buttons to move to desired photo and press the **OK** button.
3. Press the ^, v buttons to move to **View** and press the **OK** button.
4. The selected photo is displayed in full size and show up the menu.
5. Use ^, v, <, > button to select and control the menu on the full-sized screen.

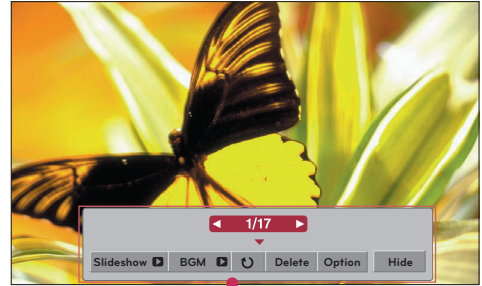

- Use <, > button to select the previous or next photo.
- **Slideshow**: Selected photos are displayed during the slide show. If no photo is selected, all photos in the current folder are displayed during slide show.
  - Set the time interval of the slide show in **Option**.
- **BGM**: Listen to music while viewing photos in full size.
  - Set the BGM device and album in **Option**.
- **Rotate** (Rotate): Rotate photos.
- **Delete**: Delete photos.
- **Option**: Set values for **Slide Speed** and **Music Folder**.
  - You cannot change **Music Folder** while BGM is playing.
- **Hide**: Hide the menu on the full-sized screen.
  - To see the menu again on the full-sized screen, press **OK** button to display.

# MUSIC LIST

\* You can use the Music List menu to play MP3 files from a USB storage device.  
The On Screen Display on your model may be slightly different.

- MUSIC (\*.MP3) supporting file  
Bit rate range 32 Kbps ~ 320 Kbps
- Sampling rate MPEG1 Layer3 : 32kHz, 44.1kHz, 48kHz
  - Sampling rate MPEG2 Layer3 : 16kHz, 22.05kHz, 24kHz
  - Sampling rate MPEG2.5 Layer3 : 8kHz, 11.025kHz, 12kHz

## Screen Components

1. Moves to upper level file
2. Preview: Display the title/folder name of the music in the selected folder
3. Current page/Total pages
4. Total number of marked music
5. Corresponding buttons on the remote control

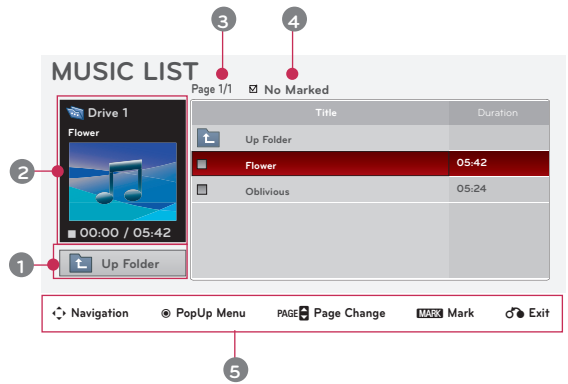

## Music Selection and Popup Menu

1. Press the **USB** button. Then, move to **MUSIC LIST** with the <, > buttons and press the **OK** button.
2. Press the ^, v, <, > buttons to move to a desired music file and press the **OK** button.
3. Move to a desired item with the ^, v buttons and then press the **OK** button.

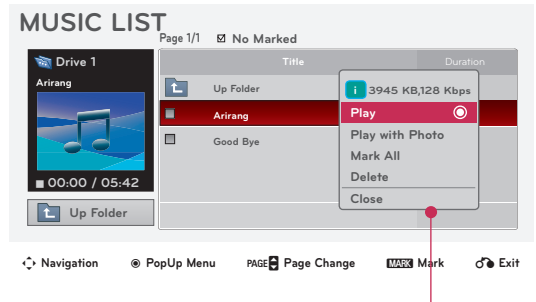

- **Play:** Once a song finishes playing, the next selected one will be played. When there are no selected music to play, the next one in the current folder will be played. If you go to a different folder and press the **OK** button, the current music in playback will stop. When music is playing, is displayed in front of the music play time. After certain time elapsed, the full music list screen disappears and the playback information screen which is on the top of the music list runs as a screen saver. Press **OK**, , or **BACK** button to stop the screen saver. A damaged or corrupted music file that does not play displays 00:00 as the play time. Music files with copy-protection will not play.
- **Play with Photo:** Start playing the selected music and then move to the **PHOTO LIST**.
- **Mark All:** Mark all music in the folder.
- **Delete:** Delete the selected music.
- **Close:** Close the pop-up menu.

## MOVIE LIST

\* The movie list is activated once USB is detected. It is used when playing movie files on projector.

### Supported Movie File

Extension name	Video Codec	Audio Codec	Max Resolution
mpg, mpeg, vob	MPEG1, MPEG2	Dolby Digital, MPEG, MP3, LPCM	1920x1080 @30p
dat	MPEG1	Dolby Digital, MPEG, MP3, LPCM	
ts, trp, tp	MPEG2, H.264/AVC	Dolby Digital, AAC, MPEG	
mp4	MPEG4 SP, MPEG4 ASP, Divx 3.11, Divx 4.12, Divx 5.x Divx 6, Xvid 1.00, Xvid 1.01, Xvid 1.02, Xvid 1.03 Xvid 1.10-beta 1, Xvid 1.10-beta 2, H.264/AVC	Dolby Digital, HEAAC, AAC, MPEG, MP3, LPCM	
avi	MPEG 2, MPEG 4 SP, MPEG4 ASP, Divx 3.11, Divx 4 Divx 5, Divx 6, Xvid 1.00, Xvid 1.01, Xvid 1.02, Xvid 1.03 Xvid 1.10-beta 1, Xvid 1.10-beta 2, H.264/AVC	Dolby Digital, HEAAC, AAC, MPEG, MP3, LPCM	
mkv	H.264/AVC, MPEG 1, MPEG 2, MPEG 4 SP, MPEG4 ASP	Dolby Digital, HEAAC, AAC, MPEG, MP3, LPCM	
divx	MPEG 2, MPEG 4 SP, MPEG4 ASP, Divx 3.11, Divx 4 Divx 5, Divx 6, Xvid 1.00, Xvid 1.01, Xvid 1.02, Xvid 1.03 Xvid 1.10-beta 1, Xvid 1.10-beta 2, H.264/AVC	Dolby Digital, HEAAC, AAC, MPEG, MP3, LPCM	

Bit rate range : within 32 kbps ~ 320 kbps (MP3)

Subtitle format : \*.smi/\*.srt/\*.sub(MicroDVD, SubViewer1.0/2.0)/\*.ass/\*.ssa/\*.txt(TMPlayer)/\*.psb(PowerDivx)

### Precautions when playing the DivX

- ▶ A DivX movie file and its subtitle file must be located in the same folder.
- ▶ At this time, a movie file name and its subtitle file name must be identical for it to be displayed.
- ▶ Specific subtitles created by the user may not be operated normally.
- ▶ Some special characters are not supported in subtitles.
- ▶ HTML tags are not supported in subtitles.
- ▶ Subtitles in languages other than the supported languages are not available.
- ▶ Time information in an external subtitle file should be arranged in ascending order to be played.
- ▶ Damaged movie files may not be played, and certain functions could be limited during the playback.
- ▶ Certain video files created with an encoder may not be played.
- ▶ If the video and audio structure of recorded file is not interleaved, either video or audio is outputted.
- ▶ Video with resolution higher than maximum resolution supported for each frame, cannot be guaranteed for smooth playback.
- ▶ DTS Audio codec is not supported.
- ▶ Playback for movie file exceeding 30 GB (Giga Byte) is not supported.
- ▶ Playing a video through a USB connection that doesn't support high speed may not work properly.
- ▶ When watching a video using MOVIE LIST, the function to adjust screen does not work.
- ▶ The screen may suffer temporary interruptions (image stoppage, faster playback, etc.) when the audio language is changed.
- ▶ Movie files other than the specified types and formats may not work properly.
- ▶ Max bitrate of playable movie file is 20Mbps.
- ▶ Files encoded with GMC(Global Motion Compensation) may not be played.
- ▶ When you are watching the movie by Movie List function, user setup for each image mode does not operate.
- ▶ Only the files saved in ASCII CODE is supported for the external subtitles of the movie.
- ▶ Only 500 alphabets and 500 numbers are supported for each line of the subtitle.
- ▶ Only 10000 of sync blocks can be supported within the subtitle file.



- ABOUT DIVX VIDEO: DivX® is a digital video format created by DivX, Inc. This is an official DivX Certified device that plays DivX video. Visit [www.divx.com](http://www.divx.com) for more information and software tools to convert your files into DivX video.
- ABOUT DIVX VIDEO-ON-DEMAND: This DivX Certified® device must be registered in order to play DivX Video-on-Demand (VOD) content. To generate the registration code, locate the DivX VOD section in the device setup menu. Go to [vod.divx.com](http://vod.divx.com) with this code to complete the registration process and learn more about DivX VOD.
- "DivX Certified® to play DivX® video up to HD 1080p, including premium content"
- "Pat. 7,295,673; 7,460,688; 7,519,274"



Manufactured under license from Dolby Laboratories. "Dolby" and the double-D symbol are trademarks of Dolby Laboratories.



## Screen Components

1. Moves to upper level folder
2. Preview: Display the title/folder name of the movie in the selected folder
3. Current page/Total pages
4. Total number of marked movies
5. Corresponding buttons on the remote control

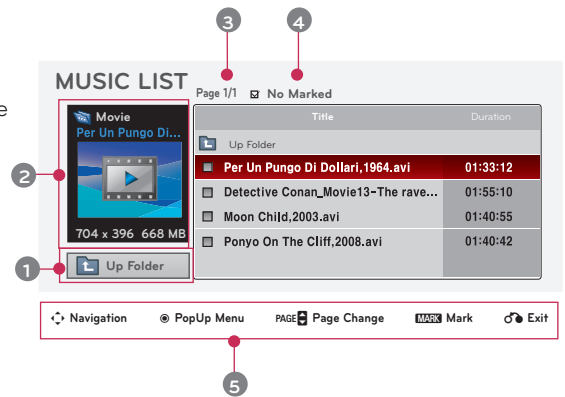

## Movie Selection and Popup Menu

1. Press the **USB** button. Then, move to **MOVIE LIST** with the <, > buttons and press the **OK** button.
2. Press the  $\wedge$ ,  $\vee$ , <, > move to a desired movie file and press the **OK** button.
3. Move to a desired item with the  $\wedge$ ,  $\vee$  buttons and then press the **OK** button.

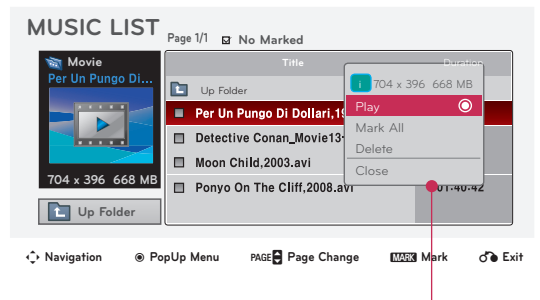

- **Play:** Play the selected movie titles.
  - In the case of files not supported, a message regarding non-supported file is displayed.
 

This file is invalid.
  - The screen is played, but when the audio file is not supported, the following message shows.
 

Unsupported Audio.
- **Mark All:** Mark all movies in the folder.
- **Delete:** Delete the selected movie.
- **Close:** Close the pop-up menu.

### Playing the Movie

\* You can adjust various method during the movie play.

1. Press the **USB** button. Then, move to **MOVIE LIST** with the <, > buttons and press the **OK** button.
2. Press the  $\wedge$ ,  $\vee$ , <, > move to a desired movie file and press the **OK** button.
3. Press the  $\wedge$ ,  $\vee$  buttons to move to **Play** and press the **OK** button.

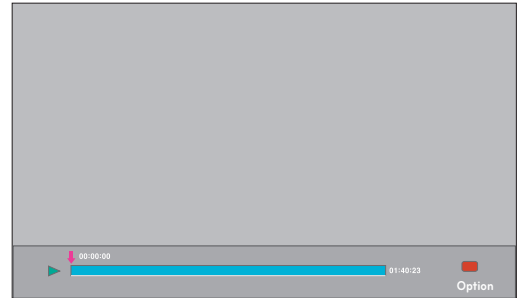

#### ◆ Use of remote control

- Press the **▶|| (Play/Pause)** button to play/pause the screen.
- Press the **■ (Stop)** button to stop.
- Press the **◀◀ (Skip -)** button to play the previous movie.
- Press the **▶▶ (Skip +)** button to play the next movie.

### Option Menu Selection

On **MOVIE LIST** play mode.  
Press the **RED** (RED) button on the remote control.

- **Picture Size:** Select the **Full** or **Original** screen size.
- **Picture Mode:** Select the **Vivid, Standard, Cinema, Sport** or **Game**.
- **Audio Language:** Select Language Group of the audio during movie play.
- **Subtitle Language:** Select Language Group of the subtitle during movie play. Subtitle language option can be differ according to choice of the language for menu.
  - **Sync:** When the video is not synchronized with the caption, it can be adjusted by the unit of 0.5 second.
  - **Position:** Move the location of the subtitle.

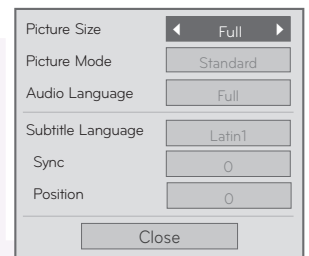

Subtitle Language Group	Supported Language
Latin1	French, Spanish, Catalan Basque, Portuguese, Italian, Albanian, Rhaeto-Romanic, Dutch, German, Danish, Swedish, Norwegian, Finnish, Faeroese, Icelandic, Irish, Scottish, English
Latin2	Czech, Hungarian, Polish, Romanian, Croatian, Slovak, Slovenian, Serbian
Latin4	Estonian, the Baltic languages Latvian(Lettish)and Lithuanian, Greenlandic and Lappish
Latin5	English, Turkish
Cyrillic	Bulgarian, Byelorussian, Macedonian, Russian, Serbian and pre-1990 (no ghe with upturn)Ukrainian
Greek	English, modern Greek
Hebrew	English, modern Hebrew
Chinese	Chinese
Korean	English, Korean
Arabic	English, Arabic

## To See The DivX Registration Code

\* Confirm the DivX registration code number of the projector.  
Using the registration number, movies can be rented or purchased at [www.divx.com/vod](http://www.divx.com/vod).

1. Press the **MENU** button. Then, move to **USB** with the  $\wedge$ ,  $\vee$ ,  $<$ ,  $>$  buttons and press the **OK** button.
2. Press the  $\wedge$ ,  $\vee$  buttons to move to **DivX Reg. Code** and press the **OK** button.
3. You can see the DivX registration code of the projector.

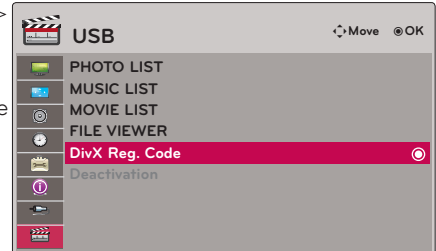

- With a DivX registration code from other projector, playback of rented or purchased DivX file is not allowed. (Only DivX files matched with the registration code of the purchased projector are playable.)
- The video or audio of a file converted based on a standard other than the DivX codec standard may be corrupted or unable to be played.
- Press the **BACK** button to exit the menu screen.

## Deactivation Function

\* Delete the existing authentication information to receive a new DivX user authentication for projector. Once this function is executed, a DivX user authentication is required again to see DivX DRM files.

1. Press the **MENU** button. Then, move to **USB** with the  $\wedge$ ,  $\vee$ ,  $<$ ,  $>$  buttons and press the **OK** button.
2. Press the  $\wedge$ ,  $\vee$  buttons to move to **Deactivation** and press the **OK** button.
3. Move to a desired item with the  $<$ ,  $>$  buttons and then press the **OK** button.

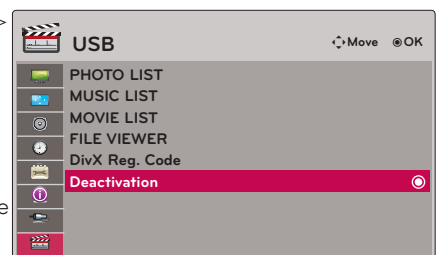

- DRM (Digital Rights Management) function:  
These are the technology and the service that prevents the illegal use of digital contents to protect the copyrights owners' benefits and rights. File can be played after the license is cleared through the methods of online, etc.
- Press the **BACK** button to exit the menu screen.

# FILE VIEWER

Supported File : XLS, DOC, PPT, TXT, XLSX, PPTX, DOCX, PDF

- Microsoft Office Version 97 / 2000 / 2002 / 2003 / 2007
- Adobe PDF Version 1.0 / 1.1 / 1.2 / 1.3 / 1.4
- File Viewer realigns the document, so it may look different from the PC.
- For the documents that include images, the resolution may look lower during the realigning process.
- If the document volume is big or it has many pages, the loading may take long time.
- For some fonts that are not supported, they may be replaced with other fonts.

## Screen Components

1. Moves to upper level file
2. Preview: Display the title/folder name of the file in the selected folder
3. Current page/Total pages
4. Corresponding buttons on the remote control

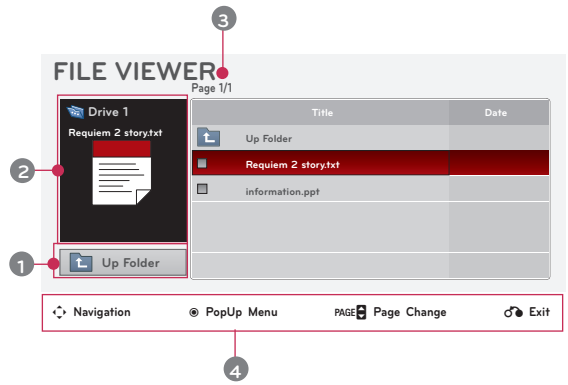

## View File

1. Press the **USB** button. Then, move to **FILE VIEWER** with the <, > buttons and press the **OK** button.
2. Press the ^, v, <, > move to a desired file and press the **OK** button.

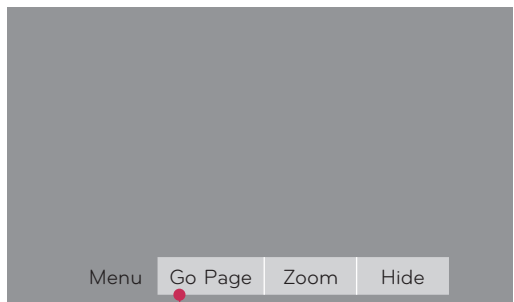

- Use Page ^, v button to move the previous or next page.
- **Go Page:** Move to a desired page.
  - 0 3 /14 page
  - 1. Move to **Go Page** with <, > buttons and press ^ button.
  - 2. Press the ^, v, <, > buttons select a desired page and press the **OK** button.
- **Zoom:** Zoom in or zoom out.
  - 100 % - + horizontal array vertical array OK
  - 1. Move to **Zoom** with <, > buttons and press ^ button.
  - 2. Press the <, > buttons select a desired page and press the **OK** button.
- **Hide:** Close the menu.
  - To see the menu again on the full-sized screen, press **MENU** button to display.

# Information

## Supported Monitor Display

\* The following table lists the display formats supported by the projector.

Format	Vertical Freq.(Hz)	Horizontal Freq.(kHz)
640X350	70.09Hz	31.468kHz
640X350	85.08Hz	37.861kHz
640X400	85.08Hz	37.861kHz
720X400	70.08Hz	31.469kHz
720X400	85.03Hz	37.927kHz
640X480	59.94Hz	31.469kHz
640X480	72.80Hz	37.861kHz
640X480	75.00Hz	37.500kHz
640X480	85.00Hz	43.269kHz
800X600	56.25Hz	35.156kHz
800X600	60.31Hz	37.879kHz
800X600	72.18Hz	48.077kHz
800X600	75.00Hz	46.875kHz
800X600	85.06Hz	53.674kHz
1024X768	60.00Hz	48.363kHz
1024X768	70.06Hz	56.476kHz
1024X768	75.02Hz	60.023kHz
1024X768	84.99Hz	68.677kHz
1152X864	60.05Hz	54.348kHz
1152X864	70.01Hz	63.995kHz
1152X864	75.00Hz	67.500kHz
1280X960	60.00Hz	60.000kHz
1280X960	85.00Hz	85.940kHz
1280X1024	60.02Hz	63.981kHz
1280X1024	75.025Hz	79.976kHz
1400X1050	60.00Hz	65.317kHz
1600X1200	60.00Hz	74.479kHz

\* If the projector does not support the input signal, "Invalid Format" message appears on the screen.

\* The projector supports DDC1/2B type as Plug & Play function. (Auto recognition of PC monitor)

\* PC synchronization signal types supported :Separate type synchronization.

\* To get the the best picture quality, adjust the PC graphics card to 1024x768.

< DVD/DTV Input >

Signal	Component-*1	HDMI-*2
NTSC (60 Hz)	480i	O
	480p	O
	720p	O
	1080i	O
	1080p	O
PAL (50 Hz)	576i	O
	576p	O
	720p	O
	1080i	O
	1080p	O
24 / 30 Hz	1080p	O
50 / 60 Hz	1080p	O

\* Cable type  
1- RGB to Component Cable  
2- HDMI Cable

## Maintenance

\* The projector needs little maintenance. You should keep the lens clean because any dirt or stains may appear on the screen. If any parts need to be replaced, contact your dealer. When cleaning any part of the projector, always turn the power off and unplug the projector first.

### Cleaning the lens

If there is any dust or stain on the surface of the lens, you must always clean the lens. Use an air spray or cleaning cloth to lightly clean the product. Please use a recommended air spray or lens cleaning product. To clean lens, small amount of cleaning agent on a swab or a soft cloth and rub on the lens. Please be aware that liquid may flow pass through the lens if the product is sprayed on lens directly.

### Cleaning the Projector Case

To clean the projector case, first unplug the power cable. To remove dirt or dust, wipe the casing with a soft, dry, lint-free cloth. To remove stubborn dirt or stains, moisten a soft cloth with water and a neutral detergent and then wipe the casing. Do not use alcohol, benzene, thinners or other chemical detergents as these can cause the casing to be warped or discolored.

## Replacing the Lamp

### Lamp Replacement

The change interval of lamp may depend on the use environment of Projector. You can see the used lamp time in the Lamp Time section of the Menu.

You must replace the lamp when:

- \* The projected image gets darker or starts to deteriorate.
- \* The lamp indicator is red.
- \* The message "Replace the lamp" appears on the screen when turning the projector on.

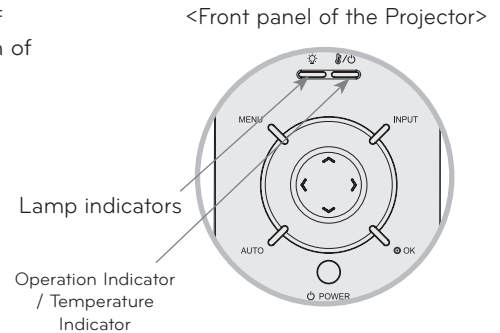

### Be careful when replacing lamp

- Press the POWER button on the control panel or remote control to turn off power.
- If the operation indicator LED is orange and blinking, do not disconnect the main supply until the operation indicator LED is lit up constantly (orange).
- Allow the lamp to cool for 1 hour before replacing it.
- Replace only with the same type lamp from an LG Electronics Service Center. Using another manufacturers lamp may cause damage to the Projector and lamp.
- Pull out the lamp only when replacing the lamp.
- Keep the lamp unit out of reach of children. Keep the Lamp away from heat sources such as radiators, stoves etc.
- To reduce the risk of fire do not expose the lamp to liquids or foreign materials.
- Do not place the lamp near any heat source.
- Make sure the new lamp is securely tightened with screws. If not, the image may be dark or there could be an increased risk of fire.
- Never touch the lamp unit glass otherwise image quality may be compromised or lamp life maybe reduced.

### To obtain a replacement Lamp unit

Lamp model number is on page 54. Check the lamp model and then purchase it from an LG Electronics Service Center.

Using another manufacturers lamp may cause damage to the projector.

### Lamp unit disposal

Dispose of the used lamp by returning it to the LG Electronics Service Center.

- 1** Turn off the projector and unplug the power cable. Carefully place on a cushioned surface.

(Allow the lamp to cool for 1 hour before removing the used lamp from the projector.)

- 2** Unscrew the screw from the lamp cover using a screwdriver.

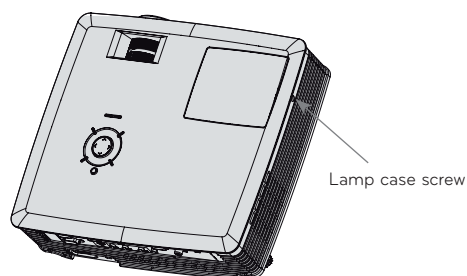

- 3** After lifting the lamp cover off, remove the two retaining screws on the lamp case with a screwdriver.

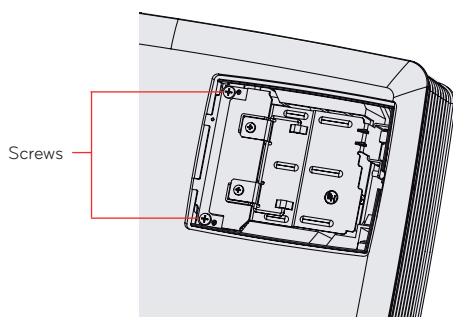

- 4** Lift the lamp up from the projector.

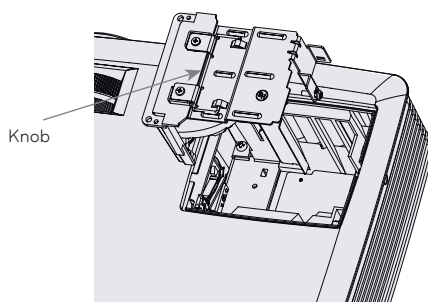

- 5** Pull out the handle slowly and remove the lamp case.

- 6** Insert the new lamp gently into the correct position. Make sure it is inserted correctly.

- 7** Tighten the screws you removed in step 3. (Make sure they are fixed firmly.)

- 8** Close the lamp cover and install the screws from step 2 to install the cover.

(If the lamp cover is not installed correctly the unit will not power on.)

**Note!**

Using another manufacturer's lamp may cause damage to the projector or lamp. Make sure the lamp cover is securely fastened. If the lamp cover is not installed correctly the unit will not power on. If this fault persists contact an LG Authorized Service Center.

## Regarding the projector lamp control

### WARNING

- \* Don't turn off the projector at least in 5 minutes after activating it.
- The frequent On/Off changes may cause the lamp function to deteriorate.
- \* Don't pull out the power cord while activating the projector and the cooling fan.
- It may cause the lamp life-span to shorten and get damaged.
- \* The life-span of projector may considerably depend on the use environment and treatment conditions.
- \* The projector uses the high pressure mercury lamp so that the serious caution is essential. The shock or abuse while using may cause lamp to blow off with explosion.
- \* When you continue to use the projector after an interval of lamp replacement, the lamp may be blown off with explosion.
- \* The following treatment should be done, in case of lamp blow-off.
- Pull off the power cord immediately.
- Let some fresh air in immediately (Ventilation).
- Check the product condition at the nearer service center and replace it with new lamp, if necessary.
- Don't try to disassemble the product without the authorized technician.

## How to fix the lens cap to the projector

### How to fix the lens cap

- 1** Prepare the lens cap and the strap supplied as accessories.

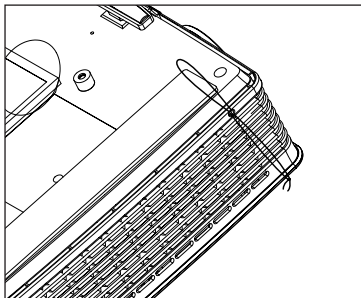

- 2** Insert the non-knot end of the strap into the hole at the bottom of the lens section of the projector.

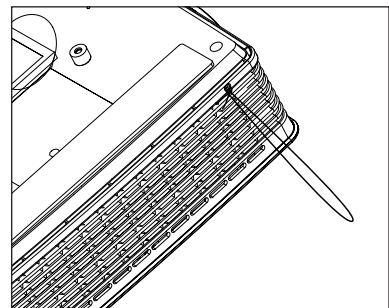

- 3** Fix the strap at the hole of the projector into the hole of the lens cap, and then pass the lens cap through the strap lasso.

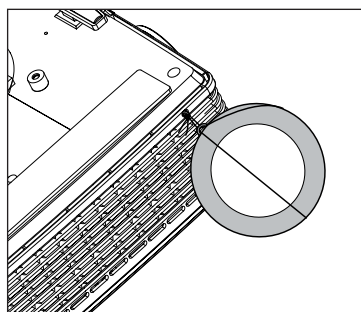

- 4** They are completely assembled as shown at the below figure.

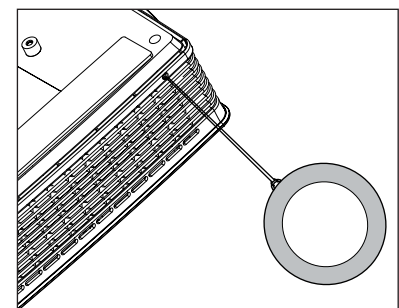



MEMO

## Specifications

MODEL	BX327 (BX327-JD)
Resolution	1024 (Horizontal) x 768 (Vertical) pixel
Horizontal / Vertical Ratio	4:3 (horizontal:vertical)
Panel size (mm)	13.97
Projection distance (Screen size)	1.6m ~ 10m (101.6cm ~ 635.0cm)
Projection Offset	115 %
Remote control distance	6 m
Video compatibility	NTSC/PAL/SECAM/NTSC4.43/PAL-M/PAL-N/PAL-60
Power	AC 100 - 240V~50/60Hz, 3.0A
Audio Output	5W + 5W
Height (mm)	90.5 (with foot), 80 (without foot)
Width (mm)	291.5
Length (mm)	260
Weight (kg)	3.5
USB Device	5 V, 0.5 A (max)

## Operating Condition

## Temperature

In operation : 0°C ~ 40°C  
 In storage and transit : -20°C ~ 60°C

## Humidity

In operation : 0 % ~ 80% relative humidity  
 Not in operation : 0 % ~ 85% relative humidity

## Projector Lamp

## Lamp model

AJ-LBX3A

## Lamp power consumption

230W

## Open Source Software Notice

The following GPL executables and LGPL, MPL libraries used in this product are subject to the GPL2.0/LGPL2.1/MPL1.1 License Agreements:

### GPL EXECUTABLES:

Linux kernel 2.6, busybox, lzo, u-boot

### LGPL LIBRARIES:

uClibc

### MPL LIBRARIES:

nanox

LG Electronics offers to provide source code to you on CD-ROM for a charge covering the cost of performing such distribution, such as the cost of media, shipping and handling upon e-mail request to LG Electronics at: [opensource@lge.com](mailto:opensource@lge.com)

This offer is valid for a period of three (3) years from the date of the distribution of this product by LG Electronics.

You can obtain a copy of the GPL, LGPL and MPL licenses on the CD-ROM provided with this product.

Also you can obtain the translation of GPL, LGPL licenses from

<http://www.gnu.org/licenses/old-licenses/gpl-2.0-translations.html>,

<http://www.gnu.org/licenses/old-licenses/lgpl-2.1-translations.html>.

This product includes

- ▶ cmap: copyright © 1990-1998 Adobe Systems Incorporated.
- ▶ GIF LZW Decoder: copyright © 1987, by Steven A. Bennett
- ▶ md5: copyright © 1991-2, RSA Data Security, Inc
- ▶ jpeg: Independent JPEG Group, copyright © 1991 - 1998, Thomas G. Lane.
- ▶ libpng: copyright © 2004 Glenn Randers-Pehrson
- ▶ OSSP str - String Handling:
  - copyright © 1999-2005 Ralf S. Engelschall <[rse@engelschall.com](mailto:rse@engelschall.com)>
  - copyright © 1999-2005 The OSSP Project <http://www.ossproject.org/>
- ▶ random number generator : copyright © 1990, 1993 The Regents of the University of California.
- ▶ Standard C functions
  - copyright © 1998 Softweyr LLC.
  - copyright © 1988, 1993 The Regents of the University of California.
- ▶ tinycl: copyright © 2000-2006 Lee Thomason
- ▶ zlib: copyright © 1995-2002 Jean-loup Gailly and Mark Adler.

All rights reserved.

Permission is hereby granted, free of charge, to any person obtaining a copy of this software and associated documentation files (the "Software"), to deal in the Software without restriction, including without limitation the rights to use, copy, modify, merge, publish, distribute, sublicense, and/or sell copies of the Software, and to permit persons to whom the Software is furnished to do so, subject to the following conditions:

THE SOFTWARE IS PROVIDED "AS IS", WITHOUT WARRANTY OF ANY KIND, EXPRESS OR IMPLIED, INCLUDING BUT NOT LIMITED TO THE WARRANTIES OF MERCHANTABILITY, FITNESS FOR A PARTICULAR PURPOSE AND NONINFRINGEMENT. IN NO EVENT SHALL THE AUTHORS OR COPYRIGHT HOLDERS BE LIABLE FOR ANY CLAIM, DAMAGES OR OTHER LIABILITY, WHETHER IN AN ACTION OF CONTRACT, TORT OR OTHERWISE, ARISING FROM, OUT OF OR IN CONNECTION WITH THE SOFTWARE OR THE USE OR OTHER DEALINGS IN THE SOFTWARE.



The model and serial number of the projector is located on the back or one side of the projector. Record it below should you ever need service.

MODEL \_\_\_\_\_

SERIAL \_\_\_\_\_