

Panasonic®

Operating Instructions Projector Operations

LCD Projector Commercial Use

Model No. PT-VX400NTE

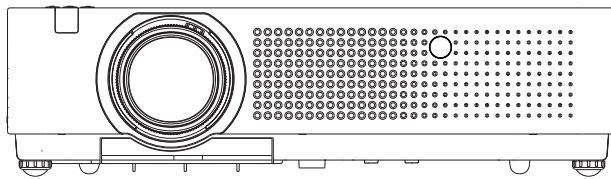

Thank you for purchasing this Panasonic Product.

■ Before operating this product, please read the instructions carefully and save this manual for future use.

For information on using the product via a network, refer to “Operating Instructions – Network Operations”.

Read this first!

WARNING: THIS APPARATUS MUST BE EARTHED.

WARNING: To prevent damage which may result in fire or shock hazard, do not expose this appliance to rain or moisture.

Machine Noise Information Ordinance 3. GSGV, January 18, 1991: The sound pressure level at the operator position is equal or less than 70 dB (A) according to ISO 7779.

WARNING:

1. Remove the plug from the mains socket when this unit is not in use for a prolonged period of time.
2. To prevent electric shock, do not remove cover. No user serviceable parts inside. Refer servicing to qualified service personnel.
3. Do not remove the earthing pin on the mains plug. This apparatus is equipped with a three prong earthing type mains plug. This plug will only fit an earthing-type mains socket. This is a safety feature. If you are unable to insert the plug into the mains socket, contact an electrician. Do not defeat the purpose of the earthing plug.

CAUTION: To assure continued compliance, follow the attached installation instructions, which includes using the provided power cord and shielded interface cables when connecting to computer or peripheral device. If you use serial port to connect PC for external control of projector, you must use optional RS-232C serial interface cable with ferrite core. Any unauthorized changes or modifications to this equipment will void the user's authority to operate.

EEE Yönetmeliğine Uygundur.
EEE Complies with Directive of Turkey.



WARNING: TURN OFF THE UV LAMP BEFORE OPENING THE LAMP COVER.

WARNING: TO REDUCE THE RISK OF FIRE OR ELECTRIC SHOCK, DO NOT EXPOSE THIS PRODUCT TO RAIN OR MOISTURE.

WARNING: RISK OF ELECTRIC SHOCK, DO NOT OPEN.



The lightning flash with arrowhead symbol, within an equilateral triangle, is intended to alert the user to the presence of uninsulated "dangerous voltage" within the product's enclosure that may be of sufficient magnitude to constitute a risk of electric shock to persons.



The exclamation point within an equilateral triangle is intended to alert the user to the presence of important operating and maintenance (servicing) instructions in the literature accompanying the product.

WARNING:**■ POWER**

The wall outlet or the circuit breaker shall be installed near the equipment and shall be easily accessible when problems occur. If the following problems occur, cut off the power supply immediately.

Continued use of the projector in these conditions will result in fire or electric shock.

- If foreign objects or water get inside the projector, cut off the power supply.
 - If the projector is dropped or the cabinet is broken, cut off the power supply.
 - If you notice smoke, strange smells or noise coming from the projector, cut off the power supply.
- Please contact an Authorized Service Center for repairs, and do not attempt to repair the projector yourself.

During a thunderstorm, do not touch the projector or the cable.

Electric shocks can result.

Do not do anything that might damage the power cord or the power plug.

If the power cord is used while damaged, electric shocks, short-circuits or fire will result.

- Do not damage the power cord, make any modifications to it, place it near any hot objects, bend it excessively, twist it, pull it, place heavy objects on top of it or wrap it into a bundle.

Ask an Authorized Service Center to carry out any repairs to the power cord that might be necessary.

Insert the power plug securely into the wall outlet.

If the plug is not inserted correctly, electric shocks or overheating will result.

- Do not use anything other than the provided power cord.
- Do not use the provided power cord for other electrical equipment.
- Do not use plugs which are damaged or wall outlets which are coming loose from the wall.

Clean the power plug regularly to prevent it from becoming covered in dust.

Failure to observe this will cause a fire.

- If dust builds up on the power plug, the resulting humidity can damage the insulation.
 - If not using the projector for an extended period of time, pull the power plug out from the wall outlet.
- Pull the power plug out from the wall outlet and wipe it with a dry cloth regularly.

Do not handle the power plug with wet hands.

Failure to observe this will result in electric shocks.

Do not overload the wall outlet.

If the power supply is overloaded (ex., by using too many adapters), overheating may occur and fire will result.

■ ON USE/INSTALLATION

Do not place liquid containers on top of the projector.

If water spills onto the projector or gets inside it, fire or electric shocks will result.

If any water gets inside the projector, contact an Authorized Service Center.

Do not place the projector on soft materials such as carpets or sponge mats.

Doing so will cause the projector to overheat, which can cause burns, fire or damage to the projector.

Do not set up the projector in humid or dusty places or in places where the projector may come into contact with oily smoke or steam, ex. a bathroom.

Using the projector under such conditions will result in fire, electric shocks or components deterioration.

Components deterioration (such as ceiling mount brackets) may cause the projector which is mounted on the ceiling to fall down.

Do not install this projector in a place which is not strong enough to take the full weight of the projector or on top of a surface which is sloped or unstable.

Failure to observe this will cause projector to fall down or tip over the projector, and severe injury or damage could result.

Do not place another projector or other heavy objects on top of the projector.

Failure to observe this will cause the projector to become unbalanced and fall, which could result in damage or injury. The projector will be damaged or deformed.

Read this first!

WARNING:

Installation work (such as ceiling mount bracket) should only be carried out by a qualified technician.

If installation is not carried out and secured correctly it can cause injury or accidents, such as electric shocks.

- Do not use anything other than an authorized ceiling mount bracket.
- Be sure to use the provided accessory wire with an eye bolt as an extra safety measure to prevent the projector from falling down. (Install in a different location to the ceiling mount bracket)

Do not cover the air inlet port or the air outlet port.

Doing so will cause the projector to overheat, which can cause fire or damage to the projector.

- Do not place the projector in narrow, badly ventilated places such as closets or bookshelves.
- Do not place the projector on cloth or papers, as these materials could be drawn into the air inlet port.

Do not place your hands or other objects close to the air outlet port.

Doing so will cause burns or damage your hands or other objects.

- Heated air comes out of the air outlet port. Do not place your hands or face, or objects which cannot withstand heat close to this port.

Do not look and place your skin into the lights emitted from the lens while the projector is being used.

Doing so can cause burns or loss of sight.

- Strong light is emitted from the projector's lens. Do not look or place your hands directly into this light.
- Be especially careful not to let young children look into the lens. In addition, turn off the power and disconnect the power plug when you are away from the projector.

Do not insert any foreign objects into the projector.

Doing so will cause fire or electric shocks.

- Do not insert any metal objects or flammable objects into the projector or drop them onto the projector.

Never attempt to remodel or disassemble the projector.

High voltages can cause fire or electric shocks.

- For any inspection, adjustment and repair work, please contact an Authorized Service Center.

Do not project an image with the lens cover attached.

Doing so can cause fire.

Do not allow metal objects, flammable objects, or liquids to enter inside of the projector. Do not allow the projector to get wet.

Doing so may cause short circuits or overheating, and result in fire, electric shock, or malfunction of the projector.

- Do not place containers of liquid or metal objects near the projector.
- If liquid enters inside of the projector, consult your dealer.
- Particular attention must be paid to children.

Use the ceiling mount bracket specified by Panasonic.

Defects in the ceiling mount bracket will result in falling accidents.

- Attach the supplied safety cable to the ceiling mount bracket to prevent the projector from falling down.

Be sure to ask authorized personnel or your supplier when mounting the product to a ceiling.

This requires an optional ceiling mount bracket.

Model No.: ET-PKV100H (for high ceilings), ET-PKV100S (for low ceilings),
ET-PKV100B (Projector Mount Base).

WARNING:**■ ACCESSORIES**

Do not use or handle the batteries improperly, and refer to the following.

Failure to observe this will cause burns, batteries to leak, overheat, explode or catch fire.

- Do not use unspecified batteries.
- Do not disassemble dry cell batteries.
- Do not heat the batteries or place them into water or fire.
- Do not allow the + and – terminals of the batteries to come into contact with metallic objects such as necklaces or hairpins.
- Do not store batteries together with metallic objects.
- Store the batteries in a plastic bag and keep them away from metallic objects.
- Make sure the polarities (+ and –) are correct when inserting the batteries.
- Do not use a new battery together with an old battery or mix different types of batteries.
- Do not use batteries with the outer cover peeling away or removed.
- Remove the empty batteries from the remote control at once.
- Insulate the battery using tape or something similar before disposal.

Do not allow children to reach the batteries (AAA/R03 or AAA/LR03 type).

- The battery can cause personal injury if swallowed.
- If swallowed, seek medical advice immediately.

If the battery fluid leaks, do not touch it with bare hands, and take the following measures if necessary.

- Battery fluid on your skin or clothing could result in skin inflammation or injury.
Rinse with clean water and seek medical advice immediately.
- Battery fluid coming in contact with your eyes could result in loss of sight.
In this case, do not rub your eyes. Rinse with clean water and seek medical advice immediately.

Do not disassemble the lamp unit.

If the lamp breaks, it could cause injury.

Lamp replacement

The lamp has high internal pressure. If improperly handled, an explosion and severe injury or accidents will result.

- The lamp can easily explode if struck against hard objects or dropped.
- Before replacing the lamp, be sure to disconnect the power plug from the wall outlet.
Electric shocks or explosions can result if this is not done.
- When replacing the lamp, turn the power off and allow the lamp to cool for at least 45 minutes before handling it otherwise it can cause burns.

Do not allow infants or pets to touch the remote control unit.

- Keep the remote control unit out of the reach of infants and pets after using it.

Do not use the supplied power cord with devices other than this projector.

- Using the supplied power cord with devices other than this projector may cause short circuits or overheating, and result in electric shock or fire.

Remove the depleted batteries from the remote control promptly.

- Leaving them in the unit may result in fluid leakage, overheating, or explosion of the batteries.

CAUTION:**■ POWER**

When disconnecting the power cord, be sure to hold the power plug and power connector.

If the power cord itself is pulled, the lead will become damaged, and fire, short-circuits or serious electric shocks will result.

When not using the projector for an extended period of time, disconnect the power plug from the wall outlet and remove the batteries from the remote control.

Disconnect the power plug from the wall outlet before carrying out any cleaning and replacing the unit.
Electric shocks can result if this is not done.

Read this first!

CAUTION:

■ ON USE/INSTALLATION

Do not put your weight on this projector.

You could fall or the projector could break, and injury will result.

- Be especially careful not to let young children stand or sit on the projector.

Do not place the projector in extremely hot locations.

Doing so will cause the outer casing or internal components to deteriorate, or result in fire.

- Take particular care in locations exposed to direct sunlight or near stoves.

Always disconnect all cables before moving the projector.

Moving the projector with cables still attached can damage the cables, which will cause fire or electric shocks to occur.

Never plug headphones and earphones into AUDIO OUT jack.

Excessive sound pressure from earphones and headphones can cause hearing loss.

■ ACCESSORIES

Do not use the old lamp unit.

If used it could cause lamp explosion.

If the lamp has broken, ventilate the room immediately. Do not touch or bring your face close to the broken pieces.

Failure to observe this will cause the user to absorb the gas which was released when the lamp broke and which contains nearly the same amount of mercury as fluorescent lamps, and the broken pieces will cause injury.

- If you believe that you have absorbed the gas or that the gas has got into your eyes or mouth, seek medical advice immediately.
- Ask your dealer about replacing the lamp unit and check the inside of the projector.



To remove the battery Remote Control Battery

1. Press the guide and lift the cover.

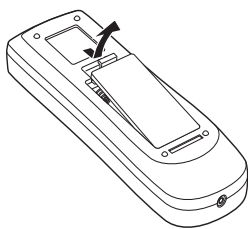

2. Remove the batteries.

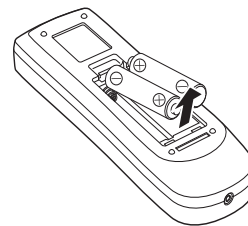

Trademarks

- HDMI, the HDMI logo and High-Definition Multimedia Interface is a trademark or registered trademark of HDMI Licensing LLC. **HDMI**
HIGH-DEFINITION MULTIMEDIA INTERFACE

- Other names, company names or product names used in these operating instructions are the trademarks or registered trademarks of their respective holders.

Please note that the operating instructions do not include the ® and TM symbols.

Illustrations in these operating instructions

- Note that illustrations of the projector and screens may differ from the ones you actually see.

Page references

- In these instructions, references to pages are indicated as: (➡ page 00).

Term

- In these instructions, the “Wireless remote control unit” accessory is referred to as the “Remote control”.

Declaration of Conformity



Declaration of Conformity (DoC)

This equipment is in compliance with the essential requirements and other relevant provisions of Directive 1999/5/EC.

Customers can download a copy of the original DoC for this product from our DoC server: <http://www.doc.panasonic.de>

Contact in the EU: Panasonic Services Europe, a Division of Panasonic Marketing Europe GmbH, Panasonic Testing Centre, Winsbergring 15, 22525 Hamburg, F.R.Germany

This product is intended to be used in the following countries.

Austria, Belgium, Bulgaria, Czech, Cyprus, Denmark, Estonia, Finland, France, Germany, Greece, Hungary, Iceland, Ireland, Italy, Latvia, Lithuania, Luxembourg, Malta, Netherlands, Norway, Poland, Portugal, Romania, Slovenia, Slovak, Spain, Sweden, Switzerland & UK



Konformitätserklärung (KE)

Dieses Gerät entspricht den grundlegenden Anforderungen und den weiteren entsprechenden Vorgaben der Richtlinie 1999/5/EU.

Kunden können eine Kopie der Original-KE für dieses Produkt von unserem KE-Server herunterladen: <http://www.doc.panasonic.de>

Kontaktadresse in der EG: Panasonic Services Europe, a Division of Panasonic Marketing Europe GmbH, Panasonic Testing Centre, Winsbergring 15, 22525 Hamburg, F.R.Germany

Dieses Produkt ist für den Einsatz in den folgenden Ländern vorgesehen.

Österreich, Belgien, Bulgarien, Tschechische Republik, Zypern, Dänemark, Estland, Finnland, Frankreich, Deutschland, Griechenland, Ungarn, Island, Irland, Italien, Lettland, Litauen, Luxemburg, Malta, Niederlande, Norwegen, Polen, Portugal, Rumänien, Slowenien, Slowakei, Spanien, Schweden, Schweiz und Großbritannien



Déclaration de Conformité (DC)

Cet appareil est conforme aux exigences essentielles et aux autres dispositions pertinentes de la Directive 1999/5/EC.

Les clients peuvent télécharger une copie de la DC originale pour ce produit à partir de notre serveur DC: <http://www.doc.panasonic.de>

Coordonnées dans l'UE : Panasonic Services Europe, a Division of Panasonic Marketing Europe GmbH, Panasonic Testing Centre, Winsbergring 15, 22525 Hamburg, F.R.Germany

Ce produit est conçu pour l'utilisation dans les pays suivants.

Autriche, Belgique, Bulgarie, République Tchèque, Chypre, Danemark, Estonie, Finlande, France, Allemagne, Grèce, Hongrie, Islande, Irlande, Italie, Lettonie, Lituanie, Luxembourg, Malte, Pays-Bas, Norvège, Pologne, Portugal, Roumanie, Slovaquie, Espagne, Suède, Suisse et Royaume-Uni



Declaración de conformidad (DC)

Este equipo cumple con los requisitos esenciales así como con otras disposiciones de la Directiva 1999/5/CE.

El cliente puede descargar una copia de la DC original de este producto desde nuestro servidor DC: <http://www.doc.panasonic.de>

Contacto en la U.E.: Panasonic Services Europe, a Division of Panasonic Marketing Europe GmbH, Panasonic Testing Centre, Winsbergring 15, 22525 Hamburg, F.R.Germany

Este producto ha sido desarrollado para el uso en los siguientes países.

Austria, Bélgica, Bulgaria, República Checa, Chipre, Dinamarca, Estonia, Finlandia, Francia, Alemania, Grecia, Hungría, Islandia, Irlanda, Italia, Letonia, Lituania, Luxemburgo, Malta, Holanda, Noruega, Polonia, Portugal, Rumania, Eslovenia, Eslovaquia, España, Suecia, Suiza y el Reino Unido



Dichiarazione di conformità (DoC)

Questo apparecchio è conforme ai requisiti essenziali ed agli altri principi sanciti dalla Direttiva 1999/5/CE.

I clienti possono scaricare la copia del DoC originale per questo prodotto dal nostro server DoC: <http://www.doc.panasonic.de>

Contatto nella EU: Panasonic Services Europe, a Division of Panasonic Marketing Europe GmbH, Panasonic Testing Centre, Winsbergring 15, 22525 Hamburg, F.R.Germany

I prodotti sono stati prodotti per l'uso nei seguenti paesi.

Austria, Belgio, Bulgaria, Repubblica Ceca, Cipro, Danimarca, Estonia, Finlandia, Francia, Germania, Grecia, Irlanda, Islanda, Italia, Lettonia, Lituania, Lussemburgo, Malta, Olanda, Norvegia, Polonia, Portogallo, Romania, Regno Unito, Slovenia, Slovacchia, Spagna, Svezia, Svizzera, Ungheria

Read this first!

България

Това устройство отговаря на съществените изисквания и останалите приложими разпоредби на Директива 1999/5/ЕО.

Česky

Toto zařízení je v souladu se základními požadavky a ostatními odpovídajícími ustanoveními Směrnice 1999/5/EC.

Dansk

Dette udstyr er i overensstemmelse med de væsentlige krav og andre relevante bestemmelser i Direktiv 1999/5/EF.

Eesti

See seade vastab direktiivi 1999/5/EÜ olulistele nõuetele ja teistele asjakohastele sätetele.

Ελληνική

Αυτός ο εξοπλισμός είναι σε συμμόρφωση με τις ουσιώδεις απαιτήσεις και άλλες σχετικές διατάξεις της Οδηγίας 1999/5/ΕC.

Íslenska

Þetta tæki er samkvæmt grunnkröfum og öðrum viðeigandi ákvæðum Tilskipunar 1999/5/EC.

Latviski

Šī iekārta atbilst Direktīvas 1999/5/EK būtiskajām prasībām un citiem ar to saistītajiem noteikumiem.

Lietuvių

Šis įrenginys tenkina 1999/5/EB Direktyvos esminius reikalavimus ir kitas šios direktyvos nuostatas.

Nederlands

Dit apparaat voldoet aan de essentiële eisen en andere van toepassing zijnde bepalingen van de Richtlijn 1999/5/EC.

Malti

Dan I-apparat huwa konformi mal-ħtiġiet essenzjali u I-provedimenti I-oħra rilevanti tad-Direttiva 1999/5/EC.

Magyar

Ez a készülék teljesíti az alapvető követelményeket és más 1999/5/EK irányelvben meghatározott vonatkozó rendelkezéseket.

Norsk

Dette utstyret er i samsvar med de grunnleggende krav og andre relevante bestemmelser i EU-direktiv 1999/5/EF.

Polski

Urządzenie jest zgodne z ogólnymi wymaganiami oraz szczególnymi warunkami określonymi Dyrektywą UE: 1999/5/EC.

Português

Este equipamento está em conformidade com os requisitos essenciais e outras provisões relevantes da Directiva 1999/5/EC.

România

Acest echipament este conform cu cerințele de bază și celelalte prevederi relevante ale Directivei 1999/5/CE.

Slovensko

Ta naprava je skladna z bistvenimi zahtevami in ostalimi relevantnimi pogoji Direktive 1999/5/EC.

Slovensky

Toto zariadenie je v zhode so základnými požiadavkami a inými príslušnými nariadeniami direktív: 1999/5/EC.

Suomi

Tämä laite täyttää direktiivin 1999/5/EY olennaiset vaatimukset ja on siinä asetettujen muiden laitetta koskevien määräysten mukainen.

Svenska

Denna utrustning är i överensstämmelse med de väsentliga kraven och andra relevanta bestämmelser i Direktiv 1999/5/EC.

Easy Setting Function

- ▶ This function enables Input search, Auto PC adjustment, Focus assist, Screen fit and Colorboard by pressing the <AUTO SETUP> button.

Direct Power Off Function

- ▶ With the Direct Power Off function, you can disconnect the power cord from the wall outlet or turn off the breaker even during projection.

Wired and Wireless LAN Function

- ▶ This function allows you to project an image on a computer as well as operate and manage the projector via network.

Useful Functions for Presentations

- ▶ - The digital zoom function allows you to focus on the crucial information during a presentation.
- The MIC function and 10W audio output allows you to make a presentation without any external audio equipment.

Memory Viewer Function

- ▶ Insert the dedicated USB thumb drive into the projector to project images or movie files stored within. You do not have to carry computers or other equipment for a presentation.

Quick steps

For details, see the corresponding pages.

1. **Set up your projector.**
(⇒ page 23)



2. **Connect with other devices.**
(⇒ page 26)



3. **Connect the power cord.**
(⇒ page 27)



4. **Power on.**
(⇒ page 29)



5. **Select the input signal.**
(⇒ page 32)



6. **Adjust the image.**
(⇒ page 32)

Contents

Be sure to read "Read this first!". (→ pages 2 to 8)

Important Information

Read this first!	2
Declaration of Conformity	7
Contents	10
Precautions for Use	12
Cautions when transporting.....	12
Cautions when installing.....	12
Security	13
Disposal.....	13
Cautions on use	14
Accessories	15
Optional accessories	16

Preparation

About Your Projector	17
Remote control	17
Projector body	19
Control panel	20
Rear terminals	21
Using Remote control	22
Installing and Removing batteries	22
Setting Remote control ID numbers	22

Getting Started

Setting up	23
Projection method	23
Parts for ceiling mount (Optional).....	23
Screen size and throw distance	24
Adjusting front adjustable feet	25
Connections	26
Before connecting to the projector	26
Connecting example.....	26

Basic Operation

Powering ON/OFF	27
Connecting the power cord	27
POWER indicator	28
Turning On the Projector	29
Enter a PIN code	30
PIN code Protection	30
Turning Off the Projector	31
Projecting	32
Adjusting the image manually	32
Adjusting the image automatically	32

Basic operations by using the remote control..... 34

Using the AUTO SET function.....	34
Using the IMAGE button.....	34
Using the MENU button.....	34
Using the INFO. button.....	34
Controlling the volume of the speaker.....	34
Using the wireless mouse function	35
Using the PAGE button	35
Using the POINTER button	35
Using the KEYSTONE button.....	35
Switching the input signal.....	36
Using the MUTE button	36
Using the D.ZOOM buttons.....	36
Using the FREEZE function	37
Using the AV MUTE function	37
Using the SCREEN button	37
Using the P-TIMER button	37
Using the LAMP button	37

Settings

Menu Navigation	38
Navigating through the menu	38
Main menu.....	39
Sub menu	39
Input menu	41
Computer 1: RGB/Component /RGB (Scart)	41
Computer 2: RGB.....	41
HDMI	41
Video	41
S-video	41
Network	42
AUTO PC adjust	43
AUTO PC adj.....	43
Manual PC adjust	44
Fine sync.....	44
Total dots	44
Horizontal	44
Vertical.....	44
Current mode	45
Clamp	45
Display area H.....	45
Display area V	45
Reset	45
Mode free	45
Store.....	45
Image select	46
Dynamic	46
Standard.....	46

Real	46	Direct on	57
Cinema	46	Standby mode	57
Blackboard(Green)	46	P-timer	58
Colorboard.....	46	Closed caption.....	58
Image 1-4	46	Lamp power.....	59
Image adjust.....	47	Remote control	59
Contrast.....	47	Security	59
Brightness	47	Fan	60
Color.....	47	Fan control	60
Tint	47	Video delay control.....	60
Color temp.....	47	Filter counter	60
Red	48	Total power savings.....	61
Green	48	Warning log	61
Blue	48	Factory default.....	61
Sharpness	48	Information.....	62
Gamma.....	48	Input Source Information Display	62
Noise reduction	48		
Progressive	49		
Reset	49		
Store.....	49		
Screen	50		
Normal.....	50		
Full	50		
Wide(16:9).....	50		
Zoom	50		
True	50		
Custom	50		
Custom adj.	50		
Digital zoom +.....	51		
Digital zoom -	51		
Keystone	51		
Ceiling	51		
Rear.....	52		
Reset	52		
Sound	53		
Volume	53		
Mute	53		
MIC	53		
MIC gain	53		
Standby MIC out.....	53		
Setting	54		
Language	54		
Menu position.....	54		
Auto setup	54		
Background	55		
Display.....	55		
Logo	56		
HDMI setup	56		
USB terminal	56		
Pointer	57		
Terminal.....	57		
Power management	57		

Maintenance

LAMP REPLACE and WARNING Indicators..... 63

Managing the indicated problems 63

Replacement 64

Before replacing the unit 64

Maintenance..... 64

Replacing the unit..... 64

Attaching the Lens Cap 68

Troubleshooting 69

Appendix

Technical Information 71

Serial terminal

Other terminals.....

List of compatible signals

Specifications 80

Dimensions.....

Ceiling mount bracket safeguards..... 82

Index 83

Precautions for Use

Cautions when transporting

- When transporting the projector, hold it securely by its bottom and avoid excessive vibration and impacts. Doing so may damage the internal parts and result in malfunctions.
- Do not transport the projector with the adjustable feet extended. Doing so may damage the adjustable feet.

Cautions when installing

■ Do not set up the projector outdoors.

- The projector is designed for indoor use only.

■ Do not use under the following conditions.

- Places where vibration and impacts occur such as in a car or vehicle: Doing so may damage the internal parts and result in malfunctions.
- Near the exhaust of an air conditioner or near lights (studio lamps, etc.) where temperature changes greatly (Operating environment ➔page 81): Doing so may shorten the life of the lamp or result in deformation of the outer case and malfunctions.
- Near high-voltage power lines or near motors: Doing so may interfere with the operation of the projector.

■ Do not install the projector at elevations of 2700 m (8858 ft) or higher above sea level.

Failure to do so may shorten the life of the internal parts and result in malfunctions.

■ Do not use the projector installed vertically or tilted right or left (➔page 23).

Using the projector at a vertical angle that exceeds 40° may reduce product life or result in malfunction.

■ Be sure to ask a specialized technician when installing the product to a ceiling.

If the product is to be installed hanging from the ceiling, purchase an optional Ceiling Mount Attachment (Optional accessories ➔page 16).

Please call a specialized technician or contact an Authorized Service Center for installation.

Cautions when setting the projectors

- Do not stack the projectors.
- Do not block the ventilation ports (intake and exhaust) of the projector.
- Avoid heating and cooling air from the air conditioning system directly blow to the ventilation ports (intake and exhaust) of the projector.

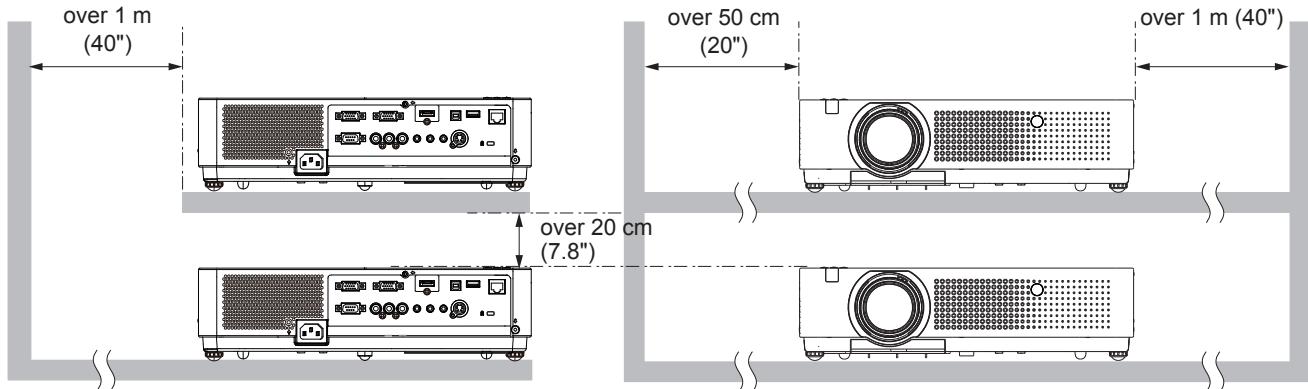
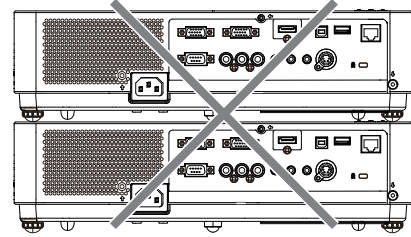

- Do not place the projector in an enclosed space. If you need to place the projector in an enclosed space, additional air conditioning and ventilation system must be equipped. When ventilation is insufficient, remaining heat may trigger the protection circuit of the projector.

Security

Take safety measures against following incidents.

- Personal information being leaked via this product.
- Unauthorized operation of this product by a malicious third party.
- Interfering or stopping of this product by a malicious third party.

Security instruction (➔ page 59)

- Make your password as difficult to guess as possible.
- Change your password periodically.
- Panasonic or its affiliate company never inquires a password directly to a customer. Do not tell your password in case you receive such an inquiry.
- The connecting network must be secured by firewall or others.
- Set a password and restrict the users who can log in.

Disposal

When disposing of the product, ask your local authority or dealer about the correct methods of disposal. The lamp contains mercury. When disposing of the used lamp unit, ask your nearest local authorities or dealer about proper disposal of the unit. Dispose of used batteries according to the instructions or your local disposal rule or guidelines.

Precautions for Use

Cautions on use

■ In order to get the picture quality

- Draw curtains or blinds over windows and turn off any lights near the screen to prevent outside light or light from indoor lamps from shining onto the screen.
- Depending on where the projector is used, heated air from an exhaust port or warm or cold air from an air conditioner can cause a shimmering effect on screen.
Avoid use in locations where exhaust or streams of air from projector, other devices and air conditioners flow between the projector and the screen.
- The lens of projector is affected by the heat from the luminous source. Because of this, the focusing may not be stable right after the power is turned on. Focusing is stabled after projecting image for 30 minutes and longer.

■ Do not touch the surface of the projector lens with your bare hand.

If the surface of the lens becomes dirty from fingerprints or anything else, this will be magnified and projected onto the screen.

■ LCD Panel

The display unit of this projector comprises three LCD panels. Although an LCD panel is a product of high-precision technology, some of the pixels on the projected image may be missing or constantly lit. Please note that this is not a malfunction.

Displaying a still image for a longer time may result in an after-image on the LCD panels. If this happens, display the all white screen in the test pattern for an hour or more.

■ Optical components

Operating the projector in an environment with high temperature or heavy exposure to dust or tobacco smoke will reduce the service life of the optical components, such as the LCD panel and polarizing plate, and may necessitate their replacement within less than one year of use. For details, consult your dealer.

■ Lamp

The luminous source of the projector is a mercury lamp with high internal pressure.

A high pressure mercury lamp has following characteristics.

- The brightness of the lamp will decrease by duration of usage.
- The lamp may burst with sound or shorten life by shock or chipping.
- The life of the lamp varies greatly depending on individual specificities and usage conditions. In particular, continuous use over 12 hours and frequent on/off switching of the power greatly deteriorate the lamp and affect the lamp life.
- In rare cases, the lamp burst shortly after the projection.
- The risk of bursting increases when the lamp is used beyond its replacement cycle. Make sure to replace the lamp unit consistently. ("When to replace the lamp unit" (➡ page 66))
- If the lamp bursts, gas contained inside of the lamp is released in a form of smoke.
- It is recommended to store replacement lamps for contingency.
- It is recommended to have authorized engineer or your dealer replace the lamp unit.

<Software information regarding this product>

© Panasonic Corporation 2011

This product incorporates the following software:

(1)the software which is developed independently by or for Panasonic Corporation

(2)the software which is licensed under the GNU GENERAL PUBLIC LICENSE,

and

(3)the software which is licensed under the GNU LESSER GENERAL PUBLIC LICENSE.

For the software categorized as (2) and (3), the license is available in accordance with GNU GENERAL PUBLIC LICENSE and GNU LESSER GENERAL PUBLIC LICENSE respectively. As for the terms and conditions, please refer to the software licence of the supplied CD-ROM.

If you wish to ask any questions as to the software, please contact (sav.pj.gpl.pavc@ml.jp.panasonic.com) by email.

Pursuant to at the directive 2004/108/EC, article 9(2)







Panasonic Testing Centre

Panasonic Service Europe, a division of Panasonic Marketing Europe GmbH

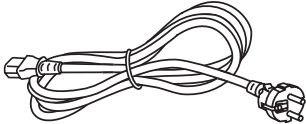
Winsbergring 15, 22525 Hamburg, F.R. Germany

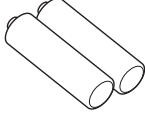
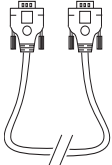
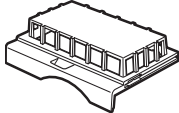
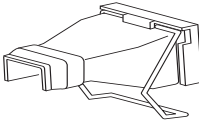
Accessories

Make sure the following accessories are provided with your projector. Numbers in the brackets () show the number of accessories.

Remote control unit (x1) (6451049759)	Power cord (x1) (6103580203)	CD-ROM (x1) (6103569512)	Batteries (AAA/R03 or AAA/LR03 type) (x2)
			 (for remote control unit)
RGB signal cable (x1) (6103580425)	Filter cover (x1) (6103568881)	AC power cord holder (x1) (6103573700) (6103573694)	Lens cap (x1) (6103545790)
			
String (x1) (6103430249)	PIN Code Label (x1)	Soft Carrying Case (x1) (6103581620)	
			

Attention

- After unpacking the projector, discard the power cord cap and packaging material properly.
- For lost accessories, consult your dealer.
- The part numbers of accessories and separately sold components are subject to change without notice.
- Store small parts in an appropriate manner, and keep them away from young children.

Precautions for Use

■ Contents of the supplied CD-ROM

The contents of the supplied CD-ROM are as follow.

[●: Instructions/List (PDF), ○: Software]

● **Operating Instructions – Projector Operations.**

● **Operating Instructions – Network Operations.**

○ **Multi Projector Monitoring & Control Software 2.6(Windows)**

- This software allows you to monitor and control multiple projectors connected to the LAN.

● **Operation Manual Multi Projector Monitoring & Control Software 2.6**

○ **Logo Transfer Software 2.0(Windows)**

- This software allows you to create original images, such as company logos to be displayed when projection starts, and transfer them to the projector.

● **Operation Manual Logo Transfer Software 2.0**

○ **Wireless Manager ME5.5(Windows/Macintosh)**

- This software allows you to send computer screen displays over wireless/wired LAN.

● **Operation Manual Wireless Manager ME5.5**

● **List of compatible projector models**

- This is a list of projectors that are compatible with the software marked with the “○” symbols above, and their restrictions.

● **Software license**

(GNU GENERAL PUBLIC LICENSE and GNU LESSER GENERAL PUBLIC LICENSE)

Optional accessories

Options	Model No.
Ceiling Mount Bracket	ET-PKV100H (for high ceilings), ET-PKV100S (for low ceilings)
Projector Mount Base	ET-PKV100B
Replacement Lamp Unit	ET-LAV100
Replacement Filter Unit	ET-RFV100

About Your Projector

Remote control

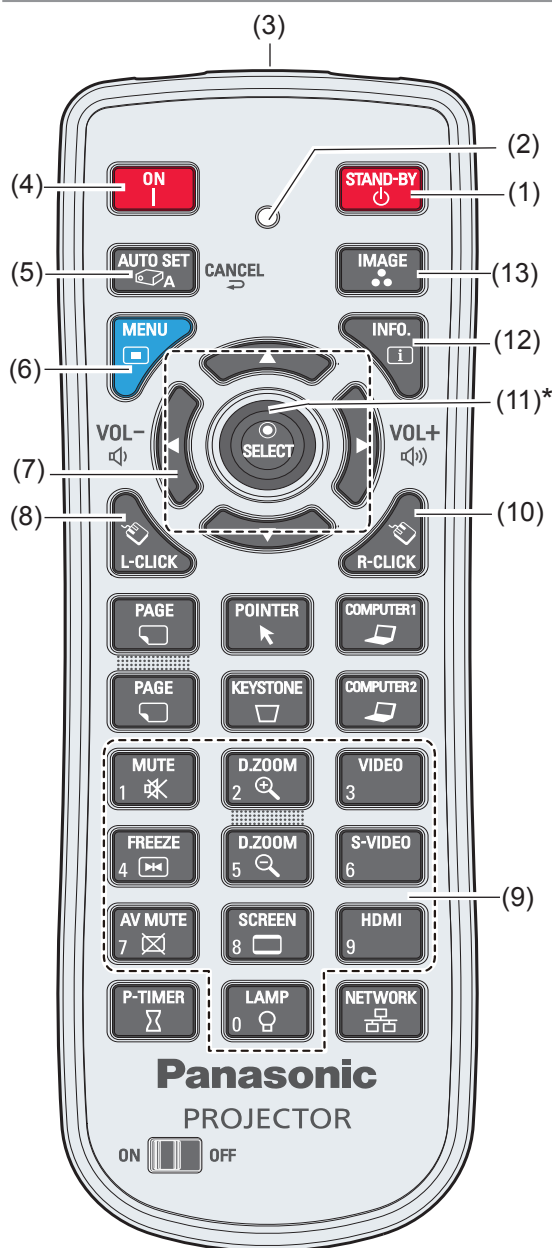

* Center part is <SELECT> Button.
Outer part is <MOUSE POINTER> Button.

(1) <STAND-BY> Button

Turn the projector off (➔page 31).

(2) Signal Emission indicator

Light red while a signal is being sent from the remote control to the projector.

(3) Remote control signal emitter

(4) <ON> Button

Turn the projector on (➔page 29).

(5) <AUTO SET/CANCEL> Button

Execute the setting of Auto setup in the setting menu (➔page 54).

Cancel the playing of the memory viewer function. (Refer to "Operating Instructions - Network operations").

(6) <MENU> Button

Open or close the On-Screen Menu (➔page 38).

(7) ▲ ▼ ◀ ▶ (VOL-/+) Buttons , <SELECT> Button

- Navigate the MENU display.
- Adjust the volume level or mute the sound.

(8) <L-CLICK> Button

Act as the left mouse button for wireless mouse operation (➔page 35).

(9) Number Buttons

Act as number buttons. Use these buttons when setting the remote control codes (➔page 22) or entering the PIN code numbers (➔page 30).

(10) <R-CLICK> Button

Act as the right mouse button for wireless mouse operation (➔page 35).

(11) <MOUSE POINTER> Button

Move a pointer of the projector or a pointer for wireless mouse operation (➔page 35).

(12) <INFO.> Button

Operate the information function (➔page 62).

(13) <IMAGE> Button

Select the image mode (➔page 34).

Note

- The remote control can be used as a wireless mouse for your computer.
- Before operating the wireless mouse, connect your computer and the projector with a USB cable (➔page 35).
- When a USB cable is connected to the computer and the projector, turn on the projector first, then the computer.
- (8), (10), (11), (15) are available when a USB cable is connected to the computer and the projector.

About Your Projector

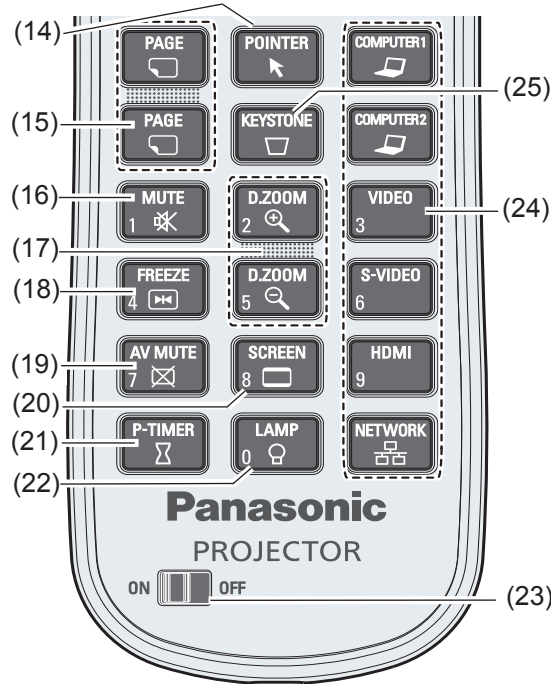

(14) <POINTER> Button

Act as the On-Off switch for the Pointer.
(➡page 35)

(15) <PAGE > Buttons

Scroll back and forth the pages on the screen when giving a presentation. To use these buttons, connect the projector and your computer with a USB cable.

(16) <MUTE> Button

Mute the sound. (➡page 36)

(17) <D.ZOOM +/-> Buttons

Zoom in and out the images. (➡page 51)

(18) <FREEZE> Button

Pauses the projected image and sound tentatively. (➡page 37)

(19) <AV MUTE> Button

Temporarily turn off the image on the screen.
(➡page 37)

(20) <SCREEN> Button

Select a screen mode. (➡page 50)

(21) <P-TIMER> Button

Operate the P-timer function. (➡page 37)

(22) <LAMP> Button

Select a lamp mode. (➡page 37)

(23) ON/OFF switch

When using the remote control, set this switch to "ON". Set it to "OFF" for power saving when it is not in use.

(24) Input Selection buttons: <COMPUTER 1>, <COMPUTER 2>, <HDMI>, <VIDEO>, <S-VIDEO>, <NETWORK>.

These buttons are used to select the input signal.
(➡page 36)

(25) <KEYSTONE> Button

Correct keystone distortion. (➡page 35)

Attention

- Do not drop the remote control.
- Avoid contact with liquids.
- Do not attempt to modify or disassemble the remote control.

Note

- The remote control can be used within a distance of about 5 m (16.4 ft) if pointed directly at the remote control signal receiver. The remote control can control at angles of up to $\pm 30^\circ$ vertically and $\pm 30^\circ$ horizontally, but the effective control range may be reduced.
- If there are any obstacles between the remote control and the remote control signal receiver, the remote control may not operate correctly.
- You can operate the projector by reflecting the remote control signal on the screen. The operating range may differ due to the loss of light caused by the properties of the screen.
- When the remote control signal receiver is lit with a fluorescent light or other strong light source, the projector may become inoperative. Set the projector as far from the luminous source as possible.

Projector body

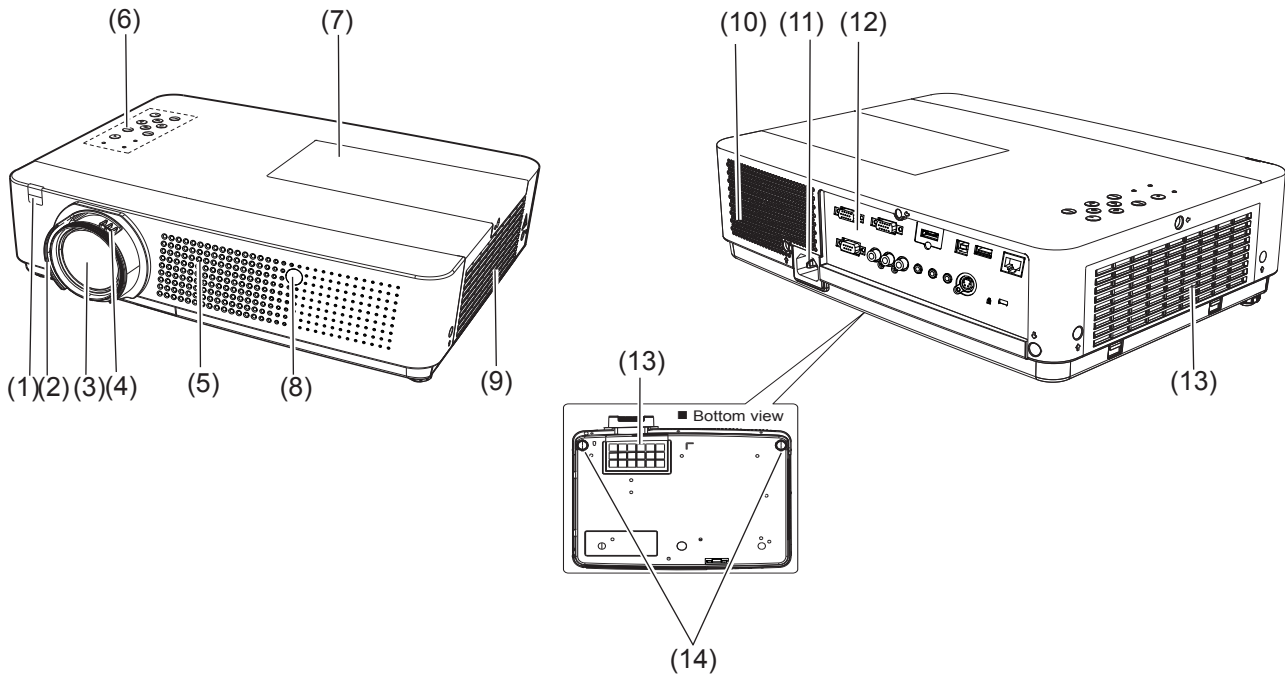

- (1) Remote control signal receiver**
- (2) Focus Ring**
Adjusts the focus.
- (3) Projection Lens**
- (4) Zoom Lever**
Adjusts the zoom.
- (5) Air intake port**
- (6) Control Panel and Indicators** (➔page 20)
- (7) Lamp cover** (➔page 67)
The lamp unit is located inside.
- (8) Camera window** (➔page 55)
The camera is capable of [Screen fit], [Focus assist] and [Coloboard] functions.
- (9) Air outlet port**
Hot air is exhausted from the exhaust vent. Do not put heat-sensitive objects near this side.
- (10) Speaker**
- (11) AC IN**
- (12) Terminals** (➔page 21)
- (13) Air intake port / Air filter cover** (➔page 64)
- (14) Adjustable feet**
Adjusts the projection angle.

WARNING:

- **Keep your hands and other objects away from the air exhaust port.**
- Keep your hand and face away.
- Do not insert your finger.
- Keep heat-sensitive articles away.

Heated air from the air exhaust port can cause burns or external damage.

About Your Projector

Control panel

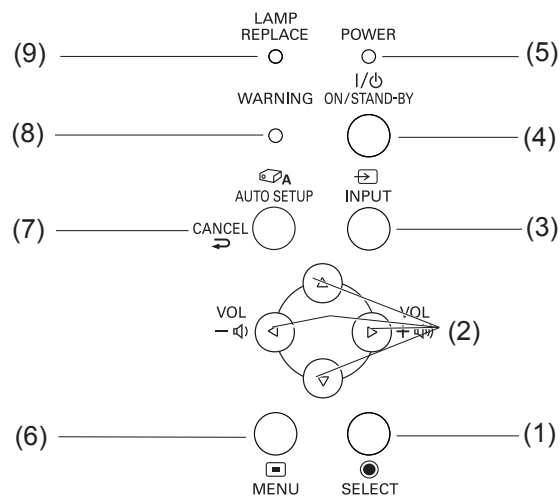

(1) <SELECT> Button

Execute the selected item.

(2) ▲ ▼ ◀ ▶ (VOL -/+) Buttons

- Navigate the MENU display.
- Adjust the volume level or mute the sound.

(3) <INPUT> Button

Selects the input signal. (➔page 36)

(4) <ON/STAND-BY> Button

Turn the projector on/off.

(5) <POWER> indicator

Indicate the power status.

(6) <MENU> Button

Displays the MENU screen. (➔page 38)

(7) <AUTO SETUP/CANCEL> Button

Execute the setting of Auto setup in the setting menu. (➔page 54)
Cancel the playing of the memory viewer function. (Refer to "Operating Instructions - Network operations").

(8) <WARNING> indicator

Indicate the abnormal conditions of the projector.

(9) <LAMP REPLACE> indicator

Lights yellow when the projection lamp reaches its end of life.

Rear terminals

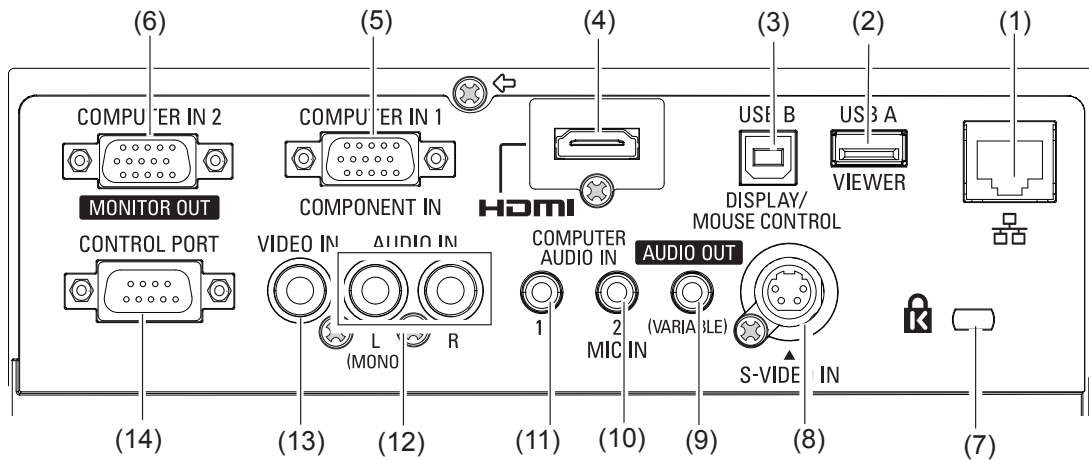

(1) LAN

Connects to a LAN cable for network connection.

(2) USB Connector (Series A)

Insert the USB thumb drive directly (refer to "Operation Instructions, Network operations").

(3) USB Connector (Series B)

- In order to operate the computer with the remote control and use the <PAGE> buttons on the remote control during a presentation, connect the USB port of the computer to the USB terminal with a USB cable (not supplied).
- The projector provides the "USB display" function that the image and sound are sent to the projector by connecting the computer to the projector with a USB cable.

For details, please refer to the "Operation Manual Wireless Manager ME5.5" in CD-ROM.

(4) HDMI

Connects to HDMI input signals.

(5) COMPUTER IN 1/ COMPONENT IN

Connects to COMPUTER IN 1/ COMPONENT IN input signals.

(6) COMPUTER IN 2/ MONITOR OUT

Connects to COMPUTER IN 2/MONITOR OUT input signals or outputs the analog RGB signals input the projector.

(7) Security slot

Attach the commercial shackle lock, manufactured by Kensington, to protect your projector. Compatible with the Kensington MicroSaver Security System.

(8) S-VIDEO IN

Connects to S-VIDEO input signals.

(9) AUDIO OUT (VARIABLE)

Outputs the audio signals input to the projector.

(10) COMPUTER AUDIO IN 2 (MIC IN)

Connects to the audio input signals. Or connect the MIC to the this jack.

(11) COMPUTER AUDIO IN 1

Connects to the audio input signals.

(12) AUDIO IN

Connects to the audio input signals. AUDIO IN has left and right (L and R) terminals.

(13) VIDEO IN

Connects to VIDEO input signals.

(14) CONTROL PORT

Connects to a computer via an RS-232C cable.

Attention

- When a LAN cable is directly connected to the projector, the network connection must be made indoors.

Using Remote control

Installing and Removing batteries

1) Open the cover

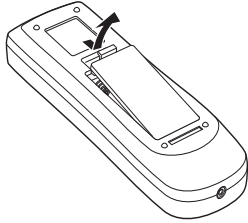

2) Install batteries and close the cover (Insert the – side first.)

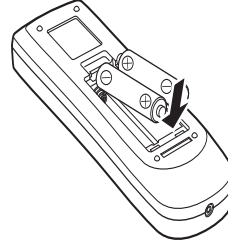

- Remove the batteries in the reverse order of installation.

Setting Remote control ID numbers

When you use the system with multiple projectors, you can operate all the projectors simultaneously or each projector individually using single remote control, if unique ID number is assigned to each projector. After setting the ID number of the projector, set the same ID number to the remote control. There are 7 different ID codes (ALL, Code 1~Code 6), the initial ID number is [ALL].

■ Setting the ID number

- 1) While holding down the <MENU> button, press the Number Buttons, the number you press the Number buttons corresponds to the desired ID code number.
- 2) The number you press the number buttons are as follows: Code 1= <1 MUTE>, Code 2= <2 D.ZOOM +>, Code 3= <3 VIDEO>, Code 4= <4 FREEZE>, Code 5= <5 D.ZOOM ->, Code 6= <6 S-VIDEO>.
- 3) The ID code is reset to [ALL] (default) by pressing the <MENU> button and <0 LAMP> button at the same time for 5 seconds or more.

Attention

- The status of the ID code is not stored after replacing batteries.

Note

- For details, please refer to the [Remote control] of the [Setting] menu. (➡ page 59)

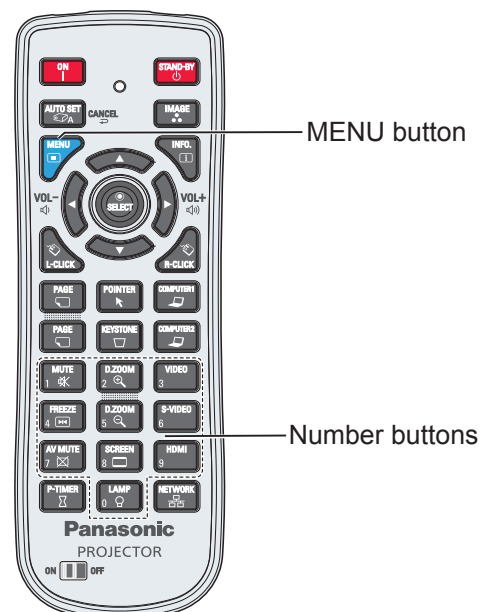

Setting up

Projection method

You can use the projector with any of the following 4 projection methods. To set the desired method in the projector.

■ Mounting on the ceiling and projecting forward

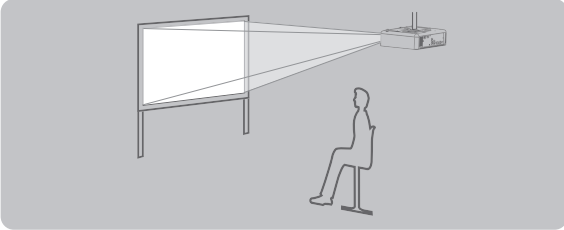

■ Setting on a desk/floor and projecting from rear

(Using translucent screen)

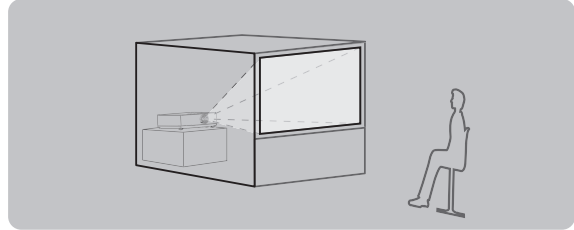

■ Mounting on the ceiling and projecting from rear

(Using translucent screen)

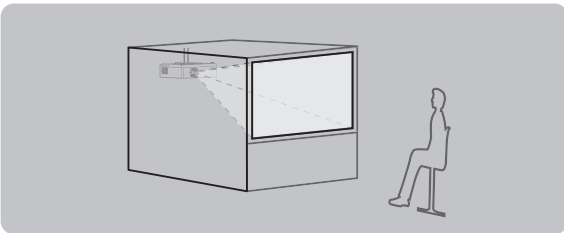

■ Setting on a desk/floor and projecting forward

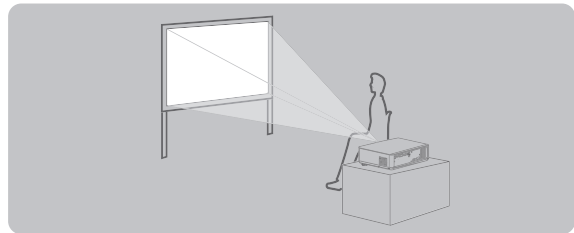

Attention

- For optimum viewing quality, install the projector in a location where screen exposure to outside light, light from light fixtures or other light is at a minimum. Also draw the curtains, close blinds and turn off light fixtures.
- Do not use the projector installed vertically or tilted right or left. Use under such conditions could result in equipment damage.
- The projector must be installed so that its inclination to the horizontal plane is $\pm 40^\circ$ or less.
- Installing the projector at an inclination that exceeds 40° may reduce product life or result in malfunction.

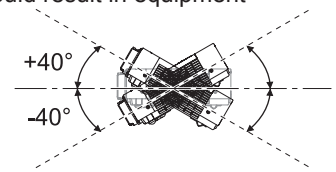

Parts for ceiling mount (Optional)

You can install the projector on the ceiling by using the optional ceiling mount bracket (ET-PKV100H: for high ceiling, ET-PKV100S: for low ceiling), and the optional projector mount base ET-PKV100B.

- Use only the ceiling mount brackets specified for this projector.
- Refer to the installation manual for the ceiling mount bracket when you install the bracket and the projector.

Attention

- To ensure projector performance and security, installation of the ceiling mount bracket must be carried by your dealer or a qualified technician.

Setting up

Screen size and throw distance

Place the projector referring to the diagram on the right and the figures of throwing distance. You can adjust the display size

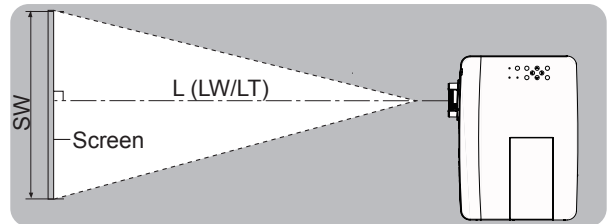
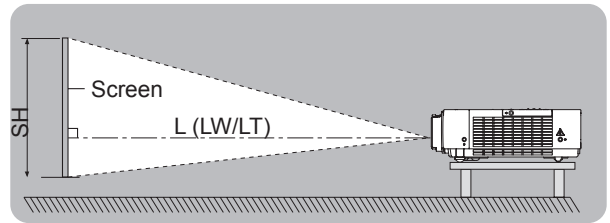
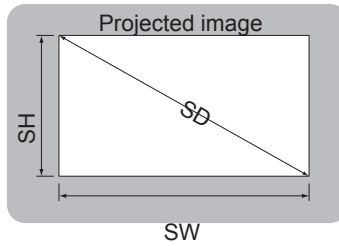

L (LW/LT) *1	Projection distance (m)
SH	Height of the projection area (m)
SW	Width of the projection area (m)
SD	Diagonal length of the projection area (m)

*1 : LW : Minimum distance
LT : Maximum distance

Attention

- Before installing, please read "Precautions for Use" (▶ pages 12 to 16).

Projection distance for PT-VX400NTE

(All measurements below are approximate and may differ slightly from the actual measurements.)

Projection size	For 4:3 aspect ratio		For 16:9 aspect ratio	
	Minimum distance (LW)	Maximum distance (LT)	Minimum distance (LW)	Maximum distance (LT)
0.76 m(30")	0.7 m(2.26')	1.1 m(3.74')	0.8 m(2.49')	1.2 m(4.07')
1.02 m(40")	0.9 m(3.05')	1.5 m(5.02')	1.0 m(3.35')	1.7 m(5.48')
1.27 m(50")	1.2 m(3.87')	1.9 m(6.30')	1.3 m(4.23')	2.1 m(6.89')
1.52 m(60")	1.4 m(4.66')	2.3 m(7.58')	1.6 m(5.09')	2.5 m(8.27')
1.78 m(70")	1.7 m(5.45')	2.7 m(8.86')	1.8 m(5.94')	3.0 m(9.68')
2.03 m(80")	1.9 m(6.23')	3.1 m(10.14')	2.1 m(6.82')	3.4 m(11.06')
2.29 m(90")	2.2 m(7.05')	3.5 m(11.42')	2.3 m(7.68')	3.8 m(12.47')
2.54 m(100")	2.4 m(7.84')	3.9 m(12.73')	2.6 m(8.53')	4.2 m(13.88')
3.05 m(120")	2.9 m(9.42')	4.7 m(15.29')	3.1 m(10.27')	5.1 m(16.67')
3.81 m(150")	3.6 m(11.81')	5.8 m(19.13')	3.9 m(12.86')	6.4 m(20.83')
5.08 m(200")	4.8 m(15.78')	7.8 m(25.52')	5.2 m(17.19')	-
6.35 m(250")	6.0m(19.75')	-	6.6 m(21.52')	-
7.62 m(300")	7.2 m(23.72')	-	7.9 m(25.85')	-

Any other projection distance can be obtained according to the screen dimensions (m) using the following calculations. The distance is shown in units of meters. (The calculated distance may contain a certain error.)

If the screen dimensions are written as "SD",

	For 4:3 aspect ratio	For 16:9 aspect ratio
Screen height (SH)	= SD(m) × 0.6	= SD(m) × 0.490
Screen width (SW)	= SD(m) × 0.8	= SD(m) × 0.872
Minimum distance (LW)	= 0.9531 × SD(m) - 0.0338	= 1.0384 × SD(m) - 0.0337
Maximum distance (LT)	= 1.5384 × SD(m) - 0.0327	= 1.6756 × SD(m) - 0.0319

Adjusting front adjustable feet

Lift the front of the projector and press the feet lock latches on both side of the projector. Release the feet lock latches to lock the adjustable feet and rotate the adjustable feet to a proper height and tilt. You can turn the front adjustable feet to extend them. You can turn them in the opposite direction to contract them.

(You can adjust the projection angle vertically.)

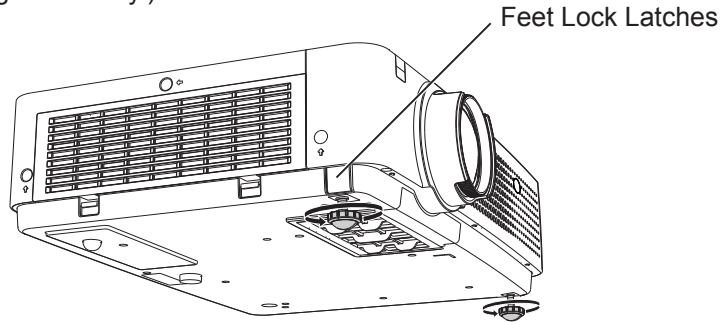

Adjustable range
Front adjustable feet : 41.2 mm(1.622")

Attention

- Heated air comes out of the air exhaust port while the lamp is lit. Do not touch the air exhaust port directly when you adjust the front adjustable feet.
- If keystone distortion occurs on the projected image, perform "KEYSTONE" from the "Screen" menu. (➡page 51)

Note

- Screw up the adjustable feet, and an audible click will be heard as the limit.

Connections

Before connecting to the projector

- Read carefully the instruction manual for the device to be connected.
- Turn off the power switch of the devices before connecting cables.
- If any connection cable is not supplied with the device, or if no optional cable is available for connection of the device, prepare a necessary system connection cable to suit the device.
- Video signals containing too much jitter may cause the images on the screen to randomly wobble or wafture. In this case, a time base corrector (TBC) must be connected.
- The projector accepts the following signals: VIDEO, S-VIDEO, analogue-RGB (with TTL sync. Level) and digital signal.
- Some computer models are not compatible with the projector.
- When using long cables to connect with each of equipment to the projector, there is a possibility that the image will not be output correctly unless a compensator is used.
- For details on what video signals the projector supports, see “List of compatible signals”. (➔page 76)

Connecting example

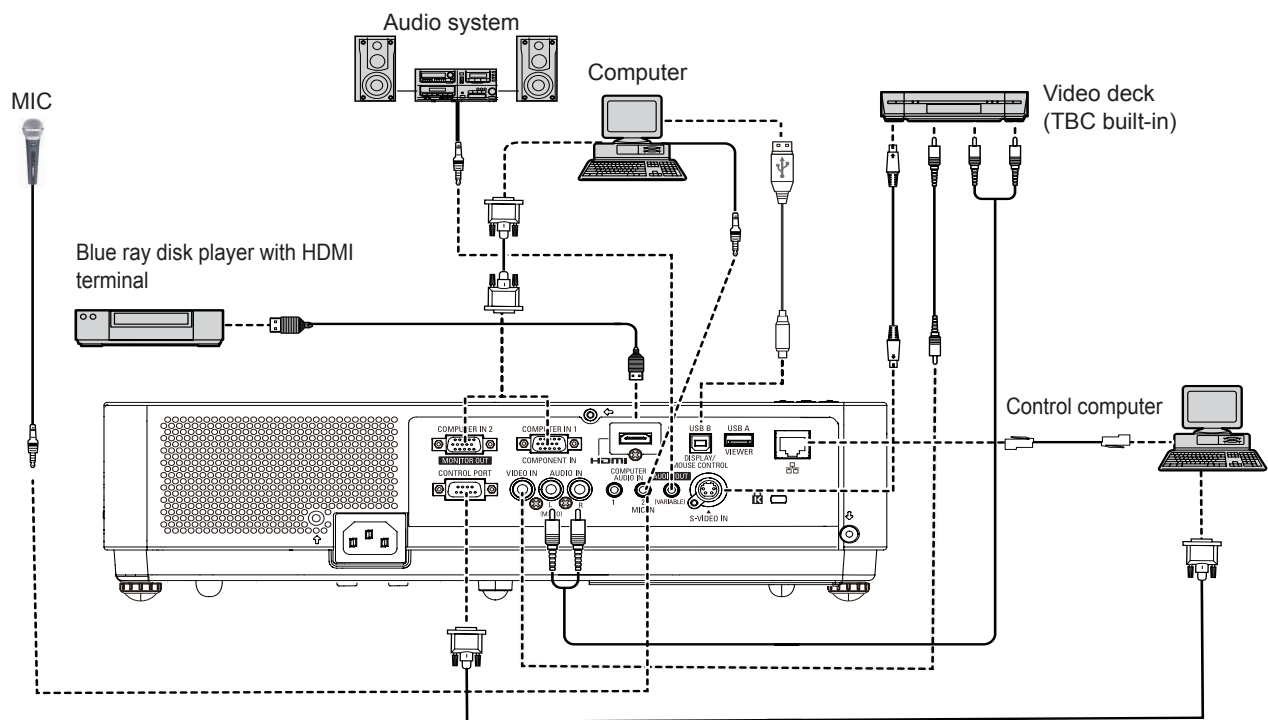

Attention

- When connecting with a video deck, be sure to use the one with a built-in time base corrector (TBC) or use a TBC between the projector and the video deck.
- If nonstandard burst signals are connected, the image may be distorted. If this is the case, connect a TBC between the projector and the video deck.

Note

- When using an HDMI cable, check that it is compliant with the HDMI standard. Using a cable that is not compliant with the HDMI standard may result in problems such as the image cutting out or not appearing. When connecting the 1080p signal using HDMI, use a cable compliant with 1080p signal.
- This projector does not support the Viera link (HDMI).
- For the specifications of the RGB signals that can be applied from the PC, refer to “List of compatible signals”. (➔page 76)
- See “Network operation” in the instruction manual on the supplied CD-ROM for the details of wired LAN and wireless communication between the projector and the computer.

Powering ON/OFF

Connecting the power cord

Be sure to insert the attached power cord securely to its base to prevent it from coming off.

■ Power cord holder

A power cord holder is designed to prevent the AC power cord from coming off the projector. Please insert the power cord into the power cord holder correctly as Picture (1) shown:

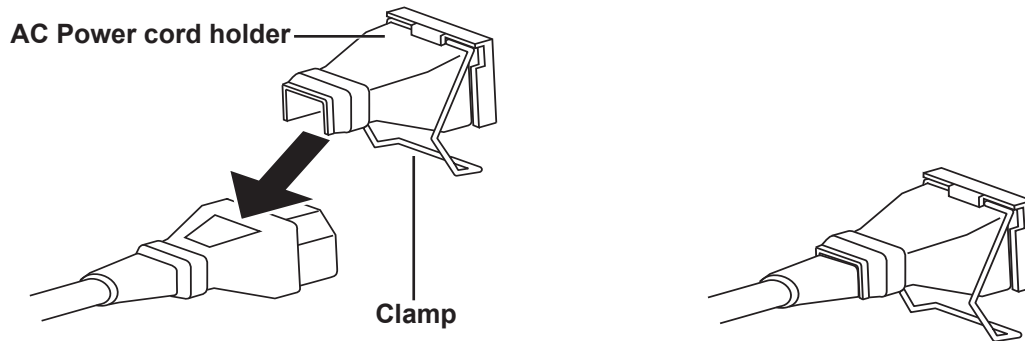

Picture (1)

■ Attaching

Attach the AC power cord with the power cord holder to the projector by following these steps.

- 1) Plug the power cord with the power cord holder to the projector as Picture (2) shown.
- 2) Push the clamp at the AC Power cord holder downward to secure it to the projector. It is correctly attached until you hear the "CLICK" sound. See Picture (3) for correct attachment.

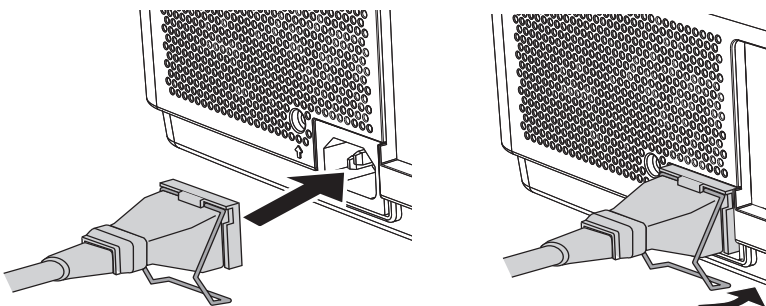

Picture (2)

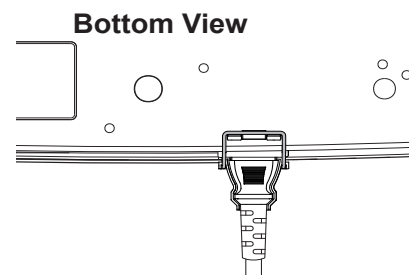

Picture (3)

Powering ON/OFF

POWER indicator

The power indicator informs you the status of the power. Confirm the status of the <POWER> indicator before operating the projector.

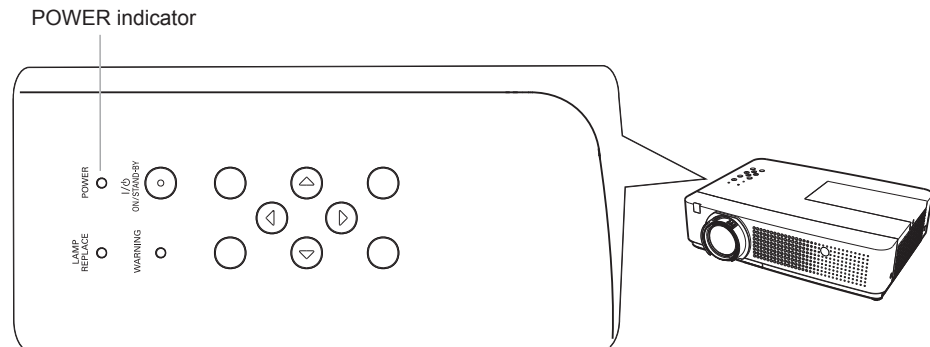

Indicator status		Status
No illumination or flashing		The power cord is unplugged.
RED	Lit	The power cord is plugged.
		The projector is in stand-by mode, after the cooling is completed.
	Flashing	The projector cannot be turned on until the normal power-off processing for fan cooling is completing and the <POWER> indicator stops blinking.
		The temperature inside the projector is abnormally high. And the <WARNING> indicator also blinks in red (➔page 63). The projector cannot be turned on until cooling is completing and the <POWER> indicator stops blinking.
GREEN	Lit	Projecting.
	Flashing	The projector is in the Power management mode.

Turning On the Projector

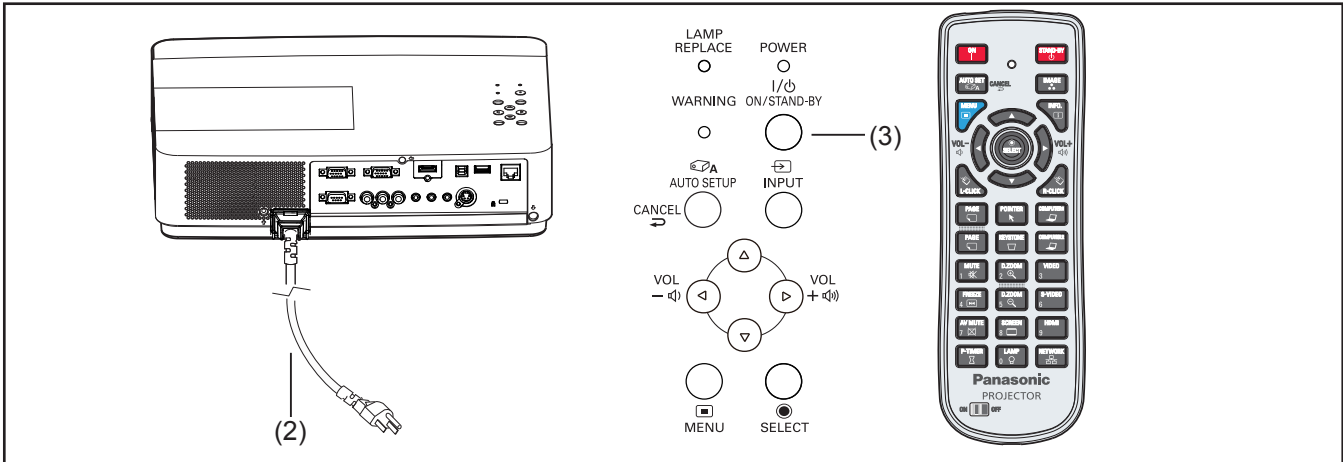

- 1) Complete peripheral connections (with a computer, VCR, etc.) before turning on the projector.
- 2) Connect the projector's AC power cord into an AC outlet. The <POWER> indicator lights red. Open the lens cap.
- 3) Press the <ON/STAND-BY> button on the control panel or the <ON> button on the remote control. The <POWER> indicator lights green and the cooling fans start to operate. The preparation display appears on the screen and the count down starts.
- 4) After the countdown, the input source that was selected the last time and the lamp power status icon appear on the screen.
- 5) If there is no signal input when start on the projector, or the current signal is missed while operating the projector, the Video/Computer selection window will be displayed on the screen, please move the pointer to input source desired by pressing the ▲ ▼ and the <SELECT> button. And then follow the input signal guidance window to correct the signal and connection.

If the projector is locked with a PIN code, PIN code input dialog box will appear. Enter the PIN code as instructed on the next page.

Note

- When the [Logo select] function is set to [Off], the logo will not be shown on the screen (➡ page 56).
- When [Countdown off] or [Off] is selected in the [Display] function, the preparation display will not be shown on the screen (➡ page 55).
- When the [Input search] function is set to [On 2], the input signal will be searched automatically (➡ page 54).
- When the [Direct on] function is set to [On], the projector will be turned on automatically by connecting the AC power cord to an AC outlet.

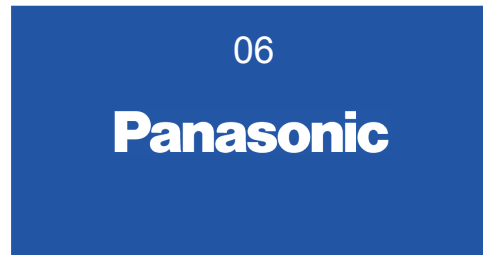

The preparation display will disappear after 30 seconds.

Selected Input Source and Lamp power

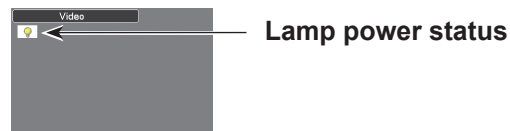

Video/Computer selection



Powering ON/OFF

Enter a PIN code

■ When using the control panel

Press ▲▼ to enter a number. Press ► to fix the number and move the red frame pointer to the next box. The number changes to *. If you fixed an incorrect number, use the ◀ button to move the pointer to the number you want to correct, and then enter the correct number.

Repeat this step to complete entering a four-digit number.

After entering the four-digit number, move the pointer to "Set". Press the <SELECT> button so that you can start to operate the projector.

■ When using the remote control

Press the Number buttons on the remote control to enter a number (►page 17). When you complete entering a four-digit number, the pointer moves to "Set". Press the <SELECT> button so that you can start to operate the projector.

If you fix an incorrect number, use the ◀ button to move the pointer to the number you want to correct, and then enter the correct number.

If you entered an incorrect PIN code, PIN code and the number (****) will turn red for a moment. Enter the correct PIN code all over again.

Note

- If the PIN code number is not entered or wrong PIN code number is entered within three minutes after the PIN code dialog box appeared, the projector will be turned off automatically.
- The "1234" is set as the initial PIN code at the factory.

PIN Code Input Dialog Box

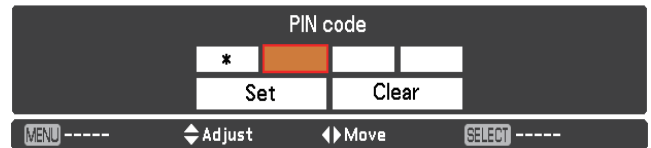

After the "OK" icon disappears, you can operate the projector.

OK

PIN code Protection

While the projector is locked with the PIN code.

Put the label below (supplied) on in a prominent place of the projector's body while it is locked with a PIN code.

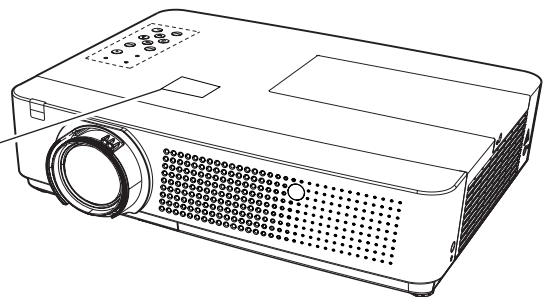

Turning Off the Projector

- 1) Press the <ON/STAND-BY> button on the control panel or the <STAND-BY> button on the remote control, and **Power off?** appears on the screen.
- 2) Press the <ON/STAND-BY> button on the control panel or the <STAND-BY> button on the remote control again to turn off the projector. The <POWER> indicator starts to blink red, and the cooling fans keep running. At this time, you can unplug the AC power cord even if the fans are still running.
- 3) When the projector has cooled down enough, the <POWER> indicator stops blinking and you can turn on the projector.

Power off ?

Power off? disappears after 4 seconds.

Note

- Do not put the projector in a case before the projector is cooled enough.
- While the <POWER> indicator is blinking, the lamp is being cooled down and the projector cannot be turned on. Wait until the <POWER> indicator stops blinking to turn on the projector again.
- The projector can be turned on after the <POWER> indicator turns red. The waiting time to restart will be shortened when the normal power-off processing for fan cooling is completed, compared with the time the AC power cord is immediately unplugged after the power-off.

Direct Power Off function

Even if you turn off the <ON/STAND-BY> button during projection or just after the lamp turns off, the cooling fan will continue to rotate using internally stored power. In cases where the <ON/STAND-BY> switch is not easily accessible, such as during ceiling mount, you can safely turn off the power by using the power breaker switch. This function also works if a power outage occurs or if the power cable is accidentally disconnected from the outlet right after turning the power off.

Note

- When using the Direct power Off function, you can not restart the projector immediately after the power is disconnected. The lamp remains high temperature and needs to be cooled, so it sometimes takes longer time than usual for the lamp to light up again.
- While the cooling fan is operating, do not place the projector inside a box or bag.

Projecting

Adjusting the image manually

Check the connections of the peripheral devices and connection of the power cord (➔page 27) and switch on the power (➔page 29) to start the projector.

Selecting the image

Select an input signal.

The image selected with the <COMPUTER 1>, <COMPUTER 2>, <HDMI>, <VIDEO>, <S-VIDEO>, or <NETWORK> button is projected (➔page 36).

Attention

- Images may not be projected properly depending on the connected device and DVD, video tape, etc. to be played. Select a system format that is suitable for the input signal in [Component] or [RGB] in the [Input] menu (➔page 41).
- Check the aspect ratio of the screen and the image and select the optimum aspect ratio under the [Screen] menu (➔page 50).

Adjusting the state of the image

1) Adjust the projection angle

- For details, see “Adjusting front adjustable feet” (➔page 25).

2) Adjust the zoom and the focus

Turn [Zoom lever] and [Focus ring] to adjust the image.

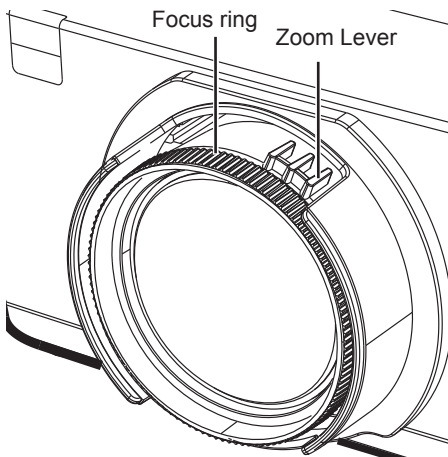

Note

- If you adjust the focus, you may need to adjust the size of the image by moving the zoom lever again.
- If keystone distortion occurs, see “KEYSTONE” (➔page 51).

Adjusting the image automatically

Easy setting function makes the semi-automatically adjustment possible, so that to get the optimal image.

Auto setup function including these following functions (➔page 54-55).

Input search	Switching the input signal automatically.
Auto PC adj.	The image projected from the computer automatically is optimal
Focus assist	The color of the bar assists the focus adjustment.
Screen fit	Detect and correct the image automatically to fit the frame. If you can not detect the frame of the screen, Keystone (standard) executes automatically.
Colorboard	The color values will change automatically to reach the optimal white balance according to the color of screen.

Auto setup

When all of the above mentioned functions are set to [On], the adjustment orders are as follows.

- 1) Project an image.
- 2) Adjust the zoom ring so that the image is larger than the screen frame.
- 3) Press the <AUTO SET> button on the remote control or the <AUTO SETUP> button on the control panel during projection. [Please wait ...] appears, Input search function starts to work and select an input signal. If the input signal is an computer (analog) signal, Auto PC adj. function starts to work and get an optimal image. Next, a test pattern for [Focus assist] appears on the screen and the focus assist bar appears in the center bottom of the screen.



- 4) Rotate the focus ring until the bar changes to blue and the image reaches to the maximum level.



The focus assist bar will display different colors according to the clarity of image.

Color	state
Red	The projected image is turning unclear.
Yellow	The projected image is turning clear.
Blue	The projected image is optimal.

Attention

- When the easy setting function is started, the focus assist bar does not display blue color, even if the focus adjustment is optimal. So readjust the focus with rotating the focus ring.

5) Then press the <SELECT> button on the remote control or on the control panel.

The adjustment image of [Screen fit] appears.

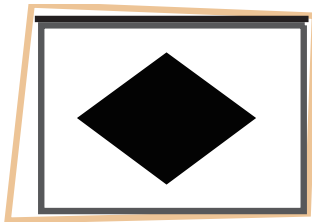

● Screen frame detected

If it detects a screen frame, the projected image is corrected to fit the screen frame automatically.

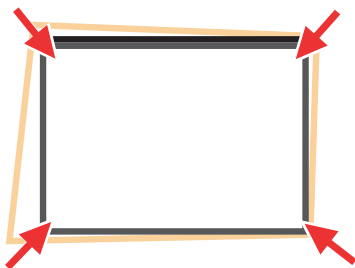

Adjust the image to fit the screen according to the [Screen fit] function's different states.

On 1	The aspect ratio of image will change to fit the screen.
On 2	The aspect ratio of image will not change, and no image area will appear in top/bottom sides or left/right sides.

Then the [Colorboard] function is activated to get an optimal image. [Corner correction] appears and it can be adjusted manually if it is necessary. (➔page 35)

It will exit without any operation.

● Screen frame undetected

If it does not detect a screen frame, the [Keystone (Standard)] function starts to work and the projected image can be adjust horizontally and vertically.

Then the [Colorboard] function is activated to get an optimal image. [Keystone (Standard)] appears and it can be adjusted manually if it is necessary. (➔page 35) It will exit without any operation.

The conditions of [Screen fit] function to adjust the projected image as follows.

items	conditions
Projected image size	30" - 100" (after correction)
Distance between projector and screen	approx. 0.7 to 3.5 m (when execute the keystone function, less than 2.5m)
Correction angle	approx. 20° right and left /approx. 30° up and down

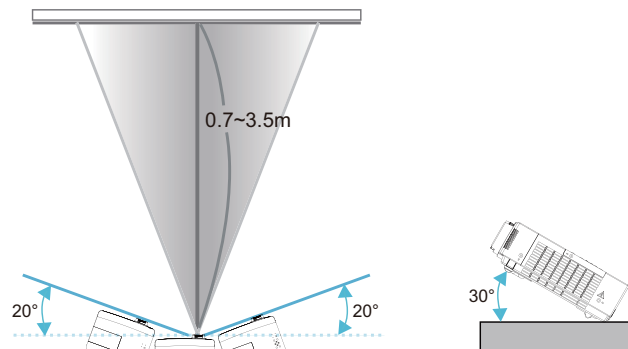

Attention

- If the [Focus assist], [Screen fit] and [Colorboard] functions are working, do not move the projector or block the image. The projected image will not be corrected properly.
- Please adjust the [Corner correction] or [Keystone (Standard)] manually, if you want to correct the projected image after the adjustment of [Screen fit]. (➔page 35)

Note

- [Screen fit] corrects the projected image when it detects two or more sides inside the projected area, and fits the detected frame.
- [Screen fit] may not work well in bright environments and the projected image is in low contrast. In this case, make the room darker, and then try executing [Screen fit] again.
- Because [Screen fit] uses a sensor, it may not work properly depending on the condition of the projection surface (deflections, patterns, and so on), the distance between projector and screen, or the effects of outside light such as fluorescent. In this case, make the adjustments manually.
- It is recommended to use a black frame screen when using [Screen fit] function.
- When the easy setting function does not complete,  mark will be displayed.

Basic operations by using the remote control



Using the AUTO SET function

This function allows you to automatically adjust [Input search], [Auto PC adjustment], [Focus assist], [Screen fit] and [Colorboard] during signal input from a computer.



Button

Press the <AUTO SET> button on the remote control.

Note

- For details, see “Setting” of Main menu. (➔page 54)

Using the IMAGE button

This function allows you to select a desired image mode of the screen.



Button

Press <IMAGE> button on the remote control to select the desired image mode among [Dynamic], [Standard], [Real], [Cinema], [Blackboard (Green)], [Colorboard], [Image 1], [Image 2], [Image 3] and [Image 4].

Note

- For details, see “Image select” of Main menu. (➔page 46)

Using the MENU button

This function allows you to open or close the On-Screen Menu.



Button

Press the <MENU> button on the remote control.

Note

- For details, see “Menu Navigation”. (➔page 38)

Using the INFO. button

This function allows you to display the information menu.



Button

Press <INFO.> button on the remote control.

Note

- For details, see “Input Source Information Display” in “Information” under Main menu. (➔page 62)

Controlling the volume of the speaker

You can control the volume of the projector’s speaker or audio output.



Buttons

Press the <VOLUME+/-> buttons on the control panel or on the remote control to adjust the volume. The volume dialog box appears on the screen for a few seconds.

Note

- For details, see “Volume” of “Sound” under Main menu. (➔page 53)

Basic operations by using the remote control

Using the wireless mouse function

<L-CLICK/R-CLICK> buttons act as left/right mouse button while the projector and a computer are connected with a USB cable, and move the pointer on the screen with <MOUSE POINTER> button.



Buttons

Press <MOUSE POINTER>, <L-CLICK/R-CLICK> buttons on the remote control.

Note

- When a USB cable is connected to the computer and the projector, turn on the projector first, then the computer. If you turn on the computer first, the wireless mouse function may not operate properly.

Using the PAGE button

Scroll back and forth the pages on the screen when giving a presentation.

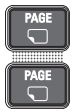

Buttons

Press the <PAGE> buttons on the remote control.

Note

- To use these buttons, connect the projector and your computer with a USB cable.

Using the POINTER button

Act as the On-Off switch for the Pointer.



Button

Press the <POINTER> button on the remote control.

Note

- For details, see "Setting" of Main menu. (➔page 57)

Using the KEYSTONE button

This function allows you to correct keystone distortion.



Button

If a projected picture still has keystone distortion after pressing the <AUTO SET> button, correct the image manually as follows:

Press the <KEYSTONE> button on the remote control to switch the [Standard] (for Vertical/Horizontal) / [Corner correction] adjustment. The [Standard] or [Corner correction] adjustment dialog box appears. Press ▲▼◀▶ to correct the Standard or Corner distortion. The [Standard] or [Corner correction] adjustment can be stored. (➔page 51)

Standard



Reduce the lower width with press ▼.

Reduce the upper width with press ▲.

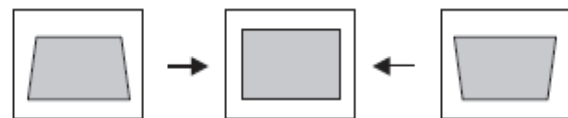

Reduce the right part with press ▶.

Reduce the left part with press ◀.

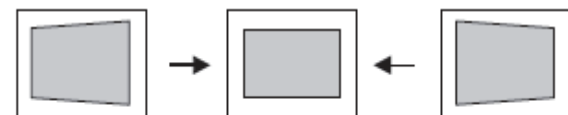

Corner correction



Press the <KEYSTONE> button on the remote control to switch [Corner correction] adjustment, press the <SELECT> button on the remote control to select the corner you want to adjust.

The top left corner adjustment as an example:

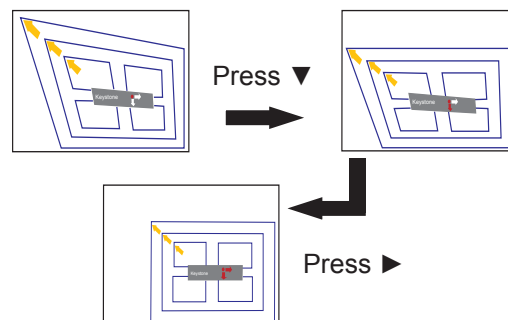

Basic operations by using the remote control

Reduce the top left corner part with press ▶▼.

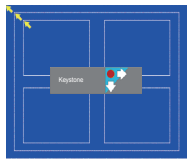

Press the <SELECT> button

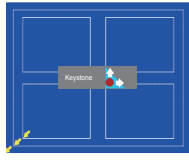

Reduce the bottom left corner part with press ▶▲.

Reduce the top right corner part with press ◀▼.

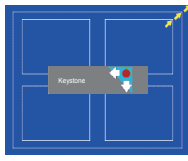

Press the <SELECT> button

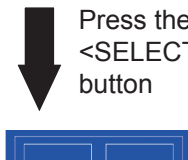

Press the <SELECT> button

Press the <SELECT> button

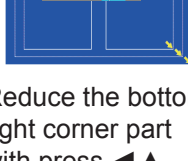

Reduce the bottom right corner part with press ◀▲.

Note

- The white arrows indicate that there is no correction.
- A red arrow indicates the direction of correction.
- An arrow disappears at the maximum correction.
- If you press the <KEYSTONE> button on the remote control once more while the keystone dialog box is being displayed, the keystone adjustment will be canceled. (▶page 51)
- The adjustable range is limited depending on the input signal.
- [Standard] and [Corner correction] functions cannot be adjusted at the same time. If one of the functions is adjusted, and then the other one will be reset automatically.

Switching the input signal

You can switch the input signals to project.

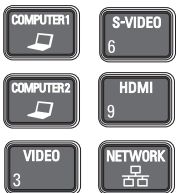

Buttons

Press (<COMPUTER 1>, <COMPUTER 2>, <HDMI>, <VIDEO>, <S-VIDEO>, or <NETWORK>) button on the remote control.

COMPUTER 1	Switches to Computer 1(RGB)/ Computer 1(Component)/ Computer 1(Scart) input.
COMPUTER 2	Switches to Computer 2(RGB) input.

HDMI	Switches to HDMI input.
VIDEO	Switches to Video input.
S-VIDEO	Switches to S-video input.
NETWORK	Switches to Network input.

Note

- Each press of the <INPUT> button on the Control Panel of the main unit switches the settings as shown below. (▶page 20)

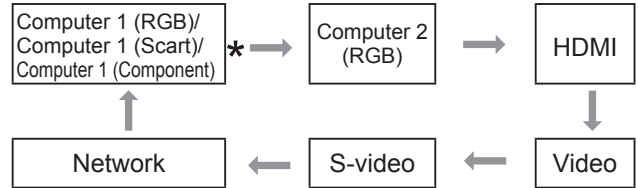

- * It depends on the item you selected in the [Computer 1] submenu of the [Input] menu.

Using the MUTE button

Press this button on the remote control to select [On] to temporarily turn off the sound.



Button

Press <MUTE> button on the remote control.

Note

- To turn the sound back on, press this button again or press the <VOLUME +/-> buttons. (▶page 53)

Using the D.ZOOM buttons

This function allows you to enter to the Digital zoom +/- mode.

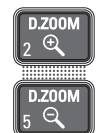

Buttons

Press <D.ZOOM +/-> buttons on the remote control.

Note

- For details, see "Screen" of Main menu. (▶page 51)

Basic operations by using the remote control

Using the FREEZE function

You can freeze the projected image and stop the sound temporarily, regardless of the playing condition of the connected device.



Button

Press the <FREEZE> button on the remote control to freeze the picture on the screen, meanwhile, volume is muted. To cancel the Freeze function, press the <FREEZE> button again or press any other button.

Fig.1 will appear on the screen while the Freeze function is working.

Fig.1



Note

- When no signal inputs,  mark will appear.

Using the AV MUTE function



Button

Press the < AV MUTE> button on the remote control to black out the image. To restore to normal, press the < AV MUTE> button again or press any button.

- When the Logo is not set, the screen changes each time you press the < AV MUTE> button as follows.



- The projected Logo (the logo can be set according to users' favorite) is transferred from computer to the projector by "Logo Transfer Software" on the supplied CD-ROM and is set as [User] in the Logo selection (➔page 56), the screen changes each time you press the < AV MUTE> button as follows.



Note

- When use the <MUTE> button to release the [AV mute] function, the mute function can not be operated at the same time.

Using the SCREEN button

This function allows you to select screen mode or change the screen size.



Button

Press the <SCREEN> button on the remote control.

Note

- For details, see "Screen" of Main menu. (➔page 50)

Using the P-TIMER button

Press the <P-TIMER> button on the remote control to operate the [Count up]/[Count down] function.



Button

Press <P-TIMER> button on the remote control.

Note

- To stop the count time, press the <P-TIMER> button. To cancel the [P-timer] function, press and hold the <P-TIMER> button. (➔page 58)

Using the LAMP button

This function allows you to select the lamp mode for changing the brightness on the screen.



Button

Press <LAMP> button on the remote control.

Note

- For details, see "Lamp Power" of "Setting" under Main menu. (➔page 59)

Menu Navigation

Navigating through the menu

Operating procedure

1) Press the <MENU> button.

The Main Menu screen appears.

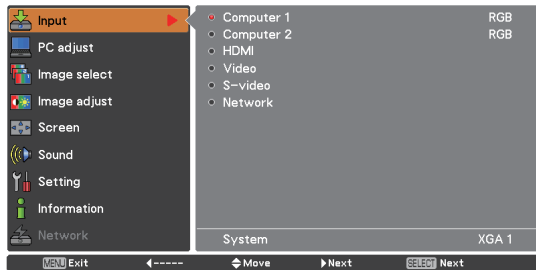

2) Press ▲ ▼ to select the Main Menu item.

Select the desired item from the 9 items: [Input], [PC adjust], [Image select], [Image adjust], [Screen], [Sound], [Setting], [Information] and [Network]. The selected item is highlighted with an orange cursor and the submenu of the selected item appears on the right.

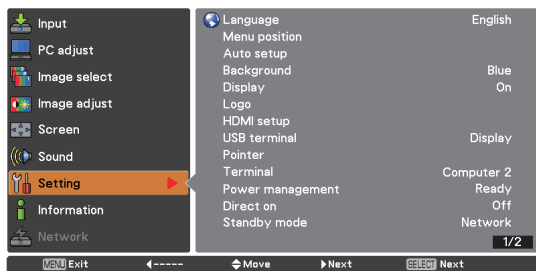

3) Press ► or the <SELECT> button.

The submenu appears so that you can select the sub-menu item.

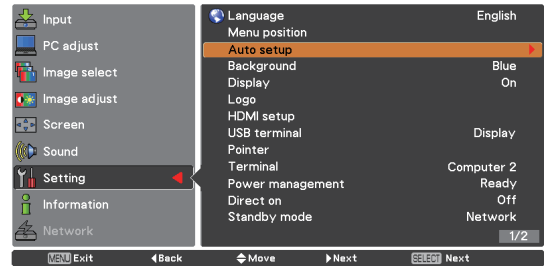

4) Press ▲ ▼ to select the desired sub-menu item.

5) Press the <SELECT> button or press ► to enter the desired item.

6) Press ▲ ▼ ◀ ▶ to set or adjust the parameter values.

7) Press ◀ to return the previous menu. Press the <MENU> button to exit the menu display.









Note

- Some items may not be adjusted or used for certain signal formats input to the projector. The menu items that cannot be adjusted or used are shown in gray characters, and they cannot be selected.
- Some items can be adjusted even if signals are not input.
- See page 39 and 40 for details on the items of sub-menu.

Main menu

The main menu consists of the following 9 menu items.

When a main menu item is selected, the screen changes to a submenu selection screen.

	Input
	PC adjust
	Image select
	Image adjust
	Screen
	Sound
	Setting
	Information
	Network

Sub menu

The sub-menu screen of the selected main menu appears, and you can set and adjust the various items in the submenu.

Input []

Sub-menu item	Factory default	Page
Computer 1	RGB	41
Computer 2	RGB	41
HDMI	-	41
Video	-	41
S-video	-	41
Network	-	42

PC adjust []

Sub-menu item	Factory default	Page
AUTO PC adj.	-	43
Fine sync.	-	44
Total dots	-	44
Horizontal	-	44
Vertical	-	44
Current mode	-	45
Clamp	-	45
Display area H	-	45
Display area V	-	45
Reset	-	45
Mode free	-	45
Store	-	45

Note

- These functions will be available when the input source come from computer.

Image select []

Sub-menu item	Factory default	Page
Dynamic	-	46
Standard	-	46
Real	-	46
Cinema*1	-	46
Blackboard(Green)	-	46
Colorboard	Red	46
Image 1-4	-	46

- *1 : When input video signal to the projector, this function will be available.

Menu Navigation

Image adjust []

Sub-menu item	Factory default	Page
Contrast	32	47
Brightness	32	47
Color* ¹	32	47
Tint* ¹	32	47
Color temp.	Mid	47
Red	32	48
Green	32	48
Blue	32	48
Sharpness	8	48
Gamma	8	48
Noise reduction* ¹	L1	48
Progressive* ¹	L1	49
Reset	-	49
Store	-	49

*1 : When input video signal to the projector, these functions will be available.

Screen []

Sub-menu item	Factory default	Page
Normal	-	50
Full	-	50
Wide (16:9)	-	50
Zoom	-	50
True* ¹	-	50
Custom	-	50
Custom adj.	-	50
Digital zoom + * ¹	-	51
Digital zoom - * ¹	-	51
Keystone	Store	51
Ceiling	Off	51
Rear	Off	52
Reset	-	52

*1 : When input computer signal to the projector, these functions will be available.

Sound []

Sub-menu item	Factory Default	Page
Volume	32	53
Mute	Off	53
MIC	Off	53
MIC gain	32	53
Standby MIC out	Off	53

Setting []

Sub-menu item	Factory Default	Page
Language	English	54
Menu position	Center	54
Auto setup	-	54
Background	Blue	55
Display	On	55
Logo	-	56
HDMI setup	-	56
USB Terminal	Display	56
Pointer	Spotlight L	57
Terminal	Computer 2	57
Power management	Shut down	57
Direct on	Off	57
Standby mode	Eco	57
P-timer	Count up	58
Closed caption	Off	58
Lamp power	Auto	59
Remote control	ALL	59
Security	-	59
Fan	L2	60
Fan control	Off	60
Video delay control	Off	60
Filter counter	-	60
Total power savings	-	61
Warning log	-	61
Factory default	-	61

Information []

Sub-menu item	Factory default	Page
Input	-	62
System	-	62
H-sync freq.	-	62
V-sync freq.	-	62
Screen	-	62
Language	-	62
Lamp power	-	62
Lamp runtime	-	62
Power management	-	62
Key lock	-	62
PIN code lock	-	62
Remote control	-	62
Serial number	-	62
Total power savings	-	62

Network []

Refer to "Operating Instructions, Network operations".

Input menu

Select [Input] from the Main Menu (see “Navigating through the menu” on page 38), then select the item from the sub-menu.

Remote Control

Control Panel

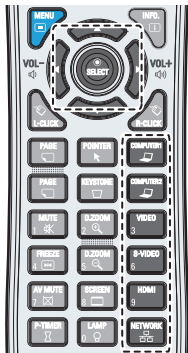

Computer 1: RGB/Component /RGB (Scart)

- 1) Press ▲ ▼ to select [Computer 1].
- 2) Press ► to access the submenu.
- 3) Press ▲ ▼ to select RGB, Component or RGB(Scart).
- 4) Press the <SELECT> button.

Computer 2: RGB

Press ▲ ▼ to select [Computer 2 (RGB)] and then press the <SELECT> button.

Computer System Selection

This projector automatically tunes to various types of computers with its Multi-scan system and Auto PC Adjustment. If a computer is selected as a signal source, this projector automatically detects the signal format and tunes to project a proper image without any additional settings. (Signal formats provided in this projector are shown on pages 76-79.)

AUTO When the projector can not recognize the connected signal conforming to the provided PC Systems, **Auto** is displayed on the System Menu box and the Auto PC adjustment function works to display proper images. If the image is not projected properly, a manual adjustment is required.

---- There is no signal input from the computer. Check the connection between your computer and the projector.

Mode 1 The preset system is manually adjusted in the PC adjust Menu. The adjusted data can be stored in Mode 1-10.

SVGA 1 PC Systems provided in this projector is chosen. The projector chooses a proper system provided in the projector and displays it.

* Mode 1 and SVGA 1 are examples.

- 1) Press ▲ ▼ to select [System].
- 2) Press ► or the <SELECT> button to access the submenu.
- 3) Press ▲ ▼ to select the desired system.

HDMI

Press ▲ ▼ to select [HDMI] and then press the <SELECT> button.

Video

Press ▲ ▼ to select [Video] and then press the <SELECT> button.

S-video

Press ▲ ▼ to select [S-video] and then press the <SELECT> button.

Video System Selection

Video or S-video

Auto

The projector automatically detects an incoming video system, and adjusts itself to optimize its performance. When Video System is [PAL-M] or [PAL-N], select the system manually.

Input menu

PAL/SECAM/NTSC/NTSC4.43/PAL-M/PAL-N

If the projector cannot reproduce proper video image, select a specific broadcast signal format from among [PAL], [SECAM], [NTSC], [NTSC 4.43], [PAL-M] and [PAL-N].

Component

Auto

The projector automatically detects an incoming video signal, and adjusts itself to optimize its performance.

COMPONENT VIDEO SIGNAL FORMAT

If the projector cannot reproduce proper video image, select a specific component video signal format among [480i], [576i], [480p], [576p], [720p], [1035i] and [1080i].

- 1) Press ▲ ▼ to select [System].
- 2) Press ► or the <SELECT> button to access the submenu.
- 3) Press ▲ ▼ to select the desired system.

Note

- When the [Input Search] function is set to [On1] or [On2] in the [Auto setup] function, the input signal will be searched automatically.
- The AV System Menu cannot be selected when selecting [RGB (Scart)].

Network

Press ▲ ▼ to select [Network] and then press the <SELECT> button.

Note

- [Network] will be available in the [Input] menu when the input source [Network] is selected.
- For details please refer to "Operating Instructions-Network operations".

AUTO PC adjust

Select [PC adjust] from the Main Menu (see “Navigating through the menu” on page 38), then select the item from the sub-menu.

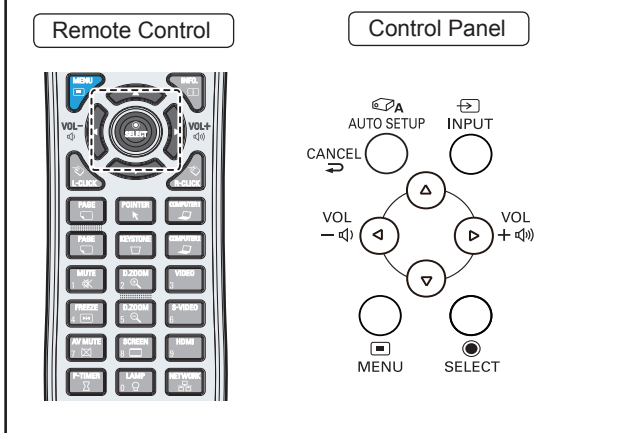

AUTO PC adj.

Auto PC adjustment function is provided to automatically adjust [Fine sync], [Total dots], [Horizontal] and [Vertical] positions to conform to your computer.

Press ▲ ▼ to select [AUTO PC adj.] and then press the <SELECT> button.

- [Please wait...] appears while the Auto PC adjustment is in process.

To store adjustment parameters

The adjusted parameters from the Auto PC adjustment can be stored in the projector. Once the parameters are stored, the setting can be done just by selecting a Mode (1–10) in the PC System Menu (see page 41). See also [Store] on page 45.

Attention

- [Fine sync], [Total dots], [Horizontal] and [Vertical] position of some computers cannot be fully adjusted with the Auto PC adjustment function. When the image is not provided properly with this operation, manual adjustments are required (► pages 44-45).
- The Auto PC adjustment cannot be operated when [480i], [576i], [480p], [576p], [720p], [1035i] or [1080i] is selected in the PC System Menu (► page 42), or when the signal is coming from the HDMI terminal.

Manual PC adjust

Select [PC adjust] from the Main Menu (see “Navigating through the menu” on page 38), then select the item from the sub-menu.

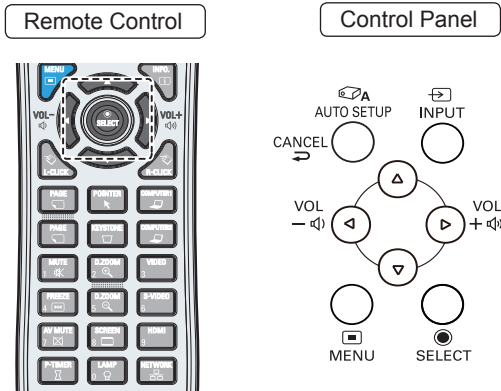

Some computers employ special signal formats which may not be tuned by Multi-scan system of this projector. Manual PC adjustment enables you to precisely adjust several parameters to match those signal formats. The projector has 10 independent memory areas to store those parameters manually adjusted. It allows you to recall the setting for a specific computer.

Fine sync

- 1) Press ▲ ▼ to select [Fine sync].
- 2) Press the <SELECT> button to display the adjustment dialog box.
- 3) Press ◀ ▶ to adjust the value.
 - The value can be adjusted from 0 to 31.

Total dots

- 1) Press ▲ ▼ to select [Total dots].
- 2) Press the <SELECT> button to display the adjustment dialog box.
- 3) Press ◀ ▶ to adjust the value.

Horizontal

- 1) Press ▲ ▼ to select [Horizontal].
- 2) Press the <SELECT> button to display the adjustment dialog box.
- 3) Press ◀ ▶ to adjust the horizontal picture position.

■ For horizontal (right and left) adjustment

Operation	Adjustment	
Press ◀.	The picture position moves to the right.	
Press ▶.	The picture position moves to the left.	

Vertical

- 1) Press ▲ ▼ to select [Vertical].
- 2) Press the <SELECT> button to display the adjustment dialog box.
- 3) Press ◀ ▶ to adjust the vertical picture position.

■ For vertical (up and down) adjustment

Operation	Adjustment	
Press ▶.	The picture position moves up.	
Press ◀.	The picture position moves down.	

Current mode

- 1) Press ▲▼ to select [Current mode].
- 2) Press ► or the <SELECT> button to enter the next submenu to show [H-sync freq.] and [V-sync freq.] of the connected computer.

Clamp

- 1) Press ▲▼ to select [Clamp].
- 2) Press the <SELECT> button to display the adjustment dialog box.
- 3) Press ◀▶ to adjust the clamp level.
 - When the image has dark bars, try this adjustment.

Display area H

- 1) Press ▲▼ to select [Display area H].
- 2) Press the <SELECT> button to display the adjustment dialog box.
- 3) Press ◀▶ to adjust the horizontal area displayed by this projector.

Display area V

- 1) Press ▲▼ to select [Display area V].
- 2) Press the <SELECT> button to display the dialog box.
- 3) Press ◀▶ to adjust the vertical area displayed by this projector.

Reset

To reset the adjusted data, all adjustments will return to their previous figures.

- 1) Press ▲▼ to select [Reset].
- 2) Press the <SELECT> button.
 - A confirmation box appears and then select [Yes].

Mode free

- 1) Press ▲▼ to select [Mode free].
- 2) Press ► or the <SELECT> button to enter the next submenu.
 - Move the highlight to the mode that you want to clear and then press the <SELECT> button.

Store

- 1) Press ▲▼ to select [Store].
- 2) Press ► or the <SELECT> button to enter the next submenu.
 - Move the highlight to one of the Modes 1 to 10 in which you want to store, and then press the <SELECT> button.

Image select

Select [Image select] from the Main Menu (see “Navigating through the menu” on page 38), then select the item from the sub-menu.

Remote Control



Control Panel

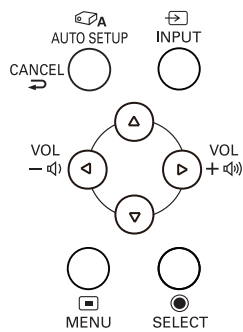

Blackboard(Green)

For the image projected on a blackboard.

Press ▲ ▼ to select [Blackboard(Green)] and then press the <SELECT> button.

- This mode helps enhance the image projected on a blackboard. This is mainly effective on a green colored board, not truly effective on a black colored board.

Colorboard

For the image projected on a colorboard.

1) Press ▲ ▼ to select [Colorboard].

2) Press ► or the <SELECT> button to display the submenu.

- At the time of simple projection on the colored wall, you can get the close color image to the color image projected on a white screen by selecting the similar color to the wall color from the preset four colors (Red, Blue, Yellow and Green).
- When [Colorboard] is set to [Auto], the [Colorboard] function of [Auto setup] will execute and correct color automatically.

Note

- When [Colorboard] function of [Auto setup] is operating the [Colorboard] of [Image select] will switch to [Auto] automatically.

Dynamic

For viewing pictures in a bright room.

Press ▲ ▼ to select [Dynamic] and then press the <SELECT> button.

Standard

Normal picture mode preset on the projector.

Press ▲ ▼ to select [Standard] and then press the <SELECT> button.

Real

Picture mode with improved halftone for graphics.

Press ▲ ▼ to select [Real] and then press the <SELECT> button.

Cinema

Picture mode adjusted with fine tone.

Press ▲ ▼ to select [Cinema] and then press the <SELECT> button.

Image 1-4

For viewing with the user preset image mode in the Image adjust Menu. This Image memory is provided in each computer, component and video input source.

Press ▲ ▼ to select [Image 1-4] and then press the <SELECT> button.

Image adjust

Select [Image adjust] from the Main Menu (see “Navigating through the menu” on page 38), then select the item from the sub-menu.

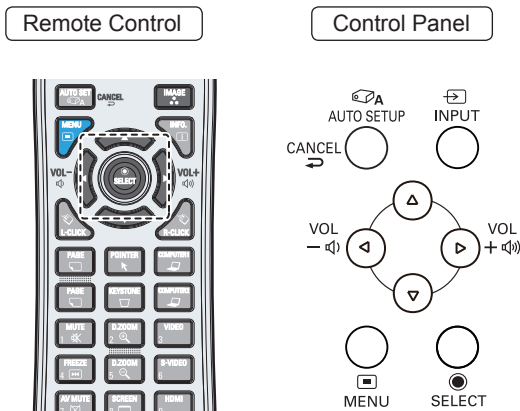

Contrast

- 1) Press ▲▼ to select [Contrast].
- 2) Press the <SELECT> button to display the adjustment dialog box.
- 3) Press ◀▶ to adjust the setting value.

Operation	Adjustment	Adjustment range
Press ▶.	increase the contrast	Maximum value 63
Press ◀.	decrease the contrast	Minimum value 0

Brightness

- 1) Press ▲▼ to select [Brightness].
- 2) Press the <SELECT> button to display the adjustment dialog box.
- 3) Press ◀▶ to adjust the setting value.

Operation	Adjustment	Adjustment range
Press ▶.	increase the brightness	Maximum value 63
Press ◀.	decrease the brightness	Minimum value 0

Color

- 1) Press ▲▼ to select [Color].
- 2) Press the <SELECT> button to display the adjustment dialog box.
- 3) Press ◀▶ to adjust the setting value.

Operation	Adjustment	Adjustment range
Press ▶.	increase the intensity of the color	Maximum value 63
Press ◀.	decrease the intensity of the color	Minimum value 0

Note

- When input video signal to the projector, [Color] will be available.

Tint

- 1) Press ▲▼ to select [Tint].
- 2) Press the <SELECT> button to display the adjustment dialog box.
- 3) Press ◀▶ to adjust the tint value to get a proper color balance.
 - Adjustments can be made between 0 and 63.

Note

- When you select [NTSC] or [NTSC4.43] in System menu under Video input signal, [Tint] will be available.

Color temp.

- 1) Press ▲▼ to select [Color temp.].
- 2) Press the <SELECT> button to display the adjustment dialog box.
- 3) Press ◀▶ to select the desired Color temp. level.
 - You can select the desired Color temp. level from [XLow], [Low], [Mid] or [High].

Note

- [Color temp.] level displays [Blackboard] or [Colorboard] when the [Blackboard(Green)] or [Colorboard] is selected in the [Image select] menu.

Image adjust

Red

- 1) Press ▲ ▼ to select [Red].
- 2) Press the <SELECT> button to display the adjustment dialog box.
- 3) Press ◀ ▶ to adjust the setting value.

Operation	Adjustment	Adjustment range
Press ▶.	deepen red tone	Maximum value 63
Press ◀.	lighten red tone	Minimum value 0

Green

- 1) Press ▲ ▼ to select [Green].
- 2) Press the <SELECT> button to display the adjustment dialog box.
- 3) Press ◀ ▶ to adjust the setting value.

Operation	Adjustment	Adjustment range
Press ▶.	deepen green tone	Maximum value 63
Press ◀.	lighten green tone	Minimum value 0

Blue

- 1) Press ▲ ▼ to select [Blue].
- 2) Press the <SELECT> button to display the adjustment dialog box.
- 3) Press ◀ ▶ to adjust the setting value.

Operation	Adjustment	Adjustment range
Press ▶.	deepen blue tone	Maximum value 63
Press ◀.	lighten blue tone	Minimum value 0

Sharpness

- 1) Press ▲ ▼ to select [Sharpness].
- 2) Press the <SELECT> button to display the adjustment dialog box.
- 3) Press ◀ ▶ to adjust the setting value.

Operation	Adjustment	Adjustment range
Press ▶.	increase the sharpness of the image	Maximum value 15
Press ◀.	decrease the sharpness of the image	Minimum value 0

Gamma

- 1) Press ▲ ▼ to select [Gamma].
- 2) Press the <SELECT> button to display the adjustment dialog box.
- 3) Press ◀ ▶ to adjust the gamma value to obtain a better balance of contrast.
 - Adjustments can be made between 0 and 15.

Noise reduction

- 1) Press ▲ ▼ to select [Noise reduction].
- 2) Press the <SELECT> button to display the adjustment dialog box.
- 3) Press ◀ ▶ to select the desired item.

Off	Disabled
L1	Lower reduction
L2	Higher reduction

- Noise interference on the screen can be reduced. Select one of the above options to get smoother images.
- [Noise reduction] cannot be selected when [480p], [576p], [720p], [1035i] or [1080i] is selected.

Note

- When input video signal to the projector, [Noise reduction] will become available.

Progressive

- 1) Press ▲▼ to select [Progressive].
- 2) Press the <SELECT> button to display the dialog box.
- 3) Press ◀▶ to select the desired item.
 - An interlaced video signal can be displayed in progressive mode. Select one of the following options.
 - [Progressive] cannot be selected when [480p], [576p], [720p], [1035i] or [1080i] is selected.

Off	Disabled
L1	For an active picture
L2	For a still picture
Film	For watching a film

Note

- When input video signal to the projector, [Progressive] will become available.

Reset

To reset the adjusted data, all adjustments will return to their previous figures.

- 1) Press ▲▼ to select [Reset].
- 2) Press the <SELECT> button.
 - A confirmation box appears and then select [Yes].

Store

- 1) Press ▲▼ to select [Store].
- 2) Press ▶ or the <SELECT> button.
- 3) Press ▲▼ to select one from Image 1 to 4 and press the SELECT button.
 - A confirmation box appears and then select [Yes].

Screen

Select [Screen] from the Main Menu (see “Navigating through the menu” on page 38), then select the item from the sub-menu.

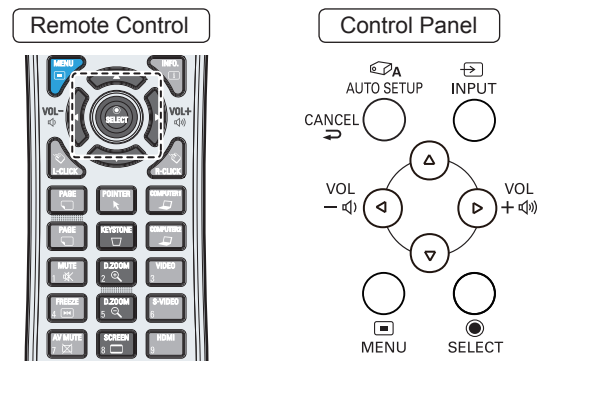

Normal

Provide the image to fit the screen size while maintaining the aspect ratio of the input signal.

Press **▲ ▼** to select [Normal] and then press the **<SELECT>** button.

Full

Provide the full screen image.

Press **▲ ▼** to select [Full] and then press the **<SELECT>** button.

Wide(16:9)

Provide the image at the 16:9 wide screen ratio.

Press **▲ ▼** to select [Wide(16:9)] and then press the **<SELECT>** button.

Zoom

Scale the image proportionally to fit the entire screen. Either side of image may go over the screen.

Press **▲ ▼** to select [Zoom] and then press the **<SELECT>** button.

True

Provide the image in its original size. When the original image size is larger or smaller than the panel size (1024 x 768), the projector enters to the panning mode automatically.

1) Press **▲ ▼** to select [True] and then press the **<SELECT>** button.

2) Press **▲ ▼ ◀ ▶** to pan the image.

- When adjusted, the arrows will turn red. When reached to the correction limits, the arrows will disappear.

Note

- When input computer signal to the projector, [True] will be available.
- [True] is disabled and cannot be displayed when [480i], [576i], [480p], [576p], [720p], [1035i] or [1080i] is selected in the PC System Menu.
- When [True] is selected in the Screen menu, [Digital zoom +/-] can not be selected.

Custom

Provide the last stored aspect screen image.

Press **▲ ▼** to select [Custom] and press the **<SELECT>** button.

Custom adj.

Adjust the screen scale and position manually with this function.

1) Press **▲ ▼** to select [Custom adj.].

2) Press **▶** or the **<SELECT>** button to enter the next submenu.

3) Press **▲ ▼** to choose the item you want to adjust.

- You can choose one from the items as below:

Scale H/V	Adjust the Horizontal/Vertical screen scale.
H&V	When set to [On], the aspect ratio is fixed.
Position H/V	Adjust the Horizontal/Vertical screen position.
Common	Save the adjusted scale or position to all the inputs.
Reset	Reset the all adjusted values.

Digital zoom +

Zoom in the images.

- 1) Press ▲▼ to select [Digital zoom +] and then press the <SELECT> button.
 - The On-Screen Menu disappears and [D. zoom +] appears.
- 2) Press the <SELECT> button to zoom in the image size and press ▲▼ ◀▶ to move the image to the top/bottom/left/right of the screen.
 - The Panning function can work only when the image is larger than the screen size. A projected image can be also expanded by pressing the <D. ZOOM + > or the <SELECT> button.

Digital zoom -

Zoom out the images.

- 1) Press ▲▼ to select [Digital zoom -] and then press the <SELECT> button.
 - The On-Screen Menu disappears and [D. zoom -] appears.
- 2) Press the <SELECT> button to zoom out image size.
 - The projected image can be also compressed by pressing the <D. ZOOM - > or the <SELECT> button.

To exit the Digital zoom +/- mode, press any button except the <D. ZOOM +/->, <SELECT> and ▲▼◀▶ buttons.

To return to the previous screen size, select a screen size from the Screen Size Adjustment Menu or select an input source from the "Input Source Selection Menu" (▶page 41) again, or adjust the screen size with the <D. ZOOM +/-> buttons.

Note

- When input computer signal to the projector, this function will be available.
- [Digital zoom +/-] cannot be selected when [True] is selected in the Screen menu.
- [Digital zoom -] cannot be selected when [Custom] is selected in the Screen menu.
- [Digital zoom +/-] are disabled and cannot be displayed when [480i], [576i], [480p], [576p], [720p], [1035i] or [1080i] is selected in the PC System Menu (▶page 42).
- When [Digital zoom +/-] functions are disabled,  mark will appear.

Keystone

This function is used to adjust keystone distortion of the projected image.

- 1) Press ▲▼ to select [Keystone].
- 2) Press ▶ or the <SELECT> button.
- 3) Press ▲▼ to choose the item you want to adjust.

Standard	Adjust the Horizontal/Vertical keystone distortion of the projected image.
Corner correction	Adjust the corner distortion of the projected image.
Corner pattern	Choose a Corner pattern mode among Red, White, Blue, and Off.
Store	To store or reset the keystone correction.



The following items is the submenu of [Store].

Store	Keep the keystone correction even when the AC power cord is unplugged.
Reset	Release the keystone correction when turn off the projector.

Note

- For details, see "Using the KEYSTONE button" of "Basic operation by using the remote control" (▶page 35).

Ceiling

This function is used to project the image from a ceiling-mounted projector.

- 1) Press ▲▼ to select [Ceiling] and then press the <SELECT> button.
- 2) Press ▲▼ to change the image.
 - When this function is set to [On], the picture will be top/bottom and left/right reversed.

Screen

Rear

This function is used to project the image from rear of the screen.

- 1) Press ▲ ▼ to select [Rear] and then press the <SELECT> button.
- 2) Press ▲ ▼ to change the image.
 - When this function is set to [On], the picture will be left/right reversed.

Reset

To reset the adjusted data, all adjustments will return to their previous figures.

- Press ▲ ▼ to select [Reset] and then press the <SELECT> button**
- A confirmation box appears and then select [Yes].

Sound

Select [Sound] from the Main Menu (see “Navigating through the menu” on page 38), then select the item from the sub-menu.

Remote Control



Control Panel

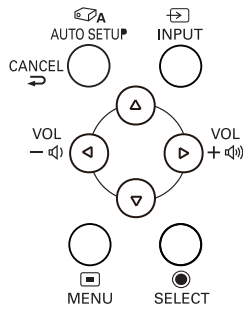

Volume

- 1) Press ▲▼ to select [Volume] and then Press the <SELECT> button.
- 2) Press ◀▶ to adjust the volume.

Operation	Adjustment	Adjustment range
Press ▶.	turn up the volume	Maximum value 63
Press ◀.	turn down the volume	Minimum value 0

- You can also press <VOLUME +/-> buttons on the remote control or control panel to adjust the volume.

Mute

- 1) Press ▲▼ to select [Mute].
- 2) Press the <SELECT> button to switch the mute function On/Off.
 - Press the <MUTE> button on the remote control to temporarily turn off the sound. To turn the sound back on, press the <MUTE> button again or press the <VOLUME +/-> buttons.

MIC

- 1) Press ▲▼ to select [MIC] and then Press the <SELECT> button.
- 2) Press ▲▼ to switch the MIC function On/Off.
 - When [Off] is selected in [MIC] function, the [MIC gain] and [Standby MIC out] functions are not available.
 - If the [MIC] function is turned on when connecting PC audio to the AUDIO IN (a mini jack), loud sound may be output suddenly depending on the setting value of [MIC gain].

MIC gain

- 1) Press ▲▼ to select [MIC gain] and then Press the <SELECT> button.
- 2) Press ◀▶ to adjust the MIC mixing gain.

Operation	Adjustment	Adjustment range
Press ▶.	turn up the MIC mixing gain	Maximum value 63
Press ◀.	turn down the MIC mixing gain	Minimum value 0

Standby MIC out

- 1) Press ▲▼ to select [Standby MIC out] and then Press the <SELECT> button.
- 2) Press ▲▼ to switch the Standby MIC out function On/Off.
 - When setting the [Standby MIC out] function to [On] and in Standby mode status, only MIC input volume can be output.
 - Only the Standby mode is set to [Network], [Standby MIC out] can be selected.

Setting

Select [Setting] from the Main Menu (see "Navigating through the menu" on page 38), then select the item from the sub-menu.

Remote Control



Control Panel

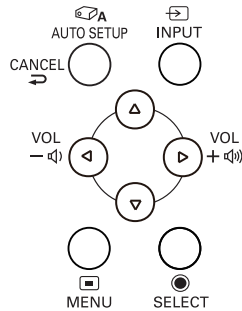

Language

- 1) Press ▲ ▼ to select [Language].
- 2) Press ► or the <SELECT> button.
- 3) Press ▲ ▼ to select the desired language.

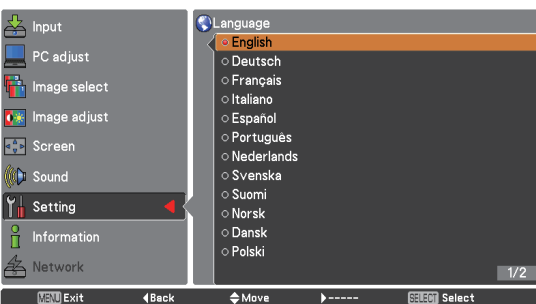
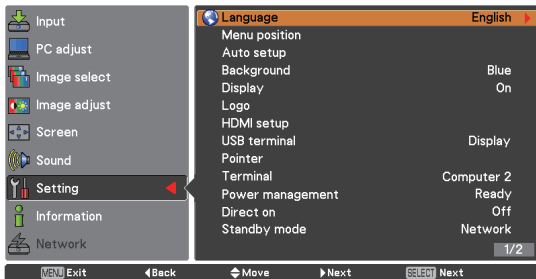

- The language used in the On-Screen Menu is available in English, German, French, Italian, Spanish, Portuguese, Dutch, Swedish, Finnish, Norwegian, Danish, Polish, Hungarian, Romanian, Czech, Russian, Turkish, Arabic, Kazak, Vietnamese, Chinese, Korean, Japanese and Thai.

Menu position

This function is used to change the position of the On-Screen Menu.

- 1) Press ▲ ▼ to select [Menu position].
- 2) Press the <SELECT> button to change the position.
 - The Menu position changes each time you press <SELECT> button as follows:

the center → the bottom left → the bottom right → the top left → the top right → the center.....

Auto setup

- 1) Press ▲ ▼ to select [Auto setup].
- 2) Press ► or the <SELECT> button.
- 3) Press ▲ ▼ to select these functions as follows:

Input search

This function detects the input signal automatically. When a signal is found, the search will stop.

Off	Input search will not work
On1	Input search works*1
On2	Input search works*2

*1 : • When pressing the <AUTO SET> button on the remote control or the <AUTO SETUP> button on the control panel.

*2 : • When turning on the projector by pressing the <ON> button on the remote control or the <ON/STANDBY> button on the control panel.

• When pressing the <AUTO SET> button on the remote control or the <AUTO SETUP> button on the control panel.

• When the current input signal is cut off.*
* If the "AV mute" or "Freeze" function is active, cancel it to activate the [Input search]. It is also unavailable when On-Screen menu is displayed.

Auto PC adj.

On	Enables Auto PC adjustment *1
Off	Disables Auto PC adjustment

*1 : When pressing the <AUTO SET> button on the remote control or the <AUTO SETUP> button on the control panel.

Focus assist

[Focus assist] function is available when it is set to [On]. Then press the <AUTO SET> button on the remote control or the <AUTO SETUP> button on the control panel, [Please wait...] appears, the adjustment starts. A test pattern for focus assist appears on the screen, and a focus assist bar appears in the lower center of the screen. Rotate the focus ring to adjust the focus until the color which displays in the bar change to blue. Then get the clearest image. (➔pages 32-33)

Note

- The focus assist bar will display different colors according to the clarity of image. It turns red when you are rotating the focus ring to the wrong direction. If it turns yellow it means that you are adjusting the focus correctly. Blue is the optimal adjustment.

Screen fit

[Screen fit] function allows you to optimize the image size to the screen and correct the keystone distortion even when projecting from the diagonal to the screen.

[Screen fit] function is available when it is set to [On 1] or [On 2]. Then press the <AUTO SET> button on the remote control or the <AUTO SETUP> button on the control panel, [Please wait...] appears, the adjustment starts. It will not stop until the projected image coincide with screen completely. (➔pages 32-33)

On 1	The aspect ratio of image will change to fit the screen.
On 2	The aspect ratio of image will not change, and no image area will appear in top/bottom sides or left/right sides.

Note

- [Keystone (Standard)] will be executed when the camera window cannot identify the state of screen.

Colorboard

At the time of simple projection on the colored wall, you can get the close color image to the color image projected on a white screen.

[Colorbord] function is available when it is set to [On]. Then press the <AUTO SET> button on the remote control or the <AUTO SETUP> button on the control panel, [Please wait...] appears, the adjustment starts. The [Red], [Green], [Blue] value will change according to the color of the screen.

Note

- [Input search], [Auto PC adj.], [Focus assist], [Screen fit] and [Colorboard] cannot be set [Off] at the same time.

Background

Select the background screen for when no input signal is detected.

- 1) Press ▲ ▼ to select [Background].
- 2) Press the <SELECT> button.
- 3) Press ▲ ▼ to switch between each option as below.

Blue	Blue colored background.
User	The logo transferred by "Logo Transfer Software *1" is projected.
Black	Black colored background.

*1 : "Logo Transfer Software" is included on the supplied CD-ROM.

Display

This function decides whether to display On-Screen Displays.

- 1) Press ▲ ▼ to select [Display].
- 2) Press the <SELECT> button.
- 3) Press ▲ ▼ to switch between each option as below.

On	Show all the On-Screen displays. *1
Countdown off	Show the input image instead of the countdown when turning on the projector. *2
Off	Hide the On-Screen Displays. *3

*1 : Use this function when you want to project images after the lamp becomes bright enough. The factory default setting is in this option.

*2 : Use this function when you want to project the image as early as possible even when the lamp is not bright enough.

*3 : Hide the On-Screen Displays except;

- On-Screen Menu
- [Power off?]
- [P-timer] display
- No signal for [Power management]
- [Please wait ...]
- Arrows for the [True] function in the Screen Menu.

Setting

Logo

This function allows you to customize the screen logo with [Logo select], [Logo PIN code lock] and [Logo PIN code change] functions.

- 1) Press ▲ ▼ to select [Logo].
- 2) Press ► or the <SELECT> button.
- 3) Press ▲ ▼ to choose the desired item.

■ Logo select

This function decides on the starting-up display from among following options.

Off	Show the countdown display only.
Default	Show the factory-set logo.
User	The logo transferred by "Logo Transfer Software *1" is projected.

*1 : "Logo Transfer Software" is included on the supplied CD-ROM.

■ Logo PIN code lock

This function prevents an unauthorized person from changing the screen logo.

Off	The screen logo can be changed freely from the Logo Menu.
ON	The screen logo cannot be changed without a Logo PIN code.

Note

- You can enter a Logo PIN code through the control panel or the remote control. For details, please refer to "Enter a PIN code" (► page 30).
- If you want to change the [Logo PIN code lock] setting, press the <SELECT> button and the [Logo PIN code] dialog box appears. Enter a [Logo PIN code] by following the steps below. The initial [Logo PIN code] is set to "4321" at the factory.

■ Logo PIN code change

Logo PIN code can be changed to your desired four-digit number.

- 1) Press ▲ ▼ to select [Logo PIN code change].
- 2) Press the <SELECT> button.
 - [Current logo PIN code] dialog box appears.
- 3) Press ▲ ▼ to enter the current code.
 - The [New Logo PIN code] input dialog box appears. Set a new [Logo PIN code], a confirmation box appears, choose [Yes] to set the new [Logo PIN code].

Attention

- Be sure to note the new [Logo PIN code] and keep it on hand. If you lost the number, you could no longer change the [Logo PIN code] setting.

HDMI setup

This function is only used for HDMI input source.

- 1) Press ▲ ▼ to select [HDMI setup].
- 2) Press ► or the <SELECT> button.
 - The names for the output setting of Digital R/G/B vary from equipment to equipment.
- 3) Press ▲ ▼ to choose the desired item.

■ Image

Normal	When the output of Digital R/G/B equipment is set to Standard.
Enhanced	When the output of Digital R/G/B equipment is set to Enhanced.

■ Sound

HDMI	When Digital input source is input, [Sound] is set to [HDMI].
Computer 2	When DVI input source is changed to HDMI input source, [Sound] is set to [Computer 2].

Attention

- For details, refer to the operating instructions of your Digital R/G/B equipment.

USB terminal

- 1) Press ▲ ▼ to select [USB terminal] and then press the <SELECT> button.
- 2) Press ▲ ▼ to choose the desired item.

Display	To display the image when the input source comes from the USB terminal.
Mouse control	To use the remote control as a mouse control.

Pointer

You can emphasize a part of the projected image with this function.

- 1) Press ▲▼ to select [Pointer].
- 2) Press ► or the <SELECT> button to access the submenu.
- 3) Press ▲▼ to choose one item among the items such as the size of Spotlight (Large/Middle/Small) and the pattern of Pointer (Arrow/Fingertip/Dot).

Note

- When you reset the [Pointer] function, the remote control code will be reset, as well.

Terminal

The COMPUTER IN 2/ MONITOR OUT terminal on the back of the projector is switchable for computer 2 input or monitor output.

- 1) Press ▲▼ to select [Terminal] and then press the <SELECT> button .
- 2) Press ▲▼ to switch the item.

Computer 2	Computer input
Monitor out	Monitor out

Note

- Terminal function is not available when selecting [Computer 2] to the input source. Change the input source to the others (HDMI or Computer 1 or Video) so that the [Terminal] function will be available.

Power management

For reducing power consumption as well as maintaining the lamp life, the [Power management] function turns off the projection lamp when the projector is not operated for a certain period.

- 1) Press ▲▼ to select [Power management].
- 2) Press ► or the <SELECT> button to access the submenu.

Mode

- 1) Press ▲▼ and then press the <SELECT> button to select one mode among the items as below.

Ready	When the lamp has been fully cooled down, the <POWER> indicator changes to green blinking. In this condition, the projection lamp will be turned on if the input signal is reconnected or any button on the control panel or remote control is pressed.
Shut down	When the lamp has been fully cooled down, the power will be turned off.
Off	Power management function is off.

Timer

- 1) Press ▲▼ to select [Timer] and then press the <SELECT> button.
- 2) Press ▲▼ to set the Timer(1~30min).

Direct on

- 1) Press ▲▼ to select [Direct on] and then press the <SELECT> button.
- 2) Press ▲▼ to switch between On and Off.
 - When this function is set to [On], the projector will be automatically turned on just by connecting the AC power cord to a wall outlet.
 - Be sure to turn off the projector properly. If the projector is turned off in the incorrect sequence, the [Direct On] function does not work properly.

Standby mode

This function can set the electric power when the projector is standing by.

- 1) Press ▲▼ to select [Standby mode] and then press the <SELECT> button.
- 2) Press ▲▼ to switch between the items as below.

Eco	Restricts some functions in standby mode to reduce power consumption.
Network	Does not restrict functionality even in standby mode.

Setting

Attention

- When selecting [Network], the cooling fans may be running depending on the temperature inside the projector even if the projector is turned off.
- If [Standby mode] is set to [Eco], the signals come from MONITOR OUT and AUDIO OUT terminal are unavailable.
- If [Standby mode] is set to [Eco], you can not use network functions when the projector is standing by. Also, you cannot use some RS-232C protocol commands.
- If set to [Network], you can use network functions when the projector is standing by. Refer to "Operating Instructions - Network Operations".

P-timer

This function allows you to change the setting of the P-timer and execute it.

- 1) Press ▲ ▼ to select [P-timer].
- 2) Press ► or <SELECT> button to access the submenu.

Mode

- 1) Press ▲ ▼ button to select one mode among the items as below.

Count up	The P-timer display 000:00 appears on the screen and the count up starts (000:00-180:00).
Count down	The time set in the Timer setting appears on the screen and the countdown starts.

Timer

- 1) Press ▲ ▼ to select [Timer] and then press the <SELECT> button.
- 2) Press ▲ ▼ to set the [Timer](1-180 Min).
 - Timer is available in [Count down] only. Factory default value is 10 Min.

Execute

- 1) Press ▲ ▼ to select one among the items as below and then press the <SELECT> button.

Start	It executes the count up or count down function.*1
Reset	Reset the P-timer values.*2
Exit	To exit the P-timer operation.

- *1 : Press the <SELECT> button at [Start] and the indication changes into [Stop]. To stop [Count up] or [Count down], press the <SELECT> button at [Stop] on the screen menu, then the indication changes into [Restart]. Press the <SELECT> button at [Restart] to resume [Count up] or [Count down].
- *2 : Press the <SELECT> button at [Reset] to return to the following value:

Count up	"000:00"
Count down	Timer that you set

Attention

- To stop the [P-timer] function, press the <P-TIMER> button.
- To cancel the [P-timer], press and hold the <P-TIMER> button for a few seconds.

Closed caption

[Only for NTSC, 480i input]

- 1) Press ▲ ▼ to select [Closed caption].
- 2) Press ► or the <SELECT> button to enter the submenu.

Closed caption

- 1) Press ▲ ▼ to select [Closed caption] and then press the <SELECT> button.
- 2) Press ▲ ▼ to select Off, CC1, CC2, CC3 or CC4.

Color

- 1) Press ▲ ▼ to select [Color] and then press the <SELECT> button.
- 2) Press ▲ ▼ to select color or white.





Attention

- The closed caption is mainly used in the north America. This function shows the text information contained in the image signal. Captions may not be displayed on some devices or software.
- You can select [Closed caption] when [NTSC] or [480i] signals are input.
- Part of characters may not displayed when high compensation valued are set in [Keystone].
- Closed captions are not displayed while the menu screen appears.

Lamp power

This function allows you to change brightness of the screen.

- 1) Press ▲▼ to select [Lamp power] and then press the <SELECT> button.
- 2) Press ▲▼ to select one among the modes as below.
 - You can also press the <LAMP> button to display [Lamp power].

 Auto	Brightness according to the input signal.
 Normal	The lamp power output is maximum.
 Eco1	The lamp power output is 70% of the Normal mode.
 Eco2	The lamp power output is 53% of the Normal mode.

Remote control

This switching function prevents remote control interference when operating several projectors or video equipment at the same time.

- 1) Press ▲▼ to select [Remote control].
- 2) Press ► or the <SELECT> button.
- 3) Press ▲▼ to select one among the seven codes.
 - This projector provides 7 different remote control codes: [ALL], [Code 1]~[Code 6].

Attention

- When operating the projector under [ALL] code, you can operate several projectors at the same time. If you want to operate the projector independently, you must switch to other code.
- When different codes are set on the projector and on the remote control, any operation cannot be made. In that case, switch the code on the remote control to fit the code on the projector.

Security



This function allows you to use the Key lock and PIN code lock function to set the security for the projector operation.

- 1) Press ▲▼ to select [Security].
- 2) Press ► or the <SELECT> button to access the submenu.

Key lock

This function locks the control panel and remote control buttons to prevent operation by unauthorized persons.

- 1) Press ▲▼ to select the desired items as below.

	Unlocked.
	Lock the operation of the control panel. To unlock, use the remote control.
	Lock the operation of the remote control. To unlock, use the control panel.

PIN code lock

This function prevents the projector from being operated by unauthorized persons and provides the following setting options for security.

- 1) Press ▲▼ to select the desired items as below.

Off	Unlocked.
On1	Enter the PIN code every time turning on the projector.
On2	Enter the PIN code to operate the projector once the power cord is disconnected; as long as the AC power cord is connected, the projector can be operated without a PIN code.

Attention

- You can enter a PIN code through the control panel or the remote control. For details, please refer to "Enter a PIN code" (▶page 30).
- Whenever you change the [PIN code lock] setting or the [PIN code] (the four-digit number), you are required to enter the [PIN code]. The "1234" is set as the initial [PIN code] at the factory.

Setting

■ PIN code change

The PIN code can be changed to your desired four-digit number.

- 1) Press ▲ ▼ to select [PIN code change] and then Press <SELECT> button.
 - [Current PIN code] dialog box appears.
- 2) Press ▲ ▼ to enter the current code. Press ► button to fix the number and move the red frame pointer to the next box.
 - The [New PIN code] input dialog box appears.
- 3) Repeat these steps to set a new PIN code.

Fan

- 1) Press ▲ ▼ to select [Fan] and then Press <SELECT> button.
- 2) Press ▲ ▼ to select one option .
 - This function provides the following options in the cooling fans' operation when the projector is turned off.

L1	Normal operation.
L2	Slower and lower-sound than the normal operation (L1), but it takes more time to cool the projector down.

Fan control

- 1) Press ▲ ▼ to select [Fan control] and then Press <SELECT> button.
- 2) Press ▲ ▼ to select one among options as below.
 - Choose the running speed of cooling fans from the following options according to the ground elevation under which you use the projector.

Off	Normal speed.*1
On1	Faster than Off mode.*2
On2	Faster than On 1 mode.*3

*1 : Set this function to [Off] when using the projector in non-high altitude environment.

*2 : Select this mode when using the projector in high altitudes (about 1,200 meters or more above the sea level) where the fans have less cooling effect.

*3 : Select this mode when using the projector in higher altitudes (than above where the fans have lesser cooling effect).

Note

- Failure to set the running speed of cooling fans properly may affect the projector life.
- The fan noise becomes louder in [On 1] and [On 2].

Video delay control

This function allows you to make a digital processing of a projected image faster.

- 1) Press ▲ ▼ to select [Video delay control] and then Press the <SELECT> button.
- 2) Press ▲ ▼ to select one item between On and Off.

Note

- [Noise reduction] and [Progressive] can not be selected when [Video delay control] function is set to [On].

Filter counter

This function is used to set a frequency for the filter replacement.

- 1) Press ▲ ▼ to select [Filter counter].
- 2) Press ► or the <SELECT> button to access the submenu items.

■ Filter counter

Show the total accumulated time of the filter use timer setting.

■ Timer

To set a timer. When the projector reaches the selected time the "filter warning" icon appears on the screen.

- 1) Press ▲ ▼ to select [Timer] and then press the <SELECT> button.
- 2) Press ▲ ▼ to set the Timer.
 - Select from [Off/1000H/2000H/3000H/4000H/5000H/6000H] depending on the use environment.

Filter counter reset

After replacing the filter, be sure to reset the timer.

- 1) Press ▲ ▼ to select [Filter counter reset].
- 2) Press the <SELECT> button.
 - [Filter counter Reset?] appears. Select [Yes] to continue. Another confirmation dialog box appears, select [Yes] to reset the [Filter counter].

Total power savings

This function displays the saved amount of power and the exhausted CO2 of the projector.

- 1) Press ▲ ▼ to select [Total power savings] and then press the <SELECT> button.
 - Show the total accumulated power savings of the projector and display the total amount of CO2 exhausted from the projector.
- 2) Press the <SELECT> button to reset the figures of the total power savings and the exhausted CO2.
 - [Total power savings Reset?] appears. Select [Yes] to continue. Another confirmation dialog box appears, select [Yes] to reset the [Total power savings].

Warning log

This function records anomalous operations while the projector is in operation and use it when diagnosing faults.

- 1) Press ▲ ▼ to select [Warning log].
- 2) Press ► or the <SELECT> button to display the latest warning message.
 - Up to 10 warning logs are displayed with the latest warning message at the top of the list, followed by previous warning messages in chronological order.

Attention

- When the [Factory default] function is executed, all the warning log records will be deleted.

Factory default

This function returns all setting values except for the [User logo], [PIN code lock], [Logo PIN code lock], [Filter counter] and [Total power savings] to the factory default settings.

- 1) Press ▲ ▼ to select [Factory default].
- 2) Press the <SELECT> button.
 - [Return to Factory default?] appears. Select [Yes] to continue. Another confirmation dialog box appears, select [Yes] to return to [Factory default].

Information

Select [Information] from the Main Menu (see “Navigating through the menu” on page 38), then select the item from the sub-menu.

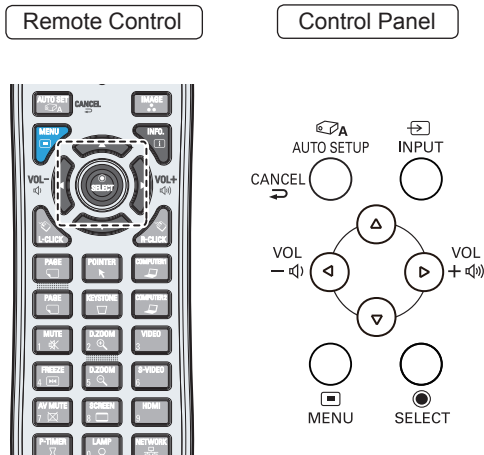

Input Source Information Display

The Information Menu is used for checking the status of the image signal being projected and the operation of the projector.

You can also Press the <INFO.> button on the remote control to display the Information menu.

■ Input

The selected input source is displayed.

■ System

The selected system is displayed.

■ H-sync freq.

The selected H-sync freq. is displayed.
The horizontal frequency of the input signal is displayed in KHz, or - - - KHz when no signal.

■ V-sync freq.

The selected V-sync freq. is displayed.
The vertical frequency of the input signal is displayed in Hz, or - - - Hz when no signal. Numbers of Hz doubles when during Interlace.

■ Screen

The selected Screen size is displayed.

■ Language

The selected language is displayed.

■ Lamp power

The selected lamp mode is displayed.

■ Lamp runtime

The cumulative lamp operating time is displayed.

■ Power management

[Off], [Ready] or [Shut down], and [Timer] are displayed.

■ Key lock

The selected Key lock icon is displayed.

■ PIN code lock

[Off], [On 1] or [On 2] is displayed.

■ Remote control

The selected remote control code is displayed.

■ Serial number

The serial number of the projector is displayed.
The serial number is used to service the projector.

■ Total power savings

The saved amount of power and the exhausted CO2 are is displayed.

LAMP REPLACE and WARNING Indicators

Managing the indicated problems

If a problem should occur inside the projector, the <POWER>, <LAMP REPLACE> and / or <WARNING> indicators will inform you. Manage the indicated problems as follow.

CAUTION

- Before you take a remedial measure, follow the procedure of switching the power off indicated in “Turning off the projector”. (➔page 31)
- If multiple indicators light or blink, verify the status of the projector by looking at each indicator.

Note

- Confirm the status of the power indicated on the <POWER> indicator.

LAMP REPLACE indicator

Indicator	Lighting in yellow
Status	The projection lamp reaches its end of life.
Check	Is there a Lamp replacement icon appears on the screen?
Remedy	Replace the lamp unit. (➔page 67)

Note

- Contact your dealer for repair services when <LAMP REPLACE> indicator persists to light after taking these measurements.

WARNING indicator

Indicator	Lights in red.	Blinks in red.
Status	The projector detects an abnormal condition and cannot be turned on.	The temperature inside the projector is abnormally high. The projector cannot be turned on. And the <POWER> indicator also blinks in red.
Check	Unplug the AC power cord and plug it again to turn on the projector.	- Did you provide appropriate space for the projector to be ventilated? Check the installing condition to see if the air vents of the projector are not blocked. - Has the projector been installed near an Air-Conditioning/ Heating Duct or Vent? - Are the filters clean?
Remedy	If the projector is turned off again, unplug the AC power cord and contact the dealer or the service center for service and checkup.	- Provide good installing condition to your projector. - Move the installation of the projector away from the duct or vent. - Replace filters.

Note

- If <WARNING> indicator persists to light or blink after taking these measurements, please contact your dealer for repair services. Do not leave the projector on. It may cause an electric shock or a fire hazard.
- The projector detects an abnormal condition and cannot be turned on. Unplug the AC power cord and plug it again to turn on the projector. If the projector is turned off again, unplug the AC power cord and contact the dealer or the service center for service and checkup. Do not leave the projector on. It may cause an electric shock or a fire hazard.

Replacement

Before replacing the unit

- When you perform maintenance or replacement of the parts, make sure to turn off the power and disconnect the power plug from the wall outlet. (➔ pages 27, 31)
- Be sure to observe the procedure “Turning off the projector” (➔ page 31) when performing power supply operation.

Maintenance

Outer Case

Wipe off dirt and dust using a soft dry cloth.

- If the dirt is persistent, soak the cloth with water and wring it thoroughly before wiping. Dry off the projector with a dry cloth.
- Do not use benzene, thinner, or rubbing alcohol, other solvents, household cleaners, or chemical treated dusters. Using them may cause deterioration of the outer case.

Front glass surface of the lens

Wipe off the dirt and dust off the front surface of the lens with soft clean cloth.

- Do not use a cloth that has an abrasive surface or a cloth that is moist, oily, or covered with dust.
- Do not use excessive force when wiping the lens as it is fragile.

Attention

- The lens is made of glass. Impacts or excessive force when wiping may scratch its surface. Please handle with care.

Replacing the unit

Air filter units

Filter prevents dust from accumulating on the optical elements inside the projector. Should the filter become clogged with dust particles, it will reduce cooling fans' effectiveness and may result in internal heat buildup and adversely affect the life of the projector.

If a “Filter warning” icon appears on the screen, replace the filters immediately.

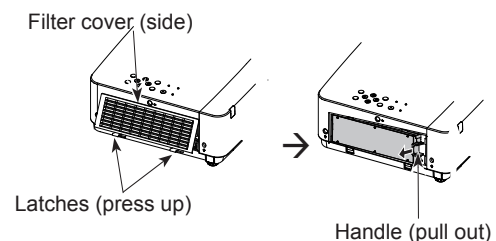
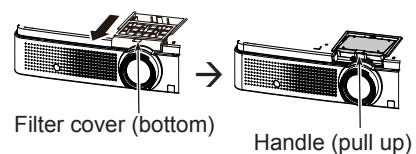

Replacement of the air filter units

1) Remove the air filters.

- Turn over the projector and pull out the filter cover (bottom); pull up the handle and take out the whole filter (bottom.)
Press up the latches and pull out the filter cover (side); pull out the handle and take out the side filter.

2) Replace the air filter units.

- Put new filters back into the position. Make sure that the filters are fully inserted to the projector.

Resetting the Filter Counter

Be sure to reset the Filter counter after replacing the filter. (➔page 61" **Filter counter reset**")

Attention

- Turn off the power before you replace the air filter unit.
- When attaching the air filter unit, make sure that the projector is stable, and work in an environment that is safe, even in the event of the air filter unit dropping.
- Do not operate the projector with the filters removed. Dust may accumulate on the optical elements degrading picture quality.
- Do not put anything into the air vents. Doing so may result in malfunction of the projector.
- Do not wash the filters with water or any other liquid matter. Otherwise the filters may be damaged.

Attaching the Filter Cover to the Projector

The supplied filter cover is designed for preventing dust accumulation on the filter when mounting the projector on the ceiling.

1) Turn over the projector.

2) Remove the filter cover (bottom). (➔page 64)

3) Attaching the filter cover to the projector.

- Push the cover as the picture shown.

4) Attach the projector to the ceiling mount in accordance with the instruction manuals which come with the ceiling mount.

To Ceiling Mount

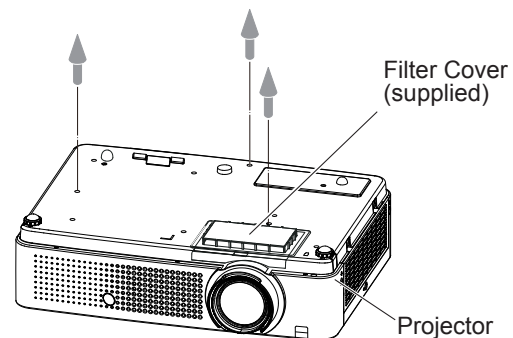

Attention

- Please keep the filter cover (bottom) for later use.
- If the Projector Mount Base ET-PKV100B is applied, the supplied filter cover is unnecessary.

Replacement

Lamp unit

The lamp unit is a consumable component. You can check the total usage time using [Lamp runtime] in the Information menu on page 62.

It is recommended to ask an authorized engineer to replace the lamp unit. Contact your dealer. Consult your dealer to purchase a replacement lamp unit (ET-LAV100).

CAUTION:

- Do not replace the lamp unit when it is hot. (Wait at least 45 minutes after use.)
The inside of the cover can become very hot, take care to avoid burn injuries.

Notes on the replacement of the lamp unit

- The luminous source of the lamp is made of glass and may burst if you hit it against a hard surface or drop it.
Please handle with care.
- A Phillips screwdriver is required for replacement of the lamp unit.
- When replacing the lamp unit, be sure to hold it by the handle.
- When replacing the lamp because it has stopped illuminating, there is a possibility that the lamp may be broken. If replacing the lamp of a projector which has been installed on the ceiling, you should always assume that the lamp is broken, and you should stand to the side of the lamp cover, not underneath it. Remove the lamp cover gently. Small pieces of glass may fall out when the lamp cover is opened. If pieces of glass get into your eyes or mouth, seek medical advice immediately.
- The lamp contains mercury. Consult your local municipality or your dealer about correct disposal of used lamp units.

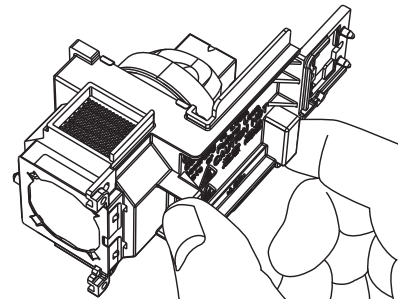



Attention

- Do not use other than designated lamp units.
- The part numbers of accessories and separately sold components are subject to change without notice.

When to replace the lamp unit

The lamp unit is a consumable component. Brightness decreases according to duration of usage, so periodical replacement of the lamp unit is necessary.

When the projection lamp of the projector reaches its end of life, the Lamp replacement icon appears on the screen and <LAMP REPLACE> indicator lights yellow. Replace the lamp with a new one promptly.

Lamp runtime	On screen Lamp replacement icon 	LAMP REPLACE indicator 
Over 3000 hours *	The message is displayed for 10 seconds. If you press any button within the 10 seconds, the message disappears.	Lights in yellow (even in stand-by mode).
Over 3200 hours *	If the power is turned on without replacing the lamp, the power automatically turns off after approximately ten minutes to prevent the malfunction of the projector.	

*3200 hours of use is a rough guideline, but is not a guarantee. The lamp runtime differs depending on the setting of "Lamp power" menu.

Note

- The Lamp replacement icon will not appear when the [Display] function is set to [Off] (➔page 55), or during "Freeze" (➔page 37), or "AV mute" (➔page 37).

■ Replacing the Lamp unit

CAUTION:

- When the projector is mounted on a ceiling, do not work with your face close to the projector.
- Attach the lamp unit and the lamp cover securely.
- When you experience difficulty in installing the lamp, remove it and try again. If you use force to install the lamp, the connector may be damaged.

1) Turn off the Power by following the procedure in “Turning off the projector (→page 31). Unplug the AC power cord. Wait at least 45 minutes and make sure the lamp unit and surroundings are cool.

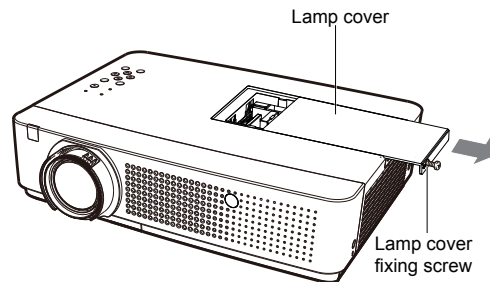

2) Use a Phillips screwdriver to loosen the lamp cover fixing screw and remove the lamp cover.

- Remove the lamp cover by pulling it slowly toward the direction of the arrow.

3) Use a Phillips screwdriver to loosen three lamp unit fixing screws until the screws turn freely. Hold the used lamp unit by its handles, and pull it gently from the projector.

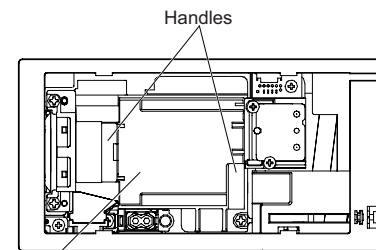

4) Insert the new lamp unit in correct direction. Tighten the three lamp unit fixing screws securely with a Phillips screwdriver.

Lamp unit

5) Attach the lamp cover, and tighten the lamp cover fixing screw securely with a Phillips screwdriver.

- Attach the lamp cover by pushing it slowly opposite the direction of the arrow.

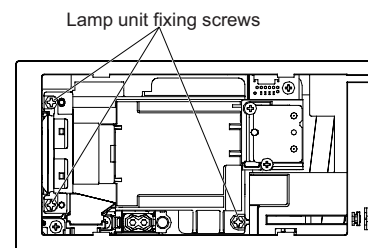

Note

- When you replace the new lamp unit (ET-LAV100), the projector resets the total usage time of the lamp unit automatically.

Replacement

Attaching the Lens Cap

When moving this projector or while not using it over an extended period of time, attach the lens cap. Attach the lens cap according to the following procedures.

- 1) **Thread the string through the hole on the lens cap and then tie a knot in the string to secure it in place.**
- 2) **To pass the other end of the string into the hole on the bottom of the projector and pull at it.**

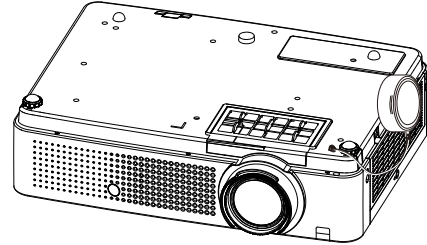

Troubleshooting

Please check following points. For details, see the corresponding pages.

Problem	Cause	Reference page
Power does not turn on.	● The power cord may not be connected.	—
	● No electric supply is at the wall outlet.	—
	● The circuit breakers have tripped.	—
	● Is the <LAMP REPLACE> indicator, <POWER> indicator, or <WARNING> indicator lit or blinking?	28, 63
	● The lamp cover has not been securely installed.	67
No picture appears.	● The video signal input source may not be connected to a terminal properly.	26
	● The input selection setting may not be correct.	36
	● The [Brightness] adjustment setting may be at the minimum setting.	47
	● The input source which is connected to the projector may have a problem.	—
	● The [AV mute] function may be in use.	37
The picture is fuzzy.	● The lens focus may not have been set correctly.	32
	● The projector may not be at the correct distance from the screen.	24
	● The lens may be dirty.	14
	● The projector may be tilted too much.	—
The color is pale or grayish.	● [Color] or [Tint] adjustment may be incorrect.	47
	● The input source which is connected to the projector may not be adjusted correctly.	—
	● RGB cable is damaged.	—
No sound from the internal speaker	● The input terminals may not have been correctly connected.	26
	● The volume may have been set to the minimum level.	34, 53
	● The [AV mute] function may have been turned on.	37
	● When the AUDIO OUT is plugged-in, the projector's built-in speaker is not available.	21
	● The [Mute] function may have been turned on.	36, 53
The remote control does not operate.	● The ON/OFF switch on the remote control is set to "OFF".	—
	● The batteries may be weak.	—
	● The batteries may not have been inserted correctly.	22
	● The remote control signal receptor on the projector may be obstructed.	18
	● The remote control unit may be out of the operation range.	18
	● Strong light such as fluorescent shine onto the signal receptor.	18
	● When different codes are set on the projector and on the remote control.	59
The control buttons of the projector do not operate.	● The control panel is not available if the control panel is locked at [Key lock] under [Security] of [Setting] section.	59
The picture does not display correctly.	● There may be a problem with the VCR or other signal source.	—
	● A signal which is not compatible with the projector is being input.	76 - 79

Troubleshooting

Problem	Cause	Reference page
Picture from a computer does not appear.	<ul style="list-style-type: none"> • The cable may be longer than the optional cable. • The external video output from a laptop computer may not be correct. 	— —
Picture from a HDMI device does not appear or picture is not stable.	<ul style="list-style-type: none"> • Is the HDMI cable securely connected? • Turn off the power of the projector and the connected devices. Then turn the power of the projector and the connected devices back on. • Isn't unsupported signal cable connected? 	26 — 76-79
No sound is output from a HDMI device.	<ul style="list-style-type: none"> • Set the sound channel of the attached device to Linear PCM. • If no audio signal is output during HDMI cable connection, connect the audio cable to COMPUTER AUDIO IN 2 terminal and set to "Computer 2" in "Sound" of "Setting" menu. . 	— 56
The image is distorted or runs off.	<ul style="list-style-type: none"> • Check [PC adj.] or [Screen] and adjust them. 	44, 50

Note

- If the problem persists, after confirming the contents of the table, please consult your dealer.

Technical Information

Serial terminal

The serial connector which is on the connector panel of the projector conforms to the RS-232C interface specification, so that the projector can be controlled by a personal computer which is connected to this connector.

■ Connection

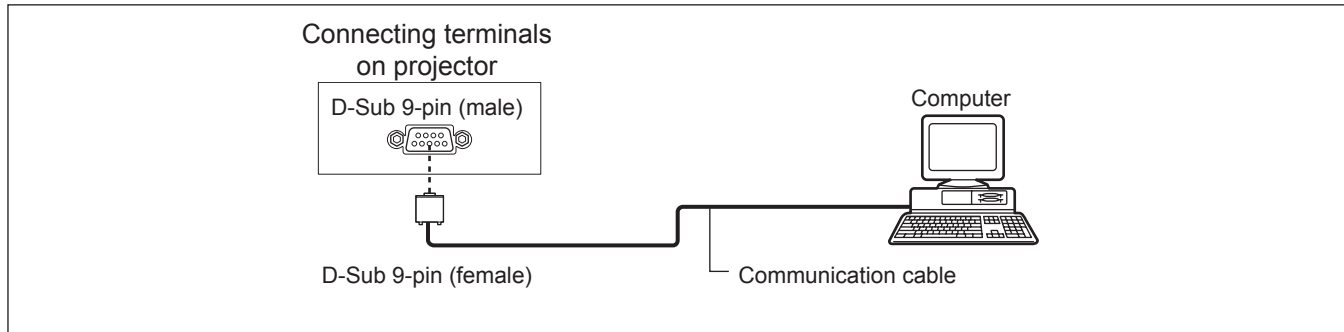

■ Pin assignments and signal names

D-Sub 9-pin (male) Outside view	Pin No.	Signal name	Contents
	①	—	NC
	②	RXD	Received data
	③	TXD	Transmitted data
	④	—	NC
	⑤	GND	Earth
	⑥	—	NC
	⑦	—	NC
	⑧	—	NC
	⑨	—	NC

■ Communication conditions

Signal level	RS-232C-compliant
Sync. method	Asynchronous
Baud rate	19200 bps
Parity	None

Character length	8 bits
Stop bit	1 bit
X parameter	None
S parameter	None

Note

- When [AMX D. D.] function is set to [On] under the "Network" menu, the Baud rate will change to 9600 bps automatically.

Basic format

Transmission from the computer begins with STX, then the command, parameter, and ETX are sent in this order. Add parameters according to the details of control.

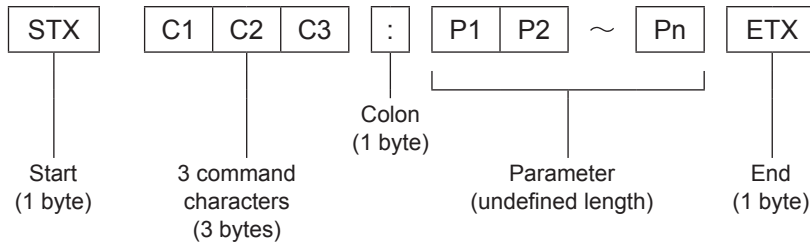

*: When sending commands without parameters, a colon (:) is not necessary.

Basic format (with sub command)

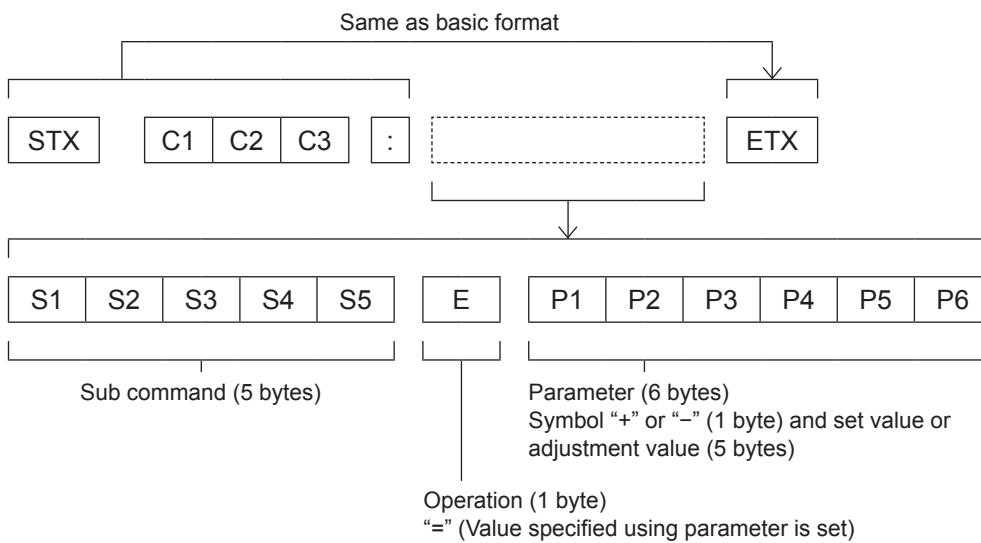

*: When transmitting a command which does not need a parameter, the operation (E) and parameter are not necessary.

Cable specifications

[When connected to a computer]

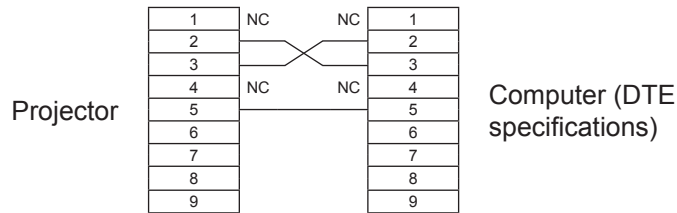

Control commands

When controlling the projector from a computer, the following commands are available:

[Projector control command]

Command	Control contents	Remarks
PON	Power [ON]	
POF	Power [OFF]	
IIS	INPUT selection	(Parameter) VID = Video SVD = S-video RG1 = Computer 1 (RGB) RG2 = Computer 2 (RGB) HD1 = HDMI SCT = Computer 1 (Scart) NWP = Network
OSH	AV mute function	Turning off the projection and sound temporarily. Sending the command switches ON/OFF. Do not switch ON/OFF in a short period of time.
OFZ	Freeze	Sending the command switches ON/OFF.
AUU	Volume up	
AUD	Volume down	
DZU	D. ZOOM up	
DZD	D. ZOOM down	
QPW	Power query	000 = Standby 001 = Power on
Q\$\$	Lamp condition query	(Call back) 0 = Stand-by 1 = Lamp ON control active 2 = Lamp ON 3 = Lamp OFF control active

Other terminals

Pin assignments and signal names of <S-VIDEO IN> terminal

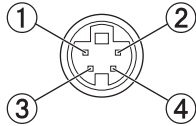
Outside view	Pin No.	Signal names
	①	GND (luminance signal)
	②	GND (color signal)
	③	Luminance signal
	④	Color signal

Pin assignments and signal names of <COMPUTER IN 1/COMPONENT IN> terminal

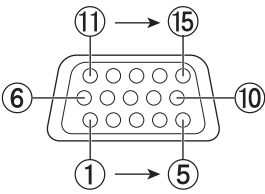
Outside view	Pin No.	Signal names	
	①	R/P _R	
	②	G/G · SYNC/Y	
	③	B/P _B	
	⑨	+ 5 V	
	⑫	DDC data	
	⑬	HD/SYNC	
	⑭	VD	
	⑮	DDC clock	
	④		④ : Not assigned
	⑤ - ⑧, ⑩, ⑪		⑤ - ⑧, ⑩, ⑪ : GND terminals

Pin assignments and signal names of <COMPUTER IN 2/MONITOR OUT> terminal

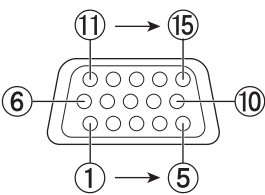
Outside view	Pin No.	Signal names	
	①	R/P _R	
	②	G/G · SYNC/Y	
	③	B/P _B	
	⑬	HD/SYNC	
	⑭	VD	
	④		④, ⑨, ⑪, ⑫, ⑮ : Not assigned
	⑤ - ⑧, ⑩		⑤ - ⑧, ⑩ : GND terminals
	⑥		
	⑦		
	⑮		

Pin assignments and signal names of <HDMI> terminal

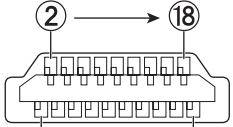
Outside view	Pin No.	Signal names	Pin No.	Signal names
<p>Even-numbered pins ② to ⑮</p>  <p>Odd-numbered pins ① to ⑮</p>	①	T.M.D.S data 2+	⑪	T.M.D.S clock shield
	②	T.M.D.S data 2 shield	⑫	T.M.D.S clock -
	③	T.M.D.S data 2-	⑬	CEC
	④	T.M.D.S data 1+	⑭	—
	⑤	T.M.D.S data 1 shield	⑮	SCL
	⑥	T.M.D.S data 1-	⑯	SDA
	⑦	T.M.D.S data 0+	⑰	DDC/CEC GND
	⑧	T.M.D.S data 0 shield	⑱	+5V
	⑨	T.M.D.S data 0-		Hot plug detection
	⑩	T.M.D.S clock +		

USB CONNECTOR (Type A)

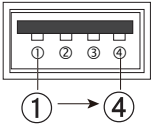
Outside view	Pin No.	Signal names
	①	+5V
	②	- Data
	③	+Data
	④	GND

■ USB CONNECTOR (Type B)

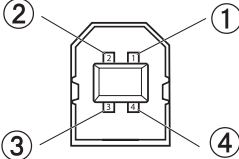
Outside view	Pin No.	Signal names
	①	+5V
	②	- Data
	③	+Data
	④	GND

Technical Information

List of compatible signals

The following table specifies the types of signals compatible with the projectors.

Format : V = VIDEO, S = S-VIDEO, C = COMPUTER, Y = YP_BP_R, H = HDMI

Mode	Display resolution *1 (dots)	Scanning frequency		Dot clock frequency (MHz)	Picture quality *2 PT-VX400NTE	PnP		Format
		H (kHz)	V (Hz)			COMPUTER	HDMI	
480p	640 x 480	31.47	59.88	25.2	A			C/Y
480i	640 x 480i	15.734	60.00	12.2727				
576p	768 x 576	31.25	50.00	29.5	A			
576i	768 x 576i	15.625	50.00	14.75	A			
720p	1280 x 720	37.50	50.00	74.25				
		45.00	60.00	74.25				
1035i	1920 x 1035i	33.75	60.00	74.25	A		○	
1080/50i	1920 x 1080i	28.125	50.00	74.25	A		○	
1080/60i	1920 x 1080i	33.75	60.00	74.25	A		○	
VGA	640 x 480	31.47	59.88	25.149	A	○	○	C
		37.86	74.38	31.50	A	○		
		37.86	72.81	31.50	A	○		
		37.50	75.00	31.50	A	○		
	43.269	85.00	36.00	A				
	640 x 400	31.47	70.09	25.175	A			
720 x 400	31.47	70.09	28.322	A				
SVGA	800 x 600	35.156	56.25	36.00	A	○		
		37.88	60.32	40.00	A	○	○	
		46.875	75.00	49.50	A	○		
		53.674	85.06	56.25	A	○		
		48.08	72.19	50.00	A			
		37.90	61.03	40.02	A			
		34.50	55.38	36.432	A			
		38.00	60.51	40.128	A			
		38.60	60.31	38.60	A			
32.70	51.09	32.70	A					
38.00	60.51	40.128	A					
MAC	1280 x 960	75.00	75.08	126.00	A	○		
	1280 x 1024	80.00	75.08	135.20	A	○		
MAC 13	640 x 480	35.00	66.67	30.24	A	○		
MAC LC13	640 x 480	34.97	66.60	31.33	A	○		
MAC 16	832 x 624	49.72	74.55	57.283	A	○		
MAC 19	1024 x 768	60.24	75.08	80.01	A	○		
MAC 21	1152 x 870	68.68	75.06	100.00	A	○		
SXGA+1	1400 x 1050	63.970	60.190	107.990				
SXGA+2	1400 x 1050	65.350	60.120	122.850				
SXGA+3	1400 x 1050	65.120	59.900	122.430				

*1 : "i" added to the resolution value indicates an interlaced signal.

*2 : Picture quality is indicated by the following symbols.

AA: Maximum picture quality can be obtained.

A: Signals are converted by the image processing circuit.

Mode	Display resolution *1 (dots)	Scanning frequency		Dot clock frequency (MHz)	Picture quality *2 PT-VX400NTE	PnP		Format
		H (kHz)	V (Hz)			COMPUTER	HDMI	
XGA	1024 x 768	48.36	60.00	65.00	AA			C
		68.677	84.977	94.504	AA	○	○	
		60.023	75.03	78.75	AA	○	○	
		56.476	70.07	75.00	AA	○	○	
		60.31	74.92	79.252	AA			
		48.50	60.02	65.179	AA			
		44.00	54.58	59.129	AA			
		63.48	79.35	83.41	AA			
		62.04	77.07	84.375	AA			
		61.00	75.70	81.00	AA			
		46.90	58.20	63.03	AA			
		47.00	58.30	61.664	AA			
	58.03	72.00	74.745	AA				
	1024 x 768i	36.00	87.17	47.30	AA			
35.522		86.96	44.90	AA				
SXGA	1152 x 864	64.20	70.40	94.560	A			
	1152 x 900	61.20	65.20	92.00	A			
		71.40	75.60	105.10	A			
	1280 x 960	61.85	66.00	94.50	A			
		60.00	60.00	108.00	A	○		
	1280 x 1024	62.50	58.60	108.00	A		○	
		63.90	60.00	107.35	A	○		
		63.34	59.98	108.18	A			
		63.74	60.01	109.497	A			
		71.69	67.19	117.004	A			
		81.13	76.107	135.008	A			
		63.98	60.02	108.00	A			
		79.976	75.025	135.00	A			
		63.37	60.01	111.520	A			
		76.97	72.00	130.08	A			
		63.79	60.18	108.19	A			
	91.146	85.024	157.5	A				
	1280 x 1024i	50.00	86.00	80.00	A			
50.00		94.00	80.00	A				
46.43		86.70	78.745	A				
D-VGA	640 x 480	31.47	59.94	25.175	A		H	
D-480p	640 x 480	31.47	59.88	25.2				
D-576p	768 x 576	31.25	50.00	29.5				
D-720p	1280 x 720	37.50	50.00	74.25				
		45.00	60.00	74.25				
D-SVGA	800 x 600	37.879	60.32	40				
D-XGA	1024 x 768	43.363	60.00	65				
D-SXGA+1	1400 x 1050	63.97	60.19	107.99				
D-SXGA+2	1400 x 1050	65.350	60.120	122.850				

*1 : "i" added to the resolution value indicates an interlaced signal.

*2 : Picture quality is indicated by the following symbols.

AA: Maximum picture quality can be obtained.

A: Signals are converted by the image processing circuit.

Technical Information

Mode	Display resolution *1 (dots)	Scanning frequency		Dot clock frequency (MHz)	Picture quality *2 PT-VX400NTE	PnP		Format
		H (kHz)	V (Hz)			COMPUTER	HDMI	
D-SXGA+3	1400 x 1050	65.120	59.900	122.430				H
UXGA	1600 x 1200	75.00	60.00	162.00	A	○		C
		81.25	65.00	175.50				
		87.5	70.00	189.00	A	○		
		93.75	75.00	202.50	A			
WXGA	1280 x 768	47.776	59.870	79.500	A			
		60.289	74.893	102.250	A	○	○	
		68.633	84.837	117.500				
		55.993	69.991	94.964				
		57.675	72.004	97.817				
	1280 x 800	49.600	60.050	79.360	A			
		41.200	50.000	68.557	A			
		49.702	59.810	83.500	A	○	○	
		63.980	60.020	108.000				
		58.289	69.975	98.858				
		60.044	71.995	102.795				
		62.790	74.928	106.492				
	1366 x 768	71.553	84.879	122.498				
		48.36	60.00	86.67	A	○		
47.70		60.00	86.67					
1360 x 768	56.16	72.00	100.19					
	48.36	60.00	86.67					
1376 x 768								
WSXGA+1	1680 x 1050	65.290	59.954	146.250				
WXGA+1	1440 x 900	55.935	59.887	106.500				
WXGA+2	1440 x 900	74.918	60.000	161.850				
WUXGA	1920 x 1200	74.556	59.885	193.250	A	○		
		74.038	59.950	154.000	A			
D-WXGA	1360 x 768	47.700	60.00	86.670				
		56.160	72.000	100.190				
	1366 x 768	46.500	50.000	67.400				
		48.360	60.00	86.670				
	1376 x 768	48.360	60.00	86.670				
		47.776	59.870	79.500				
	1280 x 768	60.289	74.893	102.250				
		68.633	84.837	117.500				
		49.572	59.870	83.282				
	1280 x 800	41.200	50.000	68.557				
		49.702	59.810	83.500				
		63.980	60.020	108.000				
		58.289	69.975	98.858				
		60.044	71.995	102.795				
62.790		74.928	106.492					
71.553		84.879	122.498					
55.993		69.991	94.964					
57.675		72.004	97.817					

Mode	Display resolution *1 (dots)	Scanning frequency		Dot clock frequency (MHz)	Picture quality *2 PT-VX400NTE	PnP		Format
		H (kHz)	V (Hz)			COMPUTER	HDMI	
D-SXGA	1280 x 1024	63.98	60.02	108				H
		60.276	58.069	93.067				
		31.65	29.8	53.48				
D-1035i	1920 x 1035i	33.75	60.00	74.25				
D-1080/50i	1920 x 1080i	28.125	50.00	74.25				
D-1080/60i	1920 x 1080i	33.75	60.00	74.25				
D-1080p	1920 x 1080	67.5	60.00	148.5				
		56.25	50.00	148.5				
D-WXGA+1	1440 x 900	55.935	59.887	106.500				
D-WSXGA+1	1680 x 1050	65.290	59.954	146.250				
D-WUXGA 2	1920 x 1200	74.038	59.950	154.000				

*1 : "i" added to the resolution value indicates an interlaced signal.

*2 : Picture quality is indicated by the following symbols.

AA: Maximum picture quality can be obtained.

A: Signals are converted by the image processing circuit.

Note

- The number of display dots is 1024 x 768 for the PT-VX400NTE.
A signal with a different resolution will be projected after converting the resolution to match the projector display.
- When interlaced signals are connected, flicker may occur on the projected image.

Specifications

Model No.		PT-VX400NTE
Power supply		AC100 V - 240 V 50 Hz/60 Hz
Power consumption		100 V - 240 V 3.8 A-1.8 A 322 W When [Standby mode] of [Setting] is set to [Eco]: 0.48 W (100 V - 120 V), 0.5 W (220 V - 240 V) When [Standby mode] of [Setting] is set to [Network]: 14.5W When [Standby MIC out] of [Sound] is set to [On]: Max.26 W
LCD panel	Panel size	1.6 cm(0.63") (aspect ratio 4 : 3)
	Display method	3 transparent LCD panels (RGB)
	Drive method	Active matrix method
	Pixels	786 432 (1 024 x 768) x 3 panels
Lens		Manual zoom (1.6x) / Manual focus F 1.65 to 2.33, f 15.47 mm to 24.53 mm
Luminous lamp		245 W UHP lamp
Light output *1		4000 lm (ANSI)
Applicable scanning frequency *2	for RGB signal	Horizontal 15 kHz to 100 kHz, Vertical 50 Hz to 100 Hz Dot clock frequency: 140 MHz or less
	for YP _B P _R signal	[525i(480i)] Horizontal 15.75 kHz, Vertical 60 Hz [525p(480p)] Horizontal 31.5 kHz, Vertical 60 Hz [750(720)/60p] Horizontal 45 kHz, Vertical 60 Hz [1125(1080)/60i] Horizontal 33.75 kHz, Vertical 60 Hz [625i(576i)] Horizontal 15.63 kHz, Vertical 50 Hz [625p(576p)] Horizontal 31.25 kHz, Vertical 50 Hz [750(720)/50p] Horizontal 37.5 kHz, Vertical 50 Hz [1125(1080)/50i] Horizontal 28.13 kHz, Vertical 50 Hz ● HD/SYNC and V terminals are not compliant with 3 value composite SYNC
	for Video signal (including S-video)	Horizontal 15.75 kHz / 15.63 kHz, Vertical 50 Hz / 60 Hz
	for HDMI signal	525p(480p), 625p(576p), 750(720)/60p, 750(720)/50p, 1125(1080)/60p, 1125(1080)/50p, 1125(1080)/60i, 1125(1080)/50i ● Displayable resolution: VGA to WUXGA (non-interlace) ● Dot clock frequency: up to 162 MHz
Color system		7 (NTSC, NTSC4.43, PAL, PAL-N, PAL-M, SECAM, PAL60)
Projection size		0.76 m - 7.62 m (30"-300")
Screen aspect ratio		4 : 3
Projection scheme		Front / Rear / Mount on Ceiling / Floor (Menu setting system)
Speaker		1 (3.7 cm round-type)
Maximum usable volume output		10W
Contrast ratio *1		2000 : 1 (all white / all black)

*1 : Measurement, measuring conditions and method of notation all comply with ISO21118 international standards.

*2 : For details of video signals that can be projected using this projector, refer to "List of compatible signals".
(➡ page 76-79)

Specifications

Model No.		PT-VX400NTE
Terminals	COMPUTER IN 1/ COMPONENT IN	1 (D-sub 15 pin female) [RGB signal] 0.7 V [p-p] 75 Ω (When G-SYNC: 1.0 [p-p] 75 Ω HD/SYNC TTL high impedance, automatic positive/negative polarity compatible VD TTL high impedance, automatic positive/negative polarity compatible [YP _B P _R signal] Y: 1.0 V [p-p] including synchronization signal, P _B P _R : 0.7 V [p-p] 75 Ω
	COMPUTER IN 2/ MONITOR OUT	[RGB signal] 0.7 V [p-p] 75 Ω (When G-SYNC: 1.0 [p-p] 75 Ω HD/SYNC TTL high impedance, automatic positive/negative polarity compatible VD TTL high impedance, automatic positive/negative polarity compatible
	VIDEO IN	1 (RCA pin jack 1.0 V [p-p] 75 Ω)
	S-VIDEO IN	1 (Mini DIN 4 pin, Y 1.0 V [p-p], C 0.286 V [p-p] 75 Ω, S1 signal compatible)
	HDMI IN	1 (HDMI 19 pin, HDCP and Deep color compatible)
	AUDIO IN	2 (M3 stereo mini jack, 0.5 V [rms], input impedance 22 kΩ and more) 1 (RCA pin jack x 2 (L-R), 0.5 V [rms], input impedance 22 kΩ and more)
	AUDIO OUT	1 (M3 stereo mini jack, stereo monitor output compatible, 0 V [rms] to 2.0 V [rms] valuable, output impedance 2.2 kΩ and less)
	USB Connectors	USB connector (Series A x1, Series B x 1)
	CONTROL PORT	1 (D-sub 9 pin, RS-232C compliant, for computer control use)
	LAN	1 (for RJ-45 network connection, PLink compatible,)
Power cable length		2.0 m (195.75")
Cabinet		Molded plastic
Wireless LAN	Compatible	IEEE802.11 b/g/n (Wireless LAN standard protocol)
	Wireless channel	IEEE802.11 b/g/n: 1 - 13 channels
	Distance	Approx. 30 m (98'5") (depends on the usage environment)
Dimensions		Width: 350 mm (13.78") Height: 97.0 mm (3.82") (when front adjustable feet shortened) Depth: 276.9 mm (10.9") (excluding protractions)
Weight		Approx. 3.6 kg (7.94 lbs.) *3
Operating environment		Operating environment temperature : 5 °C (41 °F) to 35 °C (95 °F) Operating environment humidity: 20 % to 80 % (no condensation)
Remote control	Power supply	DC 3 V (battery (AAA/R03 or AAA/LR03) x 2)
	Operating range	Approx. 5 m (196.9") (when operated directly in front of receptor)
	Weight	102 g (3.6 ozs.) (including batteries)
	Dimensions	Width : 48 mm (1.9"), Length : 145 mm (5.7"), Height : 27 mm (1.1")

*3 : This is an average value. It may differ depending on individual product.

- The part numbers of accessories and separately sold components are subject to change without notice.

Specifications

Dimensions

<Unit : mm>

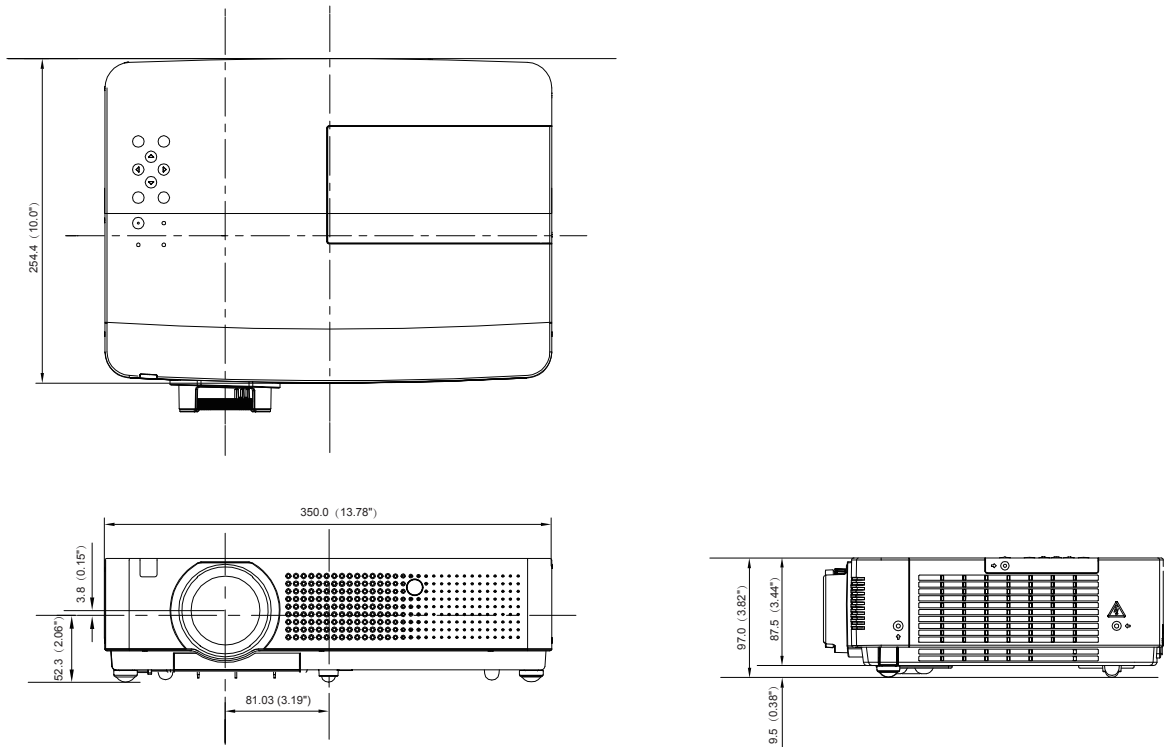

*: Actual dimension may differ by product.

Ceiling mount bracket safeguards

- Installation work of the ceiling mount bracket should only be carried by a qualified technician.
- Even if it is during guaranteed period, the manufacturer is not responsible for any hazard or damage caused by using a ceiling mount bracket which is not purchased from an authorized distributors, or environmental conditions.
- Remove an unused ceiling mount bracket promptly.
- Ensure to use a torque driver and do not use an electrical screwdriver or an impact screwdriver.
- For details, see the work instruction manual packed together with the ceiling mount bracket.
- The model Nos. of the accessories and the parts sold separately are subject to change without notice.
- Make sure the screws on the ceiling mount kit cannot touch the metal parts materials (metallic lath, wire or board) in the ceiling board. Otherwise it may result in fire hazard.

Bottom view

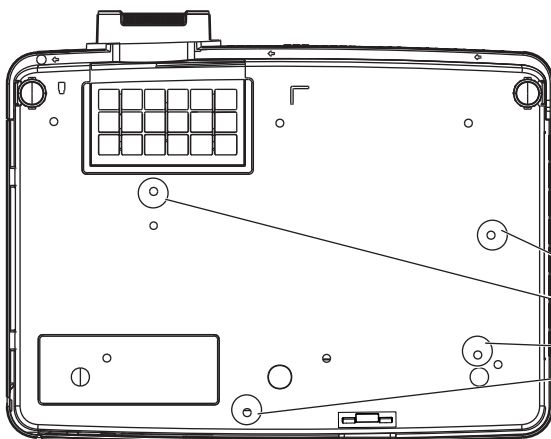

Model No. of ceiling mount bracket:
ET-PKV100H (for high ceilings)
ET-PKV100S (for low ceilings)
Model No. of projector mount base:
ET-PKV100B

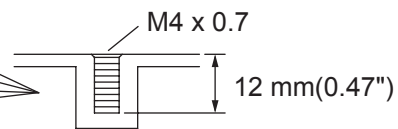

Torque: 1.2 ± 0.1 N·m

Index

A			
About Your Projector.....	17	Installing and Removing batteries ..	22
Accessories	15	K	
Adjusting front adjustable feet	25	Keystone.....	35, 51
Attaching the Lens Cap	68	L	
AUTO PC adjust	43	Lamp power.....	59
Auto setup	54	LAMP REPLACE indicator	63
AV MUTE.....	37	Lamp unit.....	66
B		Language.....	54
Background	55	List of compatible signals	76
Basic operations by using the remote control	34	Logo.....	56
Blackboard(Green)	46	M	
Brightness.....	47	Main menu.....	39
C		Maintenance	64
Cautions on use.....	14	Managing the indicated problems..	63
Cautions when installing.....	12	Manual PC adjust	44
Cautions when transporting.....	7, 12	Menu Navigation.....	38
CD-ROM.....	16	Menu position	54
Ceiling.....	51	MIC	53
Cinema	46	Mute.....	36, 53
Closed caption.....	58	N	
Color	47	Noise reduction.....	48
Colorboard.....	46, 55	Normal	50
Color temp	47	O	
Computer System Selection.....	41	Optional accessories	16
Connecting	26	Other terminals	74
Connecting the power cord.....	27	P	
Contrast.....	47	PIN code.....	30
Control panel	20	PIN code Protection.....	30
Custom	50	Pointer	57
Custom adj.	50	POWER indicator	28
D		Power management	57
Digital zoom.....	51	Precautions for Use.....	12
Direct on	57	Progressive.....	49
Direct Power Off function.....	31	Projecting.....	32
Display.....	55	Projection distance	24
Disposal.....	13	Projection method.....	23
Dynamic.....	46	Projector body	19
F		P-timer	58
Factory default.....	61	R	
Fan	60	Read this first!.....	2
Fan control.....	60	Real	46
Filter counter.....	60	Rear.....	52
Focus assist.....	55	Rear terminals	21
FREEZE	37	Remote control	17, 59
Full.....	50	Replacing the Lamp unit.....	67
G		Replacing the unit.....	64
Gamma.....	48	S	
H		Screen	50
HDMI setup.....	56	Screen fit	32, 33, 55
I		Screen size and throw distance.....	24
ID numbers	22	Security.....	13, 59
Image adjust.....	47	Selecting the image	32
Image select	46	Serial terminal.....	71
Information.....	62	Setting	54
Input menu.....	41	Setting the ID number.....	22
Input search.....	54	Setting up	23
		Sharpness	48
		Sound	53
		Specifications	80
		Standard.....	46
		Standby mode	57
		Sub menu	39
		Switching the input signal.....	36
		T	
		Terminal.....	57
		Tint.....	47
		Total power savings.....	61
		Troubleshooting.....	69
		True	50
		Turning Off the Projector	31
		Turning On the Projector	29
		U	
		USB terminal	56
		V	
		Video delay control	60
		Video System Selection.....	41
		Volume.....	53
		W	
		WARNING indicator.....	63
		Warning log	61
		Wide(16:9).....	50
		Wireless mouse	35
		Z	
		Zoom	50

Information for Users on Collection and Disposal of Old Equipment and used Batteries



These symbols on the products, packaging, and/or accompanying documents mean that used electrical and electronic products and batteries should not be mixed with general household waste. For proper treatment, recovery and recycling of old products and used batteries, please take them to applicable collection points, in accordance with your national legislation and the Directives 2002/96/EC and 2006/66/EC.

By disposing of these products and batteries correctly, you will help to save valuable resources and prevent any potential negative effects on human health and the environment which could otherwise arise from inappropriate waste handling.



For more information about collection and recycling of old products and batteries, please contact your local municipality, your waste disposal service or the point of sale where you purchased the items.

Penalties may be applicable for incorrect disposal of this waste, in accordance with national legislation.



For business users in the European Union

If you wish to discard electrical and electronic equipment, please contact your dealer or supplier for further information.

Cd

Information on Disposal in other Countries outside the European Union

These symbols are only valid in the European Union. If you wish to discard these items, please contact your local authorities or dealer and ask for the correct method of disposal.

Note for the battery symbol (bottom two symbol examples):

This symbol might be used in combination with a chemical symbol. In this case it complies with the requirement set by the Directive for the chemical involved.

Panasonic Corporation

Web Site : <http://panasonic.net/avc/projector/>