

## Operating Instructions Functional Manual

DLP™ Projector Commercial Use

---

Model No. PT-DW730E  
PT-DW730EL  
PT-DX800E  
PT-DX800EL

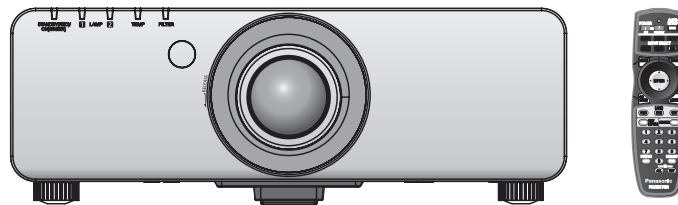

Thank you for purchasing this Panasonic product.

- This manual is common to all the models regardless of suffixes of the Model No.
  - S: Silver model, the standard zoom lens supplied    LS: Silver model, the lens sold separately
  - K: Black model, the standard zoom lens supplied    LK: Black model, the lens sold separately
- Before operating this product, please read the instructions carefully and save this manual for future use.
- Before using your projector, be sure to read “Read this first!” (➡ pages 2 to 8)

# Read this first!

**WARNING:** THIS APPARATUS MUST BE EARTHED.

**WARNING:** To prevent damage which may result in fire or shock hazard, do not expose this appliance to rain or moisture.

Machine Noise Information Ordinance 3. GSGV, January 18, 1991: The sound pressure level at the operator position is equal or less than 70 dB (A) according to ISO 7779.

**WARNING:**

1. Remove the plug from the mains socket when this unit is not in use for a prolonged period of time.
2. To prevent electric shock, do not remove cover. No user serviceable parts inside. Refer servicing to qualified service personnel.
3. Do not remove the earthing pin on the mains plug. This apparatus is equipped with a three prong earthingtype mains plug. This plug will only fit an earthing-type mains socket. This is a safety feature. If you are unable to insert the plug into the mains socket, contact an electrician. Do not defeat the purpose of the earthing plug.

**WARNING:**

This is a class A product. In a domestic environment this product may cause radio interference in which case the user may be required to take adequate measures.

**CAUTION:** To assure continued compliance, follow the attached installation instructions, which include using the provided power cord and shielded interface cables when connecting to computer or peripheral device. If you use serial port to connect PC for external control of projector, you must use optional RS-232C serial interface cable with ferrite core. Any unauthorized changes or modifications to this equipment will void the user's authority to operate.

EEE Yönetmeliğine Uygundur.

EEE Complies with Directive of Turkey.

**IMPORTANT: THE MOULDED PLUG (U.K. only)**FOR YOUR SAFETY, PLEASE READ THE FOLLOWING TEXT CAREFULLY.

This appliance is supplied with a moulded three pin mains plug for your safety and convenience. A 13 amp fuse is fitted in this plug. Should the fuse need to be replaced, please ensure that the replacement fuse has a rating of 13 amps and that it is approved by ASTA or BSI to BS1362.

Check for the ASTA mark  or the BSI mark  on the body of the fuse.

If the plug contains a removable fuse cover, you must ensure that it is refitted when the fuse is replaced. If you lose the fuse cover, the plug must not be used until a replacement cover is obtained. A replacement fuse cover can be purchased from an Authorised Service Center.

**If the fitted moulded plug is unsuitable for the mains socket in your home, then the fuse should be removed and the plug cut off and disposed of safely. There is a danger of severe electrical shock if the cut off plug is inserted into any 13 amp socket.**

If a new plug is to be fitted, please observe the wiring code as shown below.  
If in any doubt, please consult a qualified electrician.

**WARNING:** THIS APPLIANCE MUST BE EARTHED.

**IMPORTANT:** The wires in this mains lead are coloured in accordance with the following code:

Green - and - Yellow:	Earth
Blue:	Neutral
Brown:	Live

As the colours of the wire in the mains lead of this appliance may not correspond with the coloured markings identifying the terminals in your plug, proceed as follows.

The wire which is coloured GREEN - AND - YELLOW must be connected to the terminal in the plug which is marked with the letter E or by the Earth symbol  $\perp$  or coloured GREEN or GREEN - AND - YELLOW.

The wire which is coloured BLUE must be connected to the terminal in the plug which is marked with the letter N or coloured BLACK.

The wire which is coloured BROWN must be connected to the terminal in the plug which is marked with the letter L or coloured RED.

How to replace the fuse: Open the fuse compartment with a screwdriver and replace the fuse.

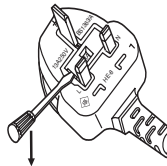

## Read this first!

### WARNING:

#### ■ POWER

**The wall outlet or the circuit breaker shall be installed near the equipment and shall be easily accessible when problems occur. If the following problems occur, cut off the power supply immediately.**

Continued use of the projector in these conditions will result in fire or electric shock.

- If foreign objects or water get inside the projector, cut off the power supply.
- If the projector is dropped or the cabinet is broken, cut off the power supply.
- If you notice smoke, strange smells or noise coming from the projector, cut off the power supply.

Please contact an Authorized Service Center for repairs, and do not attempt to repair the projector yourself.

**During a thunderstorm, do not touch the projector or the cable.**

Electric shocks can result.

**Do not do anything that might damage the power cord or the power plug.**

If the power cord is used while damaged, electric shocks, short-circuits or fire will result.

- Do not damage the power cord, make any modifications to it, place it near any hot objects, bend it excessively, twist it, pull it, place heavy objects on top of it or wrap it into a bundle.

Ask an Authorized Service Center to carry out any repairs to the power cord that might be necessary.

**Completely insert the power plug into the wall outlet and the power connector into the projector terminal.**

If the plug is not inserted correctly, electric shocks or overheating will result.

**Do not use anything other than the provided power cord.**

Failure to observe this will result in electric shocks.

- Do not use plugs which are damaged or wall outlets which are coming loose from the wall.

**Clean the power plug regularly to prevent it from becoming covered in dust.**

Failure to observe this will cause a fire.

- If dust builds up on the power plug, the resulting humidity can damage the insulation.
- If not using the projector for an extended period of time, pull the power plug out from the wall outlet.

Pull the power plug out from the wall outlet and wipe it with a dry cloth regularly.

**Do not handle the power plug with wet hands.**

Failure to observe this will result in electric shocks.

**Do not overload the wall outlet.**

If the power supply is overloaded (ex., by using too many adapters), overheating may occur and fire will result.

#### ■ ON USE/INSTALLATION

**Do not place the projector on soft materials such as carpets or sponge mats.**

Doing so will cause the projector to overheat, which can cause burns, fire or damage to the projector.

**Do not set up the projector in humid or dusty places or in places where the projector may come into contact with oily smoke or steam, ex. a bathroom.**

Using the projector under such conditions will result in fire, electric shocks or components deterioration.

Components deterioration (such as ceiling mount brackets) may cause the projector which is mounted on the ceiling to fall down.

**Do not install this projector in a place which is not strong enough to take the full weight of the projector or on top of a surface which is sloped or unstable.**

Failure to observe this will cause projector to fall down or tip over the projector, and severe injury or damage could result.

**Do not place another projector or other heavy objects on top of the projector.**

Failure to observe this will cause the projector to become unbalanced and fall, which could result in damage or injury. The projector will be damaged or deformed.

**WARNING:****Do not cover the air inlet port or the air outlet port.**

Doing so will cause the projector to overheat, which can cause fire or damage to the projector.

- Do not place the projector in narrow, badly ventilated places such as closets or bookshelves.
- Do not place the projector on cloth or papers, as these materials could be drawn into the air inlet port.

**Do not place your hands or other objects close to the air outlet port.**

Doing so will cause burns or damage your hands or other objects.

- Heated air comes out of the air outlet port. Do not place your hands or face, or objects which cannot withstand heat close to this port.

**Do not look and place your skin into the lights emitted from the lens while the projector is being used.**

Doing so can cause burns or loss of sight.

- Strong light is emitted from the projector's lens. Do not look or place your hands directly into this light.
- Be especially careful not to let young children look into the lens. In addition, turn off the power and disconnect the power plug when you are away from the projector.

**Never attempt to remodel or disassemble the projector.**

High voltages can cause fire or electric shocks.

- For any inspection, adjustment and repair work, please contact an Authorized Service Center.

**Do not project an image with the lens cover attached.**

Doing so can cause fire.

**Do not allow metal objects, flammable objects, or liquids to enter inside of the projector. Do not allow the projector to get wet.**

Doing so may cause short circuits or overheating, and result in fire, electric shock, or malfunction of the projector.

- Do not place containers of liquid or metal objects near the projector.
- If liquid enters inside of the projector, consult your dealer.
- Particular attention must be paid to children.

**Use the ceiling mount bracket specified by Panasonic.**

Defects in the ceiling mount bracket will result in falling accidents.

- Attach the supplied safety cable to the ceiling mount bracket to prevent the projector from falling down.

**Be sure to ask authorized personnel or your supplier when mounting the product to a ceiling.**

This requires an optional ceiling mount bracket.

Model No.: ET-PKD56H (for high ceilings), ET-PKD55S (for low ceilings)

**Installation work (such as ceiling mount bracket) should only be carried out by a qualified technician.**

If installation is not carried out and secured correctly it can cause injury or accidents, such as electric shocks.

- Do not use anything other than an authorized ceiling mount bracket.
- Be sure to use the provided accessory wire with an eye bolt as an extra safety measure to prevent the projector from falling down. (Install in a different location to the ceiling mount bracket)

## Read this first!

### WARNING:

#### ■ ACCESSORIES

**Do not use or handle the batteries improperly, and refer to the following.**

Failure to observe this will cause burns, batteries to leak, overheat, explode or catch fire.

- Do not use unspecified batteries.
- Do not disassemble dry cell batteries.
- Do not heat the batteries or place them into water or fire.
- Do not allow the + and – terminals of the batteries to come into contact with metallic objects such as necklaces or hairpins.
- Do not store batteries together with metallic objects.
- Store the batteries in a plastic bag and keep them away from metallic objects.
- Make sure the polarities (+ and –) are correct when inserting the batteries.
- Do not use a new battery together with an old battery or mix different types of batteries.
- Do not use batteries with the outer cover peeling away or removed.

**If the battery fluid leaks, do not touch it with bare hands, and take the following measures if necessary.**

- Battery fluid on your skin or clothing could result in skin inflammation or injury.  
Rinse with clean water and seek medical advice immediately.
- Battery fluid coming in contact with your eyes could result in loss of sight.  
In this case, do not rub your eyes. Rinse with clean water and seek medical advice immediately.

**Do not disassemble the lamp unit.**

If the lamp breaks, it could cause injury.

#### Lamp replacement

The lamp has high internal pressure. If improperly handled, an explosion and severe injury or accidents will result.

- The lamp can easily explode if struck against hard objects or dropped.
- Before replacing the lamp, be sure to disconnect the power plug from the wall outlet.  
Electric shocks or explosions can result if this is not done.
- When replacing the lamp, turn the power off and allow the lamp to cool for at least one hour before handling it otherwise it can cause burns.

**Do not allow infants or pets to touch the remote control unit.**

- Keep the remote control unit out of the reach of infants and pets after using it.

**Do not use the supplied power cord with devices other than this projector.**

- Using the supplied power cord with devices other than this projector may cause short circuits or overheating, and result in electric shock or fire.

**Remove the depleted batteries from the remote control promptly.**

- Leaving them in the unit may result in fluid leakage, overheating, or explosion of the batteries.

### CAUTION:

#### ■ POWER

**When disconnecting the power cord, be sure to hold the power plug and power connector.**

If the power cord itself is pulled, the lead will become damaged, and fire, short-circuits or serious electric shocks will result.

**When not using the projector for an extended period of time, disconnect the power plug from the wall outlet and remove the batteries from the remote control.**

**Disconnect the power plug from the wall outlet before carrying out any cleaning and replacing the unit.**

Electric shocks can result if this is not done.

**CAUTION:**

■ **ON USE/INSTALLATION**

**Do not put your weight on this projector.**

You could fall or the projector could break, and injury will result.

- Be especially careful not to let young children stand or sit on the projector.

**Do not place the projector in extremely hot locations.**

Doing so will cause the outer casing or internal components to deteriorate, or result in fire.

- Take particular care in locations exposed to direct sunlight or near stoves.

**Do not place your hands in the openings beside the optical lens, while shifting the lens.**

Failure to observe this could cause injury.

**Always disconnect all cables before moving the projector.**

Moving the projector with cables still attached can damage the cables, which will cause fire or electric shocks to occur.

■ **ACCESSORIES**

**Do not use the old lamp unit.**

If used it could cause lamp explosion.

**If the lamp has broken, ventilate the room immediately. Do not touch or bring your face close to the broken pieces.**

Failure to observe this will cause the user to absorb the gas which was released when the lamp broke and which contains nearly the same amount of mercury as fluorescent lamps, and the broken pieces will cause injury.

- If you believe that you have absorbed the gas or that the gas has got into your eyes or mouth, seek medical advice immediately.
- Ask your dealer about replacing the lamp unit and check the inside of the projector.

**Do not attach the air filter unit while it is wet.**

Doing so may result in electric shock or malfunctions.

- After you clean the air filter units, dry them thoroughly before reattaching them.



**To remove the battery**  
**Remote Control Battery**

**1. Press the guide and lift the cover.**

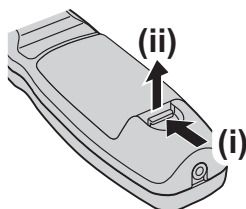

**2. Remove the batteries.**

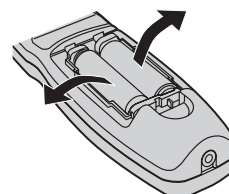

## **Trademarks**

- Microsoft® and its logos, Windows®, Windows® XP, Windows Vista®, Windows® 7, and Internet Explorer® are the registered trademarks or trademarks of Microsoft Corporation in the United States and/or other countries.
- Macintosh, Mac OS and Safari are the trademarks of Apple Inc. registered in the United States and other countries.
- PJLink™ is a trademark or pending trademark in Japan, the United States, and other countries and regions.
- HDMI, the HDMI logo and High-Definition Multimedia Interface are trademarks or registered trademarks of HDMI Licensing LLC.
- Other names, company names or product names used in these operating instructions are the trademarks or registered trademarks of their respective holders.

Please note that the operating instructions do not include the ® and TM symbols.

## **Illustrations in these operating instructions**

- Note that illustrations of the projector and screens may differ from the ones you actually see.

## **Page references**

- In these instructions, references to pages are indicated as: (➡ page 00).

## **Term**

- In these instructions, the “Wireless/wired remote control unit” accessories are referred to as the “Remote control”.



## Feature of the Projector

### High clarity and high color reproducibility

- ▶ The unique optical system and lamp boost control realizes high clarity and high color reproducibility.

### Easy setup and improved serviceability

- ▶ Extensive lineup of optional lenses allow more flexible setup of the projector.

### Improved cost performance in maintenance fee

- ▶ The new filter reduces the maintenance cost.

## Quick Steps

For details, see the corresponding pages.

1. **Set up your projector.**  
(➡ page 21)



2. **Attach the projection lens.**  
(➡ page 29)



3. **Connect with other devices.**  
(➡ page 30)



4. **Connect the power cord.**  
(➡ page 32)



5. **Power on.**  
(➡ page 34)



6. **Select the input signal.**  
(➡ page 36)



7. **Adjust the image.**  
(➡ page 36)

# Contents

Be sure to read "Read this first!". (➔ pages 2 to 8)

## Important Information

<b>Read this first!</b> .....	<b>2</b>
<b>Precautions for Use</b> .....	<b>12</b>
Cautions when transporting .....	12
Cautions when installing .....	12
Security .....	14
Disposal .....	14
Cautions on use .....	15
Accessories .....	16
Optional accessories .....	16

## Preparation

<b>About Your Projector</b> .....	<b>17</b>
Remote control.....	17
Projector body.....	18
<b>Using Remote control</b> .....	<b>20</b>
Inserting and removing the batteries .....	20
Setting Remote control ID numbers .....	20
Connecting to the projector with a cable .....	20

## Getting Started

<b>Setting up</b> .....	<b>21</b>
Projection method .....	21
Parts for ceiling mount (optional) .....	21
Screen size and throw distance .....	22
Adjustable feet .....	27
<b>Removing/attaching the projection lens...</b> <b>28</b>	
Removing the projection lens .....	28
Attaching the projection lens.....	29
<b>Connections</b> .....	<b>30</b>
Before connecting to the projector .....	30
Connecting example: AV equipment .....	31
Connecting example: Computers .....	31

## Basic Operation

<b>Powering ON/OFF</b> .....	<b>32</b>
Connecting the power cord.....	32
Power indicator .....	33
Powering up the projector .....	34
Making adjustment and selection.....	34
Powering off the projector .....	35
Direct power off function.....	35
<b>Projecting</b> .....	<b>36</b>
Selecting the input signal .....	36
Adjusting the focus, zoom, and shift .....	36
Moving the lens to the home position .....	36

Adjustment range by the lens position shift  
(optical shift) .....

<b>Basic operations using the remote control ...</b> <b>38</b>	
Using the SHUTTER function .....	38
Using the on-screen display function .....	38
Switching the input signal .....	38
Using the STATUS function .....	38
Using the automatic setup function .....	39
Using the FUNCTION button .....	39
Displaying the internal test pattern .....	39
Changing the picture aspect ratio .....	40

## Settings

<b>Menu Navigation</b> .....	<b>41</b>
Navigating through the menu .....	41
MAIN MENU.....	42
SUB MENU .....	42
<b>[PICTURE] menu</b> .....	<b>44</b>
[PICTURE MODE].....	44
[CONTRAST] .....	44
[BRIGHTNESS].....	44
[COLOR].....	45
[TINT].....	45
[COLOR TEMPERATURE].....	45
[WHITE GAIN].....	46
[SYSTEM DAYLIGHT VIEW].....	46
[SHARPNESS].....	46
[NOISE REDUCTION] .....	46
[AI] .....	47
[SYSTEM SELECTOR] .....	47
<b>[POSITION] menu</b> .....	<b>48</b>
[SHIFT] .....	48
[ASPECT] .....	48
[ZOOM].....	49
[CLOCK PHASE].....	50
[KEystone] .....	50
<b>[ADVANCED MENU] .....</b>	<b>51</b>
[DIGITAL CINEMA REALITY].....	51
[BLANKING].....	51
[INPUT RESOLUTION].....	52
[CLAMP POSITION].....	52
[EDGE BLENDING].....	52
[RASTER POSITION].....	53
<b>[DISPLAY LANGUAGE] menu .....</b>	<b>54</b>
Changing the display language.....	54
<b>[DISPLAY OPTION] menu .....</b>	<b>55</b>
[COLOR MATCHING].....	55
[COLOR CORRECTION].....	56
[CONTRAST MODE].....	56
[SCREEN SETTING].....	57

[AUTO SIGNAL] .....	57
[AUTO SETUP] .....	57
[DVI-D IN] .....	58
[ON-SCREEN DISPLAY] .....	58
[BACK COLOR] .....	59
[STARTUP LOGO] .....	60
[FREEZE] .....	60
[SIDE BY SIDE] (PT-DW730E only) .....	60
<b>[PROJECTOR SETUP] menu .....</b>	<b>61</b>
[PROJECTOR ID] .....	61
[PROJECTION METHOD] .....	61
[HIGH ALTITUDE MODE] .....	61
[COOLING CONDITION] .....	62
[LAMP SELECT] .....	62
[LAMP RELAY] .....	63
[LAMP POWER] .....	63
[STANDBY MODE] .....	63
[RS-232C] .....	63
[REMOTE2 MODE] .....	64
[STATUS] .....	64
[NO SIGNAL SHUT-OFF] .....	65
[FUNCTION BUTTON] .....	65
[DATE AND TIME] .....	65
[SAVE ALL USER DATA] .....	65
[LOAD ALL USER DATA] .....	66
[INITIALIZE] .....	66
[SERVICE PASSWORD] .....	66
<b>[TEST PATTERN] menu .....</b>	<b>67</b>
[TEST PATTERN] .....	67
<b>[SIGNAL LIST] menu .....</b>	<b>68</b>
Registering a signal to the list .....	68
Renaming the registered data .....	68
Deleting a registered data .....	68
Managing the sub memory list .....	69
<b>[SECURITY] menu .....</b>	<b>70</b>
[SECURITY PASSWORD] .....	70
[SECURITY PASSWORD CHANGE] .....	70
[DISPLAY SETTING] .....	70
[TEXT CHANGE] .....	71
[MENU LOCK] .....	71
[MENU LOCK PASSWORD] .....	71
[CONTROL DEVICE SETUP] .....	71
<b>[NETWORK] menu .....</b>	<b>73</b>
[NETWORK SETUP] .....	73
[NETWORK CONTROL] .....	73
[NETWORK STATUS] .....	73
Network connections .....	74
Accessing from the Web browser .....	75

## Maintenance

<b>LAMP/TEMP/FILTER Indicators .....</b>	<b>87</b>
Managing the indicated problems .....	87
<b>Maintenance/Replacement .....</b>	<b>89</b>
Before maintaining/replacing the unit .....	89
Maintenance .....	89
Replacing the unit .....	90
<b>Troubleshooting .....</b>	<b>93</b>

## Appendix

<b>Technical Information .....</b>	<b>95</b>
PJLink protocol .....	95
Control commands via LAN .....	96
Serial terminal .....	98
REMOTE 2 IN terminal .....	100
Two window display combination list (PT-DW730E only) .....	101
Menu lock password .....	101
List of compatible signals .....	102
<b>Specifications .....</b>	<b>104</b>
<b>Dimensions .....</b>	<b>106</b>
<b>Ceiling mount bracket safeguards .....</b>	<b>106</b>
<b>Index .....</b>	<b>107</b>

# Precautions for Use

## Cautions when transporting

- Projection lens is susceptible to effects due to vibration or impact. Make sure to remove the lens when transporting.
- When transporting the projector, hold it securely by its bottom and avoid excessive vibration and impacts. Doing so may damage the internal parts and result in malfunctions.
- Do not transport the projector with the adjustable feet extended. Doing so may damage the adjustable feet.

## Cautions when installing

### ■ After installing the projection lens, make sure to attach the projection lens cover.

- If the cover is not attached, dust will be accumulated inside and can cause a trouble.

### ■ Do not set up the projector outdoors.

- The projector is designed for indoor use only.

### ■ Do not use under the following conditions.

- Places where vibration and impacts occur such as in a car or vehicle: Doing so may damage the internal parts and result in malfunctions.
- Near the exhaust of an air conditioner: Depending on the conditions of use, the screen may fluctuate due to the hot air from the air exhaust port or the heated or cooled air from the air conditioner. Take care so that the exhaust from the projector or other equipment, or the air from the air conditioner does not blow toward the front of the projector.
- Near lights (studio lamps, etc.) where temperature changes greatly (Operating environment (➡ page 105)): Doing so may shorten the life of the lamp or result in deformation of the outer case and malfunctions.
- Near high-voltage power lines or near motors: Doing so may interfere with the operation of the projector.
- Place where there is a high-power laser equipment: It may cause malfunction in DLP chips when the laser beam enters the lens.

### ■ Be sure to ask a specialized technician when installing the product to a ceiling.

If the product is to be installed hanging from the ceiling, purchase an optional Ceiling Mount Attachment (For high ceilings: Model No. ET-PKD56H, For low ceilings: Model No. ET-PKD55S). Please call a specialized technician or contact an Authorized Service Center for installation.

### ■ Lens Focus

Do not adjust the lens focus in the initial period after switching the projector on. The high clarity projection lens is thermally affected by the light from the light source, making the focus unstable in the period just after switching on. Please allow a warm-up time of at least 30 minutes before adjusting the lens focus.

### ■ Make sure to set [HIGH ALTITUDE MODE] to [ON] when using the projector at elevations of 1 400 m (4 593 ft) or higher and lower than 2 700 m (8 858 ft) above sea level.

Failure to do so may shorten the life of the internal parts and result in malfunctions.

### ■ Make sure to set [HIGH ALTITUDE MODE] to [OFF] when using the projector at elevations lower than 1 400 m (4 593 ft) above sea level.

Failure to do so may shorten the life of the internal parts and result in malfunctions.

### ■ Do not install the projector at elevations of 2 700 m (8 858 ft) or higher above sea level.

Failure to do so may shorten the life of the internal parts and result in malfunctions.

## Do not use the projector tilted right or left.

Using the projector at a vertical angle that exceeds 15° may reduce product life or result in malfunction.

## When installing and using the projector at an angle that exceeds 30° vertically, set [COOLING CONDITION] (➔ page 62).

Failure to observe this will result in malfunctions or the lamp life or other components will be shortened.

## Cautions when setting the projectors

- When installing and using the projector with a method other than the floor standing installation using the adjustable feet, fix the projector using the five screw holes for ceiling mounting (shown in the figure). (Screw diameter: M6, tapping depth inside the set: 12 mm)
- Use the adjustable feet only for the floor standing installation and for adjusting the angle. If you use it other than this purpose, the set may be damaged.

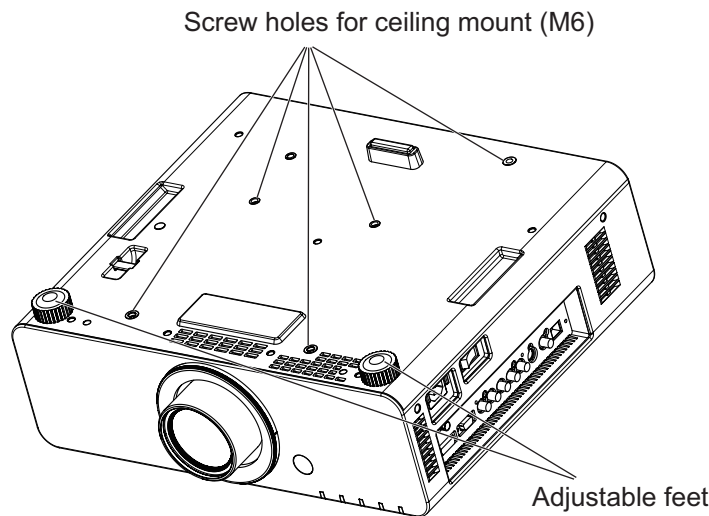

- Do not stack the projectors.
- Do not use the projector tilted at an angle that exceeds ±15° vertically.
- Do not block the ventilation ports (intake and exhaust) of the projector.
- Avoid heating and cooling air from the air conditioning system directly blow to the ventilation ports (intake and exhaust) of the projector.

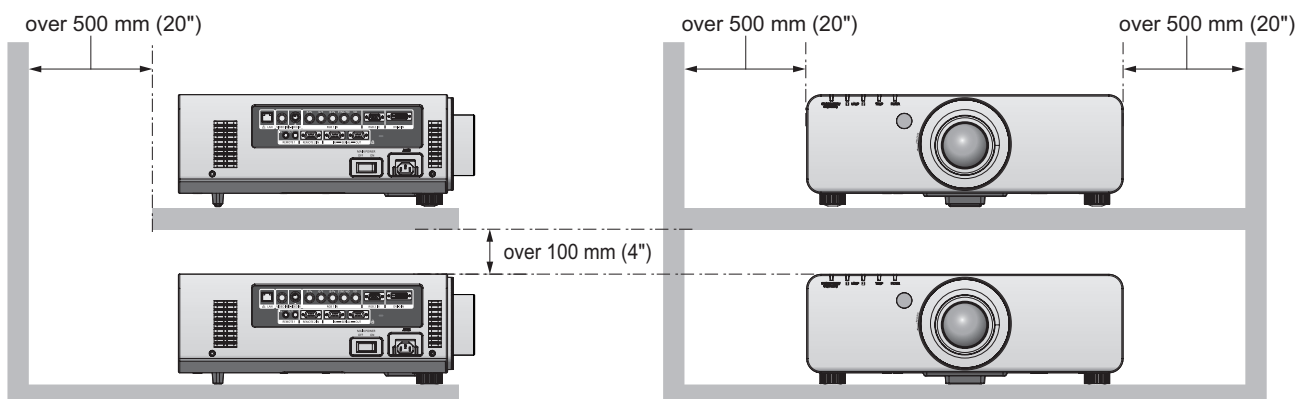
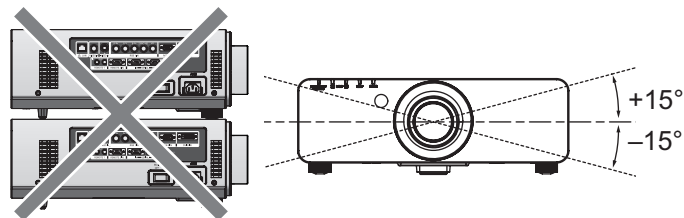

- Do not install the projector in a confined space. When it is necessary to install in a confined space, install the air conditioning or ventilating installation separately. Exhaust heat may accumulate when the ventilation is not enough, triggering the protection circuit of the projector.
- Make a clearance of at least 20 mm between the projector bottom and setting surface by inserting spacers (metallic) etc. between them.

## Precautions for Use

### Security

Take safety measures against following incidents.

- Personal information being leaked via this product
- Unauthorized operation of this product by a malicious third party
- Interfering or stopping of this product by a malicious third party

Take sufficient security measures. (➡ page 70)

- Make your password as difficult to guess as possible.
- Change your password periodically.
- Panasonic or its affiliate company never inquires a password directly to a customer. Do not tell your password in case you receive such an inquiry.
- The connecting network must be secured by firewall or others.
- Set a password and restrict the users who can log in.

### Disposal

To dispose of the product, inquire your local authorities or dealer for correct methods of disposal.

The lamp contains mercury. When disposing of used lamp units, contact your local authorities or dealer for correct methods of disposal.

## Cautions on use

### ■ In order to get the picture quality

Draw curtains or blinds over windows and turn off any lights near the screen to prevent outside light or light from indoor lamps from shining onto the screen.

### ■ Do not touch the surface of the projection lens with your bare hands.

If the surface of the lens becomes dirty from fingerprints or anything else, this will be magnified and projected onto the screen. Please put the lens cover (accessory) on the projector when you do not use it.

### ■ DLP chips

- The DLP chips are precision-made. Note that in rare cases, pixels of high precision could be missing or always lit, but this is not a malfunction.
- Directing a high power laser beam onto the lens surface can damage the DLP chip.

### ■ Do not move the projector while it is operating or subject it to vibration or impact.

The service life of its internal motor will be shortened.

### ■ Lamp

The luminous source of the projector is a mercury lamp with high internal pressure. A high pressure mercury lamp has following characteristics.

- The brightness of the lamp will decrease by duration of usage.
- The lamp may burst with sound or shorten life by shock or chipping.
- The life of the lamp varies greatly depending on individual specificities and usage conditions. In particular, continuous use over 22 hours and frequent on/off switching of the power greatly deteriorate the lamp and affect the lamp life.
- Lamp deterioration accelerates when used continuously for 22 hours or more. Lamp deterioration due to continuous use can be reduced by using the "LAMP RELAY" function (➡ page 63).
- In rare cases, the lamp burst shortly after the projection.
- The risk of bursting increases when the lamp is used beyond its replacement cycle. Make sure to replace the lamp unit consistently. ("When to replace the lamp unit" (➡ page 91), "Replacing the lamp unit" (➡ page 92))
- If the lamp bursts, gas contained inside of the lamp is released in a form of smoke.
- It is recommended to store replacement lamps for contingency.

<Software information regarding this product>

© Panasonic Corporation 2011

This product incorporates the following software:

(1)the software which is developed independently by or for Panasonic Corporation

(2)the software which is licensed under the GNU GENERAL PUBLIC LICENSE,

and

(3)the software which is licensed under the GNU LESSER GENERAL PUBLIC LICENSE.

For the software categorized as (2) and (3), the license is available in accordance with GNU GENERAL PUBLIC LICENSE and GNU LESSER GENERAL PUBLIC LICENSE respectively. As for the terms and conditions, please refer to the software licence of the supplied CD-ROM.

If you wish to ask any questions as to the software, please contact (sav.pj.gpl.pavc@ml.jp.panasonic.com) by email.

Pursuant to at the directive 2004/108/EC, article 9(2)

Panasonic Testing Centre

Panasonic Service Europe, a division of Panasonic Marketing Europe GmbH





Winsbergring 15, 22525 Hamburg, F.R. Germany

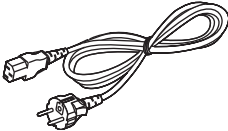
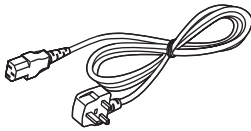

# Precautions for Use

## Accessories

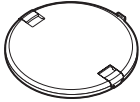
Make sure that the following accessories are provided with your projector. Numbers in the brackets ( ) show the number of accessories.

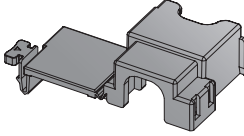
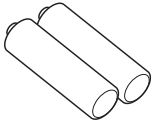
Wireless/wired remote control unit (x1) (N2QAYB000371)	Power cord (x1) (K2CM3FZ00003)	Power cord (x1) (K2CT3FZ00003)	Projection lens cover (x1) (TKPB35101)
			
Lens cover (x1) (TKKL5244)	CD-ROM (x1) (TXFQB02VKP8)	Power cord secure lock (x1) (TTRA0183)	AA/R6 battery (x2)
 (Only for the model with a lens)			 (For remote control unit)

### Attention

- After unpacking the projector, discard the power cord cap and packaging material properly.
- For lost accessories, consult your dealer.
- The part numbers of accessories and separately sold components are subject to change without notice.
- Store small parts in an appropriate manner, and keep them away from young children.

## Optional accessories

Optional accessories (product name)	Model No.
Projection lens	ET-DLE055 (fixed-focus lens), ET-DLE080 (ultra short-focus zoom lens), ET-DLE150 (short-focus zoom lens), ET-DLE250 (medium-focus zoom lens), ET-DLE350 (long-focus zoom lens), ET-DLE450 (ultra long-focus zoom lens)
Ceiling mount bracket	ET-PKD56H (for high ceilings), ET-PKD55S (for low ceilings)
Replacement lamp unit	ET-LAD60A (1 pc), ET-LAD60AW (2 pcs)
Replacement filter unit	ET-EMF300



# About Your Projector

## Remote control

### Top

Remote control signal emitters

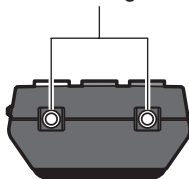

### Front

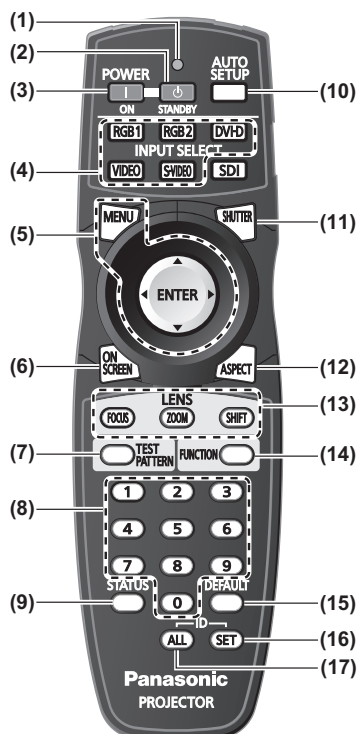

- (1) **Remote control indicator**  
Flashes by pressing any buttons.
- (2) **STANDBY ( ) button**  
Sets the projector to the standby mode when the <MAIN POWER> switch on the projector is set to <ON>.
- (3) **POWER ON ( | ) button**  
Starts projection when the <MAIN POWER> switch on the projector is set to <ON> and in the standby mode.
- (4) **Input Selection (<RGB1>, <RGB2>, <DVI-D>, <VIDEO>, and <S-VIDEO>) buttons**  
Switches the input signal to project. (➡ page 38)
- (5) **<MENU> button/<ENTER> button/ ▲▼◀▶ buttons**  
Use it to operate the menu screen. (➡ page 41)
- (6) **<ON SCREEN> button**  
Switches on (display)/off (not display) the on-screen display function. (➡ page 38)
- (7) **<TEST PATTERN> button**  
Displays the test pattern. (➡ page 39)
- (8) **Number (<0> - <9>) buttons**  
Use it when the system uses multiple projectors.  
Used to input the ID numbers or passwords.
- (9) **<STATUS> button**  
Displays the information of the projector.
- (10) **<AUTO SETUP> button**  
Automatically adjusts the image display position while projecting the image.  
[PROGRESS] is displayed on the screen while the image is adjusted automatically.  
(➡ page 39)
- (11) **<SHUTTER> button**  
Use it to temporarily turn off the image. (➡ page 38)
- (12) **<ASPECT> button**  
Switches the aspect ratio of the image. (➡ page 40)
- (13) **Lens (<FOCUS>, <ZOOM>, and <SHIFT>) buttons**  
Adjusts the projection lens. (➡ pages 34, 36)
- (14) **<FUNCTION> button**  
You can assign a frequently used operation and use as a shortcut button. (➡ page 39)
- (15) **<DEFAULT> button**  
Restores the contents of the sub-menu to the factory default setting. (➡ page 41)
- (16) **<ID SET> button**  
Sets the ID number of the remote control when the system uses multiple projectors.  
(➡ page 20)
- (17) **<ID ALL> button**  
Simultaneously controls all the projectors with one remote control when the system uses multiple projectors. (➡ page 20)

### Bottom

Remote control wired terminal  
(➡ page 20)

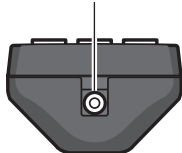

#### Attention

- Do not drop the remote control.
- Avoid contact with liquids or moisture.
- Do not attempt to modify or disassemble the remote control.

#### Note

- The <SDI> button cannot be used.
- The remote control can be used within a distance of about 30 m if pointed directly at the remote control receiver. The remote control can control at angles of up to  $\pm 15^\circ$  vertically and  $\pm 30^\circ$  horizontally, but the effective control range may be reduced.
- If there are any obstacles between the remote control and the remote control signal receptor, the remote control may not operate properly. The signal will be reflected off the screen, but the operating range may differ due to the screen material.
- If the remote control signal receptor receives strong light such as fluorescent light directly, the remote control may not operate properly. Use it in a place distant from the light source.

# About Your Projector

## Projector body

### Front

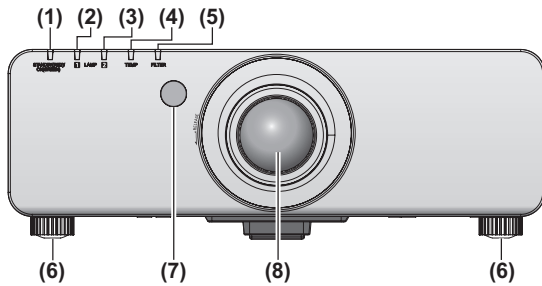

### Rear

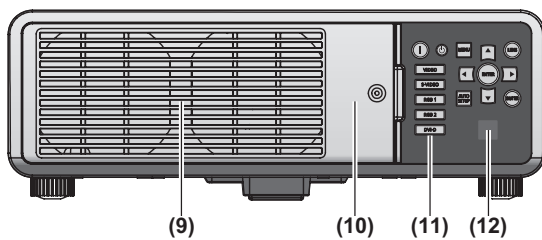

### Side

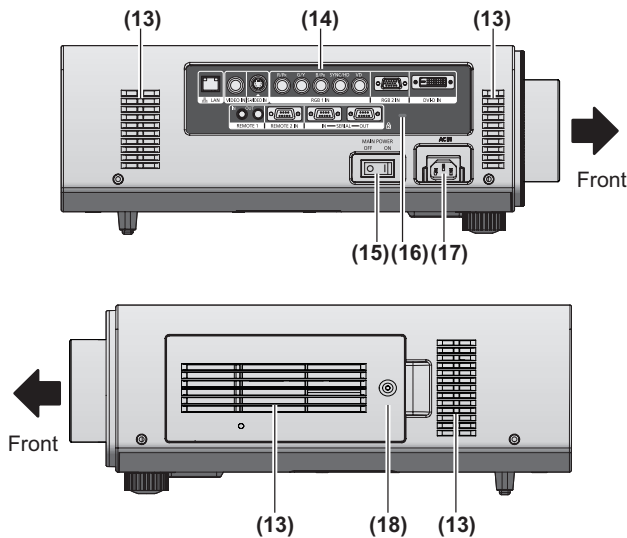

### Bottom

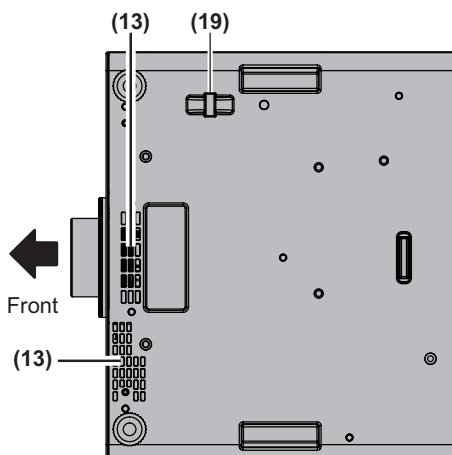

- (1) **Power indicator <STANDBY (RED)/ON (GREEN)>**  
Displays the status of the power.
- (2) **Lamp indicator <LAMP1>**  
Displays the status of the lamp 1.
- (3) **Lamp indicator <LAMP2>**  
Displays the status of the lamp 2.
- (4) **Temperature indicator <TEMP>**  
Displays the status of the internal temperature.
- (5) **Filter indicator <FILTER>**  
Displays the status of the air filter unit.
- (6) **Adjustable feet**  
Adjusts the projection angle.
- (7) **Remote control signal receiver (front)**
- (8) **Projection lens**  
(Only for the model with a lens)
- (9) **Air exhaust port**
- (10) **Lamp unit cover** (➔ page 92)
- (11) **Control panel** (➔ page 19)
- (12) **Remote control signal receiver (rear)**
- (13) **Air intake port**
- (14) **Terminals on side** (➔ page 19)
- (15) **<MAIN POWER> switch**  
Turns off/on the main power.
- (16) **Security slot**  
This security slot is compatible with the Kensington security cables.
- (17) **AC IN terminal <AC IN>**  
Connect the supplied power cord.
- (18) **Air filter cover**  
There is an air filter unit inside. (➔ page 89)
- (19) **Burglar hook port**  
Attach a commercial burglar prevention cable.

### Attention

- Keep your hands and other objects away from the air exhaust port.
    - Keep your hands and face away.
    - Do not insert your fingers.
    - Keep heat-sensitive articles away.
- Heated air from the air outlet port can cause burns, injury, or deformations.

## Control panel

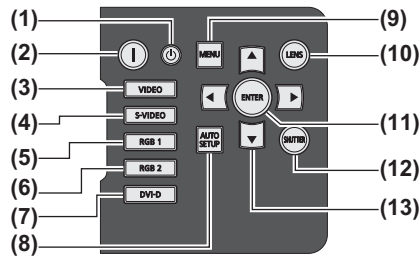

- (1) **STANDBY (⏻) button**  
Sets the projector to the standby mode when the <MAIN POWER> switch on the projector is set to <ON>.
- (2) **POWER ON (⏻) button**  
Starts projection when the <MAIN POWER> switch on the projector is set to <ON> and in the standby mode.
- (3) **<VIDEO> button**  
Switches to VIDEO input.
- (4) **<S-VIDEO> button**  
Switches to S-VIDEO input.
- (5) **<RGB1> button**  
Switches to RGB1 input.
- (6) **<RGB2> button**  
Switches to RGB2 input.
- (7) **<DVI-D> button**  
Switches to DVI-D input.
- (8) **<AUTO SETUP> button**  
Automatically adjusts the image display position while projecting the image.  
[PROGRESS] is displayed on the screen while the image is adjusted automatically. (➔ page 39)
- (9) **<MENU> button**  
Displays and clears the main menu, and returns to the previous menu when the menu is displayed. (➔ page 41)  
If you press the <MENU> button on the control panel for at least three seconds while the on-screen indication is off, the screen off state is canceled.
- (10) **<LENS> button**  
Adjusts the focus, zoom, and shift (position) of the lens.
- (11) **<ENTER> button**  
Press to activate a menu selection or to initiate a function.
- (12) **<SHUTTER> button**  
Use this button to temporarily turn off the image. (➔ page 38)
- (13) **▲▼◀▶ buttons**  
Use these buttons to select menu items, change settings, and adjust levels. It is also used to enter the [SECURITY] password.

## Terminals on side

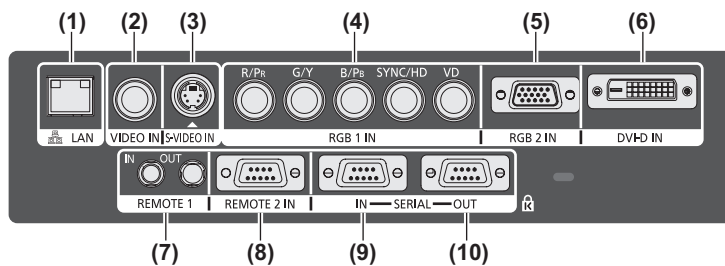

- (1) **LAN terminal <LAN>**  
This is a terminal to connect to the network.
- (2) **VIDEO input terminal <VIDEO IN>**  
This is a terminal to input the VIDEO signal.
- (3) **S-VIDEO input terminal <S-VIDEO IN>**  
This is a terminal to input the S-VIDEO signal.
- (4) **RGB (YP<sub>B</sub>P<sub>R</sub>) 1 input terminals <RGB 1 IN> (<R/P<sub>R</sub>>, <G/Y>, <B/P<sub>B</sub>>, <SYNC/HD>, and <VD>)**  
This is a terminal to input the RGB signal or the YP<sub>B</sub>P<sub>R</sub> signal.
- (5) **RGB2 input terminal <RGB 2 IN>**  
This is a terminal to input the RGB signal or the YP<sub>B</sub>P<sub>R</sub> signal.
- (6) **DVI-D input terminal <DVI-D IN>**  
This is a terminal to input the DVI-D signal.
- (7) **REMOTE 1 IN terminal <REMOTE 1 IN>/REMOTE 1 OUT terminal <REMOTE 1 OUT>**  
These are the terminals to connect the remote control for serial control when the system uses multiple projectors.
- (8) **REMOTE 2 IN terminal <REMOTE 2 IN>**  
This is a terminal to remotely control the projector using the external control circuit.
- (9) **SERIAL IN terminal <SERIAL IN>**  
This is a RS-232C compatible terminal to externally control the projector by connecting a computer.
- (10) **SERIAL OUT terminal <SERIAL OUT>**  
This is a terminal to output the signal connected to the SERIAL IN terminal.

### Attention

- Connect the LAN to the indoor equipment.

# Using Remote control

## Inserting and removing the batteries

### 1) Open the cover.

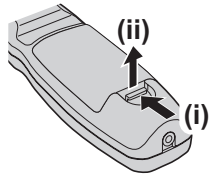

### 2) Insert the batteries and close the cover (insert the side first).

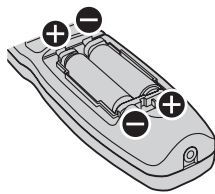

- When remove the batteries, perform the steps in the reverse order.

## Setting Remote control ID numbers

When you use the system with multiple projectors, you can operate all the projectors simultaneously or each projector individually using single remote control, if a unique ID number is assigned to each projector. After setting the ID number of the projector, set same ID number on the remote control.

**The ID number of the projector is set to [ALL] by the factory default. When using a single projector, press the <ID ALL> button on the remote control.**

### How to set

- 1) Press the <ID SET> button on the remote control.
- 2) Within five seconds, press the two-digit ID number set on the projector using the number (<0> - <9>) button.

#### Attention

- Since setting of the ID number on the remote control can be performed even without the projector, do not press the <ID SET> button carelessly. If the number (<0> - <9>) button is not pressed within five seconds after the <ID SET> button is pressed, the ID number returns to that before pressing the <ID SET> button.
- The ID number set on the remote control will be stored unless it is set again. However, it will be erased if the remote control is left with dead batteries. Set the same ID number again when the batteries are replaced.

#### Note

- Set the ID number of the projector from the [PROJECTOR SETUP] menu → [PROJECTOR ID] (➡ page 61).

## Connecting to the projector with a cable

When you use the system with multiple projectors, configure the units as in the following figure. Use a commercial M3 stereo mini jack cable and connect the other devices to the <REMOTE 1 IN>/<REMOTE 1 OUT> terminals of the projector.

It is effective to use the remote control in a place where an obstacle stands in the light path or where devices are susceptible to the outside light.

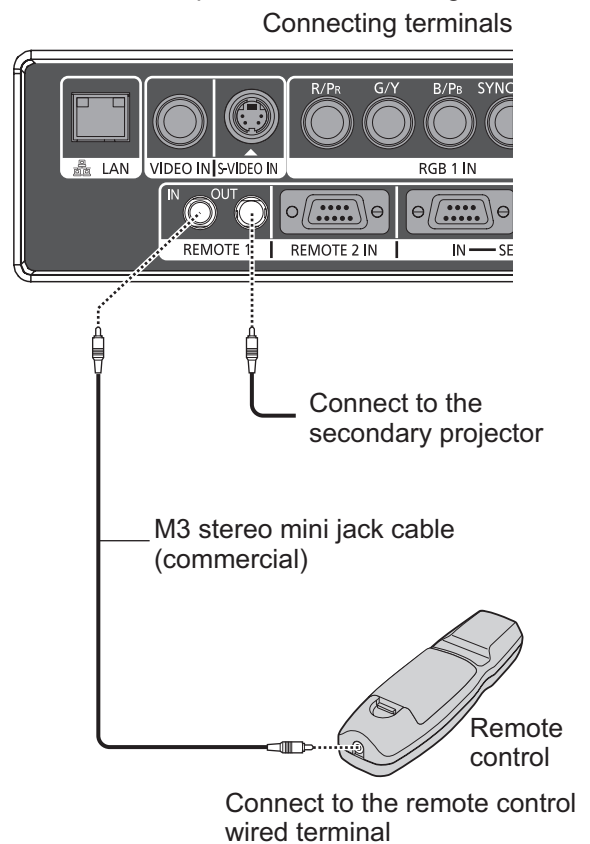

#### Attention

- Use a cable that is 15 m or shorter, with 2 core shield. The remote control may not operate when the length of the cable exceeds 15 m or when the shielding of the cable is inadequate.

# Setting up

## Projection method

You can use the projector with any of the following four projection methods. Select the appropriate method depending on the environment.

### ■ Mounting on the ceiling and projecting forward

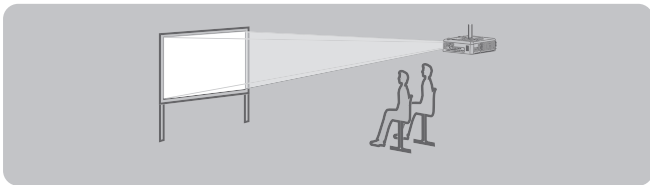

Menu item*1	Method
[PROJECTION METHOD]	[FRONT/CEILING]
[COOLING CONDITION]	[CEILING SETTING]

### ■ Setting on a desk/floor and projecting from rear

(Using the translucent screen)

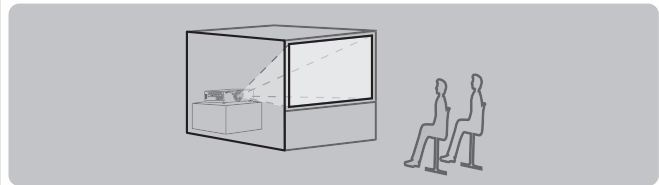

Menu item*1	Method
[PROJECTION METHOD]	[REAR/FLOOR]
[COOLING CONDITION]	[FLOOR SETTING]

### ■ Mounting on the ceiling and projecting from rear

(Using the translucent screen)

Menu item*1	Method
[PROJECTION METHOD]	[REAR/CEILING]
[COOLING CONDITION]	[CEILING SETTING]

### ■ Setting on a desk/floor and projecting forward

Menu item*1	Method
[PROJECTION METHOD]	[FRONT/FLOOR]
[COOLING CONDITION]	[FLOOR SETTING]

\*1: For details of the menu items, confirm from the [PROJECTOR SETUP] menu → [PROJECTION METHOD] (➔ page 61) and [COOLING CONDITION] (➔ page 62).

## Parts for ceiling mount (optional)

You can install the projector on the ceiling using the optional ceiling mount bracket (ET-PKD56H: for high ceilings, ET-PKD55S: for low ceilings).

- Use only the ceiling mount brackets specified for this projector.
- Refer to the installation manual for the ceiling mount bracket when you install the bracket and the projector.

### Attention

- To ensure the projector performance and security, installation of the ceiling mount bracket must be carried out by your dealer or a qualified technician.

## Setting up

### Screen size and throw distance

Install the projector referring to the following figures and table describing projection distances. Image size and image position can be adjusted in accordance with the screen size and screen position.

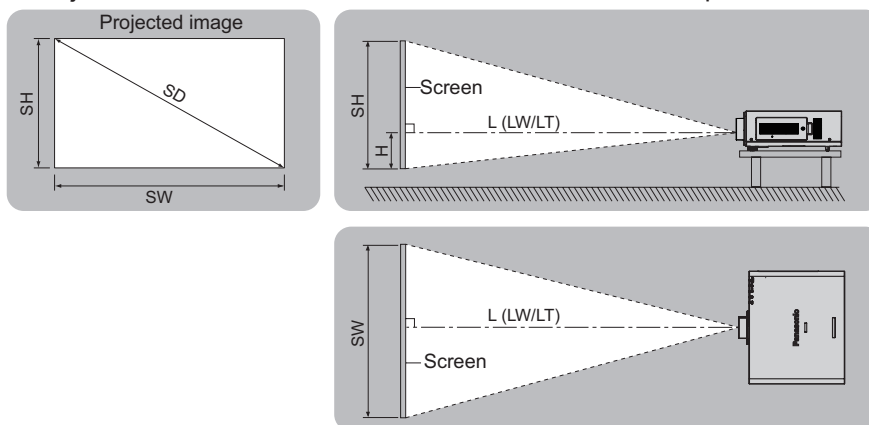

$L (LW/LT)^{*1}$	Projection distance (m)
SH	Image height (m)
SW	Image width (m)
H	Distance from the center of lens to the image lower end (m)
SD	Image diagonal size (m)

\*1: LW: Minimum projection distance when the zoom lens is used  
LT: Maximum projection distance when the zoom lens is used

#### Attention

- Read "Precautions for Use" (➔ pages 12 to 16) before installation.
- Do not use the projector and the high-powered laser equipment in the same room.  
Hitting of a laser beam on to the lens can damage the DLP chips.

## ■ Projection distance per projection lens (for PT-DW730E)

● When the screen aspect ratio is 16:10 (unit: m)

(All measurements below are approximate and may differ slightly from the actual measurements.)

Lens type			Standard zoom lens	Optional lens												Height position (H) <sup>2</sup>
				Fixed-focus lens	Ultra short-focus zoom lens	Short-focus zoom lens	Medium-focus zoom lens	Long-focus zoom lens	Ultra long-focus zoom lens							
Projection lens Model No.			–	ET-DLE055	ET-DLE080	ET-DLE150	ET-DLE250	ET-DLE350	ET-DLE450							
Throw ratio <sup>*1</sup>			1.8–2.5:1	0.8:1	0.8–1.0:1	1.4–2.0:1	2.4–3.8:1	3.8–5.7:1	5.6–9.0:1							
Projection size			Projection distance (L)													
Screen size (SD)	Height (SH)	Width (SW)	Min.	Max.	Fixed	Min.	Max.	Min.	Max.	Min.	Max.	Min.	Max.	Min.	Max.	
1.27 (50")	0.673	1.077	1.91	2.70	0.87	0.87	1.09	1.45	2.12	2.54	4.06	4.00	6.11	5.96	9.60	-0.07–0.34
1.52 (60")	0.808	1.292	2.31	3.26	1.06	1.05	1.32	1.75	2.55	3.07	4.89	4.83	7.36	7.21	11.57	-0.08–0.40
1.78 (70")	0.942	1.508	2.71	3.81	1.24	1.24	1.54	2.05	2.98	3.59	5.72	5.65	8.61	8.46	13.55	-0.09–0.47
2.03 (80")	1.077	1.723	3.11	4.37	1.42	1.42	1.77	2.35	3.42	4.12	6.55	6.48	9.86	9.71	15.53	-0.11–0.54
2.29 (90")	1.212	1.939	3.50	4.92	1.61	1.60	2.00	2.65	3.85	4.64	7.38	7.31	11.11	10.96	17.51	-0.12–0.61
2.54 (100")	1.346	2.154	3.90	5.48	1.79	1.78	2.22	2.95	4.28	5.17	8.20	8.13	12.36	12.22	19.49	-0.14–0.67
3.05 (120")	1.615	2.585	4.70	6.59	2.16	2.15	2.68	3.55	5.15	6.21	9.86	9.79	14.86	14.72	23.45	-0.16–0.81
3.81 (150")	2.019	3.231	5.89	8.25	2.71	2.70	3.36	4.45	6.45	7.79	12.35	12.27	18.61	18.47	29.38	-0.20–1.01
5.08 (200")	2.692	4.308	7.88	11.03	3.63	3.62	4.49	5.95	8.61	10.41	16.49	16.40	24.85	24.73	39.28	-0.27–1.35
6.35 (250")	3.365	5.385	9.86	13.81	–	4.53	5.62	7.45	10.78	13.03	20.63	20.53	31.10	30.99	49.17	-0.34–1.68
7.62 (300")	4.039	6.462	11.85	16.58	–	5.45	6.76	8.96	12.95	15.65	24.77	24.67	37.35	37.25	59.06	-0.40–2.02
8.89 (350")	4.712	7.539	13.84	19.36	–	6.36	7.89	10.46	15.11	18.28	28.91	28.80	43.59	43.51	68.96	-0.47–2.36
10.16 (400")	5.385	8.616	15.83	22.13	–	7.28	9.02	11.96	17.28	20.90	33.06	32.94	49.84	49.76	78.85	-0.54–2.69
12.70 (500")	6.731	10.770	19.80	27.68	–	9.11	11.29	14.96	21.61	26.14	41.34	41.20	62.33	62.28	98.64	-0.67–3.37
15.24 (600")	8.077	12.923	23.78	33.23	–	10.94	13.56	17.96	25.94	31.39	49.62	49.47	74.82	74.80	118.43	-0.81–4.04

\*1: The throw ratio is based on the value during projection onto a 2.03-m (80") screen size.

\*2: When the fixed-focus lens (ET-DLE055) is attached, the lens shift cannot be used, so the height position (H) will be SH/2.

● When the screen aspect ratio is 16:9 (unit: m)

(All measurements below are approximate and may differ slightly from the actual measurements.)

Lens type			Standard zoom lens	Optional lens												Height position (H) <sup>2</sup>
				Fixed-focus lens	Ultra short-focus zoom lens	Short-focus zoom lens	Medium-focus zoom lens	Long-focus zoom lens	Ultra long-focus zoom lens							
Projection lens Model No.			–	ET-DLE055	ET-DLE080	ET-DLE150	ET-DLE250	ET-DLE350	ET-DLE450							
Throw ratio <sup>*1</sup>			1.8–2.5:1	0.8:1	0.8–1.0:1	1.4–2.0:1	2.4–3.8:1	3.8–5.7:1	5.6–9.0:1							
Projection size			Projection distance (L)													
Screen size (SD)	Height (SH)	Width (SW)	Min.	Max.	Fixed	Min.	Max.	Min.	Max.	Min.	Max.	Min.	Max.	Min.	Max.	
1.27 (50")	0.623	1.107	1.97	2.78	0.90	0.89	1.12	1.49	2.18	2.62	4.18	4.11	6.29	6.13	9.87	-0.14–0.31
1.52 (60")	0.747	1.328	2.38	3.35	1.09	1.08	1.35	1.80	2.62	3.15	5.03	4.96	7.57	7.42	11.90	-0.16–0.37
1.78 (70")	0.872	1.550	2.79	3.92	1.28	1.27	1.59	2.11	3.07	3.69	5.88	5.81	8.85	8.70	13.94	-0.19–0.44
2.03 (80")	0.996	1.771	3.19	4.49	1.46	1.46	1.82	2.42	3.51	4.23	6.73	6.66	10.14	9.99	15.97	-0.22–0.50
2.29 (90")	1.121	1.992	3.60	5.06	1.65	1.65	2.05	2.72	3.96	4.77	7.58	7.51	11.42	11.28	18.01	-0.25–0.56
2.54 (100")	1.245	2.214	4.01	5.63	1.84	1.84	2.29	3.03	4.40	5.31	8.44	8.36	12.71	12.56	20.04	-0.27–0.62
3.05 (120")	1.494	2.657	4.83	6.77	2.22	2.21	2.75	3.65	5.29	6.39	10.14	10.06	15.27	15.14	24.11	-0.33–0.75
3.81 (150")	1.868	3.321	6.05	8.49	2.79	2.78	3.45	4.58	6.63	8.01	12.69	12.61	19.13	19.00	30.21	-0.41–0.93
5.08 (200")	2.491	4.428	8.10	11.34	3.73	3.72	4.62	6.12	8.86	10.70	16.95	16.86	25.55	25.43	40.38	-0.55–1.25
6.35 (250")	3.113	5.535	10.14	14.19	–	4.66	5.78	7.66	11.08	13.40	21.21	21.11	31.97	31.86	50.54	-0.69–1.56
7.62 (300")	3.736	6.641	12.18	17.04	–	5.60	6.94	9.21	13.31	16.09	25.46	25.36	38.39	38.29	60.71	-0.82–1.87
8.89 (350")	4.358	7.748	14.23	19.90	–	6.54	8.11	10.75	15.53	18.79	29.72	29.61	44.81	44.72	70.88	-0.96–2.18
10.16 (400")	4.981	8.855	16.27	22.75	–	7.48	9.27	12.29	17.76	21.48	33.98	33.86	51.23	51.16	81.05	-1.10–2.49
12.70 (500")	6.226	11.069	20.36	28.46	–	9.36	11.60	15.38	22.21	26.87	42.49	42.35	64.07	64.02	101.39	-1.37–3.11
15.24 (600")	7.472	13.283	24.44	34.16	–	11.24	13.93	18.46	26.67	32.26	51.00	50.85	76.91	76.89	121.73	-1.64–3.74

\*1: The throw ratio is based on the value during projection onto a 2.03-m (80") screen size.

\*2: When the fixed-focus lens (ET-DLE055) is attached, the lens shift cannot be used, so the height position (H) will be SH/2.



# Setting up

- When the screen aspect ratio is 4:3 (unit: m)  
(All measurements below are approximate and may differ slightly from the actual measurements.)

Lens type			Standard zoom lens		Optional lens								Height position (H) <sup>2</sup>				
					Fixed-focus lens	Ultra short-focus zoom lens	Short-focus zoom lens	Medium-focus zoom lens	Long-focus zoom lens	Ultra long-focus zoom lens							
Projection lens Model No.			-		ET-DLE055	ET-DLE080	ET-DLE150	ET-DLE250	ET-DLE350	ET-DLE450							
Throw ratio <sup>*1</sup>			2.2-3.0:1		1.0:1	1.0-1.2:1	1.6-2.4:1	2.9-4.6:1	4.5-6.9:1	6.8-10.8:1							
Projection size			Projection distance (L)														
Screen size (SD)	Height (SH)	Width (SW)	Min.	Max.	Fixed	Min.	Max.	Min.	Max.	Min.	Max.	Min.		Max.	Min.	Max.	
1.27 (50")	0.762	1.016	2.18	3.07	0.99	0.99	1.24	1.65	2.40	2.89	4.61	4.54		6.94	6.78	10.90	-0.08-0.38
1.52 (60")	0.914	1.219	2.63	3.70	1.20	1.20	1.50	1.99	2.89	3.48	5.55	5.48		8.35	8.20	13.14	-0.09-0.46
1.78 (70")	1.067	1.422	3.08	4.33	1.41	1.40	1.75	2.33	3.38	4.08	6.48	6.42		9.76	9.62	15.38	-0.11-0.53
2.03 (80")	1.219	1.626	3.53	4.95	1.62	1.61	2.01	2.67	3.87	4.67	7.42	7.35		11.18	11.03	17.62	-0.12-0.61
2.29 (90")	1.372	1.829	3.98	5.58	1.83	1.82	2.27	3.01	4.36	5.26	8.36	8.29	12.59	12.45	19.86	-0.14-0.69	
2.54 (100")	1.524	2.032	4.43	6.21	2.03	2.03	2.52	3.35	4.85	5.86	9.30	9.22	14.01	13.87	22.10	-0.15-0.76	
3.05 (120")	1.829	2.438	5.33	7.47	2.45	2.44	3.03	4.03	5.83	7.04	11.17	11.09	16.83	16.70	26.58	-0.18-0.91	
3.81 (150")	2.286	3.048	6.68	9.35	3.07	3.06	3.80	5.04	7.31	8.82	13.98	13.90	21.08	20.95	33.30	-0.23-1.14	
5.08 (200")	3.048	4.064	8.92	12.49	4.11	4.10	5.09	6.74	9.76	11.79	18.67	18.58	28.15	28.03	44.49	-0.31-1.52	
6.35 (250")	3.810	5.080	11.17	15.64	-	5.13	6.37	8.44	12.21	14.76	23.36	23.26	35.22	35.12	55.69	-0.38-1.91	
7.62 (300")	4.572	6.096	13.42	18.78	-	6.17	7.65	10.14	14.66	17.73	28.05	27.94	42.29	42.20	66.89	-0.46-2.29	
8.89 (350")	5.334	7.112	15.67	21.92	-	7.21	8.94	11.84	17.11	20.70	32.74	32.62	49.36	49.28	78.09	-0.53-2.67	
10.16 (400")	6.096	8.128	17.92	25.06	-	8.24	10.22	13.54	19.56	23.67	37.42	37.30	56.43	56.37	89.29	-0.61-3.05	
12.70 (500")	7.620	10.160	22.42	31.34	-	10.32	12.78	16.94	24.47	29.60	46.80	46.65	70.57	70.53	111.68	-0.76-3.81	
15.24 (600")	9.144	12.192	26.92	37.63	-	12.39	15.35	20.34	29.37	35.54	56.18	56.01	84.71	84.70	134.08	-0.91-4.57	

\*1: The throw ratio is based on the value during projection onto a 2.03-m (80") screen size.

\*2: When the fixed-focus lens (ET-DLE055) is attached, the lens shift cannot be used, so the height position (H) will be SH/2.



## ■ Projection distance per projection lens (for PT-DX800E)

● When the screen aspect ratio is 4:3 (unit: m)

(All measurements below are approximate and may differ slightly from the actual measurements.)

Lens type			Standard zoom lens	Optional lens												Height position (H) <sup>*2</sup>			
				Fixed-focus lens	Ultra short-focus zoom lens	Short-focus zoom lens	Medium-focus zoom lens	Long-focus zoom lens	Ultra long-focus zoom lens										
Projection lens Model No.			–	ET-DLE055	ET-DLE080	ET-DLE150	ET-DLE250	ET-DLE350	ET-DLE450									Standard zoom lens/ ET-DLE150/ ET-DLE250/ ET-DLE350/ ET-DLE450	ET-DLE080
Throw ratio <sup>*1</sup>			2.2–3.0:1	1.0:1	1.0–1.2:1	1.6–2.4:1	2.9–4.6:1	4.5–6.9:1	6.8–10.8:1										
Projection size			Projection distance (L)																
Screen size (SD)	Height (SH)	Width (SW)	Min.	Max.	Fixed	Min.	Max.	Min.	Max.	Min.	Max.	Min.	Max.	Min.	Max.	Min.	Max.		
1.27 (50")	0.762	1.016	1.78	2.51	0.81	0.81	1.01	1.34	1.97	2.36	3.78	3.71	5.68	5.53	8.91	0–0.38	0.08–0.38		
1.52 (60")	0.914	1.219	2.15	3.03	0.98	0.98	1.22	1.62	2.37	2.85	4.55	4.48	6.84	6.69	10.75	0–0.46	0.09–0.46		
1.78 (70")	1.067	1.422	2.52	3.55	1.15	1.15	1.43	1.90	2.77	3.34	5.32	5.25	8.01	7.86	12.60	0–0.53	0.11–0.53		
2.03 (80")	1.219	1.626	2.90	4.06	1.32	1.32	1.64	2.18	3.18	3.83	6.09	6.02	9.17	9.02	14.44	0–0.61	0.12–0.61		
2.29 (90")	1.372	1.829	3.26	4.58	1.49	1.49	1.86	2.46	3.58	4.32	6.86	6.79	10.33	10.19	16.28	0–0.69	0.14–0.69		
2.54 (100")	1.524	2.032	3.63	5.10	1.66	1.66	2.07	2.74	3.98	4.80	7.63	7.56	11.50	11.35	18.12	0–0.76	0.15–0.76		
3.05 (120")	1.829	2.438	4.37	6.13	2.01	2.00	2.49	3.30	4.79	5.78	9.18	9.10	13.82	13.68	21.81	0–0.91	0.18–0.91		
3.81 (150")	2.286	3.048	5.48	7.68	2.52	2.51	3.12	4.14	6.00	7.24	11.49	11.41	17.31	17.18	27.33	0–1.14	0.23–1.14		
5.08 (200")	3.048	4.064	7.33	10.16	3.38	3.36	4.18	5.54	8.02	9.69	15.34	15.26	23.13	23.00	36.54	0–1.52	0.31–1.52		
6.35 (250")	3.810	5.080	9.18	12.85	–	4.21	5.23	6.94	10.03	12.13	19.20	19.11	28.94	28.83	45.76	0–1.91	0.38–1.91		
7.62 (300")	4.572	6.096	11.03	15.43	–	5.07	6.29	8.33	12.05	14.57	23.06	22.96	34.76	34.66	54.97	0–2.29	0.46–2.29		
8.89 (350")	5.334	7.112	12.88	18.02	–	5.92	7.34	9.73	14.07	17.01	26.91	26.81	40.57	40.48	64.18	0–2.67	0.53–2.67		
10.16 (400")	6.096	8.128	14.73	20.60	–	6.77	8.40	11.13	16.08	19.45	30.77	30.65	46.39	46.31	73.39	0–3.05	0.61–3.05		
12.70 (500")	7.620	10.160	18.43	25.77	–	8.48	10.51	13.92	20.12	24.33	38.48	38.35	58.02	57.96	91.81	0–3.81	0.76–3.81		
15.24 (600")	9.144	12.192	22.13	30.94	–	10.18	12.62	16.72	24.15	29.22	46.19	46.05	69.65	69.61	110.23	0–4.57	0.91–4.57		

\*1: The throw ratio is based on the value during projection onto a 2.03-m (80") screen size.

\*2: When the fixed-focus lens (ET-DLE055) is attached, the lens shift cannot be used, so the height position (H) will be SH/2.

● When the screen aspect ratio is 16:9 (unit: m)

(All measurements below are approximate and may differ slightly from the actual measurements.)

Lens type			Standard zoom lens	Optional lens												Height position (H) <sup>*2</sup>			
				Fixed-focus lens	Ultra short-focus zoom lens	Short-focus zoom lens	Medium-focus zoom lens	Long-focus zoom lens	Ultra long-focus zoom lens										
Projection lens Model No.			–	ET-DLE055	ET-DLE080	ET-DLE150	ET-DLE250	ET-DLE350	ET-DLE450									Standard zoom lens/ ET-DLE150/ ET-DLE250/ ET-DLE350/ ET-DLE450	ET-DLE080
Throw ratio <sup>*1</sup>			1.8–2.5:1	0.8:1	0.8–1.0:1	1.3–2.0:1	2.4–3.8:1	3.7–5.6:1	5.6–8.9:1										
Projection size			Projection distance (L)																
Screen size (SD)	Height (SH)	Width (SW)	Min.	Max.	Fixed	Min.	Max.	Min.	Max.	Min.	Max.	Min.	Max.	Min.	Max.	Min.	Max.		
1.27 (50")	0.623	1.107	1.94	2.74	0.89	0.88	1.11	1.47	2.15	2.58	4.12	4.06	6.20	6.05	9.74	-0.21–0.31	-0.16–0.31		
1.52 (60")	0.747	1.328	2.35	3.31	1.07	1.07	1.34	1.77	2.59	3.11	4.96	4.90	7.47	7.32	11.74	-0.25–0.37	-0.19–0.37		
1.78 (70")	0.872	1.550	2.75	3.87	1.26	1.25	1.57	2.08	3.03	3.64	5.80	5.74	8.74	8.59	13.75	-0.29–0.44	-0.23–0.44		
2.03 (80")	0.996	1.771	3.15	4.43	1.44	1.44	1.80	2.38	3.47	4.18	6.64	6.57	10.00	9.85	15.76	-0.33–0.50	-0.26–0.50		
2.29 (90")	1.121	1.992	3.55	5.00	1.63	1.62	2.03	2.69	3.91	4.71	7.48	7.41	11.27	11.12	17.76	-0.37–0.56	-0.29–0.56		
2.54 (100")	1.245	2.214	3.96	5.56	1.82	1.81	2.26	2.99	4.34	5.24	8.32	8.25	12.54	12.39	19.77	-0.41–0.62	-0.32–0.62		
3.05 (120")	1.494	2.657	4.76	6.68	2.19	2.18	2.71	3.60	5.22	6.30	10.00	9.93	15.07	14.93	23.79	-0.49–0.75	-0.39–0.75		
3.81 (150")	1.868	3.321	5.97	8.37	2.75	2.74	3.40	4.52	6.54	7.90	12.52	12.44	18.87	18.74	29.81	-0.62–0.93	-0.49–0.93		
5.08 (200")	2.491	4.428	7.99	11.19	3.68	3.67	4.55	6.04	8.74	10.56	16.72	16.64	25.21	25.09	39.84	-0.82–1.25	-0.65–1.25		
6.35 (250")	3.113	5.535	10.01	14.00	–	4.60	5.70	7.56	10.94	13.22	20.93	20.83	31.54	31.44	49.88	-1.03–1.56	-0.81–1.56		
7.62 (300")	3.736	6.641	12.02	16.82	–	5.52	6.85	9.08	13.13	15.88	25.13	25.02	37.88	37.78	59.91	-1.23–1.87	-0.97–1.87		
8.89 (350")	4.358	7.748	14.04	19.63	–	6.45	8.00	10.61	15.33	18.54	29.33	29.22	44.22	44.13	69.95	-1.44–2.18	-1.13–2.18		
10.16 (400")	4.981	8.855	16.05	22.45	–	7.38	9.15	12.13	17.53	21.20	33.53	33.41	50.55	50.48	79.98	-1.64–2.49	-1.30–2.49		
12.70 (500")	6.226	11.069	20.09	28.08	–	9.24	11.45	15.18	21.92	26.52	41.93	41.79	63.22	63.17	100.05	-2.06–3.11	-1.62–3.11		
15.24 (600")	7.472	13.283	24.12	33.71	–	11.10	13.75	18.22	26.31	31.84	50.33	50.18	75.89	75.87	120.12	-2.47–3.74	-1.94–3.74		

\*1: The throw ratio is based on the value during projection onto a 2.03-m (80") screen size.

\*2: When the fixed-focus lens (ET-DLE055) is attached, the lens shift cannot be used, so the height position (H) will be SH/2.

## ■ Projection distance calculation formula per projection lens (for PT-DW730E)

Lens type		Aspect ratio	Projection distance (L) formula	
Standard zoom lens	-	16:10	Min. (LW)	$L = 1.5669 \times SD (m) - 0.0746$
			Max. (LT)	$L = 2.1850 \times SD (m) - 0.0725$
		16:9	Min. (LW)	$L = 1.6102 \times SD (m) - 0.0746$
			Max. (LT)	$L = 2.2480 \times SD (m) - 0.0725$
		4:3	Min. (LW)	$L = 1.7717 \times SD (m) - 0.0746$
			Max. (LT)	$L = 2.4724 \times SD (m) - 0.0725$
Fixed-focus lens	Model No.: ET-DLE055	16:10	-	$L = 0.7244 \times SD (m) - 0.0476$
		16:9	-	$L = 0.7441 \times SD (m) - 0.0476$
		4:3	-	$L = 0.8189 \times SD (m) - 0.0476$
Ultra short-focus zoom lens	Model No.: ET-DLE080	16:10	Min. (LW)	$L = 0.7205 \times SD (m) - 0.0471$
			Max. (LT)	$L = 0.8937 \times SD (m) - 0.0442$
		16:9	Min. (LW)	$L = 0.7402 \times SD (m) - 0.0471$
			Max. (LT)	$L = 0.9173 \times SD (m) - 0.0442$
		4:3	Min. (LW)	$L = 0.8150 \times SD (m) - 0.0471$
			Max. (LT)	$L = 1.0118 \times SD (m) - 0.0442$
Short-focus zoom lens	Model No.: ET-DLE150	16:10	Min. (LW)	$L = 1.1811 \times SD (m) - 0.0540$
			Max. (LT)	$L = 1.7047 \times SD (m) - 0.0498$
		16:9	Min. (LW)	$L = 1.2165 \times SD (m) - 0.0540$
			Max. (LT)	$L = 1.7520 \times SD (m) - 0.0498$
		4:3	Min. (LW)	$L = 1.3386 \times SD (m) - 0.0540$
			Max. (LT)	$L = 1.9291 \times SD (m) - 0.0498$
Medium-focus zoom lens	Model No.: ET-DLE250	16:10	Min. (LW)	$L = 2.0630 \times SD (m) - 0.0800$
			Max. (LT)	$L = 3.2598 \times SD (m) - 0.0792$
		16:9	Min. (LW)	$L = 2.1220 \times SD (m) - 0.0800$
			Max. (LT)	$L = 3.3504 \times SD (m) - 0.0792$
		4:3	Min. (LW)	$L = 2.3386 \times SD (m) - 0.0800$
			Max. (LT)	$L = 3.6929 \times SD (m) - 0.0792$
Long-focus zoom lens	Model No.: ET-DLE350	16:10	Min. (LW)	$L = 3.2559 \times SD (m) - 0.1351$
			Max. (LT)	$L = 4.9173 \times SD (m) - 0.1346$
		16:9	Min. (LW)	$L = 3.3465 \times SD (m) - 0.1351$
			Max. (LT)	$L = 5.0551 \times SD (m) - 0.1346$
		4:3	Min. (LW)	$L = 3.6850 \times SD (m) - 0.1351$
			Max. (LT)	$L = 5.5669 \times SD (m) - 0.1346$
Ultra long-focus zoom lens	Model No.: ET-DLE450	16:10	Min. (LW)	$L = 4.9291 \times SD (m) - 0.3017$
			Max. (LT)	$L = 7.7913 \times SD (m) - 0.2991$
		16:9	Min. (LW)	$L = 5.0630 \times SD (m) - 0.3017$
			Max. (LT)	$L = 8.0079 \times SD (m) - 0.2991$
		4:3	Min. (LW)	$L = 5.5787 \times SD (m) - 0.3017$
			Max. (LT)	$L = 8.8189 \times SD (m) - 0.2991$

## ■ Projection distance calculation formula per projection lens (for PT-DX800E)

Lens type		Aspect ratio	Projection distance (L) formula	
Standard zoom lens	-	4:3	Min. (LW)	$L = 1.4567 \times SD (m) - 0.0746$
			Max. (LT)	$L = 2.0354 \times SD (m) - 0.0725$
		16:9	Min. (LW)	$L = 1.5866 \times SD (m) - 0.0746$
			Max. (LT)	$L = 2.2165 \times SD (m) - 0.0725$
Fixed-focus lens	Model No.: ET-DLE055	4:3	-	$L = 0.6732 \times SD (m) - 0.0476$
		16:9	-	$L = 0.7323 \times SD (m) - 0.0476$
Ultra short-focus zoom lens	Model No.: ET-DLE080	4:3	Min. (LW)	$L = 0.6693 \times SD (m) - 0.0471$
			Max. (LT)	$L = 0.8307 \times SD (m) - 0.0442$
		16:9	Min. (LW)	$L = 0.7323 \times SD (m) - 0.0471$
			Max. (LT)	$L = 0.9055 \times SD (m) - 0.0442$
Short-focus zoom lens	Model No.: ET-DLE150	4:3	Min. (LW)	$L = 1.1024 \times SD (m) - 0.0540$
			Max. (LT)	$L = 1.5866 \times SD (m) - 0.0498$
		16:9	Min. (LW)	$L = 1.2008 \times SD (m) - 0.0540$
			Max. (LT)	$L = 1.7283 \times SD (m) - 0.0498$
Medium-focus zoom lens	Model No.: ET-DLE250	4:3	Min. (LW)	$L = 1.9213 \times SD (m) - 0.0800$
			Max. (LT)	$L = 3.0354 \times SD (m) - 0.0792$
		16:9	Min. (LW)	$L = 2.0945 \times SD (m) - 0.0800$
			Max. (LT)	$L = 3.3071 \times SD (m) - 0.0792$
Long-focus zoom lens	Model No.: ET-DLE350	4:3	Min. (LW)	$L = 3.0315 \times SD (m) - 0.1351$
			Max. (LT)	$L = 4.5787 \times SD (m) - 0.1346$
		16:9	Min. (LW)	$L = 3.3031 \times SD (m) - 0.1351$
			Max. (LT)	$L = 4.9882 \times SD (m) - 0.1346$
Ultra long-focus zoom lens	Model No.: ET-DLE450	4:3	Min. (LW)	$L = 4.5866 \times SD (m) - 0.3017$
			Max. (LT)	$L = 7.2520 \times SD (m) - 0.2991$
		16:9	Min. (LW)	$L = 5.0000 \times SD (m) - 0.3017$
			Max. (LT)	$L = 7.9016 \times SD (m) - 0.2991$

## Adjustable feet

The adjustable feet can be extended by turning it as shown in the figure. It is retracted by turning it in the opposite direction. (Projection angle can be adjusted vertically.)

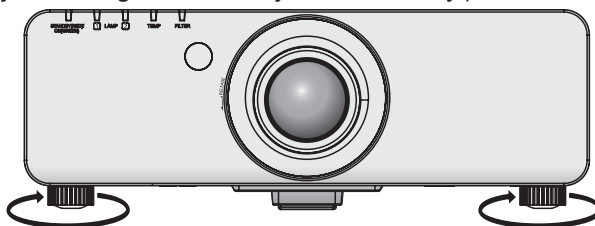

**Adjustable range**  
Front adjustable feet: 30 mm

### Attention

- Heated air is blowing out from the air exhaust port while the lamp is on. Do not touch the air exhaust port directly when adjusting the adjustable feet.

# Removing/attaching the projection lens

Perform the following steps when removing/attaching the standard zoom lens or the optional lens. Move the lens to the home position before replacing or removing the lens. (➡ page 36)

## Attention

- Replace the projection lens after turning off the power of the projector.
- Do not touch the lens signal receiver. Dust or dirt may cause defective contact.
- Do not touch the lens surface with your bare hands.
- Before attaching the projection lens, remove the dust sponge attached to the projector and the lens cover attached to the projection lens.
- For the ultra short-focus zoom lens (ET-DLE080), the procedure for removing/attaching the lens is different. For details, refer to the instruction manual supplied with ET-DLE080.

## Removing the projection lens

- 1) Turn the projection lens cover counterclockwise and remove.

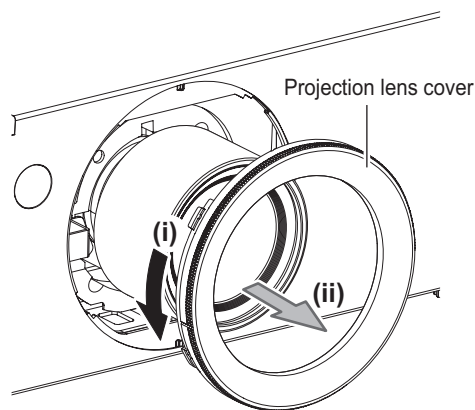

- 2) While pressing the lens release button, turn the projection lens counterclockwise all the way, and remove the projection lens.

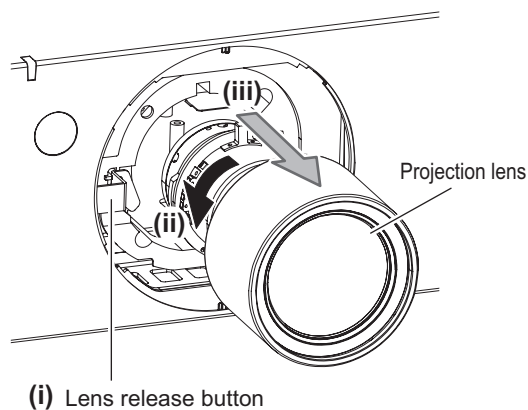

## Attention

- Store the removed lens where it will be free from vibration and impact.

# Removing/attaching the projection lens

## Attaching the projection lens

- 1) Remove the projection lens cover, align the guide of the projection lens to the guide groove on the projector, and then insert the projection lens.

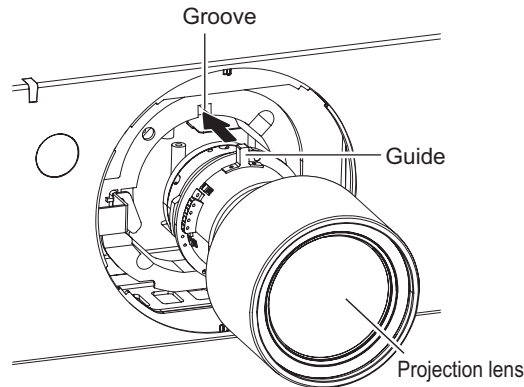

- 2) Turn the projection lens clockwise until it clicks.

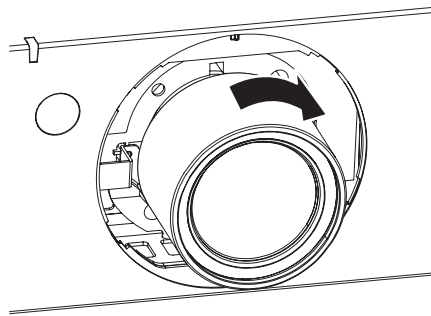

- 3) Attach the projection lens cover aligning the marking (groove \*1) to the tip of the arrow on the projector (\*2), and then turn and secure the projection lens cover until the \*1 groove aligns with the \*3 marking.

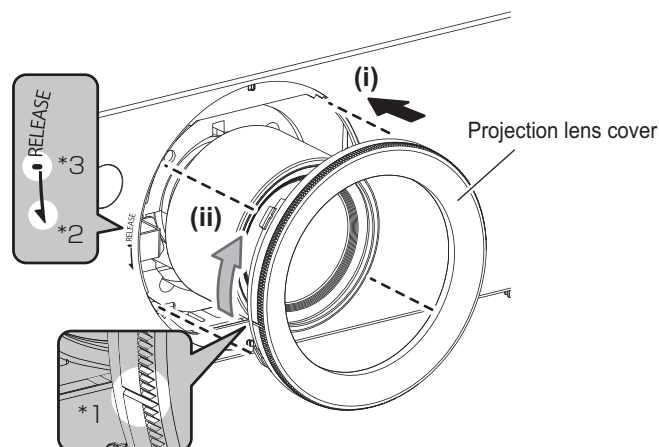

### Attention

- Turn the projection lens counterclockwise to confirm that it does not come out.

# Connections

## Before connecting to the projector

- Read carefully the instruction manual for the device to be connected.
- Turning off the power switch of the devices before connecting cables.
- If any connection cable is not supplied with the device, or if no optional cable is available for the connection of the device, prepare a necessary system connection cable to suit the device.
- Video signals containing too much jitter may cause the images on the screen to randomly wobble or wafture. In this case, a time base corrector (TBC) must be connected.
- The projector accepts the following signals: VIDEO, S-VIDEO, analog RGB (with TTL sync. Level) and digital signal.
- Some computer models are not compatible with the projector.
- Use a compensator when you connect each of equipment to the projector using long cables. Otherwise the image may not be output properly.

### <S-VIDEO IN> terminal pin assignments and signal names

	Pin No.	Signal names
	(1)	Ground (luminance signal)
	(2)	Ground (color signal)
	(3)	Luminance signal
	(4)	Color signal

### <RGB 2 IN> terminal pin assignments and signal names

	Pin No.	Signal names
	(1)	R/PR
	(2)	G/Y
	(3)	B/PB
	(12)	DDC data
	(13)	SYNC/HD
	(14)	VD
	(15)	DDC clock

(4) and (9) are not used.  
(5) - (8), (10), and (11) are GND terminals.

### <DVI-D IN> terminal pin assignments and signal names

	Pin No.	Signal name	Pin No.	Signal names
	(1)	T.M.D.S data 2-	(13)	-
	(2)	T.M.D.S data 2+	(14)	+5 V
	(3)	T.M.D.S data 2/4 shield	(15)	GND
	(4)	-	(16)	Hot plug detection
	(5)	-	(17)	T.M.D.S data 0-
	(6)	DDC clock	(18)	T.M.D.S data 0+
	(7)	DDC data	(19)	T.M.D.S data 0/5 shield
	(8)	-	(20)	-
	(9)	T.M.D.S data 1-	(21)	-
	(10)	T.M.D.S data 1+	(22)	T.M.D.S clock shield
	(11)	T.M.D.S data 1/3 shield	(23)	T.M.D.S clock+
	(12)	-	(24)	T.M.D.S clock-

## Connecting example: AV equipment

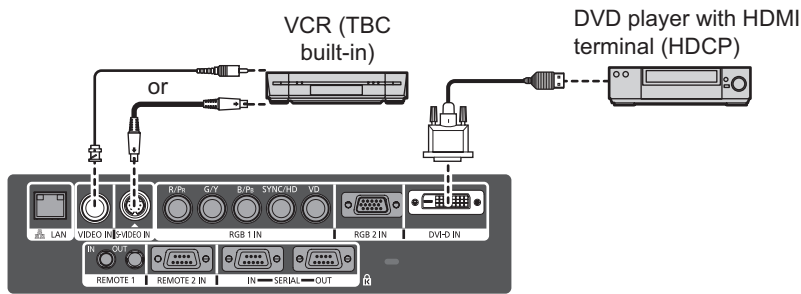

### Attention

- Always use one of the following when connecting a VCR.
  - A VCR with built-in time base corrector (TBC)
  - A time base corrector (TBC) between the projector and the VCR
- If nonstandard burst signals are connected, the image may be distorted. In such case, connect the time base corrector (TBC) between the projector.

### Note

- The <DVI-D IN> terminal can be used to connect the projector with an HDMI- or DVI-D compliant device. However, with some devices the images may not appear. (➔ page 58)
- To connect an HDMI compatible device, an HDMI-DVI-D conversion cable is required.
- When the DVI-D signal is input, EDID setting may be required depending on the connected device. (➔ page 58)

## Connecting example: Computers

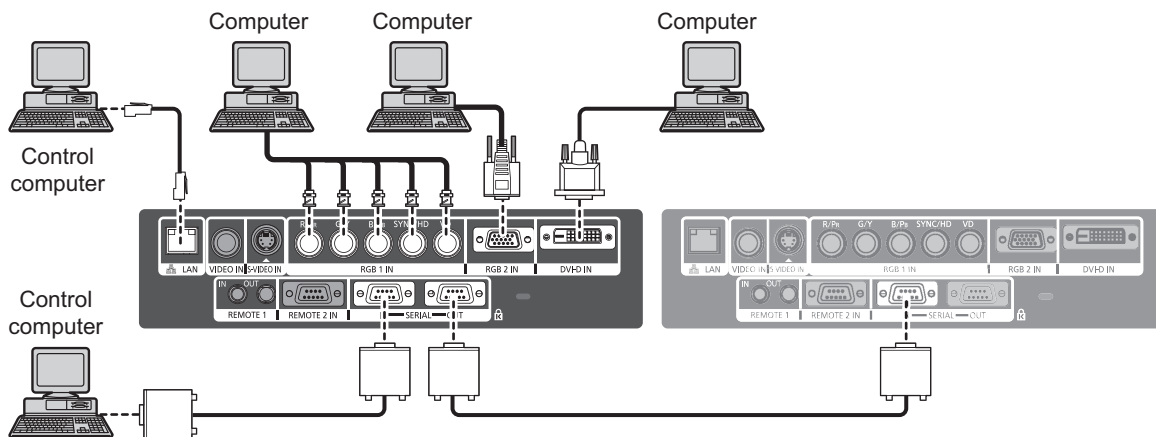

### Note

- The <DVI-D IN> terminal is compatible only with single link DVI signals.
- Refer to “List of compatible signals” (➔ page 102) for the details of the RGB signal from the computer that the projector supports.
- If you operate the projector using the computer with the resume feature (last memory), it is required to reset the resume feature to operate the projector.
- When the SYNC ON GREEN signal is input, do not input sync signals to the <SYNC/HD> and <VD> terminals.
- When the DVI-D signal is input, EDID setting may be required depending on the connected device. (➔ page 58)

### Caution

When connecting the projector to a computer or an external device, use the power cord supplied with each device and commercially available shielded cables.



# Powering ON/OFF

## Connecting the power cord

Be sure to insert the supplied power cord securely to its base to prevent it from coming off. Confirm that the <MAIN POWER> switch is at the <OFF> side, before connecting the power cord.

### ■ Attaching

- 1) Check the shapes of the AC IN terminal <AC IN> and the power cord connector and insert the plug securely in the correct direction.

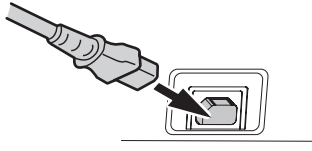

- 2) Attach the power cord secure lock along with the guide on the AC IN terminal <AC IN>.

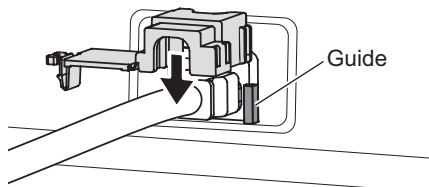

- 3) Push in the tab of the power cord secure lock until it clicks.

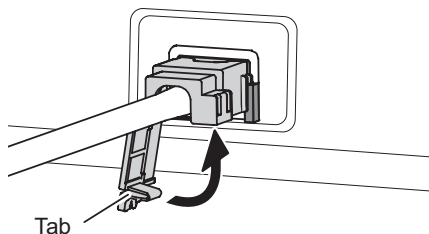

- 4) Connect the power plug to the outlet.

### ■ Removing

- 1) Confirm that the <MAIN POWER> switch is at the <OFF> side and unplug the power cord from the outlet.
- 2) Push down the tab of the power cord secure lock.

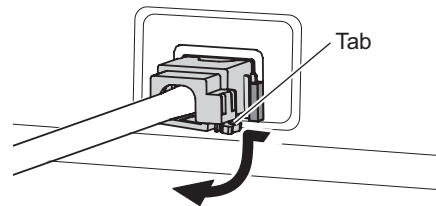

- 3) Remove the power cord secure lock upward along with the guide of the AC IN terminal <AC IN>.

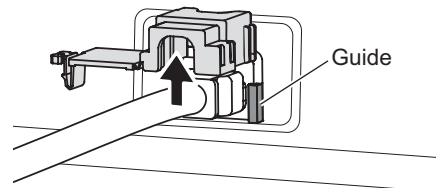

- 4) Remove the plug from the AC IN terminal <AC IN>.

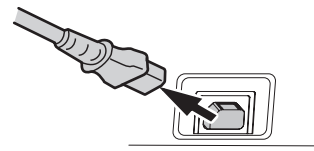



## Power indicator

The power indicator informs you of the power status. Check the status of the power indicator <STANDBY (RED)/ ON (GREEN)> before operating the projector.

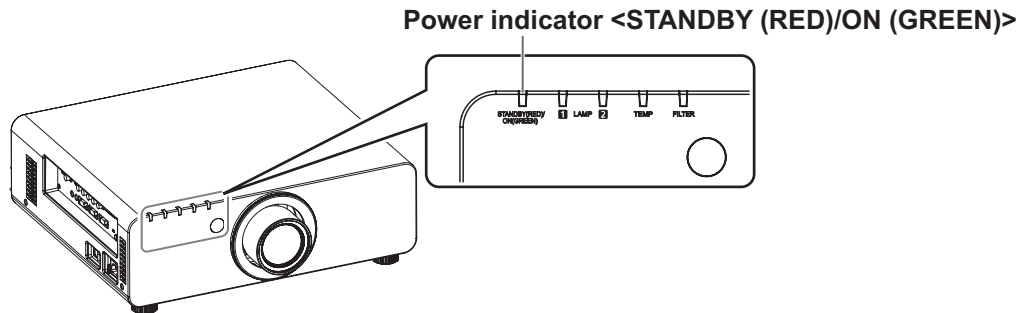

Indicator status		Status
No illumination	No illumination	The main power is switched off.
Red	Lit	The power is switched off. (Standby mode) ● Press the POWER ON <   > button to start the projection. When the lamp indicator <LAMP1>/<LAMP2> or temperature indicator <TEMP> is flashing, you cannot operate the projector. (➔ page 87)
Green	Lit	Projecting.
Orange	Lit	The projector is getting ready to be switched off. The power will be switched off momentarily. (Standby mode)

### Note

- When the power indicator < STANDBY (RED)/ON (GREEN)> is lit in orange, the fan is operating to cool the projector.
- Electricity is consumed even in the standby mode (even when the power indicator <STANDBY (RED)/ON (GREEN)> lit in red).

## Powering ON/OFF

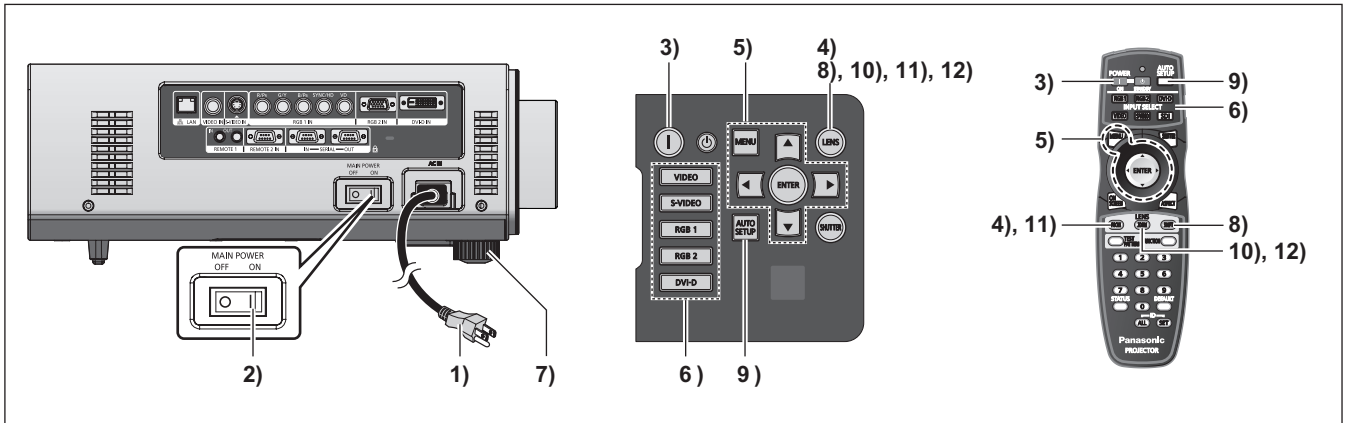

### Powering up the projector

When using the optional projection lens, attach the projection lens before turning on the power. (➡ page 29)  
Remove the lens cover beforehand.

- 1) **Connect the power plug to the outlet.**  
(AC 220 V - 240 V 50 Hz/60 Hz)
- 2) **Press the <ON> side of the <MAIN POWER> switch to turn on the power.**
  - The power indicator <STANDBY (RED)/ON (GREEN)> will light in red, and the projector will enter the standby mode.
- 3) **Press the POWER ON < | > button.**
  - The power indicator <STANDBY (RED)/ON (GREEN)> will light in green and soon the image is projected on the screen.

#### Note

- If the projector is turned on at about 0°C (32°F), a warm-up period of approximately five minutes may be necessary to start projection. The temperature indicator <TEMP> lights up during the warm-up period. When the warm-up is completed, the temperature indicator <TEMP> turns off and the projection starts. Refer to "Managing the indicated problems" (➡ page 87) for the indicator status.
- If the temperature of the operating environment is low and warm-up takes more than five minutes, the projector will judge that a problem has occurred and the power is automatically set to stand-by. If this happens, increase the temperature around the projector so that it is 0°C (32°F) or higher and turn off the main power, and then turn on the power again.
- When turning on the power, if [ECO] is selected in the [PROJECTOR SETUP] menu → [STANDBY MODE] (➡ page 63), projection will start approximately ten seconds later than when [NORMAL] is selected.
- If the direct power off function was used to set the <MAIN POWER> switch to <OFF> during projection, the next time the <MAIN POWER> switch is set to <ON> with the power plug connected to the outlet, The power indicator <STANDBY (RED)/ON (GREEN)> will soon light green and an image will be projected.

### Making adjustment and selection

It is recommended that the images are projected continuously for at least 30 minutes before the focus is adjusted.

- 4) **Press the <FOCUS> button to adjust the focus of the image roughly.**  
(➡ page 36)
- 5) **Set the projection method using [PROJECTION METHOD] (➡ page 61) and [COOLING CONDITION] (➡ page 62).**
  - Refer to "Navigating through the menu" (➡ page 41) regarding the operation of the menu screen.
- 6) **Press the Input Selection (<RGB1>, <RGB2>, <DVI-D>, <VIDEO>, and <S-VIDEO>) buttons to select the input signal.** (➡ page 38)
- 7) **Adjust the front and back, and sideway tilt of the projector with the adjustable feet.** (➡ page 27)
- 8) **Press the <SHIFT> button to adjust the position of the image.** (➡ page 36)
- 9) **If the input signal is RGB, press the <AUTO SETUP> button.** (➡ page 39)
- 10) **Press the <ZOOM> button to adjust the size of the image to the screen.**  
(➡ page 36)
- 11) **Press the <FOCUS> button again to adjust the focus.**
- 12) **Press the <ZOOM> button again to adjust the zoom and the size of the image to match the screen.**

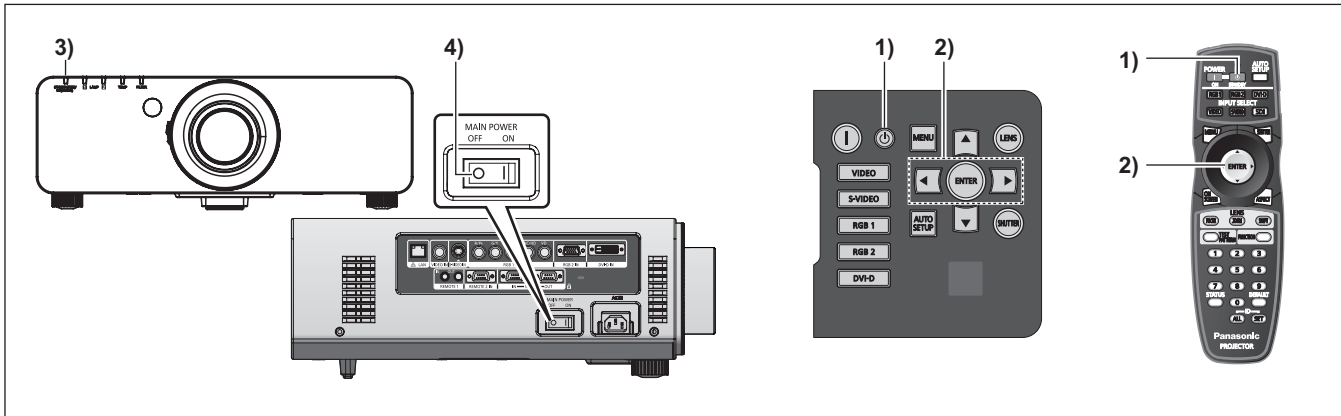

## Powering off the projector

- 1) Press the **STANDBY** < ⏻ > button.
- 2) Press the **◀ ▶** buttons to select **[OK]**, and press the **<ENTER>** button. (Or press the **STANDBY** < ⏻ > button again.)
  - Projection of the image will stop, and the Power indicator **<STANDBY (RED)/ON (GREEN)>** on the projector lights in orange. (The fan keeps running.)
- 3) Wait until the power indicator **<STANDBY (RED)/ON (GREEN)>** of the projector turns red (until the fan stops).
- 4) Press the **<OFF>** side of the **<MAIN POWER>** switch to turn off the power.

### Note

- **Do not turn on the power immediately after turning it off.**  
In the cooling state of the luminous lamp after the power is turned off, the lamp may not light up even if the power is turned on. To light up the lamp, turn on the power again after the luminous lamp goes into standby status. Turning on the power while the lamp is still hot may shorten the lamp life.
- **The projector consumes approximately 9 W power when the power is turned off by the remote control with the main power of the projector turned on.**  
(When [STANDBY MODE] is set to [NORMAL])  
If [STANDBY MODE] (➡ page 63) is set to [ECO], the power consumption in the standby mode can be reduced.

## Direct power off function

Even if you turn the **<MAIN POWER>** switch [OFF] during projection or just after the lamp turns off, the cooling fan will continue to rotate using internally stored power. In cases where the **<MAIN POWER>** switch is not easily accessible, such as during ceiling mount, you can safely turn off the power by using the power breaker switch. This function also works if a power outage occurs or if the power cable is accidentally disconnected from the outlet right after turning off the power.

### Note

- If projection was stopped by turning off the power breaker switch and you turn on the power breaker again, the power indicator **<STANDBY (RED)/ON (GREEN)>** will light in green and projection will start again.
- When the lamp has been cooled by the direct power off function, it sometimes takes longer than usual for the lamp to light up again.
- Confirm that the fan has stopped before packing the projector to transport or store.

# Projecting

Check the connections of the external devices, attachment of the projection lens (➡ page 29), and connection of the power cord (➡ page 32), and turn on the power (➡ page 34) to start the projection. Select the input signal and adjust the image.

## Selecting the input signal

Select an input signal.

**Press the Input Selection (<RGB1>, <RGB2>, <DVI-D>, <VIDEO>, and <S-VIDEO>) buttons on the control panel or the remote control.**

- Image for the selected input signal is projected.

### Attention

- Images may not be projected properly depending on the connected device and DVD, video tape, etc. to be played.  
Select a system format matching the input signal from the [PICTURE] menu → [SYSTEM SELECTOR] (➡ page 47).
- Confirm the aspect ratio of the screen to project and the image, and switch to an optimum aspect ratio from the [POSITION] menu → [ASPECT] (➡ page 48).

## Adjusting the focus, zoom, and shift

If the projected image or the position is not correct when the positioning of the projector and the screen is correctly installed, adjust the focus, zoom, and shift.

### ■ At the projector

**1) Press the <LENS> button on the control panel.**

- Pressing the button changes the setup screen in the order of [FOCUS] [ZOOM], and [SHIFT].

**2) Select each item and press ▲▼◀▶ to adjust it.**

### ■ Using the remote control

**1) Press the Lens (<FOCUS>, <ZOOM>, and <SHIFT>) buttons on the remote control.**

- <FOCUS> button:  
Adjusts focus.
- <ZOOM> button:  
Adjusts zoom.
- <SHIFT> button:  
Adjusts shift.

**2) Select each item and press ▲▼◀▶ to adjust it.**

### Note

- Zoom adjust menu will be displayed even when the lens without the zoom function is used, but it will not operate.
- The adjustment can be performed faster by pressing and holding ▲▼◀▶ for at least three seconds.
- It is recommended that the images are projected continuously for at least 30 minutes before the focus is adjusted.
- [FOCUS] is shown in yellow so that the displayed menu item can be recognized by color, even when the projector is not focused and displayed characters are unreadable. (Factory default)  
Displaying color of [FOCUS] is different depending on the setting in the [OSD DESIGN] menu (➡ page 59).

## Moving the lens to the home position

- 1) Press the <LENS> button on the control panel or the <SHIFT> button on the remote control for at least three seconds.**
- 2) While the [HOME POSITION] menu is displayed (for approximately five seconds), press the <ENTER> button.**

LENS
HOME POSITION
[ENTER] EXECUTE
[MENU] CANCEL

- [PROGRESS] is displayed in the menu screen, and the lens returns to the home position.

### Attention

- The home position of the lens is the lens position when the lens is being replaced or when the projector is being stored, and it is not the optical center of the screen.

## Adjustment range by the lens position shift (optical shift)

Perform the lens position shift within the adjustment range.

The focus may change when the lens position is shifted out of the adjustment range. This is because the movement of the lens is restricted to protect the optical parts. Projection position can be adjusted with the optical axis shift based on the standard projection position in the range shown in the following figures.

Lens type	Zoom lens	
	Standard zoom lens, ET-DLE150, ET-DLE250, ET-DLE350, ET-DLE450	ET-DLE080
PT-DW730E		
PT-DX800E		

\* The above are the figures when the projector is placed on the floor.

### Note

- When the fixed-focus lens (ET-DLE055) is attached, shift adjustment cannot be performed.

# Basic operations using the remote control



## Note

- If the <MENU> button on the control panel is pressed for at least three seconds with the on-screen display off, the on-screen display is turned on.

## Switching the input signal

The input signal for projection can be switched.



Press the Input Selection (<RGB1>, <RGB2>, <DVI-D>, <VIDEO>, and <S-VIDEO>) buttons on the remote control or the control panel.

<RGB1>	Switches the input to RGB1.
<RGB2>	Switches the input to RGB2.
<DVI-D>	Switches the input to DVI-D.
<VIDEO>	Switches the input to VIDEO.
<S-VIDEO>	Switches the input to S-VIDEO.

## Note

- The <SDI> button cannot be used.

## Using the STATUS function

You can display the status of the projector.



Press the <STATUS> button on the remote control.

- The [STATUS] screen is displayed.

STATUS		1/3
INPUT	RGB2	
NAME	SXGA60+-A1	
SIGNAL FREQUENCY	65.22k Hz/59.99Hz	
PROJECTOR RUNTIME	1h	
LAMP1	11h / ON /	
LAMP2	1h / ON /	
INTAKE AIR TEMP.	31°C / 87° F	
OPTICS MODULE TEMP.	27°C / 80° F	
AROUND LAMP TEMP.	31°C / 87° F	

## Note

- This can be displayed from the [PROJECTOR SETUP] menu. (➔ page 43)

## Using the SHUTTER function

If the projector is not used for a certain period of time during the meeting intermission, for example, it is possible to turn off the image temporarily.



- 1) Press the <SHUTTER> button on the remote control or the control panel.
  - The image disappears.
- 2) Press the <SHUTTER> button again.
  - The image resumes.

## Using the on-screen display function

Turn off the on-screen display function (no display) when you do not wish the viewers to see the on-screen display, such as the menu or the input terminal name.



- 1) Press the <ON SCREEN> button on the remote control.
  - The on-screen display is turned off.
- 2) Press the <ON SCREEN> button again.
  - The on-screen display is turned on.



## Using the automatic setup function

The automatic setup function can be used to automatically adjust the resolution, clock phase, and picture position when analog RGB signals consisting of bitmap images such as computer signals are being input, or to automatically adjust the picture position when DVI-D/HDMI signals are being input. (Automatic setup does not work for a movie format signal such as an output signal of the DVD player.) It is recommended to supply images with a bright white border at the rims and characters with high contrast black and white, when the system is in the automatic adjustment mode.

Avoid supplying images that include halftones or gradation, such as photographs and computer graphics.



**Press the <AUTO SETUP> button on the remote control or the control panel.**

- [COMPLETE] is displayed when it has completed without any problem.

### Note

- The CLOCK PHASE may shift even if it has completed without any incident. In such cases, adjust with the [POSITION] menu → [CLOCK PHASE] (➡ page 50).
- If an image with blurred edges or a dark image is input, [INCOMPLETE] may appear or adjustment may not be performed properly even if [COMPLETE] appears. In this case, adjust the settings in the [ADVANCED MENU] menu → [INPUT RESOLUTION] (➡ page 52), [POSITION] → [CLOCK PHASE] (➡ page 50), [SHIFT] (➡ page 48).
- Adjust specific signals according to the [DISPLAY OPTION] menu → [AUTO SETUP] (➡ page 57).
- Automatic adjustment may not work depending on the model of the computer.
- Automatic adjustment may not work for a synchronization signal of C-SYNC or SYNC ON GREEN.
- Images may be disrupted for a few seconds during automatic adjustment, but it is not a malfunction.
- Adjustment is required for each input signal.
- Automatic adjustment can be canceled by pressing the <MENU> button during the automatic adjustment operation.
- Even for an RGB signal for which automatic setup is possible, if automatic setup is performed while moving images are being input, [INCOMPLETE] may appear, or adjustment may not be performed properly even if [COMPLETE] appears.

## Using the FUNCTION button

[DISABLE], [SUB MEMORY], [SYSTEM SELECTOR], [SYSTEM DAYLIGHT VIEW], [FREEZE], or [SIDE BY SIDE] operations can be assigned to the <FUNCTION> button on the remote control so that it can be used as an easy shortcut button.



**Press the <FUNCTION> button on the remote control.**

### Note

- [SIDE BY SIDE] can be set up only with PT-DW730E.
- Assignment of the button is performed from the [PROJECTOR SETUP] menu → [FUNCTION BUTTON] (➡ page 65).

## Displaying the internal test pattern

The projector has nine types of internal test patterns to check the condition of the set. To display test patterns, perform the following steps.



**1) Press the <TEST PATTERN> button on the remote control.**

**2) Press ◀▶ to select the test pattern.**

### Note

- Setting is also available from the [TEST PATTERN] menu (➡ page 67).
- Settings of position, size, and other factors will not be reflected in test patterns. Be sure to display an actual input signal before performing these adjustments.

# Basic operations using the remote control

## Changing the picture aspect ratio

You can toggle through aspect ratios to select the one that is appropriate for the input signal.



**button**

**Press the <ASPECT> button on the remote control.**

- The setting will change as follows each time the button is pressed.

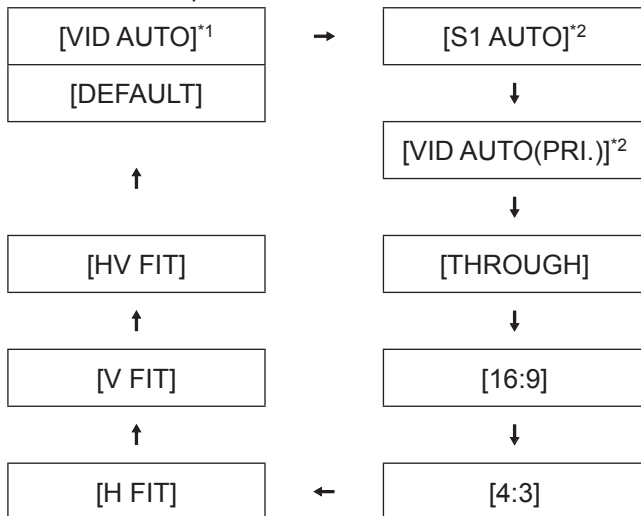

\*1: VIDEO, S-VIDEO (NTSC) only

\*2: S-VIDEO (NTSC) only

### Note

- Some aspect ratios may not be available depending on the input signal. Refer to “[ASPECT]” (➔ page 48) for details.



# Menu Navigation

The on-screen menu (Menu screen) is used to perform various settings and adjustments of the projector.

## Navigating through the menu

### Operating procedure



1) Press the <MENU> button on the remote control or the control panel.

- The [MAIN MENU] screen is displayed.

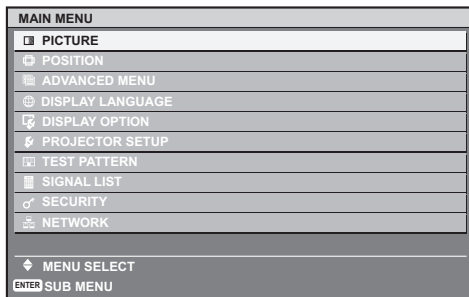

2) Press ▲▼ to select the main menu item.

- The selected item is highlighted in yellow.

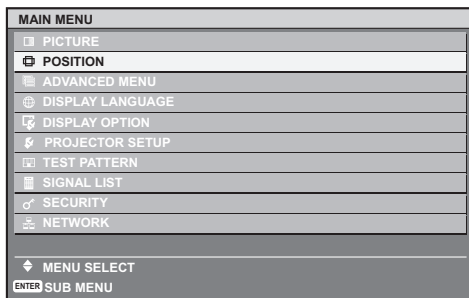

3) Press the <ENTER> button.

- The sub-menu items of the selected main menu are displayed.

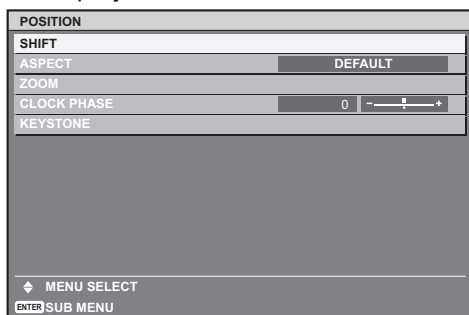

4) Press ▲▼ to select the sub-menu item, then press ◀▶ to change the settings or adjust the parameter values.

- For some items, press ◀▶ to display an individual adjustment screen with a bar scale as shown in the following diagram.

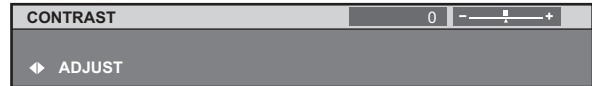

#### Note

- Press the <MENU> button to return to the previous menu.
- Some items may not be adjusted or used for certain signal formats input to the projector. The menu items that cannot be adjusted or used are shown in gray characters, and they cannot be selected.
- Some items can be adjusted even if signals are not input.
- Individual adjustment screen is cleared automatically if no operation is performed for approximately five seconds. (Excluding some functions)
- Refer to "MAIN MENU" (➔ page 42) or "SUB MENU" (➔ pages 42 to 43) regarding the menu items.
- The selected item is displayed with the yellow cursor by default. The cursor color depends on the setting in [OSD DESIGN] (➔ page 59).

### Resetting to the factory default

If the <DEFAULT> button on the remote control is pressed, the values set in the menu will be restored to the factory default settings.



Press the <DEFAULT> button on the remote control.



# Menu Navigation

## Note

- You cannot reset all the settings to the factory default at a time.
- To reset all the settings adjusted in the sub-menu item to the factory default at a time, perform initialization from the [PROJECTOR SETUP] menu → [INITIALIZE] (➔ page 66).
- Some menu items cannot be reset by pressing the <DEFAULT> button. Adjust each item manually.
- The triangular mark under the bar scale in the individual adjustment screen indicates the factory default setting.  
The position of the triangular mark varies by the selected input signals.

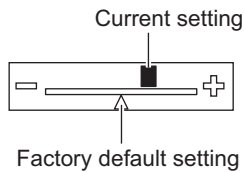

## MAIN MENU

There are following ten items in the main menu. When a main menu item is selected, the screen changes to a sub-menu selection screen.

Main menu item		Page
	[PICTURE]	42
	[POSITION]	42
	[ADVANCED MENU]	42
	[DISPLAY LANGUAGE]	43
	[DISPLAY OPTION]	43
	[PROJECTOR SETUP]	43
	[TEST PATTERN]	43
	[SIGNAL LIST]	43
	[SECURITY]	43
	[NETWORK]	43

## SUB MENU

The sub-menu screen of the selected main menu is displayed, and you can set and adjust the various items in the sub-menu.

### ■ [PICTURE]

Sub-menu item	Factory default	Page
[PICTURE MODE]	[STANDARD]*1	44
[CONTRAST]	[0]	44
[BRIGHTNESS]	[0]	44
[COLOR]	[0]	45
[TINT]	[0]	45
[COLOR TEMPERATURE]	[DEFAULT]	45
[WHITE GAIN]	[10]	46
[SYSTEM DAYLIGHT VIEW]	[OFF]*1	46
[SHARPNESS]	[6]	46
[NOISE REDUCTION]	[1]	46
[AI]	[ON]	47
[SYSTEM SELECTOR]	[YP <sub>B</sub> PR]*1	47

\*1: Depends on the signal input.

## Note

- The factory default settings may vary depending on the picture mode.

### ■ [POSITION]

Sub-menu item	Factory default	Page
[SHIFT]	—	48
[ASPECT]	[DEFAULT]*1	48
[ZOOM]	—	49
[CLOCK PHASE]	[16]	50
[KEystone]	—	50

\*1: Depends on the signal input.

### ■ [ADVANCED MENU]

Sub-menu item	Factory default	Page
[DIGITAL CINEMA REALITY]	[AUTO]*1	51
[BLANKING]	—	51
[INPUT RESOLUTION]	—	52
[CLAMP POSITION]	[0]	52
[EDGE BLENDING]	[OFF]	52
[RASTER POSITION]	—	53

\*1: Depends on the signal input.

## ■ [DISPLAY LANGUAGE]

Details (➡ page 54)

## ■ [DISPLAY OPTION]

Sub-menu item	Factory default	Page
[COLOR MATCHING]	[OFF]	55
[COLOR CORRECTION]	[OFF]	56
[CONTRAST MODE]	[DEFAULT]	56
[SCREEN SETTING]	—	57
[AUTO SIGNAL]	[OFF]	57
[AUTO SETUP]	—	57
[DVI-D IN]	—	58
[ON-SCREEN DISPLAY]	—	58
[BACK COLOR]	[BLUE]	59
[STARTUP LOGO]	[DEFAULT LOGO]	60
[FREEZE]	—	60
[SIDE BY SIDE]* <sup>1</sup>	—	60

\*1: Only for PT-DW730E.

## ■ [PROJECTOR SETUP]

Sub-menu item	Factory default	Page
[PROJECTOR ID]	[ALL]	61
[PROJECTION METHOD]	[FRONT/FLOOR]	61
[HIGH ALTITUDE MODE]	[OFF]	61
[COOLING CONDITION]	[FLOOR SETTING]	62
[LAMP SELECT]	[DUAL]	62
[LAMP RELAY]	[OFF]	63
[LAMP POWER]	[HIGH]	63
[STANDBY MODE]	[NORMAL]	63
[RS-232C]	—	63
[REMOTE2 MODE]	[DEFAULT]	64
[STATUS]	—	64
[NO SIGNAL SHUT-OFF]	[DISABLE]	65
[FUNCTION BUTTON]	—	65
[DATE AND TIME]	—	65
[SAVE ALL USER DATA]	—	65
[LOAD ALL USER DATA]	—	66
[INITIALIZE]	—	66
[SERVICE PASSWORD]	—	66

## ■ [TEST PATTERN]

Details (➡ page 67)

## ■ [SIGNAL LIST]

Details (➡ page 68)

## ■ [SECURITY]

Sub-menu item	Factory default	Page
[SECURITY PASSWORD]	[OFF]	70
[SECURITY PASSWORD CHANGE]	—	70
[DISPLAY SETTING]	[OFF]	70
[TEXT CHANGE]	—	71
[MENU LOCK]	[OFF]	71
[MENU LOCK PASSWORD]	—	71
[CONTROL DEVICE SETUP]	—	71

## ■ [NETWORK]

Sub-menu item	Factory default	Page
[NETWORK SETUP]	—	73
[NETWORK CONTROL]	—	73
[NETWORK STATUS]	—	73

### Note

- Some items may not be adjusted or used for certain signal formats to be input to the projector. The menu items that cannot be adjusted or used are shown in gray characters, and they cannot be selected.
- Sub-menu items and factory default settings differ depending on the selected input terminal.

# [PICTURE] menu

Select [PICTURE] from the main menu, and select the item from the sub-menu. Refer to “Navigating through the menu” (➔ page 41) regarding the operation of the menu screen.

- After selecting the item, press ▲▼◀▶ to set.

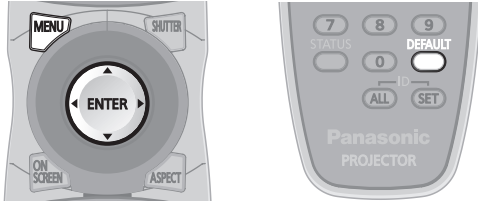

## [PICTURE MODE]

You can switch to the desired picture mode suitable for the image source and the environment in which the projector is used.

- 1) Press ▲▼ to select [PICTURE MODE].
- 2) Press ◀▶ or press the <ENTER> button.
  - The [PICTURE MODE] individual adjustment screen is displayed.
- 3) Press ◀▶ to switch [PICTURE MODE].
  - The setting will change as follows each time you press the button.

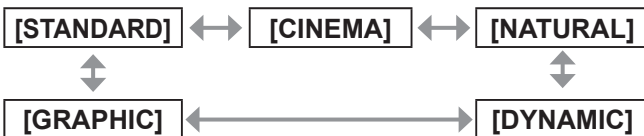

[STANDARD]	The picture becomes suitable for moving images in general.
[CINEMA]	The picture becomes suitable for movie sources.
[NATURAL]	The picture complies with sRGB.
[DYNAMIC]	The light output is maximized for use in bright areas.
[GRAPHIC]	The picture becomes suitable for input from to the personal computer.

### Note

- The factory default picture mode is [GRAPHIC] for the still image signal input mode, and [STANDARD] for the movie signal input mode.

## [CONTRAST]

You can adjust the contrast of the colors.

- 1) Press ▲▼ to select [CONTRAST].
- 2) Press ◀▶ or the <ENTER> button.
  - The [CONTRAST] individual adjustment screen is displayed.
- 3) Press ◀▶ to adjust the level.

Operation	Adjustment	Adjustment range
Press ▶ .	Brightens the screen and makes the color of image deeper.	Maximum value +31
Press ◀ .	Darkens the screen and makes the color of image lighter.	Minimum value -31

### Attention

- Adjust [BRIGHTNESS] first when you need to adjust the black level.

## [BRIGHTNESS]

You can adjust the dark (black) part of the projected image.

- 1) Press ▲▼ to select [BRIGHTNESS].
- 2) Press ◀▶ or the <ENTER> button.
  - The [BRIGHTNESS] individual adjustment screen is displayed.
- 3) Press ◀▶ to adjust the level.

Operation	Adjustment	Adjustment range
Press ▶ .	Increases the brightness of the dark (black) parts of the screen.	Maximum value +31
Press ◀ .	Reduces the brightness of the dark (black) parts of the screen.	Minimum value -31

## [COLOR]

You can adjust the color saturation of the projected image.

- 1) Press ▲▼ to select [COLOR].
- 2) Press ◀▶ or the <ENTER> button.
  - The [COLOR] individual adjustment screen is displayed.
- 3) Press ◀▶ to adjust the level.

Operation	Adjustment	Adjustment range
Press ▶ .	Deepens colors.	Maximum value +31
Press ◀ .	Weakens colors.	Minimum value -31

## [TINT]

You can adjust the skin tone in the projected image.

- 1) Press ▲▼ to select [TINT].
- 2) Press ◀▶ or the <ENTER> button.
  - The [TINT] individual adjustment screen is displayed.
- 3) Press ◀▶ to adjust the level.

Operation	Adjustment	Adjustment range
Press ▶ .	Adjusts skin tone toward greenish color.	Maximum value +31
Press ◀ .	Adjusts skin tone toward reddish purple.	Minimum value -31

## [COLOR TEMPERATURE]

You can switch the color temperature if the white areas of the projected image are bluish or reddish.

- 1) Press ▲▼ to select [COLOR TEMPERATURE].
- 2) Press ◀▶ or the <ENTER> button.
  - The [COLOR TEMPERATURE] individual adjustment screen is displayed.
- 3) Press ◀▶ to switch [COLOR TEMPERATURE].
  - The setting will change as follows each time you press the button.

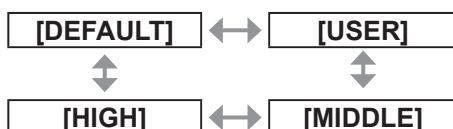

- When any setting other than [OFF] has been selected for [COLOR MATCHING] (➡ page 55) the [COLOR TEMPERATURE] setting is fixed to [USER].

### ■ To further adjust toward the desired white balance

- 4) Select [USER] in Step 3).
- 5) Press the <ENTER> button.
  - The [WHITE BALANCE] screen is displayed.
- 6) Press ▲▼ to select [WHITE BALANCE HIGH] or [WHITE BALANCE LOW].
- 7) Press the <ENTER> button.
  - The [WHITE BALANCE HIGH] screen or the [WHITE BALANCE LOW] screen is displayed.
- 8) Press ▲▼ to select [RED], [GREEN], or [BLUE].
- 9) Press ◀▶ to adjust the level.

Item	Operation	Adjustment	Adjustment range
[RED]	Press ▶ .	Deepens red.	Maximum value HIGH: 255 LOW: 63
	Press ◀ .	Weakens red.	
[GREEN]	Press ▶ .	Deepens green.	Minimum value HIGH: 0 LOW: 0
	Press ◀ .	Weakens green.	
[BLUE]	Press ▶ .	Deepens blue.	Default HIGH: 255 LOW: 32
	Press ◀ .	Weakens blue.	

#### Note

- Adjust [COLOR TEMPERATURE] correctly. All colors will not be displayed properly unless adequate adjustment is made. If the adjustment does not look suitable, you can press the <DEFAULT> button on the remote control to return the setting for the selected item only to the factory default setting.
- Internal test pattern (➡ page 67) will not reflect the settings of the [COLOR TEMPERATURE]. Be sure to perform the setting of the [COLOR TEMPERATURE] with the input signal projected.

## [PICTURE] menu

### [WHITE GAIN]

You can adjust the brightness of the white part of the projected image.

- 1) Press ▲▼ to select [WHITE GAIN].
- 2) Press ◀▶ or the <ENTER> button.
  - The [WHITE GAIN] individual adjustment screen is displayed.
- 3) Press ◀▶ to adjust the level.

Operation	Adjustment	Adjustment range
Press ▶ .	Increases the brightness of white.	Maximum value +10
Press ◀ .	Makes image natural.	Minimum value 0

### [SYSTEM DAYLIGHT VIEW]

You can correct the image to the optimal vividness even if it is projected under a bright light.

- 1) Press ▲▼ to select [SYSTEM DAYLIGHT VIEW].
- 2) Press ◀▶ or the <ENTER> button.
  - The [SYSTEM DAYLIGHT VIEW] individual adjustment screen is displayed.
- 3) Press ◀▶ to switch [SYSTEM DAYLIGHT VIEW].
  - The setting will change as follows each time you press the button.

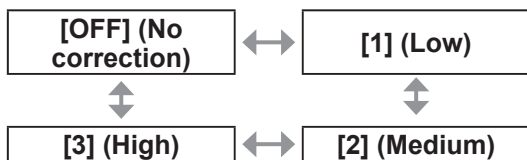

### [SHARPNESS]

You can adjust the sharpness of the projected image.

- 1) Press ▲▼ to select [SHARPNESS].
- 2) Press ◀▶ or the <ENTER> button.
  - The [SHARPNESS] individual adjustment screen is displayed.
- 3) Press ◀▶ to adjust the level.

Operation	Adjustment	Adjustment range
Press ▶ .	Contours become sharper.	0 - 15
Press ◀ .	Contours become softer.	

#### Note

- When the adjustment value is [15], press ▶ to set to [0]. Also, when the adjustment value is [0], press ◀ to set to [15].

### [NOISE REDUCTION]

You can reduce noises when the input image is degraded and noise is occurring in the image signal.

- 1) Press ▲▼ to select [NOISE REDUCTION].
- 2) Press ◀▶ or the <ENTER> button.
  - The [NOISE REDUCTION] individual adjustment screen is displayed.
- 3) Press ◀▶ to switch [NOISE REDUCTION].
  - The setting will change as follows each time you press the button.

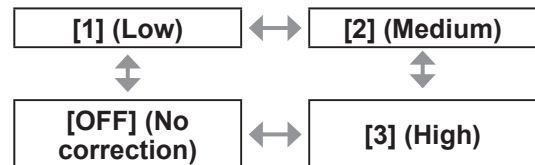

#### Attention

- When this is set for an input signal with less noise, the image may look different from what it originally was. In such case, set it to [OFF].

[AI]

You can project the optimal image with contrast by controlling the gradation in accordance with the image.

- 1) Press ▲▼ to select [AI].
- 2) Press ◀▶ or the <ENTER> button.
  - The [AI] individual adjustment screen is displayed.
- 3) Press ◀▶ to switch [AI].
  - The setting will change as follows each time you press the button.



[ON]	AI correction is enabled.
[OFF]	AI correction is disabled.

[SYSTEM SELECTOR]

The projector will automatically detect the input signal, but you can set the system method manually when an unstable signal is input. Set the system method matching the input signal.

- 1) Press ▲▼ to select [SYSTEM SELECTOR].
- 2) Press the <ENTER> button.
- 3) Press ▲▼ to select the system method.
- 4) Press the <ENTER> button.

■ When entering signals to the <VIDEO IN>/<S-VIDEO IN> terminal

- Select [AUTO], [NTSC], [NTSC4.43], [PAL], [PAL-M], [PAL-N], [SECAM], or [PAL60].

Attention

- Set it to [AUTO] normally.
- Switch the setting to the signal method for the TV used. The NTSC signal method is used in Japan.

Note

- Setting [AUTO] will automatically select [NTSC], [NTSC4.43], [PAL], [PAL-M], [PAL-N], [SECAM], or [PAL60].

■ When entering signals to the <RGB 1 IN>/<RGB 2 IN> terminal

- Only during 480i, 576i, or 576p signal input  
Select [RGB] or [YCbCr].
- Only during VGA60 or 480p signal input  
Select [VGA60], [480p], or [480pRGB].
- During movie signal input other than previously listed  
Select [RGB] or [YPbPr].

Note

- Refer to “List of compatible signals” (➡ page 102) for compatible signals.



# [POSITION] menu

Select [POSITION] from the main menu, and select the item from the sub-menu. Refer to "Navigating through the menu" (➔ page 41) regarding the operation of the menu screen.

- After selecting the item, press ▲▼◀▶ to set.

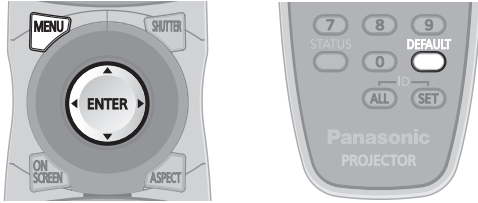

## [SHIFT]

You can move the image position vertically or horizontally if the image position projected on the screen is shifted even when the relative position of the projector and the screen is installed correctly.

- 1) Press ▲▼ to select [SHIFT].
- 2) Press the <ENTER> button.
  - The [SHIFT] screen is displayed.
- 3) Press ▲▼◀▶ to adjust the position.

### ■ For vertical (up and down) adjustment

Operation	Adjustment	
Press ▲ .	The picture position moves up.	
Press ▼ .	The picture position moves down.	

### ■ For horizontal (right and left) adjustment

Operation	Adjustment	
Press ▶ .	The picture position moves to the right.	
Press ◀ .	The picture position moves to the left.	

## [ASPECT]

You can switch the aspect ratio of the image. The aspect ratio is switched within the screen range selected in [SCREEN SETTING]. Set [SCREEN SETTING] first. (➔ page 57)

- 1) Press ▲▼ to select [ASPECT].
- 2) Press ◀▶ or the <ENTER> button.
  - The [ASPECT] individual adjustment screen is displayed.
- 3) Press ◀▶ to switch [ASPECT].
  - The setting will change as follows each time you press the button.

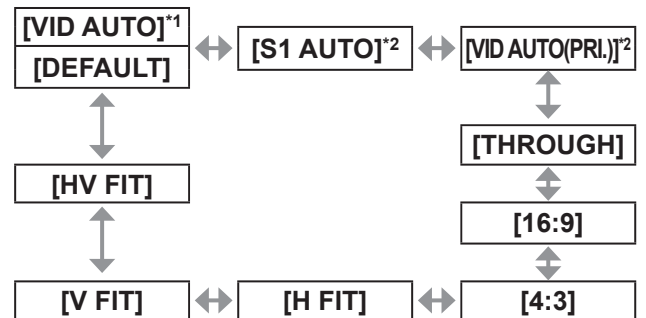

- \*1: Only during VIDEO or S-VIDEO (NTSC) input.
- \*2: Only during S-VIDEO (NTSC) input.

### ■ [DEFAULT]

Pictures are displayed without changing the aspect ratio of the input signals.

### ■ [VID AUTO]

The projector identifies the video ID (VID) embedded in the picture signals and displays the picture by automatically switching the screen sizes between 4:3 and 16:9. This function is effective for NTSC signals.

### ■ [S1 AUTO]

The projector identifies the S1 signal and displays the picture by automatically switching the screen sizes between 4:3 and 16:9. This function is effective for S-VIDEO NTSC signals.

### ■ [VID AUTO(PRI.)]

The projector identifies the above mentioned VID or S1 signals and displays the picture by automatically choosing the screen sizes of 4:3 or 16:9 according to the VID if it is detected or S1 signals if a VID is not detected. This function is effective for S-Video NTSC signals.

### ■ [THROUGH]

Pictures are displayed without changing the resolution of the input signals.



### ■ [16 : 9]

When standard signals\*<sup>1</sup> are input, the pictures are displayed with the aspect ratio converted to 16:9. When wide-screen signals\*<sup>2</sup> are input, the pictures are displayed without changing the aspect ratio.

### ■ [4 : 3]

When standard signals\*<sup>1</sup> are input, the pictures are displayed without changing the aspect ratio. When wide-screen signals\*<sup>2</sup> are input and [4:3] is selected with [SCREEN FORMAT], the aspect ratio is changed to 4:3. If [4:3] is not selected with [SCREEN FORMAT], the pictures are reduced so that they will be in the 4:3 screen without changing the input aspect ratio.

### ■ [H FIT]

The display will use the full width of the screen range selected with [SCREEN FORMAT]. When signals have a vertical aspect ratio that is larger than the screen aspect selected with [SCREEN FORMAT], the pictures will be displayed with their top or bottom areas cut off.

### ■ [V FIT]

The display will use the full height of the screen range selected with [SCREEN FORMAT].

### ■ [HV FIT]

The pictures are displayed in the full screen range selected with [SCREEN FORMAT]. If the aspect ratios of the input signals and screen range differ, conversion to the screen aspect set with [SCREEN FORMAT] is performed and then the pictures are displayed.

\*1: Standard signals are input signals with an aspect ratio of 4:3 or 5:4.

\*2: Wide-screen signals are input signals with an aspect ratio of 16:10, 16:9, 15:9 or 15:10.

#### Note

- Some size modes are not available for certain types of input signals. For NTSC signals, [DEFAULT] cannot be selected.
- If an aspect ratio which is different from the aspect ratio for the input signals is selected, the pictures will appear differently from the originals. Be careful of this when selecting the aspect ratio.
- If using this projector in places such as cafes or hotels to display programs for a commercial purpose or for public presentation, note that adjusting the aspect ratio or using the zoom function to change the screen pictures may be an infringement of the rights of the original copyright owner for that program under copyright protection laws. Take care when using a function of the projector such as the aspect ratio adjustment, zoom function, etc.
- If conventional (normal) 4:3 pictures which are not wide-screen pictures are displayed on a wide screen, the edges of the pictures may not be visible or they may become distorted. Such pictures should be viewed as with an aspect ratio of 4:3 in the original format intended by the creator of the pictures.

## [ZOOM]

You can adjust the size of the projected image.

- 1) Press ▲▼ to select [ZOOM].
- 2) Press the <ENTER> button.
  - The [ZOOM] screen is displayed.
- 3) Press ▲▼ to select [VERTICAL] or [HORIZONTAL], then press ◀▶ to adjust it.

### ■ When [ASPECT] is set to [DEFAULT]

- 1) Press ▲▼ to select [MODE].
- 2) Press ◀▶ to switch [MODE].

[INTERNAL]	Enlarge the size within the aspect range set in [SCREEN FORMAT].
[FULL]	Enlarges the size of the pictures using the whole of the display area selected with [SCREEN FORMAT].

#### Note

- When [ASPECT] is set to [THROUGH], [ZOOM] is not displayed.
- When anything but [DEFAULT] is selected for [ASPECT], [MODE] is not displayed.

## [POSITION] menu

### [CLOCK PHASE]

You can adjust to achieve an optimal image when there is a flickering image or smeared outlines.

- 1) Press ▲▼ to select [CLOCK PHASE].
- 2) Press ◀▶ or the <ENTER> button.
  - The [CLOCK PHASE] individual adjustment screen is displayed.
- 3) Press ◀▶ to adjust the level.
  - Adjustment value will change between [0] and [31]. Adjust so that the amount of interference is at a minimum.

#### Note

- Optimal value may not be achieved if the output from the input computer is unstable.
- Optimal value may not be achieved when there is a shift in the total dot numbers.
- [CLOCK PHASE] can only be adjusted when a signal is input in the <RGB 1 IN> terminal or the <RGB 2 IN> terminal.
- To project a signal with dot clock frequency with 150 MHz or higher, noise may not disappear even if [CLOCK PHASE] is adjusted.
- [CLOCK PHASE] cannot be adjusted when a digital signal is input.
- If you press ▶ while the adjustment value is [31], the value turns to [0]. If you press ◀ while the adjustment value is [0], the value turns to [31].

### [KEYSTONE]

You can correct the trapezoidal distortion that occurs when the projector is installed tilted or when the screen is tilted.

- 1) Press ▲▼ to select [KEYSTONE].
- 2) Press the <ENTER> button.
- 3) Select the item to adjust.
- 4) Press ◀▶ to adjust the level.

### ■ [KEYSTONE]

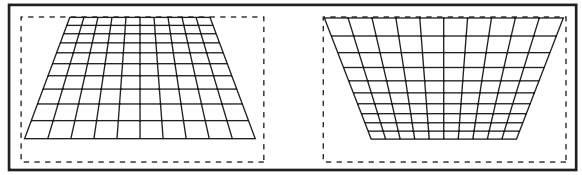

### ■ [SUB KEYSTONE]

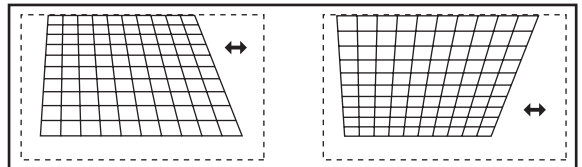

### ■ [LINEARITY]

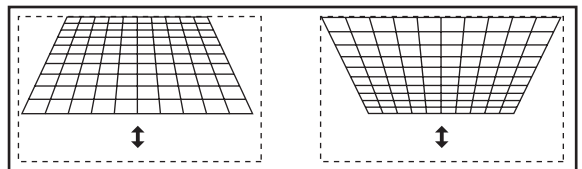

#### Note

- The menu or logo may run off the screen when various adjustments are performed with [KEYSTONE].
- Various adjustments with [KEYSTONE] are possible to correct up to  $\pm 40^\circ$  for the tilt in vertical direction. However, the picture quality will degrade and it will get harder to focus with more correction. Install the projector so the correction will be as small as possible. (Correction can be made up to  $\pm 30^\circ$  when the fixed-focus lens (ET-DLE055) or the ultra short-focus zoom lens (ET-DLE080) is used.)
- Image size will also change when various adjustments are performed with [KEYSTONE].
- Trapezoidal distortion may occur depending on the lens shift position.
- Aspect ratio of the image size may shift depending on the correction or lens zoom value.

# [ADVANCED MENU]

Select [ADVANCED MENU] from the main menu, and select the item from the sub-menu. Refer to "Navigating through the menu" (▶ page 41) regarding the operation of the menu screen.

- After selecting the item, press ▲▼◀▶ to set.

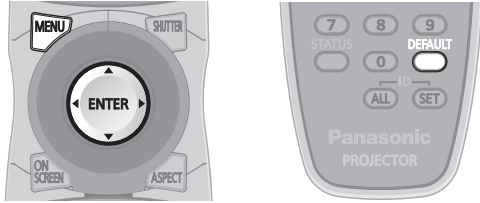

## [DIGITAL CINEMA REALITY]

You can increase the vertical resolution and enhance the picture quality by performing the cinema processing when the PAL (or the SECAM) 576i signal, the NTSC 480i, 1080/50i, and 1080/60i signals are input.

- 1) Press ▲▼ to select [DIGITAL CINEMA REALITY].
- 2) Press ◀▶ to switch [DIGITAL CINEMA REALITY].

- The setting will change as follows each time you press the button.

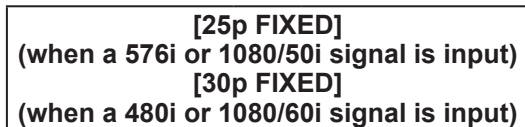
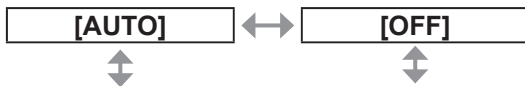

[AUTO]	Performs automatic detection and cinema processing. (Factory default)
[OFF]	Unforced cinema processing.
[25p FIXED]	Forced cinema processing (2:2 pulldown) is performed when a 576i or 1080/50i signal is input.
[30p FIXED]	Forced cinema processing (2:2 pulldown) is performed when a 480i or 1080/60i signal is input.

### Note

- In [DIGITAL CINEMA REALITY] mode, the picture quality will degrade when a signal other than the 2:2 pulldown is set as [25p FIXED] or [30p FIXED]. (Vertical resolution will degrade.)

## [BLANKING]

The blanking width is adjusted when there are noise at the edge of the screen or the image is slightly running out from the screen when an image from the VCR or other devices are projected.

- 1) Press ▲▼ to select [BLANKING].
- 2) Press the <ENTER> button.
  - The [BLANKING] adjustment screen is displayed.
- 3) Press ▲▼ to select the adjustment item.
- 4) Press ◀▶ to adjust the blanking.
  - Changes within the following range.

### For PT-DW730E

Left to right: 0 - 639  
Top to bottom: 0 - 399.

### For PT-DX800E

Left to right: 0 - 511  
Top to bottom: 0 - 383.

<b>When correcting the upper blanking of the screen (top)</b>	
Press ◀ to move the blanking zone upward. Press ▶ to move the blanking zone downward.	
<b>When correcting the lower blanking of the screen (bottom)</b>	
Press ▶ to move the blanking zone upward. Press ◀ to move the blanking zone downward.	
<b>When correcting the left hand blanking of the screen (left)</b>	
Press ▶ to move the blanking zone to the right. Press ◀ to move the blanking zone to the left.	
<b>When correcting the right hand blanking of the screen (right)</b>	
Press ◀ to move the blanking zone to the right. Press ▶ to move the blanking zone to the left.	

## [ADVANCED MENU]

### [INPUT RESOLUTION]

You can adjust to achieve an optimal image when there is a flickering image or smeared outlines.

- 1) Press ▲▼ to select [INPUT RESOLUTION].
- 2) Press the <ENTER> button.
  - The [INPUT RESOLUTION] screen is displayed.
- 3) Press ▲▼ to select [TOTAL DOTS], [DISPLAY DOTS], [TOTAL LINES], or [DISPLAY LINES], and press ◀▶ to adjust it.
  - Values corresponding to the input signal are displayed automatically for each item. Change the displayed values and adjust to the optimal point viewing the screen when there is a vertical banding or missing in the screen.

#### Note

- Previously mentioned vertical banding will not occur with all white signal input.
- The image may be disrupted while performing the adjustment, but it is not a malfunction.
- [INPUT RESOLUTION] can be adjusted only when an RGB signal is input in the <RGB 1 IN> terminal or the <RGB 2 IN> terminal.
- A signal with dot clock frequency with 150 MHz or higher cannot be adjusted.

### [CLAMP POSITION]

You can adjust the optimal point when the black part of the image is blunt or it has turned green.

- 1) Press ▲▼ to select [CLAMP POSITION].
- 2) Press ◀▶ to adjust the level.
  - Adjustment value will change between 0 and 255.
  - **Optimal value of clamp position adjustment**  
When the black part is blunt:  
The point where bluntness of the black part improves the most is the optimal value.  
When the black part is green:  
The point where the green part becomes black, and the bluntness has improved is the optimal value.

#### Note

- [CLAMP POSITION] can be adjusted only when a signal is input in <RGB 1 IN> or <RGB 2 IN>.

### [EDGE BLENDING]

The edge blending function allows multiple projector images to be seamlessly overlapped by using the inclination of the brightness at the overlapped area.

- 1) Press ▲▼ to select [EDGE BLENDING].
- 2) Press ◀▶ to switch [EDGE BLENDING].
  - The setting will change as follows each time you press the button.



[OFF]	Sets the edge blending function to off.
[ON]	Sets the edge blending function to on.

- 3) Press the <ENTER> button when [ON] is selected.
    - The [EDGE BLENDING] screen is displayed.
  - 4) Press ▲▼ to specify the location to be corrected.
    - When joining at top: Set [UPPER] to [ON].
    - When joining at bottom: Set [LOWER] to [ON].
    - When joining at left: Set [LEFT] to [ON].
    - When joining at right: Set [RIGHT] to [ON].
  - 5) Press ◀▶ to switch [ON] and [OFF].
  - 6) Press ▲▼ to select [START] or [WIDTH], and press ◀▶ to adjust the starting point and the overlap width.
- To display the adjustment marker
- 7) Press ▲▼ to select [MARKER].

**8) Press ◀▶ to switch [ON].**

- A marker for image position adjustment is displayed. The green line is the start point of edge blending adjusted with [START] in Step 6). The red line is the edge blending end point adjusted with [WIDTH] in Step 6). The position where the red and green lines overlap for the sets to join will be the optimal point. Make sure to set the correction width for the sets to join as the same value. Optimal joining is not possible with the sets with different correction widths.

The optimal point is where these lines overlap.

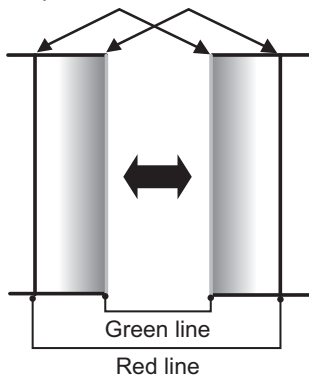

**9) Press ▲▼ to select [GAMMA].**

**10) Press ◀▶ to switch [GAMMA].**

- The setting will change as follows each time you press the button.

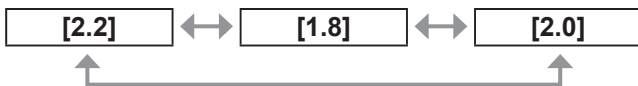

**11) Press ▲▼ to select [BRIGHT ADJUST].**

**12) Press the <ENTER> button.**

- The [BRIGHT ADJUST] screen is displayed.

**13) Press ▲▼ to select [BRIGHT INSIDE].**

**14) Press the <ENTER> button.**

- The [BRIGHT INSIDE] individual adjustment screen is displayed.
- When [INTERLOCKED] is set to [OFF], [RED], [GREEN], and [BLUE] can be adjusted.

**15) Press ▲▼ to select an item, and press ◀▶ to adjust the setting.**

- Once the adjustment is completed, press the <MENU> button to return to the [BRIGHT ADJUST] screen.

**16) Press ▲▼ to select [UPPER], [LOWER], [LEFT], or [RIGHT] from [OUTSIDE AREA].**

**17) Press ◀▶ to set the area (width) where [BRIGHT INSIDE] is adjusted.**

**18) Press ▲▼ to select [BRIGHT OUTSIDE].**

**19) Press the <ENTER> button.**

- The [BRIGHT OUTSIDE] individual adjustment screen is displayed.
- When [INTERLOCKED] is set to [OFF], [RED], [GREEN], and [BLUE] can be adjusted.

**20) Press ▲▼ to select an item, and press ◀▶ to adjust the setting.**

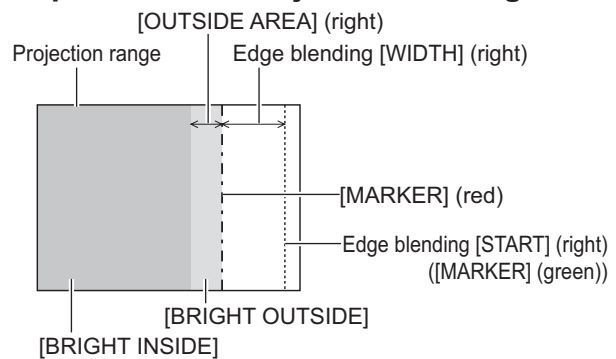

**Note**

- [BRIGHT ADJUST] is a function to make hard to notice the black level of the part of the image overlapping getting brighter when multiple screens are set using [EDGE BLENDING]. The optimal point of the correction is set by adjusting the [BRIGHT INSIDE] so the black level of the image overlapping area will become the same level as the non-overlapping area. If the bordering part of the part where the image is overlapping and the non-overlapping part gets brighter after adjusting [BRIGHT INSIDE], adjust the width of the top, bottom, left, or right. When only the bordering part became brighter by the width adjustment, adjust [BRIGHT OUTSIDE].
- The joining part may look discontinuous depending on the position you are looking from when a screen with high gain or rear screen is used.

## [RASTER POSITION]

This will allow the position of the image to move within the display area arbitrarily when the input image is not using the whole display area.

**1) Press ▲▼ to select [RASTER POSITION].**

**2) Press the <ENTER> button.**

- The [RASTER POSITION] screen is displayed.

**3) Press ▲▼◀▶ to adjust the position.**

# [DISPLAY LANGUAGE] menu

Select [DISPLAY LANGUAGE] from the main menu, and display the sub-menu.  
Refer to “Navigating through the menu” (➔ page 41) regarding the operation of the menu screen.

- Press ▲▼ to select the language, and press the <ENTER> button to set.

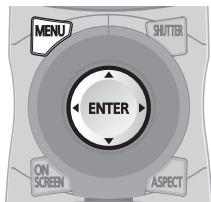

## Changing the display language

You can select the language of the on-screen display.

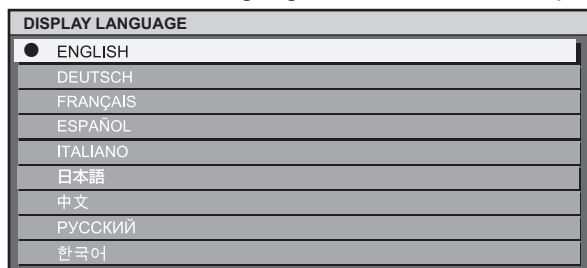

- Various menus, settings, adjustment screens, control button names, etc., are displayed in the selected language.
- Languages can be selected from English, German, French, Spanish, Italian, Japanese, Chinese, Russian, and Korean.

### Note

- The on-screen display language of the projector is set to English by default.



# [DISPLAY OPTION] menu

Select [DISPLAY OPTION] from the main menu, and select the item from the sub-menu. Refer to “Navigating through the menu” (➡ page 41) regarding the operation of the menu screen.

- After selecting the item, press ▲▼◀▶ to set.

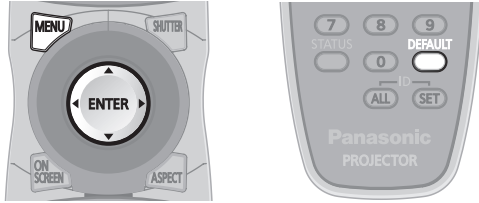

## [COLOR MATCHING]

You can correct the color difference between the sets when multiple sets are to be used simultaneously.

- 1) Press ▲▼ to select [COLOR MATCHING].
- 2) Press ◀▶ to switch [COLOR MATCHING].
  - The setting will change as follows each time you press the button.

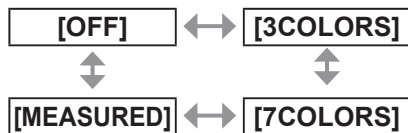

[OFF]	Color matching adjustment is not carried out.
[3COLORS]	[RED], [GREEN], and [BLUE] can be adjusted.
[7COLORS]	[RED], [GREEN], [BLUE], [CYAN], [MAGENTA], [YELLOW], and [WHITE] can be adjusted.
[MEASURED]	Refer to “Adjusting the color matching using a colorimeter” (➡ page 56) regarding details about this mode.

### ■ If [3COLORS] or [7COLORS] was selected in Step 2)

- 3) Press the <ENTER> button.
  - The [3COLORS] or [7COLORS] screen is displayed.
- 4) Press ▲▼ to select [RED], [GREEN], or [BLUE] (if [7COLORS] was selected, select [RED], [GREEN], [BLUE], [CYAN], [MAGENTA], [YELLOW], or [WHITE]).
- 5) Press the <ENTER> button.
  - The [3COLORS:RED], [3COLORS:GREEN], [3COLORS:BLUE], or [3COLORS:WHITE] screen is displayed. In case of the [7COLORS], [7COLORS:RED], [7COLORS:GREEN], [7COLORS:BLUE], [7COLORS:CYAN], [7COLORS:MAGENTA], [7COLORS:YELLOW], or [7COLORS:WHITE] screen is displayed.
- 6) Press ◀▶ to adjust the level.
  - The adjustment values will change between [0]<sup>\*1</sup> and [2048].
  - \*1: The minimum values differ depending on the color to adjust.

#### Note

- Operation when correcting the adjustment color  
When the correction color same as the adjustment color is changed:  
Luminance of the adjustment color will change.  
When correction color red is changed: Red is added to or subtracted from the adjustment color.  
When correction color green is changed: Green is added to or subtracted from the adjustment color.  
When correction color blue is changed: Blue is added to or subtracted from the adjustment color.
- This adjustment should be carried out by a person who is familiar with the projector or by a service person because a high level of skill is required to make a successful adjustment.
- Pressing the <DEFAULT> button will restore the factory default settings for all items.
- When any setting other than [OFF] has been selected for [COLOR MATCHING], [AI] and [COLOR CORRECTION] are fixed to [OFF], and [COLOR TEMPERATURE] is fixed to [USER]. (However, [WHITE BALANCE HIGH] cannot be adjusted.)



## [DISPLAY OPTION] menu

### ■ Adjusting the color matching using a colorimeter

[RED], [GREEN], [BLUE], [CYAN], [MAGENTA], [YELLOW], and [WHITE] can be set to preferred colors using the colorimeter that can measure the chromaticity coordinates and luminance.

#### ● Inputting the current luminance and chromaticity coordinates

- 1) Press ▲▼ to select [COLOR MATCHING].
- 2) Press ◀▶ to select [MEASURED].
- 3) Press the <ENTER> button.
  - The [MEASURED MODE] screen is displayed.
- 4) Press ▲▼ to select [MEASURED DATA].
- 5) Press the <ENTER> button.
  - The [MEASURED DATA] screen is displayed.
- 6) Measure the luminance (Y) and the chromaticity coordinates (x, y) using the colorimeter.
- 7) Press ▲▼ to select a color, and press ◀▶ to adjust the setting.
- 8) Once all the input is completed, press the <MENU> button.
  - The [MEASURED MODE] screen is displayed.

#### ● Inputting the coordinates of a desired color

- 1) Press ▲▼ to select [TARGET DATA].
- 2) Press the <ENTER> button.
  - The [TARGET DATA] screen is displayed.
- 3) Press ▲▼ to select the desired colors, and press ◀▶ to input their coordinates.
- 4) Once all the input is completed, press the <MENU> button.

#### Note

- Correct colors cannot be displayed when the target data is out of the color range for the projector.
- When [AUTO TESTPATTERN] is set to [ON], adjustment test pattern for the selected adjustment color is automatically displayed.
- When measuring the measurement data using a measurement device such as a colorimeter, start the measurement after setting [PICTURE MODE] to [DYNAMIC].
- There may be differences between the chromaticity coordinates of the target data and measured values of the colorimeter depending on the measurement device used and measurement environment.

## [COLOR CORRECTION]

You can adjust and register colors by input signals.

- 1) Press ▲▼ to select [COLOR CORRECTION].
- 2) Press ◀▶ to switch [COLOR CORRECTION].

[OFF]	Standard setting
[USER]	The six colors of red, green, blue, cyan, magenta, and yellow can be adjusted and registered for each of the four signal methods of VIDEO, S-VIDEO, RGB, and YP <sub>B</sub> P <sub>R</sub> /YC <sub>B</sub> C <sub>R</sub> . Set the details by pressing the <ENTER> button.

## [CONTRAST MODE]

There are two types of contrast modes. Set in accordance with the environment of usage.

- 1) Press ▲▼ to select [CONTRAST MODE].
- 2) Press ◀▶ to switch [CONTRAST MODE].

[NORMAL]	Sets the brightness to maximum.
[HIGH]	Sets the contrast to maximum.

## [SCREEN SETTING]

You can set the screen size.

You can correct to the optimal image position matching to the set screen when the aspect ratio of the projected image is changed. Set in accordance with the screen used.

- 1) Press ▲▼ to select [SCREEN SETTING].
- 2) Press the <ENTER> button.
  - The [SCREEN SETTING] screen is displayed.
- 3) Press ◀▶ to switch [SCREEN FORMAT].

### ■ PT-DW730E



### ■ PT-DX800E



- 4) Press ▲▼ to select [SCREEN POSITION].
- 5) Press ◀▶ to adjust [SCREEN POSITION].
  - In case of PT-DW730E, vertical positions can be adjusted between -40 and +40.
  - In case of PT-DX800E, vertical positions can be adjusted between -96 and +96.

#### Note

- [SCREEN POSITION] cannot be adjusted when [SCREEN FORMAT] is set to [16:10] for PT-DW730E, and when [SCREEN FORMAT] is set to [4:3] for PT-DX800E.

## [AUTO SIGNAL]

Image display positions can be automatically adjusted without pressing the <AUTO SETUP> button on the remote control every time, in cases that an unregistered signal is to be input frequently in a situation such as a conference.

- 1) Press ▲▼ to select [AUTO SIGNAL].
- 2) Press ◀▶ to switch [AUTO SIGNAL].



[OFF]	Turns off the auto signal function.
[ON]	Automatic setup is executed automatically when the projected image is changed to an unregistered signal.

## [AUTO SETUP]

You can set when adjusting a special signal or horizontally long (16:9, etc.) signal.

- 1) Press ▲▼ to select [AUTO SETUP].
- 2) Press the <ENTER> button.
  - The [AUTO SETUP] screen is displayed.
- 3) Press ◀▶ to switch [MODE].
  - The setting will change as follows each time you press the button.

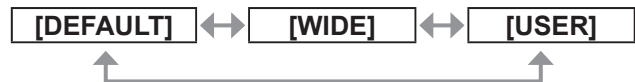

[DEFAULT]	Select when receiving a signal with the image aspect ratio of 4:3 or 5:4. (applicable resolution, 640 x 400, 640 x 480, 800 x 600, 832 x 624, 1 024 x 768, 1 152 x 864, 1 152 x 870, 1 280 x 960, 1 280 x 1 024, 1 600 x 1 200, 1 400 x 1 050.)
[WIDE]	Select when receiving a signal a with wide image aspect ratio. (applicable resolution, 1 280 x 720, 1 280 x 800, 1 440 x 900, 1 680 x 1 050, 1 920 x 1 080, 1 920 x 1 200.)
[USER]	Select when receiving a signal with a special horizontal resolution (number of display dots).

## [DISPLAY OPTION] menu

### ■ When selecting [DEFAULT] or [WIDE] in Step 3)

- 4) Press the <ENTER> button.
  - Automatic adjustment is executed. [PROGRESS] is displayed while automatically adjusting. When the adjustment is complete, the system returns to the [AUTO SETUP] screen.

### ■ When selecting [USER] in Step 3)

- 4) Press ▲▼ to select [DISPLAY DOTS] and press ◀▶ to adjust [DISPLAY DOTS] to the horizontal resolution of the signal source.
- 5) Press ▲▼ to select [MODE].
- 6) Press the <ENTER> button.
  - Automatic adjustment is executed. [PROGRESS] is displayed while automatically adjusting. When the adjustment is complete, the system returns to the [AUTO SETUP] screen.

## [DVI-D IN]

You can switch the setting when the external equipment is connected to the <DVI-D IN> terminal of the projector and the image is not projected correctly.

- 1) Press ▲▼ to select [DVI-D IN].
- 2) Press the <ENTER> button.
  - The [DVI-D IN] screen is displayed.
- 3) Press ▲▼ to select [DVI EDID].
- 4) Press ◀▶ to switch [DVI EDID].
  - The setting will change as follows each time you press the button.



[EDID3]	Switch between fine settings for a moving image and for a still image.
[EDID1]	Select this mainly when an external device (DVD player, etc.) for outputting video signals of a moving image system is connected to DVI-D IN.
[EDID2:PC]	Mainly use this when an external device (PC, etc.) for outputting video signals of a still image system is connected to DVI-D IN.

- 5) Press ▲▼ to select [DVI SIGNAL LEVEL].
- 6) Press ◀▶ to switch [DVI SIGNAL LEVEL].
  - The setting will change as follows each time you press the button.



[0-255:PC]	Select when the external equipment (computers, etc.) is connected via DVI terminal output.
[16-235]	Select when the external equipment (DVD players, etc.) is connected via HDMI terminal output using a conversion cable, etc.

### Note

- The optimal setting is different depending on the output setting of the connected external equipment. Refer to the instruction manual of the external equipment regarding the output of the external equipment.
- The data for Plug and play will change when the setting is changed. Refer to "List of compatible signals" (▶ page 102) for the resolution supporting the Plug and play.

## [ON-SCREEN DISPLAY]

You can set the on-screen display.

- 1) Press ▲▼ to select [ON-SCREEN DISPLAY].
- 2) Press the <ENTER> button.
  - The [ON-SCREEN DISPLAY] screen is displayed.
- 3) Press ▲▼ to select an item, and press ◀▶ to change the setting.

### ■ [OSD POSITION]

Set the position of the menu screen (OSD).

- The setting will change as follows each time you press the button.

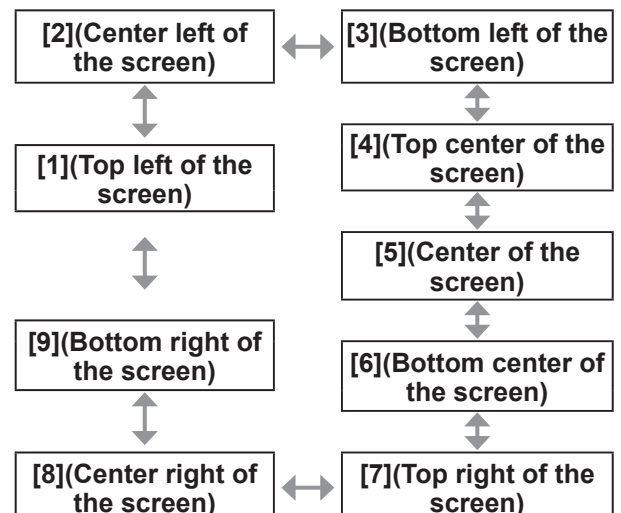

## ■ [OSD DESIGN]

You can set the color of the menu screen (OSD).

- The setting will change as follows each time you press the button.

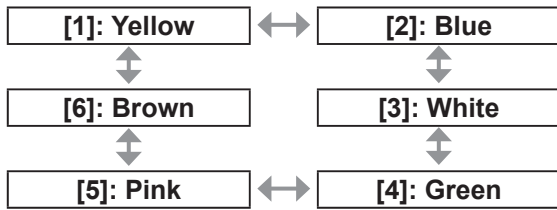

## ■ [OSD MEMORY]

You can be set whether to maintain the cursor position of the menu screen (OSD).

- The setting will change as follows each time you press the button.



### Note

- The cursor position will not be maintained when the <MAIN POWER> switch of the projector body is set to <OFF>, even if it is set to [ON].

## ■ [INPUT GUIDE]

You can set to display the input terminal name currently selected in the position set by the [OSD POSITION].

- The setting will change as follows each time you press the button.



## ■ [WARNING MESSAGE]

You can set the display/hide of the warning message.

- The setting will change as follows each time you press the button.



## [BACK COLOR]

You can set the color of the projected image when there is no signal input.

- 1) Press ▲▼ to select [BACK COLOR].
- 2) Press ◀▶ to switch [BACK COLOR].
  - The setting will change as follows each time you press the button



[BLUE]	The entire projection area appears blue.
[BLACK]	The entire projection area appears black.
[USER LOGO]	The picture registered by the user is projected.
[DEFAULT LOGO]	The Panasonic logo is projected.

### Note

- Separate software “Logo Transfer Software” is required to create and register the pictures of [USER LOGO]. Refer to the application software download from the website support information (<http://panasonic.net/avc/projector/software/>).

## [DISPLAY OPTION] menu

### [STARTUP LOGO]

You can set the logo display when the power is turned on.

- 1) Press ▲▼ to select [STARTUP LOGO].
- 2) Press ◀▶ to switch [STARTUP LOGO].
  - The setting will change as follows each time you press the button.

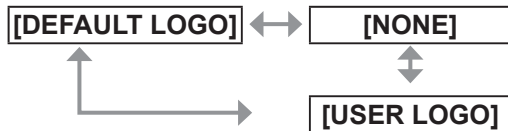

[DEFAULT LOGO]	The Panasonic logo is projected.
[NONE]	No startup logo is projected.
[USER LOGO]	The picture registered by the user is projected.

#### Note

- The startup logo will disappear in approximately 15 seconds.
- Separate software "Logo Transfer Software" is required to create and register the pictures of [USER LOGO]. Refer to the application software download from the website support information (<http://panasonic.net/avc/projector/software/>).

### [FREEZE]

The projected image is paused temporarily regardless of the playback of the external equipment.

- 1) Press ▲▼ to select [FREEZE].
- 2) Press the <ENTER> button.
  - To cancel the freeze, press the <MENU> button.

### [SIDE BY SIDE] (PT-DW730E only)

Two different input signals can be displayed simultaneously.

- 1) Press ▲▼ to select [SIDE BY SIDE].
- 2) Press the <ENTER> button.
  - Two images are displayed.

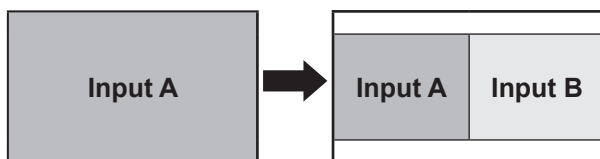

- 3) Press the <MENU> button.
  - The [SUB INPUT SELECT] screen is displayed.

- 4) Press ▲▼ to select the image to be displayed on the input B.
  - Press ▲▼ to select the image to be displayed at the right side of the screen (Input B).

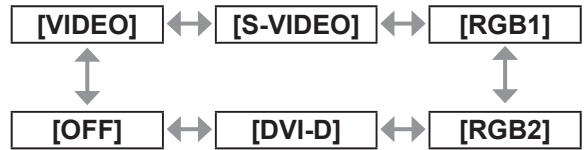

- 5) Press the <ENTER> button.

#### Note

- To cancel the two window display, select [OFF] and press the <ENTER> button.
- [FREEZE] will be set against the input A side.
- The adjustment and setting of the menu items cannot be performed during the two window display.
- Values for the input A side will be applied for the [PICTURE] settings. (Values for both input A and input B will be applied for [CONTRAST], [BRIGHTNESS], [COLOR], [TINT], and [SHARPNESS].)
- The two window display will maintain the aspect ratio selected using the <ASPECT> button on the remote control or the [ASPECT] setting.
- The two window display may not be available depending on the combination of the input signals. Refer to "Two window display combination list (PT-DW730E only)" (➔ page 101) for details.

# [PROJECTOR SETUP] menu

Select **[PROJECTOR SETUP]** from the main menu, and select the item from the sub-menu. Refer to “Navigating through the menu” (➔ page 41) regarding the operation of the menu screen.

- After selecting the item, press ▲▼◀▶ to set.

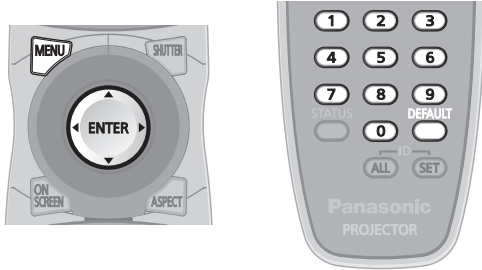

## [PROJECTOR ID]

The projector has an ID number setting function, and simultaneous control or individual control is possible with one remote control when multiple projectors are used side by side.

- 1) Press ▲▼ to select **[PROJECTOR ID]**.
- 2) Press ◀▶ to switch **[PROJECTOR ID]**.
  - The setting will change as follows each time you press the button.

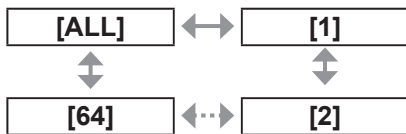

### Note

- The ID number can be set to [ALL] or [1] through [64].
- The ID number of the remote control needs to be matched with the ID number of the projector when the ID number is specified.
- When the ID number is set to [ALL], the projector will operate regardless of what number it is set on the remote control or the computer. If multiple projectors are used and some of them have their IDs set to [ALL], they cannot be controlled separately from the projectors with other ID numbers.
- Refer to “Setting Remote control ID numbers” (➔ page 20) regarding the method to set the ID number on the remote control.

## [PROJECTION METHOD]

You can set the projection method in accordance with the installation status of the projector. Change the projection method if the screen display is upside down or inverted.

- 1) Press ▲▼ to select **[PROJECTION METHOD]**.
- 2) Press the <ENTER> button.
  - The **[PROJECTION METHOD]** screen is displayed.
- 3) Press ▲▼ to select the projection method.

<b>[FRONT/FLOOR]</b>	When installing on the desk, etc., in front of the screen
<b>[FRONT/CEILING]</b>	When installing using the ceiling mount bracket (optional accessories) in front of the screen
<b>[REAR/FLOOR]</b>	When installing on the desk, etc., behind the screen (using a translucent screen)
<b>[REAR/CEILING]</b>	When installing using the ceiling mount bracket (optional accessories) behind the screen (using a translucent screen)

- 4) Press the <ENTER> button.
- 5) When the confirmation is displayed, select **[OK]** or **[CANCEL]**, and press the <ENTER> button.

### Attention

- When **[PROJECTION METHOD]** is changed, confirm that **[COOLING CONDITION]** (➔ page 62) is set correctly.

## [HIGH ALTITUDE MODE]

If you use the projector at elevations (1 400 m (4 593 ft) to 2 700 m (8 858 ft)), the **[HIGH ALTITUDE MODE]** setting needs to be **[ON]**.

- 1) Press ▲▼ to select **[HIGH ALTITUDE MODE]**.
- 2) Press ◀▶ to switch **[HIGH ALTITUDE MODE]**.
  - The setting will change as follows each time you press the button.



<b>[OFF]</b>	When using at a place lower than 1 400 m (4 593 ft) above sea level
<b>[ON]</b>	When using at a high altitude (1 400 m (4 593 ft) or higher and lower than 2 700 m (8 858 ft) above sea level)



## [PROJECTOR SETUP] menu

- When the confirmation is displayed, select [OK] or [CANCEL], and press the <ENTER> button.

### Note

- The speed of the fan is raised and the operation sound will become louder when this is set to [ON].

## [COOLING CONDITION]

You can change the fan control depending on the direction of projection. Set [COOLING CONDITION] correctly in accordance with the direction of projection referencing the following figure. It may shorten the life of the lamp if used in incorrect setting.

- Press ▲▼ to select [COOLING CONDITION].
- Press the <ENTER> button.
  - The [COOLING CONDITION] screen is displayed.
- Press ▲▼ to select the cooling condition.

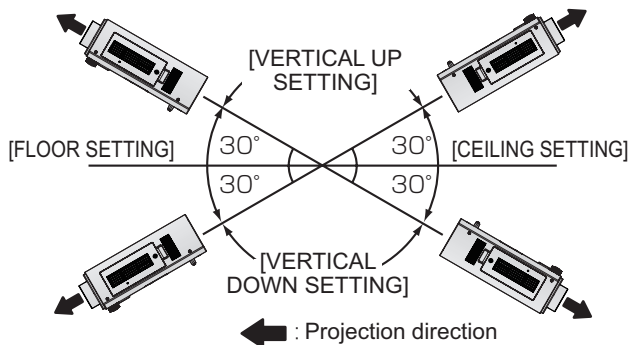

- Press the <ENTER> button.
- When the confirmation is displayed, select [OK] or [CANCEL], and press the <ENTER> button.

## [LAMP SELECT]

You can set the brightness using the two luminous lamps built inside the projector to dual-lamp or single-lamp brightness in accordance with the condition or purpose of the usage. Setting [SINGLE] automatically switches the lamp to be turned on based on the duration of use.

- Press ▲▼ to select [LAMP SELECT].
- Press ◀▶ to switch [LAMP SELECT].
  - The setting will change as follows each time you press the button.

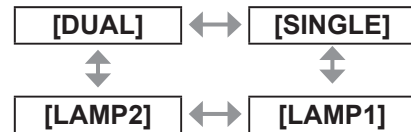

[DUAL]	Two lamps will light.
[SINGLE]	One lamp will light. (The lamp with shorter duration of use is automatically selected.)
[LAMP1]	Lamp unit 1 will light continuously.
[LAMP2]	Lamp unit 2 will light continuously.

- Press the <ENTER> button.

### Note

- In the [SINGLE], [LAMP1] or [LAMP2] mode, one lamp remains off or the currently active lamp exceeds 2 000 hours of cumulative operating time (when [HIGH] is selected as the [LAMP POWER] setting), the other lamp will light. In the [DUAL] mode, one lamp remains off or the currently active lamp exceeds 2 000 hours of cumulative operating time (when [HIGH] is selected as the [LAMP POWER] setting), the other lamp alone will light. However, if both lamps remain off or the 2 000 hours of cumulative operating time (when [HIGH] is selected as the [LAMP POWER] setting).
- The text colors of the items indicate the status.
  - Green → Current setting
  - Yellow → Current setting (When there is a lamp that cannot turn on or failed to turn on)
  - Red → Lamp that has failed to turn on
  - White → Any other status
- If the projector is repeatedly used for short periods of time, the lamps will need to be replaced more frequently.



## [LAMP RELAY]

The degradation of the lamp due to continuous usage can be reduced by automatically switching the lamp to be turned on when using the projector continuously for 22 hours or more.

- 1) Press ▲▼ to select [LAMP RELAY].
- 2) Press ◀▶ to switch [LAMP RELAY].
  - The time setting to switch the lamp will change as follows each time you press the button.

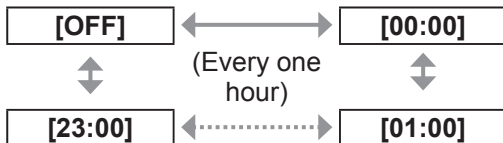

### Note

- The “LAMP RELAY” function will be enabled when [LAMP SELECT] is set to [DUAL] or [SINGLE].
- Only one lamp is turned on for four hours after the set time when [LAMP SELECT] is set to [DUAL].
- The operating time will be the local time. (➡ page 65)

## [LAMP POWER]

You can switch the brightness of the lamp in accordance with the environment or purpose of usage of the projector.

- 1) Press ▲▼ to select [LAMP POWER].
- 2) Press ◀▶ to switch [LAMP POWER].
  - The setting will change as follows each time you press the button.



[HIGH]	Set when high luminance is necessary.
[LOW]	Set when high luminance is not necessary.

### Note

- When set to [LOW], the reduction of power consumption, less operation sound, and longer life of the lamp can be achieved.

## [STANDBY MODE]

You can set the power consumption during the standby.

- 1) Press ▲▼ to select [STANDBY MODE].
- 2) Press ◀▶ to switch [STANDBY MODE].
  - The setting will change as follows each time you press the button



### Note

- When set to [ECO], the network function and the <SERIAL OUT> terminal is not available during the standby. Also, some of the RS-232C command will not be available. When set to [NORMAL], the network function and the <SERIAL OUT> terminal will be available during the standby.
- When set to [ECO], the time it takes to start the projection may become approximately ten seconds slower than compared to when set to [NORMAL].

## [RS-232C]

You can set the communication condition of the <SERIAL IN>/<SERIAL OUT> terminals.

- 1) Press ▲▼ to select [RS-232C].
- 2) Press the <ENTER> button.
- 3) Press ▲▼ to select the communication condition.
- 4) Press ◀▶ to set it.

### Note

- Refer to “Serial terminal” (➡ page 98).

# [PROJECTOR SETUP] menu

## [REMOTE2 MODE]

You can set the <REMOTE 2 IN> terminal.

- 1) Press ▲▼ to select [REMOTE2 MODE].
- 2) Press ◀▶ to switch [REMOTE2 MODE].
  - The setting will change as follows each time you press the button.



[DEFAULT]	The pin assignment of the <REMOTE 2 IN> terminal is used by the factory default setting of the projector. (➔ page 100)
[USER]	Used to change the setting of the <REMOTE 2 IN> terminal.

### ■ When selecting [USER] in Step 2)

- 3) Press the <ENTER> button.
- 4) Press ▲▼ to select an item from [PIN2] to [PIN8], and press ◀▶ to switch the setting.

## [STATUS]

Displays the status of the projector.

- 1) Press ▲▼ to select [STATUS].
- 2) Press the <ENTER> button.
- 3) Press ◀▶ to switch the pages.

[INPUT]	Displays the input terminal currently selected.
[NAME]	Displays the input signal name.
[SIGNAL FREQUENCY]	Displays the frequency of the input signal.
[PROJECTOR RUNTIME]	Displays the operation hours of the projector.
[LAMP1]*1	Displays the lighting time of the lamp 1.
[LAMP2]*1	Displays the lighting time of the lamp 2.
[INTAKE AIR TEMP.]	Displays the status of the air intake temperature of the projector.
[OPTICS MODULE TEMP.]	Displays the status of the internal temperature of the projector.
[AROUND LAMP TEMP.]	Displays the status of the temperature around the lamps of the projector.
[PROJECTOR TYPE]	Displays the type of the projector.
[SERIAL NUMBER]	Displays the serial number of the projector.
[LAMP UNIT MODEL NO.]	Displays the model no. of the lamp unit.

[LAMP1 SERIAL NUMBER]	Displays the serial number of the lamp 1.
[LAMP2 SERIAL NUMBER]	Displays the serial number of the lamp 2.
[MAIN VERSION]	Displays the main version of the firmware of the projector.
[SUB VERSION]	Displays the sub version of the firmware of the projector.
[NETWORK VERSION]	Displays the network version of the projector.
[ON COUNT]	<ul style="list-style-type: none"> <li>● [POWER ON TIMES]: Displays the number of times the power is turned on.</li> <li>● [LAMP1 ON]: Displays the number of times the lamp 1 is turned on.</li> <li>● [LAMP2 ON]: Displays the number of times the lamp 2 is turned on.</li> <li>● [SHUTTER]: Displays the number of times the shutter function is used.</li> </ul>
[LAMP1]	Displays the details of the usage time.
[LAMP2]	Displays the details of the usage time.
[NUMBER OF ENTRY SIGNAL]	Displays the number of registered signals.
[REMOTE2 STATUS]	Displays the control status of the REMOTE2.

\*1: The lamp lighting time displayed is actual time. The following conversion is required to calculate the guideline for lamp replacement.

$$\left[ \begin{array}{l} \text{Time to replace the lamp} = \\ \text{The usage time when [LAMP POWER] is} \\ \text{set to [HIGH] +} \\ \text{(the usage time when [LAMP POWER] is} \\ \text{set to [LOW] x 2 } \div \text{ 3)} \end{array} \right]$$

### Note

- The contents of the status can be sent via E-mail when the <ENTER> button is pressed while the status is displayed.

## [PROJECTOR SETUP] menu

### [NO SIGNAL SHUT-OFF]

You can set the power of the projector automatically to standby if there is no input signal by the specified time.

- 1) Press ▲▼ to select [NO SIGNAL SHUT-OFF].
- 2) Press ◀▶ to switch [NO SIGNAL SHUT-OFF].

[DISABLE]	Disables [NO SIGNAL SHUT-OFF].
[10MIN.] - [90MIN.]	Allows you to set in ten minute intervals.

### [FUNCTION BUTTON]

You can set the <FUNCTION> button on the remote control.

- 1) Press ▲▼ to select [FUNCTION BUTTON].
- 2) Press the <ENTER> button.
- 3) Press ▲▼ to select the function.

[DISABLE]	Disables the <FUNCTION> button.
[SUB MEMORY]	Switches the sub memory. (➡ page 69)
[SYSTEM SELECTOR]	Switches the setting for [SYSTEM SELECTOR]. (➡ page 47)
[SYSTEM DAYLIGHT VIEW]	Switches the setting for [SYSTEM DAYLIGHT VIEW]. (➡ page 46)
[FREEZE]	Freezes the image temporarily. (➡ page 60)
[SIDE BY SIDE]*1	Switches to two window display. (➡ page 60)

\*1: Only for PT-DW730E

- 4) Press the <ENTER> button.

### [DATE AND TIME]

You can set the time zone, date, and time of the built-in clock of the projector.

- 1) Press ▲▼ to select [DATE AND TIME].
- 2) Press the <ENTER> button.
- 3) Press ▲▼ to select [TIME ZONE].
- 4) Press ◀▶ to switch [TIME ZONE].
- 5) Press ▲▼ to select [ADJUST CLOCK].
- 6) Press the <ENTER> button.
  - The [ADJUST CLOCK] screen is displayed.

- 7) Press ▲▼ to select the item to be set, and press ◀▶ to set the local date and time.

- 8) Press ▲▼ to select [APPLY], and press the <ENTER> button.
  - The setting of the time will be completed.

### [SAVE ALL USER DATA]

You can save the various setting values as a backup in the built-in memory of the projector.

- 1) Press ▲▼ to select [SAVE ALL USER DATA].
- 2) Press the <ENTER> button.
  - The [SECURITY PASSWORD] screen is displayed.
- 3) Enter the security password and press the <ENTER> button.
- 4) When the confirmation is displayed, select [OK] or [CANCEL], and press the <ENTER> button.
  - While data is saved, [PROGRESS] is displayed.

#### Note

- The setting of the image registered in [USER LOGO] will not be saved.

## [PROJECTOR SETUP] menu

### [LOAD ALL USER DATA]

You can load the various setting values saved as a backup in the built-in memory of the projector.

- 1) Press ▲▼ to select [LOAD ALL USER DATA].
- 2) Press the <ENTER> button.
  - The [SECURITY PASSWORD] screen is displayed.
- 3) Enter the security password and press the <ENTER> button.
- 4) When the confirmation is displayed, select [OK] or [CANCEL], and press the <ENTER> button.

#### Note

- The projector will go into the standby status to reflect the setting values when [LOAD ALL USER DATA] is executed.

### [INITIALIZE]

You can return various setting values to their factory default settings.

- 1) Press ▲▼ to select [INITIALIZE].
- 2) Press the <ENTER> button.
  - The [SECURITY PASSWORD] screen is displayed.
- 3) Enter the security password and press the <ENTER> button.
  - The [INITIALIZE] screen is displayed.
- 4) Press ▲▼ to select the item to initialize.

[ALL USER DATA]	Restores all the setting values including the registered signal, the network settings, E-mail settings, and the logo image to their factory default settings. The projector will go into the standby status to reflect the setting values.
[ENTRY SIGNAL]	Deletes all the setting values saved for each input signal. To delete only a part of the registered signal, perform the procedure described in "Deleting a registered data" (➡ page 68).
[NETWORK/E-MAIL]	Restores the network settings and the E-mail settings to their factory default settings.
[LOGO IMAGE]	Deletes the image registered in [USER LOGO].

- 5) Press the <ENTER> button.

- 6) When the confirmation is displayed, select [OK] or [CANCEL], and press the <ENTER> button.

### [SERVICE PASSWORD]

Used by a service person.

# [TEST PATTERN] menu

Select [TEST PATTERN] from the main menu. Refer to “Navigating through the menu” (➔ page 41) regarding the operation of the menu screen.

- Press ◀▶ to switch.

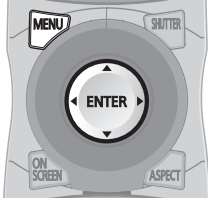

## [TEST PATTERN]

Displays the test pattern built-in to the projector. Results of position setting, size, etc. will not be reflected in the test patterns. Make sure to display the input signal before performing various adjustments.

Press ◀▶ to switch the various test patterns.

### ■ Display sequence of internal test patterns

The setting will change as follows each time you press ◀▶.

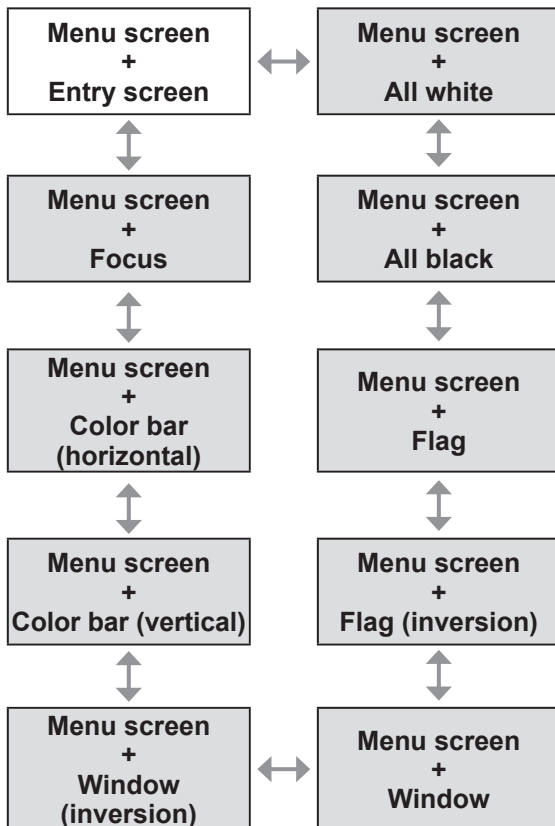

#### Note

- Press the <ON SCREEN> button on the remote control while the test pattern is displayed to hide the menu screen.

# [SIGNAL LIST] menu

Select [SIGNAL LIST] from the main menu. Refer to “Navigating through the menu” (➔ page 41) regarding the operation of the menu screen.

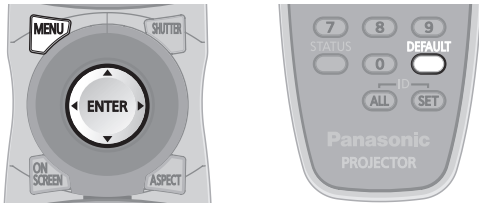

## Registered signal status

- The name can be set for each sub memory (➔ page 69).
- Memory number: A1 (1-2)

↑ ↑  
Sub memory number

When the address number (A1, A2, ... H7, H8) is registered

## Registering a signal to the list

After a new signal is input and the <MENU> button on the remote control or the control panel is pressed, the registration is completed and the [MAIN MENU] screen is displayed.

### Note

- Up to 96 signals including the sub memories can be registered to the projector.
- There are 12 pages (eight memories of A through L, with eight memories possible on each page) for memory numbers, and it is registered to the lowest number that is available. If there is no available memory number it will be overwritten from the oldest signal.
- The registration names are automatically determined by the input signals and the memory numbers.
- If a menu is being displayed, the new signals will be registered at the instant they are input.

## Renaming the registered data

- 1) Press ▲▼◀▶ to select the signal to display the details.
- 2) Press the <ENTER> button.
  - The [REGISTERED SIGNAL STATUS] screen is displayed.
  - The name, memory number, input terminal, frequency, synchronization signal, etc., of the input signal are displayed.
  - Press the <MENU> button to return to the [REGISTERED SIGNAL LIST] screen.
- 3) Press the <ENTER> button.
  - The [RENAME] screen is displayed.
- 4) Press ▲▼◀▶ to select a character to input and press the <ENTER> button to enter the character.
- 5) After changing the name, press ▲▼◀▶ to select [OK], and press the <ENTER> button.
  - The registration is completed and it will return to the [REGISTERED SIGNAL STATUS] screen.
  - If you press ▲▼◀▶ to select [CANCEL] and press the <ENTER> button, the changed signal name will not be registered and keep the signal name that was automatically registered.

## Deleting a registered data

- 1) Press ▲▼◀▶ to select the signal to delete.
- 2) Press the <DEFAULT> button.
  - The [ENTRY SIGNAL CLEAR] screen is displayed.
  - To cancel the deletion, press the <MENU> button to return to the [REGISTERED SIGNAL LIST] screen.
- 3) Press the <ENTER> button.
  - The selected signal will be deleted.

## Managing the sub memory list

The projector has a sub memory function that can register the multiple image adjustment data, even if it is recognized as the same signal by the frequency or format of the synchronization signal source.

Use this function when you need to adjust the picture quality such as switching of the aspect ratio or white balance by the same synchronization signal source.

The sub memory includes all the data that can be adjusted for each signal, such as the screen aspect ratio and data adjusted in the [PICTURE] item ([CONTRAST], [BRIGHTNESS], etc.).

### ■ Registering the current settings to the list

- 1) Press ◀▶ on the normal screen (when the menu is not displayed).
  - The sub memory registration confirmation screen is displayed if the sub memory is not registered. Go to Step 3).
  - A list of sub memories registered to the signal currently input is displayed.
  - By selecting [SUB MEMORY] in the [PROJECTOR SETUP] menu → [FUNCTION BUTTON], the <FUNCTION> button can be used instead of ◀▶ .
- 2) Press ▲▼◀▶ to select the sub memory number to register in [SUB MEMORY LIST].
- 3) Press the <ENTER> button.
  - The [RENAME] screen is displayed.
- 4) Press ▲▼◀▶ to select [OK] and press the <ENTER> button.
  - To rename the registered data, follow the procedure in Steps 4) and 5) in “Renaming the registered data” (➔ page 68).

### ■ Switching to the sub memory list

- 1) Press ◀▶ on the normal screen (when the menu is not displayed).
  - A list of sub memories registered to the signal currently input is displayed.
- 2) Press ▲▼◀▶ to select the signal to switch in [SUB MEMORY LIST].
- 3) Press the <ENTER> button.
  - It will switch to the signal selected in Step 2).

### ■ Deleting the sub memory data

- 1) Press ◀▶ on the normal screen (when the menu is not displayed).
  - The [SUB MEMORY LIST] screen is displayed.
- 2) Press ▲▼◀▶ to select the sub memory number to delete and press the <DEFAULT> button.
  - The [ENTRY SIGNAL CLEAR] screen is displayed.
  - To cancel the deletion, press the <MENU> button to return to the [REGISTERED SIGNAL LIST] screen.
- 3) Press the <ENTER> button.
  - The selected sub memory is deleted.



# [SECURITY] menu

Select [SECURITY] from the main menu, and select the item from the sub-menu.

Refer to “Navigating through the menu” (➔ page 41) regarding the operation of the menu screen.

- When the projector is used for the first time  
Initial password: Press ▲▶▼◀◀▶▶▼◀ in order, and press the <ENTER> button.
- After selecting the item, press ▲▶▼◀▶ to set.

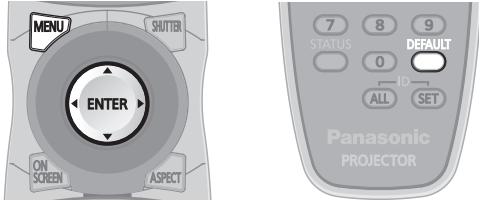

## Attention

- Make the settings after displaying the [SECURITY] screen.
- When the [SECURITY] screen is displayed, entering a password is required. Enter the set password and then continue operations.
- When the password has been changed previously, enter the changed password, and press the <ENTER> button.

## Note

- The entered password is displayed with \* mark on the screen.

## [SECURITY PASSWORD]

The [SECURITY PASSWORD] screen is displayed when the power is turned on. When the entered password is incorrect, the operation will be restricted to the STANDBY <⏻> button, the <SHUTTER> button, and the <LENS> (<FOCUS>, <ZOOM>, and <SHIFT>) buttons.

- 1) Press ▲▼ to select [SECURITY PASSWORD].
- 2) Press ◀▶ to switch [SECURITY PASSWORD].

- The setting will change as follows each time you press the button.



[OFF]	Disables the security password entry.
[ON]	Enables the security password entry.

## Note

- The [SECURITY PASSWORD] setting is set to [OFF] at the time of purchase or when all the user data has been initialized.
- Change the password periodically that is hard to guess.
- The security password is enabled after [SECURITY PASSWORD] is set to [ON] and the power is turned off (in the standby mode).

## [SECURITY PASSWORD CHANGE]

You can change the security password.

- 1) Press ▲▼ to select [SECURITY PASSWORD CHANGE].
- 2) Press the <ENTER> button.
  - The [SECURITY PASSWORD CHANGE] screen is displayed.
- 3) Press ▲▶▼◀▶ to set the password.
  - Up to eight button operations can be set.
- 4) Press the <ENTER> button.
- 5) Re-enter the password for the confirmation.
- 6) Press the <ENTER> button.

## Note

- The entered password is displayed with \* mark on the screen.
- An error message is displayed on the screen when the entered password is incorrect. Re-enter the correct password.

## [DISPLAY SETTING]

You can overlap the security message (text or image) over the projecting image.

- 1) Press ▲▼ to select [DISPLAY SETTING].
- 2) Press ◀▶ to switch [DISPLAY SETTING].
  - The setting will change as follows each time you press the button.

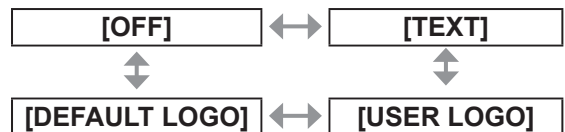

[OFF]	The text display is disabled.
[TEXT]	The text display is enabled.
[USER LOGO]	The picture registered by the user is projected.
[DEFAULT LOGO]	The Panasonic logo is projected.

## Note

- The logo is displayed on the whole screen in the normal projection condition when [DEFAULT LOGO] is set. Since the menu screen is displayed, it is not possible to see the whole image even if the logo display is canceled by pressing the <MENU> button.
- Separate software "Logo Transfer Software" is required to create and register the pictures of [USER LOGO]. Refer to the application software download from the website support information (<http://panasonic.net/avc/projector/software/>).

## [TEXT CHANGE]

You can change the text displayed when the text display is enabled by selecting [TEXT] in [DISPLAY SETTING].

- 1) Press ▲▼ to select [TEXT CHANGE].
- 2) Press the <ENTER> button.
  - The [TEXT CHANGE] screen is displayed.
- 3) Press ▲▼◀▶ to select the text, and press the <ENTER> button to enter the text.
  - Up to 22 characters can be entered.
- 4) Press ▲▼◀▶ to select [OK] and press the <ENTER> button.
  - The text is changed.

## [MENU LOCK]

You can set to enable/disable the menu operation by displaying the menu with the <MENU> button.

- 1) Press ▲▼ to select [MENU LOCK].
- 2) Press ◀▶ to switch [MENU LOCK].
  - The setting will change as follows each time you press the button.



[OFF]	Releases the lock of the menu operation.
[ON]	Locks the menu operation.

## Note

- The <MENU> button operations will be disabled when an incorrect password is entered after setting [MENU LOCK] to [ON].
- The password setting is set to [OFF] at the time of purchase or when [ALL USER DATA] is initialized.
- The unlock status is maintained until the projector is set to the standby mode.

## [MENU LOCK PASSWORD]

You can change the MENU LOCK PASSWORD.

- 1) Press ▲▼ to select [MENU LOCK PASSWORD].
- 2) Press the <ENTER> button.
  - The [MENU LOCK PASSWORD] screen is displayed.
- 3) Press ▲▼◀▶ to select the text, and press the <ENTER> button to enter the text.
  - Up to 16 characters can be entered.
- 4) Press ▲▼◀▶ to select [OK] and press the <ENTER> button.
  - Select [CANCEL] to stop.

## Attention

- The initial password when used for the first time or after initializing all the user data is "AAAA".
- Change the password periodically that is hard to guess.

## [CONTROL DEVICE SETUP]

You can enable/disable the button operations on the control panel and the remote control.

- 1) Press ▲▼ to select [CONTROL DEVICE SETUP].
- 2) Press the <ENTER> button.
  - The [CONTROL DEVICE SETUP] screen is displayed.
- 3) Press ▲▼ to select [CONTROL PANEL] or [REMOTE CONTROLLER].
- 4) Press the <ENTER> button.
  - The [CONTROL PANEL] or [REMOTE CONTROLLER] screen is displayed.

## ■ [CONTROL PANEL]

- You can set the limitation on the control from the control panel.

[ENABLE]	Enables the button operation from the main unit.
[DISABLE]	Disables the button operation from the main unit.

## [SECURITY] menu

### ■ [REMOTE CONTROLLER]

- You can set the limitation on the control from the remote control.

[ENABLE]	Enables the button operation from the remote control.
[DISABLE]	Disables the button operation from the remote control.

- 5) Press ▲▼ to select [ENABLE] or [DISABLE], and press the <ENTER> button.
- 6) When the confirmation is displayed, select [OK] or [CANCEL], and press the <ENTER> button.

#### Note

- When a button operation is performed on the device set to [DISABLE], the [SECURITY PASSWORD] screen is displayed. Enter the security password.
- The [SECURITY PASSWORD] screen will disappear when the <MENU> button is pressed or there is no operation for approximately ten seconds.
- The power cannot be turned off (the standby mode cannot be set) if the operations of both [CONTROL PANEL] and [REMOTE CONTROLLER] are set to [DISABLE].
- When the setting has completed, the menu screen will disappear. To operate continuously, press the <MENU> button to display the main menu.

# [NETWORK] menu

Select [NETWORK] from the main menu, and select the item from the sub-menu. Refer to “Navigating through the menu” (➡ page 41) regarding the operation of the menu screen.

- After selecting the item, press ▲▼◀▶ to set.

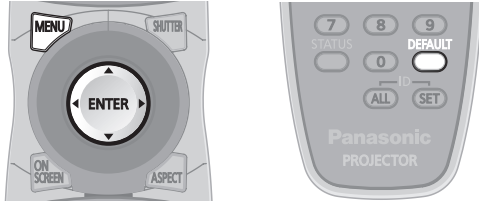

## [NETWORK SETUP]

Perform the initial setting of the network before using the network function.

- 1) Press ▲▼ to select [NETWORK SETUP].
- 2) Press the <ENTER> button.
  - The [NETWORK SETUP] screen is displayed.
- 3) Press ▲▼ to select an item, and change the settings according to the operation instructions of the menu.

[PROJECTOR NAME]	Change the setting when using a DHCP server.
[DHCP]	Set this to [ON] when using a DHCP server to acquire the IP address automatically. Set to [OFF] when not using a DHCP server.
[IP ADDRESS]	Enter the IP address when not using a DHCP server.
[SUBNET MASK]	Enter the subnet mask when not using a DHCP server.
[DEFAULT GATEWAY]	Enter the default gateway address when not using a DHCP server.
[STORE]	Save the current network settings.

- 4) Press ▲▼ to select [STORE], and press the <ENTER> button.
- 5) When the confirmation is displayed, select [OK] or [CANCEL], and press the <ENTER> button.

### Note

- When using a DHCP server, confirm that the DHCP server is running.
- Consult your network administrator regarding the IP address, subnet mask, and default gateway.

## [NETWORK CONTROL]

You can set up the control method of the network.

- 1) Press ▲▼ to select [NETWORK CONTROL].
- 2) Press the <ENTER> button.
  - The [NETWORK CONTROL] screen is displayed.
- 3) Press ▲▼ to select an item, and press ◀▶ to change the setting.

[WEB CONTROL]	Set to [ON] to control with the Web browser.
[PJLink CONTROL]	Set to [ON] to control with the PJLink protocol.
[COMMAND CONTROL]	Set to [ON] to control with the <SERIAL IN>/<SERIAL OUT> terminal control command format (➡ page 99). Refer to “Control commands via LAN” (➡ page 96).
[COMMAND PORT]	Set the port number used for command control.
[STORE]	Save the current network control settings.

- 4) Press ▲▼ to select [STORE], and press the <ENTER> button.
- 5) When the confirmation is displayed, select [OK] or [CANCEL], and press the <ENTER> button.

## [NETWORK STATUS]

Displays the status of the network for the projector body.

- 1) Press ▲▼ to select [NETWORK STATUS].
- 2) Press the <ENTER> button.
  - The [NETWORK STATUS] screen is displayed.

## [NETWORK] menu

### Network connections

The projector has a network function, and the following operations are available from the computer using the Web browser control.

- Setting and adjustment of the projector
- Display of the projector status
- Transmission of an E-mail message when there is a problem with the projector

#### Note

- A LAN cable is required to use the network function.

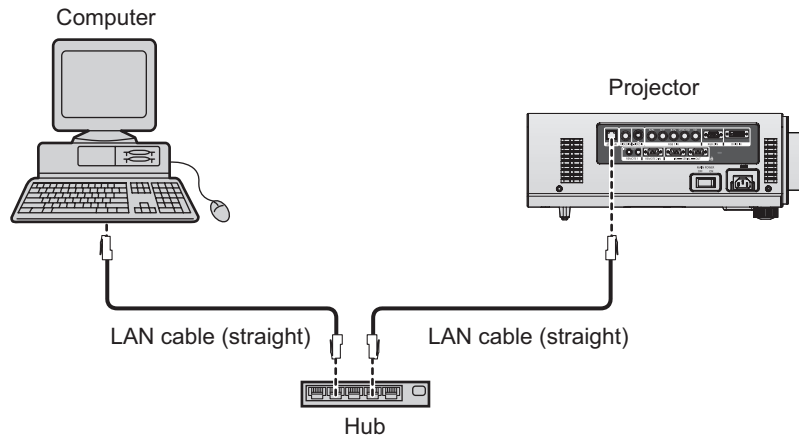

- A Web browser is required to use this function. Confirm that the Web browser can be used beforehand.  
Compatible OS: Windows XP/Windows Vista/Windows 7, Mac OS X v10.4/v10.5/v10.6  
Compatible browser: Internet Explorer 6.0/7.0/8.0, Safari 2.0/3.0/4.0 (Mac OS)
- Communication with an E-mail server is required to use the E-mail function. Confirm that the E-mail can be used beforehand.
- Use a LAN cable that is straight-through and compatible with category 5 or higher.
- Use a LAN cable with length of 100 m or shorter.

### Name and function of network function parts

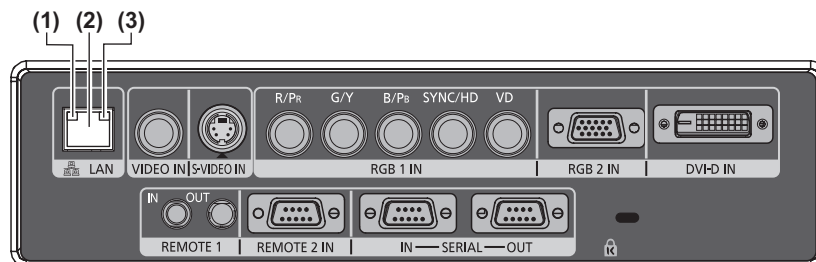

- (1) **LAN 10/100 lamp (yellow)**  
Lights on when connected to the 100BASE-TX.
- (2) **<LAN> terminal (10BASE-T/100BASE-TX)**  
Used to connect the LAN cable here.

- (3) **LAN LINK/ACT lamp (green)**  
Lights on when connected.  
Flashes when transmitting/receiving data.

#### Attention

- Connect the LAN to the indoor equipment.

## Accessing from the Web browser

- 1) Start up the Web browser on the computer.
- 2) Enter the IP address set on the projector into the URL entry field of the Web browser.
- 3) Enter the user name and the password.
  - The factory default setting of the user name is user1 (user rights)/admin1 (administrator rights) and the password is panasonic (lower case).



- 4) Click [OK].
  - The [Projector status] page is displayed.

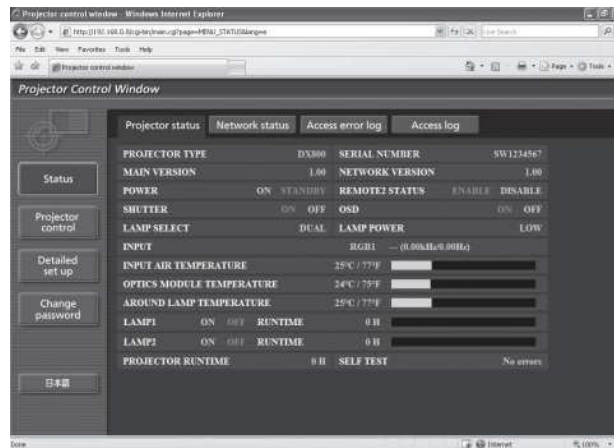

### Note

- When you wish to control the projector via the Web browser, set [WEB CONTROL] to [ON] in [NETWORK CONTROL] (➔ page 73).
- Do not perform setting or control simultaneously by starting up multiple Web browsers. Do not set or control the projector from multiple computers.
- Change the password first. (➔ page 86)
- The administrator rights allows to use all functions. The user rights only allows to use [Projector status] (➔ page 76), confirmation of the error information page (➔ page 77), [Network status] (➔ page 78), [Basic control] (➔ page 79), and [Change password] (➔ page 86).
- Access will be locked for few minutes when an incorrect password is entered three times consecutively.



# [NETWORK] menu

## Item description

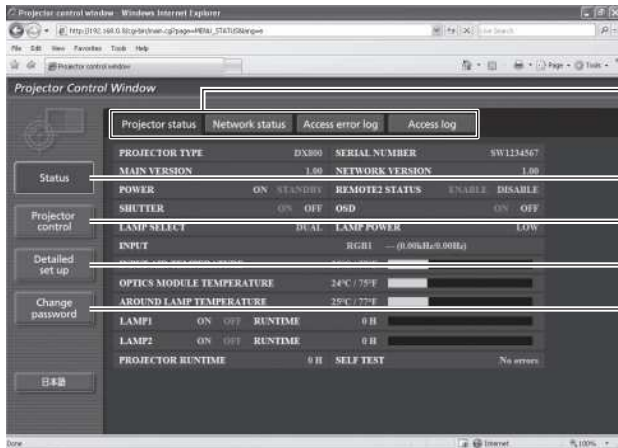

- (1) **Page switch tab**  
Click the tab to switch between pages.
- (2) **[Status]**  
The status of the projector is displayed by clicking this item.
- (3) **[Projector control]**  
The [Projector control] page is displayed by clicking this item.
- (4) **[Detailed set up]**  
The [Detailed set up] page is displayed by clicking this item.
- (5) **[Change password]**  
The [Change password] page is displayed by clicking this item.

## [Projector status] page

Click [Status] → [Projector status].  
Displays the status of the projector for the following items.

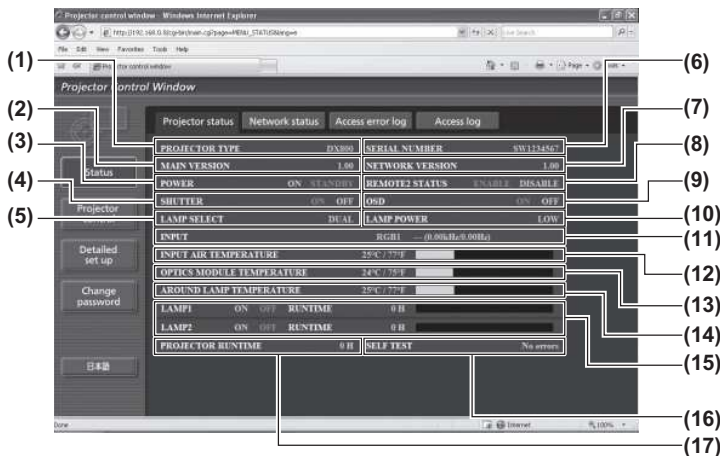

- (1) **[PROJECTOR TYPE]**  
Displays the type of the projector.
- (2) **[MAIN VERSION]**  
Displays the firmware version of the projector.
- (3) **[POWER]**  
Display the power status.
- (4) **[SHUTTER]**  
Displays the shutter status.
- (5) **[LAMP SELECT]**  
Displays the [LAMP SELECT] setting (▶ page 62).
- (6) **[SERIAL NUMBER]**  
Displays the serial number of the projector.
- (7) **[NETWORK VERSION]**  
Displays the network firmware version.
- (8) **[REMOTE2 STATUS]**  
Displays the control status of the <REMOTE 2 IN> terminal.
- (9) **[OSD]**  
Displays the on-screen display status.
- (10) **[LAMP POWER]**  
Displays the [LAMP POWER] setting (▶ page 63).
- (11) **[INPUT]**  
Displays the status of the input selection.
- (12) **[INPUT AIR TEMPERATURE]**  
Displays the status of the air intake temperature of the projector.
- (13) **[OPTICS MODULE TEMPERATURE]**  
Displays the status of the internal temperature of the projector.
- (14) **[AROUND LAMP TEMPERATURE]**  
Displays the status of the temperature around the lamp of the projector.
- (15) **[LAMP1]/[LAMP2]/[RUNTIME]**  
Displays the status and the usage time of the lamp.
- (16) **[SELF TEST]**  
Displays the self-diagnosis information.
- (17) **[PROJECTOR RUNTIME]**  
Displays the operation times of the projector.



## ■ Error information page

When [Error (Detail)] is displayed on the [Projector status] screen, click it to display the error details.

- The projector may go into the standby status to protect the projector depending on the contents of the error.

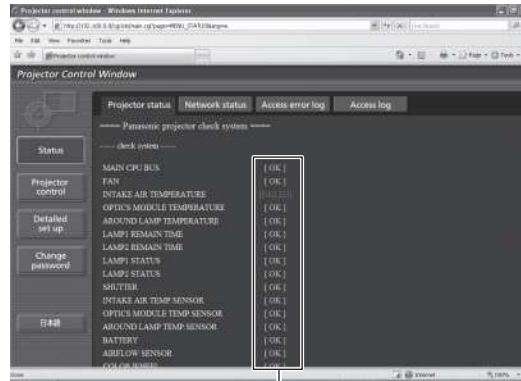
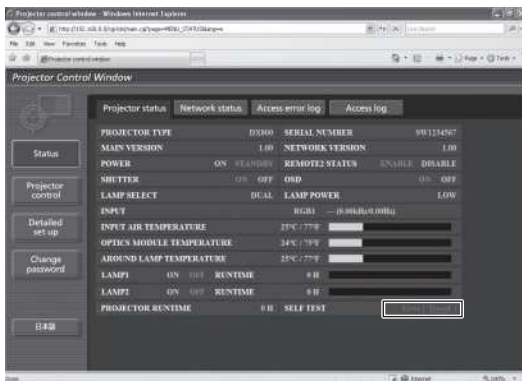

[OK]: Normal operation  
[FAILED]: Occurrence of trouble

## ● Description of problem occurrence [FAILED]:

Parameter	Description
[MAIN CPU BUS]	There is a problem with the microcomputer circuitry. Consult your dealer.
[FAN]	There is a problem with the fan or the fan drive circuit. Consult your dealer.
[INTAKE AIR TEMPERATURE]	The air intake temperature is too high. It may be used in an operating environment where the temperature is high, such as near a heating appliance.
[OPTICS MODULE TEMPERATURE]	The temperature inside the projector is high. It may be used in an operating environment where the temperature is high, such as near a heating appliance.
[AROUND LAMP TEMPERATURE]	The temperature around the lamp is high. The air exhaust port may be blocked.
[LAMP1 REMAIN TIME]	The usage time of the lamp has exceeded the specified time, and it is time to replace the lamp.
[LAMP2 REMAIN TIME]	
[LAMP1 STATUS]	The lamp has failed to turn on. Wait a while until the luminous lamp cools off, and then turn on the power.
[LAMP2 STATUS]	
[SHUTTER]	There is a problem with the shutter circuitry. Consult your dealer.
[INTAKE AIR TEMP.SENSOR]	There is a problem with the sensor used to detect intake air temperature. Consult your dealer.
[OPTICS MODULE TEMP.SENSOR]	There is a problem with the sensor used to detect temperature inside the projector. Consult your dealer.
[AROUND LAMP TEMP. SENSOR]	There is a problem with the sensor used to detect exhaust air temperature. Consult your dealer.
[BATTERY]	The battery replacement is required. Consult your dealer.
[AIRFLOW SENSOR]	There is a problem with the air volume sensor. Consult your dealer.
[COLOR WHEEL]	There is a problem with the color wheel or the color wheel drive circuit. Consult your dealer.
[COVER OPEN]	The attachment of the lamp unit cover is incomplete. Check the lamp unit cover. (➡ page 92)
[FILTER UNIT]	The air filter unit is not attached. Check the air filter unit. (➡ page 90)
[AIR FILTER]	There are too much dust accumulated in the air filter unit. Set the <MAIN POWER> switch (➡ page 35) to <OFF>, and clean the air filter (➡ page 89).

# [NETWORK] menu

## ■ [Network status] page

Click [Status] → [Network status].  
The current network setting status is displayed.

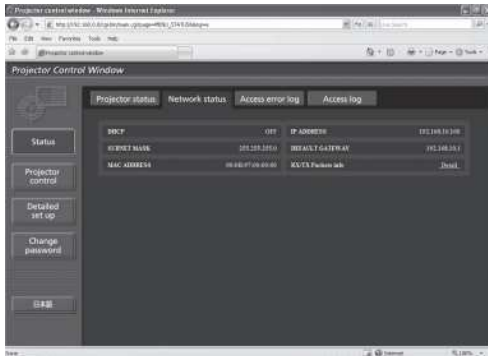

## ■ [Access error log] page

Click [Status] → [Access error log].  
The error log on the WEB server is displayed such as access to the pages that do not exist or access with unauthorized user names or passwords.

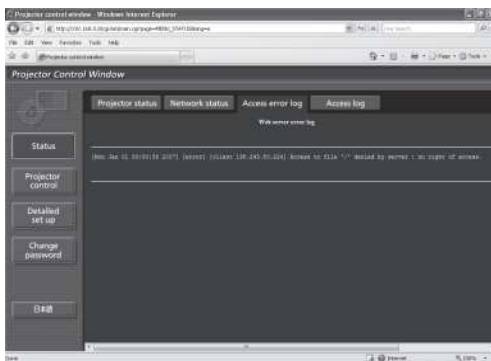

## ■ [Access log] page

Click [Status] → [Access log].  
The log such as user name accessed to the WEB control page, accessed IP address, accessed time is displayed.

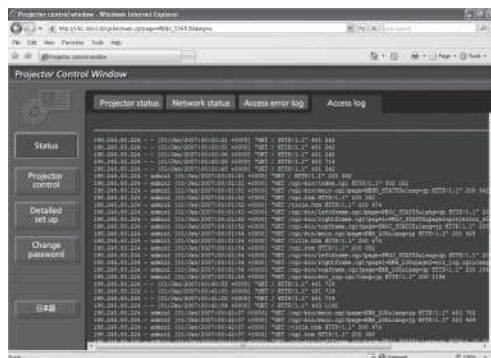

### Note

- [Access error log]/[Access log] will display the recent few thousand accesses/requests. If many accesses/requests are made at a time, some of them may not be found in the information.
- Confirm [Access error log]/[Access log] periodically.

## ■ [Basic control] page

Click [Projector control] → [Basic control].

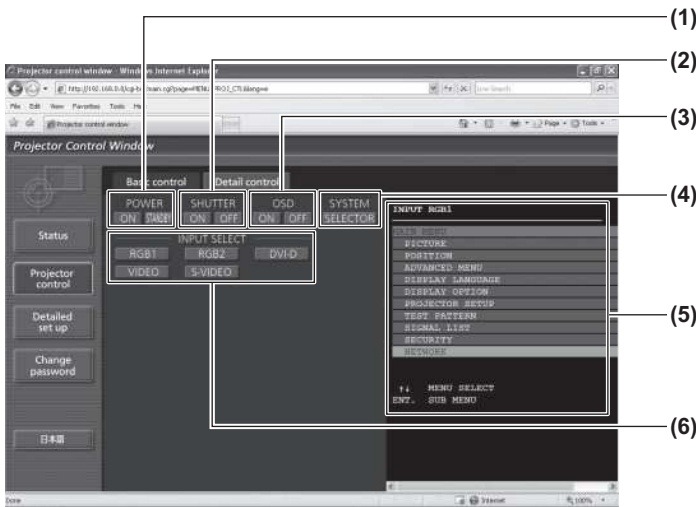

- (1) **[POWER] ([ON]/[STANDBY])**  
Switches between on/off of the power.
- (2) **[SHUTTER] ([ON]/[OFF])**  
Switches between use or not use of the shutter function.
- (3) **[OSD] ([ON]/[OFF])**  
Switches between on (display)/off (no display) of the on-screen display function.
- (4) **[SYSTEM] ([SELECTOR])**  
Switches the system method.
- (5) **On-screen display of the projector**  
The same contents as the on-screen display of the projector are displayed here. The confirmation and change of the setting contents of the menu can be performed. This is displayed even if the on-screen display function is set to off (no display).
- (6) **[INPUT SELECT] ([RGB1]/[RGB2]/[DVI-D]/[VIDEO]/[S-VIDEO])**  
Switches the input signal.

## ■ [Detail control] page

Click [Projector control] → [Detail control].

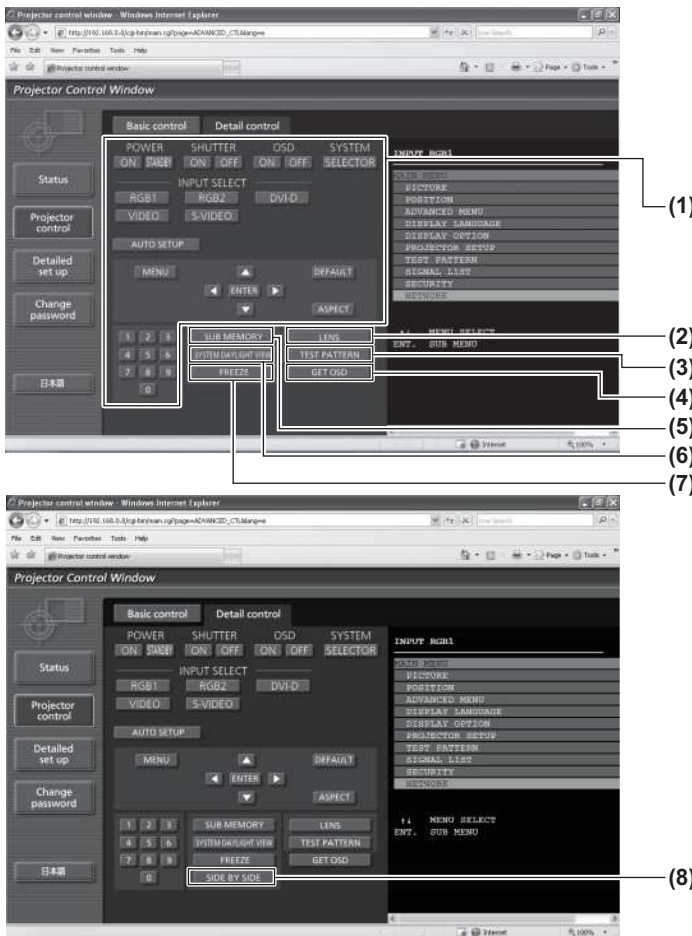

- (1) **Control of the projector**  
The projector is controlled by pressing the buttons as the buttons on the remote control. The on-screen display of the projector at the right of the control page is updated after the controlling.
- (2) **[LENS]**  
Adjusts the projection lens.
- (3) **[TEST PATTERN]**  
Displays the test pattern.
- (4) **[GET OSD]**  
Updates the on-screen display of the projector at the right of the control page.
- (5) **[SUB MEMORY]**  
Switch the sub memory
- (6) **[SYSTEM DAYLIGHT VIEW]**  
Switches the system daylight view settings.
- (7) **[FREEZE]**  
Turn the projected image to the still image temporarily.
- (8) **[SIDE BY SIDE] (PT-DW730E only)**  
Two different input signals can be displayed simultaneously.

# [NETWORK] menu

## ■ [Network config] page

Click [Detailed set up] → [Network config].

- The [CAUTION!] screen is displayed by clicking [Network config].
- The current settings are displayed by pressing the [Next] button.
- The following setting change screen is displayed by pressing the [Change] button.

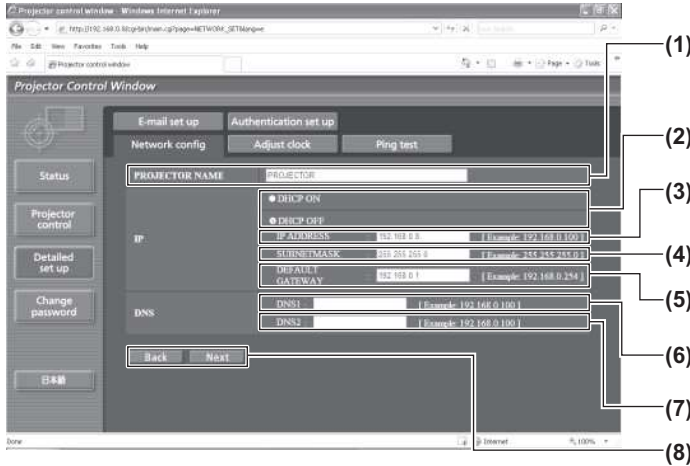

- (1) **[PROJECTOR NAME]**  
Enter the name of the projector. Also enter the host name if it is required when using a DHCP server, etc.
- (2) **[DHCP ON]/[DHCP OFF]**  
To enable the DHCP client function, set to [DHCP ON].
- (3) **[IP ADDRESS]**  
Enter the IP address when not using a DHCP server.
- (4) **[SUBNETMASK]**  
Enter the subnet mask when not using a DHCP server.
- (5) **[DEFAULT GATEWAY]**  
Enter the gateway address when not using a DHCP server.
- (6) **[DNS1]**  
Allowed characters for the entry of DNS 1 server address (primary):  
Numerics (0 - 9) and period (.)  
(Example: 192.168.0.253)
- (7) **[DNS2]**  
Allowed characters for the entry of DNS 2 server address (secondary):  
Numerics (0 - 9) and period (.)  
(Example: 192.168.0.254)
- (8) **[Back]/[Next]**  
Press [Next] to display the setting confirmation screen. Press [Submit] to update the settings.

## ■ [Adjust clock] page

Click [Detailed set up] → [Adjust clock].

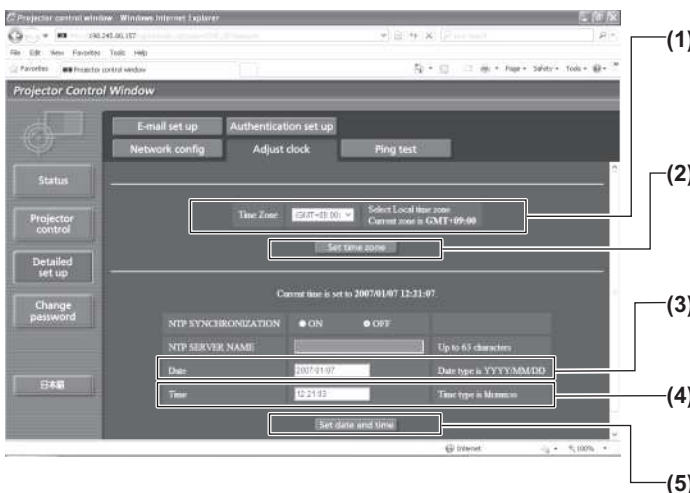

- (1) **[Time zone]**  
Selects the time zone.  
(Japan is GMT +09:00)
- (2) **[Set time zone]**  
Updates the time zone setting.
- (3) **[Date]**  
Enter the date to be changed.
- (4) **[Time]**  
Enter the time to be changed.
- (5) **[Set date and time]**  
Updates the date and time settings.

### Note

- The replacement of the battery inside the projector is required when the time goes out of alignment right after correcting the time. Please consult your dealer.

## ■ [Ping test] page

You can check whether the network is connected to the E-mail server, POP server, DNS server, etc. Click [Detailed set up] → [Ping test].

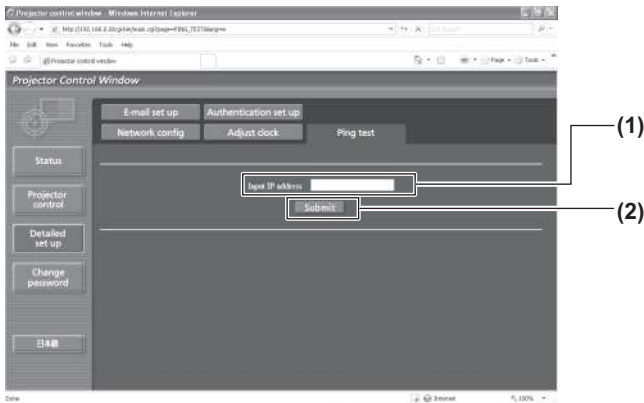

- (1) **[Input IP address]**  
Enter the IP address of the server to be tested.
- (2) **[Submit]**  
Executes the connection test.

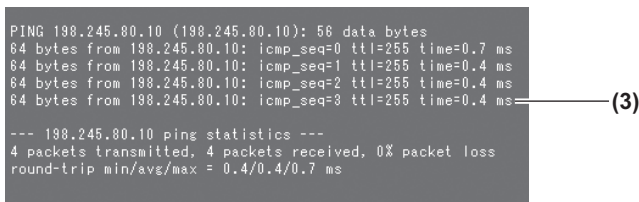

- (3) **Example of display when the connection has succeeded**
- (4) **Example of display when the connection has failed**

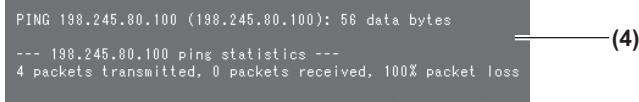

# [NETWORK] menu

## ■ [E-mail set up] page

An E-mail message can be sent to the E-mail address setup in advance (up to two addresses) when the problem occurred or the usage time of the lamp reached the specified value.

Click [Detailed set up] → [E-mail set up].

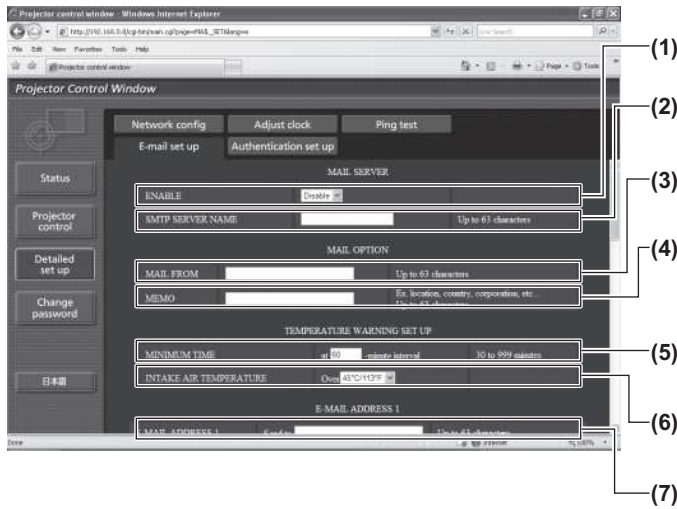

- (1) **[ENABLE]**  
Select [ENABLE] when using the E-mail function.
- (2) **[SMTP SERVER NAME]**  
Enter the IP address or the server name of the E-mail server (SMTP). To enter the server name, the setup of the DNS server is required.
- (3) **[MAIL FROM]**  
Enter the E-mail address of the projector. (Up to 63 characters in single byte)
- (4) **[MEMO]**  
You can enter information such as the location of the projector that notifies the sender of the E-mail. (Up to 63 characters in single byte)
- (5) **[MINIMUM TIME]**  
Change the minimum intervals for the temperature warning mail. The default value is 60 minutes. In this case, another E-mail will not be sent for 60 minutes after sending the temperature warning mail even if it reaches the warning temperature.
- (6) **[INTAKE AIR TEMPERATURE]**  
Change the temperature setting for the temperature warning mail. A temperature warning mail is sent when the temperature exceeds this value.
- (7) **[E-MAIL ADDRESS 1]**  
Enter the E-mail address to be sent.

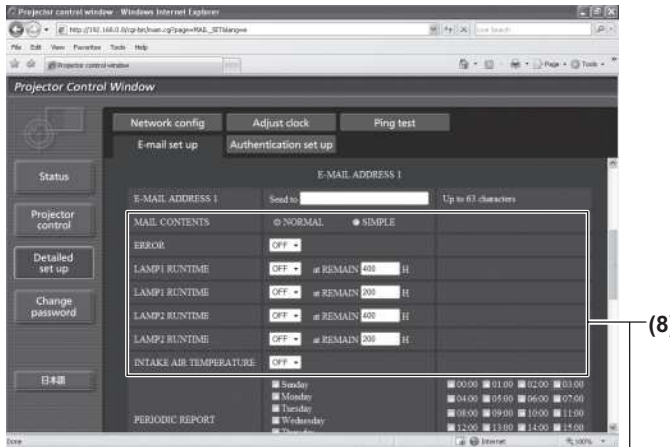

- (8) **Settings of the conditions to send E-mail**  
Select the conditions to send E-mail.  
  - [MAIL CONTENTS]:  
Select either [NORMAL] or [SIMPLE].
  - [ERROR]:  
An E-mail message is sent when an error occurred in the self-diagnosis.
  - [LAMP1 RUNTIME]:  
An E-mail message is sent when the remaining lamp on time for the lamp 1 has reached the value set at the right field.
  - [LAMP2 RUNTIME]:  
An E-mail message is sent when the remaining lamp on time for the lamp 2 has reached the value set at the right field.
  - [INTAKE AIR TEMPERATURE]:  
An E-mail message is sent when the air intake temperature has reached the value set at the above field.
  - [PERIODIC REPORT]:  
Place a check mark on this when E-mail is to be sent periodically.  
It will be sent on the days and time with the check mark.

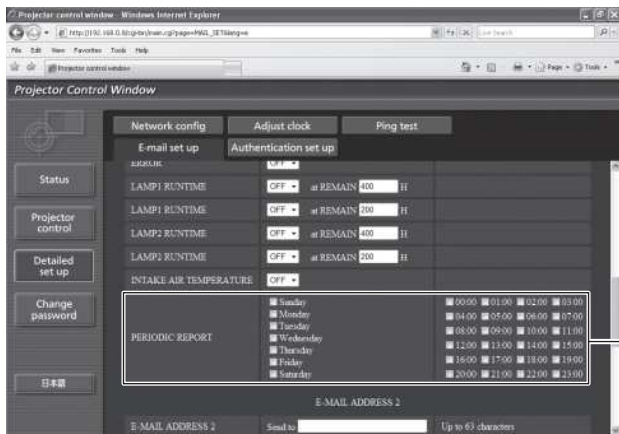



## [E-mail set up] page (continued)

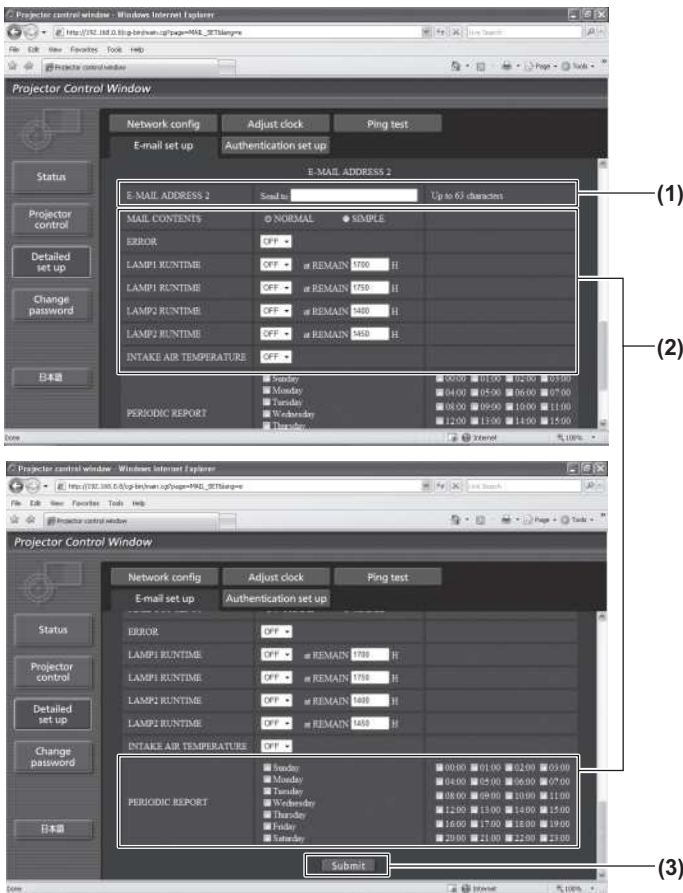

- (1) **[E-MAIL ADDRESS 2]**  
Enter the E-mail address to be sent when two E-mail addresses are to be used.  
Leave it blank when two E-mail addresses are not to be used.
- (2) **Settings of the conditions to send E-mail**  
Select the conditions to send E-mail to the second E-mail address.  
  - [MAIL CONTENTS]:  
Select either [NORMAL] or [SIMPLE].
  - [ERROR]:  
An E-mail message is sent when an error occurred in the self-diagnosis.
  - [LAMP1 RUNTIME]:  
An E-mail message is sent when the remaining lamp on time for the lamp 1 has reached the value set at the right field.
  - [LAMP2 RUNTIME]:  
An E-mail message is sent when the remaining lamp on time for the lamp 2 has reached the value set at the right field.
  - [INTAKE AIR TEMPERATURE]:  
An E-mail message is sent when the air intake temperature has reached the value set at the above field.
  - [PERIODIC REPORT]:  
Place a check mark on this when E-mail is to be sent periodically to the second E-mail address. It will be sent on the days and time with the check mark.
- (3) **[Submit]**  
Update the settings.



## ■ [Authentication set up] page

You can set the authentication items when POP authentication or SMTP authentication is necessary to send an E-mail message.

Click [Detailed set up] → [Authentication set up].

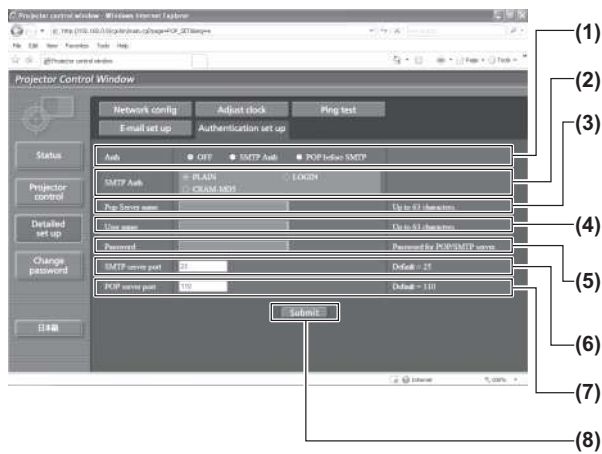

- (1) **[Auth]**  
Select the authentication method specified by your Internet service provider.
- (2) **[SMTP Auth]**  
Set when the SMTP authentication is selected.
- (3) **[Pop Server name]**  
Enter the POP server name.  
Allowed characters:  
Alphanumerics (A - Z, a - z, 0 - 9)  
Minus sign (-) and period (.)
- (4) **[User name]**  
Enter the user name for the POP server or the SMTP server.
- (5) **[Password]**  
Enter the password for the POP server or the SMTP server.
- (6) **[SMTP server port]**  
Enter the port number for the SMTP server.  
(Normally 25)
- (7) **[POP server port]**  
Enter the port number for the POP server.  
(Normally 110)
- (8) **[Submit]**  
Update the settings.

## ■ Contents of mail sent

### ● Example of E-mail sent when E-mail is set

The following E-mail is sent when the E-mail settings have been established.

```

=== Panasonic projector report(CONFIGURE) ===
Projector Type      : DX800
Serial No          : SH1234567

--- E-mail setup data ---
TEMPERATURE WARNING SETUP
MINIMUM TIME       at [ 60] minutes interval
INTAKE AIR TEMPERATURE Over [ 45C / 113F ]

ERROR              [ OFF ]
LAMP1 RUNTIME      [ OFF ] at REMAIN [ 400] H
LAMP1 RUNTIME      [ OFF ] at REMAIN [ 200] H
LAMP2 RUNTIME      [ OFF ] at REMAIN [ 400] H
LAMP2 RUNTIME      [ OFF ] at REMAIN [ 200] H
INTAKE AIR TEMPERATURE [ OFF ]
PERIODIC REPORT
Sunday [ OFF ] Monday [ OFF ] Tuesday [ OFF ] Wednesday [ OFF ]
Thursday [ OFF ] Friday [ OFF ] Saturday [ OFF ]

00:00 [ OFF ] 01:00 [ OFF ] 02:00 [ OFF ] 03:00 [ OFF ]
04:00 [ OFF ] 05:00 [ OFF ] 06:00 [ OFF ] 07:00 [ OFF ]
08:00 [ OFF ] 09:00 [ OFF ] 10:00 [ OFF ] 11:00 [ OFF ]
12:00 [ OFF ] 13:00 [ OFF ] 14:00 [ OFF ] 15:00 [ OFF ]
16:00 [ OFF ] 17:00 [ OFF ] 18:00 [ OFF ] 19:00 [ OFF ]
20:00 [ OFF ] 21:00 [ OFF ] 22:00 [ OFF ] 23:00 [ OFF ]

--- check system ---
MAIN CPU BUS       [ OK ]
FAN                [ OK ]
INTAKE AIR TEMPERATURE [ OK ]
OPTICS MODULE TEMPERATURE [ OK ]
AROUND LAMP TEMPERATURE [ OK ]

```

### ● Example of the E-mail sent for an error

The following E-mail is sent when an error has occurred.

```

=== Panasonic projector report(ERROR) ===
Projector Type      : DX800
Serial No          : SH1234567

--- check system ---
MAIN CPU BUS       [ OK ]
FAN                [ OK ]
INTAKE AIR TEMPERATURE [ OK ]
OPTICS MODULE TEMPERATURE [ OK ]
AROUND LAMP TEMPERATURE [ OK ]
LAMP1 REMAIN TIME  [ OK ]
LAMP2 REMAIN TIME  [ OK ]
LAMP1 STATUS      [ OK ]
LAMP2 STATUS      [ OK ]
SHUTTER           [ OK ]
INTAKE AIR TEMP.SENSOR [ OK ]
OPTICS MODULE TEMP.SENSOR [ OK ]
AROUND LAMP TEMP.SENSOR [ OK ]
BATTERY           [ OK ]
AIRFLOW SENSOR    [ OK ]
COLOR WHEEL       [ OK ]
COVER OPEN        [ OK ]
FILTER UNIT       [ FAILED ]
AIR FILTER        [ OK ]
(Error code 04 00 00 00 00 00 00)

Intake air temperature : 27 degC / 80 degF
Optics module temperature : 33 degC / 91 degF
Around lamp temperature : 32 degC / 89 degF
PROJECTOR RUNTIME 0 H
POWER ON          0 times
LAMP1 ON          0 times
LAMP1 LOW         0 H
LAMP1 HIGH        0 H
LAMP1 REMAIN      2000 H
LAMP2 ON          0 times
LAMP2 LOW         0 H
LAMP2 HIGH        0 H
LAMP2 REMAIN      2000 H

--- Current status ---
MAIN VERSION      1.00
NETWORK VERSION   1.00

```

# [NETWORK] menu

## ■ [Change password] page

Click [Change password].

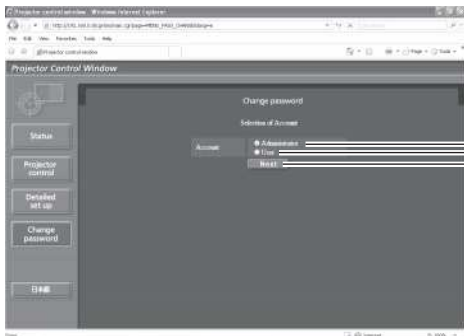

- (1) **[Administrator]**  
Select this when you change the [Administrator] setting.
- (2) **[User]**  
Select this when the [User] setting.
- (3) **[Next]**  
Displays the screen to change the password setting.

### ● [Administrator] account

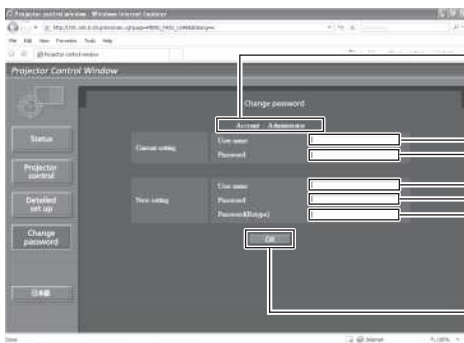

- (1) **[Account]**  
Displays the account to change.
- (2) **[Current setting] [User name]**  
Enter the user name before the change.
- (3) **[Current setting] [Password]**  
Enter the current password.
- (4) **[New setting] [User name]**  
Enter the desired new user name.
- (5) **[New setting] [Password]**  
Enter the desired new password.
- (6) **[New setting] [Password (Retype)]**  
Enter the desired new password again.
- (7) **[OK]**  
Determines the change of password.

### ● [User] account

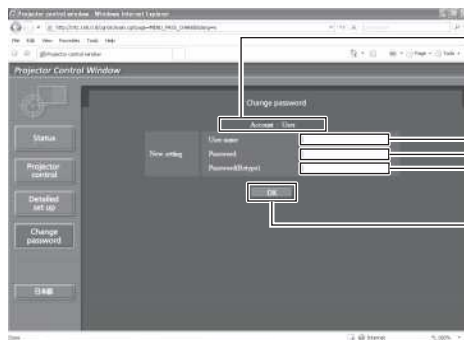

- (1) **[Account]**  
Displays the account to change.
- (2) **[New setting] [User name]**  
Enter the desired new user name.
- (3) **[New setting] [Password]**  
Enter the desired new password.
- (4) **[New setting] [Password (Retype)]**  
Enter the desired new password again.
- (5) **[OK]**  
Determines the change of password.

### ● [Change password] (when accessed by user rights)

Only the change of password is enabled under the user rights.

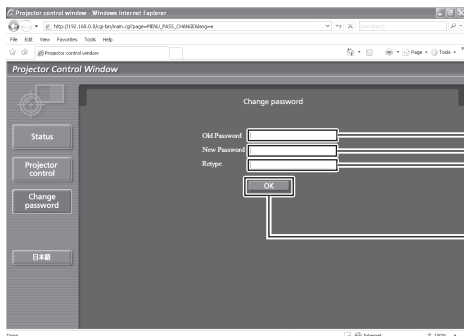

- (1) **[Old Password]**  
Enter the current password.
- (2) **[New Password]**  
Enter the desired new password.
- (3) **[Retype]**  
Enter the desired new password again.
- (4) **[OK]**  
Determines the change of password.

### Note

- To change the account of the administrator, it is required to enter [User name] and [Password] in [Current setting].

# LAMP/TEMP/FILTER Indicators

## Managing the indicated problems

If a problem should occur inside the projector, the lamp indicators <LAMP1>/<LAMP2>, the temperature indicator <TEMP>, and the filter indicator <FILTER> will inform you.

Manage the indicated problems as follow.

### Attention

- Before you take a remedial measure, follow the procedure of switching the power off indicated in “Powering off the projector” (➔ page 35).
- Check the power status with the power indicator <STANDBY (RED)/ON (GREEN)> (➔ page 33).

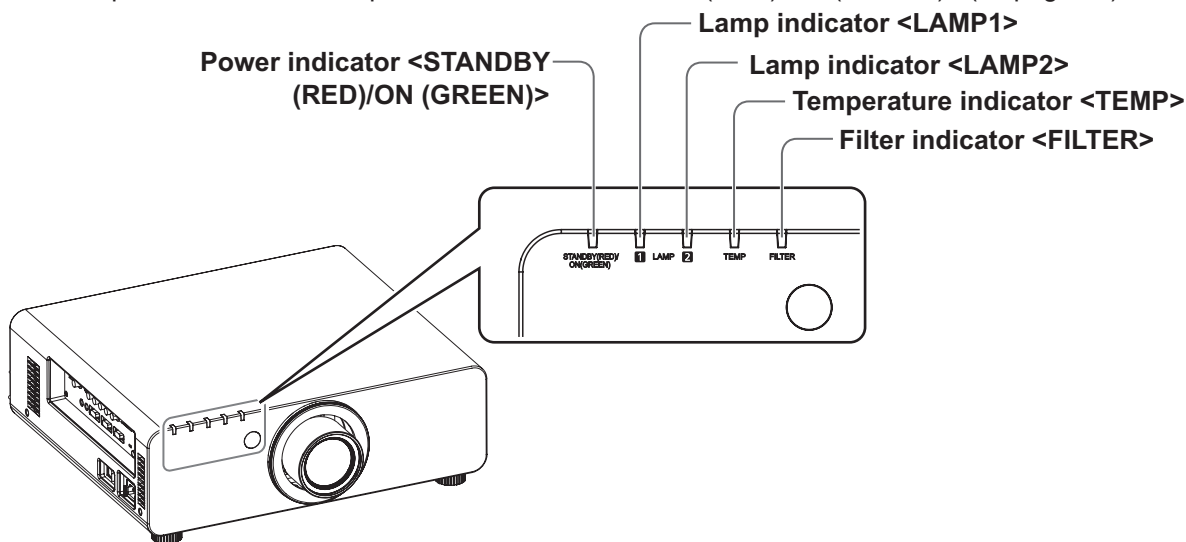

## Lamp indicator <LAMP1>/<LAMP2>

Lamp indication	Lighting in red	Blinking in red (once)	Blinking in red (3 times)	
Status	Indicates the time to replace the lamp unit.	The lamp unit is not installed.	A problem is detected in the lamp or the power supply for the lamp.	
Points to be checked	<ul style="list-style-type: none"> <li>● Is [REPLACE LAMP] displayed when you turned on the power?</li> </ul>	<ul style="list-style-type: none"> <li>● Is the lamp unit installed?</li> </ul>	<ul style="list-style-type: none"> <li>● Did you turn on the power again immediately after turning it off?</li> </ul>	<ul style="list-style-type: none"> <li>● Some error has arisen in the lamp circuit. Check for fluctuation (or drop) in the source voltage.</li> </ul>
Remedial measure	<ul style="list-style-type: none"> <li>● This indicator lights up when the lamp unit usage has reached 1 800 hours (when [LAMP POWER] is set to [HIGH]).</li> <li>● Replace the lamp unit.</li> </ul>	<ul style="list-style-type: none"> <li>● Install the lamp unit.</li> <li>● If the indicator is still blinking in red despite having installed a lamp unit, consult your dealer.</li> </ul>	<ul style="list-style-type: none"> <li>● Wait until the lamp has cooled off before turning on the power.</li> </ul>	<ul style="list-style-type: none"> <li>● Set the &lt;MAIN POWER&gt; switch to &lt;OFF&gt; (➔ page 35), and consult your dealer.</li> </ul>

### Note

- If the lamp indicators <LAMP1>/<LAMP2> are still lighting or blinking after taking the preceding measures, ask your dealer to repair the unit.

# LAMP/TEMP/FILTER Indicators

## Temperature indicator <TEMP>

Lamp indication	Lighting in red		Blinking in red (once)	Blinking in red (3 times)
Status	Warm-up status	Internal temperature is high. (WARNING)	Internal temperature is high. (Standby condition)	The cooling fan has been stopped.
Points to be checked	<ul style="list-style-type: none"> <li>Did you turn on the power when the ambient temperature was lower than approx. 0°C (32°F)?</li> </ul>	<ul style="list-style-type: none"> <li>Is the ventilating port (intake/exhaust) blocked?</li> <li>Is the room temperature too high?</li> <li>Is the filter indicator &lt;FILTER&gt; lit?</li> </ul>		—
Remedial measure	<ul style="list-style-type: none"> <li>Wait about five minutes in the current status.</li> <li>Install the unit in a location with an ambient temperature from 0°C (32°F) - 45°C (113°F)*1.</li> </ul>	<ul style="list-style-type: none"> <li>Remove any objects that are blocking the ventilating port (intake/exhaust).</li> <li>Move the projector to a temperature of 0°C (32°F) - 45°C (113°F) *1 and the humidity of 20% to 80% (no condensation).</li> </ul>		<ul style="list-style-type: none"> <li>Set the &lt;MAIN POWER&gt; switch to &lt;OFF&gt; (➡ page 35), and consult your dealer.</li> </ul>

\*1: When using the projector at high elevations 1 400 m (4 593 ft) – 2 700 m (8 858 ft) sea level, the temperature will be 5°C (41°F) lower than this higher limit.

### Note

- If the temperature indicator <TEMP> is still lighting or blinking after taking the preceding measures, ask your dealer to repair the unit.
- If the projector is used with the following two settings when the ambient temperature reaches 40°C (104°F) (35°C (95°F) in [HIGH ALTITUDE MODE]) or above, the light output may decrease by 20% to protect the projector.
  - [LAMP SELECT] is set to [DUAL] in the menu
  - [LAMP POWER] is set to [HIGH] in the menu

## Filter indicator <FILTER>

Lamp indication	Lighting in red			Blinking in red
Status	The filter is clogged. The ambient temperature or the internal temperature is extremely high.			The air filter unit is not attached.
Points to be checked	<ul style="list-style-type: none"> <li>Is the air filter unit dirt?</li> </ul>	<ul style="list-style-type: none"> <li>Is the ventilating port (intake/exhaust) blocked?</li> </ul>	<ul style="list-style-type: none"> <li>Is [HIGH ALTITUDE MODE] set correctly?</li> </ul>	<ul style="list-style-type: none"> <li>Is the air filter unit attached?</li> </ul>
Remedial measure	<ul style="list-style-type: none"> <li>Clean the air filter unit. (➡ page 89)</li> </ul>	<ul style="list-style-type: none"> <li>Remove any objects that are blocking the ventilating port (intake/exhaust).</li> </ul>	<ul style="list-style-type: none"> <li>When using the projector at high elevations 1 400 m (4 593 ft) – 2 700 m (8 858 ft) sea level, set [HIGH ALTITUDE MODE] (➡ page 61) to [ON].</li> <li>Do not use the projector at high elevations 2 700 m (8 858 ft) or higher sea level.</li> </ul>	<ul style="list-style-type: none"> <li>Attach the air filter unit.</li> </ul>

### Note

- If the filter indicator <FILTER> is still lighting or blinking after taking the preceding measures, ask your dealer to repair the unit.
- If the air filter unit is not attached when the power is turned on, the filter indicator <FILTER> will blink in red and the power will turn off after ten minutes.
- If the filter is clogged, only one lamp may light even when [LAMP SELECT] is set to [DUAL]. Clean the air filter unit or replace with new one.

# Maintenance/Replacement

## Before maintaining/replacing the unit

- Make sure to turn off the power before maintaining or replacing the unit. (➔ pages 32, 35)
- When turning off the power, make sure to follow the procedures in “Powering off the projector” (➔ page 35).

## Maintenance

### Outer case

Wipe off dirt and dust with a soft, dry cloth.

- If the dirt is persistent, soak the cloth with water and wring it thoroughly before wiping. Dry off the projector with a dry cloth.
- Do not use benzene, thinner, or rubbing alcohol, other solvents, or household cleaners. Using them may cause deterioration of the outer case.
- When using chemical treated dusters, follow the instructions.

### Front surface of the lens

Wipe off dirt and dust off the front surface of the lens with a soft clean cloth.

- Do not use a cloth that is fluffy, dusty, or soaked with oil/water.
- Do not use excessive force when wiping the lens as it is fragile.

### Attention

- Impacts or excessive force when wiping may scratch its surface. Please handle with care.

### Air filter unit

Perform maintenance of the air filter unit in the following cases.

- The air filter is clogged with dust, causing the filter replacement message to appear on the screen and the filter indicator <FILTER> to light in red.

#### 1) Remove the air filter cover.

- Use a Phillips screw driver to turn the air filter cover screw (one screw) counterclockwise until it turns freely, and then remove the air filter cover.

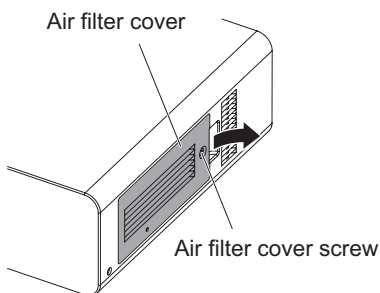

#### 2) Pull out the air filter unit.

- Hold the tabs on the air filter unit and pull out the air filter unit from the projector.

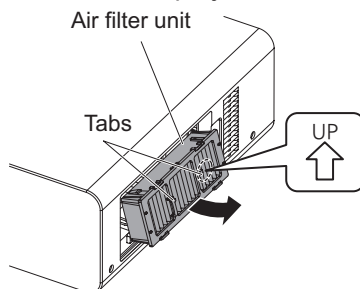

#### 3) Clean and dry the air filter unit.

##### ● Cleaning the air filter unit

- Soak the air filter unit in cold or warm water and then lightly rinse it.
  - Do not use cleaning tools such as brushes.
  - When rinsing, hold the frame of the air filter unit without putting strong pressure on the filter unit.
- Rinse the unit two to three times using fresh water each time.
  - Insufficient rinsing may result in odors.

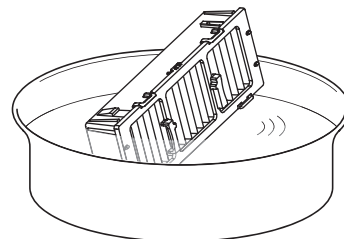

##### ● Drying the air filter unit

- Let the unit naturally dry off in a well-ventilated place where there is little dust and the unit is protected from direct sunlight.
- Do not dry using drying devices such as dryers.

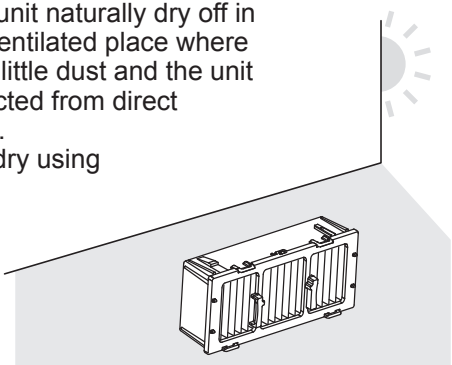

# Maintenance/Replacement

## 4) Attach the air filter unit to the projector.

- The air filter unit has vertical distinctions. (Check the direction of the allow )
- Perform Step 2) in the reverse order.

## 5) Attach the air filter cover to the projector and use a Phillips screwdriver to tighten the air filter cover screw.

- Perform Step 1) in the reverse order.

### Attention

- After washing the air filter unit, dry it thoroughly before attaching it back to the projector. Attaching a wet unit will cause an electric shock or malfunction.
- Do not disassemble the air filter unit.

### Note

- Make sure that the air filter is properly attached before using the projector. If it is not properly installed, the projector will suck in dirt and dust causing a malfunction which turns the power off after ten minutes. (The time remaining before the power is turned off is displayed in one minute intervals.)
- Replace the air filter unit with a replacement filter unit (ET-EMF300) if it is damaged or if the dirt does not come off even after washing.
- Air filter replacement is recommended after cleaning the unit two times.
- The dust-proof properties may reduce after each cleaning.

# Replacing the unit

## Air filter unit

If dirt does not come off even if the unit is maintained, it is time for the unit to be replaced. The replacement filter unit (ET-EMF300) is sold separately. To purchase the product, consult your dealer.

## Replacement of the air filter unit

### Attention

- Make sure to turn off the power before replacing the air filter unit.
- When replacing the unit, make sure that the projector is stable. Perform the replacement in a safe place where the projector will not be damaged even if you drop the air filter unit.

### 1) Remove the air filter cover.

- Use a Phillips screw driver to turn the air filter cover screw (one screw) counterclockwise until it turns freely, and then remove the air filter cover.

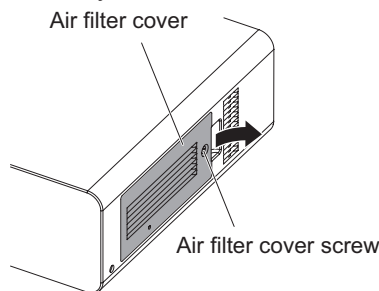

### 2) Pull out the air filter unit.

- Hold the tabs on the air filter unit and pull out the air filter unit from the projector.

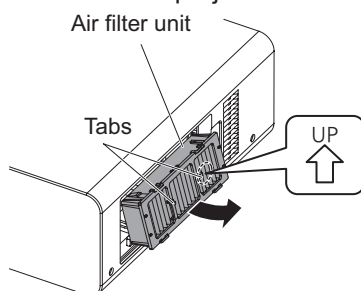

### 3) Attach the separately sold replacement filter unit (ET-EMF300) to the projector.

- The air filter unit has vertical distinctions. (Check the direction of the allow )
- Perform Step 2) in the reverse order.

### 4) Attach the air filter cover to the projector. Using a Phillips screwdriver, tighten the air filter cover screw.

- Perform Step 1) in the reverse order.

### Attention

- When turning the projector on, make sure that the air filter unit is installed before using the projector. If it is not properly installed, the projector will suck in dirt and dust causing a malfunction which turns the power off after ten minutes. (The time remaining before the power is turned off is displayed in one minute intervals.)

### Note

- The replacement cycle of the air filter unit varies greatly depending on the usage environment.



## Lamp unit

The lamp unit is a consumable component. Check the usage duration in the [PROJECTOR SETUP] menu → [STATUS] (➔ page 64) and perform regular replacement.

It is recommended that you request a qualified technician to replace the lamp unit. Consult your dealer. Consult your dealer to purchase a replacement lamp unit (ET-LAD60A: 1 pc, ET-LAD60AW: 2 pcs).

### Attention

- Do not replace the lamp unit when it is hot. (Wait at least one hour after use.) The inside of the cover can become very hot, take care to avoid burn injuries.

## Notes on the replacement of the lamp unit

- Since the luminous lamp is made of glass, it may burst if dropped or hit with a hard object. Please handle with care.
- A Phillips screwdriver is necessary when replacing the lamp unit.
- When replacing the lamp unit, be sure to hold it by the handle.
- The lamp may burst. Replace the lamp unit carefully so that the broken pieces of the lamp glass will not scatter. When the projector is mounted on the ceiling, do not make the replacement directly under the lamp unit or put your face near it.
- The lamp contains mercury. When disposing of used lamps, ask your nearest ward office or dealer about proper disposal of the unit.

### Attention

- Use only specified lamp units.
- The part numbers of accessories and separately sold components are subject to change without notice.

## When to replace the lamp unit

The lamp unit is a consumable component. Since its brightness gradually decreases over time, it is necessary to replace it regularly. The estimated duration before replacement is 2 000 hours. However, this may be shortened depending on individual lamp characteristics, usage conditions, and the installation environment. Therefore, it is strongly recommended that a replacement lamp unit be kept. The unit can damage the projector if it has not been replaced after 2 000 hours of usage. Thus, the lamp automatically turns off after approximately ten minutes.

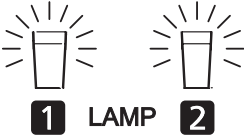
	On screen	Lamp indicator
		
<b>Over 1 800 hours</b>	The message is displayed for 30 seconds. Pressing any button on the control panel or remote control within 30 seconds will clear the message.	Lights in red even during the standby mode. (only the corresponding lamp lights up)
<b>Over 2 000 hours</b>	The message remains displayed until you press any button.	

### Note

- 2 000 hours of use is a rough guideline, but this is not a guarantee.

## ■ Replacing the lamp unit

### Attention

- When the projector is mounted on the ceiling, do not put your face near the lamp unit.
- Securely attach the lamp unit and lamp unit cover.
- If the lamp unit is not installed properly, remove it and then install it again. Pushing it in forcibly may break the connector.

1) Follow the procedures described in “Powering off the projector” (➔ page 35) to set the <MAIN POWER> switch to <OFF>, disconnect the power plug from the power outlet, and wait at least one hour, and then check if the lamp unit has cooled down.

2) Remove the lamp unit cover.

- (a) Use a Phillips screwdriver to loosen the lamp unit cover fixing screw (one screw) until it turns freely, and then open the lamp unit cover in the direction of the arrow.
- (b) Hold the lamp unit firmly, slide it towards the control buttons, then pull it out.

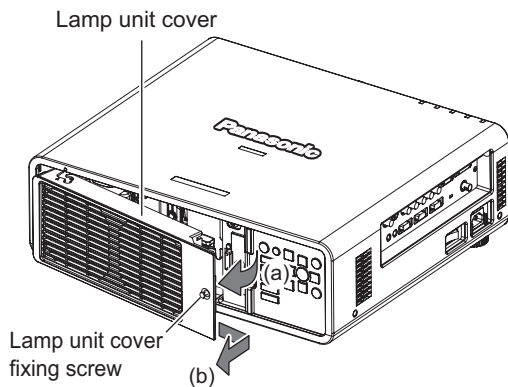

3) Use a Phillips screw driver to remove the lamp unit fixing screws (three screws each), and then holding the handles, pull out the lamp unit from the projector.

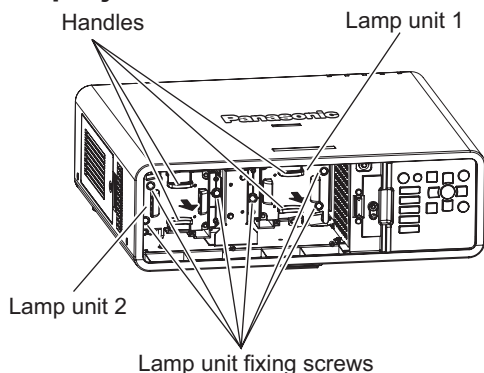

4) Carefully push the new lamp unit into the projector.

5) Use a Phillips screw driver to tighten the lamp unit fixing screws (three screws each).

6) Attach the lamp unit cover.

- (a) Attach the lamp unit cover by aligning the (i) and (ii) symbols (○ and △).
- (b) After sliding the lamp unit cover in the direction of the arrow and inserting it forward, securely tighten the lamp unit cover fixing screw.

- Make sure that the lamp unit cover connector is firmly inserted into the fan power connector.

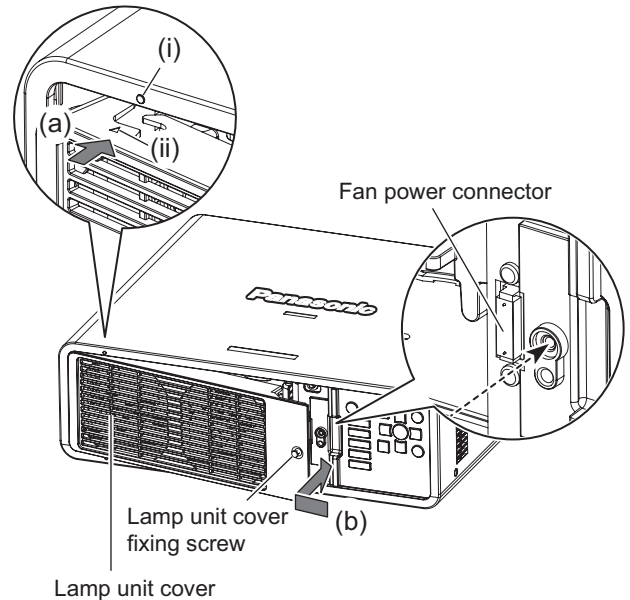

### Note

- When you replace the new lamp unit, the projector resets the total usage time of the lamp unit automatically.

# Troubleshooting

Review the following points. For details, see the corresponding pages.

Problems	Points to be checked	Reference page
<b>Power does not turn on.</b>	● Is the power plug firmly inserted into the outlet?	—
	● Is the <MAIN POWER> switch turned <OFF>?	35
	● Does the outlet in which the power plug is inserted have a supply of electricity?	—
	● Have the circuit breakers tripped?	—
	● Is the temperature indicator <TEMP> or the lamp indicators <LAMP1>/<LAMP2> lit or blinking?	87, 88
	● Is the lamp unit cover securely installed?	92
<b>No picture appears.</b>	● Is the connection to the picture (output) device correct?	30
	● Is the input selection setting correct?	38
	● Is the [BRIGHTNESS] adjustment setting at a minimum?	44
	● Is the external device that is connected to the projector working properly?	—
	● Is the shutter function in use?	38
<b>The picture is fuzzy.</b>	● Has the lens focus been set correctly?	36
	● Is the projection distance appropriate?	22
	● Is the lens dirty?	15
	● Is the projector installed perpendicular to the screen?	—
<b>The color is pale or grayish.</b>	● Are the [COLOR] and [TINT] adjusted correctly?	45
	● Is the device connected to the projector adjusted correctly?	30
	● Is the RGB cable damaged?	—
<b>The remote control does not operate.</b>	● Are the batteries depleted?	—
	● Is the polarity of the batteries set correctly?	20
	● Are there any obstructions between the remote control and the projector's remote control signal receiver?	17
	● Is the remote control being used beyond its effective operation range?	17
	● Are other forms of light, such as fluorescent lights, affecting the projection?	17
	● Is the [REMOTE CONTROLLER] setting in [CONTROL DEVICE SETUP] set to [DISABLE]?	71
	● Is the <REMOTE 2 IN> terminal used for external control?	100
	● Is the ID number setting correct?	20
<b>On screen menu does not appear.</b>	● Is the on-screen display function turned off (hidden)?	19, 38
<b>The control buttons of the projector do not operate.</b>	● Is the [CONTROL PANEL] setting in [CONTROL DEVICE SETUP] set to [DISABLE]?	71
	● Is the <REMOTE 2 IN> terminal used for external control?	100
<b>The picture does not display correctly.</b>	● Is the [SYSTEM SELECTOR] selection set correctly?	47
	● Is there a problem with the VCR or other picture sources?	—
	● Is the projector getting signals that it does not support?	102

# Troubleshooting

Problems	Points to be checked	Reference page
<b>Picture from a computer does not appear.</b>	<ul style="list-style-type: none"><li>● Is the cable too long? (Use a cable that is 10 m or shorter.)</li><li>● Is the external video output of the laptop computer set correctly? (Example: The external output settings may switch by pressing the [Fn] + [F3] or [Fn] + [F10] key simultaneously. Since the method varies depending on the computer type, refer to the user manual provided with your computer.)</li></ul>	— —
<b>Picture from a computer's DVI-D graphic board does not appear.</b>	<ul style="list-style-type: none"><li>● Is the [DVI-D IN] setting set to [EDID3]/[EDID2:PC]?</li><li>● The graphics accelerator driver of the computer may need to be updated to the latest version.</li><li>● The computer may need to be restarted after performing [DVI-D IN] settings.</li></ul>	58 — 58

## Attention

- If problems persist even after checking the preceding points, consult your dealer.

# Technical Information

## PJLink protocol

The network function of this projector supports the PJLink class 1, and the PJLink protocol can be used to perform projector setting and projector status query operations from a computer.

### Control commands

The following table lists the PJLink protocol commands that can be used to control the projector.

Command	Control details	Notes
POWR	Power supply control	Parameters 0 = Standby 1 = Power ON
POWR?	Power supply status query	Parameters 0 = Standby 2 = Cool-down in progress 1 = Power ON 3 = Warm-up in progress
INPT	Input selection	Parameters 11=RGB1    12=RGB2    21=VIDEO 22=S-VIDEO    31=DVI-D
INPT?	Input selection query	
AVMT	Shutter control	Parameters 30 = SHUTTER function off (picture mute canceled) 31 = SHUTTER function on (picture mute)
AVMT?	Shutter status query	
ERST?	Error status query	Parameters 1st byte: Indicates fan errors, range 0 - 2 2nd byte: Indicates lamp errors, range 0 - 2 3rd byte: Indicates temperature errors, range 0 - 2 4th byte: Indicates cover open errors, range 0 - 2 5th byte: Indicates filter errors, range 0 - 2 6th byte: Indicates other errors, range 0 - 2 Definitions for each value from 0 to 2 are as follows 0 = No error detected    1 = Warning    2 = Error
LAMP?	Lamp status query	Parameters 1st digits (1 - 5 digits): Lamp 1 cumulative operating time 2nd digit: 0 = Lamp 1 off, 1 = Lamp 1 on 3rd digits (1 - 5 digits): Lamp 2 cumulative operating time 4th digit: 0 = Lamp 2 off, 1 = Lamp 2 on
INST?	Input selection list query	Parameters are returned with the following values. "11 12 21 22 31"
NAME?	Projector name query	Returns the name set in [PROJECTOR NAME] of [NETWORK SETUP].
INF1?	Manufacturer name query	Returns "Panasonic".
INF2?	Model name query	Returns "DX800E" "DW730E".
INF0?	Other information query	Returns information such as version number.
CLSS?	Class information query	Returns "1".

### PJLink security authentication

The password used for PJLink is the same as that of the password set for web browser control. When using PJLink without security authentication, do not set a password for web browser control.

- For specifications regarding PJLink, refer to the Japan Business Machine and Information System Industries Association website.  
URL <http://pjlink.jbmia.or.jp/english/>

## Control commands via LAN

### ■ When WEB Control administrator rights password is set (Protect mode)

#### ● Connection method

#### 1) Obtain the IP address and port number (Initial set value = 1024) of the projector and request for a connection to the projector.

You can obtain both the IP address and the port number from the menu screen of the projector.

<b>IP address</b>	Obtain from MAIN MENU → [NETWORK] → [NETWORK STATUS]
<b>Port No.</b>	Obtain from MAIN MENU → [NETWORK] → [NETWORK CONTROL] → [COMMAND PORT]

#### 2) Check the projector's response.

Response data

Data section	Blank	Mode	Blank	Random number section	Termination symbol
"NTCONTROL" (ASCII string)	' '	'1'	' '	"ZZZZZZZ" (ASCII code hexadecimal number)	(CR) 0x0d
9 bytes	1 byte	1 byte	1 byte	8 bytes	1 byte

Mode: 1 = Protect mode

#### 3) Generate a 32-byte hash value from the following data using MD5 algorithm.

"xxxxxx:yyyyy:zzzzzzz"

<b>xxxxxx</b>	Administrator rights user name for WEB CONTROL (default user name is "admin1").
<b>yyyyy</b>	Password of above administrator rights user (default password is "panasonic").
<b>zzzzzzz</b>	8-byte random number obtained in Step 2)

#### ● Command transmission method

Transmit using the following command formats.

Transmitted data

Header			Data section	Termination symbol
Hash value (See above "Connection method")	'0'	'0'	Control command (ASCII string)	(CR) 0x0d
32 bytes	1 byte	1 byte	Undefined length	1 byte

Received data

Header			Data section	Termination symbol
'0'	'0'		Control command (ASCII string)	(CR) 0x0d
0x30	0x30		Undefined length	1 byte
1 byte	1 byte			

Error response

Error message		Termination symbol
"ERR1"	Undefined control command	(CR) 0x0d
"ERR2"	Out of parameter range	
"ERR3"	Busy state or no-acceptable period	
"ERR4"	Timeout or no-acceptable period	
"ERR5"	Wrong data length	
"ERRA"	Password mismatch	
	4 bytes	1 byte

## ■ When WEB Control administrator rights password is not set (Non-protect mode)

### ● Connection method

#### 1) Obtain the IP address and port number (Initial set value = 1024) of the projector and request for a connection to the projector.

You can obtain both the IP address and the port number from the menu screen of the projector.

<b>IP address</b>	Obtain from MAIN MENU → [NETWORK] → [NETWORK STATUS]
<b>Port No.</b>	Obtain from MAIN MENU → [NETWORK] → [NETWORK CONTROL] → [COMMAND PORT]

#### 2) Check the projector's response

##### Response data

Data section	Blank	Mode	Termination symbol
"NTCONTROL" (ASCII string) 9 bytes	' ' 0x20 1 byte	'0' 0x30 1 byte	(CR) 0x0d 1 byte

Mode: 0 = Non-protect mode

### ● Command transmission method

Transmit using the following command formats.

##### Transmitted data

Header		Data section	Termination symbol
'0' 0x30 1 byte	'0' 0x30 1 byte	Control command (ASCII string) Undefined length	(CR) 0x0d 1 byte

##### Received data

Header		Data section	Termination symbol
'0' 0x30 1 byte	'0' 0x30 1 byte	Control command (ASCII string) Undefined length	(CR) 0x0d 1 byte

##### Error response

Error message		Termination symbol
"ERR1"	Undefined control command	(CR) 0x0d 1 byte
"ERR2"	Out of parameter range	
"ERR3"	Busy state or no-acceptable period	
"ERR4"	Timeout or no-acceptable period	
"ERR5"	Wrong data length	
"ERRA"	Password mismatch	
4 bytes		



# Technical Information

## Serial terminal

The <SERIAL IN>/<SERIAL OUT> terminals on the side of the projector conform with RS-232C so that the projector can be connected to and controlled from a computer.

### ■ Connection

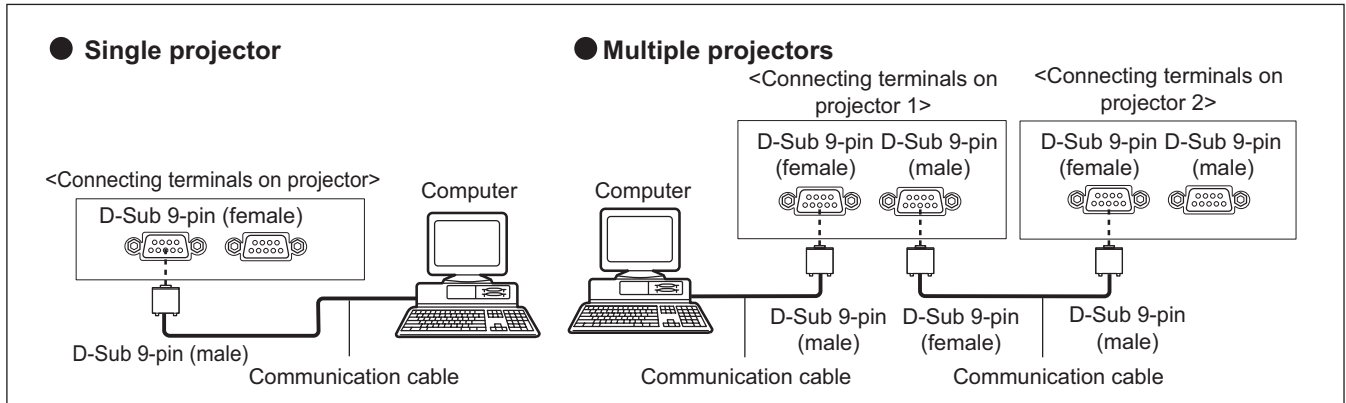

### ■ Pin assignments and signal names

D-Sub 9-pin (female) Outside view	Pin No.	Signal name	Details
		(1)	–
(2)		TXD	Transmitted data
(3)		RXD	Received data
(4)		–	Connected internally
(5)		GND	Earth
(6)		–	NC
(7)		CTS	Connected internally
(8)		RTS	
(9)		–	NC

D-Sub 9-pin (male) Outside view	Pin No.	Signal name	Details
		(1)	–
(2)		RXD	Received data
(3)		TXD	Transmitted data
(4)		–	NC
(5)		GND	Earth
(6)		–	NC
(7)		RTS	Connected internally
(8)		CTS	
(9)		–	NC

### ■ Communication conditions (Factory default settings)

<b>Signal level</b>	RS-232C-compliant
<b>Sync. method</b>	Asynchronous
<b>Baud rate</b>	9 600 bps
<b>Parity</b>	None

<b>Character length</b>	8 bits
<b>Stop bit</b>	1 bit
<b>X parameter</b>	None
<b>S parameter</b>	None

## Basic format

Transmission from the computer starts with STX, then the ID, command, parameter, and ETX are sent in this order. Add parameters according to the details of control.

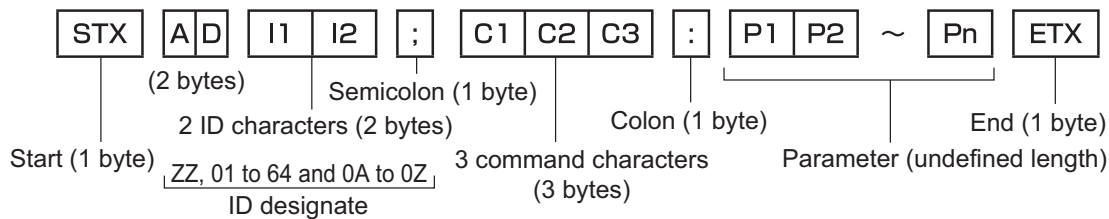

### Attention

- When a command is transmitted after the lamp turned on, there may be a delay in response or the command may not be executed. Try sending any command after 60 seconds.
- When transmitting multiple commands, be sure to wait until 0.5 seconds has elapsed after receiving the response from the projector before sending the next command. When transmitting a command which does not need a parameter, a colon (:) is not necessary.

### Note

- If a command cannot be executed, a “ER401” response is sent from the projector to the computer.
- If an invalid parameter is sent, a “ER402” response is sent from the projector to the computer.
- ID transmission in RS-232C supports ZZ (ALL) and the 01 to 64 and 0A to 0Z groups.
- If a command is sent with a specified ID, a response will be sent to the computer only in the following cases.
  - It matches the projector ID
  - ID setting is set to ALL and responding (ID ALL) is [ON]
  - ID setting is set to Group and responding (ID Group) is [ON]
- STX and ETX are character codes. STX shown in hexadecimal is 02, and ETX shown in hexadecimal is 03.

## Cable specifications

<When connected to a computer>

Projector (<SERIAL IN> terminal)	1	NC	NC	1	Computer (DTE specifications)
	2			2	
	3			3	
	4	NC	NC	4	
	5			5	
	6	NC	NC	6	
	7			7	
	8			8	
	9	NC	NC	9	

<When connected multiple projectors>

Projector 1 (<SERIAL OUT> terminal)	1	NC	NC	1	Projector 2 (<SERIAL IN> terminal)
	2			2	
	3			3	
	4	NC	NC	4	
	5			5	
	6	NC	NC	6	
	7			7	
	8			8	
	9	NC	NC	9	

## Control commands

The following table lists the commands that can be used to control the projector using a a computer.

<Projector control command>

Command	Details	Notes (Parameter)
PON	POWER ON	To check if the power is on, use the “Power query” command.
POF	STANDBY	
QPW	Power query	000 = Standby 001 = POWER ON
IIS	Switch input modes	VID = VIDEO SVD = S-VIDEO RG1 = RGB1 RG2 = RGB2 DVI = DVI-D
QSL	Query for active lamp selection	0 = DUAL 1 = SINGLE*1 2 = LAMP1 3 = LAMP2
LPM	Lamp mode	0 = DUAL 1 = SINGLE*1 2 = Only LAMP1 is ON 3 = Only LAMP2 is ON
OLP	Lamp power setting	0 = HIGH 1 = LOW

\*1: Uses the lamp (LAMP1 or LAMP2) with shorter operating hours.

# Technical Information

## REMOTE 2 IN terminal

It is possible to control the projector remotely (by external contact) from a control panel located away from the projector where remote control signals cannot reach. Use the <REMOTE 2 IN> terminal on the side of the projector to connect to the control panel.

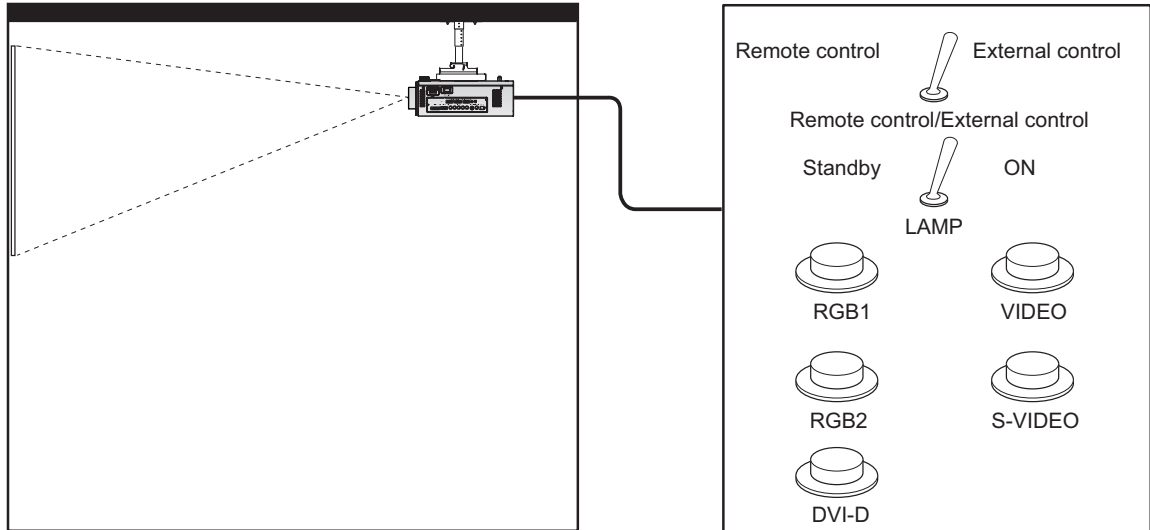

Projector set up in a meeting room

Control panel located in a different room

### Pin assignments and signal names

D-Sub 9-pin (Outside view)	Pin No.	Signal name	Open (H)	Short (L)
	(1)	GND	–	GND
	(2)	POWER	OFF	ON
	(3)	RGB1	Other	RGB1
	(4)	RGB2	Other	RGB2
	(5)	VIDEO	Other	VIDEO
	(6)	S-VIDEO	Other	S-VIDEO
	(7)	DVI-D	Other	DVI-D
	(8)	SHUTTER	OFF	ON
	(9)	RST/SET	Controlled by remote control	Controlled by external contact

#### Attention

- When controlling, make sure to short-circuit pins (1) and (9).
- When pins (1) and (9) are short-circuited, the following buttons on the control panel and the remote control cannot be used.  
The POWER ON < | > button, the STANDBY < ⏻ > button, the <SHUTTER> button, and the corresponding RS-232C commands and network functions cannot be used either.
- When pins (1) and (9) are short-circuited, do not short-circuit any pins from (3) to (7) with pin (1). The following buttons on the control panel and the remote control cannot be used.  
The POWER ON < | > button, the STANDBY < ⏻ > button, the <RGB1> button, the <RGB2> button, the <DVI-D> button, the <VIDEO> button, the <S-VIDEO> button, the <SHUTTER> button, and the corresponding RS-232C commands and network functions cannot be used either.

#### Note

- For pin (2) to pin (8) settings, you can make changes if you set [REMOTE2 MODE] to [USER]. (➡ page 64)

## Two window display combination list (PT-DW730E only)

Input A Input B	RGB1 Still image	RGB1 Movie	RGB2 Still image	RGB2 Movie	VIDEO	S-VIDEO	DVI Still image	DVI Movie
RGB1 Still image	–	–	✓	✓	✓	✓	✓	✓
RGB1 Movie	–	–	✓	–	–	–	✓	–
RGB2 Still image	✓	✓	–	–	✓	✓	✓	✓
RGB2 Movie	✓	–	–	–	–	–	✓	–
VIDEO	✓	–	✓	–	–	–	✓	–
S-VIDEO	✓	–	✓	–	–	–	✓	–
DVI Still image	✓	✓	✓	✓	✓	✓	–	–
DVI Movie	✓	–	✓	–	–	–	–	–

✓: Two window display combination is possible

–: Two window display combination is not possible

Signals that are treated as “movies”:

480i, 576i, 480p, 576p, 1080/60i, 1080/50i, 1080/60p,  
1080/50p, 1080/24sF, 1080/30p, 1080/25p, 1080/24p,  
720/60p, 720/50p, NTSC, PAL, SECAM, NTSC4.43, PAL-M, PAL-N, PAL60

## Menu lock password

To initialize your password, consult your distributor.

# Technical Information

## List of compatible signals

The following table specifies the types of signals compatible with the projectors.

Mode	Resolution (Dots)	Scanning frequency		Dot clock frequency (MHz)	Picture quality <sup>*3</sup>	Plug and play <sup>*6</sup>			Format <sup>*7</sup>
		Horizontal (kHz)	Vertical (Hz)			RGB2	DVI-D EDID1	DVI-D EDID2	
NTSC/NTSC4.43/ PAL-M/PAL60	720 x 480i	15.7	59.9	—	A	—	—	—	V/S
PAL/PAL-N/SECAM	720 x 576i	15.6	50.0	—	A	—	—	—	V/S
525i(480i)	720 x 480i	15.7	59.9	13.5	A	—	—	—	R/Y
625i(576i)	720 x 576i	15.6	50.0	13.5	A	—	—	—	R/Y
525p(480p)	720 x 483	31.5	59.9	27.0	A	—	✓	—	D/R/Y
625p(576p)	720 x 576	31.3	50.0	27.0	A	—	✓	—	D/R/Y
1125(1080)/60i <sup>*1</sup>	1 920 x 1 080i	33.8	60.0	74.3	A	—	✓	—	D/R/Y
1125(1080)/50i	1 920 x 1 080i	28.1	50.0	74.3	A	—	✓	—	D/R/Y
1125(1080)/24p	1 920 x 1 080	27.0	24.0	74.3	A	—	✓	—	D/R/Y
1125(1080)/24sF	1 920 x 1 080i	27.0	24.0	74.3	A	—	—	—	D/R/Y
1125(1080)/25p	1 920 x 1 080	28.1	25.0	74.3	A	—	✓	—	D/R/Y
1125(1080)/30p	1 920 x 1 080	33.8	30.0	74.3	A	—	—	—	D/R/Y
1125(1080)/60p	1 920 x 1 080	67.5	60.0	148.5	A	—	✓	—	D/R/Y
1125(1080)/50p	1 920 x 1 080	56.3	50.0	148.5	A	—	✓	—	D/R/Y
750 (720)/60p	1 280 x 720	45.0	60.0	74.3	AA <sup>*4</sup>	—	✓	—	D/R/Y
750 (720)/50p	1 280 x 720	37.5	50.0	74.3	AA <sup>*4</sup>	—	✓	—	D/R/Y
VGA400	640 x 400	31.5	70.1	25.2	A	—	—	—	D/R
	640 x 400	37.9	85.1	31.5	A	—	—	—	D/R
VGA480	640 x 480	31.5	59.9	25.2	A	✓	✓	✓	D/R
	640 x 480	35.0	66.7	30.2	A	—	—	—	D/R
	640 x 480	37.9	72.8	31.5	A	✓	—	✓	D/R
	640 x 480	37.5	75.0	31.5	A	✓	—	✓	D/R
	640 x 480	43.3	85.0	36.0	A	—	—	—	D/R
SVGA	800 x 600	35.2	56.3	36.0	A	✓	—	✓	D/R
	800 x 600	37.9	60.3	40.0	A	✓	—	✓	D/R
	800 x 600	48.1	72.2	50.0	A	✓	—	✓	D/R
	800 x 600	46.9	75.0	56.3	A	✓	—	✓	D/R
	800 x 600	53.7	85.1	56.3	A	—	—	—	D/R
MAC16	832 x 624	49.7	74.6	57.3	A	✓	—	✓	D/R
XGA	1 024 x 768	39.6	50.0	51.9	AA <sup>*5</sup>	—	—	—	D/R
	1 024 x 768	48.4	60.0	65.0	AA <sup>*5</sup>	✓	—	✓	D/R
	1 024 x 768	56.5	70.1	75.0	AA <sup>*5</sup>	✓	—	✓	D/R
	1 024 x 768	60.0	75.0	78.8	AA <sup>*5</sup>	✓	—	✓	D/R
	1 024 x 768	65.5	81.6	86.0	AA <sup>*5</sup>	—	—	—	D/R
	1 024 x 768	68.7	85.0	94.5	AA <sup>*5</sup>	—	—	—	D/R
	1 024 x 768	80.0	100.0	105.0	AA <sup>*5</sup>	—	—	—	D/R
	1 024 x 768	96.7	120.0	130.0	AA <sup>*5</sup>	—	—	—	D/R

Mode	Resolution (Dots)	Scanning frequency		Dot clock frequency (MHz)	Picture quality <sup>3</sup>	Plug and play <sup>6</sup>			Format <sup>7</sup>
		Horizontal (kHz)	Vertical (Hz)			RGB2	DVI-D EDID1	DVI-D EDID2	
MXGA	1 152 x 864	64.0	71.2	94.2	A	–	–	–	D/R
	1 152 x 864	67.5	74.9	108.0	A	–	–	–	D/R
	1 152 x 864	76.7	85.0	121.5	A	–	–	–	D/R
MAC21	1 152 x 870	68.7	75.1	100.0	A	✓	–	✓	D/R
1280 x 768	1 280 x 768	39.6	49.9	65.3	AA <sup>4</sup>	–	–	–	D/R
	1 280 x 768	47.8	59.9	79.5	AA <sup>4</sup>	–	–	–	D/R
1280 x 800	1 280 x 800	41.3	50.0	68.0	AA <sup>4</sup>	–	–	–	D/R
	1 280 x 800	49.7	59.8	83.5	AA <sup>4</sup>	–	–	–	D/R
MSXGA	1 280 x 960	60.0	60.0	108.0	A	–	–	–	D/R
SXGA	1 280 x 1 024	64.0	60.0	108.0	A	✓	–	✓	D/R
	1 280 x 1 024	80.0	75.0	135.0	A	✓	–	✓	D/R
	1 280 x 1 024	91.1	85.0	157.5	B	–	–	–	D/R
SXGA+	1 400 x 1 050	65.2	60.0	122.6	A	✓	–	✓	D/R
	1 400 x 1 050	82.2	75.0	155.9	B	–	–	–	D/R
WXGA+	1 440 x 900	55.9	59.9	106.5	A	–	–	–	D/R
UXGA	1 600 x 1 200	75.0	60.0	162.0	B	✓	–	✓	D/R
WSXGA+	1 680 x 1 050	65.3	60.0	146.3	A	–	–	–	D/R
1920 x 1080 <sup>2</sup>	1 920 x 1 080	66.6	59.9	138.5	A	–	–	–	D/R
WUXGA <sup>2</sup>	1 920 x 1 200	74.0	60.0	154.0	B	✓	–	✓	D/R

\*1: When the 1035/60i signal is input, the signal is displayed as 1080/60i.

\*2: VESA CVT-RB (Reduced Blanking) compatible

\*3: Signals that show display picture quality are as follows.

AA : Projects the image in the highest picture quality.

A : Converts the image in the image processing circuit and projects the image.

B : Samples the image in the image processing circuit and projects the image.

\*4: Signal A for PT-DX800E.

\*5: Signal A for PT-DW730E.

\*6: Signals with a ✓ in Plug and play are signals described in the projector's EDID (extended display identification data). If a signal has no ✓ in Plug and play but has an entry in the Format column, it can be entered. For signals without a ✓ in Plug and play, there are instances that resolution cannot be selected even though the computer supports them.

\*7: Signals that show formats are as follows.

V: Video

S: S-Video

D: DVI-D

R: RGB

Y: YP<sub>B</sub>Pr

## Note

- The number of display dots is 1 280 x 800 for the PT-DW730E and 1 024 x 768 for the PT-DX800E. A signal with a different resolution will be projected after converting the resolution to match the projector display.
- The "i" at the end of the resolution indicates an interlaced signal.
- When interlaced signals are connected, flicker may occur on the projected image.

# Specifications

The following table describes the specifications of the projector.

Model No.		PT-DW730E	PT-DW730EL	PT-DX800E	PT-DX800EL
Power supply		AC 220 V - 240 V 50 Hz/60 Hz			
Power consumption		760 W (When [STANDBY MODE] is set to [ECO]: 0.3 W When [STANDBY MODE] is set to [NORMAL]: 9 W)			
Amps		4.3 A			
DLP chip	Size	0.65" (aspect ratio 16:10)		0.7" (aspect ratio 4:3)	
	Display system	One-unit DLP chip, DLP type			
	Number of pixels	1 024 000 pixels (1 280 x 800 dots)		786 432 pixels (1 024 x 768 dots)	
Lens	Power zoom	1.8 to 2.5:1	Optional	1.8 to 2.5:1	Optional
	Power focus	F = 1.7 to 1.9 f = 25.6 mm to 35.7 mm		F = 1.7 to 1.9 f = 25.6 mm to 35.7 mm	
Luminous lamp		300 W (maximum of 310 W) UHM lamp x 2			
Light output		7 000 lm <sup>**1</sup> (ANSI)		8 000 lm <sup>**1</sup> (ANSI)	
Applicable scanning frequency	For video signals (including S-video)	Horizontal: 15.75 kHz/15.63 kHz, Vertical: 50 Hz/60 Hz			
	For RGB signals	Horizontal: 15 kHz to 91 kHz, Vertical: 50 Hz to 85 Hz PIAS (Panasonic Intelligent Auto Scanning) system			
		Dot clock frequency 150 MHz or less			
	For DVI-D signals	525p(480p), 625p(576p), 750(720)/60p, 750(720)/50p, 1125(1080)/60p, 1125(1080)/50p, 1125(1080)/60i, 1125(1080)/50i, 1125(1080)/24sF, 1125(1080)/30p, 1125(1080)/25p, 1125(1080)/24p ● Displayable resolution: VGA to WUXGA (non-interlaced) ● Dot clock frequency: 25 MHz to 162 MHz ● WUXGA signals support only VESA CVT-RB (Reduced Blanking) signals.			
For YP <sub>B</sub> Pr signals	[525i (480i)] H: 15.75 kHz, V: 60 Hz [525p (480p)] H: 31.5 kHz, V: 60 Hz [750 (720)/60p] H: 45 kHz, V: 60 Hz [1035/60i] H: 33.75 kHz, V: 60 Hz [1125 (1080)/50i] H: 28.13 kHz, V: 50 Hz [1125 (1080)/24p] H: 27 kHz, V: 24 Hz [1125 (1080)/30p] H: 33.75 kHz, V: 30 Hz [1125 (1080)/50p] H: 56.25 kHz, V: 50 Hz		[625i (576i)] H: 15.63 kHz, V: 50 Hz [625p (576p)] H: 31.25 kHz, V: 50 Hz [750 (720)/50p] H: 37.5 kHz, V: 50 Hz [1125 (1080)/60i] H: 33.75 kHz, V: 60 Hz [1125 (1080)/25p] H: 28.13 kHz, V: 25 Hz [1125 (1080)/24sF] H: 27 kHz, V: 48 Hz [1125 (1080)/60p] H: 67.5 kHz, V: 60 Hz ● SYNC/HD terminals and VD terminals are not supported in 3 value SYNC.		
Color system		7 standards (NTSC/NTSC4.43/PAL/PAL-N/PAL-M/SECAM/PAL60)			
Screen size		1.27 m (50") - 15.24 m (600") <sup>2</sup>			
Screen aspect ratio		16:10		4:3	
Projection method		Front ceiling/front floor/rear ceiling/rear floor			
Contrast ratio		2 500:1 (when [CONTRAST MODE] is set to [HIGH])		2 000:1 (when [CONTRAST MODE] is set to [HIGH])	
Terminals	RGB1 IN	1 set (BNC x 5)			
		[RGB SIGNAL]	0.7 V [p-p] 75 Ω (SYNC ON GREEN: 1.0 V [p-p] 75 Ω) SYNC/HD, TTL high impedance, automatic positive/negative polarity compatible VD, TTL high impedance, automatic positive/negative polarity compatible		
		[YP <sub>B</sub> Pr signal]	Y:1.0 V [p-p] including synchronization signal, P <sub>B</sub> Pr: 0.7 V [p-p] 75 Ω		



# Specifications

Model No.		PT-DW730E	PT-DW730EL	PT-DX800E	PT-DX800EL
Terminals	RGB2 IN	1 set, high-density D-Sub 15 p (female) [RGB SIGNAL] 0.7 V [p-p] 75 Ω (SYNC ON GREEN: 1.0 V [p-p] 75 Ω) SYNC/HD, TTL high impedance, automatic positive/negative polarity compatible VD, TTL high impedance, automatic positive/negative polarity compatible [YP <sub>B</sub> P <sub>R</sub> signal] Y:1.0 V [p-p] including synchronization signal, P <sub>B</sub> P <sub>R</sub> : 0.7 V [p-p] 75 Ω			
	VIDEO IN	1 set, BNC 1.0 V [p-p] 75 Ω			
	S-VIDEO IN	1 set, Mini DIN 4 p Y 1.0 V [p-p], C 0.286 V [p-p] 75 Ω S1 signal compliant			
	SERIAL IN/OUT	D-Sub 9 p, each set, RS-232C compatible, for computer control			
	REMOTE1 IN/OUT	M3 stereo mini jack, for each remote control (wired) / projector connection control			
	REMOTE2 IN/OUT	1 set, D-Sub 9 p (female), for external control (contact control)			
	DVI-D IN	1 set, DVI-D 24 p, single link, DVI1.0 compatible, HDCP compliant			
	LAN	1 set, RJ-45 for network connection, PLink compliant, 10Base-T/100Base-TX			
Power cable length		3.0 m (118-1/8")			
Outer case		Molded plastic			
Dimensions		Width: 498 mm (19-19/32") Height: 175 mm (6-7/8") (feet at a minimum) Depth: 466 mm (18-11/32") (including the supplied standard zoom lens)	Width: 498 mm (19-19/32") Height: 175 mm (6-7/8") (feet at a minimum) Depth: 423 mm (16-21/32")	Width: 498 mm (19-19/32") Height: 175 mm (6-7/8") (feet at a minimum) Depth: 466 mm (18-11/32") (including the supplied standard zoom lens)	Width: 498 mm (19-19/32") Height: 175 mm (6-7/8") (feet at a minimum) Depth: 423 mm (16-21/32")
Weight		Approx. 16.3 kg (35.9 lbs.) <sup>*3</sup> (including the supplied standard zoom lens)	Approx 15.4 kg (34 lbs.) <sup>*3</sup>	Approx. 16.3 kg (35.9 lbs.) <sup>*3</sup> (including the supplied standard zoom lens)	Approx 15.4 kg (34 lbs.) <sup>*3</sup>
Operating environment		Operating environment temperature <sup>*4</sup> : 0°C (32°F) to 45°C (113°F) Operating environment humidity: 20% to 80% (no condensation)			
Remote control	Power supply	DC 3 V (AA/R6 battery x 2)			
	Operating range	Approx. 30 m (98'5") (when operated directly in front of signal receiver)			
	Weight	134 g (4.7 ozs.) (including batteries)			
	Dimensions	Width: 51 mm (2"), Height: 176 mm (6-15/16"), Depth: 22.7 mm (29/32")			

\*1: The supplied standard zoom lens value for PT-DX800E and PT-DW730E. Values vary depending on the lens. Measurement, measuring conditions and method of notation all comply with ISO21118 international standards.

\*2: The maximum is 5.08 m (200") when using an ET-DLE055 lens.

\*3: Average value. Weight varies for each product.

\*4: When using the projector at high elevations 1 400 m (4 593 ft) – 2 700 m (8 858 ft) sea level, temperature will be 5°C (41°F) lower than this higher limit. If the projector is used with the following 2 settings when the ambient temperature reaches 40°C (104°F) (35°C (95°F) in [HIGH ALTITUDE MODE]) or above, the light output may decrease by 20% to protect the projector.

- [LAMP SELECT] is set to [DUAL] in the menu
- [LAMP POWER] is set to [HIGH] in the menu

● The part numbers of accessories and separately sold components are subject to change without notice.

# Dimensions

<Unit: mm>

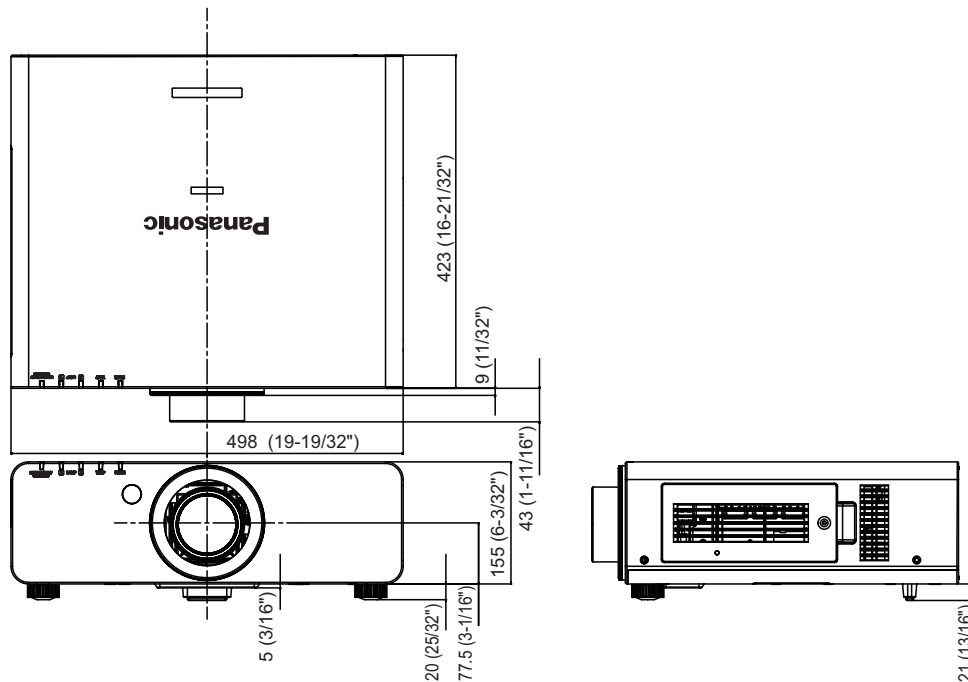

- \* The above dimension is for the models with the standard zoom lens.
- \* Actual dimension may differ depending on the product.

## Ceiling mount bracket safeguards

- When installing the projector to a ceiling, be sure to use the specified ceiling mount bracket (ET-PKD56H: for high ceilings, ET-PKD55S: for low ceilings).
- When installing the projector, attach the drop-prevention kit supplied with the ceiling mount bracket to the projector. When you wish to purchase the kit (Product No. TTRA0214), consult your dealer.
- Installation work of the ceiling mount bracket should only be performed by a qualified technician.
- Panasonic takes no responsibility for any damage to the projector resulting from use of a ceiling mount bracket not manufactured by Panasonic or the inappropriate choice of location for installation, even if the warranty period of the projector has not expired.
- An unused ceiling mount bracket must be removed promptly by a qualified technician.
- Use a torque driver or a hex torque driver when tightening the screws and tighten the screws within the minimum required tightening torque. Do not use tools such as electric screwdrivers or impact screwdrivers.
- For details, read the installation manual that comes with with the ceiling mount bracket.
- The part numbers of accessories and separately sold components are subject to change without notice.

Bottom view

Model No. of ceiling mount bracket: ET-PKD56H (for high ceilings)  
ET-PKD55S (for low ceilings)

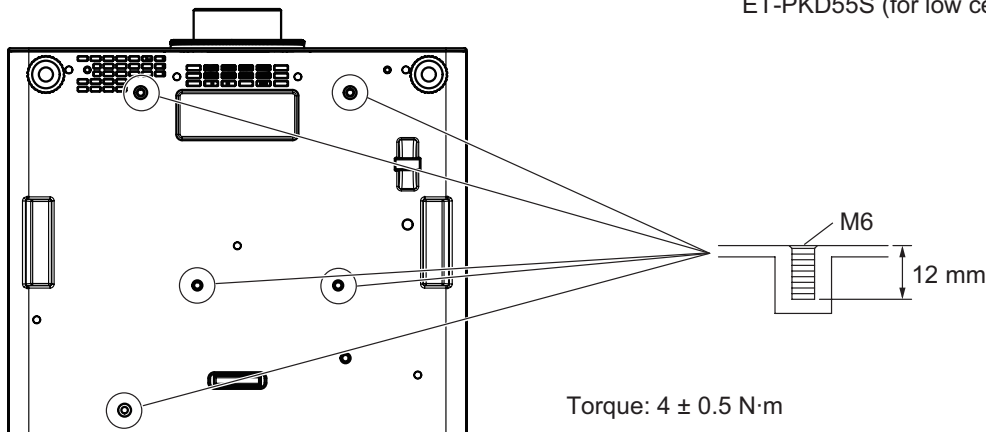

# Index

<b>A</b>			
Accessories	16	INPUT RESOLUTION	52
AC IN terminal	18, 32	<b>K</b>	
Adjustable feet	27	KEystone	50
ADVANCED MENU	42, 51	<b>L</b>	
AI	47	Lamp indicator	87
Air filter unit	89	LAMP POWER	63
Air filter unit compartment	90	LAMP RELAY	63
ASPECT	48	LAMP SELECT	62
<ASPECT> button		Lamp unit cover	18
Remote control	17, 40	<LENS> button	
ASPECT function	40	Projector body	19, 36
AUTO SETUP	57	List of compatible signals	102
<AUTO SETUP> button		LOAD ALL USER DATA	66
Projector body	19, 39	<b>M</b>	
Remote control	17, 39	MAIN MENU	42
AUTO SETUP function	39	<MAIN POWER> switch	18, 34
AUTO SIGNAL	57	Maintenance	89
<b>B</b>		<MENU> button	
BACK COLOR	59	Projector body	19, 41
BLANKING	51	Remote control	17, 41
BRIGHTNESS	44	Menu item	42
<b>C</b>		MENU LOCK	71
Cautions on use	15	MENU LOCK PASSWORD	71
Cautions when installing	12	Menu Navigation	41
Cautions when transporting	12	<b>N</b>	
Ceiling mount bracket	106	Navigating through the menu	41
Ceiling mount bracket safeguards	106	NETWORK	43, 73
CLAMP POSITION	52	Network connections	74
CLOCK PHASE	50	NETWORK CONTROL	73
COLOR	45	NETWORK SETUP	73
COLOR CORRECTION	56	NETWORK STATUS	73
COLOR MATCHING	55	New registration	68
COLOR TEMPERATURE	45	NOISE REDUCTION	46
Connecting the power cord	32	NO SIGNAL SHUT-OFF	65
Connections	30	<b>O</b>	
CONTRAST	44	<ON SCREEN> button	
CONTRAST MODE	56	Remote control	17, 38
CONTROL DEVICE SETUP	71	ON-SCREEN DISPLAY	58
COOLING CONDITION	62	Optional accessories	16
<b>D</b>		<b>P</b>	
DATE AND TIME	65	PICTURE	42, 44
<DEFAULT> button		PICTURE MODE	44
Remote control	17, 41	POSITION	42, 48
Deleting entry signal	68	Power cord	32
DIGITAL CINEMA REALITY	51	Power indicator	33, 87
Dimensions	106	Powering off the projector	35
Direct power off function	35	Powering up the projector	34
DISPLAY LANGUAGE	43, 54	POWER ON button	
DISPLAY OPTION	43, 55	Projector body	19
DISPLAY SETTING	70	Remote control	17
Disposal	14	Precautions for Use	12
<DVI-D> button		Projecting	36
Projector body	19, 38	Projection method	21, 61
Remote control	17, 38	Projector body	18
DVI-D IN	58	PROJECTOR ID	61
<b>E</b>		PROJECTOR SETUP	43, 61
EDGE BLENDING	52	<b>R</b>	
<ENTER> button		RASTER POSITION	53
Projector body	19	Read this first!	2
Remote control	17	REMOTE 1 IN terminal	20
<b>F</b>		REMOTE 2 IN terminal	20
Filter indicator	88	REMOTE2 MODE	64
<FOCUS> button		Remote control	17
Remote control	17, 36	Remote control operations	38
FREEZE	60	Removing/attaching the projection lens	28
<FUNCTION> button		Renaming registered signal	68
Remote control	17, 39	Replacing the air filter unit	90
FUNCTION BUTTON	39, 65	Replacing the lamp unit	91
<b>H</b>		Replacing the unit	90
HIGH ALTITUDE MODE	61	Resetting to the factory default	41
<b>I</b>		<RGB1> button	
<ID ALL> button		Projector body	19, 38
Remote control	17, 20	Remote control	17, 38
<ID SET> button		<RGB2> button	
Remote control	17, 20	Projector body	19, 38
INITIALIZE	66	Remote control	17, 38
		RS-232C	63, 98
		<b>S</b>	
		SAVE ALL USER DATA	65
		SCREEN SETTING	57
		Security	14
		SECURITY	43, 70
		SECURITY PASSWORD	70
		SECURITY PASSWORD CHANGE	70
		Selecting the input signal	36
		Serial terminal	98
		SERVICE PASSWORD	66
		Setting Remote control ID numbers	20
		Setting up	21
		SHARPNESS	46
		SHIFT	48
		<SHIFT> button	
		Remote control	17, 36
		<SHUTTER> button	
		Projector body	38
		Remote control	17, 38
		SIDE BY SIDE	60, 101
		SIGNAL LIST	43, 68
		Specifications	104
		STANDBY button	
		Projector body	19
		Remote control	17
		STANDBY MODE	63
		STARTUP LOGO	60
		STATUS	64
		<STATUS> button	
		Remote control	17, 38
		Sub memory	69
		<S-VIDEO> button	
		Projector body	19, 38
		Remote control	17, 38
		Switching the input signal	38
		SYSTEM DAYLIGHT VIEW	46
		SYSTEM SELECTOR	47
		<b>T</b>	
		Temperature indicator	88
		TEST PATTERN	43, 67
		<TEST PATTERN> button	
		Remote control	17, 39
		TEXT CHANGE	71
		TINT	45
		Troubleshooting	93
		<b>V</b>	
		<VIDEO> button	
		Projector body	19, 38
		Remote control	17, 38
		<b>W</b>	
		WHITE GAIN	46
		<b>Z</b>	
		ZOOM	49
		<ZOOM> button	
		Remote control	17, 36

## Information for Users on Collection and Disposal of Old Equipment and used Batteries



These symbols on the products, packaging, and/or accompanying documents mean that used electrical and electronic products and batteries should not be mixed with general household waste. For proper treatment, recovery and recycling of old products and used batteries, please take them to applicable collection points, in accordance with your national legislation and the Directives 2002/96/EC and 2006/66/EC.

By disposing of these products and batteries correctly, you will help to save valuable resources and prevent any potential negative effects on human health and the environment which could otherwise arise from inappropriate waste handling.



For more information about collection and recycling of old products and batteries, please contact your local municipality, your waste disposal service or the point of sale where you purchased the items.

Penalties may be applicable for incorrect disposal of this waste, in accordance with national legislation.



### **For business users in the European Union**

If you wish to discard electrical and electronic equipment, please contact your dealer or supplier for further information.

### **Information on Disposal in other Countries outside the European Union**

These symbols are only valid in the European Union. If you wish to discard these items, please contact your local authorities or dealer and ask for the correct method of disposal.

### **Note for the battery symbol (bottom two symbol examples):**

This symbol might be used in combination with a chemical symbol. In this case it complies with the requirement set by the Directive for the chemical involved.

## Environment care information for users in China



This symbol is only valid in china.

# Panasonic Corporation

Web Site : <http://panasonic.net/avc/projector/>

© Panasonic Corporation 2011