

Projector

CP-X2514WN/CP-X3014WN/ CP-X4014WN/CP-WX3014WN

User's Manual (detailed) Operating Guide

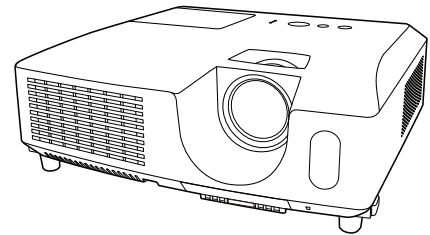

Thank you for purchasing this projector.

⚠ WARNING ▶ Before using this product, please read all manuals for this product. Be sure to read **Safety Guide** first. After reading them, store them in a safe place for future reference.

About this manual

Various symbols are used in this manual. The meanings of these symbols are described below.

⚠ WARNING This symbol indicates information that, if ignored, could possibly result in personal injury or even death due to incorrect handling.

⚠ CAUTION This symbol indicates information that, if ignored, could possibly result in personal injury or physical damage due to incorrect handling.

NOTICE This entry notices of fear of causing trouble.

 Please refer to the pages written following this symbol.

NOTE • The information in this manual is subject to change without notice.
• The manufacturer assumes no responsibility for any errors that may appear in this manual.
• The reproduction, transfer or copy of all or any part of this document is not permitted without express written consent.

Trademark acknowledgment

- Mac[®] is a registered trademark of Apple Inc.
- Windows[®], DirectDraw[®] and Direct3D[®] are registered trademarks of Microsoft Corporation in the U.S. and/or other countries.
- VESA and DDC are trademarks of the Video Electronics Standard Association.
- HDMI, the HDMI logo, and High-Definition Multimedia Interface are trademarks or registered trademarks of HDMI Licensing LLC in the United States and other countries.
- Trademark PJLink is a trademark applied for trademark rights in Japan, the United States of America and other countries and areas.
- Blu-ray Disc[™] is a trademark.

PJLink[™]

All other trademarks are the properties of their respective owners.

Projector

User's Manual - Safety Guide

Thank you for purchasing this projector.



 **WARNING** • Before using, read these user's manuals of this projector to ensure correct usage through understanding. After reading, store them in a safe place for future reference. Incorrect handling of this product could possibly result in personal injury or physical damage. The manufacturer assumes no responsibility for any damage caused by mishandling that is beyond normal usage defined in these manuals of this projector.

NOTE • The information in this manual is subject to change without notice.

- The manufacturer assumes no responsibility for any errors that may appear in this manual.
- The reproduction, transmission or use of this document or contents is not permitted without express written authority.

About The Symbols

Various symbols are used in this manual, the user's manual and on the product itself to ensure correct usage, to prevent danger to the user and others, and to prevent property damage. The meanings of these symbols are described below. It is important that you read these descriptions thoroughly and fully understand the contents.

 WARNING	This symbol indicates information that, if ignored, could possibly result in personal injury or even death due to incorrect handling.
 CAUTION	This symbol indicates information that, if ignored, could result possibly in personal injury or physical damage due to incorrect handling.

Typical Symbols



This symbol indicates an additional warning (including cautions). An illustration is provided to clarify the contents.



This symbol indicates a prohibited action. The contents will be clearly indicated in an illustration or nearby (the symbol to the left indicates that disassembly is prohibited).



This symbol indicates a compulsory action. The contents will be clearly indicated in an illustration or nearby (the symbol to the left indicates that the power plug should be disconnected from the power outlet).

Safety Precautions

WARNING

Never use the projector if a problem should occur.

Abnormal operations such as smoke, strange odor, no image, no sound, excessive sound, damaged casing or elements or cables, penetration of liquids or foreign matter, etc. can cause a fire or electrical shock.

In such case, immediately turn off the power switch and then disconnect the power plug from the power outlet. After making sure that the smoke or odor has stopped, contact your dealer. Never attempt to make repairs yourself because this could be dangerous.

- The power outlet should be close to the projector and easily accessible.

Use special caution for children and pets.

Incorrect handling could result in fire, electrical shock, injury, burn or vision problem.

Use special caution in households where children and pets are present.

Do not insert liquids or foreign object.

Penetration of liquids or foreign objects could result in fire or electrical shock.

Use special caution in households where children are present.

If liquids or foreign object should enter the projector, immediately turn off the power switch, disconnect the power plug from the power outlet and contact your dealer.

- Do not place the projector near water (ex. a bathroom, a beach, etc.).
- Do not expose the projector to rain or moisture. Do not place the projector outdoors.
- Do not place flower vases, pots, cups, cosmetics, liquids such as water, etc on or around the projector.
- Do not place metals, combustibles, etc on or around the projector.
- To avoid penetration of foreign objects, do not put the projector into a case or bag together with any thing except the accessories of the projector, signal cables and connectors.

Never disassemble and modify.

The projector contains high voltage components. Modification and/or disassembly of the projector or accessories could result in fire or electrical shock.

- Never open the cabinet.
- Ask your dealer to repair and clean insides.

Do not give the projector any shock or impact.

If the projector should be shocked and/or broken, it could result in an injury, and continued use could result in fire or electrical shock.

If the projector is shocked, immediately turn off the power switch, disconnect the power plug from the power outlet and contact your dealer.

Do not place the projector on an unstable surface.

If the projector should be dropped and/or broken, it could result in an injury, and continued use could result in fire or electrical shock.

- Do not place the projector on an unstable, slant or vibrant surface such as a wobbly or inclined stand.
- Use the caster brakes placing the projector on a stand with casters.
- Do not place the projector in the side up position, the lens up position or the lens down position.
- In the case of a ceiling installation or the like, contact your dealer before installation.



Disconnect the plug from the power outlet.



Do not disassemble.



Safety Precautions (continued)

WARNING

Be cautious of High temperatures of the projector.

High temperatures are generated when the lamp is lit. It could result in fire or burn. Use special caution in households where children are present.

Do not touch about the lens, air fans and ventilation openings during use or immediately after use, to prevent a burn. Take care of ventilation.

- Keep a space of 30 cm or more between the sides and other objects such as walls.
- Do not place the projector on a metallic table or anything weak in heat.
- Do not place anything about the lens, air fans and ventilation openings of the projector.
- Never block the air fan and ventilation openings.
- Do not cover the projector with a tablecloth, etc.
- Do not place the projector on a carpet or bedding.



Never look through the lens or openings when the lamp is on.

The powerful light could adversely affect vision.

Use special caution in households where children are present.



Use only the correct power cord and the correct power outlet.

Incorrect power supply could result in fire or electrical shock.

- Use only the correct power outlet depending on the indication on the projector and the safety standard.
- The enclosed power cord must be used depending on the power outlet to be used.



Be cautious of the power cord connection.

Incorrect connection of the power cord could result in fire or electrical shock.

- Do not touch the power cord with a wet hand.
- Check that the connecting portion of the power cord is clean (with no dust), before using. Use a soft and dry cloth to clean the power plug.
- Insert the power plug into a power outlet firmly. Avoid using a loose, unsound outlet or contact failure.



Be sure to connect with ground wire.

Connect the ground terminal of AC inlet of this unit with the ground terminal provided at the building using the correct power cord; otherwise, fire or electric shock can result.

- Don't take the core of power cord away.



Surely connect the ground wire.

Safety Precautions (continued)

WARNING

Be careful in handling the light source lamp.

The projector uses a high-pressure mercury glass lamp made of glass. The lamp can break with a loud bang, or burn out. When the bulb bursts, it is possible for shards of glass to fly into the lamp housing, and for gas containing mercury to escape from the projector's vent holes.



Please carefully read the section "Lamp".

Be careful in handling the power cord and external connection cables.

If you keep using a damaged the power cord or cables, it can cause a fire or electrical shock. Do not apply too much heat, pressure or tension to the power cord and cables.

If the power cord or cables is damaged (exposed or broken core wires, etc.), contact your dealer.

- Do not place the projector or heavy objects on the power cord and cables. Also, do not place a spread, cover, etc, over them because this could result in the inadvertent placing of heavy objects on the concealed power cord or cables.



- Do not pull the power cord and cables. When connecting and disconnecting the power cord or cables, do it with your hand holding the plug or connector.

- Do not place the cord near the heater.

- Avoid bending the power cord sharply.

- Do not attempt to work on the power cord.

Be careful in handling the battery of the remote control.

Incorrect handling of the battery could result in fire or personal injury. The battery may explode if not handled properly.

- Keep the battery away from children and pets. If swallowed consult a physician immediately for emergency treatment.

- Do not allow the battery in a fire or water.

- Avoid fire or high-temperature environment.

- Do not hold the battery with the metallic tweezers.

- Keep the battery in a dark, cool and dry place.

- Do not short circuit the battery.

- Do not recharge, disassemble or solder the battery.

- Do not give the battery a physical impact.

- Use only the battery specified in the other manual of this projector.

- Make sure the plus and minus terminals are correctly aligned when loading the battery.

- If you observe a leakage of the battery, wipe out the leakage and then replace the battery. If the leakage adheres your body or clothes, rinse well with water.

- Obey the local laws on disposing the battery.



Safety Precautions (continued)

CAUTION

Be careful in moving the projector.

Neglect could result in an injury or damage.

- Do not move the projector during use. Before moving, disconnect the power cord and all external connections, and close the slide lens door or attach the lens cap.
- Avoid any impact or shock to the projector.
- Do not drag the projector.
- For moving the projector, use the enclosed case or bag if provided.



Do not put anything on top of the projector.

Placing anything on the projector could result in loss of balance or falling, and cause an injury or damage. Use special caution in households where children are present.



Do not attach anything other than specified things to the projector.

Neglect could result in an injury or damage.

- Some projector has a screw thread in a lens part. Do not attach anything other than specified options (such as conversion lens) to the screw thread.



Avoid a smoky, humid or dusty place.

Placing the projector in a smoke, a highly humid, dusty place, oily soot or corrosive gas could result in fire or electrical shock.

- Do not place the projector near a smoky, humid or dusty place (ex. a smoking space, a kitchen, a beach, etc.). Do not place the projector outdoors.
- Do not use a humidifier near the projector.



Take care of the air filter to normal ventilate.

The air filter should be cleaned periodically. If the air filter becomes clogged by dust or the like, internal temperature rises and could cause malfunction. The projector may display the message such as "CHECK THE AIR FLOW" or turn off the projector, to prevent the internal heat level rising.

- When the indicators or a message prompts you to clean the air filter, clean the air filter as soon as possible.
- If the soiling will not come off the air filter, or it becomes damaged, replace the air filter.
- Use the air filter of the specified type only. Please order the air filter specified in the other manual of this projector to your dealer.
- When you replace the lamp, replace also the air filter. The air filter may be attached when you buy a replacement lamp for this projector.
- Do not turn on the projector without air filter.



Avoid a high temperature environment.

The heat could have adverse influence on the cabinet of the projector and other parts. Do not place the projector, the remote control and other parts in direct sunlight or near a hot object such as heater, etc.



Avoid Magnetism.

Manufacture strongly recommends to avoid any magnetic contact that is not shielded or protected on or near the projector itself. (ie., Magnetic Security Devices, or other projector accessory that contains magnetic material that has not been provided by the manufacture etc.) Magnetic objects may cause interruption of the projector's internal mechanical performance which may interfere with cooling fans speed or stopping, and may cause the projector to completely shut down.



Safety Precautions (continued)

CAUTION

Remove the power cord for complete separation.

- For safety purposes, disconnect the power cord if the projector is not to be used for prolonged periods of time.
- Before cleaning, turn off and unplug the projector. Neglect could result in fire or electrical shock.



Disconnect the plug from the power outlet.

Ask your dealer to cleaning inside of the projector about every year.

Accumulations of dust inside the projector cause result in fire or malfunction. Cleaning inside is more effective if performed before every humid periods such as rainy season.



- Do not clean inside yourself because it is dangerous.

NOTE

Do not give the remote control any physical impact.

A physical impact could cause damage or malfunction of the remote control.

- Take care not to drop the remote control.
- Do not place the projector or heavy objects on the remote control.

Take care of the lens.

- Close the slide lens door or attach the lens cap to prevent the lens surface being scratched when the projector is not used.
- Do not touch the lens to prevent fog or dirt of the lens that cause deterioration of display quality.
- Use commercially available lens tissue to clean the lens (used to clean cameras, eyeglasses, etc.). Be careful not to scratch the lens with hard objects.

Take care of the cabinet and the remote control.

Incorrect care could have adverse influence such as discoloration, peeling paint, etc.

- Use a soft cloth to clean the cabinet and control panel of the projector and the remote control. When excessively soiled dilute a neutral detergent in water, wet and wring out the soft cloth and afterward wipe with a dry soft cloth. Do not use undiluted detergent directly.
- Do not use an aerosol sprays, solvents, volatile substances or abrasive cleaner.
- Before using chemical wipes, be sure to read and observe the instructions.
- Do not allow long-term close contact with rubber or vinyl.

About bright spots or dark spots.

Although bright spots or dark spots may appear on the screen, this is a unique characteristic of liquid crystal displays, and such do not constitute or imply a machine defect.

Be careful of printing of the LCD panel.

If the projector continues projecting a still image, inactive images or 16:9 aspect images in case of 4:3 panel, etc., for long time, the LCD panel might possibly be printed.

Safety Precautions (continued)

NOTE

About consumables.

Lamp, LCD panels, polarizers and other optical components, and air filter and cooling fans have a different lifetime in each. These parts may need to be replaced after a long usage time.

- This product isn't designed for continuous use of long time. In the case of continuous use for 6 hours or more, or use for 6 hours or more every day (even if it isn't continuous), or repetitious use, the lifetime may be shortened, and these parts may need to be replaced even if one year has not passed since the beginning of using.
- Any inclining use beyond the adjustment range explained in these user's manuals may shorten the lifetimes of the consumables.

Before turning on the power, make the projector cool down adequately.

After turning the projector off, pushing the restart switch or interrupting of the power supply, make the projector cool down adequately. Operation in a high temperature state of the projector causes a damage of the electrode and un-lighting of the lamp.

Avoid strong rays.

Any strong ray (such as direct rays of the sun or room lighting) onto the remote control sensors could invalidate the remote control.

Avoid radio interference.

Any interfering radiation could cause disordered image or noises.

- Avoid radio generator such as a mobile telephone, transceiver, etc. around the projector.

About displaying characteristic.

The display condition of the projector (such as color, contrast, etc.) depends on characteristic of the screen, because the projector uses a liquid crystal display panel. The display condition can differ from the display of CRT.

- Do not use a polarized screen. It can cause red image.

Turn the power on/off in right order.

To prevent any trouble, turn on/off the projector in right order mentioned below unless specifying.

- Power on the projector before the computer or video tape recorder.
- Power off the projector after the computer or video tape recorder.

Take care not to fatigue your eyes.

Rest the eyes periodically.

Set the sound volume at a suitable level to avoid bothering other people.

- It is better to keep the volume level low and close the windows at night to protect the neighborhood environment.

Connecting with notebook computer

When connecting with notebook computer, set to valid the RGB external image output (setting CRT display or simultaneous display of LCD and CRT).

Please read instruction manual of the notebook for more information.

Lamp

WARNING



HIGH VOLTAGE



HIGH TEMPERATURE



HIGH PRESSURE

The projector uses a high-pressure mercury glass lamp. The lamp can **break with a loud bang, or burn out**, if jolted or scratched, handled while hot, or worn over time. Note that each lamp has a different lifetime, and some may burst or burn out soon after you start using them. In addition, when the bulb bursts, it is possible for **shards of glass** to fly into the lamp housing, and for **gas containing mercury** to escape from the projector's vent holes.

About disposal of a lamp • This product contains a mercury lamp; do not put in trash. Dispose of in accord with environmental laws.

For lamp recycling, go to www.lamprecycle.org. (in USA)

For product disposal, contact your local government agency or www.eiae.org (in the US) or www.epsc.ca (in Canada).

For more information, call your dealer.



Disconnect
the plug from
the power
outlet

- If the lamp should break (it will make a loud bang when it does), unplug the power cord from the outlet, and make sure to request a replacement lamp from your local dealer. Note that shards of glass could damage the projector's internals, or cause injury during handling, so please do not try to clean the projector or replace the lamp yourself.
- If the lamp should break (it will make a loud bang when it does), ventilate the room well, and make sure not to breathe the gas that comes out of the projector vents, or get it in your eyes or mouth.
- Before replacing the lamp, make sure the power switch is off and the power cable is not plugged in, then wait at least 45 minutes for the lamp to cool sufficiently. Handling the lamp while hot can cause burns, as well as damaging the lamp.



- Do not open the lamp cover while the projector is suspended from above. This is dangerous, since if the lamp's bulb has broken, the shards will fall out when the cover is opened. In addition, working in high places is dangerous, so ask your local dealer to have the lamp replaced even if the bulb is not broken.
- Do not use the projector with the lamp cover removed. At the lamp replacing, make sure that the screws are screwed in firmly. Loose screws could result in damage or injury.



- Use the lamp of the specified type only.
- If the lamp breaks soon after the first time it is used, it is possible that there are electrical problems elsewhere besides the lamp. If this happens, contact your local dealer or a service representative.
- Handle with care: jolting or scratching could cause the lamp bulb to burst during use.
- Using the lamp for long periods of time, could cause it dark, not to light up or to burst. When the pictures appear dark, or when the color tone is poor, please replace the lamp as soon as possible. Do not use old (used) lamps; this is a cause of breakage.

Regulatory Notices

FCC Statement Warning

This device complies with part 15 of the FCC Rules. Operation is subject to the following two conditions: (1) This device may not cause harmful interference, and (2) this device must accept any interference received, including interference that may cause undesired operation.

WARNING: This equipment has been tested and found to comply with the limits for a Class B digital device, pursuant to Part 15 of the FCC Rules. These limits are designed to provide reasonable protection against harmful interference in a residential installation. This equipment generates, uses, and can radiate radio frequency energy and, if not installed and used in accordance with the instructions, may cause harmful interference to radio communications. However, there is no guarantee that interference will not occur in a particular installation. If this equipment does cause harmful interference to radio or television reception, which can be determined by turning the equipment off and on, the user is encouraged to try to correct the interference by one or more of the following measures:

- Reorient or relocate the receiving antenna.
- Increase the separation between the equipment and receiver.
- Connect the equipment into an outlet on a circuit different from that to which the receiver is connected.
- Consult the dealer or an experienced radio/TV technician for help.

INSTRUCTIONS TO USERS: This equipment complies with the requirements of FCC (Federal Communication Commission) equipment provided that the following conditions are met. Some cables have to be used with the core set. Use the accessory cable or a designated-type cable for the connection. For cables that have a core only at one end, connect the core to the projector.

CAUTION: Changes or modifications not expressly approved by the party responsible for compliance could void the user's authority to operate the equipment.

For the Customers in CANADA

NOTICE: This Class B digital apparatus complies with Canadian ICES-003.

Warranty And After-Service

Unless seen any abnormal operations (mentioned with the first paragraph of WARNING in this manual), when a problem occurs with the equipment, first refer to the "Troubleshooting" section of the "Operating Guide", and run through the suggested checks. If this does not resolve the problem contact your dealer or service company. They will tell you what warranty condition is applied.

Contents

Introduction	3	SETUP menu	42
Features	3	AUTO KEYSTONE,  KEYSTONE, AUTO ECO MODE,	
Checking the contents of package	3	ECO MODE, MIRROR, STANDBY MODE,	
Part names	4	MONITOR OUT	
Setting up	7	AUDIO menu	45
Arrangement	7	VOLUME, SPEAKER, AUDIO SOURCE,	
Connecting with your devices	10	HDMI AUDIO, MIC LEVEL, MIC VOLUME	
Connecting to a power supply	15	SCREEN menu	47
Fastening the adapter cover	16	LANGUAGE, MENU POSITION, BLANK,	
Using the security bar and slot	16	START UP, MyScreen, MyScreen Lock,	
Remote control	17	MESSAGE, SOURCE NAME, TEMPLATE, C.C.	
Installing the batteries	17	OPTION menu	53
About the remote control signal	17	AUTO SEARCH, AUTO KEYSTONE,	
Changing the frequency of remote control signal	18	DIRECT POWER ON, AUTO POWER OFF,	
Using as a simple PC mouse & keyboard	18	USB TYPE B, LAMP TIME, FILTER TIME,	
Power on/off	19	MY BUTTON, MY SOURCE, SERVICE	
Turning on the power	19	NETWORK menu	63
Turning off the power	19	WIRELESS SETUP, WIRELESS INFORMATION,	
Operating	20	WIRED SETUP, WIRED INFORMATION,	
Adjusting the volume	20	PROJECTOR NAME, MY IMAGE,	
Temporarily muting the sound	20	AMX D.D., PRESENTATION, SERVICE	
Selecting an input signal	21	SECURITY menu	74
Searching an input signal	22	SECURITY PASSWORD CHANGE,	
Selecting an aspect ratio	22	MYSCREEN PASSWORD, PIN LOCK,	
Adjusting the projector's elevator	23	TRANSITION DETECTOR, MY TEXT PASSWORD,	
Adjusting the zoom and focus	23	MY TEXT DISPLAY, MY TEXT WRITING	
Using the automatic adjustment feature	24	Presentation tools	80
Adjusting the position	24	PC-LESS Presentation	80
Correcting the keystone distortions	25	Thumbnail Mode, Full Screen Mode,	
Using the magnify feature	26	Slideshow mode, Playlist	
Temporarily freezing the screen	27	USB Display	90
Temporarily blanking the screen	27	Starting USB Display,	
Using the menu function	28	Right-Click menu, Floating menu,	
EASY MENU	30	Options window	
ASPECT, AUTO KEYSTONE,  KEYSTONE,		Maintenance	94
PICTURE MODE, ECO MODE, MIRROR, RESET,		Replacing the lamp	94
FILTER TIME, LANGUAGE, ADVANCED MENU, EXIT		Cleaning and replacing the air filter	96
PICTURE menu	32	Other care	98
BRIGHTNESS, CONTRAST, GAMMA, COLOR TEMP,		Troubleshooting	99
COLOR, TINT, SHARPNESS, ACTIVE IRIS, MY MEMORY		Related messages	99
IMAGE menu	35	Regarding the indicator lamps	101
ASPECT, OVER SCAN, V POSITION, H POSITION,		Resetting all settings	103
H PHASE, H SIZE, AUTO ADJUST EXECUTE		Phenomena that may be easy	
INPUT menu	38	to be mistaken for machine defects	103
PROGRESSIVE, VIDEO NR, COLOR SPACE,		Specifications	108
COMPONENT, VIDEO FORMAT, HDMI FORMAT,			
HDMI RANGE, COMPUTER IN, FRAME LOCK,			
RESOLUTION			

Introduction

Features

The projector provides you with the broad use by the following features.

- ✓ This projector has a variety of I/O ports that supposedly cover for any business scene. The **HDMI** port can support various image equipment which have digital interface to get clearer pictures on a screen.
- ✓ If you insert a USB storage device, such as a USB memory, into the **USB TYPE A** port and select the port as the input source, you can view images stored in the device.
- ✓ This projector can be controlled and monitored via LAN connection. Furthermore, you can use the designated USB wireless adapter (optional) to establish wireless LAN connection.
- ✓ The built-in 16W speaker can deliver sufficient sound volume in a large space like a classroom without external speakers.

Checking the contents of package

Please see the **Contents of package** section in the **User's Manual (concise)** which is a book. Your projector should come with the items shown there. Require of your dealer immediately if any items are missing.

⚠ WARNING ► Keep small parts away from children and pets. Take care not to put in the mouth. If swallowed, consult a physician immediately for emergency treatment.

NOTE • Keep the original packing materials, for future reshipment. Be sure to use the original packing materials when moving the projector. Use special caution for the lens.

- The projector may make a rattling sound when tilted, moved or shaken, since a flap to control the air flow inside of the projector has moved. Be aware that this is not a failure or malfunction.

Part names

Projector

(1) Lamp cover (📖94)

The lamp unit is inside.

(2) Speaker (📖20, 45)

(3) Filter cover (📖96)

The air filter and intake vent are inside.

(4) Elevator feet (x2) (📖23)

(5) Elevator buttons (x2) (📖23)

(6) Remote sensor (📖17)

(7) Lens (📖98)

(8) Lens cover

(9) Intake vents

(10) Control panel (📖5)

(11) **FOCUS** ring (📖23)

(12) **ZOOM** ring (📖23)

(13) **AC IN** (AC inlet) (📖15)

(14) Exhaust vent

(15) Rear panel (📖5)

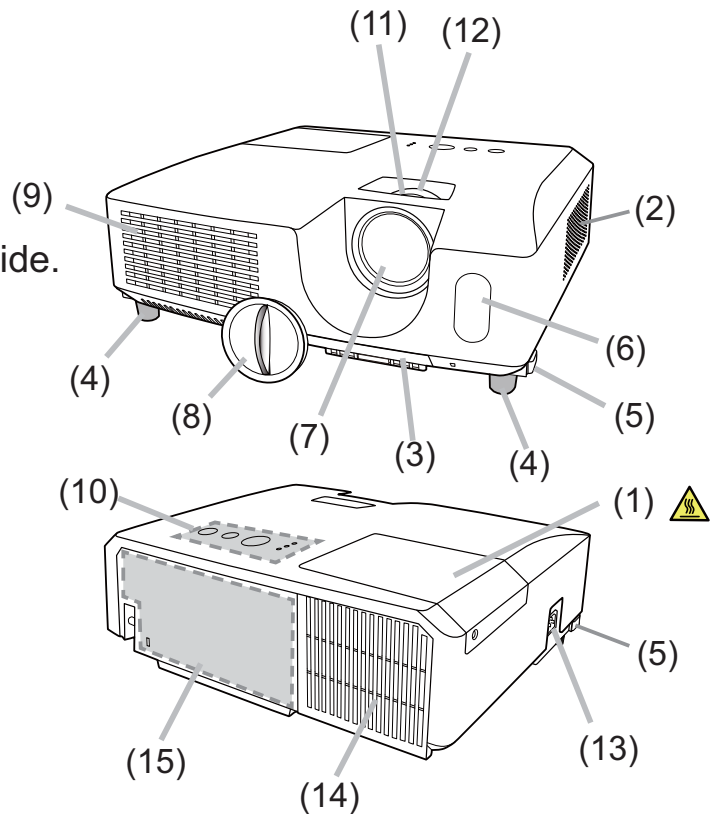

⚠️ WARNING ▶ Do not open or remove any portion of the product, unless the manuals direct it.

▶ Do not subject the projector to unstable conditions.

▶ Do not apply a shock or pressure to this product.

▶ Do not look into the lens and the openings on the projector while the lamp is on.

⚠️ CAUTION ▶ Do not touch around the lamp cover and the exhaust vents during use or just after use, since it is too hot.

▶ Do not attach anything onto the lens except the lens cover of this projector because it could damage the lens, such as melting the lens.



(continued on next page)

Part names (continued)

Control panel

- (1) **STANDBY/ON** button (📖 19)
- (2) **INPUT** button (📖 21)
- (3) **MENU** button (📖 28)
- (4) **LAMP** indicator (📖 101)
- (5) **TEMP** indicator (📖 101)
- (6) **POWER** indicator (📖 101)

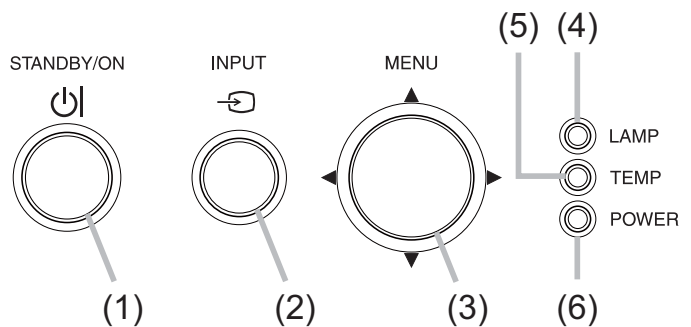

Rear panel (📖 10 ~ 14)

- (1) **LAN** port
- (2) **USB TYPE A** port
- (3) **HDMI** port
- (4) **USB TYPE B** port
- (5) **MIC** port (📖 14)
- (6) **AUDIO IN1** port
- (7) **AUDIO IN2** port
- (8) **AUDIO IN3 (R,L)** ports
- (9) **AUDIO OUT (R,L)** ports
- (10) **COMPUTER IN1** port
- (11) **COMPUTER IN2** port
- (12) **MONITOR OUT** port
- (13) **CONTROL** port
- (14) **COMPONENT** ports (Y, Cb/Pb, Cr/Pr)
- (15) **VIDEO** port
- (16) **S-VIDEO** port
- (17) Security slot (📖 16)
- (18) Security bar (📖 16)

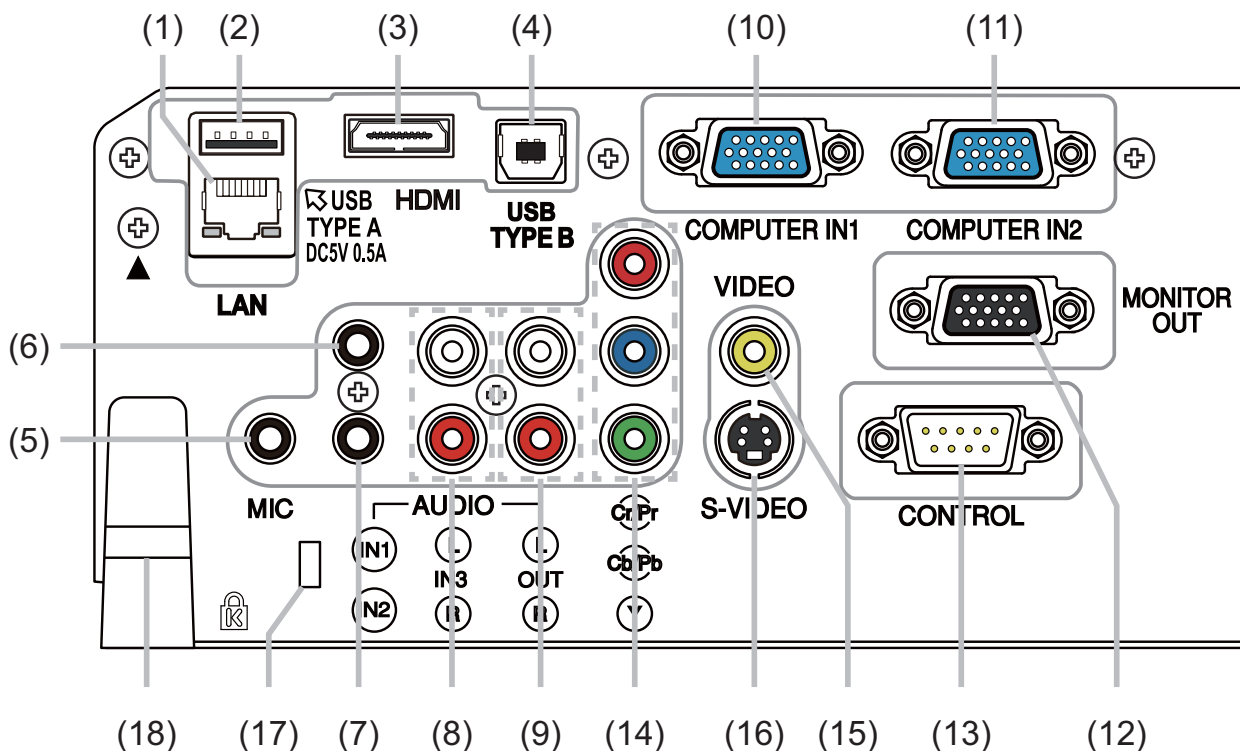

(continued on next page)

Part names (continued)

Remote control

- (1) **VIDEO** button (📖21)
- (2) **COMPUTER** button (📖21)
- (3) **SEARCH** button (📖22)
- (4) **STANDBY/ON** button (📖19)
- (5) **ASPECT** button (📖22)
- (6) **AUTO** button (📖24)
- (7) **BLANK** button (📖27)
- (8) **MAGNIFY - ON** button (📖26)
- (9) **MAGNIFY - OFF** button (📖26)
- (10) **MY SOURCE/DOC.CAMERA** button (📖21, 57)
- (11) **VOLUME -** button (📖20)
- (12) **PAGE UP** button (📖18)
- (13) **PAGE DOWN** button (📖18)
- (14) **VOLUME +** button (📖20)
- (15) **MUTE** button (📖20)
- (16) **FREEZE** button (📖27)
- (17) **MY BUTTON - 1** button (📖56, 57)
- (18) **MY BUTTON - 2** button (📖56, 57)
- (19) **KEystone** button (📖26)
- (20) **POSITION** button (📖24, 29)
- (21) **MENU** button (📖28)
- (22) **▲/▼/◀/▶** cursor buttons (📖28)
- (23) **ENTER** button (📖28)
- (24) **ESC** button (📖28)
- (25) **RESET** button (📖29)
- (26) **Battery cover** (📖17)

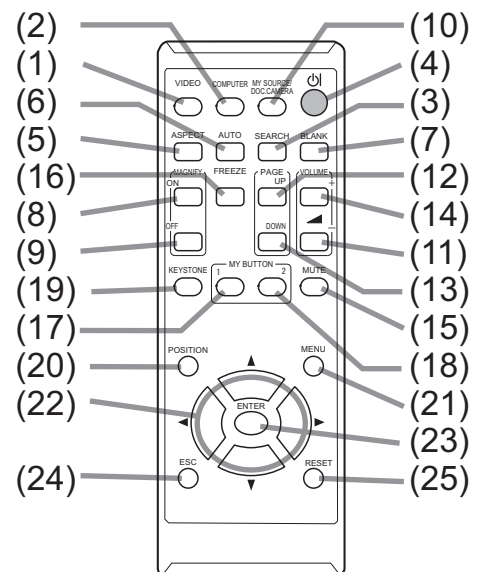

Back of the remote control

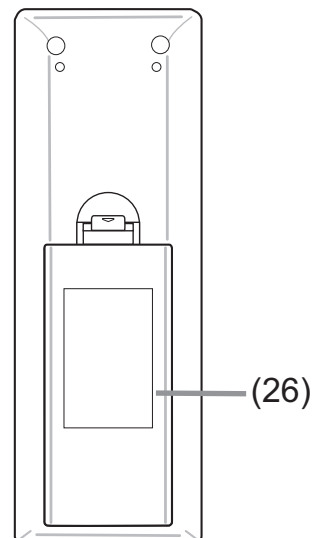

Setting up

Install the projector according to the environment and manner the projector will be used in.

For the case of installation in a special state such as ceiling mount, the specified mounting accessories ( **Specifications** in the **User's Manual (concise)**) and service may be required. Before installing the projector, consult your dealer about your installation.

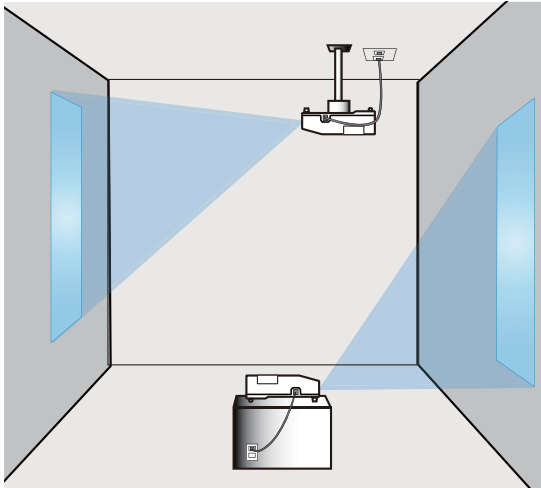

Arrangement

Refer to tables **T-1** and **T-2** at the back of **User's Manual (concise)** as well as the following to determine the screen size and projection distance. The values shown in the table are calculated for a full size screen.

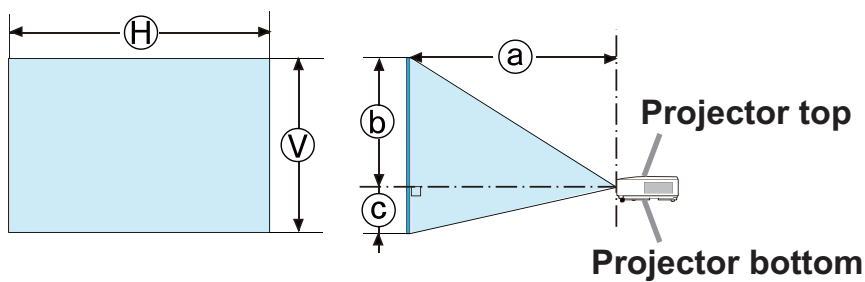

$H \times V$: Screen size

a : Projection distance (from the projector's end)

b , c : Screen height

(continued on next page)

Arrangement (continued)

⚠ WARNING ▶ Install the projector where you can access the power outlet easily. If an abnormality should occur, unplug the projector urgently. Otherwise it could cause a fire or electric shock.

▶ Do not subject the projector to unstable conditions. If the projector falls or topples over, it could result in injury or damage to the projector and the surrounding things. Using a damaged projector could result in a fire and an electric shock.

- Do not place the projector in unstable places, such as an inclined surface, places subject to vibration, on top of a wobbly table or cart, or a surface that is smaller than the projector.
- Do not put the projector on its side, front or rear position.
- Do not attach nor place anything on the projector unless otherwise specified in the manual.
- Do not use any mounting accessories except the accessories specified by the manufacturer. Read and keep the manuals of the accessories used.
- For special installation such as ceiling mounting, be sure to consult your dealer beforehand.

▶ Do not install the projector near thermally conductive or flammable things. Such things when heated by the projector could result in a fire and burns.

- Do not place the projector on a metal stand.

▶ Do not place the projector where any oils, such as cooking or machine oil, are used. Oil may harm the product, resulting in malfunction, or falling from the mounted position.

▶ Do not place the projector in a place where it may get wet. Getting the projector wet or inserting liquid into the projector could cause a fire and an electric shock, and damage the projector.

- Do not place the projector near water, such as in a bathroom, kitchen, or poolside.
- Do not place the projector outdoors or by the window.
- Do not place anything containing liquid near the projector.

(continued on next page)

Arrangement (continued)

⚠ CAUTION ▶ Place the projector in a cool place with sufficient ventilation. The projector may shutdown automatically or may malfunction if its internal temperature is too high.

Using a damaged projector could result in a fire and an electric shock.

- Do not place the projector in direct sunlight or near hot objects such as heaters.
- Do not place the projector where the air from an air conditioner or similar unit will blow on it directly.
- Keep a space of 30 cm or more between a side of the projector and other objects such as walls.
- Do not place the projector on carpet, cushions or bedding.
- Do not stop up, block nor cover the projector's vent holes. Do not place anything around the projector that could be sucked in or stuck to the projector's intake vents.
- Do not place the projector at places that are exposed to magnetic fields, doing so can cause the cooling fans inside the projector to malfunction.

▶ Avoid placing the projector in smoky, humid or dusty place. Placing the projector in such places could cause a fire, an electric shock and malfunction of the projector.

- Do not place the projector near humidifiers. Especially for an ultrasonic humidifier, chlorine and minerals contained in tap water are atomized and could be deposited in the projector causing image degradation or other problems.
- Do not place the projector in a smoking area, kitchen, passageway or by the window.

NOTICE • Position the projector to prevent light from directly hitting the projector's remote sensor.

- Do not place the product in a place where radio interference may be caused.
- Check and correct the setting for FAN SPEED of SERVICE in the OPTION menu according to the usage environment ( 57). If the projector is used with a wrong setting, it may cause damage to the projector itself or the parts inside.
- Keep heat-sensitive things away from the projector. Otherwise, they may be damaged by the heat from the projector.

Connecting with your devices

Before connecting the projector to a device, consult the manual of the device to confirm that the device is suitable for connecting with this projector and prepare the required accessories, such as a cable in accord with the signal of the device. Consult your dealer when the required accessory did not come with the product or the accessory is damaged.

After making sure that the projector and the devices are turned off, perform the connection, according to the following instructions. Refer to the figures in subsequent pages.

Before connecting the projector to a network system, be sure to read **Network Guide** too.

⚠ WARNING ► **Use only the appropriate accessories.** Otherwise it could cause a fire or damage the projector and devices.

- Use only the accessories specified or recommended by the projector's manufacturer. It may be regulated under some standard.
- Neither disassemble nor modify the projector and the accessories.
- Do not use the damaged accessory. Be careful not to damage the accessories. Route a cable so that it is neither stepped on nor pinched out.

⚠ CAUTION ► **For a cable with a core at only one end, connect the end with the core to the projector.** That may be required by EMI regulations.

NOTE • Do not turn on or off the projector while connected to a device in operation, unless that is directed in the manual of the device. Otherwise it may cause malfunction in the device or projector.

- The function of some input ports can be selected according to your usage requirements. Check the reference page indicated beside each port in the following illustration.
- Be careful not to mistakenly connect a connector to a wrong port. Otherwise it may cause malfunction in the device or projector.
 - When connecting a connector to a port, make sure that the shape of the connector fits the port.
 - Tighten the screws to connect a connector equipped with screws to a port.
 - Use the cables with straight plugs, not L-shaped ones, as the input ports of the projector are recessed.

About Plug-and-Play capability

- Plug-and-Play is a system composed of a computer, its operating system and peripheral equipment (i.e. display devices). This projector is VESA DDC 2B compatible. Plug-and-Play can be used by connecting this projector to a computer that is VESA DDC (display data channel) compatible.
 - Take advantage of this feature by connecting a computer cable to the **COMPUTER IN1** port (DDC 2B compatible). Plug-and-Play may not work properly if any other type of connection is attempted.
 - Please use the standard drivers in your computer as this projector is a Plug-and-Play monitor.

(continued on next page)

Connecting with your devices (continued)

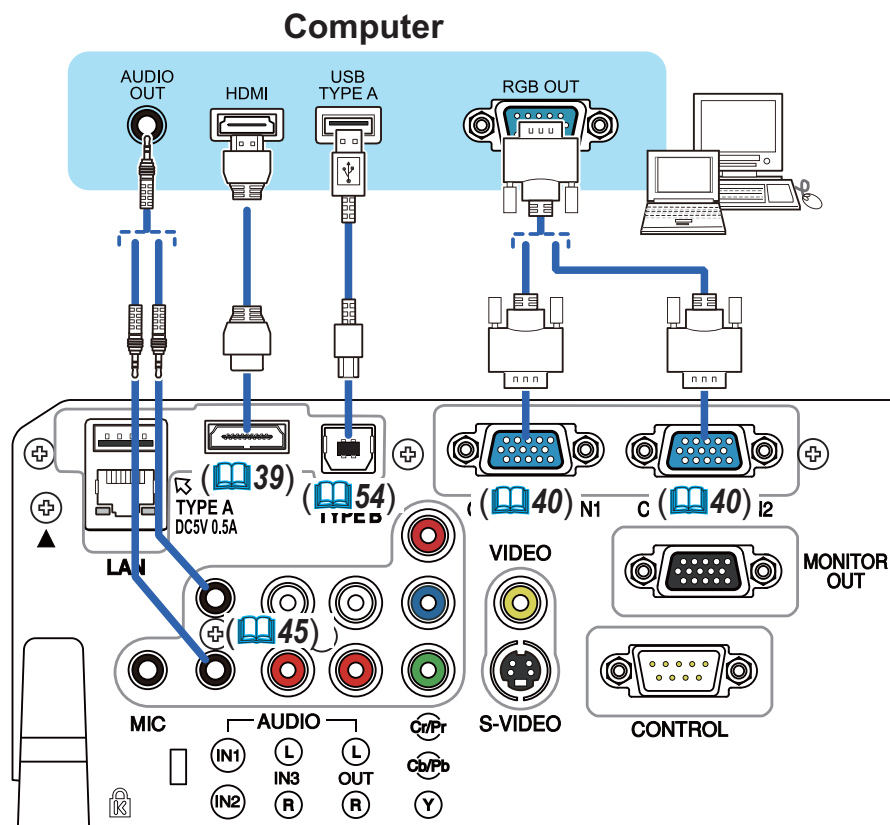

- NOTE** • Before connecting the projector to a computer, consult the computer's manual and check the compatibility of the signal level, the synchronization methods and the display resolution output to the projector.
- Some signal may need an adapter to input this projector.
 - Some computers have multiple screen display modes that may include some signals which are not supported by this projector.
 - Although the projector can display signals with resolution up to UXGA (1600x1200), the signal will be converted to the projector's panel resolution before being displayed. The best display performance will be achieved if the resolutions of the input signal and the projector panel are identical.
 - If you connect this projector and a notebook computer, you need output the display to an external monitor, or output simultaneously to the internal display and an external monitor. Consult the computer's manual for the setting.
 - Depending on the input signal, the automatic adjustment function of this projector may take some time and not function correctly.
 - Note that a composite sync signal or sync-on-green signal may confuse the automatic adjustment function of this projector (40).
 - If the automatic adjustment function does not work correctly, you may not see the dialog to set the display resolution. In such a case, use an external display device. You may be able to see the dialog and set an appropriate display resolution.

(continued on next page)

Connecting with your devices (continued)

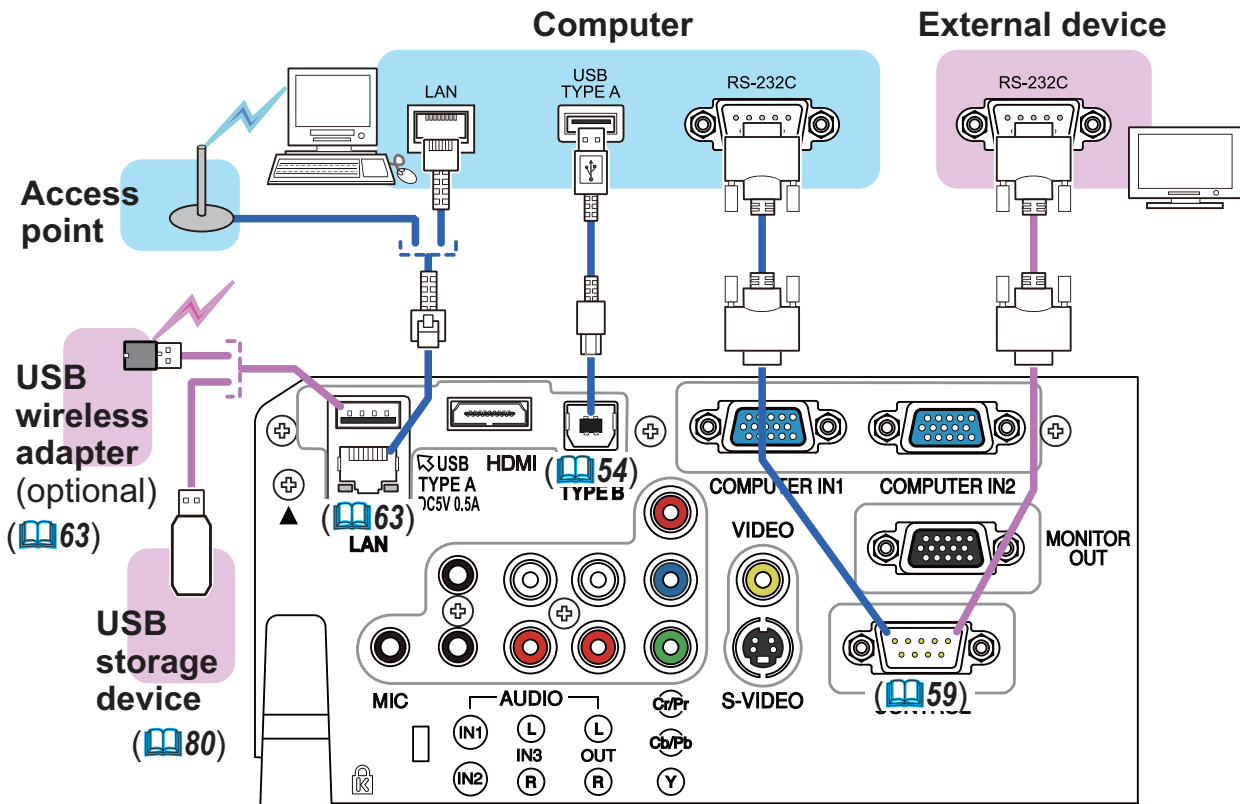

⚠ CAUTION ▶ Before connecting the projector to a network system be sure to obtain the consent of the administrator of the network.

▶ Do not connect the **LAN** port to any network that might have the excessive voltage.

▶ The designated USB wireless adapter that is sold as an option is required to use the wireless network function of this projector.

▶ Before removing the USB storage device from the port of the projector, be sure to use the REMOVE USB function on the thumbnail screen to secure your data (📖83).

▶ Do not use any extension cable or device when connecting the adapter to the projector. Before you insert or pull out the USB wireless adapter from the projector, turn off the power of the projector and pull out the power cord's plug from the outlet. Do not touch the USB wireless adapter while the projector is receiving AC power.

▶ To connect both the LAN cable and USB device to the projector, use a LAN cable that is flat on the side where the plug's wire is visible. Otherwise, both of them cannot be connected correctly, or the wire may break (malfunction).

NOTE • If an oversized USB storage device blocks the **LAN** port, use a USB extension cable to connect the USB storage device.

(continued on next page)

Connecting with your devices (continued)

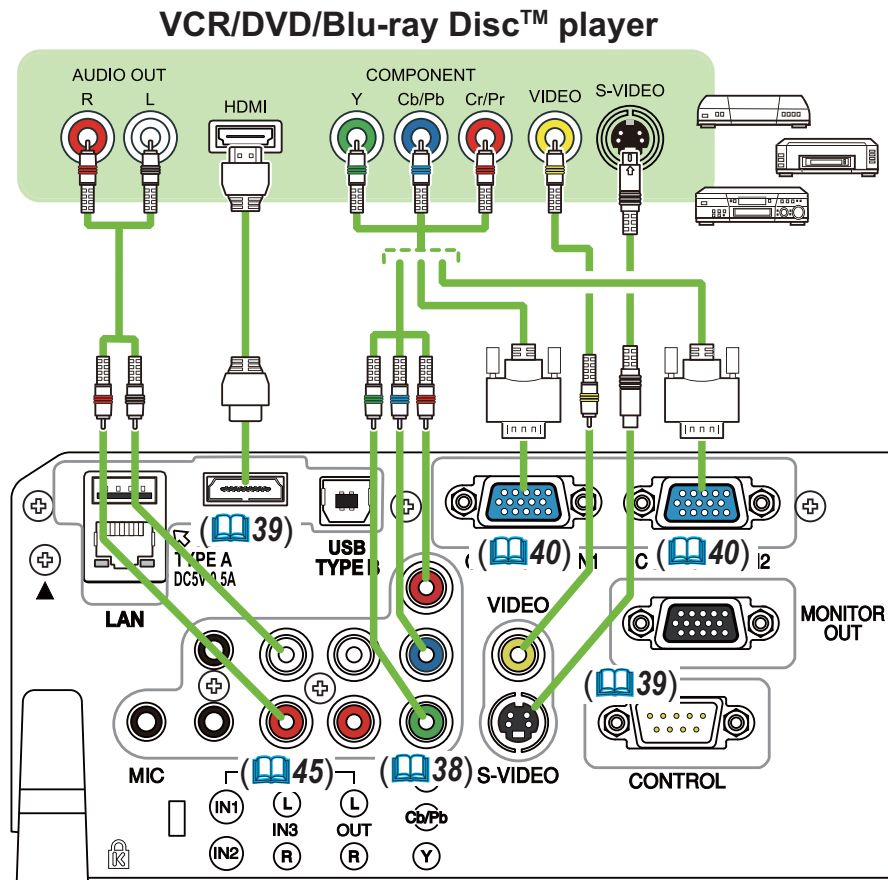

NOTE • The **HDMI** port of this model is compatible with HDCP (High-bandwidth Digital Content Protection) and therefore capable of displaying a video signal from HDCP compatible DVD players or the like.

- The **HDMI** supports the following signals.

Video signal : 480i@60, 480p@60, 576i@50, 576p@50, 720p@50/60, 1080i@50/60, 1080p@50/60

Audio signal : Format Linear PCM

Sampling frequency 48kHz / 44.1kHz / 32kHz

- This projector can be connected with another equipment that has HDMI™ connector, but with some equipment the projector may not work properly, something like no video.

- Be sure to use an HDMI™ cable that has the HDMI™ logo.

- Use a Category 2-certified HDMI™ cable to input 1080p@50/60 signal to the projector.

- When the projector is connected with a device having DVI connector, use a DVI to HDMI™ cable to connect with the **HDMI** input.

(continued on next page)

Connecting with your devices (continued)

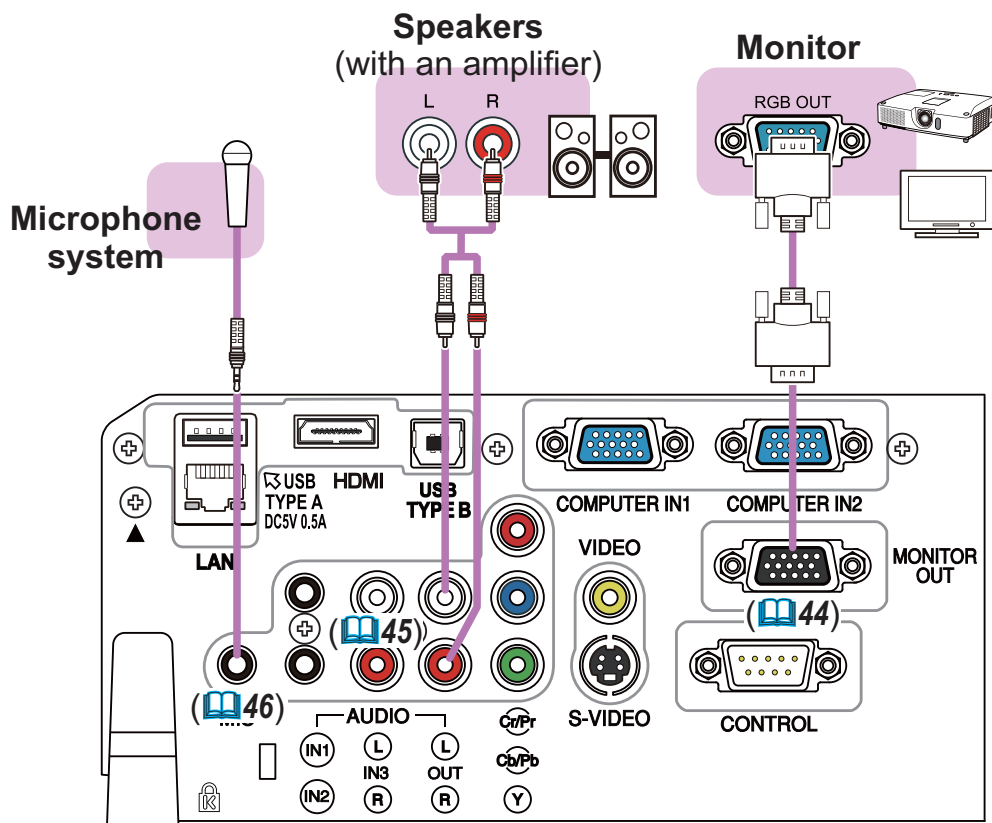

NOTE • If a loud feedback noise is produced from the speaker, move the microphone away from the speaker.

Microphone function

- You can connect a dynamic microphone to the **MIC** port with a 3.5 mm mini-plug. In that case, the built-in speaker outputs the sound from the microphone, even while the sound from the projector is output. You can input line level signal to the **MIC** port from equipment such as wireless microphone. Select HIGH in the MIC LEVEL item of the AUDIO menu when you input line level audio signal to the **MIC** port. In the normal mode, the volume of the microphone can be adjusted separately from the volume of the projector using the menu (46). In the standby mode, the volume of the microphone is adjustable with the **VOLUME +/-** buttons on the remote control, in synchronization with the volume of the projector (20). Even when the sound of projector is set to mute mode by the AUDIO SOURCE function (45), the volume of the microphone is adjustable.
- In both modes (standby or normal), the **MUTE** button on the remote control works on the sounds of the microphone and the projector (20).
- This projector doesn't support plug-in power for the microphone.

Connecting to a power supply

1. Put the connector of the power cord into the **AC IN** (AC inlet) of the projector.
2. Firmly plug the power cord's plug into the outlet. In a couple of seconds after the power supply connection, the **POWER** indicator will light up in steady orange.

Please remember that when the DIRECT POWER ON function activated (📖53), the connection of the power supply make the projector turn on.

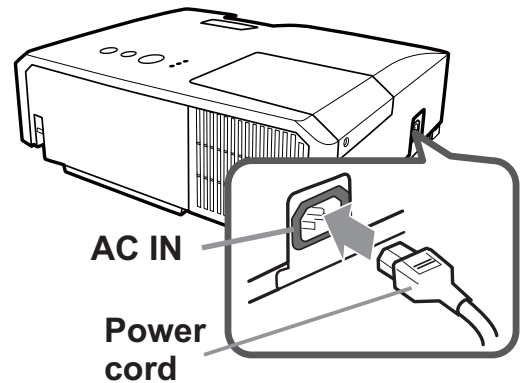

⚠ WARNING ► Please use extra caution when connecting the power cord, as incorrect or faulty connections may result in fire and/or electrical shock.

- Do not touch the power cord with a wet hand.
- Only use the power cord that came with the projector. If it is damaged, consult your dealer to get a new one. Never modify the power cord.
- Only plug the power cord into an outlet whose voltage is matched to the power cord. The power outlet should be close to the projector and easily accessible. Remove the power cord for complete separation.
- Do not distribute the power supply to multiple devices. Doing so may overload the outlet and connectors, loosen the connection, or result in fire, electric shock or other accidents.
- Connect the ground terminal for the AC inlet of this unit to the ground terminal of the building using an appropriate power cord (bundled).

NOTICE ► This product is also designed for IT power systems with a phase-to-phase voltage of 220 to 240 V.

Fastening the adapter cover

Use the supplied adapter cover to prevent the USB wireless adapter from coming off easily.

1. Loosen the screw (marked with triangle) on the bottom left of the **USB TYPE A** port.
2. Insert the tab of the cover into the hole at the upper right of the **USB TYPE A** port in the direction of the arrow.
3. Align the screw holes on the projector and the cover. Then insert the screw removed from the projector into the hole and tighten the screw.

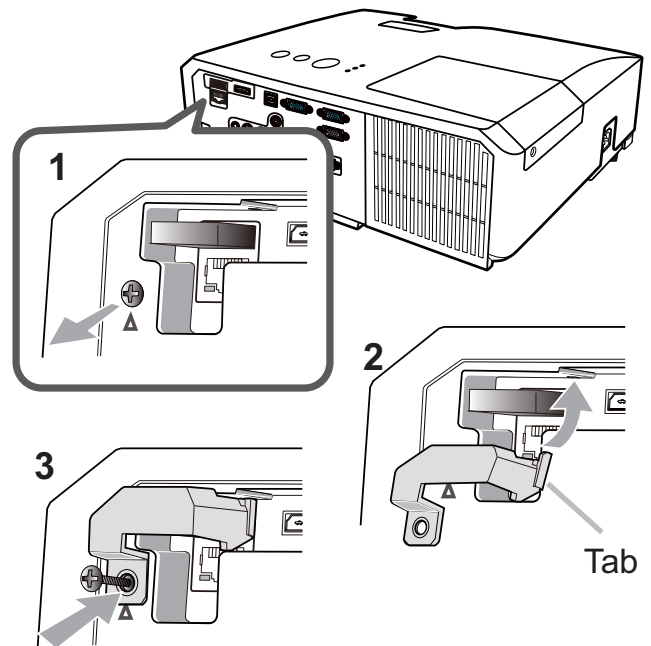

⚠ WARNING ▶ Keep small parts away from children and pets. Take care not to put in the mouth.

Using the security bar and slot

A commercially available anti-theft chain or wire can be attached to the security bar on the projector. Refer to the figure to choose an anti-theft chain or wire.

Also this product has the security slot for the Kensington lock.

For details, see the manual of the security tool.

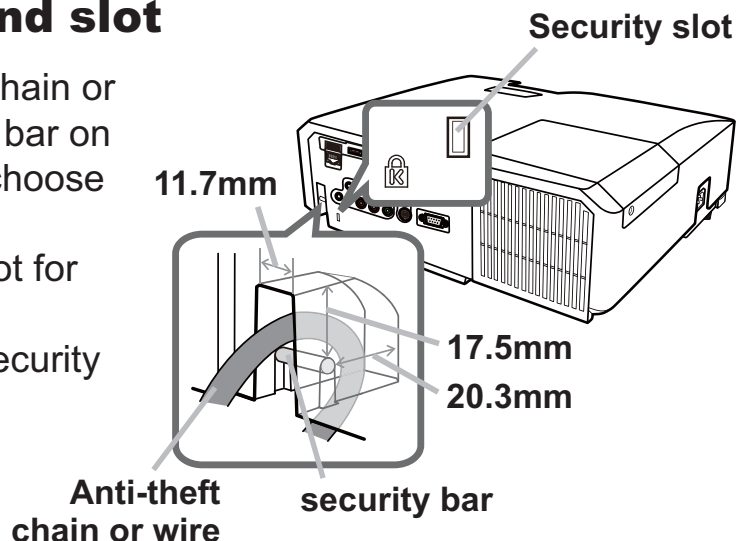

⚠ WARNING ▶ Do not use the security bar and slot to prevent the projector from falling down, since it is not designed for it.

⚠ CAUTION ▶ Do not place anti-theft chain or wire near the exhaust vents. It may become too hot.

NOTE • The security bar and slot is not comprehensive theft prevention measures. It is intended to be used as supplemental theft prevention measure.

Remote control

Installing the batteries

Please insert the batteries into the remote control before using it. If the remote control starts to malfunction, try to replace the batteries. If you will not use the remote control for long period, remove the batteries from the remote control and store them in a safe place.

1. Holding the hook part of the battery cover, remove it.
2. Align and insert the two AA batteries (**HITACHI MAXELL, Part No.LR6 or R6P**) according to their plus and minus terminals as indicated in the remote control.
3. Replace the battery cover in the direction of the arrow and snap it back into place.

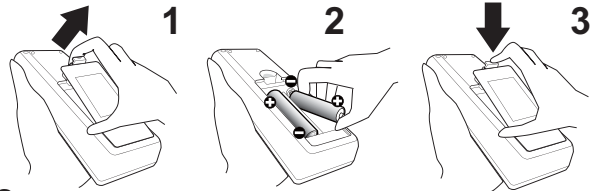

⚠ WARNING ► Always handle the batteries with care and use them only as directed. Improper use may result in battery explosion, cracking or leakage, which could result in fire, injury and/or pollution of the surrounding environment.

- Be sure to use only the batteries specified. Do not use batteries of different types at the same time. Do not mix a new battery with used one.
- Make sure the plus and minus terminals are correctly aligned when loading a battery.
- Keep a battery away from children and pets.
- Do not recharge, short circuit, solder or disassemble a battery.
- Do not place a battery in a fire or water. Keep batteries in a dark, cool and dry place.
- If you observe battery leakage, wipe out the leakage and then replace a battery. If the leakage adheres to your body or clothes, rinse well with water immediately.
- Obey the local laws on disposing the battery.

About the remote control signal

The remote control works with the projector's remote sensor. This projector has a remote sensor on the front. The sensor senses the signal within the following range when the sensor is active:

60 degrees (30 degrees to the left and right of the sensor)
within 3 meters about.

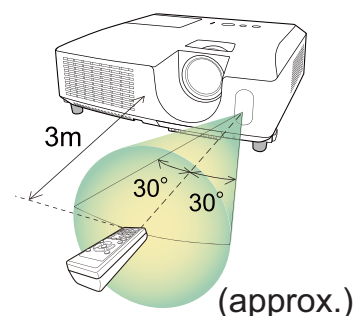

NOTE • The remote control signal reflected in the screen or the like may be available. If it is difficult to send the signal to the sensor directly, attempt to make the signal reflect.

- The remote control uses infrared light to send signals to the projector (Class 1 LED), so be sure to use the remote control in an area free from obstacles that could block the remote control's signal to the projector.
- The remote control may not work correctly if strong light (such as direct sun light) or light from an extremely close range (such as from an inverter fluorescent lamp) shines on the remote sensor of the projector. Adjust the position of projector avoiding those lights.

Changing the frequency of remote control signal

The accessory remote control has the two choices on signal frequency Mode 1:NORMAL and Mode 2:HIGH. If the remote control does not function properly, attempt to change the signal frequency. In order to set the Mode, please keep pressing the combination of two buttons listed below simultaneously for about 3 seconds.

- (1) Set to Mode 1:NORMAL... **VOLUME -** and **RESET** buttons
- (2) Set to Mode 2:HIGH... **MAGNIFY OFF** and **ESC** buttons

Please remember that the REMOTE FREQ. in the SERVICE item of the OPTION menu (📖58) of the projector to be controlled should be set to the same mode as the remote control.

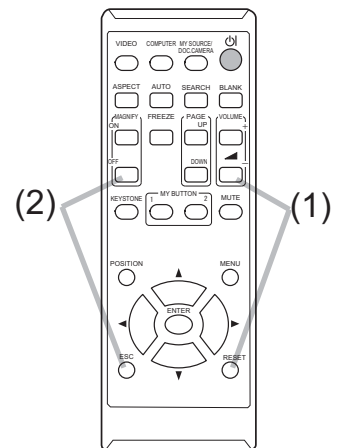

Using as a simple PC mouse & keyboard

The accessory remote control works as a simple mouse and keyboard of the computer, when the projector's **USB TYPE B** port and the computer's type A USB port are connected and MOUSE is selected for the USB TYPE B item in the OPTION menu (📖54).

- (1) **PAGE UP key:** Press **PAGE UP** button.
- (2) **PAGE DOWN key:** Press **PAGE DOWN** button.
- (3) **Mouse left button:** Press **ENTER** button.
- (4) **Move pointer:** Use the cursor buttons **▲**, **▼**, **◀** and **▶**.
- (5) **ESC key:** Press **ESC** button.
- (6) **Mouse right button:** Press **RESET** button.

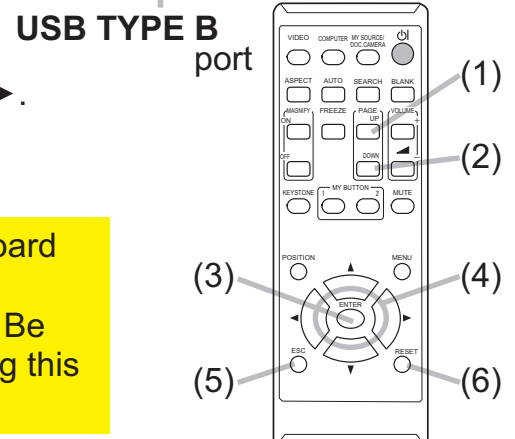
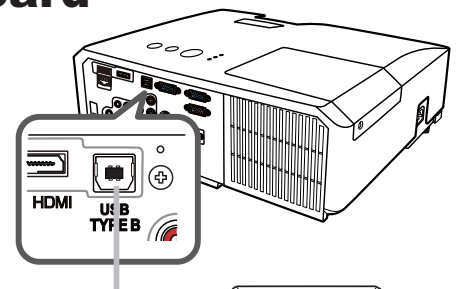

NOTICE ▶ Improper use of the simple mouse & keyboard function could damage your equipment. While using this function, please connect this product only to a computer. Be sure to check your computer's manuals before connecting this product to the computer.

NOTE When the simple mouse & keyboard function of this product does not work correctly, please check the following.

- When a USB cable connects this projector with a computer having a built-in pointing device (e.g. track ball) like a laptop PC, open BIOS setup menu, then select the external mouse and disable the built-in pointing device, because the built-in pointing device may have priority to this function.
- Windows 95 OSR 2.1 or higher is required for this function. And also this function may not work depending on the computer's configurations and mouse drivers. This function can work with the computer which can operate general USB mouse or keyboard.
- You cannot do things like press two buttons at once (for instance, pressing two buttons at the same time to move the mouse pointer diagonally).
- This function is activated only when the projector is working properly. This function is not available in any of the following cases:
 - While the lamp is warming up. (The **POWER** indicator blinks in green.)
 - When either **USB TYPE A** or **USB TYPE B** port is selected.
 - While displaying BLANK (📖47), TEMPLATE (📖51) or MY IMAGE (📖71) screen.
 - When any menu is displayed on the screen.
 - While using the cursor buttons to operate the sound or screen functions such as adjusting the sound volume, correcting the keystone, correcting the picture position and magnifying the screen.

Power on/off

Turning on the power

1. Make sure that the power cord is firmly and correctly connected to the projector and the outlet.
2. Make sure that the **POWER** indicator is steady orange (📖101). Then remove the lens cover.
3. Press **STANDBY/ON** button on the projector or the remote control.
The projection lamp will light up and **POWER** indicator will begin blinking in green. When the power is completely on, the indicator will stop blinking and light in steady green (📖101).

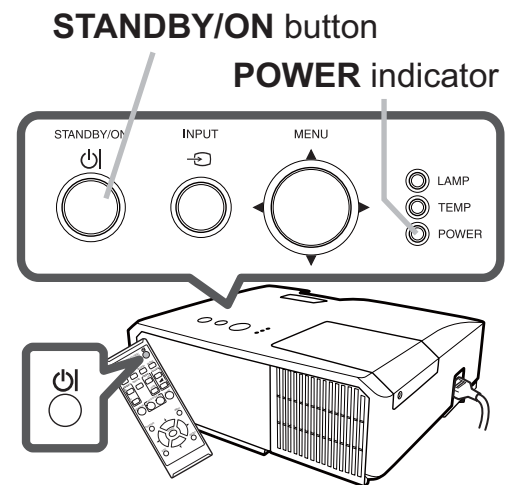

To display the picture, select an input signal according to the section **Selecting an input signal** (📖21).

Turning off the power

1. Press the **STANDBY/ON** button on the projector or the remote control.
The message "Power off?" will appear on the screen for about 5 seconds.
2. Press the **STANDBY/ON** button again while the message appears.
The projector lamp will go off, and the **POWER** indicator will begin blinking in orange. Then **POWER** indicator will stop blinking and light in steady orange when the lamp cooling is complete (📖101).
3. Attach the lens cover, after the **POWER** indicator turns in steady orange.

Do not turn the projector on for about 10 minutes or more after turning it off. Also, do not turn the projector off shortly after turning it on. Such operations might cause the lamp to malfunction or shorten the lifetime of some parts including the lamp.

⚠ WARNING ▶ A strong light is emitted when the projector's power is on. Do not look into the lens of the projector or look inside of the projector through any of the projector's openings.
▶ Do not touch around the lamp cover and the exhaust vents during use or just after use, since it is too hot.

NOTE • Turn the power on/off in right order. Please power on the projector prior to the connected devices.
• This projector has the function that can make the projector automatically turn on/off. Please refer to the **DIRECT POWER ON** (📖53) and **AUTO POWER OFF** (📖54) items of the **OPTION** menu.

Operating

Adjusting the volume

VOLUME +/- button

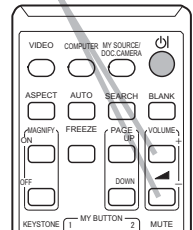

1. Use the **VOLUME +/VOLUME -** buttons to adjust the volume.
 - A dialog will appear on the screen to aid you in adjusting the volume. If you do not do anything, the dialog will automatically disappear after a few seconds.
 - When \times is selected for current picture input port, the volume adjustment is disabled. Please see AUDIO SOURCE item of AUDIO menu (📖45).
 - Even if the projector is in the standby mode, the volume is adjustable when both of the following conditions are true:
 - An option other than \times is selected for STANDBY in the AUDIO SOURCE item of the AUDIO menu (📖45).
 - NORMAL is selected in the STANDBY MODE item of the SETUP menu (📖44).
 - In the standby mode, the volume of the microphone is adjustable with the **VOLUME +/-** buttons on the remote control, in synchronization with the volume of the projector.

Temporarily muting the sound

MUTE button

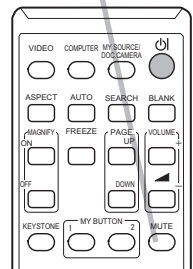

1. Press **MUTE** button on the remote control.
 - A dialog will appear on the screen indicating that you have muted the sound. To restore the sound, press the **MUTE, VOLUME +** or **VOLUME -** button. Even if you do not do anything, the dialog will automatically disappear after a few seconds.
 - When \times is selected for current picture input port, the sound is always muted. Please see AUDIO SOURCE item of AUDIO menu (📖45).
 - C.C. (Closed Caption) is automatically activated when sound is muted and an input signal containing C.C. is received. This function is available only when the signal is NTSC for **VIDEO** or **S-VIDEO**, or 480i@60 for **COMPONENT, COMPUTER IN1** or **COMPUTER IN2**, and when AUTO is selected for DISPLAY in the C.C. menu under the SCREEN menu (📖52).

Selecting an input signal

1. Press **INPUT** button on the projector.
 - Each time you press the button, the projector switches its input port from the current port as below.

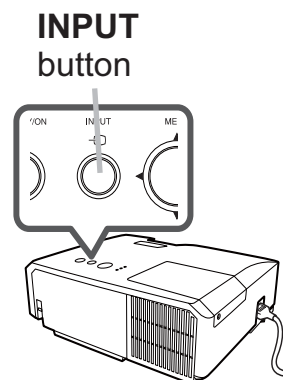
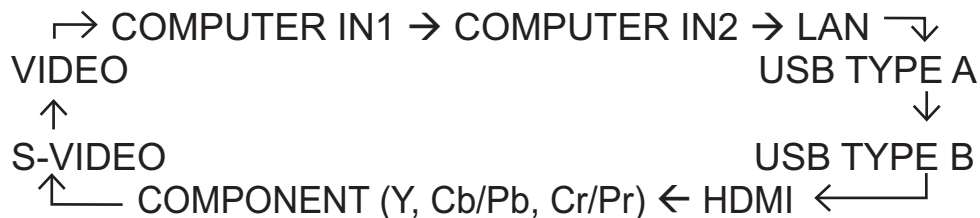

- While ON is selected for AUTO SEARCH item in OPTION menu ([53](#)), the projector will keep checking the ports in above order repeatedly till an input signal is detected.
- It may take several seconds to project the images from the **USB TYPE B** port.

1. Press **COMPUTER** button on the remote control.
 - Each time you press the button, the projector switches its input port from the current port as below.



COMPUTER button

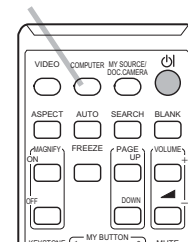

- While ON is selected for AUTO SEARCH item in OPTION menu, the projector will keep checking every port sequentially till an input signal is detected ([53](#)). If **COMPUTER** button is pressed when **VIDEO**, **S-VIDEO**, **COMPONENT** or **HDMI** port is selected, the projector will check **COMPUTER IN1** port first.
- It may take several seconds to project the images from the **USB TYPE B** port.

1. Press **VIDEO** button on the remote control.
 - Each time you press the button, the projector switches its input port from the current port as below.

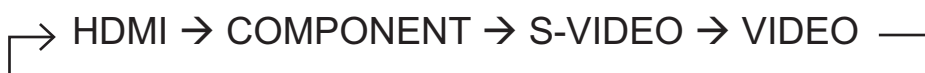

VIDEO button

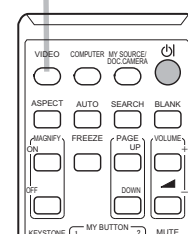

- While ON is selected for AUTO SEARCH item in OPTION menu, the projector will keep checking every port sequentially till an input signal is detected ([53](#)). If **VIDEO** button is pressed when **COMPUTER IN1**, **COMPUTER IN2**, **LAN**, **USB TYPE A** or **USB TYPE B** port is selected, the projector will check **HDMI** port first.

1. Press the **MY SOURCE / DOC. CAMERA** button on the remote control. The input signal will be changed into the signal you set as MY SOURCE ([57](#)).

MY SOURCE / DOC. CAMERA button

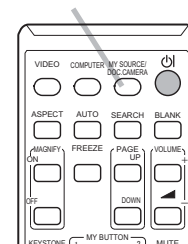

- This function also can use for document camera. Select the input port that connected the document camera.

Searching an input signal

1. Press **SEARCH** button on the remote control.
 - The projector will start to check its input ports as below in order to find any input signals. When an input is found, the projector will stop searching and display the image. If no signal is found, the projector will return to the state selected before the operation.

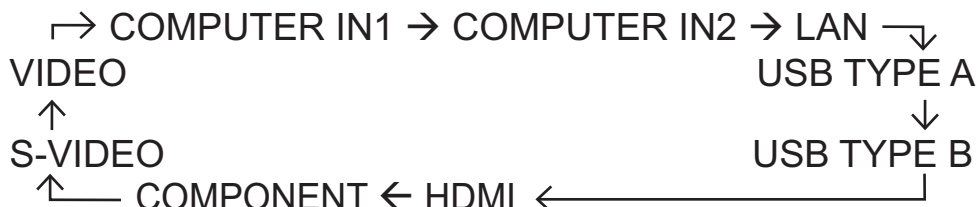

SEARCH button

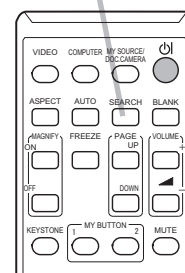

- While ON is selected for AUTO SEARCH item in OPTION menu (📖 53), the projector will keep checking the ports in above order repeatedly till an input signal is detected.
- It may take several seconds to project the images from the **USB TYPE B** port.

Selecting an aspect ratio

1. Press **ASPECT** button on the remote control.
 - Each time you press the button, the projector switches the mode for aspect ratio in turn.

ASPECT button

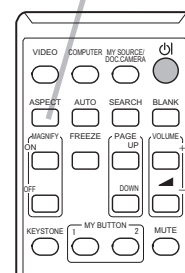

○ For a computer signal

CP-X2514WN, CP-X3014WN, CP-X4014WN:

NORMAL → 4:3 → 16:9 → 16:10



CP-WX3014WN: NORMAL → 4:3 → 16:9 → 16:10 → NATIVE



○ For an HDMI™ signal

CP-X2514WN, CP-X3014WN, CP-X4014WN:

NORMAL → 4:3 → 16:9 → 16:10 → 14:9



CP-WX3014WN: NORMAL → 4:3 → 16:9 → 16:10 → 14:9 → NATIVE



○ For a video signal, s-video signal or component video signal

CP-X2514WN, CP-X3014WN, CP-X4014WN:

4:3 → 16:9 → 14:9



CP-WX3014WN: 4:3 → 16:9 → 16:10 → 14:9 → NATIVE

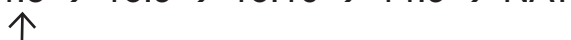

○ For an input signal from the LAN, USB TYPE A or USB TYPE B port, or if there is no signal

CP-X2514WN, CP-X3014WN, CP-X4014WN: 4:3 (fixed)

CP-WX3014WN: 16:10 (fixed)

- **ASPECT** button does not work when no proper signal is inputted.
- **NORMAL** mode keeps the original aspect ratio setting.

Adjusting the projector's elevator

When the place to put the projector is slightly uneven to the left or right, use the elevator feet to place the projector horizontally.

Using the feet can also tilt the projector in order to project at a suitable angle to the screen, elevating the front side of the projector within 14 degrees.

This projector has 2 elevator feet and 2 elevator buttons. An elevator foot is adjustable while pushing the elevator button on the same side as it.

1. Holding the projector, push the elevator buttons to loose the elevator feet.
2. Position the front side of the projector to the desired height.
3. Release the elevator buttons in order to lock the elevator feet.
4. After making sure that the elevator feet are locked, put the projector down gently.
5. If necessary, the elevator feet can be manually twisted to make more precise adjustments. Hold the projector when twisting the feet.

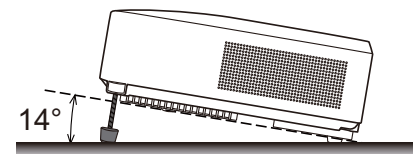

To loose an elevator foot, push the elevator button on the same side as it.

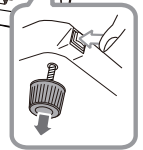

To finely adjust, twist the foot.

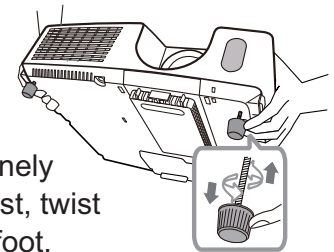

⚠ CAUTION ► Do not handle the elevator buttons without holding the projector, since the projector may drop down.

► Do not tilt the projector other than elevating its front within 14 degrees using the adjuster feet. A tilt of the projector exceeding the restriction could cause malfunction or shortening the lifetime of consumables, or the projector itself.

Adjusting the zoom and focus

1. Use the **ZOOM** ring to adjust the screen size.
2. Use the **FOCUS** ring to focus the picture.

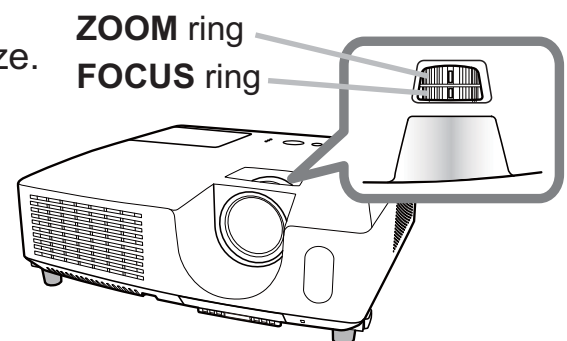

Using the automatic adjustment feature

1. Press **AUTO** button on the remote control.

AUTO button

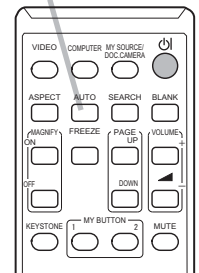

○ **For a computer signal**

The vertical position, the horizontal position and the horizontal phase will be automatically adjusted.

Make sure that the application window is set to its maximum size prior to attempting to use this feature. A dark picture may still be incorrectly adjusted. Use a bright picture when adjusting.

○ **For a video signal and s-video signal**

The video format best suited for the respective input signal will be selected automatically. This function is available only when the AUTO is selected for the VIDEO FORMAT item in the INPUT menu (📖39). The vertical position and horizontal position will be automatically set to the default.

○ **For a component video signal**

The vertical position and horizontal position will be automatically set to the default. The horizontal phase will be automatically adjusted.

- The automatic adjustment operation requires approx. 10 seconds. Also please note that it may not function correctly with some input.
- When this function is performed for a video signal, a certain extra such as a line may appear outside a picture.
- When this function is performed for a computer signal, a black frame may be displayed on the edge of the screen, depending on the PC model.
- The items adjusted by this function may vary when the FINE or DISABLE is selected for the AUTO ADJUST item of the SERVICE item in the OPTION menu (📖57).

Adjusting the position

1. Press **POSITION** button on the remote control when no menu is indicated.

The “POSITION” indication will appear on the screen.

2. Use the ▲/▼/◀/▶ cursor buttons to adjust the picture position.
- When you want to reset the operation, press **RESET** button on the remote control during the operation.

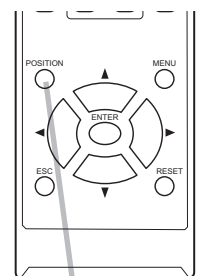

POSITION button

To complete this operation, press **POSITION** button again. Even if you do not do anything, the dialog will automatically disappear after a few seconds.

- When this function is performed on a video signal or an s-video signal, some image such as an extra-line may appear at outside of the picture.
- When this function is performed on a video signal or s-video signal, the range of this adjustment depends on OVER SCAN in IMAGE menu (📖35) setting. It is not possible to adjust when OVER SCAN is set to 10.
- If **POSITION** button is pressed when a menu is indicated on screen, the displayed picture does not move its position but the menu does.
- This function is unavailable for a signal from the **LAN**, **USB TYPE A**, **USB TYPE B** or **HDMI** port.

Correcting the keystone distortions

KEYSTONE button

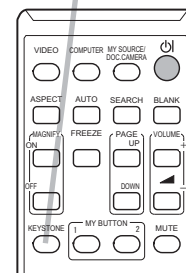
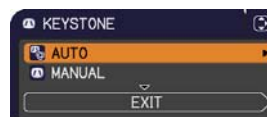

1. Press **KEYSTONE** button on the remote control. A dialog will appear on the screen to aid you in correcting the distortion.
2. Use the ▲/▼ cursor buttons to select **AUTO** or **MANUAL** operation, and press the ► button to perform the following.
 - (1) **AUTO** executes automatic vertical keystone correction.
 - (2) **MANUAL** displays a dialog for keystone correction. Use the ◀/▶ buttons for adjustment.



To close the dialog and complete this operation, press **KEYSTONE** button again. Even if you do not do anything, the dialog will automatically disappear after a few seconds.

- The menu or dialog will automatically disappear after several seconds of inactivity. Pressing the **KEYSTONE** button again finishes the operation and closes the menu or dialog.
- The adjustable range of this function will vary among inputs. For some input, this function may not work well.
- When V:INVERT or H&V:INVERT is selected to the MIRROR item in the SETUP menu, if the projector screen is inclined or angled downward, automatic vertical keystone correction may not work correctly.
- When the zoom adjustment is set to the TELE (telephoto focus), this function may be excessive. This function should be used when the zoom adjustment is set to the full WIDE (wide-angle focus) whenever possible.
- When the projector is placed on the level (about $\pm 4^\circ$), the automatic keystone distortion correction may not work.
- When the projector is inclined to near ± 30 degree or over, this function may not work well.
- This function will be unavailable when the Transition Detector is on (📖77).

Using the magnify feature

1. Press the **MAGNIFY ON** button on the remote control.
 - The picture will be magnified, and the MAGNIFY dialog will appear on the screen. When the **MAGNIFY ON** button is pressed for the first time after the projector is turned on, the picture will be zoomed by 1.5 times. On the dialog, triangle marks to show each direction will be displayed.
2. The display magnification of the projector switches in order with every press of the **MAGNIFY ON** button.
 - For computer signals, HDMI™ (RGB) signals, input signals from the LAN, USB TYPE A or USB TYPE B port
 1.5 times → 2 times → 3 times → 4 times → 1 time

 - For video signals, s-video signals, component video signals or HDMI™ (Component) signals
 1.5 times → 2 times → 1 time

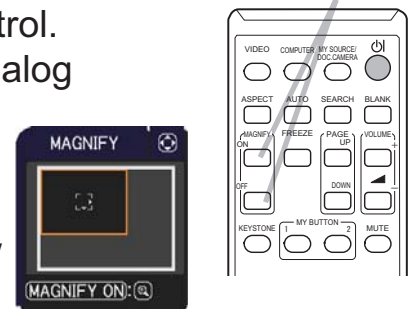
3. While the triangles are displayed on the dialog, use the ▲/▼/◀/▶ cursor buttons to shift the magnifying area.
4. Press the **MAGNIFY OFF** button on the remote control to exit magnification.
 - The MAGNIFY dialog will automatically disappear in several seconds with no operation. The dialog will appear again if the **MAGNIFY ON** button is pressed when the dialog has automatically disappeared.
 - The magnification is automatically disabled when the displaying signal or its display condition is changed.
 - While the magnification is active, the keystone distortion condition may vary. It will be restored when the magnification is disabled.
 - Some horizontal stripes might be visible on the image while magnification is active.
 - This function is not available in the following cases:
 - A sync signal in the range not supported is input.
 - There is no input signal.

MAGNIFY ON/OFF button



Temporarily freezing the screen

1. Press the **FREEZE** button on the remote control.
 - The “FREEZE” indication will appear on the screen (however, the indication will not appear when the OFF is selected for the MESSAGE item in the SCREEN menu (📖49)), and the projector will go into the FREEZE mode, which the picture is frozen.

To exit the FREEZE mode and restore the screen to normal, press the **FREEZE** button again.

FREEZE button

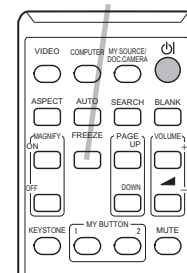

- The projector automatically exits from the FREEZE mode when some control buttons are pressed.
- If the projector continues projecting a still image for a long time, the LCD panel might possibly be burned in. Do not leave the projector in the FREEZE mode for too long.
- Images might appear degraded when this function is operated, but it is not a malfunction.

Temporarily blanking the screen

1. Press **BLANK** button on the remote control.
 - The BLANK screen will be displayed instead of the screen of input signal. Please refer to BLANK item in SCREEN menu (📖47).

To exit from the BLANK screen and return to the input signal screen, press **BLANK** button again.

BLANK button

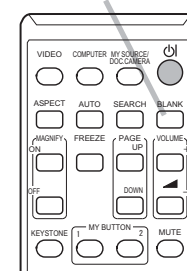

- The projector automatically exits from the BLANK mode when some control buttons are pressed.

⚠ CAUTION ► If you wish to have a blank screen while the projector's lamp is on, use the BLANK function above. Taking any other action may cause the damage on the projector.

NOTE • The sound is not connected with the BLANK screen function. If necessary, set the volume or mute first. To display the BLANK screen and mute the sound at one time, use AV MUTE function (📖57).

Using the menu function

This projector has the following menus:

PICTURE, IMAGE, INPUT, SETUP, AUDIO, SCREEN, OPTION, NETWORK, SECURITY and EASY MENU.

EASY MENU consists of functions often used, and the other menus are classified into each purpose and brought together as the ADVANCED MENU.

Each of these menus is operated using the same methods. While the projector is displaying any menu, the **MENU** button on the projector works as the cursor buttons. The basic operations of these menus are as follows.

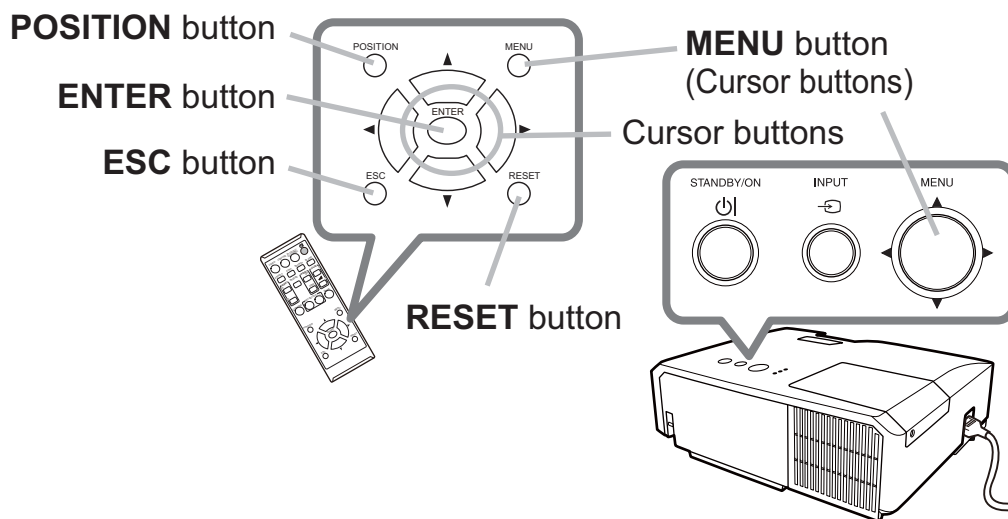

- To start the MENU, press the **MENU** button. The MENU you last used (EASY or ADVANCED) will appear. EASY MENU has priority to appear just after powered on.

2. In the EASY MENU

- Use the ▲/▼ cursor buttons to select an item to operate. If you want to change it to the ADVANCED MENU, select the ADVANCED MENU.
- Use the ◀/▶ cursor buttons to operate the item.

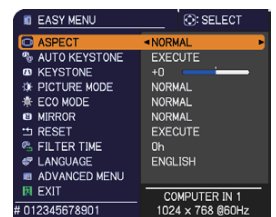

In the ADVANCED MENU

- Use the ▲/▼ cursor buttons to select a menu. If you want to change it to the EASY MENU, select the EASY MENU. The items in the menu appear on the right side.
- Press the ▶ cursor button or **ENTER** button to move the cursor to the right side. Then use the ▲/▼ cursor buttons to select an item to operate and press the ▶ cursor button or **ENTER** button to progress. The operation menu or dialog of the selected item will appear.
- Use the buttons as instructed in the OSD to operate the item.



(continued on next page)

Using the menu function (continued)

3. To close the MENU, press the **MENU** button again or select EXIT and press the ◀ cursor button or **ENTER** button. Even if you do not do anything, the dialog will automatically disappear after about 30 seconds.
 - If you want to move the menu position, use the cursor buttons after pressing the **POSITION** button.
 - Some functions cannot be performed when a certain input port is selected, or when a certain input signal is displayed.
 - When you want to reset the operation, press **RESET** button on the remote control during the operation. Note that some items (ex. LANGUAGE, VOLUME) cannot be reset.
 - In the ADVANCED MENU, when you want to return to the previous display, press the ◀ cursor button or **ESC** button on the remote control.

Indication in OSD (On Screen Display)

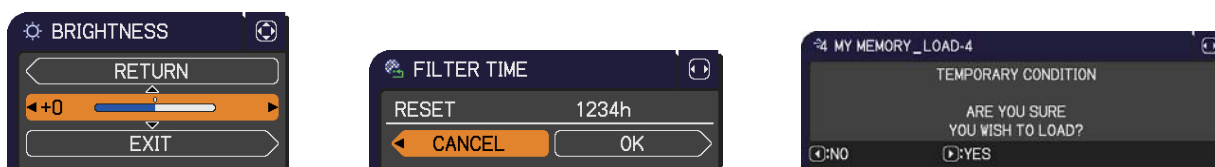

The meanings of the general words on the OSD are as follows.

Indication	Meaning
EXIT	Selecting this word finishes the OSD menu. It's the same as pressing the MENU button.
RETURN	Selecting this word returns the menu to the previous menu.
CANCEL or NO	Selecting this word cancels the operation in the present menu and returns to the previous menu.
OK or YES	Selecting this word executes the prepared function or shifts the menu to the next menu.

EASY MENU

From the EASY MENU, items shown in the table below can be performed.

Select an item using the ▲/▼ cursor buttons. Then perform it according to the following table.

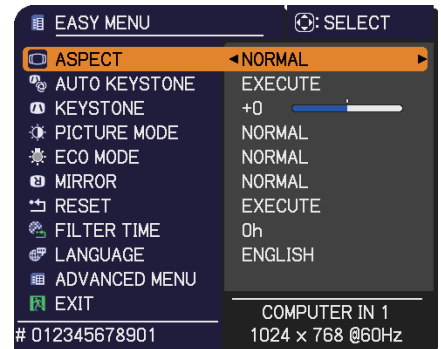

Item	Description																								
ASPECT	Using the ◀/▶ buttons switches the mode for aspect ratio. See the ASPECT item in IMAGE menu (📖35).																								
AUTO KEYSTONE	Using the ▶ button executes the auto keystone function. See the AUTO KEYSTONE item in SETUP menu (📖42).																								
KEYSTONE	Using the ◀/▶ buttons corrects the vertical keystone distortion. See the KEYSTONE item in SETUP menu (📖42).																								
PICTURE MODE	<p>Using the ◀/▶ buttons switches the picture mode. The picture modes are combinations of GAMMA and COLOR TEMP settings. Choose a suitable mode according to the projected source.</p> <p> ↻ NORMAL ↔ CINEMA ↔ DYNAMIC ↔ BOARD(BLACK) ↻ ↻ DAYTIME ↔ WHITEBOARD ↔ BOARD(GREEN) ↻ </p> <table border="1"> <thead> <tr> <th></th> <th>GAMMA</th> <th>COLOR TEMP</th> </tr> </thead> <tbody> <tr> <td>NORMAL</td> <td>1 DEFAULT</td> <td>2 MID</td> </tr> <tr> <td>CINEMA</td> <td>2 DEFAULT</td> <td>3 LOW</td> </tr> <tr> <td>DYNAMIC</td> <td>3 DEFAULT</td> <td>1 HIGH</td> </tr> <tr> <td>BOARD(BLACK)</td> <td>4 DEFAULT</td> <td>4 Hi-BRIGHT-1</td> </tr> <tr> <td>BOARD(GREEN)</td> <td>4 DEFAULT</td> <td>5 Hi-BRIGHT-2</td> </tr> <tr> <td>WHITEBOARD</td> <td>5 DEFAULT</td> <td>2 MID</td> </tr> <tr> <td>DAYTIME</td> <td>6 DEFAULT</td> <td>6 Hi-BRIGHT-3</td> </tr> </tbody> </table> <ul style="list-style-type: none"> • When the combination of GAMMA and COLOR TEMP differs from pre-assigned modes above, the display on the menu for the PICTURE MODE is “CUSTOM”. Please refer to the GAMMA and COLOR TEMP (📖32, 33) items in PICTURE menu. • Lines or other noise might appear on the screen when this function is operated, but it is not a malfunction. 		GAMMA	COLOR TEMP	NORMAL	1 DEFAULT	2 MID	CINEMA	2 DEFAULT	3 LOW	DYNAMIC	3 DEFAULT	1 HIGH	BOARD(BLACK)	4 DEFAULT	4 Hi-BRIGHT-1	BOARD(GREEN)	4 DEFAULT	5 Hi-BRIGHT-2	WHITEBOARD	5 DEFAULT	2 MID	DAYTIME	6 DEFAULT	6 Hi-BRIGHT-3
	GAMMA	COLOR TEMP																							
NORMAL	1 DEFAULT	2 MID																							
CINEMA	2 DEFAULT	3 LOW																							
DYNAMIC	3 DEFAULT	1 HIGH																							
BOARD(BLACK)	4 DEFAULT	4 Hi-BRIGHT-1																							
BOARD(GREEN)	4 DEFAULT	5 Hi-BRIGHT-2																							
WHITEBOARD	5 DEFAULT	2 MID																							
DAYTIME	6 DEFAULT	6 Hi-BRIGHT-3																							

(continued on next page)

Item	Description
ECO MODE	Using the ◀/▶ buttons turns off/on the Eco mode. See the ECO MODE item in SETUP menu (📖43).
MIRROR	Using the ◀/▶ buttons switches the mode for mirror status. See the MIRROR item in SETUP menu (📖43).
RESET	Performing this item resets all of the EASY MENU items except the FILTER TIME and LANGUAGE. A dialog is displayed for confirmation. Selecting the OK using the ▶ button performs resetting.
FILTER TIME	The usage time of the air filter is shown in the menu. Performing this item resets the filter time which counts usage time of the air filter. A dialog is displayed for confirmation. Selecting the OK using the ▶ button performs resetting. See the FILTER TIME item in OPTION menu (📖55).
LANGUAGE	Using the ◀/▶ buttons changes the display language. See the LANGUAGE item in SCREEN menu (📖47).
ADVANCED MENU	Press the ▶ or ENTER button to use the menu of PICTURE, IMAGE, INPUT, SETUP, AUDIO, SCREEN, OPTION, NETWORK or SECURITY.
EXIT	Press the ◀ or ENTER button to finish the OSD menu.

PICTURE menu

From the PICTURE menu, items shown in the table below can be performed.



Select an item using the ▲/▼ cursor buttons, and press the ► cursor button or **ENTER** button to execute the item. Then perform it according to the following table.

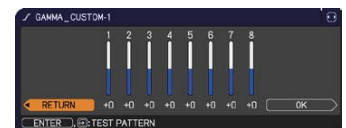

Item	Description
BRIGHTNESS	Using the ◀/▶ buttons adjusts the brightness. Dark ⇔ Light
CONTRAST	Using the ◀/▶ buttons adjusts the contrast. Weak ⇔ Strong
GAMMA	<p>Using the ▲/▼ buttons switches the gamma mode.</p> <p>1 DEFAULT ⇔ 1 CUSTOM ⇔ 2 DEFAULT ⇔ 2 CUSTOM ⇔ 3 DEFAULT ⇕ ⇕ 6 CUSTOM 3 CUSTOM ⇕ ⇕ 6 DEFAULT ⇔ 5 CUSTOM ⇔ 5 DEFAULT ⇔ 4 CUSTOM ⇔ 4 DEFAULT</p> <p>To adjust CUSTOM</p> <p>Selecting a mode whose name includes CUSTOM and then pressing the ► button or the ENTER button displays a dialog to aid you in adjusting the mode. This function is useful when you want to change the brightness of particular tones.</p> <p>Choose an item using the ◀/▶ buttons, and adjust the level using the ▲/▼ buttons.</p> <p>You can display a test pattern for checking the effect of your adjustment by pressing the ENTER button. Each time you press the ENTER button, the pattern changes as below.</p> <p>No pattern ⇔ Gray scale of 9 steps ⇓ ⇑ Ramp ⇔ Gray scale of 15 steps</p> <p>The eight equalizing bars correspond to eight tone levels of the test pattern (Gray scale of 9 steps) except the darkest in the left end. If you want to adjust the 2nd tone from left end on the test pattern, use the equalizing adjustment bar “1”. The darkest tone at the left end of the test pattern cannot be controlled with any of equalizing adjustment bar.</p> <ul style="list-style-type: none"> • Lines or other noise might appear on the screen when this function is operated, but it is not a malfunction.



(continued on next page)

Item	Description
<p>COLOR TEMP</p>	<p>Using the ▲/▼ buttons switches the color temperature mode.</p> <p style="text-align: center;"> 1 HIGH ⇔ 1 CUSTOM ⇔ 2 MID ⇔ 2 CUSTOM ⇕ ⇕ 6 CUSTOM 3 LOW ⇕ ⇕ 6 Hi-BRIGHT-3 3 CUSTOM ⇕ ⇕ 5 CUSTOM ⇔ 5 Hi-BRIGHT-2 ⇔ 4 CUSTOM ⇔ 4 Hi-BRIGHT-1 </p> <p>To adjust CUSTOM</p> <p>Selecting a mode whose name includes CUSTOM and then pressing the ► button or the ENTER button displays a dialog to aid you in adjusting the OFFSET and GAIN of the selected mode.</p>  <p>OFFSET adjustments change the color intensity on the whole tones of the test pattern.</p> <p>GAIN adjustments mainly affect color intensity on the brighter tones of the test pattern.</p> <p>Choose an item using the ◀/▶ buttons, and adjust the level using the ▲/▼ buttons.</p> <p>You can display a test pattern for checking the effect of your adjustment by pressing the ENTER button.</p> <p>Each time you press the ENTER button, the pattern changes as below.</p> <p>No pattern ⇔ Gray scale of 9 steps ⇓ ⇑ ⇐ Ramp ⇔ Gray scale of 15 steps</p> <ul style="list-style-type: none"> • Lines or other noise might appear on the screen when this function is operated, but it is not a malfunction. 
<p>COLOR</p>	<p>Using the ◀/▶ buttons adjusts the strength of whole color.</p> <p style="text-align: center;">Weak ⇔ Strong</p> <ul style="list-style-type: none"> • This item can be selected only for a video, s-video and component video signal. • For an HDMI™ signal, this item can also be selected if either (1) or (2) applies. (1) HDMI FORMAT item in the INPUT menu is set to VIDEO. (2) HDMI FORMAT item in the INPUT menu is set to AUTO, and the projector recognizes that it receives video signals.
<p>TINT</p>	<p>Using the ◀/▶ buttons adjusts the tint.</p> <p style="text-align: center;">Reddish ⇔ Greenish</p> <ul style="list-style-type: none"> • This item can be selected only for a video, s-video and component video signal. • For an HDMI™ signal, this item can also be selected if either (1) or (2) applies. (1) HDMI FORMAT item in the INPUT menu is set to VIDEO. (2) HDMI FORMAT item in the INPUT menu is set to AUTO, and the projector recognizes that it receives video signals.



Item	Description
<p>SHARPNESS</p>	<p>Using the ◀/▶ buttons adjusts the sharpness. Weak ⇔ Strong</p> <ul style="list-style-type: none"> • There may be some noise and/or the screen may flicker for a moment when an adjustment is made. This is not a malfunction.
<p>ACTIVE IRIS</p>	<p>Using the ▲/▼ cursor buttons changes the active iris control mode. PRESENTATION ⇔ THEATER ⇔ OFF</p>  <p><u>PRESENTATION</u> : The active iris displays the best presentation image for both bright and dark scenes. <u>THEATER</u> : The active iris displays the best theater image for both bright and dark scenes. <u>OFF</u> : The active iris is always open.</p> <ul style="list-style-type: none"> • The screen may flicker when the PRESENTATION or THEATER modes are selected. If this occurs select OFF.
<p>MY MEMORY</p>	<p>This projector has 4 memories for adjustment data (for all the items of the PICTURE menu). Selecting a function using the ▲/▼ buttons and pressing the ▶ or ENTER button performs each function.</p>  <p><u>SAVE-1, SAVE-2, SAVE-3, SAVE-4</u> Performing a SAVE function saves the current adjustment data into the memory linked in the number included in the function's name.</p> <ul style="list-style-type: none"> • Remember that the current data being stored of a memory will be lost by saving new data into the memory. <p><u>LOAD-1, LOAD-2, LOAD-3, LOAD-4</u> Performing a LOAD function loads the data from the memory linked in the number included in the function's name, and adjusts the picture automatically depending on the data.</p> <ul style="list-style-type: none"> • The LOAD functions whose linked memory has no data are skipped. • Remember that the current adjusted condition will be lost by loading data. If you want to keep the current adjustment, please save it before performing a LOAD function. • There may be some noise and the screen may flicker for a moment when loading data. This is not malfunction. • You can perform the LOAD function using MY BUTTON. Please see MY BUTTON item in OPTION menu (📖 56, 57).

IMAGE menu

From the IMAGE menu, items shown in the table below can be performed.

Select an item using the ▲/▼ cursor buttons, and press the ► cursor button or **ENTER** button to execute the item. Then perform it according to the following table.

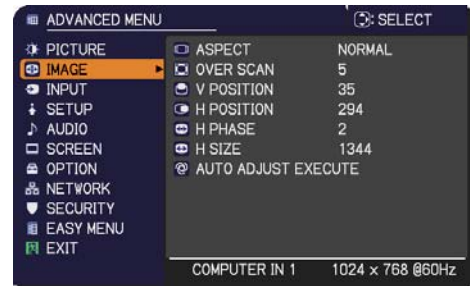

Item	Description
<p>ASPECT</p>	<p>Using the ▲/▼ buttons switches the mode for aspect ratio.</p> <p>For a computer signal CP-X2514WN, CP-X3014WN, CP-X4014WN: NORMAL ⇔ 4:3 ⇔ 16:9 ⇔ 16:10 ↑↑↑↑↑ CP-WX3014WN: NORMAL ⇔ 4:3 ⇔ 16:9 ⇔ 16:10 ⇔ NATIVE ↑↑↑↑↑</p> <p>For an HDMI™ signal CP-X2514WN, CP-X3014WN, CP-X4014WN: NORMAL ⇔ 4:3 ⇔ 16:9 ⇔ 16:10 ⇔ 14:9 ↑↑↑↑↑ CP-WX3014WN: NORMAL ⇔ 4:3 ⇔ 16:9 ⇔ 16:10 ⇔ 14:9 ⇔ NATIVE ↑↑↑↑↑</p> <p>For a video signal, s-video signal or component video signal CP-X2514WN, CP-X3014WN, CP-X4014WN: 4:3 ⇔ 16:9 ⇔ 14:9 ↑↑↑↑↑ CP-WX3014WN: 4:3 ⇔ 16:9 ⇔ 16:10 ⇔ 14:9 ⇔ NATIVE ↑↑↑↑↑</p> <p>For an input signal from the LAN, USB TYPE A or USB TYPE B port, or if there is no signal CP-X2514WN, CP-X3014WN, CP-X4014WN: 4:3 (fixed) CP-WX3014WN: 16:10 (fixed)</p> <ul style="list-style-type: none"> • The NORMAL mode keeps the original aspect ratio of the signal.
<p>OVER SCAN</p>	<p>Using the ◀/▶ buttons adjusts the over-scan ratio. Small (It magnifies picture) ⇔ Large (It reduces picture)</p> <ul style="list-style-type: none"> • This item can be selected only for a video, s-video and component video signal. • For an HDMI™ signal, this item can also be selected if either (1) or (2) applies. (1) HDMI FORMAT item in the INPUT menu is set to VIDEO. (2) HDMI FORMAT item in the INPUT menu is set to AUTO, and the projector recognizes that it receives video signals.

(continued on next page)

Item	Description
<p>V POSITION</p>	<p>Using the ◀/▶ buttons adjusts the vertical position. Down ⇔ Up</p> <ul style="list-style-type: none"> • Over-adjusting the vertical position may cause noise to appear on the screen. If this occurs, please reset the vertical position to the default setting. Pressing the RESET button when the V POSITION is selected will reset the V POSITION to the default setting. • When this function is performed on a video signal or an s-video signal, the range of this adjustment depends on OVER SCAN (📖35) setting. It is not possible to adjust when OVER SCAN is set to 10. • This function is unavailable for a signal from the LAN, USB TYPE A, USB TYPE B or HDMI port.
<p>H POSITION</p>	<p>Using the ◀/▶ buttons adjusts the horizontal position. Right ⇔ Left</p> <ul style="list-style-type: none"> • Over-adjusting the horizontal position may cause noise to appear on the screen. If this occurs, please reset the horizontal position to the default setting. Pressing the RESET button when the H POSITION is selected will reset the H POSITION to the default setting. • When this function is performed on a video signal or an s-video signal, the range of this adjustment depends on OVER SCAN (📖35) setting. It is not possible to adjust when OVER SCAN is set to 10. • This function is unavailable for a signal from the LAN, USB TYPE A, USB TYPE B or HDMI port.

(continued on next page)

Item	Description
H PHASE	<p>Using the ◀/▶ buttons adjusts the horizontal phase to eliminate flicker. Right ⇔ Left</p> <ul style="list-style-type: none"> • This item can be selected only for a computer signal or a component video signal. This function is unavailable for a signal from the LAN, USB TYPE A, USB TYPE B or HDMI port.
H SIZE	<p>Using the ◀/▶ buttons adjusts the horizontal size. Small ⇔ Large</p> <ul style="list-style-type: none"> • This item can be selected only for a computer signal. This function is unavailable for a signal from the LAN, USB TYPE A, USB TYPE B or HDMI port. • When this adjustment is excessive, the picture may not be displayed correctly. In such a case, please reset the adjustment by pressing the RESET button on the remote control during this operation. • Images might appear degraded when this function is operated, but it is not a malfunction.
AUTO ADJUST EXECUTE	<p>Selecting this item performs the automatic adjustment feature.</p> <p>For a computer signal The vertical position, the horizontal position and the horizontal phase will be automatically adjusted. Make sure that the application window is set to its maximum size prior to attempting to use this feature. A dark picture may still be incorrectly adjusted. Use a bright picture when adjusting.</p> <p>For a video signal and s-video signal The video format best suited for the respective input signal will be selected automatically. This function is available only when the AUTO is selected for the VIDEO FORMAT item in the INPUT menu (📖39). The vertical position and horizontal position will be automatically set to the default.</p> <p>For a component video signal The vertical position and horizontal position will be automatically set to the default. The horizontal phase will be automatically adjusted.</p> <ul style="list-style-type: none"> • The automatic adjustment operation requires approx. 10 seconds. Also please note that it may not function correctly with some input. • When this function is performed for a video signal, a certain extra such as a line may appear outside a picture. • When this function is performed for a computer signal, a black frame may be displayed on the edge of the screen, depending on the PC model. • The items adjusted by this function may vary when the FINE or DISABLE is selected for the AUTO ADJUST item of the SERVICE item in the OPTION menu (📖57).

INPUT menu

From the INPUT menu, items shown in the table below can be performed.

Select an item using the ▲/▼ cursor buttons, and press the ► cursor button or **ENTER** button to execute the item. Then perform it according to the following table.

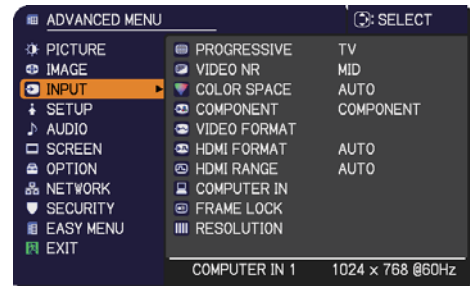

Item	Description
PROGRESSIVE	<p>Using the ▲/▼ buttons switches the progress mode.</p> <p>TV ⇄ FILM ⇄ OFF</p> <p>↑—————↑</p> <ul style="list-style-type: none"> • This function works only for a video signal, s-video signal, component video signal (of 480i@60 or 576i@50 or 1080i@50/60) and an HDMI™ signal (of 480i@60 or 576i@50 or 1080i@50/60). • When TV or FILM is selected, the screen image will be sharp. FILM adapts to the 2-3 Pull-Down conversion system. But these may cause a certain defect (for example, jagged line) of the picture for a quick moving object. In such a case, please select OFF, even though the screen image may lose sharpness.
VIDEO NR	<p>Using the ▲/▼ buttons switches the noise reduction mode.</p> <p>HIGH ⇄ MID ⇄ LOW</p> <p>↑—————↑</p> <ul style="list-style-type: none"> • This function works only for a video signal, s-video signal, component video signal (of 480i@60 or 576i@50 or 1080i@50/60) and an HDMI™ signal (of 480i@60 or 576i@50 or 1080i@50/60).
COLOR SPACE	<p>Using the ▲/▼ buttons switches the mode for color space.</p> <p>AUTO ⇄ RGB ⇄ SMPTE240 ⇄ REC709 ⇄ REC601</p> <p>↑—————↑</p> <ul style="list-style-type: none"> • This item can be selected only for a computer signal (except for signals from the LAN, USB TYPE A and USB TYPE B ports) or a component video signal (except SCART RGB). • The AUTO mode automatically selects the optimum mode. • The AUTO operation may not work well at some signals. In such a case, it might be good to select a suitable mode except AUTO.
COMPONENT	<p>Using the ▲/▼ buttons switches the function of the COMPONENT ports.</p> <p>COMPONENT ⇄ SCART RGB</p> <p>When the SCART RGB is selected, the COMPONENT (Y, Cb/Pb, Cr/Pr) and VIDEO ports will function as a SCART RGB port. A SCART adapter or SCART cable is required for a SCART RGB input to the projector. For details, contact your dealer.</p>



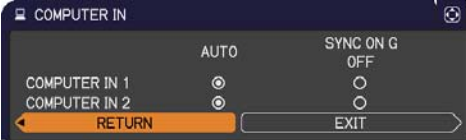
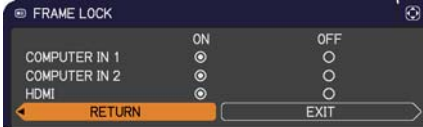

(continued on next page)

Item	Description								
<p>VIDEO FORMAT</p>	<p>The video format for S-VIDEO port and VIDEO port can be set.</p> <p>(1) Use the ▲/▼ buttons to select the input port.</p> <p>(2) Using the ◀/▶ buttons switches the mode for video format.</p> <div data-bbox="922 331 1465 474" style="border: 1px solid black; padding: 5px; margin: 10px 0;"> </div> <p style="text-align: center;"> AUTO ⇔ NTSC ⇔ PAL ⇔ SECAM ⇨ N-PAL ⇔ M-PAL ⇔ NTSC4.43 ⇨ </p> <ul style="list-style-type: none"> • This item is performed only for a video signal from the VIDEO port or the S-VIDEO port. • The AUTO mode automatically selects the optimum mode. • The AUTO operation may not work well for some signals. If the picture becomes unstable (e.g. an irregular picture, lack of color), please select the mode according to the input signal. 								
<p>HDMI FORMAT</p>	<p>Using the ▲/▼ cursor buttons switches the video format for an input from the HDMI port.</p> <p style="text-align: center;"> AUTO ⇔ VIDEO ⇔ COMPUTER ↕──↕ </p> <table border="1" data-bbox="437 1014 1457 1211" style="width: 100%; border-collapse: collapse;"> <thead> <tr> <th style="width: 30%;"></th> <th>Feature</th> </tr> </thead> <tbody> <tr> <td>AUTO</td> <td>automatically sets the optimum mode.</td> </tr> <tr> <td>VIDEO</td> <td>sets the suitable mode for DVD signals.</td> </tr> <tr> <td>COMPUTER</td> <td>sets the suitable mode for computer signals.</td> </tr> </tbody> </table> <ul style="list-style-type: none"> • When the COMPUTER is selected, the functions COLOR (PICTURE menu), TINT (PICTURE menu) and OVER SCAN (IMAGE menu) are unavailable. 		Feature	AUTO	automatically sets the optimum mode.	VIDEO	sets the suitable mode for DVD signals.	COMPUTER	sets the suitable mode for computer signals.
	Feature								
AUTO	automatically sets the optimum mode.								
VIDEO	sets the suitable mode for DVD signals.								
COMPUTER	sets the suitable mode for computer signals.								
<p>HDMI RANGE</p>	<p>Using the ▲/▼ cursor buttons changes the digital range for input from the HDMI port.</p> <p style="text-align: center;"> AUTO ⇔ NORMAL ⇔ ENHANCED ↕──↕ </p> <table border="1" data-bbox="437 1529 1457 1727" style="width: 100%; border-collapse: collapse;"> <thead> <tr> <th style="width: 30%;"></th> <th>Feature</th> </tr> </thead> <tbody> <tr> <td>AUTO</td> <td>automatically sets the optimum mode.</td> </tr> <tr> <td>NORMAL</td> <td>sets the suitable mode for DVD signals. (16-235)</td> </tr> <tr> <td>ENHANCED</td> <td>sets the suitable mode for computer signals. (0-255)</td> </tr> </tbody> </table> <ul style="list-style-type: none"> • If the contrast of the screen image is too strong or too weak, try finding a more suitable mode. 		Feature	AUTO	automatically sets the optimum mode.	NORMAL	sets the suitable mode for DVD signals. (16-235)	ENHANCED	sets the suitable mode for computer signals. (0-255)
	Feature								
AUTO	automatically sets the optimum mode.								
NORMAL	sets the suitable mode for DVD signals. (16-235)								
ENHANCED	sets the suitable mode for computer signals. (0-255)								

(continued on next page)

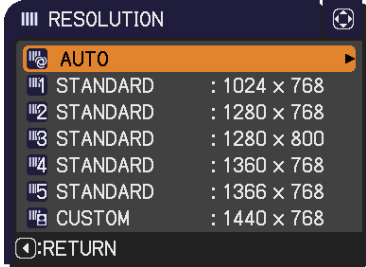
Item	Description
<p>COMPUTER IN</p>	<p>The computer input signal type for COMPUTER IN1 and IN2 ports can be set.</p> <p>(1) Use the ▲/▼ buttons to select the COMPUTER IN port to be set.</p> <p>(2) Use the ◀/▶ buttons to select the computer input signal type.</p> <p style="text-align: center;">AUTO ⇔ SYNC ON G OFF</p> <ul style="list-style-type: none"> • Selecting the AUTO mode allows you to input a sync on G signal or component video signal from the port (📖11, 13). • In the AUTO mode, the picture may be distorted with certain input signals. In such a case, remove the signal connector so that no signal is received and select the SYNC ON G OFF, and then reconnect the signal. 
<p>FRAME LOCK</p>	<p>Set the frame lock function on/off for each port.</p> <p>(1) Use the ▲/▼ buttons to select the input ports.</p> <p>(2) Use the ◀/▶ buttons to turn the frame lock function on/off .</p> <p style="text-align: center;">ON ⇔ OFF</p> <ul style="list-style-type: none"> • This item can be performed only on a signal with a vertical frequency of 49 to 51Hz, 59 to 61 Hz. • When ON is selected, moving pictures are displayed more smoothly. 

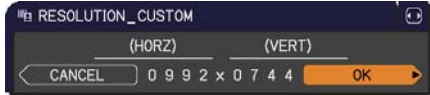
(continued on next page)

Item	Description
<p>RESOLUTION</p>	<p>The resolution for the COMPUTER IN1 and COMPUTER IN2 input signals can be set on this projector.</p> <p>(1) In the INPUT menu select the RESOLUTION using the ▲/▼ buttons and press the ► button. The RESOLUTION menu will be displayed.</p>  <p>(2) In the RESOLUTION menu select the resolution you wish to display using the ▲/▼ buttons. Selecting AUTO will set a resolution appropriate to the input signal.</p> <p>(3) Pressing the ► or ENTER button when selecting a STANDARD resolution will automatically adjust the horizontal and vertical positions, clock phase and horizontal size. The INPUT_INFORMATION dialog will be displayed.</p>  <p>(4) To set a custom resolution use the ▲/▼ buttons to select the CUSTOM and the RESOLUTION_CUSTOM box will be displayed. Set the horizontal (HORZ) and vertical (VERT) resolutions using the ▲/▼/◀/▶ buttons. This function may not support all resolutions.</p>  <p>(5) Move the cursor to OK on screen and press the ► or ENTER button. The message "ARE YOU SURE YOU WISH TO CHANGE RESOLUTION?" appears. To save the setting, press the ► button. The horizontal and vertical positions, clock phase and horizontal size will be automatically adjusted. The INPUT_INFORMATION dialog will be displayed.</p>  <p>(6) To revert back to the previous resolution without saving changes, move the cursor to CANCEL on screen and press the ◀ or ENTER button. The screen will then return to the RESOLUTION menu displaying the previous resolution.</p> <ul style="list-style-type: none"> • For some pictures, this function may not work well.

SETUP menu

From the SETUP menu, items shown in the table below can be performed.

Select an item using the ▲/▼ cursor buttons, and press the ► cursor button or **ENTER** button to execute the item. Then perform it according to the following table.

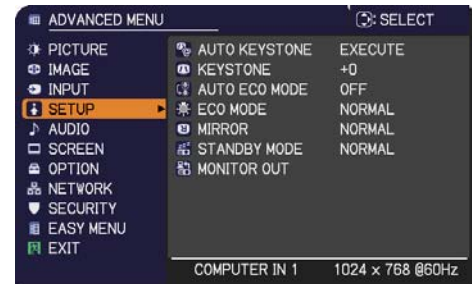

Item	Description
<p>AUTO KEYSTONE</p>	<p>Selecting this item performs the Automatic keystone distortion correction. Projector automatically corrects vertical keystone distortion due to the (forward/backward) setup angle by itself. This function will be executed only once when selected in the menu. When the slant of the projector is changed, execute this function again.</p> <ul style="list-style-type: none"> • The adjustable range of this function will vary among inputs. For some input, this function may not work well. • When V:INVERT or H&V:INVERT is selected to the MIRROR item in the SETUP menu, if the projector screen is inclined or angled downward, this function may not work correctly. • When the zoom adjustment is set to the TELE (telephoto focus), this function may be excessive. This function should be used when the zoom adjustment is set to the full WIDE (wide-angle focus) whenever possible. • When the projector is placed on the level (about $\pm 4^\circ$), this function may not work. • When the projector is inclined to near ± 30 degree or over, this function may not work well. • This function will be unavailable when the Transition Detector is on (📖77).
<p>KEYSTONE</p>	<p>Using the ◀/▶ buttons corrects the vertical keystone distortion.</p> <p>Shrink the bottom of the image ⇔ Shrink the top of the image</p> <ul style="list-style-type: none"> • The adjustable range of this function will vary among inputs. For some input, this function may not work well. • When the zoom adjustment is set to the TELE (telephoto focus), this function may be excessive. This function should be used when the zoom adjustment is set to the full WIDE (wide-angle focus) whenever possible. • This function will be unavailable when the Transition Detector is on (📖77).

(continued on next page)

Item	Description
AUTO ECO MODE	<p>Using the ▲/▼ buttons turns on/off the AUTO ECO MODE. ON ⇔ OFF</p> <ul style="list-style-type: none"> • When ON is selected, the projector will always be set to Eco mode at start-up regardless of the ECO MODE (📖<i>below</i>) setting. An OSD message “AUTO ECO MODE” will be displayed for tens of seconds when the projector starts with this function activated.
ECO MODE	<p>Using the ▲/▼ buttons turns off/on the Eco mode. NORMAL ⇔ ECO</p> <ul style="list-style-type: none"> • When the ECO is selected, acoustic noise and screen brightness are reduced. • When AUTO ECO MODE (📖<i>above</i>) is set to ON, the projector will always be set to Eco mode at start-up regardless this setting.
MIRROR	<p>Using the ▲/▼ buttons switches the mode for mirror status.</p> <div style="text-align: center;">  <p>NORMAL ⇔ H:INVERT ⇔ V:INVERT ⇔ H&V:INVERT</p> <p style="text-align: center;">↑—————↑</p> </div> <p>If the Transition Detector is on and MIRROR status is changed, TRANSITION DETECTOR ON alarm (📖77) will be displayed when projector is restarted after the AC power is turned off.</p>

(continued on next page)

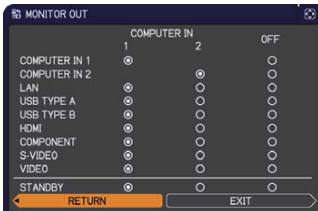
Item	Description
<p>STANDBY MODE</p>	<p>Using ▲/▼ buttons switches the standby mode setting between NORMAL and SAVING.</p> <p>NORMAL ⇔ SAVING</p> <p>When SAVING is selected, the power consumption in the standby mode is lowered with some functional restriction as below:</p> <ul style="list-style-type: none"> • When SAVING is selected, the RS-232C communication control except to turn the projector on and the network function are disabled while the projector is in the standby mode. If the COMMUNICATION TYPE in the COMMUNICATION menu is set to NETWORK BRIDGE, all of the RS-232C commands are disabled (📖59). • When SAVING is selected, STANDBY setting of AUDIO SOURCE (📖45) is invalid, and no signal is output from AUDIO OUT port in the standby mode. • When SAVING is selected, STANDBY setting of MONITOR OUT is invalid, and no signal is output from MONITOR OUT port in the standby mode.
<p>MONITOR OUT</p>	<p>While the image signal from the input port chosen in step (1) is projected, the image signal from the input port selected in step (2) is output to MONITOR OUT port.</p> <p>(1) Choose a picture input port using ▲/▼ buttons. Choose STANDBY to select the picture output in the standby mode.</p> <p>(2) Select one of the COMPUTER IN ports using ◀/▶ buttons. Select OFF to disable the MONITOR OUT port for the input port or standby mode chosen in the step (1).</p> <p>• You cannot select COMPUTER IN1 in step (1) and COMPUTER IN2 in step (2) and vice versa.</p> 

AUDIO menu

From the AUDIO menu, items shown in the table below can be performed. Select an item using the ▲/▼ cursor buttons, and press the ► cursor button or the **ENTER** button to execute the item. Then perform it according to the following table.

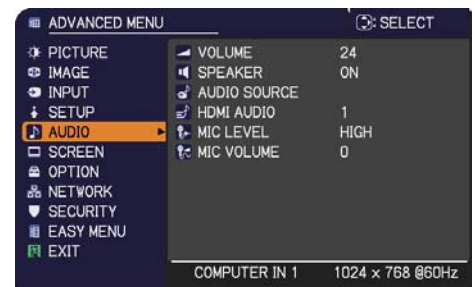

Item	Description								
VOLUME	Using the ◀/▶ buttons adjusts the volume. Low ⇄ High								
SPEAKER	Using the ▲/▼ buttons turns on/off the built-in speaker. ON ⇄ OFF When OFF is selected, the built-in speaker does not work.								
AUDIO SOURCE	<p>While the image signal from the input port chosen in step (1) is projected, the audio signal from the input port selected in step (2) is output to both the AUDIO OUT port and built-in speaker of this projector. However, the built-in speaker does not work when SPEAKER is set to OFF.</p> <p>(1) Choose a picture input port using the ▲/▼ buttons. Choose STANDBY to select the sound output in the standby mode.</p> <p>(2) Select an audio input port or the mute icon using the ◀/▶ buttons. The icons indicate the following.</p> <table data-bbox="478 1355 1244 1512"> <tr> <td>No.1: AUDIO IN1 port</td> <td>No.2: AUDIO IN2 port</td> </tr> <tr> <td>No.3: AUDIO IN3 ports</td> <td>No.4: LAN port</td> </tr> <tr> <td>No.5: USB TYPE A port</td> <td>No.6: USB TYPE B port</td> </tr> <tr> <td>No.7: HDMI port</td> <td>⌘: mutes the sound</td> </tr> </table> <ul data-bbox="430 1523 1468 1904" style="list-style-type: none"> • Audio input from port nos.4 to 7 can only be selected by each of the picture input ports. • Even if the projector is in the standby mode, cooling fans may work and make noises when the built-in speaker is in operation. • C.C. (Closed Caption) is automatically activated when ⌘ is selected and an input signal containing C.C. is received. This function is available only when the signal is NTSC for VIDEO or S-VIDEO, or 480i@60 for COMPONENT, COMPUTER IN1 or COMPUTER IN2, and when AUTO is selected for DISPLAY in the C.C. menu under the SCREEN menu (52). 	No.1: AUDIO IN1 port	No.2: AUDIO IN2 port	No.3: AUDIO IN3 ports	No.4: LAN port	No.5: USB TYPE A port	No.6: USB TYPE B port	No.7: HDMI port	⌘: mutes the sound
No.1: AUDIO IN1 port	No.2: AUDIO IN2 port								
No.3: AUDIO IN3 ports	No.4: LAN port								
No.5: USB TYPE A port	No.6: USB TYPE B port								
No.7: HDMI port	⌘: mutes the sound								

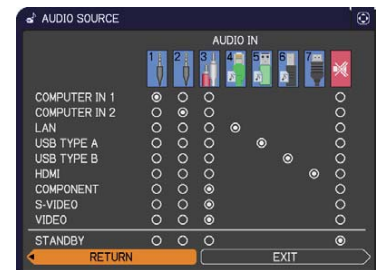

(continued on next page)

AUDIO menu

Item	Description
HDMI AUDIO	Using the ▲/▼ buttons switches the mode for the HDMI™ audio. Check each of the two modes provided and select the suitable one for your HDMI™ audio device. 1 ⇄ 2
MIC LEVEL	Using the ▲/▼ buttons switches the input level to match that of the microphone connected to the MIC port. HIGH ⇄ LOW HIGH: for a microphone with an amplifier. LOW: for a microphone without an amplifier.
MIC VOLUME	Using the ◀/▶ buttons adjusts the volume of the microphone connected to the MIC port. Low ⇄ High

SCREEN menu

From the SCREEN menu, items shown in the table below can be performed.

Select an item using the ▲/▼ cursor buttons, and press the ► cursor button or **ENTER** button to execute the item. Then perform it according to the following table.

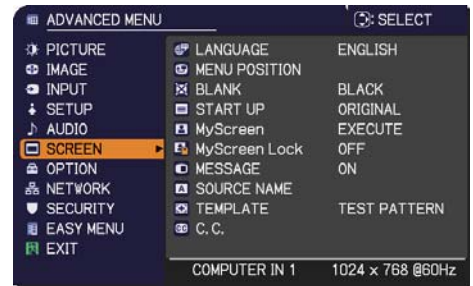

Item	Description
LANGUAGE	<p>Using the ▲/▼/◀/▶ buttons switches the OSD (On Screen Display) language.</p> <p>ENGLISH ⇔ FRANÇAIS ⇔ DEUTSCH ⇔ ESPAÑOL ⤴ (shown in the LANGUAGE dialog) ⤵</p> <p>Press the ENTER or INPUT button to save the language setting.</p>
MENU POSITION	<p>Using the ▲/▼/◀/▶ buttons adjusts the menu position. To quit the operation, press the MENU button on the remote control or keep no operation for about 10 seconds.</p>
BLANK	<p>Using the ▲/▼ buttons switches the mode for the blank screen. The blank screen is a screen for the temporarily blanking feature (📖27). It is displayed by pressing the BLANK button on the remote control.</p> <p>MyScreen ⇔ ORIGINAL ⇔ BLUE ⇔ WHITE ⇔ BLACK ⤴—————⤵</p> <p><u>MyScreen</u> : Screen can be registered by the MyScreen item (📖48). <u>ORIGINAL</u> : Screen preset as the standard screen. <u>BLUE, WHITE, BLACK</u> : Plain screens in each color.</p> <ul style="list-style-type: none"> • To avoid remaining as an afterimage, the MyScreen or ORIGINAL screen will change to the plain black screen after several minutes.
START UP	<p>Using the ▲/▼ buttons switches the mode for the start-up screen. The start-up screen is a screen displayed when no signal or an unsuitable signal is detected.</p> <p>MyScreen ⇔ ORIGINAL ⇔ OFF ⤴—————⤵</p> <p><u>MyScreen</u> : Screen can be registered by the MyScreen item (📖48). <u>ORIGINAL</u> : Screen preset as the standard screen. <u>OFF</u> : Plain black screen.</p> <ul style="list-style-type: none"> • To avoid remaining as an afterimage, the MyScreen or ORIGINAL screen will change to the BLANK screen (📖above) after several minutes. If also the BLANK screen is the MyScreen or ORIGINAL, the plain black screen is instead used. • When the ON is selected to the MyScreen PASSWORD item in the SECURITY menu (📖75), the START UP is fixed to MyScreen.

(continued on next page)

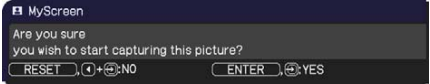
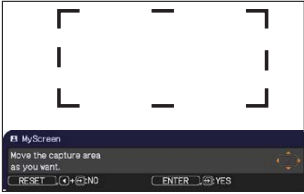
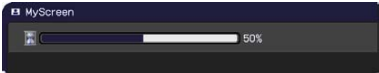
Item	Description
<p>MyScreen</p>	<p>This item allows you to capture an image for use as a MyScreen image which can be used as the BLANK screen and START UP screen. Display the image you want to capture before executing the following procedure.</p> <ol style="list-style-type: none"> <p>Selecting this item displays a dialog titled “MyScreen”. It will ask you if you start capturing an image from the current screen.</p>  <p>Please wait for the target image to be displayed, and press the ENTER or INPUT button when the image is displayed. The image will freeze and the frame for capturing will appear.</p> <p>To stop performing, press the RESET button on the remote control.</p> <p>Using the ▲/▼/◀/▶ buttons adjusts the frame position.</p>  <p>Please move the frame to the position of the image which you want to use. The frame may not be able to be moved for some input signals.</p>  <p>To start registration, press the ENTER or INPUT button on the remote control.</p> <p>To restore the screen and return to the previous dialog, press the RESET button on the remote control.</p> <p>Registration may take several minutes.</p> <p>When the registration is completed, the registered screen and the following message is displayed for several seconds:</p> <p>“MyScreen registration is finished.”</p> <p>If the registration failed, the following message is displayed:</p> <p>“A capturing error has occurred. Please try again.”</p> <ul style="list-style-type: none"> • This function cannot be selected when the ON is selected to the MyScreen Lock item (📖49). • This function cannot be selected when the ON is selected to the MyScreen PASSWORD item in SECURITY menu (📖75). • This function is unavailable for a signal from the LAN, USB TYPE A, USB TYPE B or HDMI port.

(continued on next page)

Item	Description
MyScreen Lock	<p>Using the ▲/▼ buttons turns on/off the MyScreen lock function. ON ⇔ OFF</p> <p>When the ON is selected, the item MyScreen is locked. Use this function for protecting the current MyScreen.</p> <ul style="list-style-type: none"> • This function cannot be selected when the ON is selected to the MyScreen PASSWORD item in SECURITY menu (📖75).
MESSAGE	<p>Using the ▲/▼ buttons turns on/off the message function. ON ⇔ OFF</p> <p>When the ON is selected, the following message function works.</p> <p>“AUTO IN PROGRESS” while automatically adjusting “NO INPUT IS DETECTED” “SYNC IS OUT OF RANGE” “INVALID SCAN FREQ.” “Searching....” while searching for the input “Detecting....” while an input signal is detected “AUTO ECO MODE” while starting up with AUTO ECO MODE</p> <p>The indication of the input signal displayed by changing The indication of the aspect ratio displayed by changing The indication of the PICTURE MODE displayed by changing The indication of the ACTIVE IRIS displayed by changing The indication of the MY MEMORY displayed by changing The indication of “FREEZE” and “II” while freezing the screen by pressing the FREEZE button. The indication of the TEMPLATE displayed by changing.</p> <ul style="list-style-type: none"> • When the OFF is selected, please remember if the picture is frozen. Do not mistake freezing for a malfunction (📖27).

(continued on next page)

Item	Description
<p>SOURCE NAME</p>	<p>Each input port for this projector can have a name applied to it.</p> <ol style="list-style-type: none"> (1) Use the ▲/▼ buttons on the SCREEN menu to select SOURCE NAME and press the ► or ENTER button. The SOURCE NAME menu will be displayed. (2) Use the ▲/▼ buttons on the SOURCE NAME menu to select the port to be named and press the ► button. The SOURCE NAME dialog will be displayed. Right side of the menu is blank until a name is specified. (3) Select an icon you would like to assign to the port in the SOURCE NAME dialog. The name assigned to the port will also be automatically switched according to your icon selection. Press the ENTER or INPUT button to determine your icon selection. (4) Select a number you would like to assign to the port along with the icon. You can select the number either from blank (no number assigned), 1, 2, 3, or 4. Then press the ENTER or INPUT button. (5) If you would like to modify the name assigned to the port, select CUSTOM NAME and press the ENTER or INPUT button. <p>(continued on next page)</p>



(continued on next page)

Item	Description
<p>SOURCE NAME (continued)</p>	<p>(6) The current name will be displayed on the first line. Use the ▲/▼/◀/▶ buttons and the ENTER or INPUT button to select and enter characters. To erase 1 character at one time, press the RESET button or press the ◀ and INPUT button at the same time. Also if you move the cursor to DELETE or ALL CLEAR on screen and press the ENTER or INPUT button, 1 character or all characters will be erased. The name can be a maximum of 16 characters.</p> <p>(7) To change an already inserted character, press the ▲ button to move the cursor to the first line, and use the ◀/▶ buttons to move the cursor on the character to be changed. After pressing the ENTER or INPUT button, the character is selected. Then, follow the same procedure as described at the item (6) above.</p> <p>(8) To finish entering text, move the cursor to the OK on screen and press the ▶, ENTER or INPUT button. To revert to the previous name without saving changes, move the cursor to the CANCEL on screen and press the ◀, ENTER or INPUT button.</p>  <p>The three screenshots show the 'SOURCE NAME' screen with 'COMPUTER IN 1' and 'desktop PC' entered. The first screenshot shows the cursor at the start of the first line. The second screenshot shows the cursor moved to the character 'E' in the second line. The third screenshot shows the cursor moved to the character 'P' in the second line.</p>
<p>TEMPLATE</p>	<p>Using the ▲/▼ cursor buttons switches the mode for the template screen. Press the ▶ cursor (or the ENTER) button to display the selected template, and press the ◀ cursor button to close the displayed screen. The last selected template is displayed when the MY BUTTON allocated to the TEMPLATE function is pressed (📖57).</p> <p style="text-align: center;"> TEST PATTERN ⇄ DOT-LINE1 ⇄ DOT-LINE2 ⇄ DOT-LINE3 ⇕ ⇕ MAP2 ⇄ MAP1 ⇄ CIRCLE2 ⇄ CIRCLE1 ⇄ DOT-LINE4 </p> <p>You can turn a map upside down and scroll it horizontally when MAP1 or MAP2 is selected. To invert or scroll the map, display the guidance by pressing the RESET button on the remote three seconds or more when MAP1 or MAP2 appears.</p>

(continued on next page)

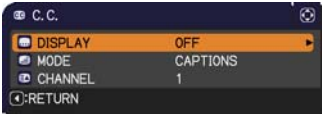
Item	Description
<p align="center">C.C. (Closed Caption)</p>	<p>The C.C. is the function that displays a transcript or dialog of the audio portion of a video, files or other presentation or other relevant sounds. It is required to have NTSC format video or 480i@60 format component video source supporting C.C. feature to utilize this function.</p> <p>It may not work properly, depending on equipment or signal source. In this case, please turn off the Closed Caption.</p> 
	<p>DISPLAY</p> <p>Select Closed Caption DISPLAY setting from following options using ▲/▼ buttons.</p> <p align="center">AUTO ⇔ ON ⇔ OFF</p> <p align="center">↑—————↑</p> <p><u>AUTO</u> : Closed Caption automatically displays when the volume is muted.</p> <p><u>ON</u> : Closed Caption is on.</p> <p><u>OFF</u> : Closed Caption is off.</p> <ul style="list-style-type: none"> • The caption is not displayed when the OSD menu is active. • The Closed Caption is the function to display the dialogue, narration, and / or sound effects of a television program or other video sources. The Closed Caption availability is depending upon broadcaster and/or content.
	<p>MODE</p> <p>Select Closed Caption MODE setting from following options using ▲/▼ buttons.</p> <p align="center">CAPTIONS ⇔ TEXT</p> <p><u>CAPTIONS</u> : Display Closed Caption.</p> <p><u>TEXT</u> : Display Text data, which is for additional information such as news reports or a TV program guide. The information covers the entire screen. Not all of the C.C. program has Text information.</p>
	<p>CHANNEL</p> <p>Select Closed Caption CHANNEL from following options using ▲/▼ buttons.</p> <p align="center">1 ⇔ 2 ⇔ 3 ⇔ 4</p> <p align="center">↑—————↑</p> <p><u>1</u>: Channel 1, primary channel / language</p> <p><u>2</u>: Channel 2</p> <p><u>3</u>: Channel 3</p> <p><u>4</u>: Channel 4</p> <p>The channel data may vary, depending on the content. Some channel might be used for secondary language or empty.</p>

OPTION menu

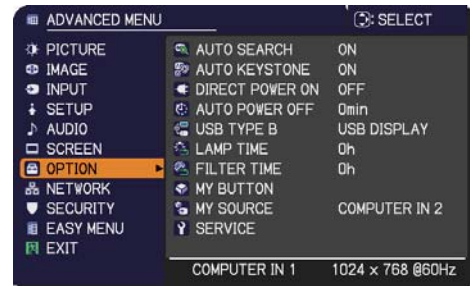

From the OPTION menu, items shown in the table below can be performed.

Select an item using the ▲/▼ cursor buttons, and press the ► cursor button or **ENTER** button to execute the item, except for the items LAMP TIME and FILTER TIME. Then perform it according to the following table.



Item	Description
<p>AUTO SEARCH</p>	<p>Using the ▲/▼ buttons turns on/off the automatic signal search function.</p> <p>ON ⇔ OFF</p> <p>When the ON is selected, detecting no signal automatically cycles through input ports in the following order. The search is started from the current port. Then when an input is found, the projector will stop searching and display the image.</p> <p>COMPUTER IN1 ⇨ COMPUTER IN2 ⇨ LAN ⇨ USB TYPE A VIDEO ⇨ S-VIDEO ⇨ COMPONENT ⇨ HDMI ⇨ USB TYPE B</p> <ul style="list-style-type: none"> • It may take several seconds to project the images from the USB TYPE B port.
<p>AUTO KEYSTONE</p>	<p>Using the ▲/▼ buttons turns on/off the automatic keystone function.</p> <p>ON ⇔ OFF</p> <p><u>ON</u> : Automatic keystone distortion correction will be executed whenever changing the slant of the projector.</p> <p><u>OFF</u> : This function is disabled. Please execute the AUTO KEYSTONE (EXECUTE) in the SETUP menu for automatic keystone distortion correction.</p> <ul style="list-style-type: none"> • When the projector is suspended from the ceiling this feature will not function properly so select the OFF. • This function will be unavailable when the Transition Detector is on (77).
<p>DIRECT POWER ON</p>	<p>Using the ▲/▼ buttons turns on/off the DIRECT POWER ON function.</p> <p>ON ⇔ OFF</p> <p>When set to the ON, the lamp in projector will be automatically turned on without the usual procedure (19), only when the projector is supplied with the power after the power was cut while the lamp was on.</p> <ul style="list-style-type: none"> • This function does not work as long as the power has been supplied to the projector while the lamp is off. • After turning the lamp on by the DIRECT POWER ON function, if neither input nor operation is detected for about 30 minutes, the projector is turned off, even though the AUTO POWER OFF function (54) is disabled.

(continued on next page)

Item	Description
<p>AUTO POWER OFF</p>	<p>Using the ▲/▼ buttons adjusts the time to count down to automatically turn the projector off.</p> <p>Long (max. 99 minutes) ⇔ Short (min. 0 minute = DISABLE)</p> <div style="display: flex; justify-content: space-around; align-items: center;">   </div> <p>When the time is set to 0, the projector is not turned off automatically. When the time is set to 1 to 99, and when the passed time with no-signal or an unsuitable signal reaches at the set time, the projector lamp will be turned off.</p> <p>If one of the projector's buttons or the remote control buttons is pressed or one of the commands (except get commands) is transmitted to the CONTROL port during the corresponding time, projector will not be turned off.</p> <p>Please refer to the section Turning off the power (📖19).</p>
<p>USB TYPE B</p>	<p>Using the ▲/▼ buttons selects the function of USB TYPE B port. To use this function, you need to connect the USB TYPE B port of the projector and the type A USB port of a computer.</p> <p>MOUSE ⇔ USB DISPLAY</p> <p>MOUSE : The accessory remote control works as the simple mouse and keyboard of the computer.</p> <p>USB DISPLAY : The port works as an input port that receives image signals from the computer (📖90).</p> <ul style="list-style-type: none"> • It may take several seconds to project the images from the USB TYPE B port. • In the following cases, a message to notify you that USB TYPE B port is not available for picture input appears together with the USB TYPE B dialog: <ul style="list-style-type: none"> - This setting is switched to MOUSE while a picture input from the USB TYPE B port is projected. - The USB TYPE B port is selected as the picture input source while this setting is set to MOUSE. Select USB DISPLAY in the dialog to project the picture input to the USB TYPE B port. In this case, you cannot use the simple mouse and keyboard function. Otherwise select other port for picture input.

(continued on next page)

Item	Description
LAMP TIME	<p>The lamp time is the usage time of the lamp, counted after the last resetting. It is shown in the OPTION menu.</p> <p>Pressing the RESET button on the remote control or the ► button of the projector displays a dialog.</p> <p>To reset the lamp time, select the OK using the ► button.</p> <p>CANCEL ⇒ OK</p> <ul style="list-style-type: none"> • Please reset the lamp time only when you have replaced the lamp, for a suitable indication about the lamp. • For the lamp replacement, see the section Replacing the lamp (📖94).
FILTER TIME	<p>The filter time is the usage time of the air filter, counted after the last resetting. It is shown in the OPTION menu.</p> <p>Pressing the RESET button on the remote control or the ► button of the projector displays a dialog.</p> <p>To reset the filter time, select the OK using the ► button.</p> <p>CANCEL ⇒ OK</p> <ul style="list-style-type: none"> • Please reset the filter time only when you have cleaned or replaced the air filter, for a suitable indication about the air filter. • For the air filter cleaning, see the section Cleaning and replacing the air filter (📖96).

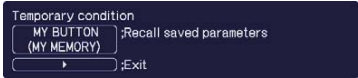

(continued on next page)

Item	Description
<p>MY BUTTON</p>	<p>This item is to assign one of the following functions to MY BUTTON 1/2 on the remote control (📖6).</p> <p>(1) Use the ▲/▼ buttons on the MY BUTTON menu to select a MY BUTTON - (1/2) and press the ► or ENTER button to display the MY BUTTON setup dialog.</p> <p>(2) Then using the ▲/▼/◀/▶ buttons sets one of the following functions to the chosen button. Press the ENTER or INPUT button to save the setting.</p> <ul style="list-style-type: none"> • COMPUTER IN1: Selects the input from COMPUTER IN1 port. • COMPUTER IN2: Selects the input from COMPUTER IN2 port. • LAN: Selects input from LAN port. • USB TYPE A: Selects input from USB TYPE A port. • USB TYPE B: Selects input from USB TYPE B port. • HDMI: Selects input from HDMI port. • COMPONENT: Selects the input from COMPONENT ports. • S-VIDEO: Selects the input from S-VIDEO port. • VIDEO: Selects the input from VIDEO port. • SLIDESHOW: Selects the input from USB TYPE A, and starts a Slideshow. • MY IMAGE: Displays the MY IMAGE menu (📖71). • MESSENGER: Turns the messenger text displayed on the screen on/off (📖5. Messenger Function in the Network Guide). When there is no transferred text data to display, the message "NO MESSENGER DATA" appears. • INFORMATION: Displays SYSTEM_INFORMATION, INPUT_INFORMATION (📖62), WIRELESS INFORMATION (📖67), WIRED INFORMATION (📖69) or nothing. • AUTO KEYSTONE : Performs automatic keystone distortion correction (📖42). • MY MEMORY: Loads one of adjustment data stored (📖34). When more than one data are saved, the adjustment changes every time the MY BUTTON is pressed. When no data is saved in memory, the dialog "No saved data" appears. When the current adjustment is not saved to memory, the dialog as shown in the right appears. <p>If you want to keep the current adjustment, please press the ► button to exit. Otherwise loading a data will overwrite the current adjusted condition.</p> <p>(continued on next page)</p> <div style="text-align: right;">   </div>

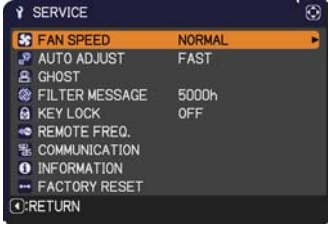
(continued on next page)

Item	Description
<p>MY BUTTON (continued)</p>	<ul style="list-style-type: none"> • ACTIVE IRIS: Changes the active iris mode. • PICTURE MODE: Changes the PICTURE MODE (📖30). • FILTER RESET: Displays the filter time reset confirmation dialogue (📖55). • TEMPLATE: Makes the template pattern selected to the TEMPLATE item (📖51) appear or disappear. • AV MUTE: Turns the picture and audio on/off. • RESOLUTION: Turns on/off the RESOLUTION dialog (📖41). • MIC VOLUME: Turns on/off the MIC VOLUME dialog (📖46). • ECO MODE: Turns on/off the ECO MODE dialog (📖43).
<p>MY SOURCE</p>	<p>Using ▲/▼ buttons selects the picture input port to be selected with pressing the MY SOURCE/DOC.CAMERA button on the remote control.</p> <p>You can use this function not only for document cameras but also computers and other equipment.</p> <p>⇄COMPUTER IN1 ⇄ COMPUTER IN2 ⇄ LAN ⇄ USB TYPE A ⇄ ⇄VIDEO⇄S-VIDEO ⇄ COMPONENT ⇄ HDMI ⇄ USB TYPE B⇄</p>
<p>SERVICE</p>	<p>Selecting this item displays the SERVICE menu.</p> <p>Select an item using the ▲/▼ buttons, and press the ► button or the ENTER button on the remote control to execute the item.</p>  <p>FAN SPEED</p> <p>Using the ▲/▼ buttons switches the rotation speed of the cooling fans. The HIGH is the mode for use at highlands etc. If the projector is used at an altitude of about 1600 m or higher, select HIGH. Otherwise, select NORMAL. Note that the projector is noisier when the HIGH is selected.</p> <p>HIGH ⇄ NORMAL</p> <p>AUTO ADJUST</p> <p>Using the ▲/▼ buttons to select one of the mode. When the DISABLE is selected, the automatic adjustment feature is disabled.</p> <p>FINE ⇄ FAST ⇄ DISABLE</p> <p>↑—————↑</p> <p><u>FINE</u>: Finer tuning including H.SIZE adjustment. <u>FAST</u>: Faster tuning, setting H.SIZE to prearranged data for the input signal.</p> <ul style="list-style-type: none"> • Depending on conditions, such as input image, signal cable to the projector, environment around the projector, etc., the automatic adjustment may not work correctly. In such a case, please choose DISABLE to disable the automatic adjustment, and make adjustment manually.

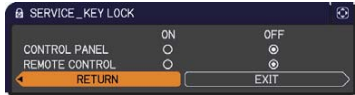
(continued on next page)

Item	Description
SERVICE (continued)	<p>GHOST Adjust the settings using the ▲/▼ buttons to eliminate ghosting.</p>
	<p>FILTER MESSAGE Use the ▲/▼ button to set the timer for notifying by the message when to replace the filter unit 100h ⇄ 200h ⇄ 500h ⇄ 1000h ⇄ 2000h ⇄ 5000h ⇄ OFF After choosing an item except OFF, the message “REMINDER *** HRS PASSED ...” will appear after the timer reaches the interval time set by this feature (📖100). When the OFF is chosen, the message will not appear. Utilize this feature to keep the air filter clean, setting the suitable time according to your environment of this projector.</p> <ul style="list-style-type: none"> • Please take care of the filter unit periodically, even if there is no message. If the air filter becomes to be blocked by dust or other matter, the internal temperature will rise, which could cause malfunction, or reduce the lifetime of the projector. • Please be careful with the operating environment of the projector and the condition of the filter unit.
	<p>KEY LOCK (1) Use the ▲/▼ buttons to choose the operations control. CONTROL PANEL ⇄ REMOTE CONTROL (2) Use the ◀/▶ buttons to select ON or OFF. ON ⇄ OFF</p>  <p>Selecting ON in Step 2 locks the buttons except STANDBY/ON on the operations control selected in Step 1. Selecting OFF releases the locked buttons on the operations control selected in Step 1.</p> <ul style="list-style-type: none"> • Please use this function to prevent tampering or accidental operation.
	<p>REMOTE FREQ. (1) Use the ▲/▼ button to change the projector's remote sensor frequency setting (📖4, 17). 1:NORMAL ⇄ 2:HIGH (2) Use the ◀/▶ button to change the projector's remote sensor on or off. ON ⇄ OFF</p>  <p>The factory default setting is for both 1:NORMAL and 2:HIGH to be on. If the remote control does not function correctly, disable either of them. It's not possible to disable both options at the same time.</p>

(continued on next page)

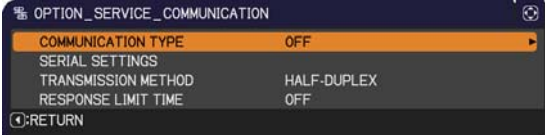
Item	Description
<p>SERVICE (continued)</p>	<p>Selecting this item displays COMMUNICATION menu. In this menu, you can configure the serial communication settings of the projector using the CONTROL port.</p>  <ul style="list-style-type: none"> • Select an item using the cursor buttons ▲/▼. Then pressing the ► button opens the submenu for the setting item you selected. Or, pressing the ◀ button instead of the ► button makes the menu back to the previous one without changing the setup. Each submenu can be operated as described above. • When COMMUNICATION TYPE (📖 below) is set to OFF, the other items in COMMUNICATION menu are invalid. • For the function of serial communication, refer to the Network Guide.
	<p>COMMUNICATION</p> <p>COMMUNICATION TYPE Select the communication type for transmission via the CONTROL port.</p> <pre> NETWORK BRIDGE (WIRELESS) ⇕ NETWORK BRIDGE (WIRED) ⇕ OFF ← </pre> <p>NETWORK BRIDGE: Select this type, if it is required to control an external device as a network terminal, via this projector from the computer. Select WIRELESS or WIRED as your network connection mode. The CONTROL port doesn't accept RS-232C commands (📖6. Network Bridge Function in the Network Guide)</p> <p>OFF: Select this mode to receive RS-232C commands using the CONTROL port.</p> <ul style="list-style-type: none"> • OFF is selected as the default setting. • When you select the NETWORK BRIDGE, check the item, TRANSMISSTION METHOD (📖60).

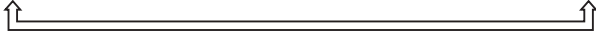
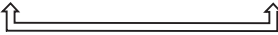

(continued on next page)

Item	Description	
<p>SERVICE (continued)</p>	<p>COMMUNICATION (continued)</p>	<p>SERIAL SETTINGS Select the serial communication condition for the CONTROL port.</p> <p>BAUD RATE 4800bps ⇔ 9600bps ⇔ 19200bps ⇔ 38400bps </p> <p>PARITY NONE ⇔ ODD ⇔ EVEN </p> <ul style="list-style-type: none"> • The BAUD RATE is fixed to 19200bps and PARITY is fixed NONE when the COMMUNICATION TYPE is set to OFF (📖59).
		<p>TRANSMISSION METHOD Select the transmission method for communication by the NETWORK BRIDGE from the CONTROL port.</p> <p>HALF-DUPLEX ⇔ FULL-DUPLEX</p> <p><u>HALF-DUPLEX</u>: This method lets the projector make two way communication, but only one direction, either transmitting or receiving data, is allowed at a time.</p> <p><u>FULL-DUPLEX</u>: This method lets the projector make two way communication, transmitting and receiving data at the same time.</p> <ul style="list-style-type: none"> • HALF-DUPLEX is selected as the default setting. • If you select HALF-DUPLEX, check the setting of the item RESPONSE LIMIT TIME (📖61).

(continued on next page)

Item	Description	
<p>SERVICE (continued)</p>	<p>COMMUNICATION (continued)</p>	<p>RESPONSE LIMIT TIME Select the time period to wait for receiving response data from other device communicating by the NETWORK BRIDGE and the HALF-DUPLEX through the CONTROL port.</p> <p>OFF ⇔ 1s ⇔ 2s ⇔ 3s </p> <p><u>OFF</u>: Select this mode if it is not required to check the responses from the device that the projector sends data to. In this mode, the projector can send out data from the computer continuously.</p> <p><u>1s /2s /3s</u>: Select the time period to keep the projector waiting for response from the device that the projector sends data to. While waiting the response, the projector does not send out any data from the CONTROL port.</p> <ul style="list-style-type: none"> • This menu is available only when the NETWORK BRIDGE is selected for the COMMUNICATION TYPE and the HALF-DUPLEX is selected for the TRANSMISSION METHOD (📖 59, 60). • OFF is selected as the default setting.

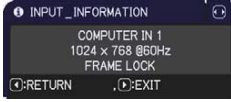
(continued on next page)

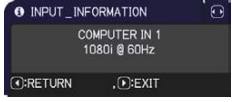
Item	Description
<p>SERVICE (continued)</p>	<p>INFORMATION</p> <p>Selecting this item displays a dialog titled “INPUT_INFORMATION”. It shows the information about the current input.</p> <div style="display: flex; justify-content: space-around; align-items: center;">    </div> <ul style="list-style-type: none"> • The “FRAME LOCK” message on the dialog means the frame lock function is working. • The “SCART RGB” message means the COMPONENT ports is working as a SCART RGB input port. Please refer to the COMPONENT item in INPUT menu (📖38). • This item can't be selected for no signal and sync out. • When the MY TEXT DISPLAY is set to ON, the MY TEXT is displayed together with the input information in the INPUT_INFORMATION box (📖79).
	<p>FACTORY RESET</p> <p>Selecting OK using the ► button performs this function. By this function, all the items in all of menus will collectively return to the initial setting. Note that the items LAMP TIME, FILTER TIME, LANGUAGE, FILTER MESSAGE, NETWORK and SECURITY settings are not reset.</p> <p style="padding-left: 20px;">CANCEL ⇨ OK</p> <ul style="list-style-type: none"> • Be sure to set FAN SPEED after resetting all the settings (📖57).

NETWORK menu

Remember that incorrect network settings on this projector may cause trouble on the network. Be sure to consult with your network administrator before connecting to an existing access point on your network. Select "NETWORK" from the main menu to access the following functions.

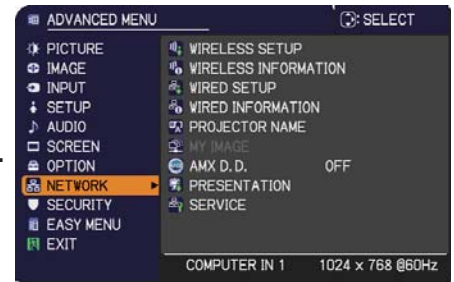

Select an item using the ▲/▼ cursor buttons on the projector or remote control, and press the ► cursor button on the projector or remote control, or **ENTER** button on the remote control to execute the item. Then perform it according to the following table.

See the **Network Guide** for details of NETWORK operation.

- NOTE** • To use the wireless network function of this projector, the designated USB wireless adapter that is sold as an option is required. Do not use any extension cable or device when connecting the adapter to the projector.
- The projector does not allow both wireless and wired LAN to be connected to the same network.
 - Do not set the same network address for both wireless and wired LAN.
 - If you are not utilizing SNTP ([3.1.8 Date/Time Settings](#) in the **Network Guide**), then you must set the DATE AND TIME during the initial installation.
 - The network communication control is disabled while the projector is in standby mode if the STANDBY MODE item of SETUP menu is set to SAVING. Please connect the network communication to the projector after setting the STANDBY MODE to NORMAL ([44](#)).

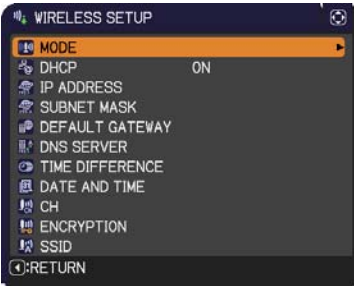
Item	Description	
<p>WIRELESS SETUP</p>	<p>Selecting this item displays the WIRELESS SETUP menu for the wireless LAN. Use the ▲/▼ buttons to select an item, and the ► or ENTER button on the remote control to perform the item.</p> 	
	<p>MODE</p>	<p>Use the ▲/▼ buttons to select the mode of the network communication system. Select according to the settings of your computer.</p> <p>ADHOC ↔ INFRASTRUCTURE</p> <p>To save the setting, press the ► button.</p> <ul style="list-style-type: none"> • When ADHOC is selected, IEEE802.11 n cannot be used. • If ADHOC is set to MODE while one of WPA-PSK or WPA2-PSK is selected in ENCRYPTION, the ENCRYPTION (65) setting switches to OFF automatically.

Item	Description	
WIRELESS SETUP (continued)	DHCP (Dynamic Host Configuration Protocol)	<p>Use the ▲/▼ buttons to turn DHCP on/off. ON ⇔ OFF</p> <p>Select OFF when the network does not have DHCP enabled. To save the setting, press the ► button.</p> <ul style="list-style-type: none"> • When the “DHCP” setting changes to “ON”, it takes a little time to obtain IP address from DHCP server. • Auto IP function will be assigned an IP address if the projector could not obtain an IP address from server even if DHCP is “ON”
	IP ADDRESS	<p>Use the ▲/▼/◀/▶ buttons to enter the IP ADDRESS.</p> <p>This function can only be used when DHCP is set to OFF.</p> <ul style="list-style-type: none"> • The IP ADDRESS is the number that identifies this projector on the network. You cannot have two devices with the same IP ADDRESS on the same network. • The IP ADDRESS “0.0.0.0” is prohibited.
	SUBNET MASK	<p>Use the ▲/▼/◀/▶ buttons to enter the same SUBNET MASK used by your computer.</p> <p>This function can only be used when DHCP is set to OFF.</p> <ul style="list-style-type: none"> • The SUBNET MASK “0.0.0.0” is prohibited.
	DEFAULT GATEWAY	<p>Use the ▲/▼/◀/▶ buttons to enter the DEFAULT GATEWAY (a node on a computer network that serves as an access point to another network) address.</p> <p>This function can only be used when DHCP is set to OFF.</p>
	DNS SERVER	<p>Use the ▲/▼/◀/▶ buttons to input the DNS server address.</p> <p>The DNS server is a system to control domain names and IP addresses on the Network.</p>
	TIME DIFFERENCE	<p>Use the ▲/▼ buttons to enter the TIME DIFFERENCE.</p> <p>Set the same TIME DIFFERENCE as the one set on your computer. If unsure, consult your IT manager.</p> <p>Use the ► button to return to the menu after setting the TIME DIFFERENCE.</p> <ul style="list-style-type: none"> • When this item is set, the same item in the WIRED SETUP menu is overwritten with the same setting (📖69).

(continued on next page)

Item	Description															
<p>WIRELESS SETUP (continued)</p>	<p>DATE AND TIME</p>	<p>Use the ▲/▼/◀/▶ buttons to enter the Year (last two digits), Month, Date, Hour and Minute.</p> <ul style="list-style-type: none"> • When this item is set, the same item in the WIRED SETUP menu is overwritten with the same setting (📖69). • The projector will override this setting and retrieve DATE AND TIME information from the Time server when SNTP is enabled. (📖3.1.8 Date/Time Settings in the Network Guide) • This setting will be reset if the projector is turned off while STANDBY MODE in the SETUP menu is set to SAVING (📖44), or when the AC power is turned off. 														
	<p>CH</p>	<p>Use the ▲/▼ buttons to select the channel of the wireless LAN to be used while MODE (📖63) is set to ADHOC. Select according to the settings of your computer.</p> <p>The channels 1 to 11 are available. To save the setting, press the ► button.</p> <ul style="list-style-type: none"> • The available channels would be various depending on a country. In addition, wireless network card might be required due to the standard. • This item can only be selected when MODE is set to ADHOC. When MODE is set to INFRASTRUCTURE, the channel is automatically selected. 														
	<p>ENCRYPTION</p>	<p>Use the ▲/▼ buttons to select the encryption method to be used.</p> <table style="margin-left: auto; margin-right: auto;"> <tr> <td style="text-align: center;">WPA2-PSK(AES)</td> <td style="text-align: center;">↔</td> <td style="text-align: center;">WPA2-PSK(TKIP)</td> </tr> <tr> <td style="text-align: center;">↕</td> <td></td> <td style="text-align: center;">↕</td> </tr> <tr> <td style="text-align: center;">OFF</td> <td></td> <td style="text-align: center;">WPA-PSK(AES)</td> </tr> <tr> <td style="text-align: center;">↕</td> <td></td> <td style="text-align: center;">↕</td> </tr> <tr> <td colspan="3" style="text-align: center;">WEP 64bit ↔ WEP 128bit ↔ WPA-PSK(TKIP)</td> </tr> </table> <p>To save the setting, press the ► button.</p> <ul style="list-style-type: none"> • When MODE (📖63) is set to ADHOC, either WPA-PSK and WPA2-PSK cannot be selected. • If IEEE802.11 n is used while MODE is set to INFRASTRUCTURE, TKIP and WEP are disabled. If OFF or AES is not selected, communication will switch automatically to IEEE802.11 b/g. 	WPA2-PSK(AES)	↔	WPA2-PSK(TKIP)	↕		↕	OFF		WPA-PSK(AES)	↕		↕	WEP 64bit ↔ WEP 128bit ↔ WPA-PSK(TKIP)	
WPA2-PSK(AES)	↔	WPA2-PSK(TKIP)														
↕		↕														
OFF		WPA-PSK(AES)														
↕		↕														
WEP 64bit ↔ WEP 128bit ↔ WPA-PSK(TKIP)																

(continued on next page)

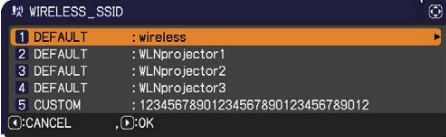
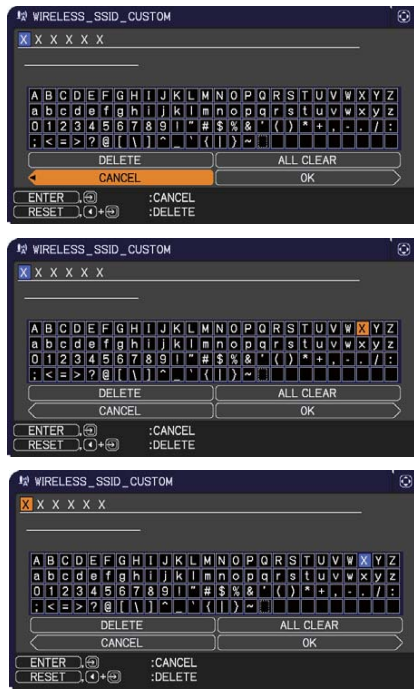
Item	Description
<p>WIRELESS SETUP (continued)</p>	<p>SSID</p> <p>Use the ▲/▼ buttons to select the SSID to display the SSID menu.</p>  <p>#1 DEFAULT ⇔ #2 DEFAULT ⇔ #3 DEFAULT ↶ ↷ #5 CUSTOM ⇔ #4 DEFAULT ↶↷</p> <p>Select one of the DEFAULT (#1~#4) and press ► or ENTER button.</p> <p>To adjust CUSTOM</p> <p>Press the ► or ENTER button when the # 5 CUSTOM is selected. The SSID #5 CUSTOM menu will be appeared.</p> <p>(1) The current SSID will be displayed on the first line. If not yet written, the line will be blank. Use the ▲/▼/◀/► buttons and the ENTER or INPUT button to select and enter characters. To erase 1 character at one time, press the RESET button or press the ◀ and INPUT button at the same time. Also if you move the cursor to DELETE or ALL CLEAR on screen and press the ENTER or INPUT button, 1 character or all characters will be erased. The SSID can be input up to 32 characters.</p> <p>(2) To change an already inserted character, press the ▲/▼ button to move the cursor to one of the first 2 lines, and use the ◀/► buttons to move the cursor on the character to be changed. After pressing the ENTER or INPUT button, the character is selected. Then, follow the same procedure as described at the item (1) above.</p>  <p>(3) To finish entering text, move the cursor to the OK on screen and press the ►, ENTER or INPUT button. To revert to the previous name without saving changes, move the cursor to the CANCEL on screen and press the ◀, ENTER or INPUT button.</p>

(continued on next page)

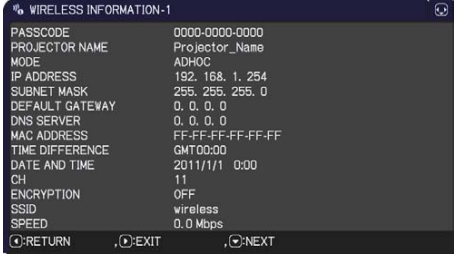
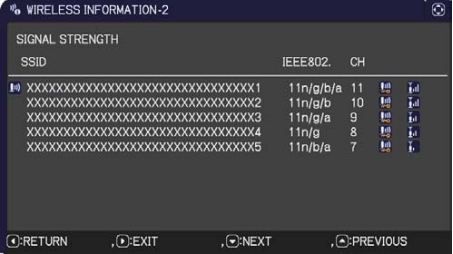
Item	Description
<p>WIRELESS INFORMATION</p>	<p>Selecting this item displays the WIRELESS INFORMATION dialog for viewing the wireless LAN settings. Use the ▲/▼ buttons to switch the page.</p> <p>The first page shows the wireless LAN settings. The second and subsequent pages display the signal information of wireless LAN connection devices.</p> <div style="display: flex; justify-content: space-around;">   </div> <ul style="list-style-type: none"> • For details of PASSCODE, refer to the manual for “LiveViewer”. • Nothing (blank) is shown in the PROJECTOR NAME (📖70) and SSID (📖66) field until you setup those items. Only the first 16 characters of the PROJECTOR NAME and SSID are displayed. • IP ADDRESS, SUBNET MASK and DEFAULT GATEWAY indicate “0.0.0.0” in the following condition. <ol style="list-style-type: none"> (1) The USB wireless adapter is not inserted into the projector. (2) DHCP is ON and the projector does not get address from DHCP server. • Nothing (blank) is shown in the MAC ADDRESS, CH and SPEED fields if the USB wireless adapter is not inserted. • The actual performance and setting will be shown in the CH and SPEED field, instead of the setting value in the WIRELESS SETUP menu. • An icon is displayed to the left of the SSID of the device connected to the projector.

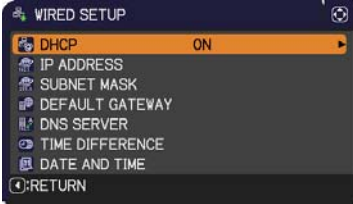

(continued on next page)

Item	Description	
WIRED SETUP	<p>Selecting this item displays the WIRED SETUP menu for the wired LAN. Use the ▲/▼ buttons to select an item, and the ► or ENTER button on the remote control to perform the item.</p> 	
	DHCP (Dynamic Host Configuration Protocol)	<p>Use the ▲/▼ buttons to turn DHCP on/off. ON ⇄ OFF</p> <p>Select OFF when the network does not have DHCP enabled. To save the setting, press the ► button.</p> <ul style="list-style-type: none"> • When the “DHCP” setting changes to “ON”, it takes a little time to obtain IP address from DHCP server. • Auto IP function will be assigned an IP address if the projector could not obtain an IP address from server even if DHCP is “ON”.
	IP ADDRESS	<p>Use the ▲/▼/◀/▶ buttons to enter the IP ADDRESS. This function can only be used when DHCP is set to OFF.</p> <ul style="list-style-type: none"> • The IP ADDRESS is the number that identifies this projector on the network. You cannot have two devices with the same IP ADDRESS on the same network. • The IP ADDRESS “0.0.0.0” is prohibited.
	SUBNET MASK	<p>Use the ▲/▼/◀/▶ buttons to enter the same SUBNET MASK used by your computer. This function can only be used when DHCP is set to OFF.</p> <ul style="list-style-type: none"> • The SUBNET MASK “0.0.0.0” is prohibited.
	DEFAULT GATEWAY	<p>Use the ▲/▼/◀/▶ buttons to enter the DEFAULT GATEWAY (a node on a computer network that serves as an access point to another network) address. This function can only be used when DHCP is set to OFF.</p>
	DNS SERVER	<p>Use the ▲/▼/◀/▶ buttons to input the DNS server address. The DNS server is a system to control domain names and IP addresses on the Network.</p>

(continued on next page)

Item	Description	
<p>WIRED SETUP (continued)</p>	<p>TIME DIFFERENCE</p>	<p>Use the ▲/▼ buttons to enter the TIME DIFFERENCE. Set the same TIME DIFFERENCE as the one set on your computer. If unsure, consult your IT manager. Use the ► button to return to the menu after setting the TIME DIFFERENCE.</p> <ul style="list-style-type: none"> • When this item is set, the same item in the WIRELESS SETUP menu is overwritten with the same setting (📖64).
	<p>DATE AND TIME</p>	<p>Use the ▲/▼/◀/▶ buttons to enter the Year (last two digits), Month, Date, Hour and Minute.</p> <ul style="list-style-type: none"> • When this item is set, the same item in the WIRELESS SETUP menu is overwritten with the same setting (📖65). • The projector will override this setting and retrieve DATE AND TIME information from the Time server when SNTP is enabled. (📖3.1.8 Date/Time Settings in the Network Guide) • This setting will be reset if the projector is turned off while STANDBY MODE in the SETUP menu is set to SAVING (📖44), or when the AC power is turned off.
<p>WIRED INFORMATION</p>	<p>Selecting this item displays the WIRED INFORMATION dialog for viewing the wired LAN settings.</p> <div data-bbox="715 1261 1171 1509" data-label="Image"> </div> <ul style="list-style-type: none"> • For details of PASSCODE, refer to the manual for “LiveViewer”. • Only the first 16 characters of the PROJECTOR NAME are displayed. • IP ADDRESS, SUBNET MASK and DEFAULT GATEWAY indicate “0.0.0.0” when DHCP is ON and the projector has not gotten address from DHCP server. 	

(continued on next page)

Item	Description
<p style="text-align: center;">PROJECTOR NAME</p>	<p>(1) Use the ▲/▼ buttons on the NETWORK menu to select the PROJECTOR NAME and press the ► button. The PROJECTOR NAME dialog will be displayed.</p>  <p>(2) The current PROJECTOR NAME will be displayed on the first 3 lines. Particular projector name is pre-assigned by default. Use the ▲/▼/◀/▶ buttons and the ENTER or INPUT button to select and enter characters. To erase 1 character at one time, press the RESET button or press the ◀ and INPUT button at the same time. Also if you move the cursor to DELETE or ALL CLEAR on screen and push the ENTER or INPUT button, 1 character or all characters will be erased. The PROJECTOR NAME can be input up to 64 characters.</p> <p>(3) To change an already inserted character, press the ▲/▼ button to move the cursor to one of the first 3 lines, and use the ◀/▶ buttons to move the cursor on the character to be changed. After pressing the ENTER or INPUT button, the character is selected. Then, follow the same procedure as described at the item (2) above.</p>   <p>(4) To finish entering text, move the cursor to the OK on screen and press the ►, ENTER or INPUT button. To revert to the previous PROJECTOR NAME without saving changes, move the cursor to the CANCEL on screen and press the ◀, ENTER or INPUT button.</p>

(continued on next page)

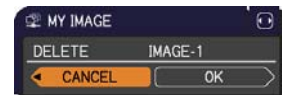

Item	Description
<p>MY IMAGE</p>	<p>Selecting this item displays the MY IMAGE menu.</p> <p>Use the application to transfer the image data. It can be downloaded from the Hitachi web site.</p> <p>Use the ▲/▼ buttons to select an item which is a still image by the MY IMAGE (4. My Image Function in the Network Guide) and the ► or ENTER button to display the image.</p> <ul style="list-style-type: none"> • The item without image stored cannot be selected. • The image names are each displayed in 16 characters or less. <p>To switch the image displayed Use the ▲/▼ buttons.</p> <p>To return to the menu Press the ◀ button on the remote control.</p> <p>To erase the image displayed and its source file in the projector.</p> <p>(1) Press the RESET button on the remote control while displaying an image to display the MY IMAGE DELETE menu.</p> <p>(2) Press the ► button to perform to erase. To stop erasing, press the ◀ button.</p>
<p>AMX D.D. (AMX Device Discovery)</p>	<p>Use the ▲/▼ buttons to turn the AMX Device Discovery on/off. ON ⇄ OFF</p> <p>When ON is selected, the projector can be detected by controllers of AMX connected to the same network. For the details of AMX Device Discovery, visit the AMX web site. <u>URL: http://www.amx.com/</u> (as of Dec. 2010)</p>



(continued on next page)

Item	Description
PRESENTATION	<p>Selecting this item displays the PRESENTATION menu. Use ▲/▼ buttons to select one of the following items, then press ► or ENTER button to use the function.</p> <ul style="list-style-type: none"> • To use Network Presentation, an exclusive application, “LiveViewer” is required. It can be installed from the bundled application CD. You can also download the latest version and relevant information from the Hitachi website (http://www.hitachi-america.us/digitalmedia or http://www.hitachidigitalmedia.com). For details of Network Presentation and instructions to install the “LiveViewer”, refer to the manual for “LiveViewer”.
	<p style="text-align: center;">QUIT PRESENTER MODE</p> <p>If you set a computer to the Presenter mode while its image is projected, the projector is occupied by the computer and access from any other computer is blocked.</p> <p>Use this function to quit the Presenter mode and allow other computers to access the projector. Select this item to display a dialog. Press ► button to choose OK in the dialog. The Presenter mode is cancelled and a message is displayed indicating the result.</p> <ul style="list-style-type: none"> • To make Presenter mode setting, use “LiveViewer”. For details, refer to the manual for “LiveViewer”.
	<p style="text-align: center;">MULTI PC MODE</p> <p>If you set one or more computers to the Multi PC mode on “LiveViewer” and send their images to the projector, you can select the display mode on the projector from two options below.</p> <ul style="list-style-type: none"> - Single PC mode: displays the image of the selected computer on full screen. - Multi PC mode: displays the images sent from up to four computers on screen that is divided into quarter sections. <p>Select this item to display a dialog. Use the dialog to change the display mode as explained below.</p> <ul style="list-style-type: none"> • To change from Multi PC mode to Single PC mode, select one of computers in the dialog using the ▲/▼/◀/▶ buttons and press the ENTER or INPUT button. <p>Press the ► button to choose OK, and then press ENTER or INPUT again. The image for the selected computer is displayed on full screen.</p> <p>(continued on next page)</p>

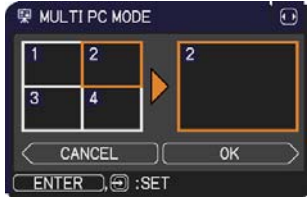
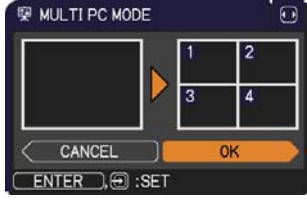
(continued on next page)

Item	Description
<p>PRESENTATION (continued)</p>	<p>MULTI PC MODE (continued)</p> <ul style="list-style-type: none"> • To change from Single PC mode to Multi PC mode, press ► button to choose OK in the dialog and press the ENTER or INPUT button. The display mode is changed. • For details on how to switch the display mode to Multi PC mode on your computer, refer to the manual for “LiveViwer”. • The Presenter mode setting of the selected computer becomes valid when the display mode is changed to Single PC mode. Also, the Presenter mode setting becomes invalid when the display mode is changed to Multi PC mode, regardless the setting on the computers. For details, refer to the manual for “LiveViewer”.  
	<p>DISPLAY USER NAME</p> <p>Selecting this item displays the user name. This function helps you identify from which computer the current image is sent.</p> <ul style="list-style-type: none"> • You can set user names for each computer on “LiveViwer”. For details, refer to the manual for “LiveViewer”.
<p>SERVICE</p>	<p>Executing this item restarts and initializes the network functions. Choose the RESTART EXECUTE using the button ►.</p>  <p>Then use the button ► to execute.</p>  <p>Network will be once cut off when choose restart. If DHCP is selected on, IP address may be changed. After selecting RESTART EXECUTE, NETWORK menu may not be controlled approx. 30 seconds.</p>

SECURITY menu

This projector is equipped with security functions.

From the SECURITY menu, items shown in the table below can be performed.

To use SECURITY menu: User registration is required before using the security functions.

Enter to the SECURITY menu

1. Press the ► button. The ENTER PASSWORD box will be displayed.
2. Use the ▲/▼/◀/▶ buttons to enter the registered password. The factory default password is as follows.
 CP-X2514WN, CP-X3014WN, CP-X4014WN: 3292
 CP-WX3014WN: 1692

This password can be changed ([below](#)). Move the cursor to the right side of the ENTER PASSWORD box and press the ► button to display the SECURITY menu.

- It is strongly recommended the factory default password to be changed as soon as possible.
 - If an incorrect password is input, the ENTER PASSWORD box will be displayed again. If incorrect password is input 3 times, the projector will turn off. Afterwards the projector will turn off every time an incorrect password is input.
3. Items shown in the table below can be performed.

If you have forgotten your password

- (1) While the ENTER PASSWORD box is displayed, press and hold the **RESET** button on the remote control for about 3 seconds or press and hold the **INPUT** button for 3 seconds while pressing the ► button on the projector.
- (2) The 10 digit Inquiring Code will be displayed. Contact your dealer with the 10 digit Inquiring Code. Your password will be sent after your user registration information is confirmed.



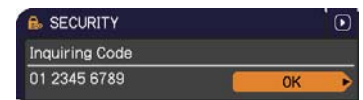
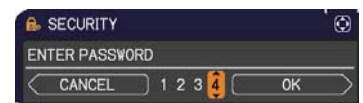
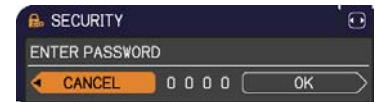

• If there is no key input for about 55 seconds while the Inquiring Code is displayed, the menu will close. If necessary, repeat the process from (1).

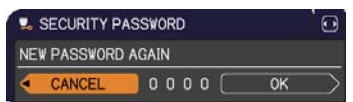

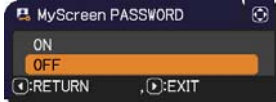

Item	Description
<p>SECURITY PASSWORD CHANGE</p>	<ol style="list-style-type: none"> (1) Use the ▲/▼ buttons on the SECURITY menu to select SECURITY PASSWORD CHANGE and press the ► button to display the ENTER NEW PASSWORD box. (2) Use the ▲/▼/◀/▶ buttons to enter the new password. (3) Move the cursor to the right side of the ENTER NEW PASSWORD box and press the ► button to display the NEW PASSWORD AGAIN box, enter the same password again. (4) Move the cursor to the right side of the NEW PASSWORD AGAIN box and press the ► button and the NOTE NEW PASSWORD box will be displayed for about 30 seconds, please make note of the password during this time. Pressing the ENTER button on the remote control or ► button on the projector will close the NOTE NEW PASSWORD box. <ul style="list-style-type: none"> • Please do not forget your password.

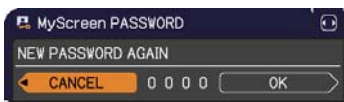

(continued on next page)

Item	Description
<p>MyScreen PASSWORD</p>	<p>The MyScreen PASSWORD function can be used to prohibit access to the MyScreen function and prevent the currently registered MyScreen image from being overwritten.</p> <p>1 Turning on the MyScreen PASSWORD</p> <p>1-1 Use the ▲/▼ buttons on the SECURITY menu to select MyScreen PASSWORD and press the ► button to display the MyScreen PASSWORD on/off menu.</p>  <p>1-2 Use the ▲/▼ buttons on the MyScreen PASSWORD on/off menu to select ON. The ENTER NEW PASSWORD box (small) will be displayed.</p>  <p>1-3 Use the ▲/▼/◀/▶ buttons to enter the password. Move the cursor to the right side of the ENTER NEW PASSWORD box (small) and press the ► button to display the NEW PASSWORD AGAIN box, enter the same PASSWORD again.</p>  <p>1-4 Move the cursor to the right side of the NEW PASSWORD AGAIN box and press the ► button to display the NOTE NEW PASSWORD box for about 30 seconds, please make note of the password during this time.</p>  <p>Pressing the ENTER button on the remote control or ► button on the projector will return to MyScreen PASSWORD on/off menu.</p> <p>When a password is set for MyScreen:</p> <ul style="list-style-type: none"> • The MyScreen registration function (and menu) will be unavailable. • The MyScreen Lock menu will be unavailable. • The START UP setting will be locked on MyScreen (and the menu will be unavailable). <p>Turning the MyScreen PASSWORD off will allow normal operation of these functions.</p> <ul style="list-style-type: none"> • Please do not forget your MyScreen PASSWORD. <p>2 Turning off the MyScreen PASSWORD</p> <p>2-1 Follow the procedure in 1-1 to display the MyScreen PASSWORD on/off menu.</p> <p>2-2 Select OFF to display the ENTER PASSWORD box (large). Enter the registered password and the screen will return to the MyScreen PASSWORD on/off menu.</p>  <p>If an incorrect PASSWORD is input, the menu will close. If necessary, repeat the process from 2-1.</p> <p>3 If you have forgotten your password</p> <p>3-1 Follow the procedure in 1-1 to display the MyScreen PASSWORD on/off menu.</p> <p>3-2 Select OFF to display the ENTER PASSWORD box (large). The 10 digit Inquiring Code will be displayed inside the box.</p> <p>3-3 Contact your dealer with the 10 digit Inquiring Code. Your password will be sent after your user registration information is confirmed.</p>

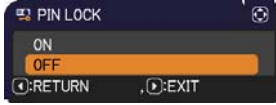
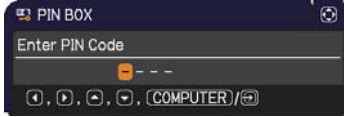
(continued on next page)

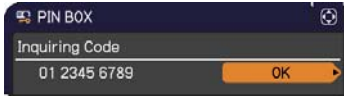
Item	Description
<p>PIN LOCK</p>	<p>PIN LOCK is a function which prevents the projector from being used unless a registered Code is input.</p> <p>1 Turning on the PIN LOCK</p> <p>1-1 Use the ▲/▼ buttons on the SECURITY menu to select PIN LOCK and press the ► button or the ENTER button to display the PIN LOCK on/off menu.</p>  <p>1-2 Use the ▲/▼ buttons on the PIN LOCK on/off menu to select ON and the Enter PIN Code box will be displayed.</p>  <p>1-3 Input a 4 part PIN code using the ▲/▼/◀/▶, COMPUTER or INPUT button. The PIN Code again box will appear. Reenter the same PIN code. This will complete the PIN code registration.</p>  <ul style="list-style-type: none"> • If there is no key input for about 55 seconds while the Enter PIN Code box or the PIN Code again box is displayed, the menu will close. If necessary, repeat the process from 1-1. <p>Afterwards, anytime the projector is restarted after AC power is turned off the Enter PIN Code box will be displayed. Enter the registered PIN code. The projector can be used after entering the registered PIN code. If an incorrect PIN code is input, the Enter PIN code box will be displayed again. If an incorrect PIN code is input 3 times, the projector will turn off. Afterwards the projector will turn off every time an incorrect PIN code is input. The projector will also turn off if there is no key input for about 5 minutes while the Enter PIN code box is displayed. This function will activate only when the projector is started after AC power is turned off.</p> <ul style="list-style-type: none"> • Please do not forget your PIN code. <p>2 Turning off the PIN LOCK</p> <p>2-1 Follow the procedure in 1-1 to display the PIN LOCK on/off menu.</p> <p>2-2 Use the ▲/▼ buttons to select OFF and the Enter PIN Code box will be displayed. Enter the registered PIN code to turn the PIN LOCK function off. If an incorrect PIN code is input 3 times, the projector will turn off.</p> <p>3 If you have forgotten your PIN code</p> <p>3-1 While the Enter PIN code box is displayed, press and hold the RESET button for three seconds or press and hold the INPUT button for 3 seconds while pressing the ► button on the projector. The 10 digit Inquiring Code will be displayed.</p>  <ul style="list-style-type: none"> • If there is no key input for about 5 minutes while the Inquiring Code is displayed, the projector will turn off. <p>3-2 Contact your dealer with the 10 digit Inquiring Code. Your PIN code will be sent after your user registration information is confirmed.</p>

(continued on next page)

Item	Description
<p style="text-align: center;">TRANSITION DETECTOR</p>	<p>If this function is set to ON when the vertical angle of the projector or MIRROR setting at which the projector is turned on is different than the previously recorded, the TRANSITION DETECTOR ON alarm will be displayed and the projector will not display the input signal.</p> <ul style="list-style-type: none"> • To display the signal again, set this function OFF. • After about 5 minutes of displaying the TRANSITION DETECTOR ON alarm, the lamp will turn off. • Keystone adjustment feature has been prohibited as long as the Transition Detector function is on. <p>1 Turning on the TRANSITION DETECTOR</p> <p>1-1 Use the ▲/▼ buttons on the SECURITY menu to select TRANSITION DETECTOR and press the ► or the ENTER button to display the TRANSITION DETECTOR on/off menu.</p> <p>1-2 Use the ▲/▼ buttons on the TRANSITION DETECTOR on/off menu to select ON. Select ON and the current angle and MIRROR setting will be recorded. The ENTER NEW PASSWORD box (small) will be displayed.</p> <p>1-3 Use the ▲/▼/◀/▶ buttons to enter a password. Move the cursor to the right side of the ENTER NEW PASSWORD box (small) and press the ► button to display the NEW PASSWORD AGAIN box, enter the same password again.</p> <p>1-4 Move the cursor to the right side of the NEW PASSWORD AGAIN box and press the ► button to display the NOTE NEW PASSWORD box for about 30 seconds, please make note of the password during this time. Pressing the ENTER button on the remote control or the ► button on the projector will return to the TRANSITION DETECTOR on/off menu.</p> <ul style="list-style-type: none"> • Please do not forget your TRANSITION DETECTOR password. • This function will activate only when the projector is started after turning off the AC power. • This feature may not function properly if the projector is not in a stable position when ON is selected. <p>2 Turning off the TRANSITION DETECTOR</p> <p>2-1 Follow the procedure in 1-1 to display the TRANSITION DETECTOR on/off menu.</p> <p>2-2 Select OFF to display the ENTER PASSWORD box (large). Enter the registered password and the screen will return to the TRANSITION DETECTOR on/off menu.</p> <p>If an incorrect password is input, the menu will close. If necessary, repeat the process from 2-1.</p> <p>3 If you have forgotten your password</p> <p>3-1 Follow the procedure in 1-1 to display the TRANSITION DETECTOR on/off menu.</p> <p>3-2 Select OFF to display the ENTER PASSWORD box (large). The 10 digit Inquiring Code will be displayed inside the box.</p> <p>3-3 Contact your dealer with the 10 digit Inquiring Code. Your password will be sent after your user registration information is confirmed.</p>

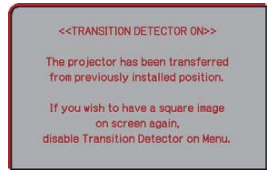



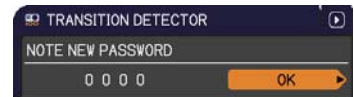
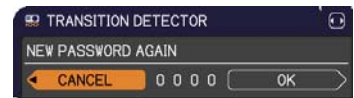

ENTER NEW PASSWORD box (small)





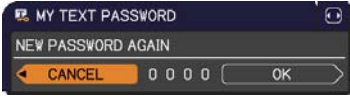

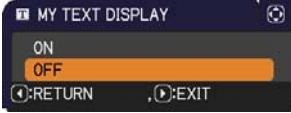

ENTER PASSWORD box (large)

(continued on next page)

Item	Description
<p>MY TEXT PASSWORD</p>	<p>The MY TEXT PASSWORD function can prevent the MY TEXT from being overwritten. When the password is set for the MY TEXT;</p> <ul style="list-style-type: none"> • The MY TEXT DISPLAY menu will be unavailable, which can prohibit changing the DISPLAY setting. • The MY TEXT WRITING menu will be unavailable, which can prevent the MY TEXT from being overwritten. <p>1 Turning on the MY TEXT PASSWORD</p> <p>1-1 Use the ▲/▼ buttons on the SECURITY menu to select the MY TEXT PASSWORD and press the ► button to display the MY TEXT PASSWORD on/off menu.</p>  <p>1-2 Use the ▲/▼ buttons on the MY TEXT PASSWORD on/off menu to select ON. The ENTER NEW PASSWORD box (small) will be displayed.</p>  <p>ENTER NEW PASSWORD box (small)</p> <p>1-3 Use the ▲/▼/◀/▶ buttons to enter the password. Move the cursor to the right side of the ENTER NEW PASSWORD box (small) and press the ► button to display the NEW PASSWORD AGAIN box, and then enter the same password again.</p>  <p>1-4 Move the cursor to the right side of the NEW PASSWORD AGAIN box and press ► button to display the NOTE NEW PASSWORD box for about 30 seconds, then please make note of the password during this time.</p>  <p>Pressing the ENTER button on the remote control or ► button on the projector will return to the MY TEXT PASSWORD on/off menu.</p> <p>2 Turning off the MY TEXT PASSWORD</p> <p>2-1 Follow the procedure in 1-1 to display the MY TEXT PASSWORD on/off menu.</p> <p>2-2 Select OFF to display the ENTER PASSWORD box (large). Enter the registered password and the screen will return to the MY TEXT PASSWORD on/off menu.</p>  <p>ENTER PASSWORD box (large)</p> <p>If an incorrect password is input, the menu will close. If necessary, repeat the process from 2-1</p> <p>3 If you have forgotten your password</p> <p>3-1 Follow the procedure in 1-1 to display the MY TEXT PASSWORD on/off menu.</p> <p>3-2 Select OFF to display the ENTER PASSWORD box (large). The 10 digit inquiring code will be displayed inside the box.</p> <p>3-3 Contact your dealer with the 10 digit inquiring code. Your password will be sent after your user registration information is confirmed.</p>

(continued on next page)

Item	Description
<p>MY TEXT DISPLAY</p>	<p>(1) Use the ▲/▼ buttons on the SECURITY menu to select the MY TEXT DISPLAY and press the ► or ENTER button to display the MY TEXT DISPLAY on/off menu.</p>  <p>(2) Use the ▲/▼ buttons on the MY TEXT DISPLAY on/off menu to select on or off. ON ⇔ OFF</p> <p>When it is set ON, the MY TEXT will be displayed on the START UP screen and the INPUT_INFORMATION when the INFORMATION on the SERVICE menu is chosen.</p> <ul style="list-style-type: none"> This function is available only when the MY TEXT PASSWORD function is set to the OFF.  
<p>MY TEXT WRITING</p>	<p>(1) Use the ▲/▼ buttons on the SECURITY menu to select the MY TEXT WRITING and press the ► button. The MY TEXT WRITING dialog will be displayed.</p>  <p>(2) The current MY TEXT will be displayed on the first 3 lines. If not yet written, the lines will be blank. Use the ▲/▼/◀/▶ buttons and the ENTER or INPUT button to select and enter characters. To erase 1 character at one time, press the RESET button or press the ◀ and INPUT button at the same time. Also if you move the cursor to DELETE or ALL CLEAR on screen and press the ENTER or INPUT button, 1 character or all characters will be erased. The MY TEXT can be input up to 24 characters on each line.</p>  <p>(3) To change an already inserted character, press the ▲/▼ button to move the cursor to one of the first 3 lines, and use the ◀/▶ buttons to move the cursor on the character to be changed. After pressing the ENTER or INPUT button, the character is selected. Then, follow the same procedure as described at the item (2) above.</p>  <p>(4) To finish entering text, move the cursor to the OK on screen and press the ►, ENTER or INPUT button. To revert to the previous MY TEXT without saving changes, move the cursor to the CANCEL on screen and press the ◀, ENTER or INPUT button.</p> <ul style="list-style-type: none"> The MY TEXT WRITING function is available only when the MY TEXT PASSWORD function is set to OFF.

Presentation tools



The projector has the following two convenient tools that enable on-screen presentations easily and quickly:

- PC-LESS Presentation ( *below*)
- USB Display ( 90)

PC-LESS Presentation

The PC-LESS Presentation reads image and audio data from the storage media inserted into the **USB TYPE A** port and displays the image in the following modes. The PC-LESS Presentation can be started by selecting the **USB TYPE A** port as the input source.

This feature allows you to make your presentations without using your computer.

- Thumbnail mode ( 81)
- Full Screen mode ( 85)
- Slideshow mode ( 87)

[Supported storage media]

- USB memory (USB memory type, USB hard disk and USB card reader type)

- NOTE** • USB readers (adapters) that have more than one USB slot may not work (if the adapter is acknowledged as multiple devices connected).
- USB hubs may not work.
 - USB devices with security software may not work.
 - Be careful when inserting or removing a USB device. ( 12, 83)

[Supported format]

- FAT12, FAT16 and FAT32

- NOTE** • NTFS is not supported.

PC-LESS Presentation (continued)**[Supported file format and its extension]**

- JPEG (.jpeg, .jpg) * Progressive is not supported.
- Bitmap (.bmp) * 16bit mode and compressed bitmap is not supported.
- PNG (.png) * Interlace PNG is not supported.
- GIF (.gif)
- Movie (.avi, .mov) * Supported video format: Motion-JPEG
Supported audio format: WAV (Linear PCM, Stereo 16bit), IMA-ADPCM

NOTE • Files with a resolution larger than the following are not supported.
 CP-X2514WN, CP-X3014WN, CP-X4014WN: 1024 x 768 (Still), 768 x 576 (Movie)
 CP-WX3014WN: 1280 x 800 (Still), 768 x 576 (Movie)
 (* Some computers may not support 1280 x 800.)

- Files with a resolution smaller than 36 x 36 are not supported.
- Files with a resolution smaller than 100 x 100 may not be displayed.
- Movie images with a frame rate higher than 15 fps cannot be displayed.
- Movie images with a bit rate higher than 20 Mbps cannot be displayed.
- Some supported files may not be displayed.
- Only a frame appears when the content of image data cannot be displayed in the Thumbnail mode.
- Even with the file format and audio format combinations described above, playback of some files may fail.

Thumbnail mode

The Thumbnail mode displays the images stored in a USB storage device on the Thumbnail screen. Maximum 20 images are displayed in a screen.

If you wish, you can jump into the Full Screen mode or Slideshow mode, after you select some images in the Thumbnail mode.

The Thumbnail mode will be started as the primary function of the PC-LESS Presentation after selecting the **USB TYPE A** port as the input source.







PC-LESS Presentation (continued)

Operating by buttons or keys

You can control the images on the Thumbnail screen with the remote control, control panel or Web Remote Control. The following functions can be supported while the Thumbnail is displayed.





Button operation			Functions
The remote control	Control panel	Web Remote Control	
▲/▼/◀/▶	▲/▼/◀/▶	[▲]/[▼]/[◀]/[▶]	Move cursor
PAGE UP PAGE DOWN	-	[PAGE UP] [PAGE DOWN]	Switches pages
ENTER	INPUT	[ENTER]	<ul style="list-style-type: none"> • Displays the selected image on the Full Screen mode when a cursor is on a thumbnail image. • Displays the SETUP menu ( below) for the selected image when a cursor is on a thumbnail image number.

The SETUP menu for the selected image

Item	Functions
SETUP	Use the ◀/▶ cursor buttons to switch each setting or use the ▶ cursor button to execute the functions as follows.
RETURN	Press the ▶ cursor button or ENTER to return to the Thumbnail screen.
START	Switch to ON to set the selected image as the first image in the Slideshow. This setting information will be saved in the “playlist.txt” file ( 89).
STOP	Switch to ON to set the selected image as the last image in the Slideshow. This setting information will be saved in the “playlist.txt” file ( 89).
SKIP	Switch to ON to skip the selected image in the Slideshow. This setting information will be saved in the “playlist.txt” file ( 89).
ROTATE	Press the ▶ cursor or ENTER button to rotate the selected still image 90 degrees clockwise. This setting information will be saved in the “playlist.txt” file ( 89).

PC-LESS Presentation (continued)**Operating by the menu on the Thumbnail screen**

You can also control the images by using the menu on the Thumbnail screen.

Item	Functions
	Moves to an upper folder.
SORT	Allows you to sort files and folders as following.
RETURN	Press the ► cursor button or ENTER to return to the Thumbnail screen.
NAME UP	Sorts in ascending order by file name.
NAME DOWN	Sorts in descending order by file name.
DATE UP	Sorts in ascending order by file date.
DATE DOWN	Sorts in descending order.by file date.
▲/▼	Go to previous / next page.
SLIDESHOW	Configures and starts the Slideshow ( 87).
RETURN	Press the ► cursor button or ENTER to return to the Thumbnail screen.
PLAY	Press the ► cursor button or ENTER to start the Slideshow.
START	Sets the beginning number of the Slideshow.
STOP	Sets the end number of the Slideshow.
INTERVAL	Sets the interval time for displaying still images during the Slideshow.
PLAY MODE	Selects the Slideshow mode.
INPUT	Switches the input port.
MENU	Displays the menu.
REMOVE USB	Be sure to use this function before removing USB storage device from the projector. After that, the projector will not recognize a USB storage device until you insert it again into the USB TYPE A input port.
 / 	Turns the sound on/off for files that contain audio data.

PC-LESS Presentation (continued)

- NOTE** • These operations are not accessible while the projector OSD is displayed.
- The Thumbnail mode is able to display up to 20 files in one page.
 - It is not possible to change the input port by using the **INPUT** button when the Thumbnail screen, Slideshow, or Full Screen is displayed.
 - The image quality may deteriorate when playing back audio data included in a movie. If you want to give priority to the image quality, turn off the sound by setting 🎵 to off.
 - If one of the **AUDIO IN** ports is selected or 🚫 is selected for USB TYPE A in AUDIO SOURCE of the AUDIO menu (📖45), 🎵 cannot be operated.
 - Some error icons will be displayed in the Thumbnail.



————— This file seems to be broken or not supported format.

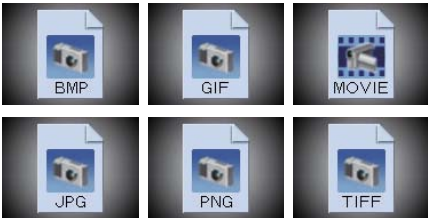

A file that cannot be displayed on the thumbnail screen is indicated by a file format icon.

PC-LESS Presentation (continued)**Full Screen Mode**

The Full Screen mode shows a full display image. To display in Full Screen mode, select an image in the Thumbnail screen. Then press the **ENTER** button on the remote control, the **INPUT** button on the control panel or click **[ENTER]** on the Web Remote Control.



Full screen display

Operations for still images

The following operations are enabled in the Full Screen mode while a still image is displayed.

Button operation			Functions
The remote control	Control panel	Web Remote Control	
▼ ▶ or PAGE DOWN	▼ or ▶	[▼] [▶] or [PAGE DOWN]	Shows the next file.
▲ ◀ or PAGE UP	▲ or ◀	[▲] [◀] or [PAGE UP]	Shows the previous file.
ENTER	INPUT	[ENTER]	Displays Thumbnail.

PC-LESS Presentation (continued)

Operations for movie

A remote control icon and a progress bar are displayed when one of the cursor buttons, **ENTER** button or **INPUT** button on the remote control, control panel or Web Remote Control is pressed or clicked while a movie is playing in the Full Screen mode. The following operations are enabled while the remote control icon and progress bar are displayed.



Button operation			Functions
The remote control	Control panel	Web Remote Control	
▲	▲	[▲]	(Play) / (Pause) toggle
▶	▶	[▶]	(FF) Fast-forward
◀	◀	[◀]	(REW) Fast-rewind
ENTER	INPUT	[ENTER]	(Stop), Displays Thumbnail.
PAGE DOWN	–	[PAGE DOWN]	Shows the next file.
PAGE UP	–	[PAGE UP]	Shows the previous file.

NOTE • These operations are not accessible while the projector OSD is displayed.
 • It is not possible to change the input port by using the **INPUT** button when the Thumbnail screen, Slideshow, or Full Screen is displayed.

PC-LESS Presentation (continued)

Slideshow mode

The Slideshow mode displays images in full screen and switches the images at intervals set in INTERVAL on the Thumbnail screen menu (📖83).

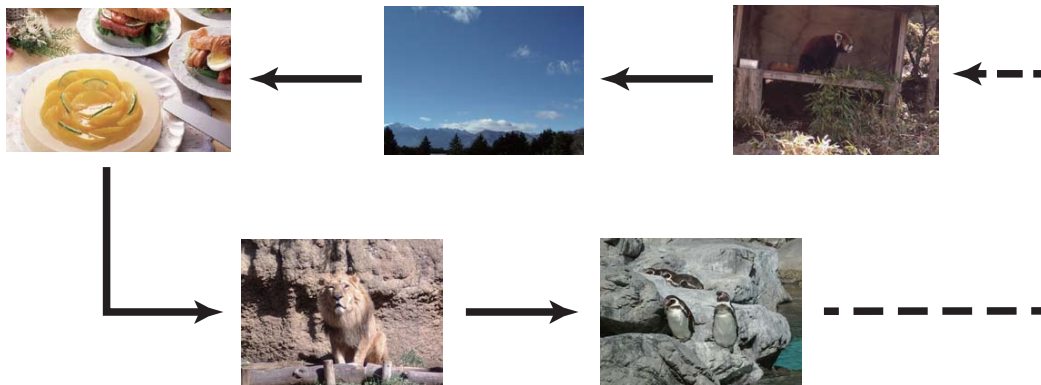

You can start this function from the Slideshow menu. To display the Slideshow menu, select the SLIDESHOW button in the Thumbnail mode and press the **ENTER** button on the remote control, **INPUT** button on the control panel, or click **[ENTER]** on the Web Remote Control.

While the Slideshow is displayed, the following button operations are enabled when still images are displayed, and the same button operations in the Full Screen mode are enabled when movies are displayed.

Button operation			Functions
The remote control	Control panel	Web Remote Control	
ENTER	INPUT	[ENTER]	Displays thumbnail

NOTE • These operations are not accessible while the projector OSD is displayed.

- It is not possible to change the input port by using the **INPUT** button when the Thumbnail screen, Slideshow, or Full Screen is displayed.
- When the Slideshow mode is set to ONE TIME and the last file is a still image, the last slide of the presentation will remain displayed until the **ENTER** button on the remote control or Web Remote Control, or the **INPUT** button on the control panel is pressed.

PC-LESS Presentation (continued)

You can play the Slideshow at your desired configuration. Configure the Slideshow items in the Thumbnail.

- 1) RETURN : Returns to the thumbnail mode.
- 2) PLAY : Play the Slideshow.
- 3) START : Set the beginning number of the Slideshow.
- 4) STOP : Set the end number of the Slideshow.
- 5) INTERVAL : Sets the interval time for displaying still images during the Slideshow.
It is not recommend to set the interval time very short something like several seconds, because it may take more than several seconds to read and display an image file if it is stored in very deep layer directory or if so many files are stored in the same directory.
- 6) PLAY MODE : Select the Slideshow mode.
ONE TIME : Play the Slideshow one time.
ENDLESS : Play the Slideshow endless.

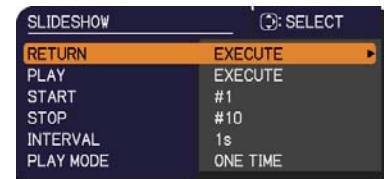

NOTE • The settings of the Slideshow are saved to the “**playlist.txt**” file that is stored in the storage media. If the file is not existed, it is generated automatically.

- The settings for the START, STOP, INTERVAL, and PLAY MODE are saved to the Playlist.
- If the storage media is under the write protection or the “**playlist.txt**” is the read only type file, it is impossible to change the settings of the Slideshow.

PC-LESS Presentation (continued)

Playlist

The Playlist is a DOS format text file, which decides the order of displayed still image files in the Thumbnail or Slideshow.

The playlist file name is “playlist.txt” and it can be edited on a computer.

It is created in the folder that contains the selected image files when the PC-LESS Presentation is started or the Slideshow is configured.

[Example of “playlist.txt” files]

START setting : STOP setting : INTERVAL setting : PLAY MODE setting :

img001.jpg: : : :

img002.jpg:600: : :

img003.jpg:700:rot1: :

img004.jpg: : :SKIP:

img005.jpg:1000:rot2:SKIP:

The “playlist.txt” file contains the following information.

Each piece of information requires to be separated by “:”, and “:” at the end of each line.

1st line: START, STOP, INTERVAL and PLAY MODE settings ([📖88](#)).

2nd line and after: file name, interval time, rotation setting and skip setting.

interval time: It can be set from 0 to 999900 (ms) with an increment of 100 (ms).

rotation setting: “rot1” means a rotation at 90 degrees clockwise; “rot2” and “rot3” increase another 90 degrees in order.

skip setting: “SKIP” means that the image will not be displayed in the Slideshow.

- NOTE** • The maximum length in a line on the "playlist.txt" file is 255 characters including linefeed. If any line exceeds the limit, the "playlist.txt" file becomes invalid.
- Up to 999 files can be registered to the Playlist. However, if some folders exist in the same directory the limit number is decreased by the number of folders. Any files over the limit will not be shown in the Slideshow.
 - If the storage device is protected or does not have sufficient space, the “playlist.txt” file cannot be created.
 - For the Slideshow settings, refer to the section **Slideshow mode** ([📖87](#)).

USB Display

The projector can display images transferred from a computer via an USB cable (📖11).

Hardware and software requirement for computer

- **OS:** One of the following. (32 bit version only)
Windows[®] XP Home Edition /Professional Edition
Windows Vista[®] Home Basic /Home Premium /Business /Ultimate /Enterprise
Windows[®] 7 Starter /Home Basic /Home Premium /Professional / Ultimate / Enterprise
- **CPU:** Pentium 4 (2.8 GHz or higher)
- **Graphic card:** 16 bit, XGA or higher
- **Memory:** 512 MB or higher
- **Hard disk space:** 30 MB or higher
- **USB Port**
- **USB cable :** 1 piece

Starting USB Display

Select the USB DISPLAY for the USB TYPE B item in the OPTION menu. When you connect your computer to the **USB TYPE B** port on the projector using a USB cable, the projector will be recognized as a CD-ROM drive on your computer. Then, the software in the projector, “LiveViewerLiteUSB.exe”, will run automatically and the application, “LiveViewer Lite for USB”, will be ready on your computer for the USB Display. The application, “LiveViewer Lite for USB”, will be automatically closed when the USB cable is unplugged.

NOTE • If the software does not start automatically (this is typically because CD-ROM autorun is disabled on your OS), follow the instructions below.

(1) Click on the [Start] button on the toolbar and select the “Run”

(2) Enter F:\LiveViewerLiteUSB.exe and then press the [OK]

↑ — If your CD-ROM drive is not drive F on your computer, you will need to replace F with the correct drive letter assigned to your CD-ROM drive.

- CD-ROM autorun is disabled while the screen saver is running.
- The image transmission from the computer is suspended while the password-protected screen saver is running. To resume the transmission, exit the screen saver.
- Check our web site for the latest version of the software and its manual.

(📖**User's Manual (concise)**)

Follow the instructions that can be obtained at the site for updating.

(continued on next page)

USB Display (continued)

This application will appear in the Windows notification area once it starts. You can quit the application from your computer by selecting “Quit” on the menu.



NOTE • The “LiveViewer” (refer to the **Network Guide**) and this application cannot be used at the same time. If you connect your computer to the projector by using a USB cable

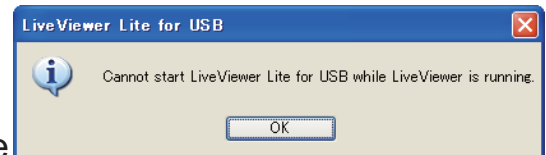

while the “LiveViewer” is running, the following message will be displayed.

- Depending on the software installed on your computer, images on your computer cannot be transferred using “LiveViewer Lite for USB”.
- If any application software having the firewall function is installed into your computer, make the firewall function invalid with following the user's manual.
- Some security software may block image transmission. Please change the security software setting to allow the use of “LiveViewer Lite for USB”.
- When the audio input from **USB TYPE B** (📖45) is selected, if the sound level is still low even after raising the volume level in the projector to the maximum, check whether your computer outputs audio and raise the volume level accordingly.

USB Display (continued)

Right-Click menu

The menu shown in the right will be displayed when you right-click the application icon in the Windows notification area.

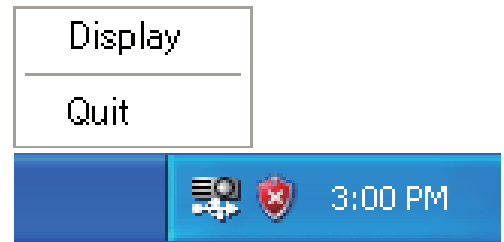

Display : The Floating menu is displayed, and the icon disappears from the Windows notification area.

Quit : The application is closed, and the icon disappears from the Windows notification area.

NOTE • If you wish to restart the application, you need to unplug the USB cable and plug it again.

Floating menu

If you select “Display” on the Right-Click menu, the Floating menu shown in the right will appear on your computer screen.

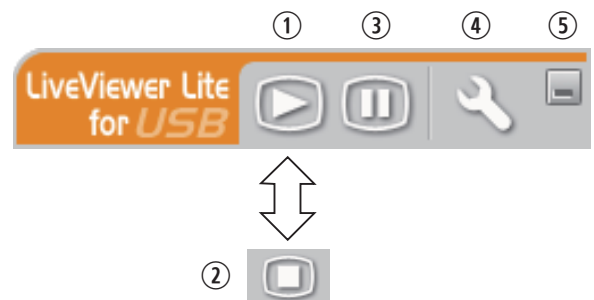

① Start capture button

The transmission to the projector is started and the images will be displayed.

② Stop button

The image transmission is stopped.

③ Hold button

The image on the projector’s screen is temporally frozen. The last image before the button is clicked is remained on the screen. You can revise the image data on your computer without showing it on the projector’s screen.

④ Option button

The Options window is displayed.

⑤ Minimize button

The Floating menu is closed, and the icon reappears in the Windows notification area.

NOTE • If you click the Start capture button and/or Stop button repeatedly, images may not be displayed on the screen.

USB Display (continued)

Options window

If you select the Option button on the Floating menu, the Options window is displayed.

Optimize Performance

The “LiveViewer Lite for USB” captures screenshots in JPEG data and sends them to the projector. The “LiveViewer Lite for USB” has two options that have different compression rate of JPEG data.

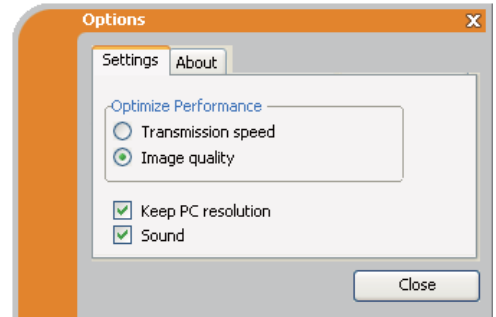

Transmission speed

Speed takes priority over Image quality.

It makes JPEG compression rate higher.

The screen on the projector is rewritten quicker because the transferred data is smaller, but the image quality is worse.

Image quality

Image quality takes priority over Speed.

It makes JPEG compression rate lower.

The screen on the projector is rewritten slower because the transferred data is larger, but the image quality is better.

Keep PC resolution

If you remove the check mark from the **[Keep PC resolution]** box, the screen resolution of your computer will be switched as follows, and the display speed may be faster.

CP-X2514WN, CP-X3014WN, CP-X4014WN: 1024 x 768 (XGA)

CP-WX3014WN: 1280 x 800

If your computer does not support the display resolution specified above, a smaller resolution that is the largest among the resolutions that are supported by the computer will be selected.

Sound

Turns the sound on/off. The image quality may deteriorate when you play back audio data transferred together with the image data. To give priority to the image quality, turn off the sound by selecting the checkbox.

About

The version information of the “LiveViewer Lite for USB”.

NOTE • When the resolution is changed, the arrangement of icons on computer desktop screen may be changed.

• If one of the **AUDIO IN** ports is selected or \times is selected for USB TYPE B in AUDIO SOURCE of the AUDIO menu (📖45), audio sound operation in the Options window will be disabled.

Maintenance

Replacing the lamp

A lamp has finite product life. Using the lamp for long periods of time could cause the pictures darker or the color tone poor. Note that each lamp has a different lifetime, and some may burst or burn out soon after you start using them. Preparation of a new lamp and early replacement are recommended. To prepare a new lamp, make contact with your dealer and tell the lamp type number.

Type number : DT01021

Replacing the lamp

1. Turn the projector off, and unplug the power cord.
 - Allow the projector to cool for at least 45 minutes.
2. Prepare a new lamp. If the projector is mounted on a ceiling, or if the lamp has broken, also ask the dealer to replace the lamp.

In case of replacement by yourself, follow the following procedure.

3. Loosen the screw (marked by arrow) of the lamp cover and then slide and lift the lamp cover to the side to remove it.
4. Loosen the 3 screws (marked by arrow) of the lamp, and slowly pick up the lamp by the handles. Never loosen any other screws.
5. Insert the new lamp, and retighten firmly the 3 screws of the lamp that are loosened in the previous process to lock it in place.
6. While putting the interlocking parts of the lamp cover and the projector together, slide the lamp cover back in place. Then firmly fasten the screw of the lamp cover.
7. Turn the projector on and reset the lamp time using the LAMP TIME item in the OPTION menu.
 - (1) Press the **MENU** button to display a menu.
 - (2) Point at the **ADVANCED MENU** in the menu using the **▼/▲** button, then press the **▶** button.
 - (3) Point at the **OPTION** in the left column of the menu using the **▼/▲** button, then press the **▶** button.
 - (4) Point at the **LAMP TIME** using the **▼/▲** button, then press the **▶** button. A dialog will appear.
 - (5) Press the **▶** button to select "OK" on the dialog. It performs resetting the lamp time.

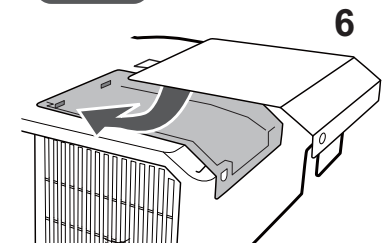
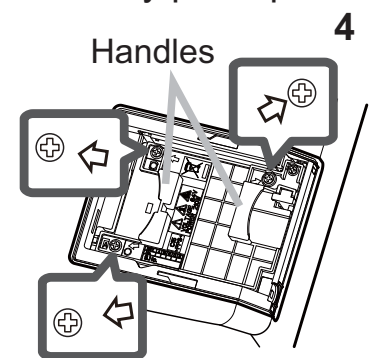
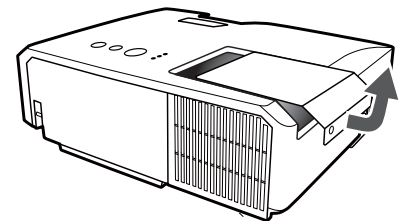
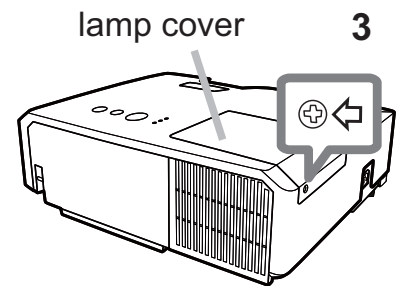

⚠ CAUTION ▶ Do not touch any inner space of the projector, while the lamp is taken out.

NOTE • Please reset the lamp time only when you have replaced the lamp, for a suitable indication about the lamp.

Replacing the lamp (continued)

Lamp warning



HIGH VOLTAGE



HIGH TEMPERATURE



HIGH PRESSURE

⚠ WARNING ► The projector uses a high-pressure mercury glass lamp. The lamp can break with a loud bang, or burn out, if jolted or scratched, handled while hot, or worn over time. Note that each lamp has a different lifetime, and some may burst or burn out soon after you start using them. In addition, if the bulb bursts, it is possible for shards of glass to fly into the lamp housing, and for gas containing mercury and dust containing fine particles of glass to escape from the projector's vent holes.

► **About disposal of a lamp:** This product contains a mercury lamp; do not put it in a trash. Dispose of it in accordance with environmental laws.

- For lamp recycling, go to www.lamprecycle.org (in the US).
- For product disposal, consult your local government agency or www.eiae.org (in the US) or www.epsc.ca (in Canada).

For more information, call your dealer.



Disconnect the plug from the power outlet

- If the lamp should break (it will make a loud bang when it does), unplug the power cord from the outlet, and make sure to request a replacement lamp from your local dealer. Note that shards of glass could damage the projector's internals, or cause injury during handling, so please do not try to clean the projector or replace the lamp yourself.
- If the lamp should break (it will make a loud bang when it does), ventilate the room well, and make sure not to inhale the gas or fine particles that come out from the projector's vent holes, and not to get them into your eyes or mouth.
- Before replacing the lamp, turn the projector off and unplug the power cord, then wait at least 45 minutes for the lamp to cool sufficiently. Handling the lamp while hot can cause burns, as well as damaging the lamp.



- Never unscrew except the appointed (marked by an arrow) screws.
- Do not open the lamp cover while the projector is suspended from a ceiling. This is dangerous, since if the lamp's bulb has broken, the shards will fall out when the cover is opened. In addition, working in high places is dangerous, so ask your local dealer to have the lamp replaced even if the bulb is not broken.
- Do not use the projector with the lamp cover removed. At the lamp replacing, make sure that the screws are screwed in firmly. Loose screws could result in damage or injury.



- Use only the lamp of the specified type. Use of a lamp that does not meet the lamp specifications for this model could cause a fire, damage or shorten the life of this product.
- If the lamp breaks soon after the first time it is used, it is possible that there are electrical problems elsewhere besides the lamp. If this happens, consult your local dealer or a service representative.
- Handle with care: jolting or scratching could cause the lamp bulb to burst during use.
- Using the lamp for long periods of time, could cause it dark, not to light up or to burst. When the pictures appear dark, or when the color tone is poor, please replace the lamp as soon as possible. Do not use old (used) lamps; this is a cause of breakage.

Cleaning and replacing the air filter

The air filter unit of this projector consists of a filter cover, two kinds of filters, and a filter frame. The new double large filters system is expected to function longer. However, please check and clean it periodically to keep ventilation needed for normal operation of the projector.

When the indicators or a message prompts you to clean the air filter, comply with it as soon as possible. Replace the filters when they are damaged or too soiled. To prepare new filters, make contact with your dealer and tell the following type number.

Type number : MU06481 (Filter set)

When you replace the lamp, please replace the air filter. An air filter of specified type will come together with a replacement lamp for this projector.

1. Turn the projector off, and unplug the power cord.
 - Allow the projector to sufficiently cool down.
2. Use a vacuum cleaner on and around the filter cover.
3. While supporting the projector with one hand, use your other hand to pull the filter cover forward in the direction of the arrow.
4. Use a vacuum cleaner for the filter vent of the projector and the outer side of the filter unit.
5. Take the filters out while holding the filter cover.
6. Use a vacuum cleaner on both sides of the filters.
 - When vacuuming up the fine meshed filter, hold it so it will not be sucked in. If the filters are damaged or heavily soiled, replace them with the new ones.
7. Put the filters back into the filter cover.
 - Put the coarse meshed filter into a filter cover first. Then put the fine meshed filter on the coarse meshed one, turning its stitched side up.
8. Put the filter unit back into the projector.

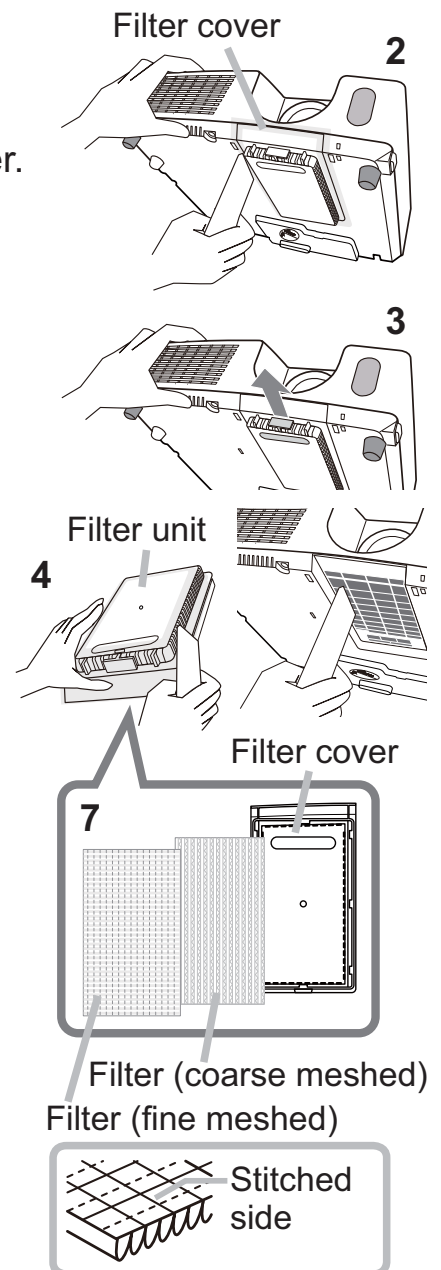

(continued on next page)

Cleaning and replacing the air filter (continued)

9. Turn the projector on and reset the filter time using the FILTER TIME item in the EASY MENU.
 - (1) Press the **MENU** button to display a menu.
 - (2) Point at the FILTER TIME using the ▼/▲ button, then press the ► button. A dialog will appear.
 - (3) Press the ► button to select “OK” on the dialog. It performs resetting the filter time.

⚠ WARNING ► Before taking care of the air filter, make sure the power cable is not plugged in, then allow the projector to cool sufficiently. Taking care of the air filter in a high temperature state of the projector could cause an electric shock, a burn or malfunction to the projector.

► Use only the air filter of the specified type. Do not use the projector without the air filter or the filter cover. It could result in a fire or malfunction to the projector.

► Clean the air filter periodically. If the air filter becomes clogged by dust or the like, internal temperatures rise and could cause a fire, a burn or malfunction to the projector.

NOTE • Please replace the air filter when it is damaged or heavily soiled.

• When you replace the projection lamp, please replace the air filter. An air filter of specified type will come together with a replacement lamp for this projector.

• Please reset the filter time only when you have cleaned or replaced the air filter, for a suitable indication about the air filter.

• The projector may display the message such as “CHECK THE AIR FLOW” or turn off the projector, to prevent the internal heat level rising.

Other care

Inside of the projector

In order to ensure the safe use of your projector, please have it cleaned and inspected by your dealer about once every year.

Caring for the lens

If the lens is flawed, soiled or fogged, it could cause deterioration of display quality. Please take care of the lens, being cautious of handling.

1. Turn the projector off, and unplug the power cord. Allow the projector to cool sufficiently.
2. After making sure that the projector is cool adequately, lightly wipe the lens with a commercially available lens-cleaning wipe. Do not touch the lens directly with your hand.

Caring for the cabinet and remote control

Incorrect care could have adverse influence such as discoloration, peeling paint, etc.

1. Turn the projector off, and unplug the power cord. Allow the projector to cool sufficiently.
2. After making sure that the projector is cool adequately, lightly wipe with gauze or a soft cloth.
If the projector is extremely dirty, dip soft cloth in water or a neutral cleaner diluted in water, and wipe lightly after wringing well. Then, wipe lightly with a soft, dry cloth.

⚠ WARNING ▶ Before caring, make sure the power cord is not plugged in, and then allow the projector to cool sufficiently. The care in a high temperature state of the projector could cause a burn and/or malfunction to the projector.

▶ Never try to care for the inside of the projector personally. Doing is so dangerous.

▶ Avoid wetting the projector or inserting liquids in the projector. It could result in a fire, an electric shock, and/or malfunction to the projector.

- Do not put anything containing water, cleaners or chemicals near the projector.
- Do not use aerosols or sprays.

⚠ CAUTION ▶ Please take right care of the projector according to the following. Incorrect care could cause not only an injury but adverse influence such as discoloration, peeling paint, etc.

▶ Do not use cleaners or chemicals other than those specified in this manual.

▶ Do not polish or wipe with hard objects.

NOTICE ▶ Do not directly touch the lens surface with hands.

Troubleshooting





If an abnormal operation should occur, stop using the projector immediately.

⚠ WARNING ▶ Never use the projector if abnormal operations such as smoke, strange odor, excessive sound, damaged casing or elements or cables, penetration of liquids or foreign matter, etc. should occur. In such cases, immediately disconnect the power plug from the power outlet. After making sure that the smoke or odor has stopped, contact to your dealer or service company.

Otherwise if a problem occurs with the projector, the following checks and measures are recommended before requesting repair.
If this does not resolve the problem, please contact your dealer or service company. They will tell you what warranty condition is applied.

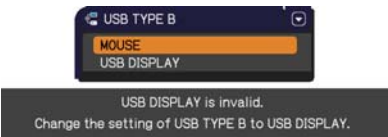

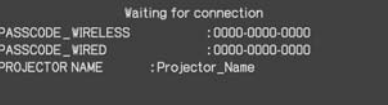

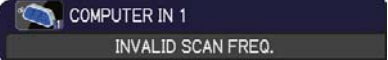
Related messages

When some message appears, check and cope with it according to the following table. Although these messages will be automatically disappeared around several minutes, it will be reappeared every time the power is turned on.

Message	Description
	There is no input signal. Please confirm the signal input connection, and the status of the signal source.
	The USB TYPE B port is selected as the picture input source even if MOUSE is selected for USB TYPE B (p.54). Select USB DISPLAY in the dialog to project the picture input to the USB TYPE B port. In this case, you cannot use the simple mouse and keyboard function. Otherwise select other port for picture input.
	Projector is waiting for an image file. Check the hardware connection, settings on the projector and network-related settings. The computer-Projector network connection might be disconnected. Please re-connect them.
	
	The horizontal or vertical frequency of the input signal is not within the specified range. Please confirm the specs for your projector or the signal source specs.
	An improper signal is input. Please confirm the specs for your projector or the signal source specs.

(continued on next page)

Related messages (continued)

Message	Description
 <p>CHECK THE AIR FLOW</p>	<p>The internal temperature is rising. Please turn the power off, and allow the projector to cool down at least 20 minutes. After having confirmed the following items, please turn the power ON again.</p> <ul style="list-style-type: none"> • Is there blockage of the air passage aperture? • Is the air filter dirty? • Does the peripheral temperature exceed 35°C? • Is the setting for FAN SPEED appropriate? <p>For details on FAN SPEED, refer to FAN SPEED of SERVICE in the OPTION menu ( 57). If the projector is used with a wrong setting, it may cause damage to the projector itself or the parts inside.</p>
 <p>REMINDER 5000 HRS PASSED AFTER THE LAST FILTER CHECK. FILTER MAINTENANCE IS ESSENTIAL. TO REMOVE WARNING MESSAGE, RESET FILTER TIME. SEE MANUAL FOR FURTHER INFO.</p>	<p>A note of precaution when cleaning the air filter. Please immediately turn the power off, and clean or change the air filter referring to the Cleaning and replacing the air filter section of this manual. After you have cleaned or changed the air filter, please be sure to reset the filter timer ( 55, 96).</p>
 <p>NOT AVAILABLE</p>	<p>The button operation is not available.</p>

Regarding the indicator lamps

When operation of the **LAMP**, **TEMP** and **POWER** indicators differs from usual, check and cope with it according to the following table.

POWER indicator	LAMP indicator	TEMP indicator	Description
Lighting In Orange	Turned off	Turned off	The projector is in a standby state. Please refer to the section "Power on/off".
<i>Blinking</i> In Green	Turned off	Turned off	The projector is warming up. Please wait.
Lighting In Green	Turned off	Turned off	The projector is in an on state. Ordinary operations may be performed.
<i>Blinking</i> In Orange	Turned off	Turned off	The projector is cooling down. Please wait.
<i>Blinking</i> In Red	(discre- tionary)	(discre- tionary)	The projector is cooling down. A certain error has been detected. Please wait until POWER indicator finishes blinking, and then perform the proper measure using the item descriptions below.
<i>Blinking</i> In Red or Lighting In Red	Lighting In Red	Turned off	The lamp does not light, and there is a possibility that interior portion has become heated. Please turn the power off, and allow the projector to cool down at least 20 minutes. After the projector has sufficiently cooled down, please make confirmation of the following items, and then turn the power on again. <ul style="list-style-type: none"> • Is there blockage of the air passage aperture? • Is the air filter dirty? • Does the peripheral temperature exceed 35°C? If the same indication is displayed after the remedy, please change the lamp referring to the section Replacing the lamp .
<i>Blinking</i> In Red or Lighting In Red	<i>Blinking</i> In Red	Turned off	The lamp cover has not been properly fixed. Please turn the power off, and allow the projector to cool down at least 45 minutes. After the projector has sufficiently cooled down, please make confirmation of the attachment state of the lamp cover. After performing any needed maintenance, turn the power on again. If the same indication is displayed after the remedy, please contact your dealer or service company.
<i>Blinking</i> In Red or Lighting In Red	Turned off	<i>Blinking</i> In Red	The cooling fan is not operating. Please turn the power off, and allow the projector to cool down at least 20 minutes. After the projector has sufficiently cooled down, please make confirmation that no foreign matter has become caught in the fan, etc., and then turn the power on again. If the same indication is displayed after the remedy, please contact your dealer or service company.

(continued on next page)

Regarding the indicator lamps (continued)

POWER indicator	LAMP indicator	TEMP indicator	Description
Blinking In Red or Lighting In Red	Turned off	Lighting In Red	<p>There is a possibility that the interior portion has become heated.</p> <p>Please turn the power off, and allow the projector to cool down at least 20 minutes. After the projector has sufficiently cooled down, please make confirmation of the following items, and then turn the power on again.</p> <ul style="list-style-type: none"> • Is there blockage of the air passage aperture? • Is the air filter dirty? • Does the peripheral temperature exceed 35°C? • Is the setting for FAN SPEED appropriate? <p>For details on FAN SPEED, refer to FAN SPEED of SERVICE in the OPTION menu (📖57). If the projector is used with a wrong setting, it may cause damage to the projector itself or the parts inside.</p>
Lighting In Green	Simultaneous blinking in Red		<p>It is time to clean the air filter.</p> <p>Please immediately turn the power off, and clean or change the air filter referring to the section Cleaning and replacing the air filter. After cleaning or changing the air filter, please be sure to reset the filter timer. After the remedy, reset the power to ON.</p>
Lighting In Green	Alternative blinking in Red		<p>There is a possibility that the interior portion has become overcooled.</p> <p>Please use the unit within the usage temperature parameters (5°C to 35°C). After the treatment, reset the power to ON.</p>
Blinking In Green for approx. 3 seconds.	Turned off	Turned off	<p>At least 1 Power ON schedule is saved to the projector.</p> <p>Please refer to 3.1.7 Schedule Settings in the Network Guide.</p>

NOTE • When the interior portion has become overheated, for safety purposes, the projector is automatically shut down, and the indicator lamps may also be turned off. In such a case, disconnect the power cord, and wait at least 45 minutes. After the projector has sufficiently cooled down, please make confirmation of the attachment state of the lamp and lamp cover, and then turn the power on again. If the projector is used at an altitude of about 1600 m or higher, set FAN SPEED of the SERVICE item in the OPTION menu to HIGH (📖57). Otherwise, set it to NORMAL.

Resetting all settings

When it is hard to correct some wrong settings, the FACTORY RESET function of SERVICE item in OPTION menu (📖62) can reset all settings (except settings such as LANGUAGE, LAMP TIME, FILTER TIME, FILTER MESSAGE, SECURITY and NETWORK) to the factory default.

Be sure to set FAN SPEED after resetting all the settings (📖57).

Phenomena that may be easy to be mistaken for machine defects

About the phenomenon confused with a machine defect, check and cope with it according to the following table.

Phenomenon	Cases not involving a machine defect	Reference page
Power does not come on.	The electrical power cord is not plugged in. Correctly connect the power cord.	15
	The main power source has been interrupted during operation such as by a power outage (blackout), etc. Please disconnect the power plug from the power outlet, and allow the projector to cool down at least 10 minutes, then turn the power on again.	15
	Either there is no lamp and/or lamp cover, or either of these has not been properly fixed. Please turn the power off and disconnect the power plug from the power outlet, and allow the projector to cool down at least 45 minutes. After the projector has sufficiently cooled down, please make confirmation of the attachment state of the lamp and lamp cover, and then turn the power on again.	94
Neither sounds nor pictures are outputted.	The signal cables are not correctly connected. Correctly connect the connection cables.	10 ~ 14
	Signal source does not correctly work. Correctly set up the signal source device by referring to the manual of the source device.	–
	The input changeover settings are mismatched. Select the input signal, and correct the settings.	20 ~ 22
	The BLANK function for pictures and the MUTE function for sounds are working. AV MUTE may be active. Refer to the item “Sound does not come out” and “No pictures are displayed” on the next page to turn off the MUTE and BLANK functions.	20, 27, 57, 104, 105

(continued on next page)

Phenomena that may be easy to be mistaken for machine defects (continued)

Phenomenon	Cases not involving a machine defect	Reference page
Sound does not come out.	The signal cables are not correctly connected. Correctly connect the audio cables.	10 ~ 14
	The MUTE function is working. Restore the sound pressing MUTE or VOLUME +/- button on the remote control.	20
	The volume is adjusted to an extremely low level. Adjust the volume to a higher level using the menu function or the remote control.	20, 45, 46
	The AUDIO SOURCE/SPEAKER setting is not correct. Correctly set the AUDIO SOURCE/SPEAKER in AUDIO menu.	45
	The mode selected for HDMI AUDIO is not suitable. Check each of the two modes provided and select the suitable one for your HDMI™ audio device.	46
	The Sound button (♪) or checkbox is disabled. If you have selected USB TYPE A , turn the sound on from the Thumbnail menu. If you have selected USB TYPE B , remove the check mark from the Sound checkbox in the Options window of "LiveViewer Lite for USB". If you have selected LAN , remove the check mark from the Sound checkbox in the Option menu of "LiveViewer".	83, 93
No pictures are displayed.	The lens cover is attached. Remove the lens cover.	4, 19
	The signal cables are not correctly connected. Correctly connect the connection cables.	10 ~ 14
	The brightness is adjusted to an extremely low level. Adjust BRIGHTNESS to a higher level using the menu function.	32
	The computer cannot detect the projector as a plug and play monitor. Make sure that the computer can detect a plug and play monitor using another plug and play monitor.	10
	The BLANK screen is displayed. Press BLANK button on the remote control.	27
	The USB TYPE B port is selected as the picture input source even if MOUSE is selected for USB TYPE B. Select USB DISPLAY for USB TYPE B in OPTION menu to project the picture input to the port. Otherwise select other port for picture input.	54

(continued on next page)

Phenomena that may be easy to be mistaken for machine defects (continued)

Phenomenon	Cases not involving a machine defect	Reference page
No pictures are displayed. (continued)	<p>The projector does not recognize the USB storage device inserted into USB TYPE A port. Use the REMOVE USB function first, remove the USB storage device, and then insert it into the port again. Before removing the USB storage device, be sure to use the REMOVE USB function on the thumbnail screen, which appears when the USB TYPE A port is selected as the input source.</p>	12, 83
Video screen display freezes.	<p>The FREEZE function is working. Press FREEZE button to restore the screen to normal.</p>	27
Colors have a faded- out appearance, or Color tone is poor.	<p>Color settings are not correctly adjusted. Perform picture adjustments by changing the COLOR TEMP, COLOR, TINT and/or COLOR SPACE settings, using the menu functions.</p>	33, 38
	<p>COLOR SPACE setting is not suitable. Change the COLOR SPACE setting to AUTO, RGB, SMPTE240, REC709 or REC601.</p>	38
Pictures appear dark.	<p>The brightness and/or contrast are adjusted to an extremely low level. Adjust BRIGHTNESS and/or CONTRAST settings to a higher level using the menu function.</p>	32
	<p>The projector is operating in Eco mode. Set ECO MODE to NORMAL, and set AUTO ECO MODE to OFF, in the SETUP menu.</p>	43
	<p>The lamp is approaching the end of its product lifetime. Replace the lamp.</p>	94 ~ 95
Pictures appear blurry.	<p>Either the focus and/or horizontal phase settings are not properly adjusted. Adjust the focus using the focus ring, and/or H PHASE using the menu function.</p>	23, 37
	<p>The lens is dirty or misty. Clean the lens referring to the section Caring for the lens.</p>	98

(continued on next page)

Phenomena that may be easy to be mistaken for machine defects (continued)

Phenomenon	Cases not involving a machine defect	Reference page
Some kind of image degradation such as flickering or stripes appear on screen.	<p>When the projector is operating in Eco mode, flickering may appear on screen. Set ECO MODE to NORMAL, and set AUTO ECO MODE to OFF, in the SETUP menu.</p>	43
	<p>The OVER SCAN ratio is too big. Adjust OVER SCAN in the IMAGE menu smaller.</p>	35
	<p>Excessive VIDEO NR. Change the setting of VIDEO NR in the INPUT menu.</p>	38
	<p>The FRAME LOCK function cannot work on the current input signal. Set FRAME LOCK in the INPUT menu to OFF.</p>	40
The sound or image is unstable or is output intermittently.	<p>When LAN, USB TYPE A or USB TYPE B port is selected, some parts of the output may be missing due to signal processing delay. Change the signal or use another port.</p>	21, 45
Noise can be heard when the MIC port is connected.	<p>If a microphone is connected to the projector while the USB wireless adapter is connected to the projector, noise from the adapter caused by interference is output from the speakers. Input the signal at line level using a preamp, etc. or remove the USB wireless adapter. Select HIGH in the MIC LEVEL item of the AUDIO menu when you input line level audio signal to the MIC port.</p>	46, 12
The computer connected to the USB TYPE B port of the projector does not start up.	<p>The computer cannot start up in the current hardware configuration. Disconnect the USB cable from the computer, then reconnect it after starting up the computer.</p>	12
RS-232C does not work.	<p>The SAVING function is working. Select NORMAL for STANDBY MODE item in the SETUP menu.</p>	44
	<p>The COMMUNICATION TYPE for the CONTROL port is set to NETWORK BRIDGE. Select OFF for COMMUNICATION TYPE item in the OPTION - SERVICE - COMMUNICATION menu.</p>	59

(continued on next page)

Phenomena that may be easy to be mistaken for machine defects (continued)

Phenomenon	Cases not involving a machine defect	Reference page
NETWORK BRIDGE function does not work	<p>The NETWORK BRIDGE function is turned off. Select NETWORK BRIDGE for COMMUNICATION TYPE item in the OPTION - SERVICE - COMMUNICATION menu.</p>	59
Network does not work	<p>The SAVING function is working. Select NORMAL for STANDBY MODE item in the SETUP menu.</p>	44
	<p>The same network address is set for both wireless and wired LAN. Change the network address setting for wireless or wired LAN.</p>	64, 68
Schedule function does not work	<p>The SAVING function is working. Select NORMAL for STANDBY MODE item in the SETUP menu.</p>	44
	<p>The internal clock has been reset. Once you turn off the projector in the SAVING mode or the AC power, the current date and time setting is reset. Check the DATE AND TIME setting for WIRELESS SETUP or WIRED SETUP in the NETWORK menu.</p>	65, 69
<p>When the projector is connected to wired LAN, it powers off and on as described below.</p> <p>Powers off ←</p> <p>↓</p> <p>POWER indicator blinks in orange a few times</p> <p>↓</p> <p>Goes into standby mode</p>	<p>Disconnect the LAN cable and check that the projector is working properly.</p> <p>If this phenomenon occurs after connecting to the network, there may be a loop between two Ethernet switching hubs within the network, as explained below.</p> <ul style="list-style-type: none"> - There are two or more Ethernet switching hubs in a network. - Two of the hubs are doubly connected by LAN cables. - This double connection forms a loop between the two hubs. <p>Such a loop may have an adverse effect on the projector as well as the other network devices.</p> <p>Check the network connection and remove the loop by disconnecting the LAN cables such that there is only one connecting cable between two hubs.</p>	—

NOTE • Although bright spots or dark spots may appear on the screen, this is a unique characteristic of liquid crystal displays, and it does not constitute or imply a machine defect.

Specifications

Please see the **Specifications** in the **User's Manual (concise)** which is a book.

End User License Agreement for the Projector Software

- Software in the projector consists of the plural number of independent software modules and there exist our copyright or/and third party copyrights for each of such software modules.
- Be sure to read "End User License Agreement for the Projector Software" which is separated document.

Projector

CP-X2514WN/CP-X3014WN/ CP-X4014WN/CP-WX3014WN

User's Manual (detailed) Network Guide

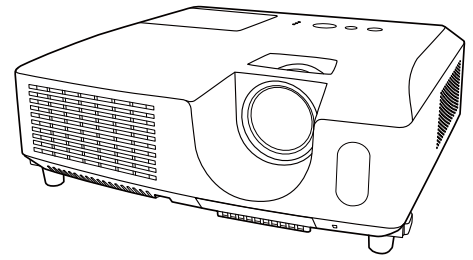

Thank you for purchasing this product.

This manual is intended to explain only the network function. For proper use of this product, please refer to this manual and the other manuals for this product.

⚠ WARNING ▶ Before using this product, be sure to read all manuals for this product. After reading them, store them in a safe place for future reference.

Features

This projector has the network function that brings you the following main features.

- ✓ **Network Presentation** : allows the projector to project computer images transmitted through a network. (📖15)
- ✓ **Web Control** : allows you to monitor and control the projector through a network from a computer. (📖16)
- ✓ **My Image** : allows the projector to store up to four still images and project them. (📖50)
- ✓ **Messenger** : allows the projector to display text sent from a computer through a network. (📖51)
- ✓ **Network Bridge** : allows you to control an external device through the projector from a computer. (📖52)

NOTE • The information in this manual is subject to change without notice.
• The manufacturer assumes no responsibility for any errors that may appear in this manual.
• The reproduction, transfer or copy of all or any part of this document is not permitted without express written consent.

Trademark acknowledgment

- Microsoft®, Internet Explorer®, Windows®, Windows Vista® and Aero® are registered trademarks of Microsoft Corporation in the U.S. and/or other countries.
 - Adobe® and Flash® are registered trademarks of Adobe Systems Incorporated.
 - Pentium® is a registered trademark of Intel Corporation.
 - JavaScript® is a registered trademark of Sun Microsystems, Inc.
 - HDMI, the HDMI logo and High-Definition Multimedia Interface are trademarks or registered trademarks of HDMI Licensing LLC in the United States and other countries.
 - Crestron®, Crestron e-Control®, e-Control®, Crestron RoomView® and RoomView™ are trademarks or registered trademarks of Crestron Electronics, Inc. in the United States and other countries.
 - Trademark PJLink is a trademark applied for trademark rights in Japan, the United States of America and other countries and areas.
- All other trademarks are the properties of their respective owners.

PJLink™



Caution	4
1. Connection to the network	5
1.1 System requirements	5
1.1.1 Required equipment preparation	5
1.1.2 Hardware and software requirement for computer	5
1.2 Quick connection.....	6
1.3 Manual network connection setting - Wired LAN -	7
1.3.1 Equipments connection	7
1.3.2 Network settings	7
1.3.3 “Internet Option” setting	10
1.4 Manual network connection setting - Wireless LAN -	11
1.4.1 Preparation for wireless LAN connection	11
1.4.2 Wireless LAN connection set up	12
2. Network Presentation	15
3. Web Control	16
3.1 Projector Web control	17
3.1.1 Logon	17
3.1.2 Network Information	18
3.1.3 Network Settings	19
3.1.4 Port Settings	22
3.1.5 Mail Settings	24
3.1.6 Alert Settings	25
3.1.7 Schedule Settings	27
3.1.8 Date/Time Settings	30
3.1.9 Security Settings	32
3.1.10 Projector Control	33
3.1.11 Remote Control	39
3.1.12 Projector Status	40
3.1.13 Network Restart	41
3.2 Crestron e-Control®	42
3.2.1 Main window	43
3.2.2 Tools window	45
3.2.3 Info window	47
3.2.4 Help Desk window	48
3.2.5 Emergency Alert	49
4. My Image Function	50
5. Messeger Function	51



6. Network Bridge Function	52
6.1 Connecting devices	52
6.2 Communication setup	53
6.3 Communication port	53
6.4 Transmission method	54
6.4.1 HALF-DUPLEX	54
6.4.2 FULL-DUPLEX	55
7. Other Functions	56
7.1 E-mail Alerts	56
7.2 Projector Management using SNMP	58
7.3 Event Scheduling	59
7.4 Command Control via the Network	62
7.5 Crestron RoomView®	67
8. Troubleshooting	68
9. Specifications	69
10. Warranty and after-sales service	70

Caution

To use the wireless network function of this projector, the designated USB wireless adapter that is sold as an option is required. For precautions according to the standards and laws, refer to the documents that come with the adapter.

[Restriction on plugging and unplugging the USB wireless adapter]

Before you insert or pull out the USB wireless adapter from the projector, turn off the power of the projector and pull out the power cord's plug from the outlet. Do not touch the USB wireless adapter that is connected to the projector while the projector is receiving AC power.

Do not use any extension cable or device when connecting the adapter to the projector.

[Security precautions when using wireless LAN]

It is recommended that security settings, such as SSID and ENCRYPTION, are specified when using wireless LAN communication. If the security settings are not specified, the contents may be intercepted or it may cause unauthorized access to the system. For details on wireless LAN security settings, refer to **3.1 Projector Web Control** or  **NETWORK** menu in the **Operating Guide**.

⚠ CAUTION ▶ The optional IEEE802.11b/g/n USB wireless adapter uses the 2.4GHz radio frequency band. You do not need a radio license to use the adapter, but you should be aware of the following:

• **DO NOT USE NEAR THE FOLLOWING!**

- Microwave ovens
- Industrial, scientific or medical devices
- Designated low power radio stations
- Premises radio stations

Using the USB wireless adapter near the above may cause radio interference, which would result in a decrease in transmission speed or interruption, and even lead to malfunctioning of devices such as pacemakers.

- Depending on the location where the USB wireless adapter is used, radio wave interference may occur, which may result in a decrease in transmission speed or interruption in communication. In particular, please be aware that using the USB wireless adapter at locations where there is reinforced steel, other types of metals or concrete is likely to cause radio wave interference.

• **Available Channels**

The USB wireless adapter uses the 2.4GHz radio frequency band, but depending on the country or region you are in, the channels that you can use might be limited. Please consult your dealer for information on the usable channels.

- Bringing the optional USB wireless adapter out of the country or region you reside in and using it there could lead to a violation of the radio laws of that country or region.

1. Connection to the network

1.1 System requirements

1.1.1 Required equipment preparation

The following equipments are required to connect the projector to your computer through the network.

■ **Common** The projector: 1 unit, Computer : minimum 1 set

■ **Depending on how you want to connect**

1) For the wired connection *1

LAN cable (CAT-5 or greater): 1 piece

2) For the wireless connection *2

- Projector side

IEEE802.11b/g/n USB wireless adapter (option : USB-WL-11N) : 1 unit

- Computer side

IEEE802.11 b/g/n wireless LAN equipment: 1 unit for each *3

*1: The system for using the network function of the projector requires communication environment conforming 100Base-TX or 10Base-T.

*2: An access point is required when the wireless LAN connection is used as Infrastructure mode.

*3: Depending on the type of wireless network device and computer you are using, the projector may not be able to communicate properly with your computer, even if the computer is equipped with a built-in wireless LAN function.

To eliminate communication problems, please use a Wi-Fi certified wireless network device.

1.1.2 Hardware and software requirement for computer

To connect your computer to the projector and use the network function of the projector, your computer needs to meet the following requirements.

✓ **OS:** One of the following.

Windows[®] XP Home Edition /Professional Edition (32 bit version only)

Windows Vista[®] Home Basic /Home Premium /Business /Ultimate /Enterprise (32 bit version only)

Windows[®] 7 Starter /Home Basic /Home Premium /Professional /Ultimate /Enterprise (32 bit version only)

✓ **CPU:** Pentium 4 (2.8 GHz or higher)

✓ **Graphic card:** 16 bit, XGA or higher

* When using the “LiveViewer” it is recommended that the display resolution of your computer is set to 1024 x 768.

✓ **Memory:** 512 MB or higher

✓ **Hard disk space:** 100 MB or higher

✓ **Web browser:** Internet Explorer[®] 6.0 or higher

✓ **CD-ROM drive**

1.1 System requirements (continued)

NOTE • The network communication control is disabled while the projector is in standby mode if the STANDBY MODE item is set to SAVING. Please connect the network communication to the projector after setting the STANDBY MODE to NORMAL. (📖 **SETUP menu** in the **Operating Guide**)

- You can get the latest version of the applications for the network functions of the projector and the latest information for this product from the Hitachi website (<http://www.hitachi-america.us/digitalmedia> or <http://www.hitachidigitalmedia.com>).

1.2 Quick connection

The “LiveViewer” supports very quick and simple connection to the network. When making use of the network function, it is recommended that you install the “LiveViewer” on your computer. For details, refer to the manual for “LiveViewer”.

In case you don’t want to use the “LiveViewer” or you cannot use it by some reason, proceed to the manual setting, the item 1.3 for the wired LAN (📖7) and the item 1.4 for the wireless LAN. (📖11)

1.3 Manual network connection setting - Wired LAN -

This section explains how to set it up manually.

1.3.1 Equipments connection

Connect the projector and computer with a LAN cable.

* Before connecting with an existing network, contact the network administrator.

Next, check the following computer settings.

1.3.2 Network settings

This is the explanation of network connection settings for Windows® 7 and Internet Explorer.

- 1) Log on to Windows® 7 as administrator authority. Administrator authority is the account, which can access to all functions.
- 2) Open "Control Panel" from "Start" menu.
- 3) Open "View network status and tasks" in "Network and Internet".
With the icons in the "Control Panel" window displayed, click "Network and Sharing Center".

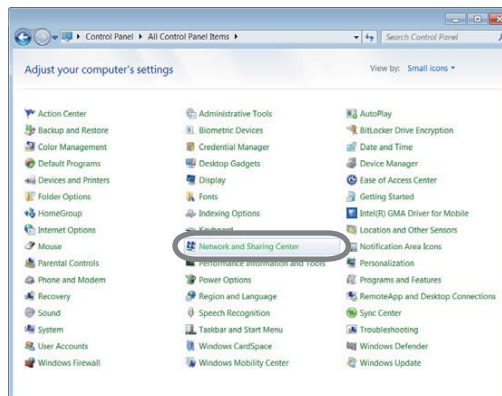

- 4) Click "Change adapter settings" in the menu on the left side of the "Network and Sharing Center" window.

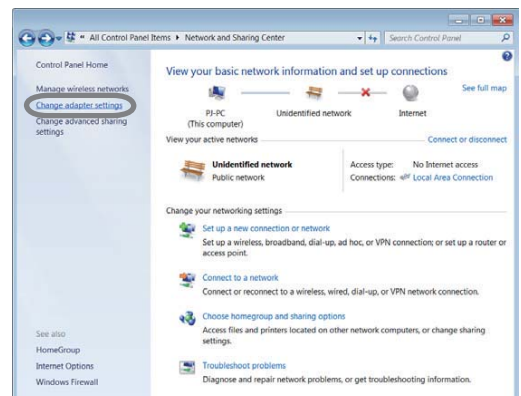

(continued on next page)

1. Connection to the network

1.3 Manual network connection setting - Wired LAN - (continued)

5) Right-click "Local Area Connection" to open the menu, and select "Properties".

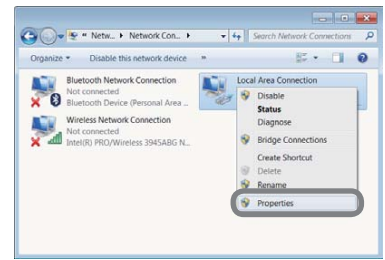

6) Select "Internet Protocol Version 4 (TCP/IPv4)" and click [Properties].

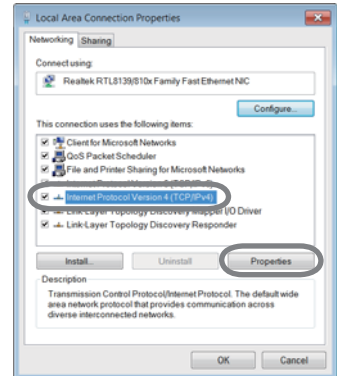

7) Select "Use the following IP address" and configure the IP address, Subnet mask and Default gateway for the computer accordingly. If a DHCP server exists in the network, you can select "Obtain an IP address automatically" and the IP address will be assigned automatically. After setting is complete, click [OK] to close the window.

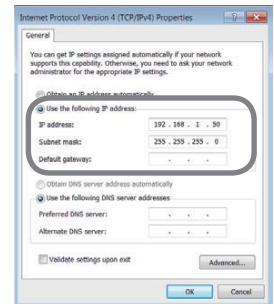

(continued on next page)

1.3 Manual network connection setting - Wired LAN - (continued)

[About IP address]

■ Setting manually

The Network address portion of the IP address setting on your computer must be the same as the setting on the projector. Also, the entire IP address on the computer must not overlap with that of the other devices on the same network, including the projector.

For example

The projector's settings are as follows.

IP address: 192.168.1.254

Subnet mask: 255.255.255.0

(Network address: 192.168.1 in this case)

Therefore, specify the computer's IP address as follows.

IP address: 192.168.1.xxx (xxx shows decimal number.)

Subnet mask: 255.255.255.0

(Network address: 192.168.1 in this case)

Select from 1 to 254 for "xxx" not duplicating with any other equipments.

In this case, since the IP address of the projector is "192.168.1.254", specify a setting between 1 to 253 for the computer.

NOTE • "0.0.0.0" cannot be set to the IP address.

- The projector's IP address can be changed by using the configuration utility via a web browser. (📖21)
- If the projector and the computer exist in the same network (i.e. same network address), you can leave the default gateway field blank.
- When the projector and the computer exist in different networks, the default gateway must be set. Consult to the network administrator in detail.

■ Setting automatically

When a DHCP server exists in the connected network, it is possible to assign an IP address to the projector and computer automatically.

* DHCP is abbreviation for "Dynamic Host Configuration Protocol" and has the function to provide necessary setting for network like IP address from server to client. A server that has DHCP function is called DHCP server.

(continued on next page)

1. Connection to the network

1.3 Manual network connection setting - Wired LAN - (continued)

1.3.3 “Internet Option” setting

1) Click “Internet Options” in “Network and Sharing Center” window to open “Internet Properties” window.

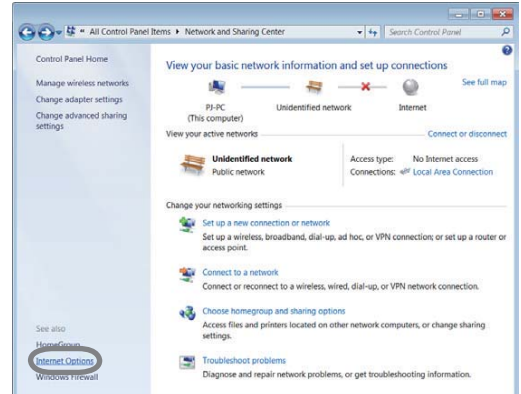

2) Click “Connections” tab and then click [LAN settings] button to open “Local Area Network (LAN) Settings”.

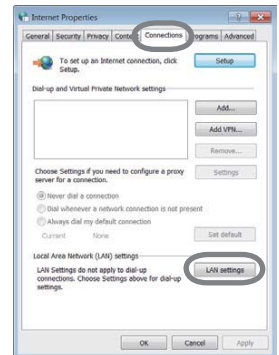

3) Uncheck all boxes in “Local Area Network (LAN) Settings” window.

After setting is complete, click [OK] to close the window.



1.4 Manual network connection setting - Wireless LAN -

Using the designated USB wireless adapter (option) on the projector enables the projector and computer to communicate in both the Ad-Hoc and Infrastructure modes.

This section is intended to explain how to set up wireless LAN connection manually.

1.4.1 Preparation for wireless LAN connection

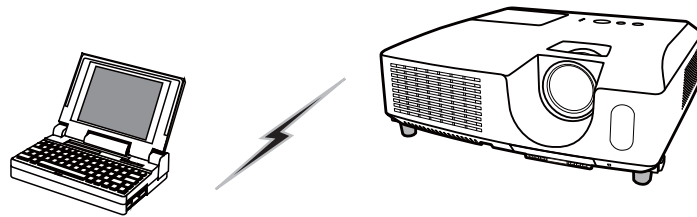

Fig. 1.4.1.a Without an access point communication (Ad-Hoc)

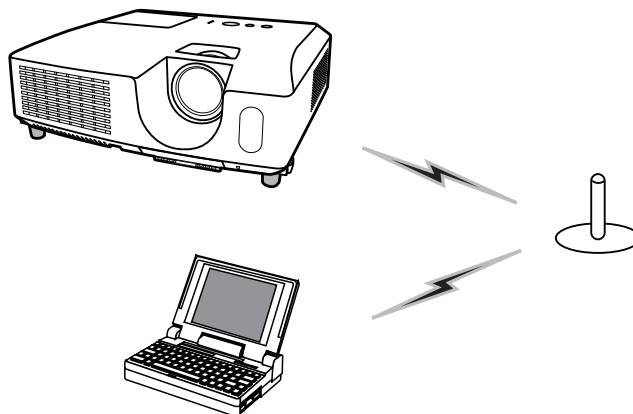

Fig. 1.4.1.b With an access point communication (Infrastructure)

- * Ad-Hoc is one of the wireless LAN communication methods without having access point to communicate.
- * Infrastructure is one of the wireless LAN communication methods with having access point to communicate. If certain quantities of equipments are used, this mode is efficient.
If communicating with existing network, consult to your network administrator.

First, insert the USB wireless adapter into the **USB TYPE A** port. ([📖 Connecting with your devices](#) in the **Operating Guide**)

Then, set up the computer for wireless communication.

When the computer comes with a built-in IEEE802.11b/g/n wireless LAN device, enable it and disable other network connections. If a wireless LAN device is not built into the computer, connect an IEEE802.11b/g/n wireless LAN device and install the device driver. (For details, refer to the user's guide for the computer and wireless LAN device.)

1. Connection to the network

1.4 Manual network connection setting - Wireless LAN - (continued)

1.4.2 Wireless LAN connection set up

Using wireless LAN utility for Windows® 7 standard.
Wireless LAN initial settings for the projector is as follows.

Connection Control	: Ad-Hoc
SSID	: wireless
Channel	: 1
Encryption rating	: None
IP address	: 192.168.10.254

* You can change these settings via a web browser on your computer or from the menu of the projector. Refer to the item **3.1.3 Network Settings** (📖 20) or **NETWORK** menu in the **Operating Guide**.

1) Select "Change adapter settings" from the menu on the left side of the "Network and Sharing Center" window.

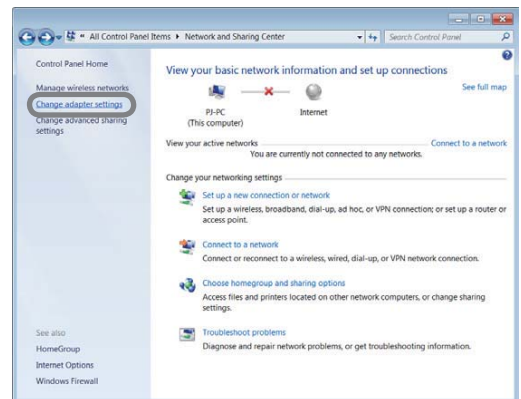

2) Right-click "Wireless Network Connection" to open the menu, and select "Properties".

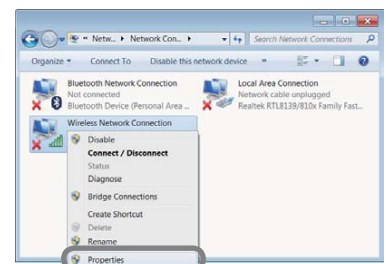

3) Select "Internet Protocol Version 4 (TCP/IPv4)" and click [Properties].

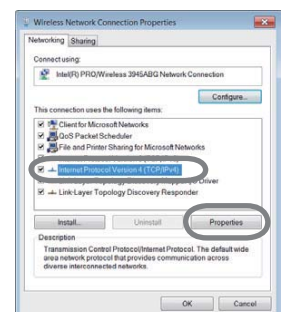

(continued on next page)

1.4 Manual network connection setting - Wireless LAN - (continued)

- 4) Select "Use the following IP address" and configure the IP address, Subnet mask and Default gateway for the computer accordingly.
After setting is complete, click [OK] to close the window.

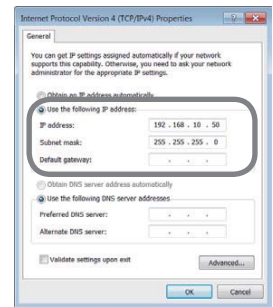

[About IP address]

The Network address portion of the IP address setting on your computer must be the same as the setting on the projector. Also, the entire IP address on the computer must not overlap with that of the other devices on the same network, including the projector.

For example

The projector's settings are as follows.

IP address: 192.168.10.254

Subnet mask: 255.255.255.0

(Network address: 192.168.10 in this case)

Therefore, specify the computer's IP address as follows.

IP address: 192.168.10.xxx (xxx shows decimal number.)

Subnet mask: 255.255.255.0

(Network address: 192.168.10 in this case)

Select from 1 to 254 for "xxx" not duplicating with any other equipments.

In this case, since the IP address of the projector is "192.168.10.254", specify a setting between 1 to 253 for the computer.

NOTE • "0.0.0.0" cannot be set to the IP address.

- The projector's IP address can be changed by using the configuration utility via a web browser. (📖20)
- If the projector and the computer exist in the same network (i.e. same network address), you can leave the default gateway field blank.
- When the projector and the computer exist in different networks, the default gateway must be set. Consult to the network administrator in detail.

(continued on next page)

1. Connection to the network

1.4 Manual network connection setting - Wireless LAN - (continued)

5) Right-click "Wireless Network Connection" to open the menu, and select "Connect / Disconnect".

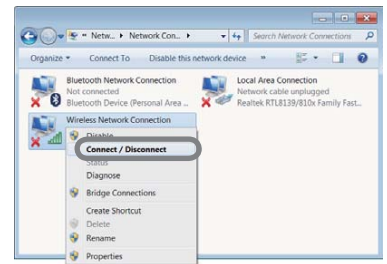

6) From the connectable wireless networks, select the SSID of the projector (set to "wireless" by default), and click [Connect]. If you have enabled encryption, a window asking for input of encryption key will be displayed. Input the preset key.



7) After connection is established, "Connected" will appear to the right of SSID.



2. Network Presentation

The projector can display or play back the computer screen images and audio data that are transmitted through the network. This Network Presentation feature helps you to smoothly make your presentations and conduct conferences.

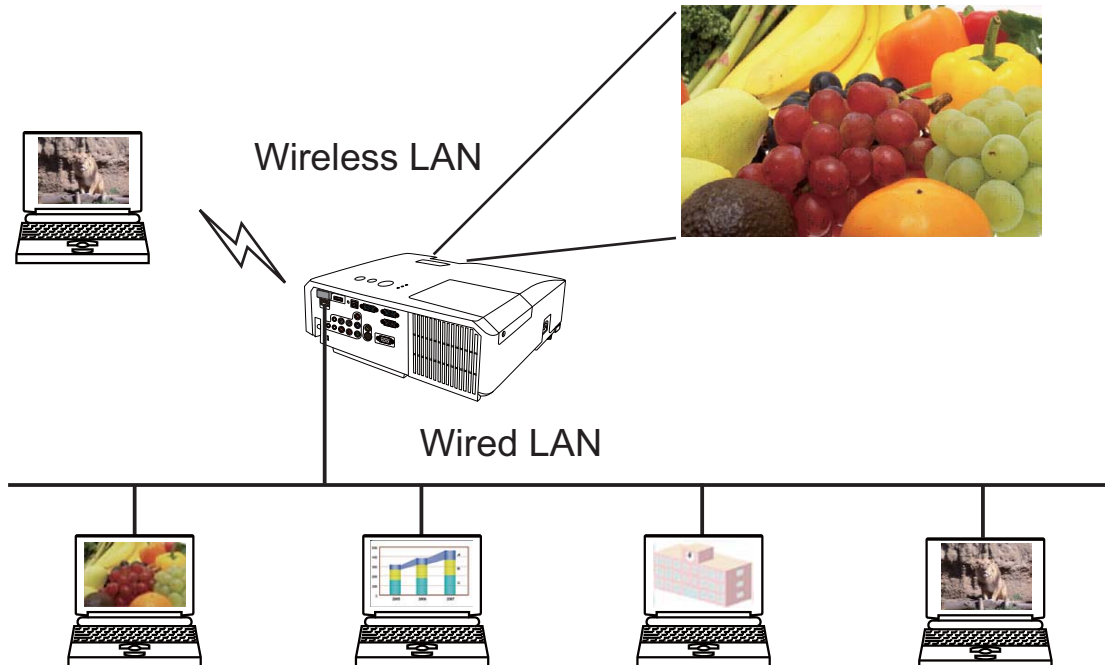

To use Network Presentation, an exclusive application, "LiveViewer", is required. It can be installed from the bundled application CD. You can also download the latest version and relevant information from the Hitachi website (<http://www.hitachi-america.us/digitalmedia> or <http://www.hitachidigitalmedia.com>). For details of Network Presentation and instructions to install the "LiveViewer", refer to the manual for "LiveViewer".

To start the Network Presentation, select the **LAN** port as the input source on the projector and click the Starting Capture button on the "LiveViewer".

3. Web Control

3. Web Control

You can adjust or control the projector via a network from a web browser on a computer that is connected to the same network.

NOTE • Internet Explorer® 6.0 or later is required.

- If JavaScript® is disabled in your web browser configuration, you must enable JavaScript® in order to use the projector web pages properly. See the Help files for your web browser for details on how to enable JavaScript®.
- It is recommended that all web browser updates are installed.
- If data is transferred via wireless and wired LAN at the same time, the projector may not be able to process the data correctly.

Refer to the following for configuring or controlling the projector via a web browser. Make sure that your computer and the projector is connected via network, and then start Web browser.



Enter the projector's IP address into URL input box of the Web browser as the example below, and then press the Enter key or  button.

Example: If the IP address of the projector is set to **192.168.1.10**:

Enter “**http://192.168.1.10**” into the address bar of the web browser and press the Enter key or click  button.

If a correct URL is input, and the projector and your computer are connected to the same network correctly, the selection window as shown on the right will be displayed.

You can choose to use the Projector Web Control or Crestron e-Control® as a tool for controlling the projector. Click one of them.

For more details, refer to **3.1 Projector Web Control** ( 17) or **3.2 Crestron e-Control®** ( 42).

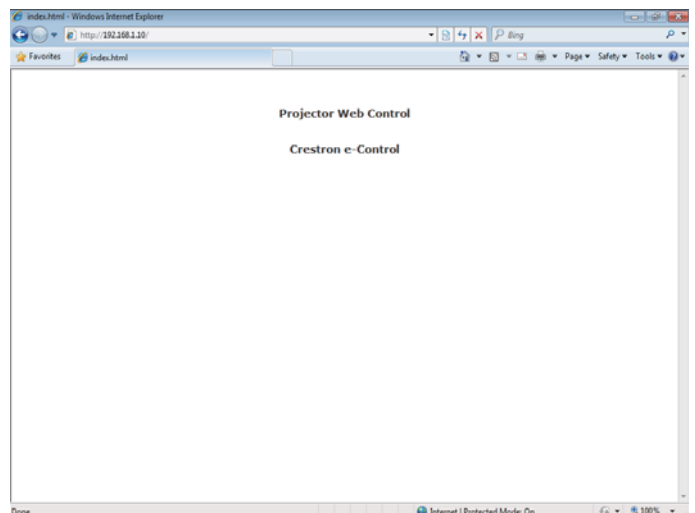

NOTE • If **Crestron e-Control** in the **Network Settings** ( 21) is set to Disable, the selection window above does not appear, but the Logon window of the Projector Web Control is displayed.

- Crestron e-Control® is created using Flash®. You need to install the Adobe® Flash® Player on your computer to use Crestron e-Control®.

3.1 Projector Web Control

3.1.1 Logon

To use the Projector Web Control function, you need to logon with your user name and password.

Below are the factory default settings for user name and password.

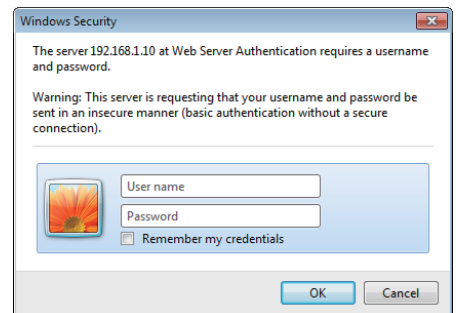

Logon window

User name	Password
Administrator	<blank>

Enter your user name and password, and then click the **[OK]**. If you logon successfully, the screen below will be displayed.

Main menu

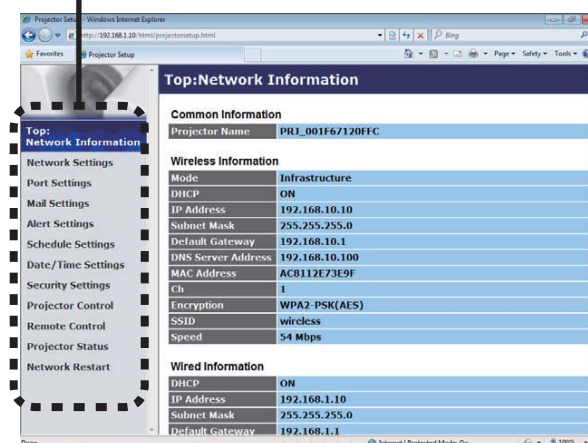

Click the desired operation or configuration item on the main menu.

NOTE • The language used on the Projector Web Control screen is the same as that of the OSD on the projector. If you want to change it, you need to change the OSD language on the projector. (📖 **SCREEN menu** in the **Operating Guide**)

3. Web Control

3.1 Projector Web Control (continued)

3.1.2 Network Information

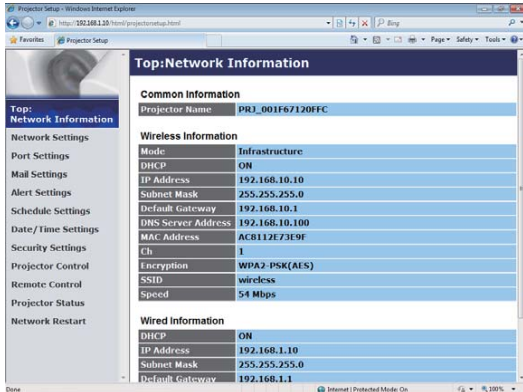

Displays the projector's current network configuration settings.

Item	Description
Common Information	Displays information common to both wireless and wired LAN.
Projector Name	Displays the projector name settings.
Wireless Information	Displays the current settings of wireless LAN.
Mode	Displays the mode of wireless LAN communication.
DHCP	Displays the DHCP setting.
IP Address	Displays the IP address.
Subnet Mask	Displays the subnet mask.
Default Gateway	Displays the default gateway.
DNS Server Address	Displays the DNS server address.
MAC Address	Displays the MAC address.
Ch	Displays the channel used for wireless LAN.
Encryption	Displays the data encryption setting.
SSID	Displays the SSID used by the projector.
Speed	Displays the current wireless LAN transmission speed.
Wired Information	Displays the current wired LAN settings.
DHCP	Displays the DHCP setting.
IP Address	Displays the IP address.
Subnet Mask	Displays the subnet mask.
Default Gateway	Displays the default gateway.
DNS Server Address	Displays the DNS server address.
MAC Address	Displays the MAC address.

3.1 Projector Web Control (continued)

3.1.3 Network Settings

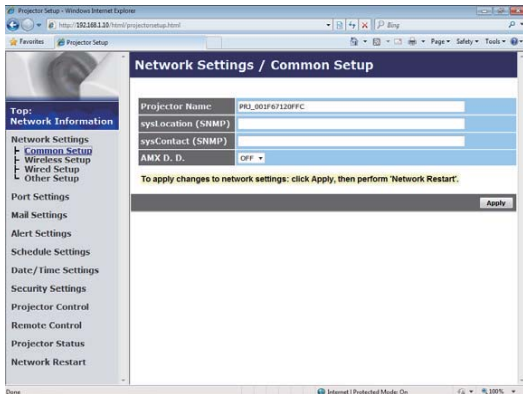

Displays and configures network settings.

Item	Description
Common Setup	Configures the settings common to wireless and wired LAN.
Projector Name	Configures the name of the projector. The length of the Projector Name can be up to 64 alphanumeric characters. Only alphabets, numbers and following symbols can be used. !"#\$%&'()*+,-./:;<=>@[\\]^_`{ }~ and space. Particular projector name is pre-assigned by default.
sysLocation (SNMP)	Configures the location to be referred to when using SNMP. The length of the sysLocation can be up to 255 alphanumeric characters. Only numbers '0-9' and alphabet 'a-z', 'A-Z' can be used.
sysContact (SNMP)	Configures the contact information to be referred to when using SNMP. The length of the sysContact can be up to 255 alphanumeric characters. Only numbers '0-9' and alphabet 'a-z', 'A-Z' can be used.
AMX D.D. (AMX Device Discovery)	Configures the AMX Device Discovery setting to detect the projector from the controllers of AMX connected to the same network. For the details of AMX Device Discovery, visit the AMX web site. <u>URL: http://www.amx.com/</u> (as of Dec. 2010)

(continued on next page)

3.1 Projector Web Control - Network Settings (continued)

Item	Description									
Wireless Setup	Configures the wireless LAN settings.									
Mode	Select "AD-HOC" or "Infrastructure".									
IP Configuration	Configures network settings.									
DHCP ON	Enables DHCP.									
DHCP OFF	Disables DHCP.									
IP Address	Configures the IP address when DHCP is disabled.									
Subnet Mask	Configures the subnet mask when DHCP is disabled.									
Default Gateway	Configures the default gateway when DHCP is disabled.									
DNS Server Address	Configures the DNS server address.									
Ch	Select from "1" to "11" a channel to use in the AD-HOC mode. <div style="border: 1px solid black; padding: 5px;"> <p>NOTE • Depending on the country where you are the channels may vary. In addition, depending on the country or region where you are may be required to use a wireless network card that confirm to the standards in the respective country or region.</p> </div>									
Encryption	Select data encryption method.									
WEP Key	Input the WEP key. Either ASCII characters or hexadecimal numbers can be used during WEP key input. The length of the key is defined as follows according to the WEP and character formats.									
	<table border="1"> <thead> <tr> <th>Encryption</th> <th>ASCII characters</th> <th>HEX numbers</th> </tr> </thead> <tbody> <tr> <td>WEP 64bit</td> <td>5 characters</td> <td>10 characters</td> </tr> <tr> <td>WEP 128bit</td> <td>13 characters</td> <td>26 characters</td> </tr> </tbody> </table>	Encryption	ASCII characters	HEX numbers	WEP 64bit	5 characters	10 characters	WEP 128bit	13 characters	26 characters
Encryption	ASCII characters	HEX numbers								
WEP 64bit	5 characters	10 characters								
WEP 128bit	13 characters	26 characters								
WPA Passphrase	Input WPA Passphrase. Available number of input characters is 8 to 63. Only alphabets, numbers and following symbols can be used. !"#\$%&'()*+,-./:;<=>?@[]^_`{ }~ and space									
SSID	Select an SSID from the list. If you require to set your unique SSID, select [Custom] , then set your own SSID following the rules below. Maximum number of input characters is 32. Only alphabets, numbers and following symbols can be used. !"#\$%&'()*+,-./:;<=>?@[]^_`{ }~ and space.									

(continued on next page)

3.1 Projector Web Control - Network Settings (continued)

Item	Description
Wired Setup	Configures the wired LAN settings.
IP Configuration	Configures network settings.
DHCP ON	Enables DHCP.
DHCP OFF	Disables DHCP.
IP Address	Configures the IP address when DHCP is disabled.
Subnet Mask	Configures the subnet mask when DHCP is disabled.
Default Gateway	Configures the default gateway when DHCP is disabled.
DNS Server Address	Configures the DNS server address.
Other Setup	Configures other network settings.
Crestron e-Control	Set whether to or not to use Crestron e-Control®. If you choose Disable, the Logon window of the Projector Web Control and not the selection window will be displayed at first of the Web Control.

Click the **[Apply]** button to save the settings.

NOTE • The new configuration settings are activated after restarting the network connection. When the configuration settings are changed, you must restart the network connection. You can restart the network connection by clicking **[Network Restart]** on the main menu (41).

- If you connect the projector to an existing network, consult a network administrator before setting server addresses.
- The WEP Key, WPA passphrase and SSID settings will not be set if the invalid characters are used.
- The projector does not allow both wireless and wired LAN to be connected to the same network. Do not set the same network address for both wireless and wired LAN.

3. Web Control

3.1 Projector Web Control (continued)

3.1.4 Port Settings

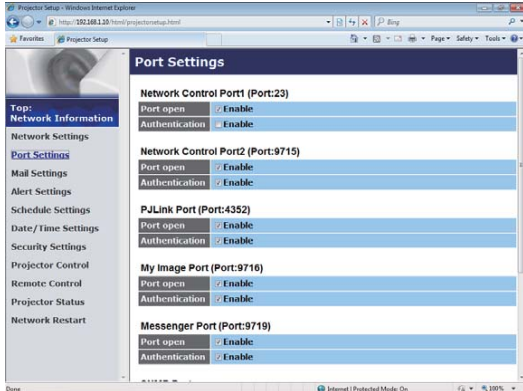

Displays and configures communication port settings.

Item	Description
Network Control Port1 (Port:23)	Configures command control port 1 (Port:23).
Port open	Click the [Enable] check box to use port 23.
Authentication	Click the [Enable] check box when authentication is required for this port.
Network Control Port2 (Port:9715)	Configures command control port 2 (Port:9715).
Port open	Click the [Enable] check box to use port 9715.
Authentication	Click the [Enable] check box when authentication is required for this port.
PJLink™ Port (Port:4352)	Configures the PJLink™ port (Port:4352).
Port open	Click the [Enable] check box to use port 4352.
Authentication	Click the [Enable] check box when authentication is required for this port.
My Image Port (Port:9716)	Configures the My Image Port (Port:9716).
Port open	Click the [Enable] check box to use port 9716.
Authentication	Click the [Enable] check box when authentication is required for this port.
Messenger Port (Port:9719)	Configures the Messenger Port (Port:9719).
Port open	Click the [Enable] check box to use port 9719.
Authentication	Click the [Enable] check box when authentication is required for this port.

(continued on next page)

3.1 Projector Web Control - Port Settings (continued)

Item	Description
SNMP Port	Configures the SNMP port.
Port open	Click the [Enable] check box to use SNMP.
Trap address	Configures the destination of the SNMP Trap in IP format. • The address allows not only IP address but also domain name if the valid DNS server is setup in the Network Settings . The maximum length of host or domain name is up to 255 characters.
Download MIB file	Downloads a MIB file from the projector.
Network Bridge Port	Configures the Bridge port number.
Port Number	Input the port number. Except for 41794, 9715, 9716, 9719, 9720, 5900, 5500, 4352 between 1024 and 65535 can be set up. It is set to 9717 as the default setting.

Click the **[Apply]** button to save the settings.

NOTE • The new configuration settings are activated after restarting the network connection. When the configuration settings are changed, you must restart the network connection. You can restart the network connection by clicking the **[Network Restart]** on the main menu (41).

3. Web Control

3.1 Projector Web Control (continued)

3.1.5 Mail Settings

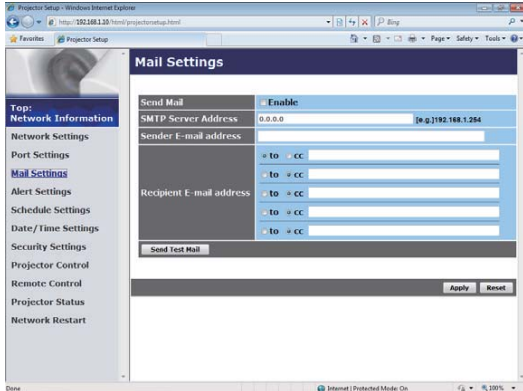

Displays and configures e-mail addressing settings.

Item	Description
Send Mail	Click the [Enable] check box to use the e-mail function. Configure the conditions for sending e-mail under the Alert Settings .
SMTP Server Address	Configures the address of the mail server in IP format. <ul style="list-style-type: none">• The address allows not only IP address but also domain name if the valid DNS server is setup in the Network Settings. The maximum length of host or domain name is up to 255 characters.
Sender E-mail address	Configures the sender e-mail address. The length of the sender e-mail address can be up to 255 alphanumeric characters.
Recipient E-mail address	Configures the e-mail address of up to five recipients. You can also specify the [TO] or [CC] for each address. The length of the recipient e-mail address can be up to 255 alphanumeric characters.

Click the **[Apply]** button to save the settings.

NOTE • You can confirm whether the mail settings work correctly using the **[Send Test Mail]** button. Please enable Send mail setting before clicking the **[Send Test Mail]**.

• If you connect the projector to an existing network, consult a network administrator before setting server addresses.

3.1 Projector Web Control (continued)

3.1.6 Alert Settings

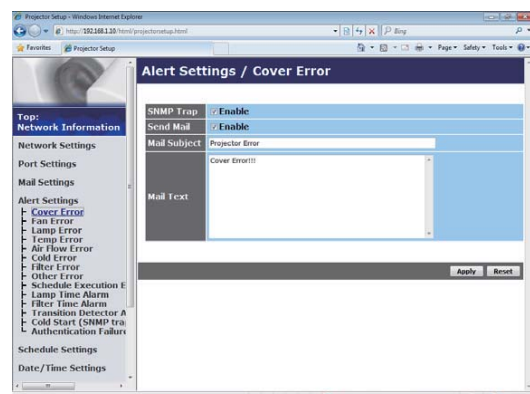

Displays and configures failure & alert settings.

Item	Description
Cover Error	The lamp cover has not been properly fixed.
Fan Error	The cooling fan is not operating.
Lamp Error	The lamp does not light, and there is a possibility that interior portion has become heated.
Temp Error	There is a possibility that the interior portion has become heated.
Air Flow Error	The internal temperature is rising.
Cold Error	There is a possibility that the interior portion has become overcooled.
Filter Error	Filter time over.
Other Error	Other error. If displaying this error, please contact your dealer.
Schedule Execution Error	Schedule Execution error. (📖27)
Lamp Time Alarm	Lamp time over Alarm Time setting.
Filter Time Alarm	Filter time over Alarm Time setting.
Transition Detector Alarm	Transition Detector Alarm. (📖SECURITY menu in the Operating Guide)
Cold Start	When the projector is supplied with the power, it works as below. <ul style="list-style-type: none"> • If the STANDBY MODE is set to the NORMAL:the projector's power status changes from "OFF" to "Standby state". • If the STANDBY MODE is set to the SAVING:the projector's power status changes from "Standby state" to "ON (lamp is turned on)". (📖SETUP menu in the Operating Guide)
Authentication Failure	The SNMP access is detected from the invalid SNMP community.

Refer to 📖Troubleshooting in the **Operating Guide** for further detailed explanation of Error except Other Error and Schedule Execution Error.

3.1 Projector Web Control - Alert Settings (continued)

The Alert Items are shown below.

Item	Description
Alarm Time	Configures the time to alert. (Only Lamp Time Alarm and Filter Time Alarm .)
SNMP Trap	Click the [Enable] check box to enable SNMP Trap alerts.
Send Mail	Click the [Enable] check box to enable e-mail alerts. (Except Cold Start and Authentication Failure .)
Mail Subject	Configures the subject line of the e-mail to be sent. The length of the subject line can be up to 100 alphanumeric characters. (Except Cold Start and Authentication Failure .)
Mail Text	Configures the text of the e-mail to be sent. The length of the text can be up to 1024 alphanumeric characters, but if you are using some of special characters below the length may be shorter. Special characters " ' : & , % \ and space (Except Cold Start and Authentication Failure .)

Click the **[Apply]** button to save the settings.

NOTE • The trigger of **Filter Error** e-mail is depending on the FILTER MESSAGE setting in the SERVICE item of the OPTION menu which defines the period until the filter message is displayed on the projector screen. An e-mail will be sent when the usage time of the filter exceeds the time limit that is set. No notification e-mail will be sent if the FILTER MESSAGE is set to TURN OFF. (📖 **OPTION menu** in the **Operating Guide**)

- **Lamp Time Alarm** is defined as a threshold for e-mail notification (reminder) of the lamp timer. When the lamp hour exceeds this threshold that is configured through the Web page, the e-mail will be sent out.
- **Filter Time Alarm** is defined as a threshold for e-mail notification (reminder) of the filter time. When the filter hour exceeds this threshold that is configured in the Web page, the e-mail will be sent out.

3.1 Projector Web Control (continued)

3.1.7 Schedule Settings

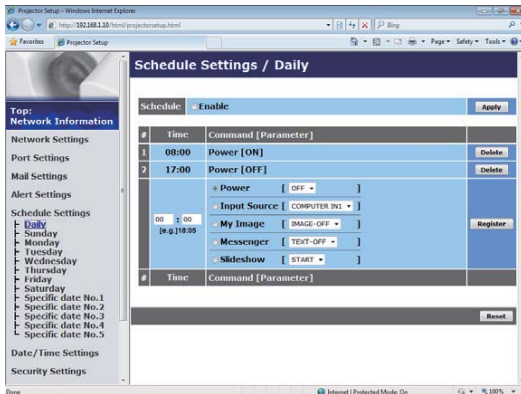

Displays and configures schedule settings.

Item	Description
Daily	Configures the daily schedule.
Sunday	Configures the Sunday schedule.
Monday	Configures the Monday schedule.
Tuesday	Configures the Tuesday schedule.
Wednesday	Configures the Wednesday schedule.
Thursday	Configures the Thursday schedule.
Friday	Configures the Friday schedule.
Saturday	Configures the Saturday schedule.
Specific date No.1	Configures the specific date (No.1) schedule.
Specific date No.2	Configures the specific date (No.2) schedule.
Specific date No.3	Configures the specific date (No.3) schedule.
Specific date No.4	Configures the specific date (No.4) schedule.
Specific date No.5	Configures the specific date (No.5) schedule.

3.1 Projector Web Control - Schedule Settings (continued)

The schedule settings are shown below.

Item	Description
Schedule	Click the [Enable] check box to enable the schedule.
Date (Month/Day)	Configures the month and date. This item appears only when Specific date (No. 1-5) is selected.

Click the **[Apply]** button to save the settings.

The current event settings are displayed on the schedule list. To add additional functions and events, set the following items.

Item	Description
Time	Configures the time to execute commands.
Command [Parameter]	Configures the commands to be executed.
Power	Configures the parameters for power control.
Input Source	Configures the parameters for input switching.
My Image	Configures the parameters for My Image data display. (📖50)
Messenger	Configures the parameters for Messenger data display. (📖51)
Slideshow	Configures the Start/Stop parameters for the Slideshow.

Click the **[Register]** button to add new commands to the schedule list.

Click the **[Delete]** button to delete commands from the schedule list.

Click the **[Reset]** button to delete all commands and reset the schedule settings from the schedule list.

3.1 Projector Web Control - Schedule Settings (continued)

NOTE • After the projector is moved, check the date and time set for the projector before configuring the schedules.

- The internal clock's time may not remain accurate. Using SNTP is recommended to maintain accurate time.
- Events "**My Image**" and "**Messenger**" will not be executed appropriately but result in "schedule execution error" status in case lamp does not light or/and display data are not stored in the projector at the scheduled event execution time.
- Events "**Input Source**" and "**My Image**" will not be executed if security feature is enabled and the projector is locked due to the feature.
- Certain error state in the projector (such as temperature error, lamp error) will prevent the projector from appropriate execution of scheduled functions/events.
- If no USB memory device is inserted to the projector or no image data for display exists at the scheduled event time, a schedule execution error occurs against the scheduled Slideshow event.
- When you start the Slideshow, input source will be automatically switched to the **USB TYPE A** port.
- Image files stored in the root directory of the USB memory device will be displayed for the scheduled Slideshow.
- Please refer to  **Troubleshooting** in the **Operating Guide** in case scheduled functions/events are not executed appropriately as you've set.

3. Web Control

3.1 Projector Web Control (continued)

3.1.8 Date/Time Settings

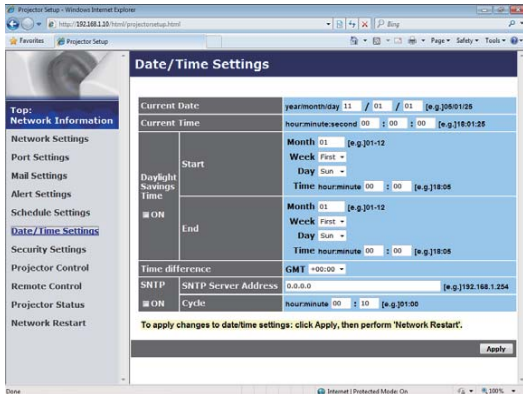

Displays and configures the date and time settings.

Item	Description
Current Date	Configures the current date in year/month/day format.
Current Time	Configures the current time in hour:minute:second format.
Daylight Savings Time	Click the [ON] check box to enable daylight savings time and set the following items.
Start	Configures the date and time daylight savings time begins.
Month	Configures the month daylight savings time begins (1~12).
Week	Configures the week of the month daylight savings time begins (First, 2, 3, 4, Last).
Day	Configures the day of the week daylight savings time begins (Sun, Mon, Tue, Wed, Thu, Fri, Sat).
Time	hour Configures the hour daylight savings time begins (0 ~ 23).
minute	Configures the minute daylight savings time begins (0 ~ 59).
End	Configures the date and time daylight savings time ends.
Month	Configures the month daylight savings time ends (1 ~ 12).
Week	Configures the week of the month daylight savings time ends (First, 2, 3, 4, Last).
Day	Configures the day of the week daylight savings time ends (Sun, Mon, Tue, Wed, Thu, Fri, Sat).
Time	hour Configures the hour daylight savings time ends (0 ~ 23).
minute	Configures the minute daylight savings time ends (0 ~ 59).

(continued on next page)

3.1 Projector Web Control - Date/Time Settings (continued)

Item	Description
Time difference	Configures the time difference. Set the same time difference as the one set on your computer. If unsure, consult your IT manager.
SNTP	Click the [ON] check box to retrieve Date and Time information from the SNTP server and set the following items.
SNTP Server Address	Configures the SNTP server address in IP format. <ul style="list-style-type: none"> The address allows not only IP address but also domain name if the valid DNS server is setup in the Network Settings. The maximum length of host or domain name is up to 255 characters.
Cycle	Configures the interval at which to retrieve Date and Time information from the SNTP server (hour:minute).

Click the **[Apply]** button to save the settings.

NOTE • The new configuration settings are activated after restarting the network connection. When the configuration settings are changed, you must restart the network connection. You can restart the network connection by clicking the **[Network Restart]** on the main menu (📖41).

- If you connect the projector to an existing network, consult a network administrator before setting server addresses.
- Once you turn off the projector in the SAVING mode (📖SETUP menu in the **Operating Guide**) or the AC power, the current date and time setting is reset.
- To enable the SNTP function, the time difference must be set.
- The projector will retrieve Date and Time information from the time server and override time settings when SNTP is enabled.
- The internal clock's time may not remain accurate. Using SNTP is recommended to maintain accurate time.

3. Web Control

3.1 Projector Web Control (continued)

3.1.9 Security Settings

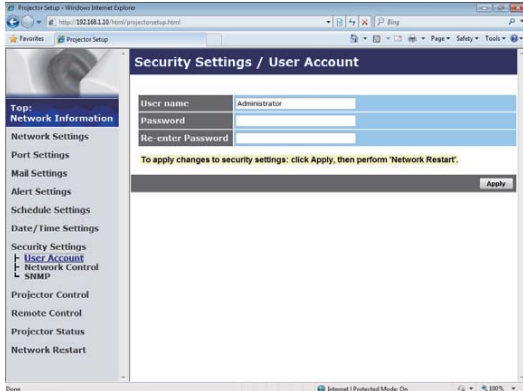

Displays and configures passwords and other security settings.

Item	Description
User Account	Configures the user name and password.
User name	Configures the user name. The length of the text can be up to 32 alphanumeric characters.
Password	Configures the password. The length of the text can be up to 255 alphanumeric characters.
Re-enter Password	Reenter the above password for verification.
Network Control	Configures the Authentication password for Network Control Port1 (Port: 23) , Network Control Port2 (Port: 9715) , PJLink™ Port (Port: 4352) , My Image Port (Port: 9716) , and Messenger Port (Port: 9719) (📖22, 23).
Authentication Password	Configures the Authentication password. The length of the text can be up to 32 alphanumeric characters.
Re-enter Authentication Password	Reenter the above password for verification.
SNMP	Configures the community name if SNMP is used.
Community name	Configures the community name. The length of the text can be up to 64 alphanumeric characters.

Click the **[Apply]** button to save the settings.

NOTE • The new configuration settings are activated after restarting the network connection. When the configuration settings are changed, you must restart the network connection. You can restart the network connection by clicking the **[Network Restart]** on the main menu (📖41).

- Only numbers '0-9' and alphabet 'a-z', 'A-Z' can be used.

3.1 Projector Web Control (continued)

3.1.10 Projector Control

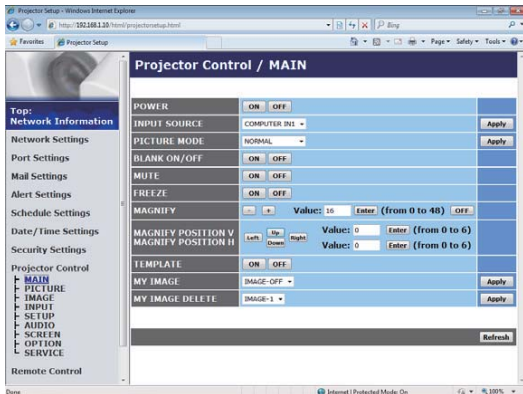

The items shown in the table below can be performed using the Projector Control menu. Select an item with the mouse. Most of the items have a submenu. Refer to the table below for details. Controls the projector.

NOTE • The setting value may not match with the actual value if the user changes the value manually. In that case, please refresh the page by clicking the **[Refresh]** button.

Item	Description
MAIN	
POWER	Turns the power on/off.
INPUT SOURCE	Selects the input source.
PICTURE MODE	Selects the picture mode setting.
BLANK ON/OFF	Turns Blank on/off.
MUTE	Turns Mute on/off.
FREEZE	Turns Freeze on/off.
MAGNIFY	Controls the magnify setting. In some input signal sources, it might stop “Magnify” even though it does not reach to maximum setting value.
MAGNIFY POSITION V	Adjusts the vertical magnify position.
MAGNIFY POSITION H	Adjusts the horizontal magnify position.
TEMPLATE	Turns template on/off.
MY IMAGE	Selects MY IMAGE data.
MY IMAGE DELETE	Deletes MY IMAGE data.

(continued on next page)

3.1 Projector Web Control - Projector Control (continued)

Item	Description
PICTURE	
BRIGHTNESS	Adjusts the brightness setting.
CONTRAST	Adjusts the contrast setting.
GAMMA	Selects the gamma setting.
COLOR TEMP	Selects the color temperature setting.
COLOR	Adjusts the color setting.
TINT	Adjusts the tint setting.
SHARPNESS	Adjusts the sharpness setting.
ACTIVE IRIS	Selects the active iris setting.
MYMEMORY SAVE	Saves the MyMemory data.
MYMEMORY RECALL	Recalls the MyMemory data.
IMAGE	
ASPECT	Selects the aspect setting.
OVER SCAN	Adjusts the over scan setting.
V POSITION	Adjusts the vertical position.
H POSITION	Adjusts the horizontal position.
H PHASE	Adjusts the horizontal phase.
H SIZE	Adjusts the horizontal size.
AUTO ADJUST EXECUTE	Performs the automatic adjustment.
INPUT	
PROGRESSIVE	Selects the progressive setting.
VIDEO NR	Selects the video noise reduction setting.
COLOR SPACE	Selects the color space.
COMPONENT	Selects the COMPONENT port setting.
VIDEO FORMAT - S-VIDEO	Selects the s-video format setting.
VIDEO FORMAT - VIDEO	Selects the video format setting.
HDMI FORMAT	Selects the HDMI™ format setting.
HDMI RANGE	Selects the HDMI™ range setting.
COMPUTER IN - COMPUTER IN1	Selects the COMPUTER IN1 input signal type.
COMPUTER IN - COMPUTER IN2	Selects the COMPUTER IN2 input signal type.
FRAME LOCK - COMPUTER IN1	Turns the FRAME LOCK-COMPUTER IN1 function on/off.
FRAME LOCK - COMPUTER IN2	Turns the FRAME LOCK-COMPUTER IN2 function on/off.
FRAME LOCK - HDMI	Turns the FRAME LOCK-HDMI function on/off.

(continued on next page)

3.1 Projector Web Control - Projector Control (continued)

Item	Description
SETUP	
AUTO KEYSTONE EXECUTE	Performs the automatic keystone distortion setting.
KEYSTONE V	Adjusts the vertical keystone distortion setting.
AUTO ECO MODE	Turns on/off the automatic eco mode function.
ECO MODE	Selects the eco mode.
MIRROR	Selects the mirror status.
STANDBY MODE	Selects the standby mode.
MONITOR OUT - COMPUTER IN1	Assigns the MONITOR OUT when the COMPUTER IN1 input port is selected.
MONITOR OUT - COMPUTER IN2	Assigns the MONITOR OUT when the COMPUTER IN2 input port is selected.
MONITOR OUT - LAN	Assigns the MONITOR OUT when the LAN input port is selected.
MONITOR OUT - USB TYPE A	Assigns the MONITOR OUT when the USB TYPE A input port is selected.
MONITOR OUT - USB TYPE B	Assigns the MONITOR OUT when the USB TYPE B input port is selected.
MONITOR OUT - HDMI	Assigns the MONITOR OUT when the HDMI input port is selected.
MONITOR OUT - COMPONENT	Assigns the MONITOR OUT when the COMPONENT input port is selected.
MONITOR OUT - S-VIDEO	Assigns the MONITOR OUT when the S-VIDEO input port is selected.
MONITOR OUT - VIDEO	Assigns the MONITOR OUT when the VIDEO input port is selected.
MONITOR OUT - STANDBY	Assigns the MONITOR OUT in the standby mode.

(continued on next page)

3.1 Projector Web Control - Projector Control (continued)

Item	Description
AUDIO	
VOLUME	Adjusts the volume setting.
SPEAKER	Turns the built-in speaker on/off.
AUDIO SOURCE - COMPUTER IN1	Assigns the AUDIO SOURCE - COMPUTER IN1 input port.
AUDIO SOURCE - COMPUTER IN2	Assigns the AUDIO SOURCE - COMPUTER IN2 input port.
AUDIO SOURCE - LAN	Assigns the AUDIO SOURCE - LAN input port.
AUDIO SOURCE - USB TYPE A	Assigns the AUDIO SOURCE - USB TYPE A input port.
AUDIO SOURCE - USB TYPE B	Assigns the AUDIO SOURCE - USB TYPE B input port.
AUDIO SOURCE - HDMI	Assigns the AUDIO SOURCE - HDMI input port.
AUDIO SOURCE - COMPONENT	Assigns the AUDIO SOURCE - COMPONENT input port.
AUDIO SOURCE - S-VIDEO	Assigns the AUDIO SOURCE - S-VIDEO input port.
AUDIO SOURCE - VIDEO	Assigns the AUDIO SOURCE - VIDEO input port.
AUDIO SOURCE - STANDBY	Assigns the AUDIO SOURCE in the standby mode.
HDMI AUDIO	Selects the HDMI™ audio setting.
MIC LEVEL	Selects the microphone level.
MIC VOLUME	Adjusts the microphone volume setting.
SCREEN	
LANGUAGE	Selects the language for the OSD.
MENU POSITION V	Adjusts the vertical Menu position.
MENU POSITION H	Adjusts the horizontal Menu position.
BLANK	Selects the Blank mode.
START UP	Selects the start up screen mode.
MyScreen Lock	Turns MyScreen lock function on/off.
MESSAGE	Turns the message function on/off.
TEMPLATE	Selects the template setting.
C.C. - DISPLAY	Selects Closed Caption DISPLAY setting.
C.C. - MODE	Selects Closed Caption MODE setting.
C.C. - CHANNEL	Selects Closed Caption CHANNEL setting.

(continued on next page)

3.1 Projector Web Control - Projector Control (continued)

Item	Description
OPTION	
AUTO SEARCH	Turns the automatic signal search function on/off.
AUTO KEYSTONE	Turns the automatic keystone distortion correction function on/off.
DIRECT POWER ON	Turns the direct power on function on/off.
AUTO POWER OFF	Configures the timer to shut off the projector when no signal is detected.
USB TYPE B	Selects the USB TYPE B setting.
MY BUTTON-1	Assigns the functions for the MY BUTTON-1 button on the included remote control.
MY BUTTON-2	Assigns the functions for the MY BUTTON-2 button on the included remote control.
MY SOURCE	Selects the My Source setting.
REMOTE FREQ. - NORMAL	Turns the remote control signal frequency normal function on/off.
REMOTE FREQ. - HIGH	Turns the remote control signal frequency high function on/off.

(continued on next page)

3. Web Control

3.1 Projector Web Control - Projector Control (continued)

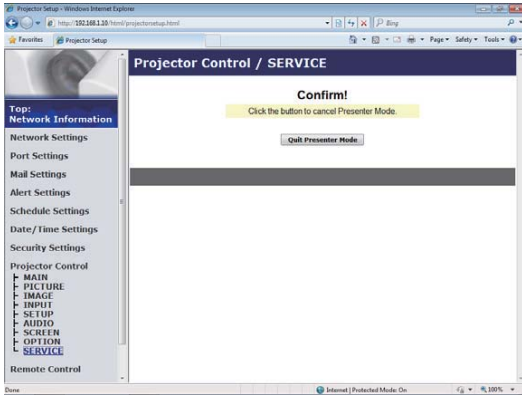

The items shown in the table below can be performed using the **Projector Control** menu. Click the **[Quit Presenter Mode]**.

Item	Description
SERVICE	
Quit Presenter Mode	Quit compulsorily from the Presenter mode.

3.1 Projector Web Control (continued)

3.1.11 Remote Control

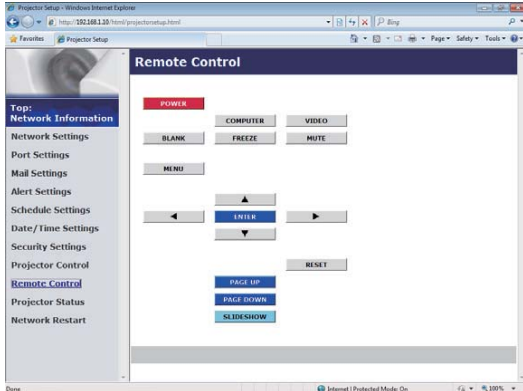

You can use your Web browser to control the projector. The functions on the bundled remote control are assigned to Web Remote Control screen.

- Do not attempt to control the projector with the projector's remote control and via your Web browser at the same time. It may cause some operational errors in the projector.

Item	Description
POWER	Assigned the same operation as STANDBY/ON button.
COMPUTER	Assigned the same operation as COMPUTER button.
VIDEO	Assigned the same operation as VIDEO button.
BLANK	Assigned the same operation as BLANK button.
FREEZE	Assigned the same operation as FREEZE button.
MUTE	Assigned the same operation as MUTE button.
MENU	Assigned the same operation as MENU button.
▲	Assigned the same operation as ▲ button.
▼	Assigned the same operation as ▼ button.
◀	Assigned the same operation as ◀ button.
▶	Assigned the same operation as ▶ button.
ENTER	Assigned the same operation as ENTER button.
RESET	Assigned the same operation as RESET button.
PAGE UP	Assigned the same operation as PAGE UP button.
PAGE DOWN	Assigned the same operation as PAGE DOWN button.
SLIDESHOW	Starts the Slideshow.

- NOTE** • Web Remote Control does not support repeat function that performs an action while holding a button clicked down.
- Since the repeat function is not available, click the button repeatedly as many times as you require.
 - Even if you hold the button clicked down for a while, Web Remote Control sends your request command one time only. Release the button, then click it again.
 - When the [**POWER**] button is pushed, a message window comes up to confirm the operation. To control the power, push [**OK**], otherwise push [**Cancel**].
 - The [**PAGE DOWN**] and [**PAGE UP**] buttons on Web Remote Control cannot be used as mouse emulation function of the projector.

3. Web Control

3.1 Projector Web Control (continued)

3.1.12 Projector Status

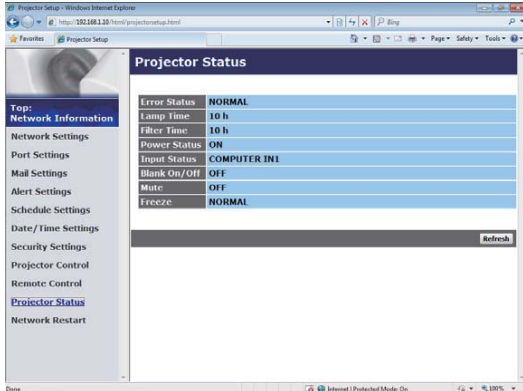

Displays the settings and status of the projector.

Item	Description
Error Status	Displays the current error status
Lamp Time	Displays the usage time for the current lamp.
Filter Time	Displays the usage time for the current filter.
Power Status	Displays the current power status.
Input Status	Displays the current input signal source.
Blank On/Off	Displays the current Blank on/off status.
Mute	Displays the current Mute on/off status.
Freeze	Displays the current Freeze status.

3.1 Projector Web Control (continued)

3.1.13 Network Restart

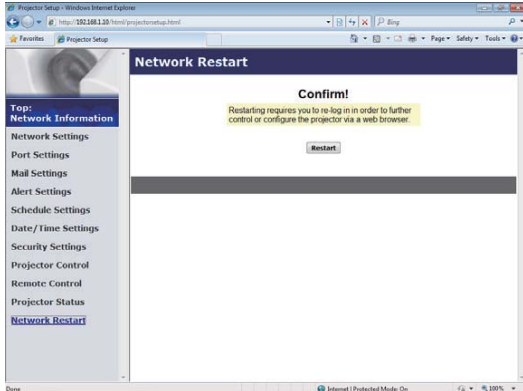

Restarts the projector's network connection.

Item	Description
Restart	Restarts the projector's network connection in order to activate new configuration settings.

NOTE • Restarting requires you to re-log on in order to further control or configure the projector via a web browser. Wait 30 seconds or more after clicking the **[Restart]** button to log on again.

3.2 Crestron e-Control®

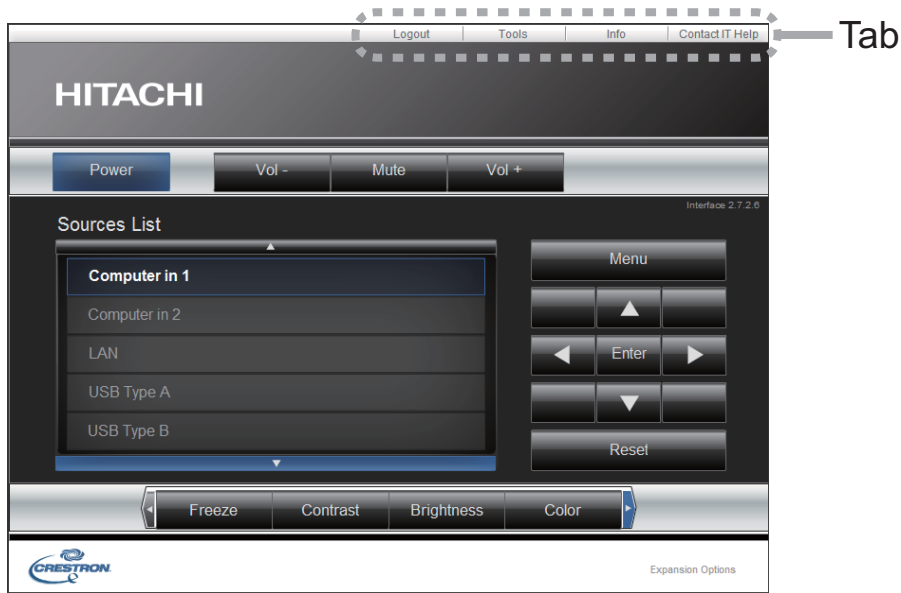

The Main window as shown above is displayed at first. However, if you have enabled User Password on the Tools window (📖46), a dialog prompting you to enter the password as shown on the right will be displayed, and no operation is enabled until you have entered the password. After entering the preset password, the dialog disappears and the Main window will be displayed.

As shown below, you can open a window by clicking the corresponding tab at the top right of the window.

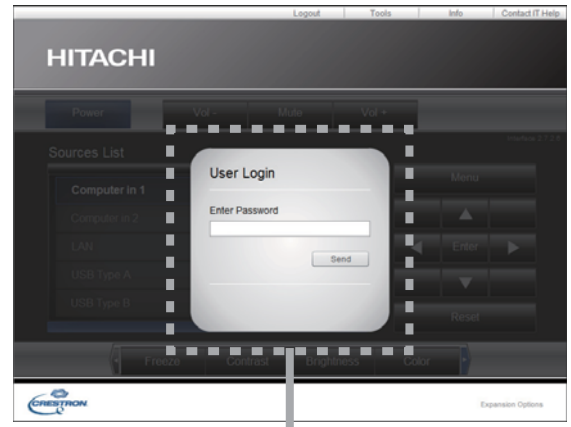

User Password dialog

Tab	Description
Log Out	Logs out from e-Control®. This tab appears only when User Password of the Tools window is enabled.
Tools	Opens Tools window (📖45).
Info	Opens Info window (📖47).
Contact IT Help	Opens Help Desk window (📖48).

NOTE • If **Crestron e-Control** in the **Network Settings** (📖21) is set to **Disable**, Crestron e-Control® cannot be used to operate the projector. Enable Crestron e-Control and close the web browser. Next, restart the web browser, followed by entering the projector's IP address.

- Only English is supported on Crestron e-Control®.

3.2 Crestron e-Control® (continued)

3.2.1 Main window



You can operate the basic controls of the projector on this screen.

NOTE • If the projector is in the standby mode, only the Power button can be operated.

1 Click a button and operate as follows.

Button	Description
Power	Turns the power on/off.
Vol -/ Vol +	Adjusts the volume setting.
Mute	Turns Mute on/off.

2 Sources List

You can click a button to switch the input channel. The cursor will move according to the currently selected input port.

Button	Description
Computer in1	Selects input from COMPUTER IN1 port.
Computer in2	Selects input from COMPUTER IN2 port.
LAN	Selects input from LAN port.
USB Type A	Selects input from USB TYPE A port.
USB Type B	Selects input from USB TYPE B port.
HDMI	Selects input from HDMI port.
Component	Selects input from COMPONENT port.
S-Video	Selects input from S-VIDEO port.
Video	Selects input from VIDEO port.

3.2 Crestron e-Control® - Main window (continued)

3 Click a button and operate as follows. To show the hidden buttons, click the ◀ / ▶ icons at the left and right ends.

Button	Description
Freeze	Turns Freeze on/off.
Contrast	Adjusts the contrast setting.
Brightness	Adjusts the brightness setting.
Color	Adjusts the color setting.
Sharpness	Adjusts the sharpness setting.
Magnify	Controls the magnification setting using the [+] / [-] buttons. Use the [▲] [▼] [◀] [▶] buttons to move to the area you want to magnify.
Auto	Performs the automatic adjustment.
Blank	Turns Blank on/off.

4 Click the button and operate in the same way as the bundled remote control.

Button	Description
Menu	Assigned the same operation as MENU button.
Enter	Assigned the same operation as ENTER button.
Reset	Assigned the same operation as RESET button.
▲	Assigned the same operation as ▲ button.
▼	Assigned the same operation as ▼ button.
◀	Assigned the same operation as ◀ button.
▶	Assigned the same operation as ▶ button.

3.2 Crestron e-Control® (continued)

3.2.2 Tools window

Configures the settings between the projector and Crestron® control system. Click the **[Exit]** button to return to the Main window.

- NOTE** • If two-byte characters are used, the input text or numbers cannot be set correctly.
- All items on this window cannot be left blank.

1 Crestron Control

Configures the settings of Crestron® control system devices.

Item	Description
IP Address	Configures the IP address of the control system.
IP ID	Configures the IP ID of the control system.
Port	Specifies the port number used for communication by the control system. The default setting is 41794.

To apply the settings, click the **[Send]** button.

2 Projector

Configures the network settings of the projector.

Item	Description
Projector Name	Configures the name of the projector. The length of the Projector Name can be up to 64 alphanumeric characters.
Location	Configures the location name of the projector. You can specify a Location name up to 32 alphanumeric characters.
Assigned To:	Configures the user name for the projector. You can specify a user name up to 32 alphanumeric characters.

The usable symbols are space and the following; !"#\$%&'()*+,-./:;<=>?@[^_`{|}~

To apply the settings, click the **[Send]** button.

3.2 Crestron e-Control® - Tools window (continued)

3 Projector (continued)

Configures the network settings of the projector.

Item	Description
DHCP	Enables DHCP.
IP Address	Configures the IP address when DHCP is disabled.
Subnet Mask	Configures the subnet mask when DHCP is disabled.
Default Gateway	Configures the default gateway when DHCP is disabled.
DNS Server	Configures the DNS server address.

To apply the settings, click the **[Send]** button.

4 User Password

Configures the User Password. To prompt the entry of User Password before starting e-Control®, select the checkbox.

Item	Description
New Password	Configures the password. You can specify a password up to 26 alphanumeric characters. The usable symbols are space and the following; !"#\$%&'()*+,-./:;<=>@[\\]^_`{ }~
Confirm	Reenter the above password for verification. If the password is incorrect, an error message is displayed.

To apply the settings, click the **[Send]** button.

5 Admin Password

Configures the Admin Password. To prompt the entry of Admin Password before displaying the Tools window, select the checkbox.

Item	Description
New Password	Configures the password. You can specify a password up to 26 alphanumeric characters. The usable symbols are space and the following; !"#\$%&'()*+,-./:;<=>@[\\]^_`{ }~
Confirm	Reenter the above password for verification. If the password is incorrect, an error message is displayed.

To apply the settings, click the **[Send]** button.

3.2 Crestron e-Control® (continued)

3.2.3 Info window

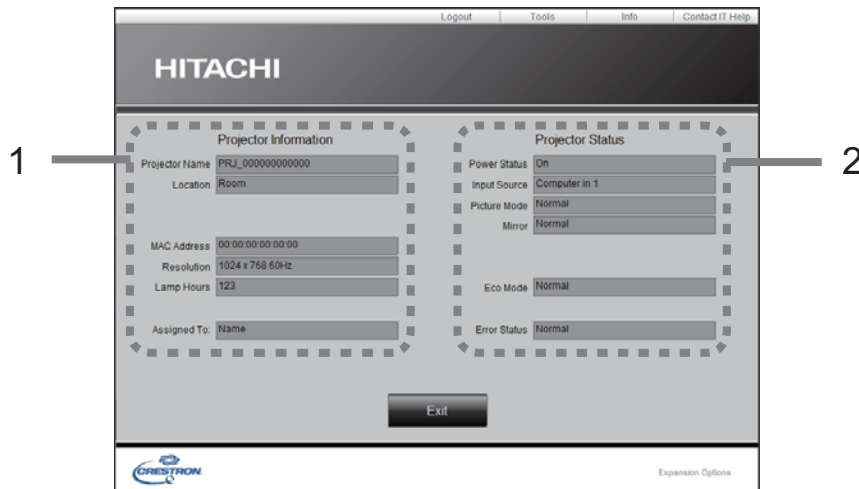

Displays the settings and status of the projector.
Click the **[Exit]** button to return to the Main window.

1 Projector Information

Item	Description
Projector Name	Displays the projector name settings.
Location	Displays the the location name of the projector.
Firmware Virsion	Displays the version of the projector firmware.
MAC address	Displays the wired LAN MAC address of the projector.
Resolution	Displays the resolution and vertical frequency of the signal input selected on the projector.
Lamp Hours	Displays the usage time for the current lamp.
Assigned To:	Displays the user name for the projector.

2 Projector Status

Item	Description
Power Status	Displays the current power status.
Input Source	Displays the current input signal source.
Picture Mode	Displays the current picture mode setting.
Mirror	Displays the current mirror setting.
Eco Mode	Displays the current eco mode setting.
Error Status	Displays the current error status.

NOTE • Projector Name, Location and the user name for Assigned To: may appear truncated if they are too long.

3. Web Control

3.2 Crestron e-Control® (continued)

3.2.4 Help Desk window



Sends/receives messages to/from the administrator for Crestron RoomView® Express.

Button	Description
Send	Sends a message.
	Check the received message.

3.2 Crestron e-Control® (continued)

3.2.5 Emergency Alert

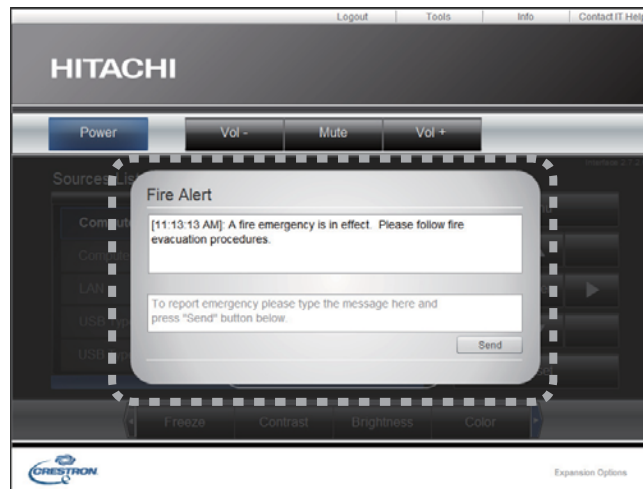

When the administrator for Crestron RoomView® Express sends out an alert message, it will be displayed on the screen.

You can reply to the alert message via a chat format. Input a message in the box below the alert message, and click the **[Send]** button.

NOTE • For details of Emergency Alert, refer to the manual of Crestron RoomView® Express.

- The alert message from Crestron RoomView® is displayed on the screen of the projector in a way similar to the real-time text of the Messenger function (51). If another real-time text is currently being displayed, it will be overwritten by the alert message. However, if the priority of the real-time text is set to high, it will not be overwritten by the alert message, and the latter will not appear on the screen of the projector. For details, refer to the manual for the application of the Messenger.

4. My Image Function

4. My Image Function

The projector can display still images that are transferred via the network.

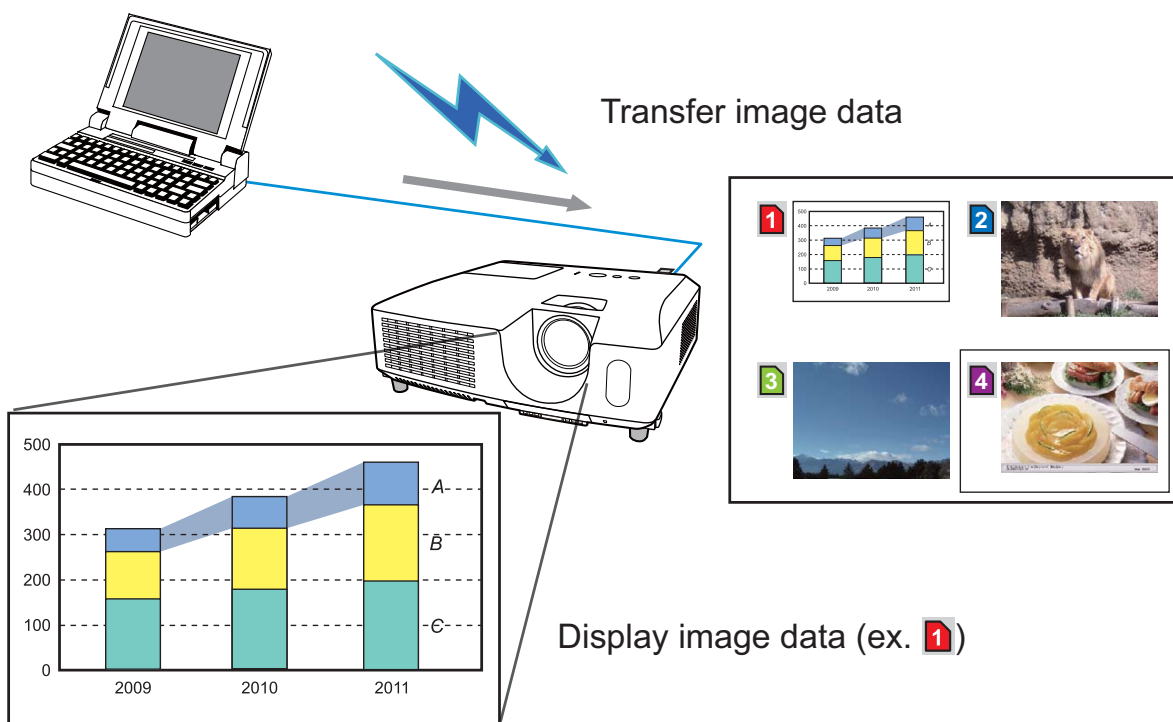

MY IMAGE transmission requires an exclusive application for your computer. Use the application to transfer the image data.

It can be downloaded from the Hitachi web site (<http://www.hitachi-america.us/digitalmedia> or <http://www.hitachidigitalmedia.com>).

For information on the necessary settings and operations for the computer and projector, refer to the manual for the application.

To display the transferred image, select the MY IMAGE item in the NETWORK menu. For more information, please see the description of the MY IMAGE item of the NETWORK menu. (📖 **NETWORK menu** in the **Operating Guide**)

NOTE • It is possible to allocate the image file up to 4 in the maximum.

• Using **MY BUTTON** that registered MY IMAGE can display transferred image. (📖 **OPTION menu** in the **Operating Guide**)

• The image file also can be displayed by using schedule function from the web browser. Refer to item **7.3 Event Scheduling** (📖 **59**) in detail.

• If you display MY IMAGE data on screen while you are using the USB Display function, the application for the USB Display will be closed. To restart the application, exit the MY IMAGE function, and then the software in the projector, LiveViewerLiteUSB.exe, will run again. (📖 **USB Display** in the **Operating Guide**)

• If data is transferred via wireless and wired LAN at the same time, the projector may not be able to process the data correctly.

5. Messenger Function

The projector can display text data transferred via the network on the screen and play back audio data inside the projector.

The text data can be displayed on the screen in two ways that displays the text transferred from the computer on real time, and the other chooses and displays the text data from the ones once stored in the projector.

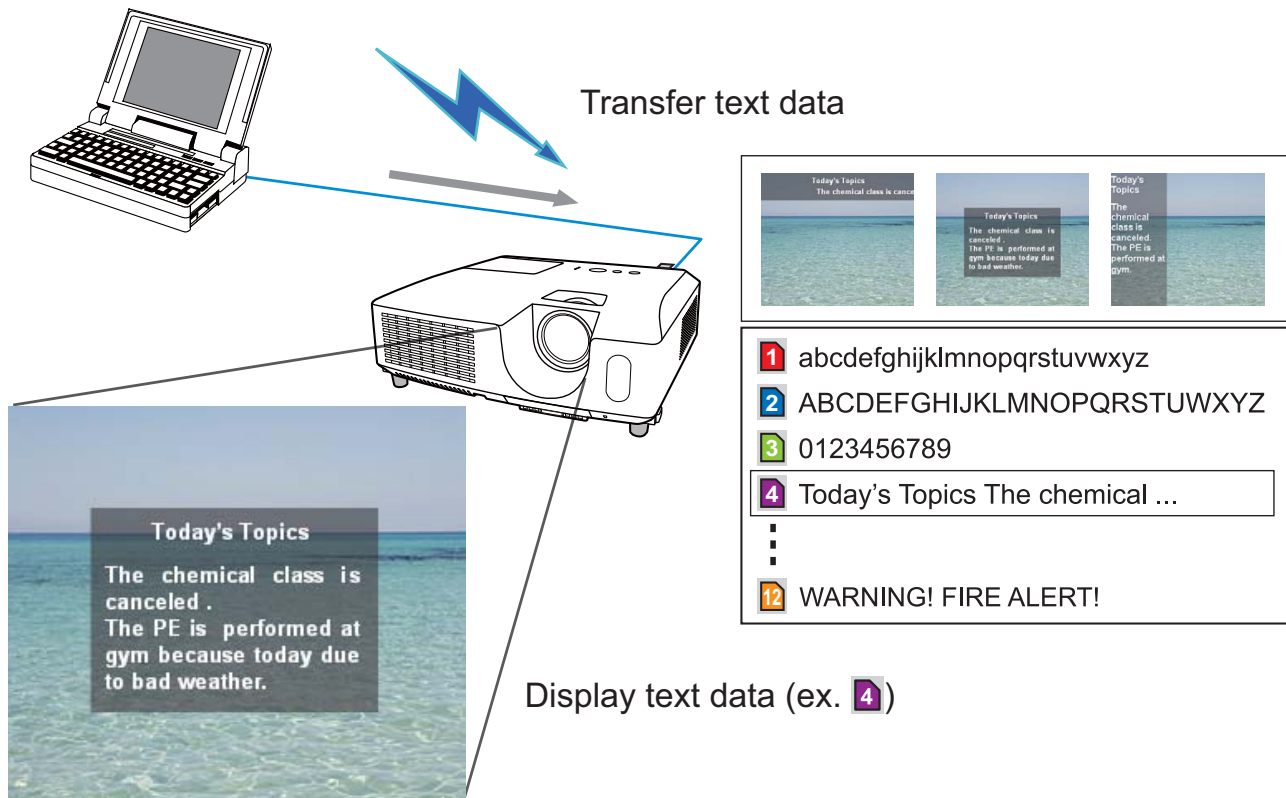

Messenger function requires an exclusive application for your computer. To edit, transfer and display the text data, use the application. You can download it from the Hitachi web site (<http://www.hitachi-america.us/digitalmedia> or <http://www.hitachidigitalmedia.com>). For information on the necessary settings and operations for the computer and projector, refer to the manual for the application.

- NOTE** • It is possible to store the text data up to 12 in the maximum.
- Using **MY BUTTON** that registered MESSANGER can turn the displaying messenger text on/off. (📖 **OPTION menu** in the **Operating Guide**)
 - The text file also can be displayed by using schedule function via the web browser. Refer to item **7.3 Event Scheduling** (📖 **59**) for the detail.
 - If data is transferred via wireless and wired LAN at the same time, the projector may not be able to process the data correctly.

6. Network Bridge Function

This projector is equipped with the NETWORK BRIDGE function to perform mutual conversion of a network protocol and a serial interface.

By making use of the NETWORK BRIDGE function, a computer that is connected to the projector via wireless or wired LAN is able to control an external device via RS-232C communication using the projector as a network terminal.

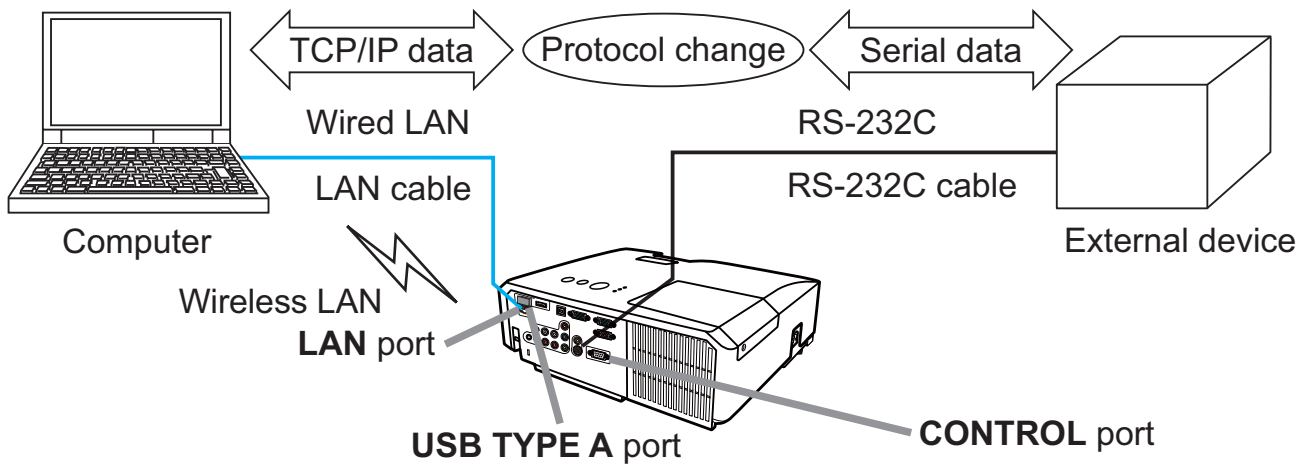

6.1 Connecting devices

- 1) Connect the projector's **LAN** port to the computer's LAN port with a LAN cable, or insert the USB wireless adapter into the **USB TYPE A** port.
- 2) Connect the projector's **CONTROL** port and the device's RS-232C port with an RS-232C cable, for RS-232C communication.

NOTE • Before connecting the devices, read the manuals for the devices to ensure the connection.
For RS-232C connection, check the specifications of each port and use the suitable cable. ([📖](#)Connection to the ports in the **Operating Guide - Technical**)

6.2 Communication setup

To configure the setup of the communication using NETWORK BRIDGE for the projector, use items in the COMMUNICATION menu. Open the menu of the projector and select the OPTION - SERVICE - COMMUNICATION menu.

( **OPTION** menu > **SERVICE** > **COMMUNICATION** in the **Operating Guide**)

- 1) In the COMMUNICATION TYPE menu, select NETWORK BRIDGE (WIRELESS or WIRED depending on the type of connection you use) for the **CONTROL** port.
- 2) Using the SERIAL SETTINGS menu, select the proper baud rate and parity for the **CONTROL** port, according to the specification of the RS-232C port of the connected device.

Item	Condition
BAUD RATE	4800bps/9600bps/19200bps/38400bps
PARITY	NONE/ODD/EVEN
Data length	8 bit (fixed)
Start bit	1 bit (fixed)
Stop bit	1 bit (fixed)

- 3) Using the TRANSMISSION METHOD menu, set up the proper method for the **CONTROL** port according to your use.

NOTE • The OFF is selected for the COMMUNICATION TYPE as the default setting.

- Using the COMMUNICATION menu, set up the communication. Remember that an unsuitable setup could cause malfunction of communication.
- When either one of the NETWORK BRIDGE settings is selected in the COMMUNICATION TYPE menu, RS-232C commands cannot be received from the **CONTROL** port.

6.3 Communication port

For the NETWORK BRIDGE function, send the data from the computer to the projector with using the **Network Bridge Port** that is configured in the **Port Settings** of web browser. ( 23)

NOTE • Except for 41794, 9715, 9716, 9719, 9720, 5900, 5500, 4352 between 1024 and 65535 can be set up as the **Network Bridge Port** number. It is set to 9717 as the default setting.

6.4 Transmission method

The transmission method can be selected from the menus, only when the NETWORK BRIDGE is selected for the COMMUNICATION TYPE.

([📖](#) **OPTION** menu > **SERVICE** > **COMMUNICATION** in the **Operating Guide**)

HALF-DUPLEX ↔ FULL-DUPLEX

6.4.1 HALF-DUPLEX

This method lets the projector make two way communication, but only one direction, either transmitting or receiving data, is allowed at a time.

The method does not allow the projector to receive the data from the computer while waiting for response data from an external device. After the projector receives the response data from an external device or the response limit time is past, the projector can receive the data from the computer.

That means that the projector controls transmitting and receiving the data to synchronize the communication.

To use the HALF-DUPLEX method, set up the RESPONSE LIMIT TIME following the instructions below.

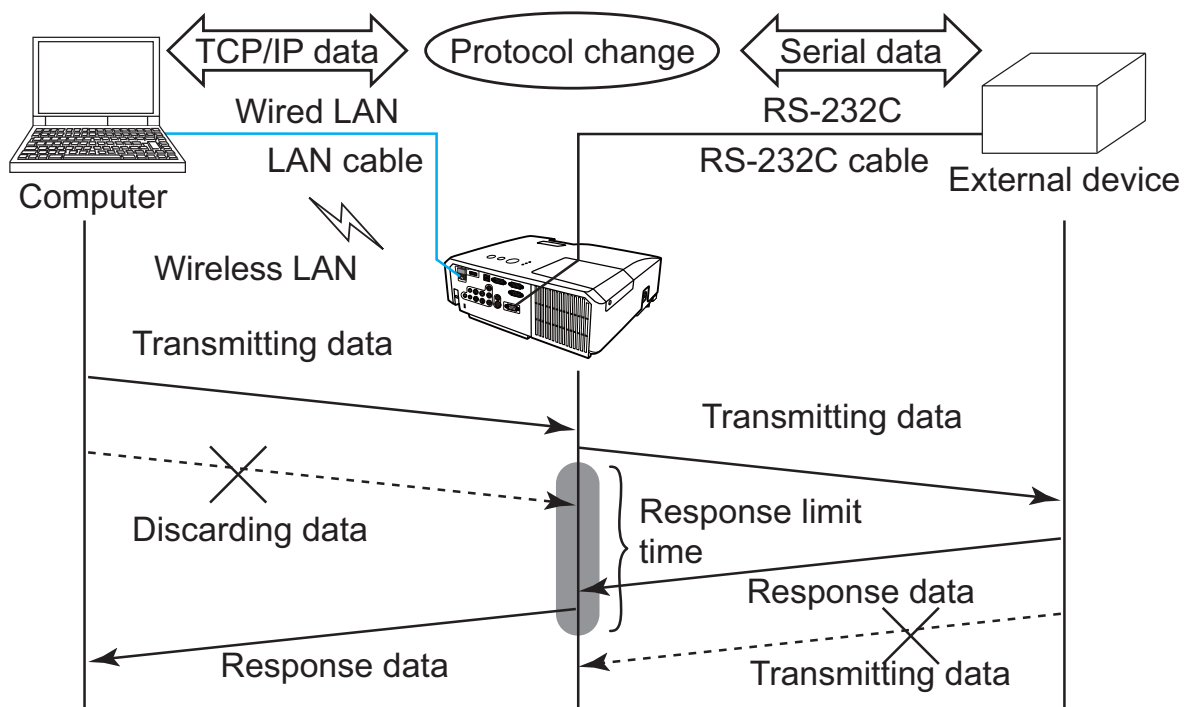

Using the RESPONSE LIMIT TIME menu, set the waiting time for response data from an external device. ([📖](#) **OPTION** menu > **SERVICE** > **COMMUNICATION** in the **Operating Guide**)

OFF ↔ 1s ↔ 2s ↔ 3s (↔ OFF)

6.4 Transmission method (continued)

NOTE • With using the HALF-DUPLEX method, the projector can send out 254 byte data as maximum at once.

- If it is not required to monitor the response data from an external device and the RESPONSE LIMIT TIME is set to OFF, the projector can receive the data from the computer and send it out to an external device continuously. The OFF is selected as the default setting.

6.4.2 FULL-DUPLEX

This method lets the projector make two way communication, transmitting and receiving data at the same time, without monitoring response data from an external device.

With using this method, the computer and an external device will send the data out of synchronization. If it is required to synchronize them, set the computer to make the synchronization.

NOTE • In case that the computer controls to synchronize transmitting and receiving the data, it may not be able to control an external device well depending on the processing status of the projector.

7. Other Functions

7.1 E-mail Alerts

The projector can automatically send an alert message to the specified e-mail addresses when the projector detects a certain condition that is requiring maintenance or detected an error.

NOTE • Up to five e-mail addresses can be specified.
• The projector may be not able to send e-mail if the projector suddenly loses power.

Mail Settings (📖24)

To use the projector's e-mail alert function, please configure the following items through a web browser.

Example: If the IP address of the projector is set to **192.168.1.10**:

- 1) Enter "**http://192.168.1.10/**" into the address bar of the web browser, and select Projector Web Control from the selection window.
- 2) Enter your user name and password, and then click the **[OK]**.
- 3) Click the **[Mail Settings]** and configure each item. Refer to item **3.1.5 Mail Settings (📖24)** for further information.
- 4) Click the **[Apply]** button to save the settings.

NOTE • Click the **[Send Test Mail]** button in the **[Mail Settings]** to confirm that the e-mail settings are correct. The following mail will be delivered to the specified addresses.

Subject line	:Test Mail	<Projector name>
Text	:Send Test Mail	
	Date	<Testing date>
	Time	<Testing time>
	IP Address	<Projector IP address>
	MAC Address	<Projector MAC address>

7.1 E-mail Alerts (continued)

- 5) Click the **[Alert Settings]** on the main menu to configure the E-mail Alerts settings.
- 6) Select and configure each alert item. Refer to item **3.1.6 Alert Setting** ( 25) for further information.
- 7) Click the **[Apply]** button to save the settings.

Failure/Warning e-mails are formatted as follows:

Subject line	:	<Mail title>	<Projector name>
Text	:	<Mail text>	
		Date	<Failure/Warning date>
		Time	<Failure/Warning time>
		IP Address	<Projector IP address>
		MAC Address	<Projector MAC address>

7.2 Projector Management using SNMP

The SNMP (Simple Network Management Protocol) enables to manage the projector information, which is a failure or warning status, from the computer on the network. The SNMP management software will be required on the computer to use this function.

NOTE • It is recommended that SNMP functions be carried out by a network administrator.
• SNMP management software must be installed on the computer to monitor the projector via SNMP.

SNMP Settings (📖22)

Configure the following items via a web browser to use SNMP.

Example: If the IP address of the projector is set to **192.168.1.10**:

- 1) Enter “**http://192.168.1.10/**” into the address bar of the web browser, and select Projector Web Control from the selection window.
- 2) Enter your user name and password, and then click the **[OK]**.
- 3) Click the **[Port Settings]** on the main menu.
- 4) Click the **[Download MIB file]** to download a MIB file.

NOTE • To use the downloaded MIB file, specify the file by your SNMP manager.

- 5) Click the **[Enable]** check box to open the **SNMP Port**. Set the IP address to send the SNMP trap to when a Failure/Warning occurs.

NOTE • A Network Restart is required after the **SNMP Port** configuration settings have been changed. Click the **[Network Restart]** and configure the following items.

- 6) Click the **[Security Settings]** on the main menu.
- 7) Click the **[SNMP]** and set the community name on the screen that is displayed.

NOTE • A Network Restart is required after the **Community name** has been changed. Click the **[Network Restart]** and configure the following items.

- 8) Configure the settings for Trap transmission of Failures/Warnings. Click the **[Alert Settings]** on the main menu and select the Failure/Warning item to be configured.
- 9) Click the **[Enable]** check box to send out the SNMP trap for Failures/Warnings. Clear the **[Enable]** check box when SNMP trap transmission is not required.
- 10) Click the **[Apply]** button to save the settings.

7.3 Event Scheduling

The scheduling function enables to setup scheduled events including power on / power off. It enables to be “self-management” projector.

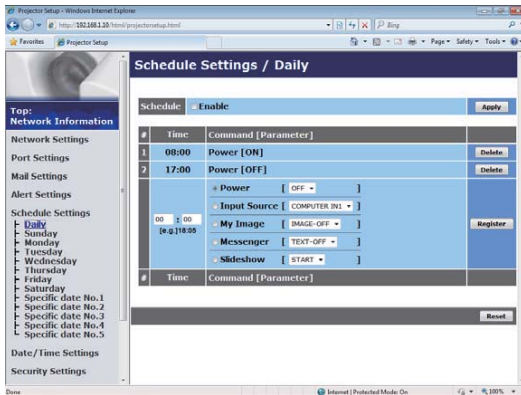

NOTE • You can schedule the following control events: Power, Input Source, My Image, Messenger, Slideshow. (📖28)

- The power on / off event has the lowest priority among the all events that are defined at the same time.
 - There are 3 types of Scheduling, 1) daily 2) weekly 3) specific date. (📖27)
 - The priority for scheduled events is as follows 1) specific date 2) weekly 3) daily.
 - Up to five specific dates are available for scheduled events. Priority is given to those with the lower numbers when more than one event has been scheduled for the same date and time (e.g., ‘Specific date No. 1’ has priority over ‘Specific date No. 2’ and so on).
 - Be sure to set the date and time before enabling scheduled events. (📖29)
- Once you turn off the projector in the SAVING mode (📖SETUP menu in the **Operating Guide**) or the AC power, the current date and time setting is reset.

7.3 Event Scheduling(continued)

Schedule Settings (📖27)

Schedule settings can be configured from a web browser.

Example: If the IP address of the projector is set to **192.168.1.10**:

- 1) Enter “**http://192.168.1.10/**” into the address bar of the web browser, and select Projector Web Control from the selection window.
- 2) Enter your user name and password, and then click the **[OK]**.
- 3) Click the **[Schedule Settings]** on the main menu and select the required schedule item. For example, if you want to perform the command every Sunday, please select the **[Sunday]**.
- 4) Click the **[Enable]** check box to enable scheduling.
- 5) Enter the date (month/day) for specific date scheduling.
- 6) Click the **[Apply]** button to save the settings.
- 7) After configure the time, command and parameters, click the **[Register]** to add the new event.
- 8) Click the **[Delete]** button when you want to delete a schedule.

There are three types of scheduling.

- 1) Daily: Perform the specified operation at a specified time every day.
- 2) Sunday ~ Saturday: Perform the specified operation at the specified time on a specified day of the week.
- 3) Specific date: Perform the specified operation on the specified date and time.

NOTE • In standby mode, the **POWER** indicator will flash green for approx. 3 seconds when at least 1 “Power ON” schedule is saved.

- When the schedule function is used, the power cord must be connected to the projector and the outlet. The schedule function does not work when the breaker in a room is tripped. The power indicator will lights orange or green when the projector is receiving AC power.

7.3 Event Scheduling(continued)

Date/Time Settings (📖30)

The Date/Time setting can be adjusted via a web browser.

Example: If the IP address of the projector is set to **192.168.1.10**:

- 1) Enter “**http://192.168.1.10**” into the address bar of the web browser, and select Projector Web Control from the selection window.
- 2) Enter your user name and password, and then click the **[OK]**.
- 3) Click the **[Date/Time Settings]** on the main menu and configure each item. Refer to item **3.1.8 Date/Time Settings (📖30)** for further information.
- 4) Click the **[Apply]** button to save the settings.

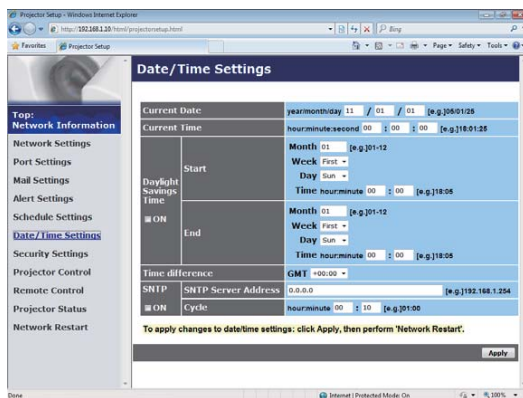

- NOTE** • The internal clock's time may not remain accurate. Using SNTP is recommended to maintain accurate time (📖31).
- Once you turn off the projector in the SAVING mode (📖SETUP menu in the Operating Guide) or the AC power, the current date and time setting is reset.

7.4 Command Control via the Network

You can configure and control the projector via the network using RS-232C commands.

Communication Port

The following two ports are assigned for the command control.

TCP #23 (**Network Control Port1 (Port: 23)**)

TCP #9715 (**Network Control Port2 (Port: 9715)**)

NOTE • Command control is available only via the specified port above.

Command Control Settings (📖22)

Configure the following items from a web browser when command control is used.

Example: If the IP address of the projector is set to **192.168.1.10**:

- 1) Enter “**http://192.168.1.10/**” into the address bar of the web browser, and select Projector Web Control from the selection window.
- 2) Enter your user name and password, and then click the **[OK]**.
- 3) Click the **[Port Settings]** on the main menu.

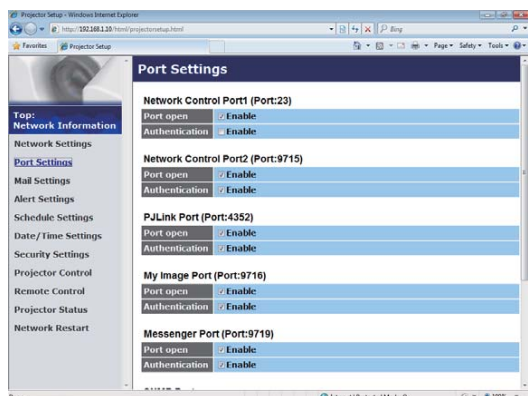

- 4) Click the **[Enable]** check box to open **Network Control Port1 (Port: 23)** to use TCP #23. Click the **[Enable]** check box for the **[Authentication]** setting when authentication is required, otherwise clear the check box.
- 5) Click the **[Enable]** check box to open **Network Control Port2 (Port: 9715)** to use TCP #9715. Click the **[Enable]** check box for the **[Authentication]** setting when authentication is required, otherwise clear the check box.
- 6) Click the **[Apply]** button to save the settings.

7.4 Command Control via the Network (continued)

When the authentication setting is enabled, the following settings are required.
(32)

- 7) Click the **[Security Settings]** on the main menu.
- 8) Click the **[Network Control]** and enter the desired authentication password.
* See NOTE.
- 9) Click the **[Apply]** button to save the settings.

NOTE • The Authentication Password will be the same for **Network Control Port1 (Port: 23)**, **Network Control Port2 (Port: 9715)**, **PJLink™ Port (Port: 4352)**, **My Image Port (Port: 9716)** and **Messenger Port (Port: 9719)**.
• The new configuration settings are activated after restarting the network connection. When the configuration settings are changed, you must restart the network connection. You can restart the network connection by clicking the **[Network Restart]** on the main menu (41).

7.4 Command Control via the Network (continued)

Command Format

Command formats differ among the different communication ports.

- TCP #23

You can use the RS-232C commands without any changes. The reply data format is the same as the RS-232C commands. ([📖RS-232C Communication](#) in the **Operating Guide - Technical**)

However, the following reply will be sent back in the event of authentication failure when authentication is enabled.

<Reply in the event of an authentication error>

Reply	Error code	
0x1F	0x04	0x00

- TCP #9715

Send Data format

The following formatting is added to the header (0 x 02), Data length (0 x 0D), Checksum (1 byte) and Connection ID (1 byte) of the RS-232C commands.

Header	Data length	RS-232Ccommand	Check Sum	Connection ID
0x02	0x0D	13 bytes	1 byte	1 byte

Header → 0x02, Fixed

Data length → RS-232C commands byte length (0x0D, Fixed)

RS-232C command → RS-232C commands that start with 0xBE 0xEF (13 bytes)

Check Sum → This is the value to make zero on the addition of the lower 8 bits from the header to the checksum.

Connection ID → Random value from 0 to 255 (This value is attached to the reply data)

7.4 Command Control via the Network (continued)

Reply Data format

The connection ID (the data is same as the connection ID data on the sending data format) is attached to the RS-232C commands reply data.

<ACK reply>

Reply	Connection ID
0x06	1 byte

<NAK reply>

Reply	Connection ID
0x15	1 byte

<Error reply>

Reply	Error code	Connection ID
0x1C	2 bytes	1 byte

<Data reply>

Reply	Data	Connection ID
0x1D	2 bytes	1 byte

<Projector busy reply>

Reply	Status code	Connection ID
0x1F	2 bytes	1 byte

<Authentication error reply>

Reply	Authentication Error code		Connection ID
0x1F	0x04	0x00	1 byte

7.4 Command Control via the Network (continued)

Automatic Connection Break

The TCP connection will be automatically disconnected after there is no communication for 30 seconds after being established.

Authentication

The projector does not accept commands without authentication success when authentication is enabled. The projector uses a challenge response type authentication with an MD5 (Message Digest 5) algorithm.

When the projector is using a LAN, a random 8 bytes will be returned if authentication is enabled. Bind this received 8 bytes and the Authentication Password and digest this data with the MD5 algorithm and add this in front of the commands to send.

Following is a sample if the Authentication Password is set to “password” and the random 8 bytes are “a572f60c”.

- 1) Connect the projector.
- 2) Receive the random 8 bytes “a572f60c” from the projector.
- 3) Bind the random 8 bytes “a572f60c” and the Authentication Password “password” and it becomes “a572f60cpassword”.
- 4) Digest this bind “a572f60cpassword” with MD5 algorithm.
It will be “e3d97429adffa11bce1f7275813d4bde”.
- 5) Add this “e3d97429adffa11bce1f7275813d4bde” in front of the commands and send the data.
Send “e3d97429adffa11bce1f7275813d4bde”+command.
- 6) When the sending data is correct, the command will be performed and the reply data will be returned. Otherwise, an authentication error will be returned.

NOTE • As for the transmission of the second or subsequent commands, the authentication data can be omitted when the same connection.

7.5 Crestron RoomView®

Crestron RoomView® is a multi-user resource management program provided by Crestron Electronics, Inc. It is an application for managing and controlling the projector and other AV devices collectively.

For details of Crestron RoomView®, refer to the Crestron® website.

URL: <http://www.crestron.com>

The following communication interfaces can be used to manage the entire facility.

1) Crestron RoomView® Express / Crestron RoomView® Server Edition

RoomView™ Express and RoomView™ Server Edition are software provided by Crestron Electronics, Inc. They are used for managing all the AV devices, and are also able to communicate with the help desk as well as send out alert messages.

For details of the software, refer to the following website.

URL: <http://www.crestron.com/getroomview>

2) Crestron e-Control®

Crestron e-Control® is a system controller that can be operated via a web browser (42).

8. Troubleshooting

Problem	Likely Cause	Things to Check	Reference Page Number
Can't communicate	Weak radio signal	<ul style="list-style-type: none"> • Bring the computer and projector closer together. • Radio waves won't go through concrete and metal (steel doors, etc.) 	—
	Cannot communicate due to configure wireless / encryption settings.	If there is a wireless configuration utility loaded on your computer, check its settings. Please refer the manual of your configuration utility.	—
	The computer and/or projector's network settings are not configured correctly.	Check the network configurations of the computer and projector.	—
	The same network address is set for both wireless and wired LAN.	Change the network address setting for wireless or wired LAN.	20, 21
	<Only for wireless LAN> The USB wireless adapter is not inserted into the projector.	Insert the optional USB wireless adapter.	—
	<Only for wireless LAN> There is closely another projector or other that has the same wireless setting.	Try changing of SSID and IP Address.	20
Others - Information from the projector to computer is not correct or completed - The projector does not respond	<p>Communication between the projector and computer is not working well.</p> <p>NETWORK Functions of the projector is not working well.</p>	Try "NETWORK RESTART" in SERVICE menu under the NETWORK menu.	73 in the Operating Guide

9. Specifications

Item	Specifications
Control software	Dedicated computer application and Web browser
Corresponding protocol	TCP/IP, DHCP client and HTTP server
Network	Wireless LAN (IEEE802.11b/g/n) (Ad-Hoc and Infrastructure modes) Wired LAN(100Base-TX/10Base-T)
Security	WEP (64/128bit), WPA-PSK (TKIP/AES), WPA2-PSK (TKIP/AES), SSID
Computer application's system requirements	OS: Windows® XP Home (32bit) Windows® XP Professional (32bit) Windows Vista® Home Basic (32bit) Windows Vista® Home Premium (32bit) Windows Vista® Business (32bit) Windows Vista® Ultimate (32bit) Windows Vista® Enterprise (32bit) Windows® 7 Starter (32bit) Windows® 7 Home Basic (32bit) Windows® 7 Home Premium (32bit) Windows® 7 Professional (32bit) Windows® 7 Ultimate (32bit) Windows® 7 Enterprise (32bit) CPU: Pentium 4 (2.8 GHz or higher) Graphic card: 16 bit, XGA or higher Memory: 512 MB or higher Hard disk space: 100 MB or higher Web browser: Internet Explorer® 6.0 or higher CD-ROM drive
USB wireless adapter	Gemtek USB-Link11n

10. Warranty and after-sales service

10. Warranty and after-sales service

If a problem occurs with the equipment, please read **8. Troubleshooting** ( 68) section first and review all suggested check points. After that, please contact your dealer or service company, if you still have the problem. They will tell you what warranty condition is applied.

Projector

CP-X2514WN/CP-X3014WN/ CP-X4014WN/CP-WX3014WN

User's Manual (detailed) Operating Guide – Technical

Example of computer signal

Resolution (H x V)	H. frequency (kHz)	V. frequency (Hz)	Rating	Signal mode
720 x 400	37.9	85.0	VESA	TEXT
640 x 480	31.5	59.9	VESA	VGA (60Hz)
640 x 480	37.9	72.8	VESA	VGA (72Hz)
640 x 480	37.5	75.0	VESA	VGA (75Hz)
640 x 480	43.3	85.0	VESA	VGA (85Hz)
800 x 600	35.2	56.3	VESA	SVGA (56Hz)
800 x 600	37.9	60.3	VESA	SVGA (60Hz)
800 x 600	48.1	72.2	VESA	SVGA (72Hz)
800 x 600	46.9	75.0	VESA	SVGA (75Hz)
800 x 600	53.7	85.1	VESA	SVGA (85Hz)
832 x 624	49.7	74.5		Mac 16" mode
1024 x 768	48.4	60.0	VESA	XGA (60Hz)
1024 x 768	56.5	70.1	VESA	XGA (70Hz)
1024 x 768	60.0	75.0	VESA	XGA (75Hz)
1024 x 768	68.7	85.0	VESA	XGA (85Hz)
1152 x 864	67.5	75.0	VESA	1152 x 864 (75Hz)
1280 x 768	47.7	60.0	VESA	W-XGA (60Hz)
1280 x 800	49.7	60.0	VESA	1280 x 800 (60Hz)
1280 x 960	60.0	60.0	VESA	1280 x 960 (60Hz)
1280 x 1024	64.0	60.0	VESA	SXGA (60Hz)
1280 x 1024	80.0	75.0	VESA	SXGA (75Hz)
*1 1280 x 1024	91.1	85.0	VESA	SXGA (85Hz)
*2 1400 x 1050	65.2	60.0	VESA	SXGA+ (60Hz)
1440 x 900	55.9	59.9	VESA	WXGA+ (60Hz)
*3 1680 x 1050	65.3	60.0	VESA	WSXGA+ (60Hz)
*1 1600 x 1200	75.0	60.0	VESA	UXGA (60Hz)

*1) Supported except for HDMI input.

*2) Only for CP-X2514WN, CP-X3014WN and CP-X4014WN. *3) Only for CP-WX3014WN.

NOTE • Be sure to check jack type, signal level, timing and resolution before connecting this projector to a computer.

- Some computers may have multiple display screen modes. Use of some of these modes will not be possible with this projector.
- Depending on the input signal, full-size display may not be possible in some cases. Refer to the number of display pixels above.
- Although the projector can display signals with resolution up to UXGA (1600x1200), the signal will be converted to the projector's panel resolution before being displayed. The best display performance will be achieved if the resolutions of the input signal and projector panel are identical.
- Automatic adjustment may not function correctly with some input signals.
- The image may not be displayed correctly when the input sync signal is a composite sync or a sync on G.

Initial set signals

The following signals are used for the initial settings. The signal timing of some computer models may be different. In such case, adjust the items V POSITION and H POSITION in the IMAGE menu.

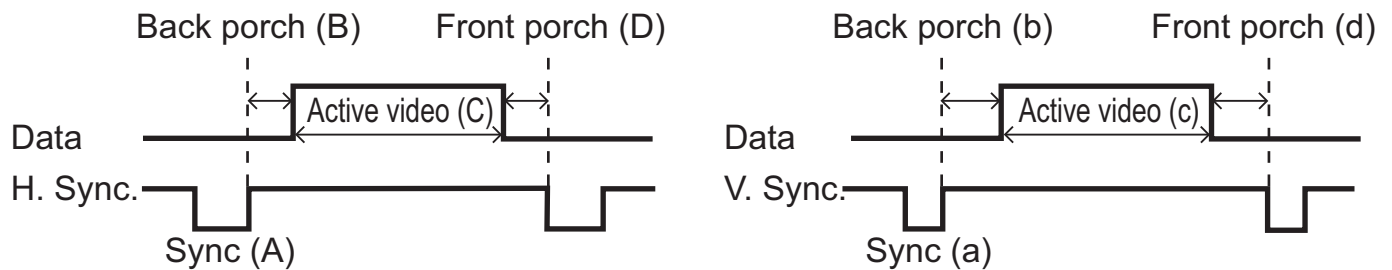

Resolution (H x V)	Horizontal signal timing (μs)				Vertical signal timing (lines)				Signal mode
	(A)	(B)	(C)	(D)	(a)	(b)	(c)	(d)	
720 x 400	2.0	3.0	20.3	1.0	3	42	400	1	TEXT
640 x 480	3.8	1.9	25.4	0.6	2	33	480	10	VGA (60Hz)
640 x 480	1.3	4.1	20.3	0.8	3	28	480	9	VGA (72Hz)
640 x 480	2.0	3.8	20.3	0.5	3	16	480	1	VGA (75Hz)
640 x 480	1.6	2.2	17.8	1.6	3	25	480	1	VGA (85Hz)
800 x 600	2.0	3.6	22.2	0.7	2	22	600	1	SVGA (56Hz)
800 x 600	3.2	2.2	20.0	1.0	4	23	600	1	SVGA (60Hz)
800 x 600	2.4	1.3	16.0	1.1	6	23	600	37	SVGA (72Hz)
800 x 600	1.6	3.2	16.2	0.3	3	21	600	1	SVGA (75Hz)
800 x 600	1.1	2.7	14.2	0.6	3	27	600	1	SVGA (85Hz)
832 x 624	1.1	3.9	14.5	0.6	3	39	624	1	Mac 16" mode
1024 x 768	2.1	2.5	15.8	0.4	6	29	768	3	XGA (60Hz)
1024 x 768	1.8	1.9	13.7	0.3	6	29	768	3	XGA (70Hz)
1024 x 768	1.2	2.2	13.0	0.2	3	28	768	1	XGA (75Hz)
1024 x 768	1.0	2.2	10.8	0.5	3	36	768	1	XGA (85Hz)
1152 x 864	1.2	2.4	10.7	0.6	3	32	864	1	1152 x 864 (75Hz)
1280 x 768	1.7	2.5	16.0	0.8	3	23	768	1	W-XGA (60Hz)
1280 x 800	1.6	2.4	15.3	0.8	3	24	800	1	1280 x 800 (60Hz)
1280 x 960	1.0	2.9	11.9	0.9	3	36	960	1	1280 x 960 (60Hz)
1280 x 1024	1.0	2.3	11.9	0.4	3	38	1024	1	SXGA (60Hz)
1280 x 1024	1.1	1.8	9.5	0.1	3	38	1024	1	SXGA (75Hz)
1280 x 1024	1.0	1.4	8.1	0.4	3	44	1024	1	SXGA (85Hz)
1400 x 1050	1.2	2.0	11.4	0.7	3	33	1050	1	SXGA+ (60Hz)
1440 x 900	1.4	2.2	13.5	0.8	6	25	900	3	WXGA+ (60Hz)
1680 x 1050	1.2	1.9	11.5	0.7	6	30	1050	3	WSXGA+ (60Hz)
1600 x 1200	1.2	1.9	9.9	0.4	3	46	1200	1	UXGA (60Hz)

Connection to the ports

NOTICE ▶ Use the cables with straight plugs, not L-shaped ones, as the input ports of the projector are recessed.
 ▶ Only the signal that is input from the **COMPUTER IN1** or **IN2** can be output from the **MONITOR OUT** port.

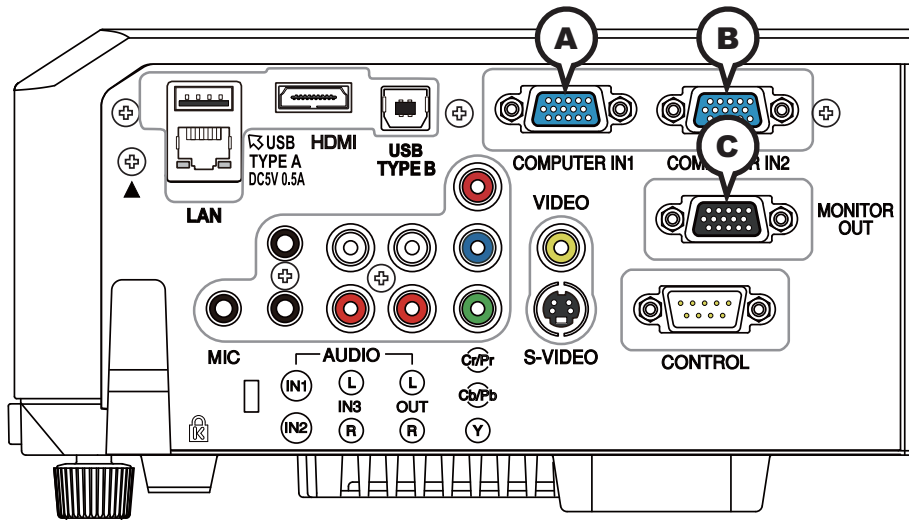

ⒶCOMPUTER IN1, ⒷCOMPUTER IN2, ⒸMONITOR OUT

D-sub 15pin mini shrink jack

<Computer signal>

- Video signal: RGB separate, Analog, 0.7Vp-p, 75Ω terminated (positive)
- H/V. sync. signal: TTL level (positive/negative)
- Composite sync. signal: TTL level

<Component video signal>

- Video signal:
 - Y, Analog, 1.0±0.1Vp-p with composite sync, 75Ω terminated
 - Cb/Pb, Analog, 0.7±0.1Vp-p, 75Ω terminated
 - Cr/Pr, Analog, 0.7±0.1Vp-p 75Ω terminated
- System: 480i@60, 480p@60, 576i@50, 720p@50/60, 1080i@50/60

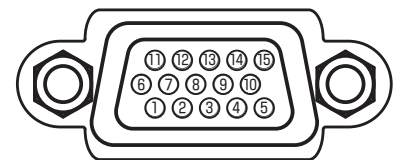

Pin	Signal	Pin	Signal
1	Video Red, Cr/Pr	9	(No connection)
2	Video Green, Y	10	Ground
3	Video Blue, Cb/Pb	11	(No connection)
4	(No connection)	12	Ⓐ: SDA (DDC data), (No connection)
5	Ground		Ⓑ, Ⓒ: (No connection)
6	Ground Red, Ground Cr/Pr	13	H. sync / Composite sync., (No connection)
7	Ground Green, Ground Y	14	V. sync., (No connection)
8	Ground Blue, Ground Cb/Pb	15	Ⓐ: SCL (DDC clock), (No connection)
			Ⓑ, Ⓒ: (No connection)

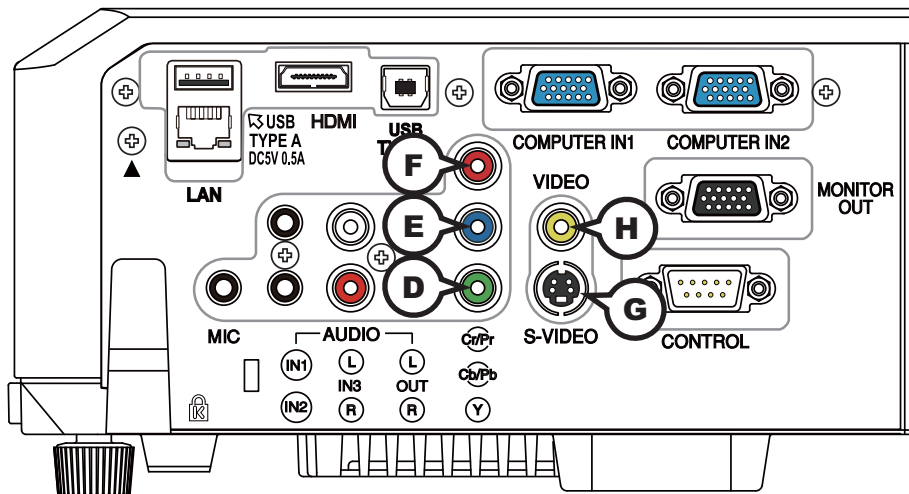

COMPONENT **D**Y, **E**Cb/Pb **F**Cr/Pr

RCA jack x3

- System: 480i@60, 480p@60, 576i@50, 720p@50/60, 1080i@50/60, 1080p@50/60

Port	Signal
Y	Component video Y, 1.0±0.1Vp-p with composite sync, 75Ω terminator
Cb/Pb	Component video Cb/Pb, 0.7±0.1Vp-p, 75Ω terminator
Cr/Pr	Component video Cr/Pr, 0.7±0.1Vp-p, 75Ω terminator

GS-VIDEO

Mini DIN 4pin jack

- System: NTSC, PAL, SECAM, PAL-M, PAL-N, NTSC4.43, PAL(60Hz)



Pin	Signal
1	Color signal 0.286Vp-p (NTSC, burst), 75Ω terminator Color signal 0.300Vp-p (PAL/SECAM, burst) 75Ω terminator
2	Brightness signal, 1.0Vp-p, 75Ω terminator
3	Ground
4	Ground

HVIDEO

RCA jack

- System: NTSC, PAL, SECAM, PAL-M, PAL-N, NTSC4.43, PAL(60Hz)
- 1.0±0.1Vp-p, 75Ω terminator

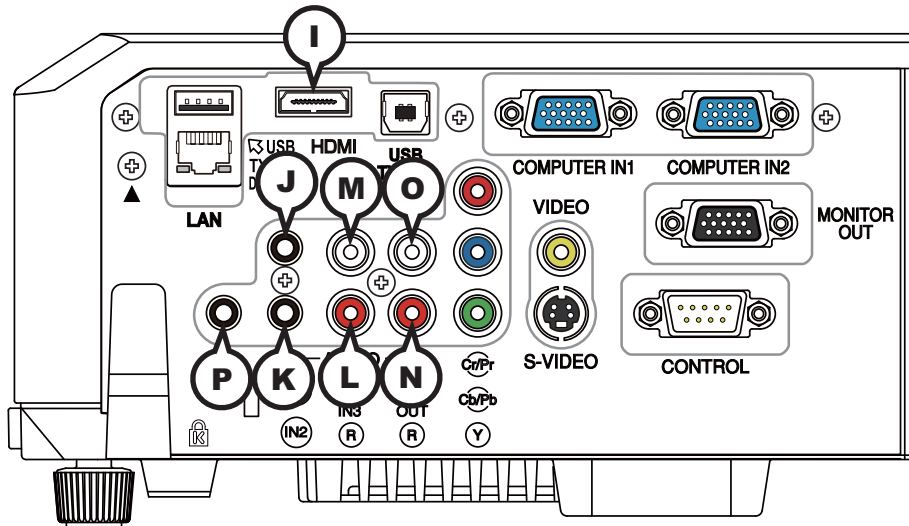

I HDMI

- Type :Digital audio/video connector
- Audio signal : Linear PCM (Sampling rate; 32/44.1/48 kHz)

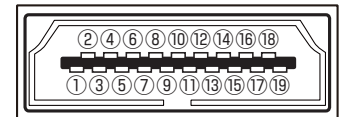

Pin	Signal	Pin	Signal	Pin	Signal
1	T.M.D.S. Data2 +	8	T.M.D.S. Data0 Shield	15	SCL
2	T.M.D.S. Data2 Shield	9	T.M.D.S. Data0 -	16	SDA
3	T.M.D.S. Data2 -	10	T.M.D.S. Clock +	17	DDC/CEC Ground
4	T.M.D.S. Data1 +	11	T.M.D.S. Clock Shield	18	+5V Power
5	T.M.D.S. Data1 Shield	12	T.M.D.S. Clock -	19	Hot Plug Detect
6	T.M.D.S. Data1 -	13	CEC		
7	T.M.D.S. Data0 +	14	Reserved(N.C. on device)		

J AUDIO IN1, K AUDIO IN2

- Ø3.5 stereo mini jack
- 200 mVrms 47kΩ terminator

AUDIO IN3 (L,R), (M)

- RCA jack x2
- 200 mVrms 47kΩ terminator

AUDIO OUT (N,R), (O)L

- RCA jack x2
- 200 mVrms 1kΩ output impedance

P MIC

- Ø3.5 mono mini jack
- <Low level>
- 2 mVrms, 1kΩ terminator
- <High level>
- 20 mVrms, 1kΩ terminator

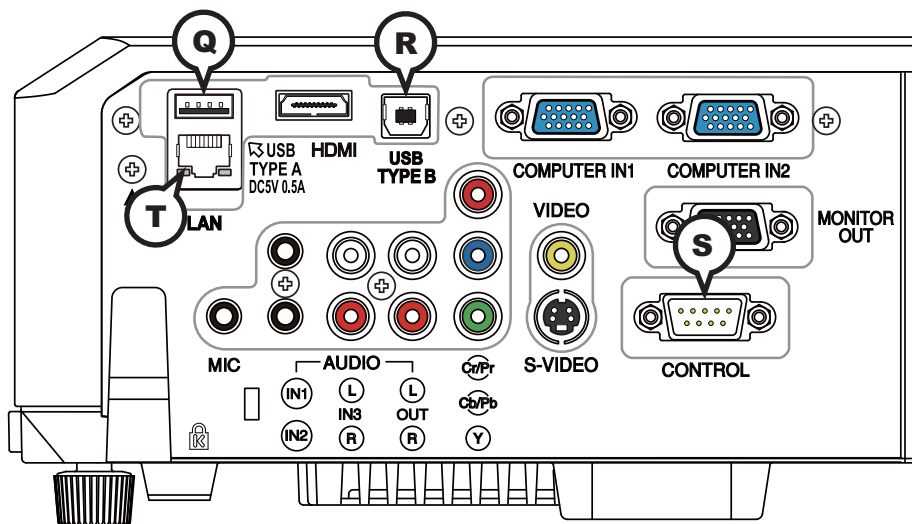

Q USB TYPE A

USB A type jack

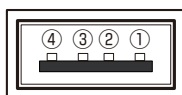

Pin	Signal
1	+5V
2	- Data
3	+ Data
4	Ground

R USB TYPE B

USB B type jack

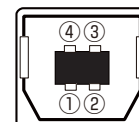

Pin	Signal
1	+5V
2	- Data
3	+ Data
4	Ground

S CONTROL

D-sub 9pin plug

• About the details of RS-232C communication, please refer to the following page.

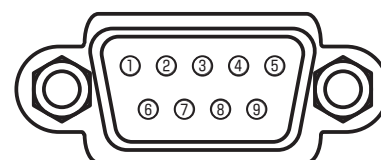

Pin	Signal	Pin	Signal	Pin	Signal
1	(No connection)	4	(No connection)	7	RTS
2	RD	5	Ground	8	CTS
3	TD	6	(No connection)	9	(No connection)

T LAN

RJ-45 jack

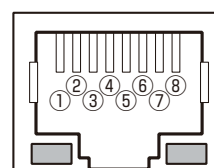

Pin	Signal	Pin	Signal	Pin	Signal
1	TX+	4	-	7	-
2	TX-	5	-	8	-
3	RX+	6	RX-		

To input SCART RGB signal;

ex.

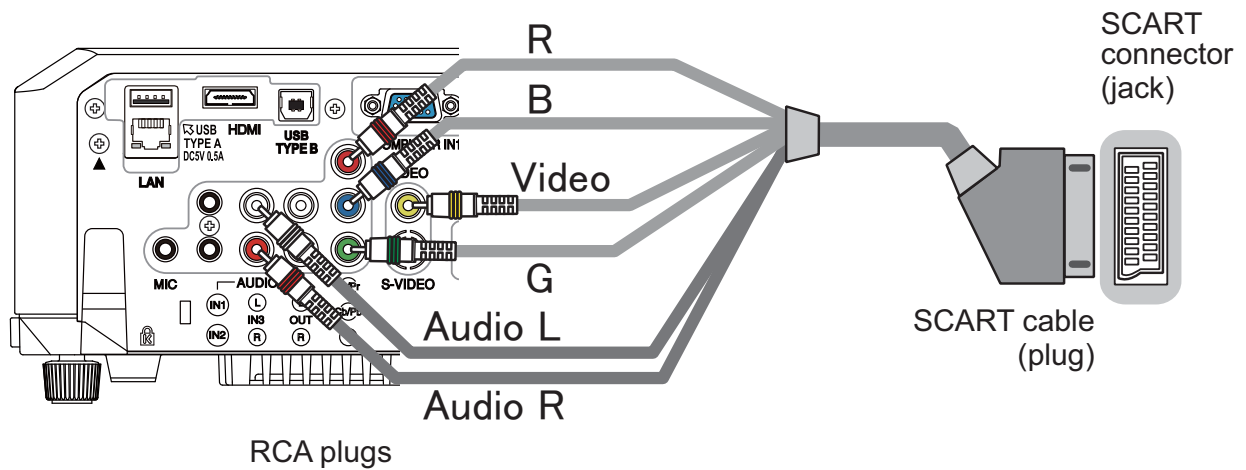

To input SCART RGB signal to the projector, use a SCART to RCA cable. Connect the plugs refer to above ex.. For more reference, please consult your dealer.

RS-232C Communication

When the projector connects to the computer by RS-232C communication, the projector can be controlled with RS-232C commands from the computer. For details of RS-232C commands, refer to RS-232C Communication / Network command table (17).

Connection

1. Turn off the projector and the computer.
2. Connect the projector's **CONTROL** port and the computer's RS-232C port with a RS-232C cable (cross). Use the cable that fulfills the specification shown in figure
3. Turn the computer on, and after the computer has started up turn the projector on.
4. Set the COMMUNICATION TYPE to OFF. (**OPTION menu - SERVICE - COMMUNICATION** in the *Operating Guide*)

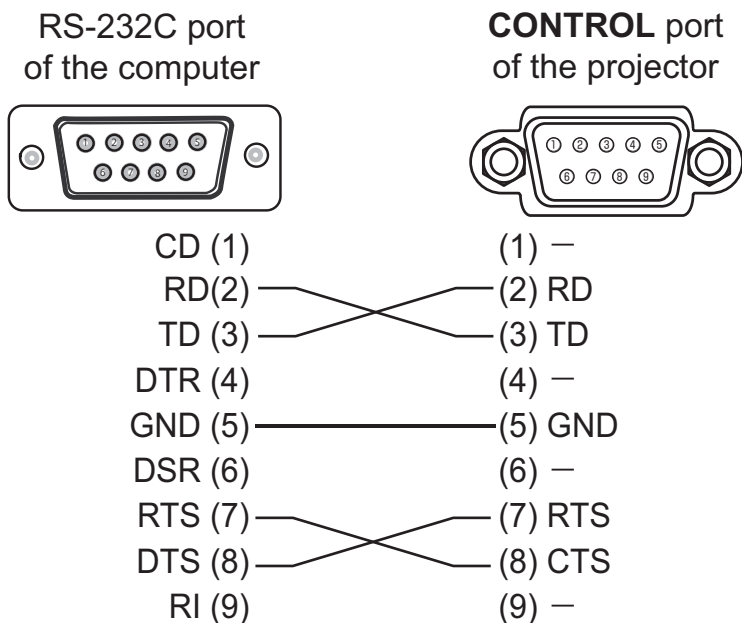
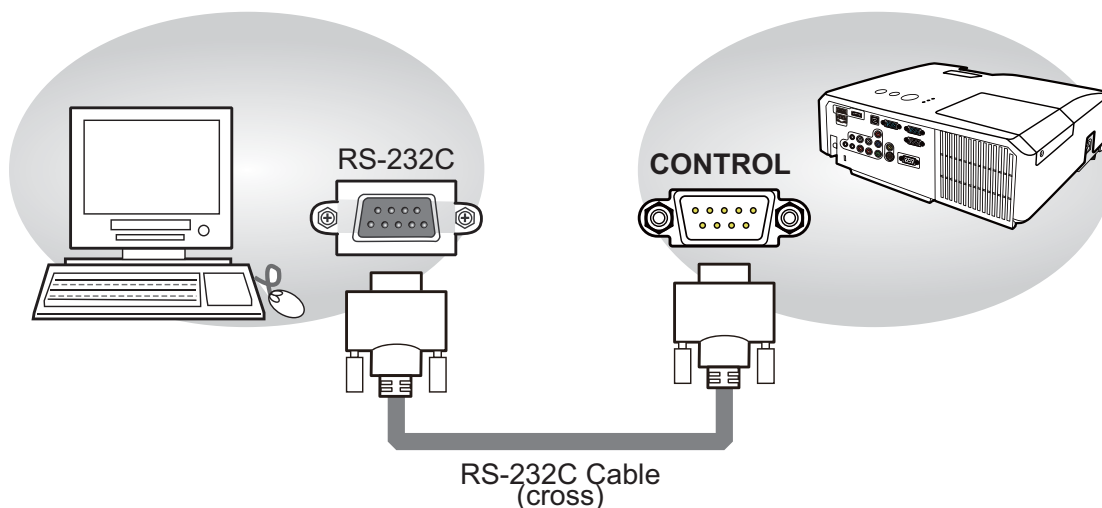

Communication settings

1. Protocol

19200bps,8N1

2. Command format ("h" shows hexadecimal)

Byte Number	0	1	2	3	4	5	6	7	8	9	10	11	12
Command	Header						Data						
	Header code		Packet	Data size		CRC flag		Action		Type		Setting code	
	L	H		L	H	L	H	L	H	L	H	L	H
<SET>Change setting to desired value [(cL)(cH)] by [(eL)(eH)].	BEh	EFh	03h	06h	00h	(aL)	(aH)	01h	00h	(bL)	(bH)	(cL)	(cH)
<GET>Read projector internal setup value [(bL)(bH)] .						(aL)	(aH)	02h	00h	(bL)	(bH)	00h	00h
<INCREMENT> Increment setup value [(bL)(bH)] by 1.						(aL)	(aH)	04h	00h	(bL)	(bH)	00h	00h
<DECREMENT> Decrement setup value [(bL)(bH)] by 1.						(aL)	(aH)	05h	00h	(bL)	(bH)	00h	00h
<EXECUTE> Run a command [(bL)(bH)].						(aL)	(aH)	06h	00h	(bL)	(bH)	00h	00h

[Header code] [Packet] [Data size]

Set [BEh, EFh, 03h, 06h, 00h] to byte number 0~4.

[CRC flag]

For byte number 5, 6, refer to RS-232C Communication / Network command table ([17](#)).

[Action]

Set functional code to byte number 7, 8.

<SET> = [01h, 00h], <GET> = [02h, 00h], <INCREMENT> = [04h, 00h]

<DECREMENT> = [05h, 00h], <EXECUTE> = [06h, 00h]

Refer to the Communication command table ([above](#)).

[Type] [Setting code]

For byte number 9~12, refer to RS-232C Communication / Network command table ([17](#)).

3. Response code / Error code ("h" shows hexadecimal)

(1) ACK reply : 06h

When the projector receives the Set, Increment, Decrement or Execute command correctly, the projector changes the setting data for the specified item by [Type], and it returns the code.

(2) NAK reply : 15h

When the projector cannot understand the received command, the projector returns the error code.

In such a case, check the sending code and send the same command again.

(3) Error reply : 1Ch + 0000h

When the projector cannot execute the received command for any reasons, the projector returns the error code.

In such a case, check the sending code and the setting status of the projector.

(4) Data reply : 1Dh + xxxxh

When the projector receives the GET command correctly, the projector returns the response code and 2 bytes of data.

- NOTE** • For connecting the projector to your devices, please read the manual for each devices, and connect them correctly with suitable cables.
- Operation cannot be guaranteed when the projector receives an undefined command or data.
 - Provide an interval of at least 40ms between the response code and any other code.
 - The projector outputs test data when the power supply is switched ON, and when the lamp is lit. Ignore this data.
 - Commands are not accepted during warm-up.
 - When the data length is greater than indicated by the data length code, the projector ignore the excess data code. Conversely when the data length is shorter than indicated by the data length code, the projector returns the error code to the computer.

Command Control via the Network

When the projector connects network, the projector can be controlled with RS-232C commands from the computer with web browser.

For details of RS-232C commands, refer to RS-232C Communication / Network command table (📖17).

NOTE • If data is transferred via wireless and wired LAN at the same time, the projector may not be able to process the data correctly.

Connection

1. Turn off the projector and the computer.
2. If you use wired LAN, connect the projector's **LAN** port to the computer's LAN port with a LAN cable. Use the cable that fulfills the specification shown in figure. If you use wireless LAN, insert the USB wireless adapter into the projector's **USB TYPE A** port.
3. Turn the computer on, and after the computer has started up turn the projector on.

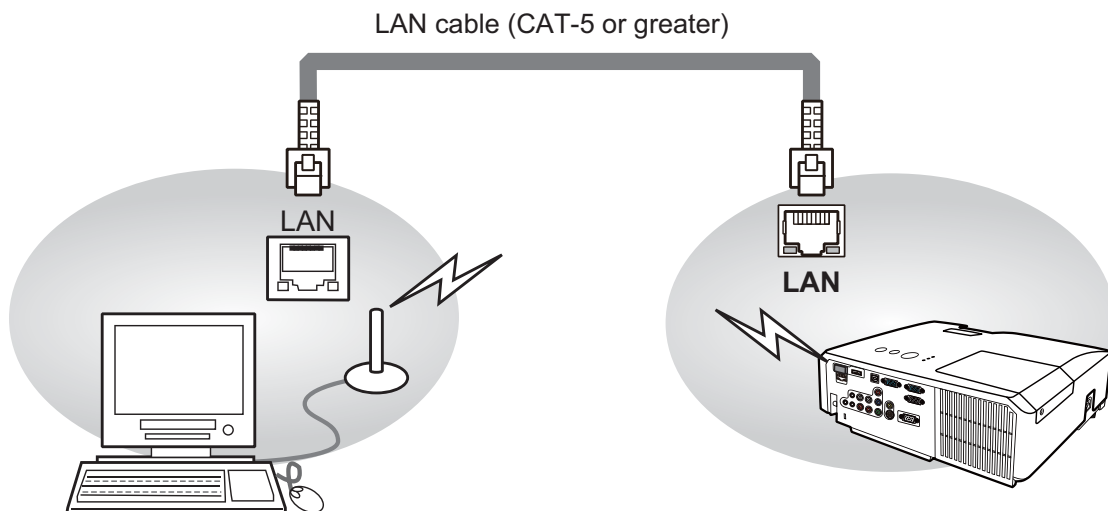

Communication Port

The following two ports are assigned for the command control.

TCP #23

TCP #9715

Configure the following items from a web browser when command control is used.

Port Settings		
Network Control Port1 (Port: 23)	Port open	Click the [Enable] check box to open [Network Control Port1 (Port: 23)] to use TCP #23. Default setting is "Enable".
	Authentication	Click the [Enable] check box for the [Authentication] setting when authentication is required. Default setting is "Disable".
Network Control Port2 (Port: 9715)	Port open	Click the [Enable] check box to open [Network Control Port2 (Port: 9715)] to use TCP #9715. Default setting is "Enable".
	Authentication	Click the [Enable] check box for the [Authentication] setting when authentication is required. Default setting is "Enable".

When the authentication setting is enabled, the following settings are required.

Security Settings		
Network Control	Authentication Password	Enter the desired authentication password. Confirm This setting will be the same for [Network Control Port1 (Port: 23)] and [Network Control Port2 (Port: 9715)] . Default setting is blank.
	Re-enter Authentication Password	

Command control settings

[TCP #23]

1. Command format

Same as RS-232C communication, refer to RS-232C Communication command format.

2. Response code / Error code ("h" shows hexadecimal)

Four of the response / error code used for TCP#23 are the same as RS-232C Communication (1)~(4). One authentication error reply (5) is added.

(1) ACK reply : 06h

Refer to RS-232C communication ([10](#)).

(2) NAK reply : 15h

Refer to RS-232C communication ([10](#)).

(3) Error reply : 1Ch + 0000h

Refer to RS-232C communication ([10](#)).

(4) Data reply : 1Dh + xxxh

Refer to RS-232C communication ([10](#)).

(5) Authentication error reply : 1Fh + 0400h

When authentication error occurred, the projector returns the error code.

[TCP #9715]

1. Command format

The commands some datum are added to the head and the end of the ones of TCP#9715 are used.

Header	Data length	RS-232C command	Check sum	Connection ID
0x02	0x0D	13 bytes	1 byte	1 byte

[Header]

02, Fixed

[Data Length]

RS-232C commands byte length (0x0D, Fixed)

[RS-232C commands]

Refer to RS-232C Communication command format ([10](#)).

[Check Sum]

This is the value to make zero on the addition of the lower 8 bits from the header to the checksum.

[Connection ID]

Random value from 0 to 255 (This value is attached to the reply data).

NOTE • Operation cannot be guaranteed when the projector receives an undefined command or data.

- Provide an interval of at least 40ms between the response code and any other code.
- Commands are not accepted during warm-up.

2. Response code / Error code ("h" shows hexadecimal)

The connection ID is attached for the TCP#23's response / error codes are used. The connection ID is same as the sending command format.

(1) ACK reply : 06h + xxh (xxh : connection ID)

(2) NAK reoly : 15h + xxh

(3) Error reply : 1Ch + 0000h + xxh

(4) Data reply : 1Dh + xxxxh + xxh

(5) Authentication error reply : 1Fh + 0400h + xxh

(6) Projector busy reply: 1Fh + xxxxxh + xxh

When the projector is too busy to receives the command ,the projector returens the error code.

In such a case, check the sending code and send the same command again.

Automatic Connection Break

The TCP connection will be automatically disconnected after there is no communication for 30 seconds after being established.

Authentication

The projector does not accept commands without authentication success when authentication is enabled. The projector uses a challenge response type authentication with an MD5 (Message Digest 5) algorithm. When the projector is using a LAN, a random 8 bytes will be returned if authentication is enabled. Bind this received 8 bytes and the authentication password and digest this data with the MD5 algorithm and add this in front of the commands to send.

Following is a sample if the authentication password is set to "password" and the random 8 bytes are "a572f60c".

- 1) Select the projector.
- 2) Receive the random 8 bytes "a572f60c" from the projector.
- 3) Bind the random 8 bytes "a572f60c" and the authentication password "password" and it becomes "a572f60cpassword".
- 4) Digest this bind "a572f60cpassword" with MD5 algorithm.
It will be "e3d97429adffa11bce1f7275813d4bde".
- 5) Add this "e3d97429adffa11bce1f7275813d4bde" in front of the commands and send the data.
Send "e3d97429adffa11bce1f7275813d4bde"+command.
- 6) When the sending data is correct, the command will be performed and the reply data will be returned. Otherwise, an authentication error will be returned.

NOTE • As for the transmission of the second or subsequent commands, the authentication data can be omitted when the same connection.

Network Bridge Communication

This projector is equipped with NETWORK BRIDGE function. When the projector connects to the computer by wired or wireless LAN communication, an external device that is connected with this projector by RS-232C communication can be controlled from the computer as a network terminal. For details, see the **6. Network Bridge** function in the **Network Guide**.

NOTE • If data is transferred via wireless and wired LAN at the same time, the projector may not be able to process the data correctly.

Connection

1. If you use wired LAN, connect the computer's LAN port and the projector's **LAN** port with a LAN cable. Use the cable that fulfills the specification shown in figure. If you use wireless LAN, insert the USB wireless adapter into the projector's **LAN** port.
2. Connect the projector's **CONTROL** port and the RS-232C port of the devices that you want to control with a RS-232C cable.
3. Turn the computer on, and after the computer has started up turn the projector on.
4. Set the COMMUNICATION TYPE to NETWORK BRIDGE. ( **OPTION menu - SERVICE - COMMUNICATION** in the *Operating Guide*)

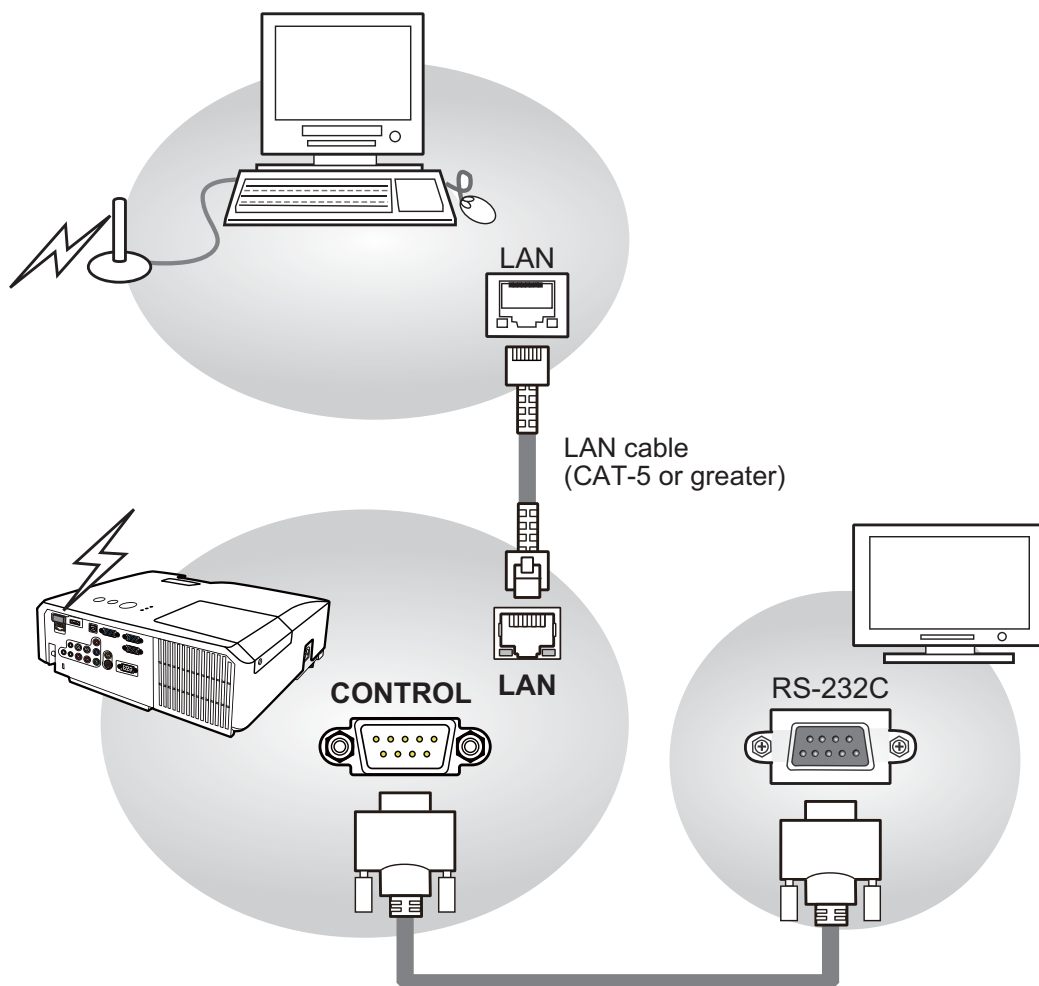

Communication settings

For communication setting, use the OPTION - SERVICE - COMMUNICATION menu. ( **OPTION menu - SERVICE - COMMUNICATION** in the *Operating Guide*)

Item	Condition
BAUD RATE	4800bps / 9600bps / 19200bps / 38400bps
Data length	8 bit (fixed)
PARITY	NONE/ODD/EVEN
Start bit	1 bit (fixed)
Stop bit	1 bit (fixed)
Transmission method	HALF-DUPLEX/FULL-DUPLEX

- NOTE** • For connecting the projector to your devices, please read the manual for each devices, and connect them correctly with suitable cables.
- Turn off (the power of) both the projector and other devices and unplug , beore connecting them.
 - For details of Transmission method, refer to **6.4 Transmission method** in the **Network Guide**.

RS-232C Communication / Network command table

Names	Operation Type	Header			Command Data				
					CRC	Action	Type	Setting code	
Power	Set	Turn off	BE EF	03	06 00	2A D3	01 00	00 60	00 00
		Turn on	BE EF	03	06 00	BA D2	01 00	00 60	01 00
	Get	BE EF	03	06 00	19 D3	02 00	00 60	00 00	
			[Example return]						
			00 00	01 00	02 00				
			[Off]	[On]	[Cool down]				
Input Source	Set	COMPUTER IN1	BE EF	03	06 00	FE D2	01 00	00 20	00 00
		COMPUTER IN2	BE EF	03	06 00	3E D0	01 00	00 20	04 00
		LAN	BE EF	03	06 00	CE D5	01 00	00 20	0B 00
		HDMI	BE EF	03	06 00	0E D2	01 00	00 20	03 00
		USB TYPE A	BE EF	03	06 00	5E D1	01 00	00 20	06 00
		USB TYPE B	BE EF	03	06 00	FE D7	01 00	00 20	0C 00
		COMPONENT	BE EF	03	06 00	AE D1	01 00	00 20	05 00
		S-VIDEO	BE EF	03	06 00	9E D3	01 00	00 20	02 00
	VIDEO	BE EF	03	06 00	6E D3	01 00	00 20	01 00	
	Get	BE EF	03	06 00	CD D2	02 00	00 20	00 00	
Error Status	Get	BE EF	03	06 00	D9 D8	02 00	20 60	00 00	
			[Example return]						
			00 00	01 00	02 00	03 00			
			[Normal]	[Cover error]	[Fan error]	[Lamp error]			
			04 00	05 00	07 00	08 00			
			[Temp error]	[Air flow error]	[Cold error]	[Filter error]			
MAGNIFY	Get	BE EF	03	06 00	7C D2	02 00	07 30	00 00	
	Increment	BE EF	03	06 00	1A D2	04 00	07 30	00 00	
	Decrement	BE EF	03	06 00	CB D3	05 00	07 30	00 00	
Magnify Position H	Get	BE EF	03	06 00	C8 D7	02 00	10 30	00 00	
	Increment	BE EF	03	06 00	AE D7	04 00	10 30	00 00	
	Decrement	BE EF	03	06 00	7F D6	05 00	10 30	00 00	
Magnify Position V	Get	BE EF	03	06 00	34 D6	02 00	11 30	00 00	
	Increment	BE EF	03	06 00	52 D6	04 00	11 30	00 00	
	Decrement	BE EF	03	06 00	83 D7	05 00	11 30	00 00	
FREEZE	Set	NORMAL	BE EF	03	06 00	83 D2	01 00	02 30	00 00
		FREEZE	BE EF	03	06 00	13 D3	01 00	02 30	01 00
	Get	BE EF	03	06 00	B0 D2	02 00	02 30	00 00	
PICTURE MODE	Set	NORMAL	BE EF	03	06 00	23 F6	01 00	BA 30	00 00
		CINEMA	BE EF	03	06 00	B3 F7	01 00	BA 30	01 00
		DYNAMIC	BE EF	03	06 00	E3 F4	01 00	BA 30	04 00
		BOARD(BLACK)	BE EF	03	06 00	E3 EF	01 00	BA 30	20 00
		BOARD(GREEN)	BE EF	03	06 00	73 EE	01 00	BA 30	21 00
		WHITEBOARD	BE EF	03	06 00	83 EE	01 00	BA 30	22 00
		DAYTIME	BE EF	03	06 00	E3 C7	01 00	BA 30	40 00
	Get	BE EF	03	06 00	10 F6	02 00	BA 30	00 00	
			[Example return]						
			00 00	01 00	04 00	20 00			
			[Normal]	[Cinema]	[Dynamic]	[BOARD(BLACK)]			
			21 00	22 00	40 00	10 00			
			[BOARD(GREEN)]	[WHITEBOARD]	[DAY TIME]	[Custom]			

RS-232C Communication / Network command table (continued)

Names	Operation Type	Header			Command Data				
					CRC	Action	Type	Setting code	
BRIGHTNESS	Get	BE EF	03	06 00	89 D2	02 00	03 20	00 00	
	Increment	BE EF	03	06 00	EF D2	04 00	03 20	00 00	
	Decrement	BE EF	03	06 00	3E D3	05 00	03 20	00 00	
BRIGHTNESS Reset	Execute	BE EF	03	06 00	58 D3	06 00	00 70	00 00	
CONTRAST	Get	BE EF	03	06 00	FD D3	02 00	04 20	00 00	
	Increment	BE EF	03	06 00	9B D3	04 00	04 20	00 00	
	Decrement	BE EF	03	06 00	4A D2	05 00	04 20	00 00	
CONTRAST Reset	Execute	BE EF	03	06 00	A4 D2	06 00	01 70	00 00	
GAMMA	Set	1 DEFAULT	BE EF	03	06 00	07 E9	01 00	A1 30	20 00
		1 CUSTOM	BE EF	03	06 00	07 FD	01 00	A1 30	10 00
		2 DEFAULT	BE EF	03	06 00	97 E8	01 00	A1 30	21 00
		2 CUSTOM	BE EF	03	06 00	97 FC	01 00	A1 30	11 00
		3 DEFAULT	BE EF	03	06 00	67 E8	01 00	A1 30	22 00
		3 CUSTOM	BE EF	03	06 00	67 FC	01 00	A1 30	12 00
		4 DEFAULT	BE EF	03	06 00	F7 E9	01 00	A1 30	23 00
		4 CUSTOM	BE EF	03	06 00	F7 FD	01 00	A1 30	13 00
		5 DEFAULT	BE EF	03	06 00	C7 EB	01 00	A1 30	24 00
		5 CUSTOM	BE EF	03	06 00	C7 FF	01 00	A1 30	14 00
		6 DEFAULT	BE EF	03	06 00	57 EA	01 00	A1 30	25 00
6 CUSTOM	BE EF	03	06 00	57 FE	01 00	A1 30	15 00		
User Gamma Pattern	Set	Get	BE EF	03	06 00	F4 F0	02 00	A1 30	00 00
		Off	BE EF	03	06 00	FB FA	01 00	80 30	00 00
		9 steps gray scale	BE EF	03	06 00	6B FB	01 00	80 30	01 00
		15 steps gray scale	BE EF	03	06 00	9B FB	01 00	80 30	02 00
	Ramp	BE EF	03	06 00	0B FA	01 00	80 30	03 00	
User Gamma Point 1	Get	BE EF	03	06 00	C8 FA	02 00	80 30	00 00	
		Get	BE EF	03	06 00	08 FE	02 00	90 30	00 00
		Increment	BE EF	03	06 00	6E FE	04 00	90 30	00 00
User Gamma Point 2	Get	BE EF	03	06 00	BF FF	05 00	90 30	00 00	
		Decrement	BE EF	03	06 00	58 C2	06 00	50 70	00 00
		Execute	BE EF	03	06 00	F4 FF	02 00	91 30	00 00
User Gamma Point 3	Get	BE EF	03	06 00	92 FF	04 00	91 30	00 00	
		Increment	BE EF	03	06 00	43 FE	05 00	91 30	00 00
		Decrement	BE EF	03	06 00	A4 C3	06 00	51 70	00 00
User Gamma Point 2 Reset	Execute	BE EF	03	06 00	B0 FF	02 00	92 30	00 00	
User Gamma Point 4	Get	BE EF	03	06 00	D6 FF	04 00	92 30	00 00	
		Increment	BE EF	03	06 00	07 FE	05 00	92 30	00 00
		Decrement	BE EF	03	06 00	E0 C3	06 00	52 70	00 00
User Gamma Point 3 Reset	Execute	BE EF	03	06 00	4C FE	02 00	93 30	00 00	
User Gamma Point 5	Get	BE EF	03	06 00	2A FE	04 00	93 30	00 00	
		Increment	BE EF	03	06 00	FB FF	05 00	93 30	00 00
		Decrement	BE EF	03	06 00	1C C2	06 00	53 70	00 00
User Gamma Point 4 Reset	Execute	BE EF	03	06 00	38 FF	02 00	94 30	00 00	
User Gamma Point 5	Get	BE EF	03	06 00	5E FF	04 00	94 30	00 00	
		Increment	BE EF	03	06 00	8F FE	05 00	94 30	00 00
		Decrement	BE EF	03	06 00				

RS-232C Communication / Network command table (continued)

Names	Operation Type	Header			Command Data				
					CRC	Action	Type	Setting code	
User Gamma Point 5 Reset	Execute	BE EF	03	06 00	68 C3	06 00	54 70	00 00	
User Gamma Point 6	Get	BE EF	03	06 00	C4 FE	02 00	95 30	00 00	
	Increment	BE EF	03	06 00	A2 FE	04 00	95 30	00 00	
	Decrement	BE EF	03	06 00	73 FF	05 00	95 30	00 00	
User Gamma Point 6 Reset	Execute	BE EF	03	06 00	94 C2	06 00	55 70	00 00	
User Gamma Point 7	Get	BE EF	03	06 00	80 FE	02 00	96 30	00 00	
	Increment	BE EF	03	06 00	E6 FE	04 00	96 30	00 00	
	Decrement	BE EF	03	06 00	37 FF	05 00	96 30	00 00	
User Gamma Point 7 Reset	Execute	BE EF	03	06 00	D0 C2	06 00	56 70	00 00	
User Gamma Point 8	Get	BE EF	03	06 00	7C FF	02 00	97 30	00 00	
	Increment	BE EF	03	06 00	1A FF	04 00	97 30	00 00	
	Decrement	BE EF	03	06 00	CB FE	05 00	97 30	00 00	
User Gamma Point 8 Reset	Execute	BE EF	03	06 00	2C C3	06 00	57 70	00 00	
COLOR TEMP	Set	1 HIGH	BE EF	03	06 00	0B F5	01 00	B0 30	03 00
		1 CUSTOM	BE EF	03	06 00	CB F8	01 00	B0 30	13 00
		2 MID	BE EF	03	06 00	9B F4	01 00	B0 30	02 00
		2 CUSTOM	BE EF	03	06 00	5B F9	01 00	B0 30	12 00
		3 LOW	BE EF	03	06 00	6B F4	01 00	B0 30	01 00
		3 CUSTOM	BE EF	03	06 00	AB F9	01 00	B0 30	11 00
		4 Hi-BRIGHT-1	BE EF	03	06 00	3B F2	01 00	B0 30	08 00
		4 CUSTOM	BE EF	03	06 00	FB FF	01 00	B0 30	18 00
		5 Hi-BRIGHT-2	BE EF	03	06 00	AB F3	01 00	B0 30	09 00
		5 CUSTOM	BE EF	03	06 00	6B FE	01 00	B0 30	19 00
		6 Hi-BRIGHT-3	BE EF	03	06 00	5B F3	01 00	B0 30	0A 00
6 CUSTOM	BE EF	03	06 00	9B FE	01 00	B0 30	1A 00		
COLOR TEMP GAIN R	Get	BE EF	03	06 00	C8 F5	02 00	B0 30	00 00	
	Increment	BE EF	03	06 00	34 F4	04 00	B1 30	00 00	
	Decrement	BE EF	03	06 00	52 F4	05 00	B1 30	00 00	
COLOR TEMP GAIN R Reset	Execute	BE EF	03	06 00	83 F5	06 00	46 70	00 00	
COLOR TEMP GAIN G	Get	BE EF	03	06 00	10 C6	02 00	B2 30	00 00	
	Increment	BE EF	03	06 00	70 F4	04 00	B2 30	00 00	
	Decrement	BE EF	03	06 00	16 F4	05 00	B2 30	00 00	
COLOR TEMP GAIN G Reset	Execute	BE EF	03	06 00	C7 F5	06 00	47 70	00 00	
COLOR TEMP GAIN B	Get	BE EF	03	06 00	EC C7	02 00	B3 30	00 00	
	Increment	BE EF	03	06 00	8C F5	04 00	B3 30	00 00	
	Decrement	BE EF	03	06 00	EA F5	05 00	B3 30	00 00	
COLOR TEMP GAIN B Reset	Execute	BE EF	03	06 00	3B F4	06 00	48 70	00 00	
COLOR TEMP OFFSET R	Get	BE EF	03	06 00	F8 C4	02 00	B5 30	00 00	
	Increment	BE EF	03	06 00	04 F5	04 00	B5 30	00 00	
	Decrement	BE EF	03	06 00	62 F5	05 00	B5 30	00 00	

RS-232C Communication / Network command table (continued)

Names	Operation Type	Header			Command Data				
					CRC	Action	Type	Setting code	
COLOR TEMP OFFSET R Reset	Execute	BE EF	03	06 00	40 C5	06 00	4A 70	00 00	
COLOR TEMP OFFSET G	Get	BE EF	03	06 00	40 F5	02 00	B6 30	00 00	
	Increment	BE EF	03	06 00	26 F5	04 00	B6 30	00 00	
	Decrement	BE EF	03	06 00	F7 F4	05 00	B6 30	00 00	
COLOR TEMP OFFSET G Reset	Execute	BE EF	03	06 00	BC C4	06 00	4B 70	00 00	
COLOR TEMP OFFSET B	Get	BE EF	03	06 00	BC F4	02 00	B7 30	00 00	
	Increment	BE EF	03	06 00	DA F4	04 00	B7 30	00 00	
	Decrement	BE EF	03	06 00	0B F5	05 00	B7 30	00 00	
COLOR TEMP OFFSET B Reset	Execute	BE EF	03	06 00	C8 C5	06 00	4C 70	00 00	
COLOR	Get	BE EF	03	06 00	B5 72	02 00	02 22	00 00	
	Increment	BE EF	03	06 00	D3 72	04 00	02 22	00 00	
	Decrement	BE EF	03	06 00	02 73	05 00	02 22	00 00	
COLOR Reset	Execute	BE EF	03	06 00	80 D0	06 00	0A 70	00 00	
TINT	Get	BE EF	03	06 00	49 73	02 00	03 22	00 00	
	Increment	BE EF	03	06 00	2F 73	04 00	03 22	00 00	
	Decrement	BE EF	03	06 00	FE 72	05 00	03 22	00 00	
TINT Reset	Execute	BE EF	03	06 00	7C D1	06 00	0B 70	00 00	
SHARPNESS	Get	BE EF	03	06 00	F1 72	02 00	01 22	00 00	
	Increment	BE EF	03	06 00	97 72	04 00	01 22	00 00	
	Decrement	BE EF	03	06 00	46 73	05 00	01 22	00 00	
SHARPNESS Reset	Execute	BE EF	03	06 00	C4 D0	06 00	09 70	00 00	
ACTIVE IRIS	Set	OFF	BE EF	03	06 00	0B 22	01 00	04 33	00 00
		THEATER	BE EF	03	06 00	CB 2F	01 00	04 33	10 00
		PRESENTATION	BE EF	03	06 00	5B 2E	01 00	04 33	11 00
	Get	BE EF	03	06 00	38 22	02 00	04 33	00 00	
MY MEMORY Load	Set	1	BE EF	03	06 00	0E D7	01 00	14 20	00 00
		2	BE EF	03	06 00	9E D6	01 00	14 20	01 00
		3	BE EF	03	06 00	6E D6	01 00	14 20	02 00
		4	BE EF	03	06 00	FE D7	01 00	14 20	03 00
MY MEMORY Save	Set	1	BE EF	03	06 00	F2 D6	01 00	15 20	00 00
		2	BE EF	03	06 00	62 D7	01 00	15 20	01 00
		3	BE EF	03	06 00	92 D7	01 00	15 20	02 00
		4	BE EF	03	06 00	02 D6	01 00	15 20	03 00
ASPECT	Set	4:3	BE EF	03	06 00	9E D0	01 00	08 20	00 00
		16:9	BE EF	03	06 00	0E D1	01 00	08 20	01 00
		14:9	BE EF	03	06 00	CE D6	01 00	08 20	09 00
		16:10	BE EF	03	06 00	3E D6	01 00	08 20	0A 00
		(*) NATIVE	BE EF	03	06 00	5E D7	01 00	08 20	08 00
	NORMAL	BE EF	03	06 00	5E DD	01 00	08 20	10 00	
Get	BE EF	03	06 00	AD D0	02 00	08 20	00 00		

(*) only for CP-WX3014WN

RS-232C Communication / Network command table (continued)

Names	Operation Type	Header			Command Data				
					CRC	Action	Type	Setting code	
OVER SCAN	Get	BE EF	03	06 00	91 70	02 00	09 22	00 00	
	Increment	BE EF	03	06 00	F7 70	04 00	09 22	00 00	
	Decrement	BE EF	03	06 00	26 71	05 00	09 22	00 00	
OVER SCAN Reset	Execute	BE EF	03	06 00	EC D9	06 00	27 70	00 00	
V POSITION	Get	BE EF	03	06 00	0D 83	02 00	00 21	00 00	
	Increment	BE EF	03	06 00	6B 83	04 00	00 21	00 00	
	Decrement	BE EF	03	06 00	BA 82	05 00	00 21	00 00	
V POSITION Reset	Execute	BE EF	03	06 00	E0 D2	06 00	02 70	00 00	
H POSITION	Get	BE EF	03	06 00	F1 82	02 00	01 21	00 00	
	Increment	BE EF	03	06 00	97 82	04 00	01 21	00 00	
	Decrement	BE EF	03	06 00	46 83	05 00	01 21	00 00	
H POSITION Reset	Execute	BE EF	03	06 00	1C D3	06 00	03 70	00 00	
H PHASE	Get	BE EF	03	06 00	49 83	02 00	03 21	00 00	
	Increment	BE EF	03	06 00	2F 83	04 00	03 21	00 00	
	Decrement	BE EF	03	06 00	FE 82	05 00	03 21	00 00	
H SIZE	Get	BE EF	03	06 00	B5 82	02 00	02 21	00 00	
	Increment	BE EF	03	06 00	D3 82	04 00	02 21	00 00	
	Decrement	BE EF	03	06 00	02 83	05 00	02 21	00 00	
H SIZE Reset	Execute	BE EF	03	06 00	68 D2	06 00	04 70	00 00	
AUTO ADJUST EXECUTE	Execute	BE EF	03	06 00	91 D0	06 00	0A 20	00 00	
PROGRESSIVE	Set	OFF	BE EF	03	06 00	4A 72	01 00	07 22	00 00
		TV	BE EF	03	06 00	DA 73	01 00	07 22	01 00
		FILM	BE EF	03	06 00	2A 73	01 00	07 22	02 00
	Get	BE EF	03	06 00	79 72	02 00	07 22	00 00	
VIDEO NR	Set	LOW	BE EF	03	06 00	26 72	01 00	06 22	01 00
		MID	BE EF	03	06 00	D6 72	01 00	06 22	02 00
		HIGH	BE EF	03	06 00	46 73	01 00	06 22	03 00
	Get	BE EF	03	06 00	85 73	02 00	06 22	00 00	
COLOR SPACE	Set	AUTO	BE EF	03	06 00	0E 72	01 00	04 22	00 00
		RGB	BE EF	03	06 00	9E 73	01 00	04 22	01 00
		SMPTE240	BE EF	03	06 00	6E 73	01 00	04 22	02 00
		REC709	BE EF	03	06 00	FE 72	01 00	04 22	03 00
		REC601	BE EF	03	06 00	CE 70	01 00	04 22	04 00
	Get	BE EF	03	06 00	3D 72	02 00	04 22	00 00	
COMPONENT	Set	COMPONENT	BE EF	03	06 00	4A D7	01 00	17 20	00 00
		SCART RGB	BE EF	03	06 00	DA D6	01 00	17 20	01 00
	Get	BE EF	03	06 00	79 D7	02 00	17 20	00 00	
S-VIDEO FORMAT	Set	AUTO	BE EF	03	06 00	E6 70	01 00	12 22	0A 00
		NTSC	BE EF	03	06 00	86 74	01 00	12 22	04 00
		PAL	BE EF	03	06 00	16 75	01 00	12 22	05 00
		SECAM	BE EF	03	06 00	16 70	01 00	12 22	09 00
		NTSC4.43	BE EF	03	06 00	26 77	01 00	12 22	02 00
		M-PAL	BE EF	03	06 00	86 71	01 00	12 22	08 00
		N-PAL	BE EF	03	06 00	76 74	01 00	12 22	07 00
	Get	BE EF	03	06 00	75 76	02 00	12 22	00 00	

RS-232C Communication / Network command table (continued)

Names	Operation Type	Header			Command Data				
					CRC	Action	Type	Setting code	
C-VIDEO FORMAT	Set	AUTO	BE EF	03	06 00	A2 70	01 00	11 22	0A 00
		NTSC	BE EF	03	06 00	C2 74	01 00	11 22	04 00
		PAL	BE EF	03	06 00	52 75	01 00	11 22	05 00
		SECAM	BE EF	03	06 00	52 70	01 00	11 22	09 00
		NTSC4.43	BE EF	03	06 00	62 77	01 00	11 22	02 00
		M-PAL	BE EF	03	06 00	C2 71	01 00	11 22	08 00
	N-PAL	BE EF	03	06 00	32 74	01 00	11 22	07 00	
	Get	BE EF	03	06 00	31 76	02 00	11 22	00 00	
HDMI FORMAT	Set	AUTO	BE EF	03	06 00	BA 77	01 00	13 22	00 00
		VIDEO	BE EF	03	06 00	2A 76	01 00	13 22	01 00
	COMPUTER	BE EF	03	06 00	DA 76	01 00	13 22	02 00	
	Get	BE EF	03	06 00	89 77	02 00	13 22	00 00	
HDMI RANGE	Set	AUTO	BE EF	03	06 00	86 D8	01 00	22 20	00 00
		NORMAL	BE EF	03	06 00	16 D9	01 00	22 20	01 00
	ENHANCED	BE EF	03	06 00	E6 D9	01 00	22 20	02 00	
	Get	BE EF	03	06 00	B5 D8	02 00	22 20	00 00	
COMPUTER IN1	Set	AUTO	BE EF	03	06 00	CE D6	01 00	10 20	03 00
		SYNC ON G OFF	BE EF	03	06 00	5E D7	01 00	10 20	02 00
	Get	BE EF	03	06 00	0D D6	02 00	10 20	00 00	
COMPUTER IN2	Set	AUTO	BE EF	03	06 00	32 D7	01 00	11 20	03 00
		SYNC ON G OFF	BE EF	03	06 00	A2 D6	01 00	11 20	02 00
	Get	BE EF	03	06 00	F1 D7	02 00	11 20	00 00	
FRAME LOCK – COMPUTER IN1	Set	OFF	BE EF	03	06 00	3B C2	01 00	50 30	00 00
		ON	BE EF	03	06 00	AB C3	01 00	50 30	01 00
	Get	BE EF	03	06 00	08 C2	02 00	50 30	00 00	
FRAME LOCK – COMPUTER IN2	Set	OFF	BE EF	03	06 00	0B C3	01 00	54 30	00 00
		ON	BE EF	03	06 00	9B C2	01 00	54 30	01 00
	Get	BE EF	03	06 00	38 C3	02 00	54 30	00 00	
FRAME LOCK - HDMI	Set	OFF	BE EF	03	06 00	7F C2	01 00	53 30	00 00
		ON	BE EF	03	06 00	EF C3	01 00	53 30	01 00
	Get	BE EF	03	06 00	4C C2	02 00	53 30	00 00	
AUTO KEYSTONE V EXECUTE	Execute	BE EF	03	06 00	E5 D1	06 00	0D 20	00 00	
KEYSTONE V	Get	BE EF	03	06 00	B9 D3	02 00	07 20	00 00	
	Increment	BE EF	03	06 00	DF D3	04 00	07 20	00 00	
	Decrement	BE EF	03	06 00	0E D2	05 00	07 20	00 00	
KEYSTONE V Reset	Execute	BE EF	03	06 00	08 D0	06 00	0C 70	00 00	
AUTO ECO MODE	Set	OFF	BE EF	03	06 00	FB 27	01 00	10 33	00 00
		ON	BE EF	03	06 00	6B 26	01 00	10 33	01 00
	Get	BE EF	03	06 00	C8 27	02 00	10 33	00 00	
ECO MODE	Set	NORMAL	BE EF	03	06 00	3B 23	01 00	00 33	00 00
		ECO	BE EF	03	06 00	AB 22	01 00	00 33	01 00
	Get	BE EF	03	06 00	08 23	02 00	00 33	00 00	
MIRROR	Set	NORMAL	BE EF	03	06 00	C7 D2	01 00	01 30	00 00
		H:INVERT	BE EF	03	06 00	57 D3	01 00	01 30	01 00
		V:INVERT	BE EF	03	06 00	A7 D3	01 00	01 30	02 00
	H&V:INVERT	BE EF	03	06 00	37 D2	01 00	01 30	03 00	
	Get	BE EF	03	06 00	F4 D2	02 00	01 30	00 00	

RS-232C Communication / Network command table (continued)

Names	Operation Type	Header				Command Data			
						CRC	Action	Type	Setting code
STANDBY MODE	Set	NORMAL	BE EF	03	06 00	D6 D2	01 00	01 60	00 00
		SAVING	BE EF	03	06 00	46 D3	01 00	01 60	01 00
	Get	BE EF	03	06 00	E5 D2	02 00	01 60	00 00	
MONITOR OUT - COMPUTER IN1	Set	COMPUTER IN1	BE EF	03	06 00	3E F4	01 00	B0 20	00 00
		OFF	BE EF	03	06 00	CE B5	01 00	B0 20	FF 00
	Get	BE EF	03	06 00	0D F4	02 00	B0 20	00 00	
MONITOR OUT - COMPUTER IN2	Set	COMPUTER IN2	BE EF	03	06 00	CE F7	01 00	B4 20	04 00
		OFF	BE EF	03	06 00	FE B4	01 00	B4 20	FF 00
	Get	BE EF	03	06 00	3D F5	02 00	B4 20	00 00	
MONITOR OUT - COMPONENT	Set	COMPUTER IN1	BE EF	03	06 00	F2 F4	01 00	B5 20	00 00
		COMPUTER IN2	BE EF	03	06 00	32 F6	01 00	B5 20	04 00
		OFF	BE EF	03	06 00	02 B5	01 00	B5 20	FF 00
	Get	BE EF	03	06 00	C1 F4	02 00	B5 20	00 00	
MONITOR OUT - S-VIDEO	Set	COMPUTER IN1	BE EF	03	06 00	86 F5	01 00	B2 20	00 00
		COMPUTER IN2	BE EF	03	06 00	46 F7	01 00	B2 20	04 00
		OFF	BE EF	03	06 00	76 B4	01 00	B2 20	FF 00
	Get	BE EF	03	06 00	B5 F5	02 00	B2 20	00 00	
MONITOR OUT - VIDEO	Set	COMPUTER IN1	BE EF	03	06 00	C2 F5	01 00	B1 20	00 00
		COMPUTER IN2	BE EF	03	06 00	02 F7	01 00	B1 20	04 00
		OFF	BE EF	03	06 00	32 B4	01 00	B1 20	FF 00
	Get	BE EF	03	06 00	F1 F5	02 00	B1 20	00 00	
MONITOR OUT - HDMI	Set	COMPUTER IN1	BE EF	03	06 00	7A F4	01 00	B3 20	00 00
		COMPUTER IN2	BE EF	03	06 00	BA F6	01 00	B3 20	04 00
		OFF	BE EF	03	06 00	8A B5	01 00	B3 20	FF 00
	Get	BE EF	03	06 00	49 F4	02 00	B3 20	00 00	
MONITOR OUT - LAN	Set	COMPUTER IN1	BE EF	03	06 00	1A F6	01 00	BB 20	00 00
		COMPUTER IN2	BE EF	03	06 00	DA F4	01 00	BB 20	04 00
		OFF	BE EF	03	06 00	EA B7	01 00	BB 20	FF 00
	Get	BE EF	03	06 00	29 F6	02 00	BB 20	00 00	
MONITOR OUT - USB TYPE A	Set	COMPUTER IN1	BE EF	03	06 00	B6 F4	01 00	B6 20	00 00
		COMPUTER IN2	BE EF	03	06 00	76 F6	01 00	B6 20	04 00
		OFF	BE EF	03	06 00	46 B5	01 00	B6 20	FF 00
	Get	BE EF	03	06 00	85 F4	02 00	B6 20	00 00	
MONITOR OUT - USB TYPE B	Set	COMPUTER IN1	BE EF	03	06 00	6E F7	01 00	BC 20	00 00
		COMPUTER IN2	BE EF	03	06 00	AE F5	01 00	BC 20	04 00
		OFF	BE EF	03	06 00	9E B6	01 00	BC 20	FF 00
	Get	BE EF	03	06 00	5D F7	02 00	BC 20	00 00	
MONITOR OUT - STANDBY	Set	COMPUTER IN1	BE EF	03	06 00	2A F7	01 00	BF 20	00 00
		COMPUTER IN2	BE EF	03	06 00	EA F5	01 00	BF 20	04 00
		OFF	BE EF	03	06 00	DA B6	01 00	BF 20	FF 00
	Get	BE EF	03	06 00	19 F7	02 00	BF 20	00 00	
VOLUME - COMPUTER IN1	Get	BE EF	03	06 00	CD CC	02 00	60 20	00 00	
	Increment	BE EF	03	06 00	AB CC	04 00	60 20	00 00	
	Decrement	BE EF	03	06 00	7A CD	05 00	60 20	00 00	
VOLUME - COMPUTER IN2	Get	BE EF	03	06 00	FD CD	02 00	64 20	00 00	
	Increment	BE EF	03	06 00	9B CD	04 00	64 20	00 00	
	Decrement	BE EF	03	06 00	4A CC	05 00	64 20	00 00	
VOLUME - COMPONENT	Get	BE EF	03	06 00	01 CC	02 00	65 20	00 00	
	Increment	BE EF	03	06 00	67 CC	04 00	65 20	00 00	
	Decrement	BE EF	03	06 00	B6 CD	05 00	65 20	00 00	

RS-232C Communication / Network command table (continued)

Names	Operation Type	Header			Command Data				
					CRC	Action	Type	Setting code	
VOLUME - S-VIDEO	Get	BE EF	03	06 00	75 CD	02 00	62 20	00 00	
	Increment	BE EF	03	06 00	13 CD	04 00	62 20	00 00	
	Decrement	BE EF	03	06 00	C2 CC	05 00	62 20	00 00	
VOLUME - VIDEO	Get	BE EF	03	06 00	31 CD	02 00	61 20	00 00	
	Increment	BE EF	03	06 00	57 CD	04 00	61 20	00 00	
	Decrement	BE EF	03	06 00	86 CC	05 00	61 20	00 00	
VOLUME - HDMI	Get	BE EF	03	06 00	89 CC	02 00	63 20	00 00	
	Increment	BE EF	03	06 00	EF CC	04 00	63 20	00 00	
	Decrement	BE EF	03	06 00	3E CD	05 00	63 20	00 00	
VOLUME - LAN	Get	BE EF	03	06 00	E9 CE	02 00	6B 20	00 00	
	Increment	BE EF	03	06 00	8F CE	04 00	6B 20	00 00	
	Decrement	BE EF	03	06 00	5E CF	05 00	6B 20	00 00	
VOLUME - USB TYPE A	Get	BE EF	03	06 00	45 CC	02 00	66 20	00 00	
	Increment	BE EF	03	06 00	23 CC	04 00	66 20	00 00	
	Decrement	BE EF	03	06 00	F2 CD	05 00	66 20	00 00	
VOLUME - USB TYPE B	Get	BE EF	03	06 00	9D CF	02 00	6C 20	00 00	
	Increment	BE EF	03	06 00	FB CF	04 00	6C 20	00 00	
	Decrement	BE EF	03	06 00	2A CE	05 00	6C 20	00 00	
VOLUME - STANDBY	Get	BE EF	03	06 00	D9 CF	02 00	6F 20	00 00	
	Increment	BE EF	03	06 00	BF CF	04 00	6F 20	00 00	
	Decrement	BE EF	03	06 00	6E CE	05 00	6F 20	00 00	
VOLUME - ALL	Get	BE EF	03	06 00	CD C3	02 00	50 20	00 00	
	Increment	BE EF	03	06 00	AB C3	04 00	50 20	00 00	
	Decrement	BE EF	03	06 00	7A C2	05 00	50 20	00 00	
MUTE	Set	OFF	BE EF	03	06 00	46 D3	01 00	02 20	00 00
		ON	BE EF	03	06 00	D6 D2	01 00	02 20	01 00
	Get	BE EF	03	06 00	75 D3	02 00	02 20	00 00	
SPEAKER	Set	ON	BE EF	03	06 00	FE D4	01 00	1C 20	01 00
		OFF	BE EF	03	06 00	6E D5	01 00	1C 20	00 00
	Get	BE EF	03	06 00	5D D5	02 00	1C 20	00 00	
AUDIO SOURCE - COMPUTER IN1	Set	AUDIO IN1	BE EF	03	06 00	6E DC	01 00	30 20	01 00
		AUDIO IN2	BE EF	03	06 00	9E DC	01 00	30 20	02 00
		AUDIO IN3	BE EF	03	06 00	0E DD	01 00	30 20	03 00
		OFF	BE EF	03	06 00	FE DD	01 00	30 20	00 00
	Get	BE EF	03	06 00	CD DD	02 00	30 20	00 00	
AUDIO SOURCE - COMPUTER IN2	Set	AUDIO IN1	BE EF	03	06 00	5E DD	01 00	34 20	01 00
		AUDIO IN2	BE EF	03	06 00	AE DD	01 00	34 20	02 00
		AUDIO IN3	BE EF	03	06 00	3E DC	01 00	34 20	03 00
		OFF	BE EF	03	06 00	CE DC	01 00	34 20	00 00
	Get	BE EF	03	06 00	FD DC	02 00	34 20	00 00	
AUDIO SOURCE - LAN	Set	AUDIO IN1	BE EF	03	06 00	4A DE	01 00	3B 20	01 00
		AUDIO IN2	BE EF	03	06 00	BA DE	01 00	3B 20	02 00
		AUDIO IN3	BE EF	03	06 00	2A DF	01 00	3B 20	03 00
		AUDIO_LAN	BE EF	03	06 00	8A D3	01 00	3B 20	11 00
		OFF	BE EF	03	06 00	DA DF	01 00	3B 20	00 00
	Get	BE EF	03	06 00	E9 DF	02 00	3B 20	00 00	

RS-232C Communication / Network command table (continued)

Names	Operation Type	Header				Command Data			
						CRC	Action	Type	Setting code
AUDIO SOURCE - USB TYPE A	Set	AUDIO IN1	BE EF	03	06 00	E6 DC	01 00	36 20	01 00
		AUDIO IN2	BE EF	03	06 00	16 DC	01 00	36 20	02 00
		AUDIO IN3	BE EF	03	06 00	86 DD	01 00	36 20	03 00
		AUDIO_USB TYPE A	BE EF	03	06 00	B6 D0	01 00	36 20	10 00
		OFF	BE EF	03	06 00	DA DF	01 00	3B 20	00 00
	Get	BE EF	03	06 00	45 DD	02 00	36 20	00 00	
AUDIO SOURCE - USB TYPE B	Set	AUDIO IN1	BE EF	03	06 00	3E DF	01 00	3C 20	01 00
		AUDIO IN2	BE EF	03	06 00	CE DF	01 00	3C 20	02 00
		AUDIO IN3	BE EF	03	06 00	5E DE	01 00	3C 20	03 00
		AUDIO_USB TYPE B	BE EF	03	06 00	0E D2	01 00	3C 20	12 00
		OFF	BE EF	03	06 00	AE DE	01 00	3C 20	00 00
	Get	BE EF	03	06 00	9D DE	02 00	3C 20	00 00	
AUDIO SOURCE - HDMI	Set	AUDIO IN1	BE EF	03	06 00	2A DC	01 00	33 20	01 00
		AUDIO IN2	BE EF	03	06 00	DA DC	01 00	33 20	02 00
		AUDIO IN3	BE EF	03	06 00	4A DD	01 00	33 20	03 00
		AUDIO_HDMI	BE EF	03	06 00	7A C4	01 00	33 20	20 00
		OFF	BE EF	03	06 00	BA DD	01 00	33 20	00 00
	Get	BE EF	03	06 00	89 DD	02 00	33 20	00 00	
AUDIO SOURCE - COMPONENT	Set	AUDIO IN1	BE EF	03	06 00	A2 DC	01 00	35 20	01 00
		AUDIO IN2	BE EF	03	06 00	52 DC	01 00	35 20	02 00
		AUDIO IN3	BE EF	03	06 00	C2 DD	01 00	35 20	03 00
		OFF	BE EF	03	06 00	32 DD	01 00	35 20	00 00
		Get	BE EF	03	06 00	01 DD	02 00	35 20	00 00
	AUDIO SOURCE - S-VIDEO	Set	AUDIO IN1	BE EF	03	06 00	D6 DD	01 00	32 20
AUDIO IN2			BE EF	03	06 00	26 DD	01 00	32 20	02 00
AUDIO IN3			BE EF	03	06 00	B6 DC	01 00	32 20	03 00
OFF			BE EF	03	06 00	46 DC	01 00	32 20	00 00
Get			BE EF	03	06 00	75 DC	02 00	32 20	00 00
AUDIO SOURCE - VIDEO		Set	AUDIO IN1	BE EF	03	06 00	92 DD	01 00	31 20
	AUDIO IN2		BE EF	03	06 00	62 DD	01 00	31 20	02 00
	AUDIO IN3		BE EF	03	06 00	F2 DC	01 00	31 20	03 00
	OFF		BE EF	03	06 00	02 DC	01 00	31 20	00 00
	Get		BE EF	03	06 00	31 DC	02 00	31 20	00 00
	AUDIO SOURCE - STANDBY	Set	AUDIO IN1	BE EF	03	06 00	7A DF	01 00	3F 20
AUDIO IN2			BE EF	03	06 00	8A DF	01 00	3F 20	02 00
AUDIO IN3			BE EF	03	06 00	1A DE	01 00	3F 20	03 00
OFF			BE EF	03	06 00	EA DE	01 00	3F 20	00 00
Get			BE EF	03	06 00	D9 DE	02 00	3F 20	00 00
LAN SOUND ENABLE		Set	Disable	BE EF	03	06 00	BA F0	01 00	A3 20
	Enable		BE EF	03	06 00	2A F1	01 00	A3 20	01 00
	Get	BE EF	03	06 00	89 F0	02 00	A3 20	00 00	
USB TYPE A SOUND ENABLE	Set	Disable	BE EF	03	06 00	CE F1	01 00	A4 20	00 00
		Enable	BE EF	03	06 00	5E F0	01 00	A4 20	01 00
	Get	BE EF	03	06 00	FD F1	02 00	A4 20	00 00	
USB TYPE B SOUND ENABLE	Set	Disable	BE EF	03	06 00	32 F0	01 00	A5 20	00 00
		Enable	BE EF	03	06 00	A2 F1	01 00	A5 20	01 00
	Get	BE EF	03	06 00	01 F0	02 00	A5 20	00 00	
HDMI AUDIO	Set	1	BE EF	03	06 00	AE C6	01 00	40 20	01 00
		2	BE EF	03	06 00	5E C6	01 00	40 20	02 00
	Get	BE EF	03	06 00	0D C7	02 00	40 20	00 00	

RS-232C Communication / Network command table (continued)

Names	Operation Type	Header				Command Data			
						CRC	Action	Type	Setting code
MIC LEVEL	Set	LOW	BE EF	03	06 00	02 F1	01 00	A1 20	00 00
		HIGH	BE EF	03	06 00	92 F0	01 00	A1 20	01 00
	Get	BE EF	03	06 00	31 F1	02 00	A1 20	00 00	
MIC VOLUME	Get	BE EF	03	06 00	75 F1	02 00	A2 20	00 00	
	Increment	BE EF	03	06 00	13 F1	04 00	A2 20	00 00	
	Decrement	BE EF	03	06 00	C2 F0	05 00	A2 20	00 00	
LANGUAGE	Set	ENGLISH	BE EF	03	06 00	F7 D3	01 00	05 30	00 00
		FRANÇAIS	BE EF	03	06 00	67 D2	01 00	05 30	01 00
		DEUTSCH	BE EF	03	06 00	97 D2	01 00	05 30	02 00
		ESPAÑOL	BE EF	03	06 00	07 D3	01 00	05 30	03 00
		ITALIANO	BE EF	03	06 00	37 D1	01 00	05 30	04 00
		NORSK	BE EF	03	06 00	A7 D0	01 00	05 30	05 00
		NEDERLANDS	BE EF	03	06 00	57 D0	01 00	05 30	06 00
		PORTUGUÊS	BE EF	03	06 00	C7 D1	01 00	05 30	07 00
		日本語	BE EF	03	06 00	37 D4	01 00	05 30	08 00
		简体中文	BE EF	03	06 00	A7 D5	01 00	05 30	09 00
		繁體中文	BE EF	03	06 00	37 DE	01 00	05 30	10 00
		한글	BE EF	03	06 00	57 D5	01 00	05 30	0A 00
		SVENSKA	BE EF	03	06 00	C7 D4	01 00	05 30	0B 00
		РУССКИЙ	BE EF	03	06 00	F7 D6	01 00	05 30	0C 00
		SUOMI	BE EF	03	06 00	67 D7	01 00	05 30	0D 00
		POLSKI	BE EF	03	06 00	97 D7	01 00	05 30	0E 00
		TÜRKÇE	BE EF	03	06 00	07 D6	01 00	05 30	0F 00
		DANSK	BE EF	03	06 00	A7 DF	01 00	05 30	11 00
		ČESKY	BE EF	03	06 00	57 DF	01 00	05 30	12 00
		MAGYAR	BE EF	03	06 00	C7 DE	01 00	05 30	13 00
		ROMÂNĂ	BE EF	03	06 00	F7 DC	01 00	05 30	14 00
		SLOVENSKI	BE EF	03	06 00	67 DD	01 00	05 30	15 00
		HRVATSKI	BE EF	03	06 00	97 DD	01 00	05 30	16 00
		ΕΛΛΗΝΙΚΑ	BE EF	03	06 00	07 DC	01 00	05 30	17 00
		LIETUVIŲ	BE EF	03	06 00	F7 D9	01 00	05 30	18 00
		EESTI	BE EF	03	06 00	67 D8	01 00	05 30	19 00
		LATVIEŠU	BE EF	03	06 00	97 D8	01 00	05 30	1A 00
		ไทย	BE EF	03	06 00	07 D9	01 00	05 30	1B 00
		ةببرعلا ةغللا	BE EF	03	06 00	37 DB	01 00	05 30	1C 00
		اىسراف	BE EF	03	06 00	A7 DA	01 00	05 30	1D 00
		PORTUGUÊS BRA	BE EF	03	06 00	57 DA	01 00	05 30	1E 00
		Get	BE EF	03	06 00	C4 D3	02 00	05 30	00 00
NOTE) Not all of the languages in this table are supported.									
MENU POSITION H	Get	BE EF	03	06 00	04 D7	02 00	15 30	00 00	
	Increment	BE EF	03	06 00	62 D7	04 00	15 30	00 00	
	Decrement	BE EF	03	06 00	B3 D6	05 00	15 30	00 00	
MENU POSITION H Reset	Execute	BE EF	03	06 00	DC C6	06 00	43 70	00 00	
MENU POSITION V	Get	BE EF	03	06 00	40 D7	02 00	16 30	00 00	
	Increment	BE EF	03	06 00	26 D7	04 00	16 30	00 00	
	Decrement	BE EF	03	06 00	F7 D6	05 00	16 30	00 00	

RS-232C Communication / Network command table (continued)

Names	Operation Type	Header			Command Data				
					CRC	Action	Type	Setting code	
MENU POSITION V Reset	Execute	BE EF	03	06 00	A8 C7	06 00	44 70	00 00	
BLANK	Set	MyScreen	BE EF	03	06 00	FB CA	01 00	00 30	20 00
		ORIGINAL	BE EF	03	06 00	FB E2	01 00	00 30	40 00
		BLUE	BE EF	03	06 00	CB D3	01 00	00 30	03 00
		WHITE	BE EF	03	06 00	6B D0	01 00	00 30	05 00
		BLACK	BE EF	03	06 00	9B D0	01 00	00 30	06 00
	Get	BE EF	03	06 00	08 D3	02 00	00 30	00 00	
BLANK On/Off	Set	OFF	BE EF	03	06 00	FB D8	01 00	20 30	00 00
		ON	BE EF	03	06 00	6B D9	01 00	20 30	01 00
	Get	BE EF	03	06 00	C8 D8	02 00	20 30	00 00	
START UP	Set	MyScreen	BE EF	03	06 00	CB CB	01 00	04 30	20 00
		ORIGINAL	BE EF	03	06 00	0B D2	01 00	04 30	00 00
		OFF	BE EF	03	06 00	9B D3	01 00	04 30	01 00
	Get	BE EF	03	06 00	38 D2	02 00	04 30	00 00	
MyScreen Lock	Set	OFF	BE EF	03	06 00	3B EF	01 00	C0 30	00 00
		ON	BE EF	03	06 00	AB EE	01 00	C0 30	01 00
	Get	BE EF	03	06 00	08 EF	02 00	C0 30	00 00	
MESSAGE	Set	OFF	BE EF	03	06 00	8F D6	01 00	17 30	00 00
		ON	BE EF	03	06 00	1F D7	01 00	17 30	01 00
	Get	BE EF	03	06 00	BC D6	02 00	17 30	00 00	
TEMPLATE	Set	TEST PATTERN	BE EF	03	06 00	43 D9	01 00	22 30	00 00
		DOT-LINE1	BE EF	03	06 00	D3 D8	01 00	22 30	01 00
		DOT-LINE2	BE EF	03	06 00	23 D8	01 00	22 30	02 00
		DOT-LINE3	BE EF	03	06 00	B3 D9	01 00	22 30	03 00
		DOT-LINE4	BE EF	03	06 00	83 DB	01 00	22 30	04 00
		CIRCLE 1	BE EF	03	06 00	13 DA	01 00	22 30	05 00
		CIRCLE 2	BE EF	03	06 00	E3 DA	01 00	22 30	06 00
		MAP 1	BE EF	03	06 00	83 D4	01 00	22 30	10 00
	MAP 2	BE EF	03	06 00	13 D5	01 00	22 30	11 00	
	Get	BE EF	03	06 00	70 D9	02 00	22 30	00 00	
TEMPLATE On/Off	Set	OFF	BE EF	03	06 00	BF D8	01 00	23 30	00 00
		ON	BE EF	03	06 00	2F D9	01 00	23 30	01 00
	Get	BE EF	03	06 00	8C D8	02 00	23 30	00 00	
C. C. - DISPLAY	Set	OFF	BE EF	03	06 00	FA 62	01 00	00 37	00 00
		ON	BE EF	03	06 00	6A 63	01 00	00 37	01 00
		AUTO	BE EF	03	06 00	9A 63	01 00	00 37	02 00
	Get	BE EF	03	06 00	C9 62	02 00	00 37	00 00	
C. C. - MODE	Set	CAPTIONS	BE EF	03	06 00	06 63	01 00	01 37	00 00
		TEXT	BE EF	03	06 00	96 62	01 00	01 37	01 00
	Get	BE EF	03	06 00	35 63	02 00	01 37	00 00	
C. C. - CHANNEL	Set	1	BE EF	03	06 00	D2 62	01 00	02 37	01 00
		2	BE EF	03	06 00	22 62	01 00	02 37	02 00
		3	BE EF	03	06 00	B2 63	01 00	02 37	03 00
		4	BE EF	03	06 00	82 61	01 00	02 37	04 00
	Get	BE EF	03	06 00	71 63	02 00	02 37	00 00	
AUTO SEARCH	Set	OFF	BE EF	03	06 00	B6 D6	01 00	16 20	00 00
		ON	BE EF	03	06 00	26 D7	01 00	16 20	01 00
	Get	BE EF	03	06 00	85 D6	02 00	16 20	00 00	

RS-232C Communication / Network command table (continued)

Names	Operation Type	Header				Command Data			
						CRC	Action	Type	Setting code
AUTO KEYSTONE	Set	OFF	BE EF	03	06 00	EA D1	01 00	0F 20	00 00
		ON	BE EF	03	06 00	7A D0	01 00	0F 20	01 00
	Get	BE EF	03	06 00	D9 D1	02 00	0F 20	00 00	
DIRECT POWER ON	Set	OFF	BE EF	03	06 00	3B 89	01 00	20 31	00 00
		ON	BE EF	03	06 00	AB 88	01 00	20 31	01 00
	Get	BE EF	03	06 00	08 89	02 00	20 31	00 00	
AUTO POWER OFF	Get	BE EF	03	06 00	08 86	02 00	10 31	00 00	
	Increment	BE EF	03	06 00	6E 86	04 00	10 31	00 00	
	Decrement	BE EF	03	06 00	BF 87	05 00	10 31	00 00	
USB TYPE B	Set	MOUSE	BE EF	03	06 00	FF 23	01 00	50 26	00 00
		USB DISPLAY	BE EF	03	06 00	6F 22	01 00	50 26	01 00
	Get	BE EF	03	06 00	CC 23	02 00	50 26	00 00	
LAMP TIME	Get	BE EF	03	06 00	C2 FF	02 00	90 10	00 00	
LAMP TIME Reset	Execute	BE EF	03	06 00	58 DC	06 00	30 70	00 00	
FILTER TIME	Get	BE EF	03	06 00	C2 F0	02 00	A0 10	00 00	
FILTER TIME Reset	Execute	BE EF	03	06 00	98 C6	06 00	40 70	00 00	
MY BUTTON-1	Set	COMPUTER IN1	BE EF	03	06 00	3A 33	01 00	00 36	00 00
		COMPUTER IN2	BE EF	03	06 00	FA 31	01 00	00 36	04 00
		LAN	BE EF	03	06 00	0A 34	01 00	00 36	0B 00
		USB TYPE A	BE EF	03	06 00	9A 30	01 00	00 36	06 00
		USB TYPE B	BE EF	03	06 00	3A 36	01 00	00 36	0C 00
		HDMI	BE EF	03	06 00	CA 33	01 00	00 36	03 00
		COMPONENT	BE EF	03	06 00	6A 30	01 00	00 36	05 00
		S-VIDEO	BE EF	03	06 00	5A 32	01 00	00 36	02 00
		VIDEO	BE EF	03	06 00	AA 32	01 00	00 36	01 00
		SLIDESHOW	BE EF	03	06 00	9A 2B	01 00	00 36	22 00
		MY IMAGE	BE EF	03	06 00	5A 3D	01 00	00 36	16 00
		MESSENGER	BE EF	03	06 00	AA 29	01 00	00 36	25 00
		INFORMATION	BE EF	03	06 00	FA 3E	01 00	00 36	10 00
		AUTO KEYSTONE V	BE EF	03	06 00	6A 3F	01 00	00 36	11 00
		MY MEMORY	BE EF	03	06 00	9A 3F	01 00	00 36	12 00
		ACTIVE IRIS	BE EF	03	06 00	AA 3D	01 00	00 36	15 00
		PICTURE MODE	BE EF	03	06 00	0A 3E	01 00	00 36	13 00
		FILTER RESET	BE EF	03	06 00	3A 3C	01 00	00 36	14 00
		AV MUTE	BE EF	03	06 00	AA 38	01 00	00 36	19 00
		TEMPLATE	BE EF	03	06 00	CA 39	01 00	00 36	1B 00
	RESOLUTION	BE EF	03	06 00	9A 3A	01 00	00 36	1E 00	
MIC VOLUME	BE EF	03	06 00	9A 24	01 00	00 36	36 00		
ECO MODE	BE EF	03	06 00	0A 25	01 00	00 36	37 00		
Get	BE EF	03	06 00	09 33	02 00	00 36	00 00		

RS-232C Communication / Network command table (continued)

Names	Operation Type	Header				Command Data			
						CRC	Action	Type	Setting code
MY BUTTON-2	Set	COMPUTER IN1	BE EF	03	06 00	C6 32	01 00	01 36	00 00
		COMPUTER IN2	BE EF	03	06 00	06 30	01 00	01 36	04 00
		LAN	BE EF	03	06 00	F6 35	01 00	01 36	0B 00
		USB TYPE A	BE EF	03	06 00	66 31	01 00	01 36	06 00
		USB TYPE B	BE EF	03	06 00	C6 37	01 00	01 36	0C 00
		HDMI	BE EF	03	06 00	36 32	01 00	01 36	03 00
		COMPONENT	BE EF	03	06 00	96 31	01 00	01 36	05 00
		S-VIDEO	BE EF	03	06 00	A6 33	01 00	01 36	02 00
		VIDEO	BE EF	03	06 00	56 33	01 00	01 36	01 00
		SLIDESHOW	BE EF	03	06 00	66 2A	01 00	01 36	22 00
		MY IMAGE,	BE EF	03	06 00	A6 3C	01 00	01 36	16 00
		MESSENGER	BE EF	03	06 00	56 28	01 00	01 36	25 00
		INFORMATION	BE EF	03	06 00	06 3F	01 00	01 36	10 00
		AUTO KEYSTONE V	BE EF	03	06 00	96 3E	01 00	01 36	11 00
		MY MEMORY	BE EF	03	06 00	66 3E	01 00	01 36	12 00
		ACTIVE IRIS	BE EF	03	06 00	56 3C	01 00	01 36	15 00
		PICTURE MODE	BE EF	03	06 00	F6 3F	01 00	01 36	13 00
		FILTER RESET	BE EF	03	06 00	C6 3D	01 00	01 36	14 00
		AV MUTE	BE EF	03	06 00	56 39	01 00	01 36	19 00
	TEMPLATE	BE EF	03	06 00	36 38	01 00	01 36	1B 00	
RESOLUTION	BE EF	03	06 00	66 3B	01 00	01 36	1E 00		
MIC VOLUME	BE EF	03	06 00	66 25	01 00	01 36	36 00		
ECO MODE	BE EF	03	06 00	F6 24	01 00	01 36	37 00		
	Get	BE EF	03	06 00	F5 32	02 00	01 36	00 00	
MY SOURCE	Set	COMPUTER IN1	BE EF	03	06 00	FA 38	01 00	20 36	00 00
		COMPUTER IN2	BE EF	03	06 00	3A 3A	01 00	20 36	04 00
		LAN	BE EF	03	06 00	CA 3F	01 00	20 36	0B 00
		USB TYPE A	BE EF	03	06 00	5A 3B	01 00	20 36	06 00
		USB TYPE B	BE EF	03	06 00	FA 3D	01 00	20 36	0C 00
		HDMI	BE EF	03	06 00	0A 38	01 00	20 36	03 00
		COMPONENT	BE EF	03	06 00	AA 3B	01 00	20 36	05 00
		S-VIDEO	BE EF	03	06 00	9A 39	01 00	20 36	02 00
		VIDEO	BE EF	03	06 00	6A 39	01 00	20 36	01 00
		Get	BE EF	03	06 00	C9 38	02 00	20 36	00 00
REMOTE FREQ. NORMAL	Set	OFF	BE EF	03	06 00	FF 3D	01 00	30 26	00 00
		ON	BE EF	03	06 00	6F 3C	01 00	30 26	01 00
	Get	BE EF	03	06 00	CC 3D	02 00	30 26	00 00	
REMOTE FREQ. HIGH	Set	OFF	BE EF	03	06 00	03 3C	01 00	31 26	00 00
		ON	BE EF	03	06 00	93 3D	01 00	31 26	01 00
	Get	BE EF	03	06 00	30 3C	02 00	31 26	00 00	

RS-232C Communication / Network command table (continued)

Names	Operation Type	Header			Command Data				
					CRC	Action	Type	Setting code	
MY IMAGE	Set	OFF	BE EF	03	06 00	3A C3	01 00	00 35	00 00
		IMAGE-1	BE EF	03	06 00	AA C2	01 00	00 35	01 00
		IMAGE-2	BE EF	03	06 00	5A C2	01 00	00 35	02 00
		IMAGE-3	BE EF	03	06 00	CA C3	01 00	00 35	03 00
	IMAGE-4	BE EF	03	06 00	FA C1	01 00	00 35	04 00	
	Get	BE EF	03	06 00	09 C3	02 00	00 35	00 00	
MY IMAGE IMAGE-1 Delete	Execute	BE EF	03	06 00	71 C3	06 00	01 35	00 00	
MY IMAGE IMAGE-2 Delete	Execute	BE EF	03	06 00	35 C3	06 00	02 35	00 00	
MY IMAGE IMAGE-3 Delete	Execute	BE EF	03	06 00	C9 C2	06 00	03 35	00 00	
MY IMAGE IMAGE-4 Delete	Execute	BE EF	03	06 00	BD C3	06 00	04 35	00 00	

PJLink command

Commands	Control Description	Parameter or Response
POWR	Power Control	0 = Standby 1 = Power On
POWR ?	Power Status inquiry	0 = Standby 1 = Power On 2 = Cool Down
INPT	Input Source selection	11 = COMPUTER IN 1 12 = COMPUTER IN 2 21 = COMPONENT 22 = S-VIDEO 23 = VIDEO 31 = HDMI 41 = USB TYPE A 51 = LAN 52 = USB TYPE B
INPT ?	Input Source inquiry	11 = COMPUTER IN 1 12 = COMPUTER IN 2 21 = COMPONENT 22 = S-VIDEO 23 = VIDEO 31 = HDMI 41 = USB TYPE A 51 = LAN 52 = USB TYPE B
AVMT	AV Mute	10 = BLANK off 11 = BLANK on 20 = Mute off 21 = Mute on 30 = AV Mute off 31 = AV Mute on
AVMT ?	AV Mute inquiry	10 = BLANK off 11 = BLANK on 20 = Mute off 21 = Mute on 30 = AV Mute off 31 = AV Mute on

(continued on next page)

PJLink command (continued)

Commands	Control Description	Parameter or Response
ERST ?	Error Status inquiry	1st byte: Refers to Fan error; one of 0 to 2 2nd byte: Refers to Lamp error; one of 0 to 2 3rd byte: Refers to Temperature error; one of 0 to 2 4th byte: Refers to Cover error; one of 0 to 2 5th byte: Refers to Filter error; one of 0 to 2 6th byte: Refers to Other error; one of 0 to 2 The meaning of 0 to 2 is as given below 0 = Error is not detected; 1 = Warning; 2 = Error
LAMP ?	Lamp Status inquiry	1st number (digits 1 to 5): Lamp Time 2nd number : 0 = Lamp off, 1 = Lamp on
INST ?	Input Source List inquiry	11 12 21 22 23 31 41 51 52
NAME ?	Projector Name inquiry	Responds with the name set in "PROJECTOR NAME" or "NETWORK"
INF1 ?	Manufacturer's Name inquiry	HITACHI
INF2 ?	Model Name inquiry	CP-X2514WN CP-X3014WN CP-X4014WN CP-WX3014WN
INFO ?	Other Information inquiry	Responds with the factory information and so on
CLSS ?	Class Information inquiry	1

NOTE • The password used in PJLink™ is the same as the password set in the Web Browser Control. To use PJLink™ without authentication, do not set any password in Web Browser Control.

• For specifications of PJLink™, see the web site of the Japan Business Machine and Information System Industries Association.

URL: <http://pjlink.jbmia.or.jp/> (as of Feb. 2011)

Projector

CP-X2514WN/CP-X3014WN/ CP-X4014WN/CP-WX3014WN User's Manual (concise)

Thank you for purchasing this projector.

Please read through this manual before using this product, in order to use safely and utilize well the product.

- ⚠ WARNING** ▶ Before using this product, be sure to read all manuals for this product. After reading them, store them in a safe place for future reference.
- ▶ Heed all the warnings and cautions in the manuals or on the product.
 - ▶ Follow all the instructions in the manuals or on the product.

NOTE • In this manual, unless any comments are accompanied, “the manuals” means all the documents provided with this product, and “the product” means this projector and all the accessories came with the projector.

Contents

First of all 2	Connecting power supply 8
Entries and graphical symbols explanation 2	Turning on the power..... 9
Important safety instruction 2	Adjusting the projector's elevator 10
Regulatory notices 3	Displaying the picture 11
About Electro-Magnetic Interference 3	Turning off the power..... 12
About Waste Electrical and Electronic Equipment... 4	Replacing the lamp..... 13
Contents of package..... 4	Cleaning and replacing the air filter .. 15
Preparing for the remote control..... 5	Using the CD manual 16
Arrangement..... 6	Specifications 17
Connecting with your devices..... 7	Troubleshooting
Fastening the adapter cover..... 8	- Warranty and after-service 18

First of all

Entries and graphical symbols explanation

The following entries and graphical symbols are used for the manuals and the product as follows, for safety purpose. Please know their meanings beforehand, and heed them.

- ⚠ **WARNING** This entry warns of a risk of serious personal injury or even death.
- ⚠ **CAUTION** This entry warns of a risk of personal injury or physical damage.
- NOTICE** This entry notices of fear of causing trouble.

Important safety instruction

The followings are important instructions for safely using the product. Be sure to follow them always when handling the product. The manufacturer assumes no responsibility for any damage caused by mishandling that is beyond normal usage defined in these manuals of this projector.

- ⚠ **WARNING** ▶ Never use the product in or after an abnormality (ex. giving off smoke, smelling strange, took a liquid or an object inside, broken, etc.) If an abnormality should occur, unplug the projector urgently.
- ▶ Situate the product away from children and pets.
- ▶ Keep small parts away from children and pets. If swallowed, consult a physician immediately for emergency treatment.
- ▶ Do not use the product when there is fear of a thunderbolt.
- ▶ Unplug the projector from the power outlet if the projector is not used for the time being.
- ▶ Do not open or remove any portion of the product, unless the manuals direct it. For internal maintenance, leave it to your dealer or their service personnel.
- ▶ Use only the accessories specified or recommended by the manufacturer.
- ▶ Do not modify the projector or accessories.
- ▶ Do not let any things or any liquids enter to the inside of the product.
- ▶ Do not wet the product.
- ▶ Do not place the projector where any oils, such as cooking or machine oil, are used. Oil may harm the product, resulting in malfunction, or falling from the mounted position.
- ▶ Do not apply a shock or pressure to this product.
- Do not place the product on an unstable place such as the uneven surface or the leaned table.
- Do not place the product unstably. Place the projector so that it does not protrude from the surface where the projector is placed on.
- Remove all the attachments including the power cord and cables, from the projector when carrying the projector.
- ▶ Do not look into the lens and the openings on the projector, while the lamp is on.
- ▶ Do not approach the lamp cover and the exhaust vents, while the projection lamp is on. Also after the lamp goes out, do not approach them for a while, since too hot.

Regulatory notices

About Electro-Magnetic Interference

In CANADA

This Class B digital apparatus complies with Canadian ICES-003.

In the US, and other places where the FCC regulations are applicable

Declaration of Conformity

Trade name	HITACHI
Model Number	CP-X2514WN, CP-X3014WN, CP-X4014WN, CP-WX3014WN
Responsible Party	Hitachi America, Ltd.
Address	900 Hitachi way, Chula Vista, CA 91914-3556 U.S.A.
Telephone Number	+1 -800-225-1741

This device complies with part 15 of the FCC Rules. Operation is subject to the following two conditions: (1) This device may not cause harmful interference, and (2) this device must accept any interference received, including interference that may cause undesired operation. This equipment has been tested and found to comply with the limits for a Class B digital device, pursuant to Part 15 of the FCC Rules.

These limits are designed to provide reasonable protection against harmful interference in a residential installation. This equipment generates, uses, and can radiate radio frequency energy and, if not installed and used in accordance with the instructions, may cause harmful interference to radio communications. However, there is no guarantee that interference will not occur in a particular installation. If this equipment does cause harmful interference to radio or television reception, which can be determined by turning the equipment off and on, the user is encouraged to try to correct the interference by one or more of the following measures:

- Reorient or relocate the receiving antenna.
- Increase the separation between the equipment and receiver.
- Connect the equipment into an outlet on a circuit different from that to which the receiver is connected.
- Consult the dealer or an experienced radio/TV technician for help.

INSTRUCTIONS TO USERS: This equipment complies with the requirements of FCC (Federal Communication Commission) equipment provided that the following conditions are met. Some cables have to be used with the core set. Use the accessory cable or a designated-type cable for the connection. For cables that have a core only at one end, connect the core to the projector.

CAUTION: Changes or modifications not expressly approved by the party responsible for compliance could void the user's authority to operate the equipment.

Regulatory notices (continued)

About Waste Electrical and Electronic Equipment



The mark is in compliance with the Waste Electrical and Electronic Equipment Directive 2002/96/EC (WEEE).

The mark indicates the requirement NOT to dispose the equipment including any spent or discarded batteries or accumulators as unsorted municipal waste, but use the return and collection systems available. If the batteries or accumulators included with this equipment, display the chemical symbol Hg, Cd, or Pb, then it means that the battery has a heavy metal content of more than 0.0005% Mercury or more than, 0.002% Cadmium, or more than 0.004% Lead.

Contents of package

Your projector should come with the items shown below. Check that all the items are included. Require of your dealer immediately if any items are missing.

- (1) Remote control with two AA batteries
- (2) Power cord
- (3) Computer cable
- (4) Adapter cover
- (5) Lens cover
- (6) User's manuals (Book x1, CD x1)
- (7) Security label
- (8) Application CD

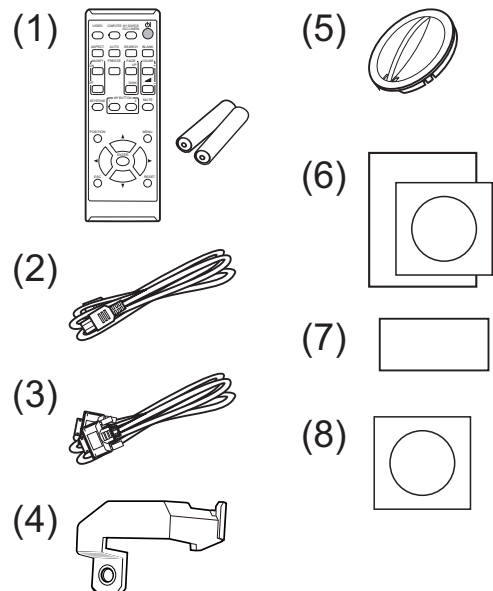

⚠ WARNING ► Keep small parts away from children and pets. Take care not to put in the mouth. If swallowed, consult a physician immediately for emergency treatment.

NOTE • Keep the original packing materials for future reshipment. Be sure to use the original packing materials when moving the projector. Use special caution for the lens.

• The projector may make a rattling sound when tilted, moved or shaken, since a flap to control the air flow inside of the projector has moved. Be aware that this is not a failure or malfunction.

Preparing for the remote control

Please insert the batteries into the remote control before using it. If the remote control starts to malfunction, try to replace the batteries. If you will not use the remote control for long period, remove the batteries from the remote control and store them in a safe place.

1. Holding the hook part of the battery cover, remove it.
2. Align and insert the two AA batteries (HITACHI MAXELL, Part No.LR6 or R6P) according to their plus and minus terminals as indicated in the remote control.
3. Replace the battery cover in the direction of the arrow and snap it back into place.

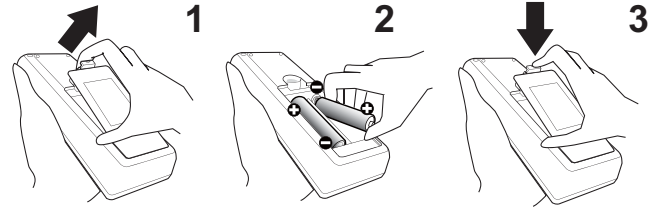

- ⚠ WARNING** ► Always handle the batteries with care and use them only as directed. Improper use may result in battery explosion, cracking or leakage, which could result in fire, injury and/or pollution of the surrounding environment.
- When replacing the batteries, replace both of the batteries with new batteries of the same type. Do not use a new battery with a used battery.
 - Be sure to use only the batteries specified. Do not use batteries of different types at the same time. Do not mix a new battery with used one.
 - Make sure the plus and minus terminals are correctly aligned when loading a battery.
 - Keep a battery away from children and pets.
 - Do not recharge, short circuit, solder or disassemble a battery.
 - Do not place a battery in a fire or water. Keep batteries in a dark, cool and dry place.
 - If you observe battery leakage, wipe out the leakage and then replace a battery. If the leakage adheres to your body or clothes, rinse well with water immediately.
 - Obey the local laws on disposing the battery.

Arrangement

Refer to tables **T-1** and **T-2** at the back of this manual as well as the following to determine the screen size and projection distance. The values shown in the table are calculated for a full size screen.

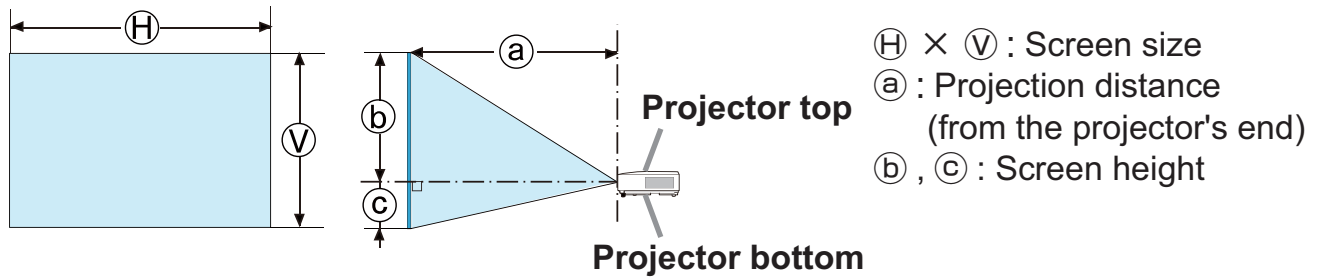

⚠ WARNING ▶ Install the projector where you can access the power outlet easily.

- ▶ Install the projector in a stable horizontal position.
- Do not use any mounting accessories except the accessories specified by the manufacturer. Read and keep the manuals of the accessories used.
- For special installation such as ceiling mounting, be sure to consult your dealer beforehand. Specific mounting accessories and services may be required.
- Do not put the projector on its side, front or rear position.
- Do not attach nor place anything on the projector unless otherwise specified in the manual.
- ▶ Do not install the projector near thermally conductive or flammable things.
- ▶ Do not place the projector where any oils, such as cooking or machine oil, are used.
- ▶ Do not place the projector in a place where it may get wet.

⚠ CAUTION ▶ Place the projector in a cool place with sufficient ventilation.

- Keep a space of 30 cm or more between a side of the projector and other objects such as walls.
- Do not stop up, block nor cover the projector's vent holes.
- Do not place the projector at places that are exposed to magnetic fields, doing so can cause the cooling fans inside the projector to malfunction.
- ▶ Avoid placing the projector in smoky, humid or dusty place.
- Do not place the projector near humidifiers.

NOTICE ▶ Position the projector to prevent light from directly hitting the projector's remote sensor.

- ▶ Do not place the product in a place where radio interference may be caused.
- ▶ Check and correct the setting for FAN SPEED of SERVICE in the OPTION menu according to the usage environment. For details, see **User's Manual - Operating Guide**.

Connecting with your devices

Before connecting the projector to a device, consult the manual of the device to confirm that the device is suitable for connecting with this projector and prepare the required accessories, such as a cable in accord with the signal of the device. Consult your dealer when the required accessory did not come with the product or the accessory is damaged.

After making sure that the projector and the devices are turned off, perform the connection, according to the following instructions. Refer to figures **F-1** to **F-4** at the back of this manual.

For details, see **User's Manual - Operating Guide**. Before connecting the projector to a network system, be sure to read **User's Manual - Network Guide** too.

⚠ **WARNING** ▶ Use only the appropriate accessories. Otherwise it could cause a fire or damage the projector and devices.

- Use only the accessories specified or recommended by the projector's manufacturer. It may be regulated under some standard.
- Neither disassemble nor modify the projector and the accessories.
- Do not use the damaged accessory. Be careful not to damage the accessories. Route a cable so that it is neither stepped on nor pinched out.

⚠ **CAUTION** ▶ For a cable with a core at only one end, connect the end with the core to the projector. That may be required by EMI regulations.

▶ Before connecting the projector to a network system be sure to obtain the consent of the administrator of the network.

▶ Do not connect the **LAN** port to any network that might have the excessive voltage.

▶ The designated USB wireless adapter that is sold as an option is required to use the wireless network function of this projector.

▶ Before removing the USB storage device from the port of the projector, be sure to use the REMOVE USB function on the thumbnail screen to secure your data. Before you insert or pull out the USB wireless adapter from the projector, turn off the power of the projector and pull out the power cord's plug from the outlet. Do not touch the USB wireless adapter while the projector is receiving AC power.

NOTE • Do not turn on or off the projector while connected to a device in operation, unless that is directed in the manual of the device.

- Some input ports are selectable in the use. For details, see **User's Manual - Operating Guide**.
- Be careful not to mistakenly connect a connector to a wrong port.
- If an oversized USB storage device blocks the **LAN** port, use a USB extension cable to connect the USB storage device.
- If a loud feedback noise is produced from the speaker, move the microphone away from the speaker.
- This projector doesn't support plug-in power for the microphone.

Fastening the adapter cover

Use the supplied adapter cover to prevent the USB wireless adapter from coming off easily.

1. Loosen the screw (marked with triangle) on the bottom left of the **USB TYPE A** port.
2. Insert the tab of the cover into the hole at the upper right of the **USB TYPE A** port in the direction of the arrow.
3. Align the screw holes on the projector and the cover. Then insert the screw removed from the projector into the hole and tighten the screw.

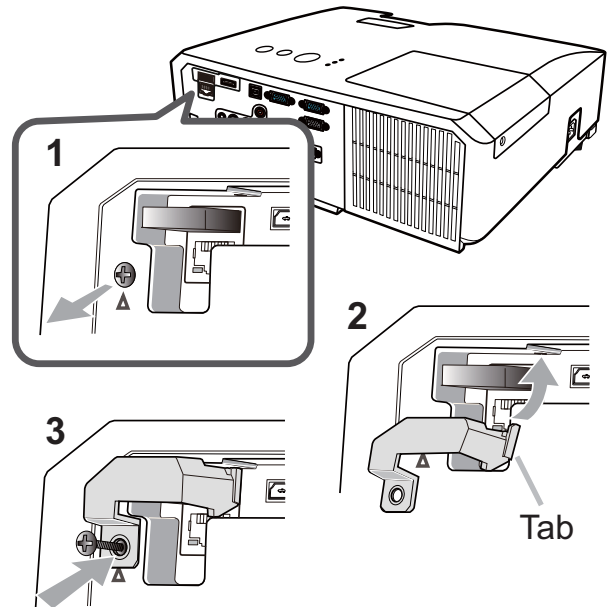

⚠ WARNING ► Keep small parts away from children and pets. Take care not to put in the mouth.

Connecting power supply

1. Put the connector of the power cord into the **AC IN** (AC inlet) of the projector.
2. Firmly plug the power cord's plug into the outlet. In a couple of seconds after the power supply connection, the **POWER** indicator will light up in steady orange.

Please remember that when the DIRECT POWER ON function activated, the connection of the power supply make the projector turn on.

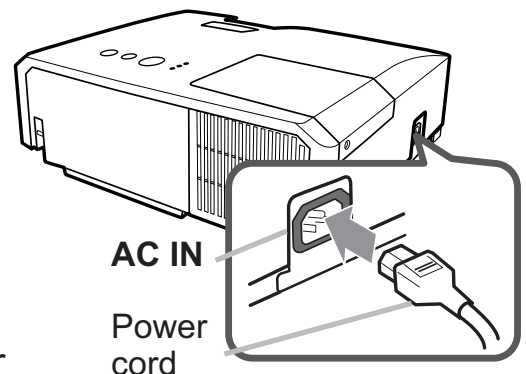

⚠ WARNING ► Please use extra caution when connecting the power cord, as incorrect or faulty connections may result in fire and/or electrical shock.

- Do not touch the power cord with a wet hand.
- Only use the power cord that came with the projector. If it is damaged, consult your dealer to get a new one. Never modify the power cord.
- Only plug the power cord into an outlet whose voltage is matched to the power cord. The power outlet should be close to the projector and easily accessible. Remove the power cord for complete separation.
- Do not distribute the power supply to multiple devices. Doing so may overload the outlet and connectors, loosen the connection, or result in fire, electric shock or other accidents.
- Connect the ground terminal for the AC inlet of this unit to the ground terminal of the building using an appropriate power cord (bundled).

NOTICE ► This product is also designed for IT power systems with a phase-to-phase voltage of 220 to 240 V.

Turning on the power

1. Make sure that the power cord is firmly and correctly connected to the projector and the outlet.
2. Make sure that the **POWER** indicator is steady orange. Then remove the lens cover.
3. Press the **STANDBY/ON** button on the projector or the remote control.

The projection lamp will light up and the **POWER** indicator will begin blinking in green. When the power is completely on, the indicator will stop blinking and light in steady green.

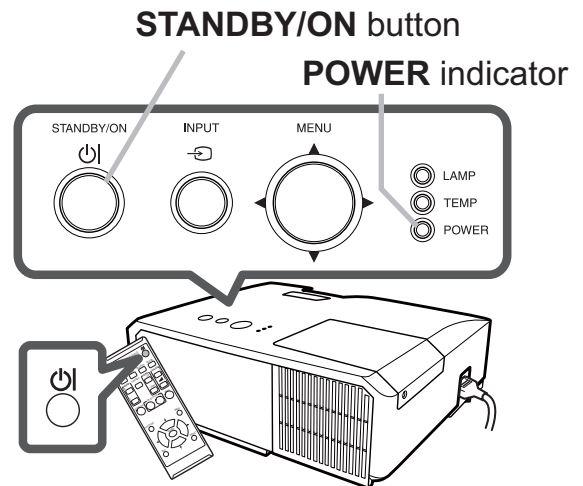

⚠ WARNING ► A strong light is emitted when the projector's power is on. Do not look into the lens of the projector or look inside of the projector through any of the projector's openings.

NOTE • Please power on the projector prior to the connected devices.
 • The projector has the DIRECT POWER ON function, which can make the projector automatically turn on. For more information, please see **User's Manual - Operating Guide**.

Adjusting the projector's elevator

When the place to put the projector is slightly uneven to the left or right, use the elevator feet to place the projector horizontally. Using the feet can also tilt the projector in order to project at a suitable angle to the screen, elevating the front side of the projector within 14 degrees. This projector has 2 elevator feet and 2 elevator buttons. An elevator foot is adjustable while pushing the elevator button on the same side as it.

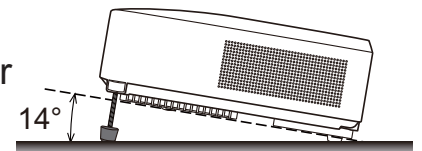

1. Holding the projector, push the elevator buttons to loose the elevator feet.
2. Position the front side of the projector to the desired height.
3. Release the elevator buttons in order to lock the elevator feet.
4. After making sure that the elevator feet are locked, put the projector down gently.
5. If necessary, the elevator feet can be manually twisted to make more precise adjustments. Hold the projector when twisting the feet.

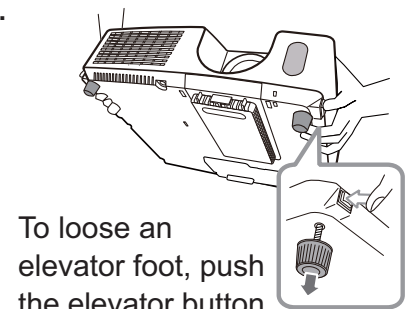

To loose an elevator foot, push the elevator button on the same side as it.

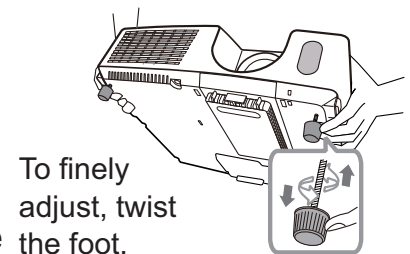

To finely adjust, twist the foot.

- ⚠ CAUTION** ► Do not handle the elevator buttons without holding the projector, since the projector may drop down.
- Do not tilt the projector other than elevating its front within 14 degrees using the adjuster feet. A tilt of the projector exceeding the restriction could cause malfunction or shortening the lifetime of consumables, or the projector itself.

Displaying the picture

1. Activate your signal source. Turn the signal source on, and make it send the signal to the projector.
2. Use the **VOLUME + / VOLUME -** buttons to adjust the volume.
To have the projector silent, press the **MUTE** button on the remote control.
3. Press the **INPUT** button on the projector. Each time you press the button, the projector switches its input port in turn. You can also use the remote control to select an input signal. Press the **VIDEO** button for selecting an input signal from the **HDMI, COMPONENT (Y, Cb/Pb, Cr/Pr), S-VIDEO** or **VIDEO** port, or the **COMPUTER** button for selecting an input signal from the **COMPUTER IN1, COMPUTER IN2, LAN, USB TYPE A** or **USB TYPE B** port.
4. Press the **ASPECT** button on the remote control. Each time you press the button, the projector switches the mode for aspect ratio in turn.
5. Use the **ZOOM** ring to adjust the screen size.
6. Use the **FOCUS** ring to focus the picture.

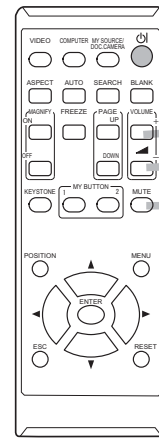

VOLUME+ button
VOLUME- button
MUTE button

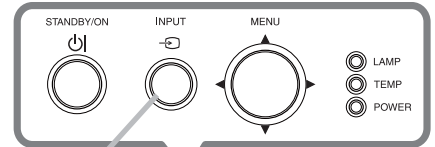

INPUT button

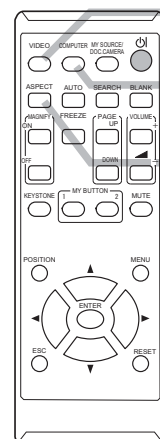
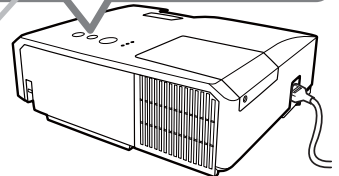

VIDEO button
COMPUTER button
ASPECT button

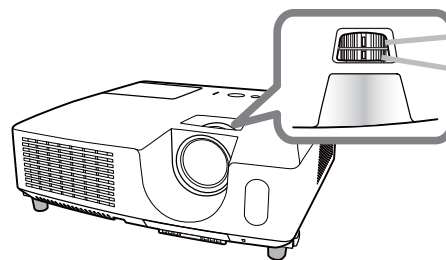

ZOOM ring
FOCUS ring

CAUTION ► If you wish to have a blank screen while the projector's lamp is on, use the **BLANK** function. (see **User's Manual - Operating Guide**) Taking any other action may cause the damage on the projector.

NOTE • The **ASPECT** button does not work when no proper signal is inputted.
• For the details of how to adjust the picture, please see **User's Manual - Operating Guide**.

Turning off the power

1. Press the **STANDBY/ON** button on the projector or the remote control.
The message "Power off?" will appear on the screen for about 5 seconds.
2. Press the **STANDBY/ON** button again while the message appears.
The projector lamp will go off, and the **POWER** indicator will begin blinking in orange. Then the **POWER** indicator will stop blinking and light in steady orange when the lamp cooling is complete.
3. Attach the lens cover, after the **POWER** indicator turns in steady orange.

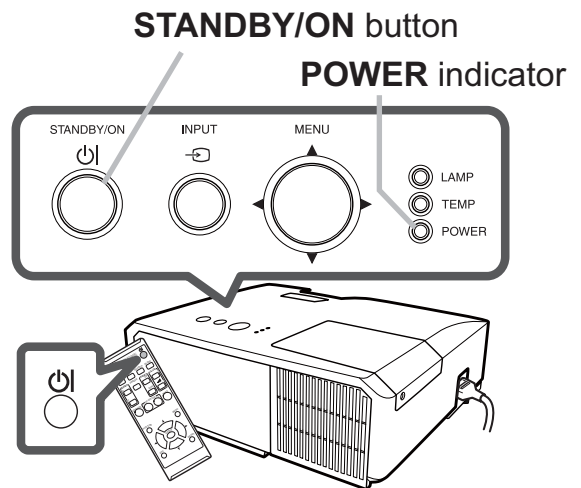

Do not turn the projector on for about 10 minutes or more after turning it off. Also, do not turn the projector off shortly after turning it on. Such operations might cause the lamp to malfunction or shorten the lifetime of some parts including the lamp.

⚠ WARNING ▶ Do not touch around the lamp cover and the exhaust vents during use or just after use, since it is too hot.
▶ Remove the power cord for complete separation. The power outlet should be close to the projector and easily accessible.

NOTE • Please power off the projector after any connected devices are powered off.
• This projector has the AUTO POWER OFF function that can make the projector turn off automatically. For more information, please see **User's Manual - Operating Guide**.

Replacing the lamp

A lamp has finite product life. Using the lamp for long periods of time could cause the pictures darker or the color tone poor. Note that each lamp has a different lifetime, and some may burst or burn out soon after you start using them. Preparation of a new lamp and early replacement are recommended. To prepare a new lamp, make contact with your dealer and tell the lamp type number.

Type number : DT01021

1. Turn the projector off, and unplug the power cord.
 - Allow the projector to cool for at least 45 minutes.
2. Prepare a new lamp. If the projector is mounted on a ceiling, or if the lamp has broken, also ask the dealer to replace the lamp.

In case of replacement by yourself, follow the following procedure.

3. Loosen the screw (marked by arrow) of the lamp cover and then slide and lift the lamp cover to the side to remove it.
4. Loosen the 3 screws (marked by arrow) of the lamp, and slowly pick up the lamp by the handles.

Never loosen any other screws.

5. Insert the new lamp, and retighten firmly the 3 screws of the lamp that are loosened in the previous process to lock it in place.
6. While putting the interlocking parts of the lamp cover and the projector together, slide the lamp cover back in place. Then firmly fasten the screw of the lamp cover.
7. Turn the projector on and reset the lamp time using the LAMP TIME item in the OPTION menu.

- (1) Press the **MENU** button to display a menu.
- (2) Point at the **ADVANCED MENU** in the menu using the ▼/▲ button, then press the ► button.
- (3) Point at the **OPTION** in the left column of the menu using the ▼/▲ button, then press the ► button.
- (4) Point at the **LAMP TIME** using the ▼/▲ button, then press the ► button. A dialog will appear.
- (5) Press the ► button to select "OK" on the dialog. It performs resetting the lamp time.

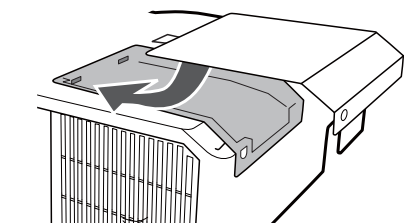
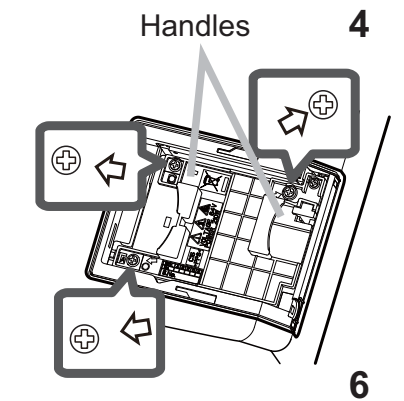
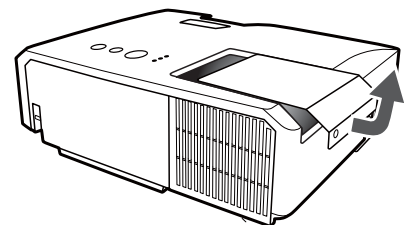
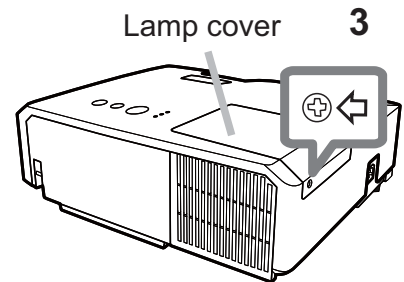

⚠ CAUTION ► Do not touch any inner space of the projector, while the lamp is taken out.

NOTE • Please reset the lamp time only when you have replaced the lamp, for a suitable indication about the lamp.

Replacing the lamp (continued)



HIGH VOLTAGE



HIGH TEMPERATURE



HIGH PRESSURE

⚠ WARNING ► The projector uses a high-pressure mercury glass lamp. The lamp can break with a loud bang, or burn out, if jolted or scratched, handled while hot, or worn over time. Note that each lamp has a different lifetime, and some may burst or burn out soon after you start using them. In addition, if the bulb bursts, it is possible for shards of glass to fly into the lamp housing, and for gas containing mercury and dust containing fine particles of glass to escape from the projector's vent holes.

► **About disposal of a lamp:** This product contains a mercury lamp; do not put it in a trash. Dispose of it in accordance with environmental laws.

- For lamp recycling, go to www.lamprecycle.org (in the US).
- For product disposal, consult your local government agency or www.eiae.org (in the US) or www.epsc.ca (in Canada).

For more information, ask your dealer.



Disconnect
the plug
from the
power
outlet

- If the lamp should break (it will make a loud bang when it does), unplug the power cord from the outlet, and make sure to request a replacement lamp from your local dealer. Note that shards of glass could damage the projector's internals, or cause injury during handling, so please do not try to clean the projector or replace the lamp yourself.

- If the lamp should break (it will make a loud bang when it does), ventilate the room well, and make sure not to inhale the gas or fine particles that come out from the projector's vent holes, and not to get them into your eyes or mouth.

- Before replacing the lamp, turn the projector off and unplug the power cord, then wait at least 45 minutes for the lamp to cool sufficiently. Handling the lamp while hot can cause burns, as well as damaging the lamp.



- Never unscrew except the appointed (marked by an arrow) screws.

- Do not open the lamp cover while the projector is suspended from a ceiling. This is dangerous, since if the lamp's bulb has broken, the shards will fall out when the cover is opened. In addition, working in high places is dangerous, so ask your local dealer to have the lamp replaced even if the bulb is not broken.

- Do not use the projector with the lamp cover removed. At the lamp replacing, make sure that the screws are screwed in firmly. Loose screws could result in damage or injury.



- Use only the lamp of the specified type. Use of a lamp that does not meet the lamp specifications for this model could cause a fire, damage or shorten the life of this product.

- If the lamp breaks soon after the first time it is used, it is possible that there are electrical problems elsewhere besides the lamp. If this happens, consult your local dealer or a service representative.

- Handle with care: jolting or scratching could cause the lamp bulb to burst during use.

- Using the lamp for long periods of time, could cause it dark, not to light up or to burst. When the pictures appear dark, or when the color tone is poor, please replace the lamp as soon as possible. Do not use old (used) lamps; this is a cause of breakage.

Cleaning and replacing the air filter

Please check and clean the air filter periodically. When the indicators or a message prompts you to clean the air filter, comply with it as soon as possible. The air filter has two kinds of filters inside. Replace the filters when they are damaged or too soiled. To prepare the new filters, make contact with your dealer and tell the following type number.

Type number : MU06481 (Filter set)

When you replace the lamp, please replace the air filter. An air filter of specified type will come together with a replacement lamp for this projector.

1. Turn the projector off, and unplug the power cord. Allow the projector to sufficiently cool down.
2. Use a vacuum cleaner on and around the filter cover.
3. While supporting the projector with one hand, use your other hand to pull the filter cover forward in the direction of the arrow.
4. Use a vacuum cleaner for the filter vent of the projector and the outer side of the filter unit.
5. Take the filters out while holding the filter cover.
6. Use a vacuum cleaner on both sides of the filters. When vacuuming up the fine meshed filter, hold it so it will not be sucked in. If the filters are damaged or heavily soiled, replace them with the new ones.
7. Put the filters back into the filter cover. Put the coarse meshed filter into a filter cover first. Then put the fine meshed filter on the coarse meshed one, turning its stitched side up.
8. Put the filter unit back into the projector.
9. Turn the projector on and reset the filter time using the FILTER TIME item in the EASY MENU.
 - (1) Press the **MENU** button to display a menu.
 - (2) Point at the FILTER TIME using the **▼/▲** button, then press the **▶** button. A dialog will appear.
 - (3) Press the **▶** button to select "OK" on the dialog. It performs resetting the filter time.

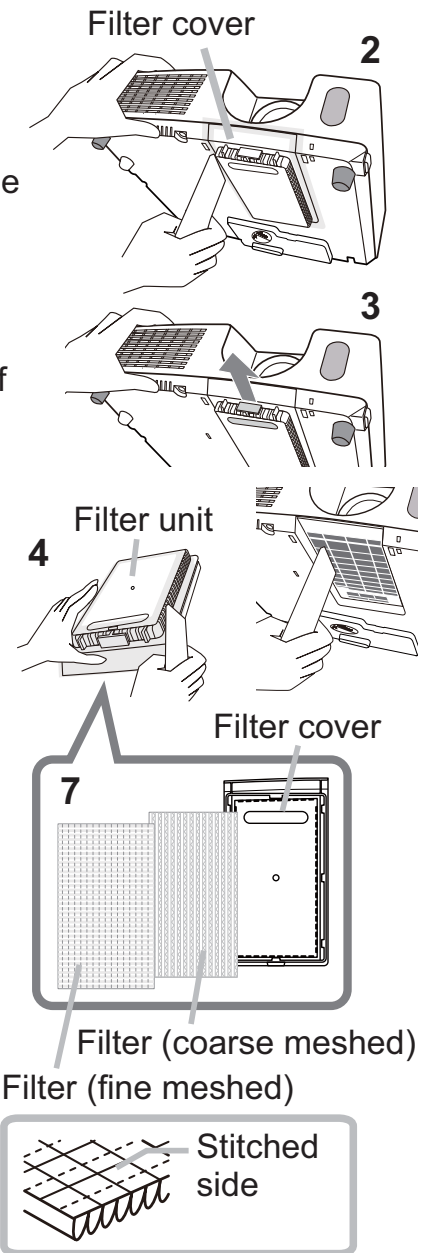

- ⚠ WARNING** ▶ Before taking care of the air filter, make sure the power cable is not plugged in, then allow the projector to cool sufficiently.
- ▶ Use only the air filter of the specified type. Do not use the projector without the air filter or the filter cover. It could result in a fire or malfunction to the projector.
- ▶ Clean the air filter periodically. If the air filter becomes clogged by dust or the like, internal temperatures rise and could cause a fire, a burn or malfunction to the projector.

NOTE • Please reset the filter time only when you have cleaned or replaced the air filter, for a suitable indication about the air filter.

• The projector may display the message such as "CHECK THE AIR FLOW" or turn off the projector, to prevent the internal heat level rising.

Using the CD manual

The other manuals for this product are written into the included CD-ROM titled "User's Manual (detailed)". Before using the CD-ROM, please read the following to ensure the proper use.

■ System requirements

The system for using the CD-ROM requires the following.

Windows®:	OS:Microsoft® Windows® 98, Windows® 98SE, Windows NT®4.0, Windows® Me, Windows® 2000/Windows® XP or later CPU:Pentium® processor 133MHz / Memory:32MB or more
Macintosh®:	OS:Mac OS® 10.2 or later CPU:PowerPC® / Memory:32MB or more
CD-ROM drive:	4x CD-ROM drive
Display:	256 color / 640x480 dots resolution
Applications:	Microsoft® Internet Explorer®4.0 and Adobe® Acrobat® Reader® 4.0 or later

■ How to use the CD

1. Insert CD into computer's CD-ROM drive.

Windows®: In a while, Web browser automatically starts. Start up window comes up.

Macintosh®: (1) Double-click on the "Projectors" icon appeared on the desktop screen.
(2) When "main.html" file is clicked, Web browser will start and Initial window will appear.

2. Click the model name of your projector first, and then click language you want from the displayed list. The User's manual (detailed) will open.

⚠ CAUTION ► Only use the CD-ROM in a computer CD drive. The CD-ROM is designed for computer use only. NEVER INSERT THE CD-ROM INTO A NON-COMPUTER CD PLAYER! Inserting the CD-ROM into an incompatible CD drive may produce a loud noise, which in turn MAY RESULT IN EAR AND SPEAKER DAMAGE!

- After using CD-ROM, please put it into CD case and keep it. Please keep the CD neither in direct sunlight nor in a high temperature and high humidity environment.

NOTE • The information in the CD-ROM is subject to change without notice. Please check our website where you may find the latest information for this projector. (📖18)

- No responsibility is taken for any obstacle and defect to hardware and software of your computer as a result of the use of the CD-ROM.
- All or Any part of the information in the CD-ROM must not be copied, reproduced or republished without notice to our company.

Specifications

Item	Specification
Product name	Liquid crystal projector
Liquid Crystal Panel	CP-X2514WN, CP-X3014WN, CP-X4014WN: 786,432 pixels (1024 horizontal x 768 vertical) CP-WX3014WN: 1,024,000 pixels (1280 horizontal x 800 vertical)
Lamp	210 W UHP
Speaker	16 W mono (8 W x 2)
Power supply/ Rated current	AC 100-120 V: 3.4 A, AC 220-240 V: 1.8 A
Power consumption	AC 100-120 V: 330 W, AC 220-240 V: 310 W
Temperature range	5 ~ 35 °C (Operating)
Size	317 (W) x 98 (H) x 288 (D) mm * Not including protruding parts. Refer to figure F-5 at the back of this manual.
Weight (mass)	approx. 3.5 kg
Ports	COMPUTER IN1 D-sub 15 pin mini jack x1 COMPUTER IN2 D-sub 15 pin mini jack x1 HDMI HDMI connector x1 MONOTOR OUT D-sub 15 pin mini jack x1 Y, Cb/Pb, Cr/Pr (COMPONENT) RCA jack x3 S-VIDEO Mini DIN 4 pin jack x1 VIDEO RCA jack x1 AUDIO IN1 3.5 mm (stereo) mini jack x1 AUDIO IN2 3.5 mm (stereo) mini jack x1 AUDIO IN3 (R, L) RCA jack x2 AUDIO OUT (R, L) RCA jack x2 USB TYPE A USB type A connector x1 USB TYPE B USB type B connector x1 CONTROL D-sub 9 pin plug x1 LAN RJ45 jack x1 MIC 3.5 mm (mono) mini jack x1
Optional parts	Lamp: DT01021 Filter set: MU06481 Mounting accessory: HAS-3010 (Bracket for ceiling mount) HAS-204L (Fixing adaptor for low ceilings) HAS-304H (Fixing adaptor for high ceilings) Laser remote control: RC-R008 USB wireless adapter: USB-WL-11N * For more information, please consult your dealer.

Troubleshooting - Warranty and after-service

If an abnormal operation (such as smoke, strange odor or excessive sound) should occur, stop using the projector immediately.

Otherwise if a problem occurs with the projector, first refer to “Troubleshooting” of **User’s Manual - Operating Guide** and **Network Guide**, and run through the suggested checks.

If this does not resolve the problem, please consult your dealer or service company. They will tell you what warranty condition is applied.

Please check the following web address where you may find the latest information for this projector.

Product information and Manuals :	http://www.hitachi-america.us/digitalmedia
Production information :	http://www.hitachidigitalmedia.com
Direct link to manual download :	http://www.hitachiserviceeu.com/support/guides/userguides.htm

- NOTE** • The information in this manual is subject to change without notice.
- The manufacturer assumes no responsibility for any errors that may appear in this manual.
 - The reproduction, transfer or copy of all or any part of this document is not permitted without express written consent.

Trademark acknowledgment

- Mac[®], Macintosh[®] and Mac OS[®] are registered trademarks of Apple Inc.
- Pentium[®] is a registered trademark of Intel Corp.
- Adobe[®] and Acrobat[®], Reader[®] are registered trademarks of Adobe Systems Incorporated.
- Microsoft[®], Internet Explorer[®], Windows[®], Windows NT[®] and Windows Vista[®] are registered trademarks of Microsoft Corporation in the U.S. and/or other countries.
- PowerPC[®] is a registered trademark of International Business Machines Corporation.
- HDMI, the HDMI logo and High-Definition Multimedia Interface are trademarks or registered trademarks of HDMI Licensing LLC in the United States and other countries.
- Blu-ray Disc[™] is a trademark.

All other trademarks are the properties of their respective owners.

End User License Agreement for the Projector Software

- Software in the projector consists of the plural number of independent software modules and there exist our copyright or/and third party copyrights for each of such software modules.
- Be sure to read “End User License Agreement for the Projector Software” which is separated document. (in the CD)

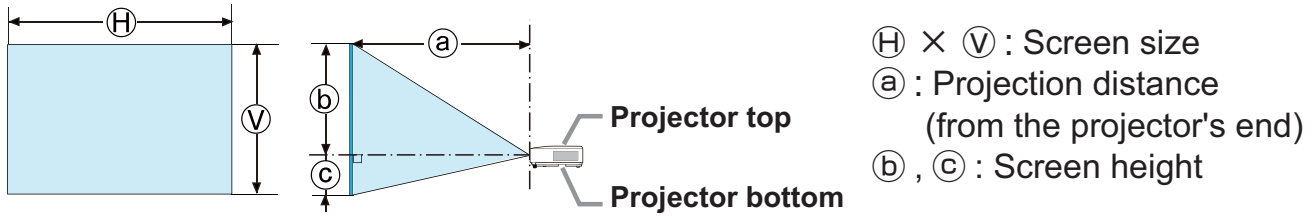

T-1 CP-X2514WN, CP-X3014WN, CP-X4014WN

(1024 x 768) (±10%)

Screen type (inch)	4 : 3										16 : 9									
	Screen size		Projection distance				Screen height				Screen size		Projection distance				Screen height			
	(H)	(V)	(a) min.	(a) max.	(b)		(c)		(H)	(V)	(a) min.	(a) max.	(b)		(c)					
	m	m	m	inch	m	inch	cm	inch	cm	inch	m	m	m	inch	m	inch	cm	inch	cm	inch
30	0.6	0.5	0.8	32	1.0	38	41	16	5	2	0.7	0.4	0.9	35	1.1	42	39	15	-1	0
40	0.8	0.6	1.1	44	1.3	52	55	22	6	2	0.9	0.5	1.2	48	1.5	57	51	20	-2	-1
50	1.0	0.8	1.4	56	1.7	67	69	27	8	3	1.1	0.6	1.5	61	1.9	73	64	25	-2	-1
60	1.2	0.9	1.7	67	2.0	81	82	32	9	4	1.3	0.7	1.9	74	2.2	88	77	30	-2	-1
70	1.4	1.1	2.0	79	2.4	95	96	38	11	4	1.5	0.9	2.2	87	2.6	104	90	35	-3	-1
80	1.6	1.2	2.3	91	2.8	109	110	43	12	5	1.8	1.0	2.5	100	3.0	119	103	41	-3	-1
90	1.8	1.4	2.6	103	3.1	123	123	49	14	5	2.0	1.1	2.9	113	3.4	134	116	46	-4	-1
100	2.0	1.5	2.9	115	3.5	137	137	54	15	6	2.2	1.2	3.2	126	3.8	150	129	51	-4	-2
120	2.4	1.8	3.5	139	4.2	165	165	65	18	7	2.7	1.5	3.9	152	4.6	181	154	61	-5	-2
150	3.0	2.3	4.4	175	5.3	208	206	81	23	9	3.3	1.9	4.8	191	5.8	227	193	76	-6	-2
200	4.1	3.0	6.0	234	7.1	278	274	108	30	12	4.4	2.5	6.5	256	7.7	304	257	101	-8	-3
250	5.1	3.8	7.5	294	8.9	349	343	135	38	15	5.5	3.1	8.1	321	9.7	381	322	127	-10	-4
300	6.1	4.6	9.0	354	10.7	420	411	162	46	18	6.6	3.7	9.8	386	11.6	458	386	152	-12	-5

T-2 CP-WX3014WN

(1280 x 800) (±10%)

Screen type (inch)	16 : 10										4 : 3									
	Screen size		Projection distance				Screen height				Screen size		Projection distance				Screen height			
	(H)	(V)	(a) min.	(a) max.	(b)		(c)		(H)	(V)	(a) min.	(a) max.	(b)		(c)					
	m	m	m	inch	m	inch	cm	inch	cm	inch	m	m	m	inch	m	inch	cm	inch	cm	inch
30	0.6	0.4	0.9	35	1.1	43	40	16	1	0	0.6	0.5	1.0	40	1.2	49	46	18	0	0
40	0.9	0.5	1.2	48	1.5	58	53	21	1	0	0.8	0.6	1.4	54	1.7	67	61	24	0	0
50	1.1	0.7	1.5	61	1.9	74	66	26	1	1	1.0	0.8	1.8	69	2.1	84	76	30	0	0
60	1.3	0.8	1.9	73	2.3	89	79	31	2	1	1.2	0.9	2.1	84	2.6	102	91	36	0	0
70	1.5	0.9	2.2	86	2.7	105	92	36	2	1	1.4	1.1	2.5	98	3.0	119	107	42	0	0
80	1.7	1.1	2.5	99	3.1	121	106	42	2	1	1.6	1.2	2.9	113	3.5	137	122	48	0	0
90	1.9	1.2	2.8	112	3.5	136	119	47	2	1	1.8	1.4	3.2	128	3.9	155	137	54	0	0
100	2.2	1.3	3.2	125	3.9	152	132	52	3	1	2.0	1.5	3.6	142	4.4	172	152	60	0	0
120	2.6	1.6	3.8	151	4.6	183	158	62	3	1	2.4	1.8	4.4	171	5.3	207	183	72	0	0
150	3.2	2.0	4.8	190	5.8	229	198	78	4	2	3.0	2.3	5.5	215	6.6	260	229	90	0	0
200	4.3	2.7	6.5	254	7.8	307	264	104	5	2	4.1	3.0	7.3	288	8.8	348	305	120	0	0
250	5.4	3.4	8.1	319	9.8	385	330	130	7	3	5.1	3.8	9.2	361	11.1	436	381	150	0	0
300	6.5	4.0	9.7	383	11.8	463	396	156	8	3	6.1	4.6	11.0	434	13.3	524	457	180	0	0

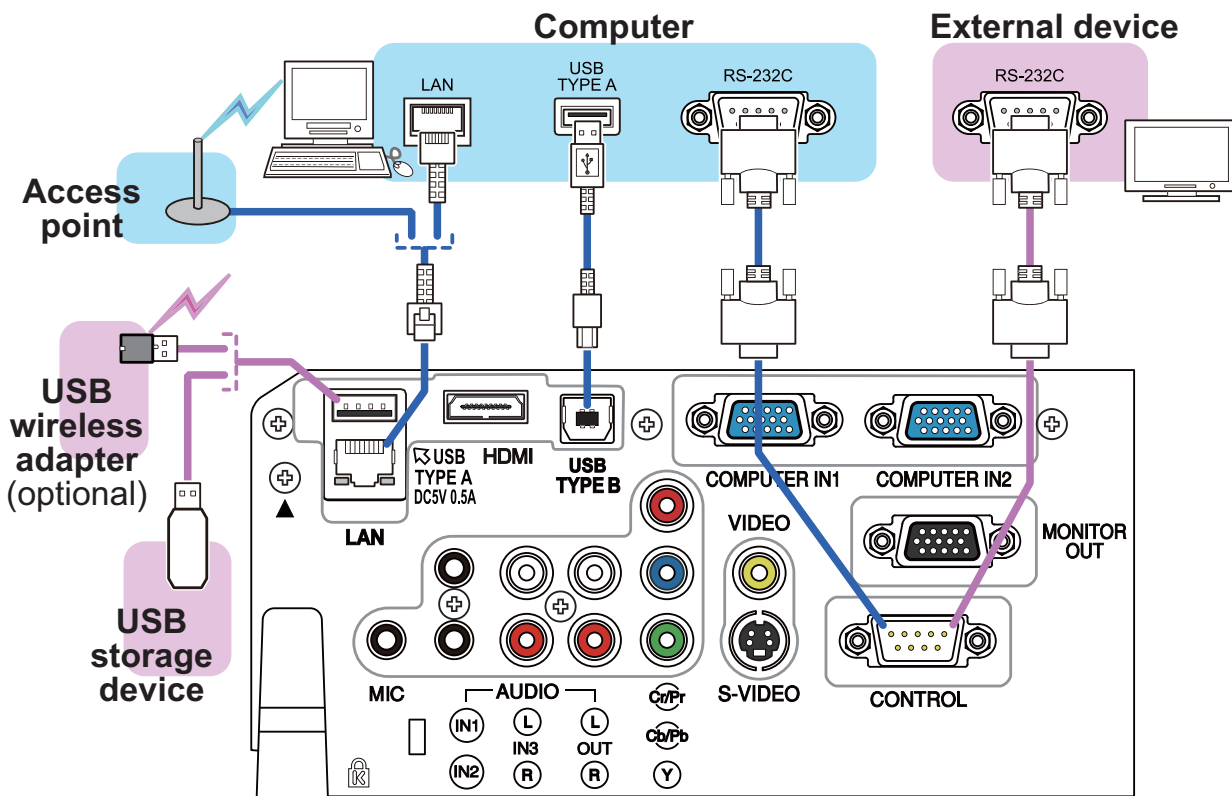
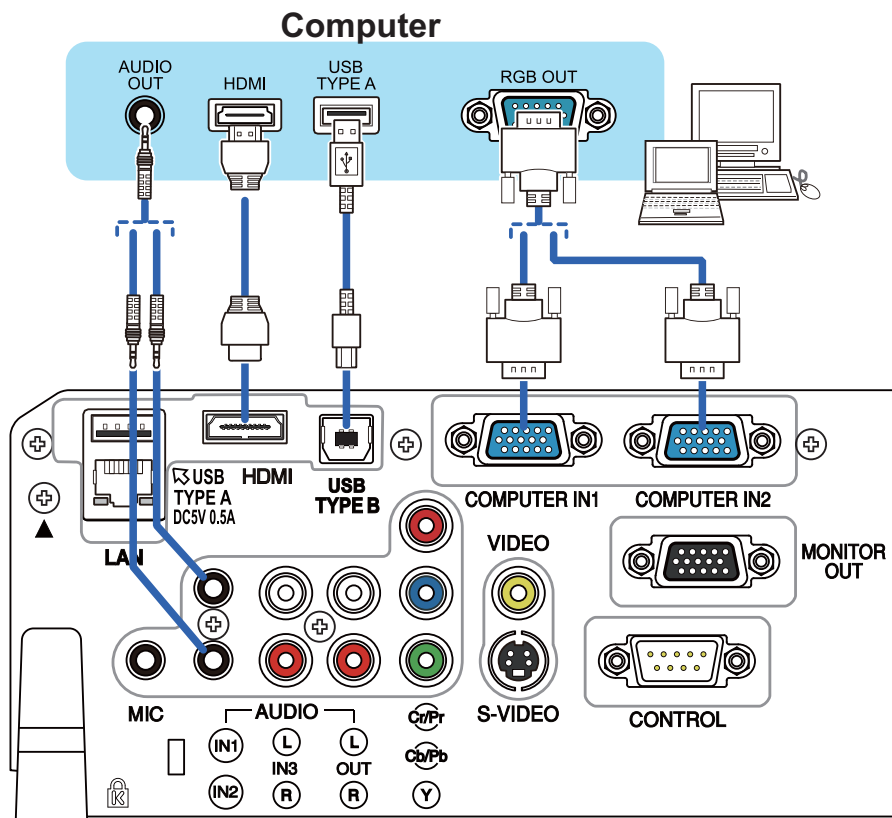

VCR/DVD/Blu-ray Disc player

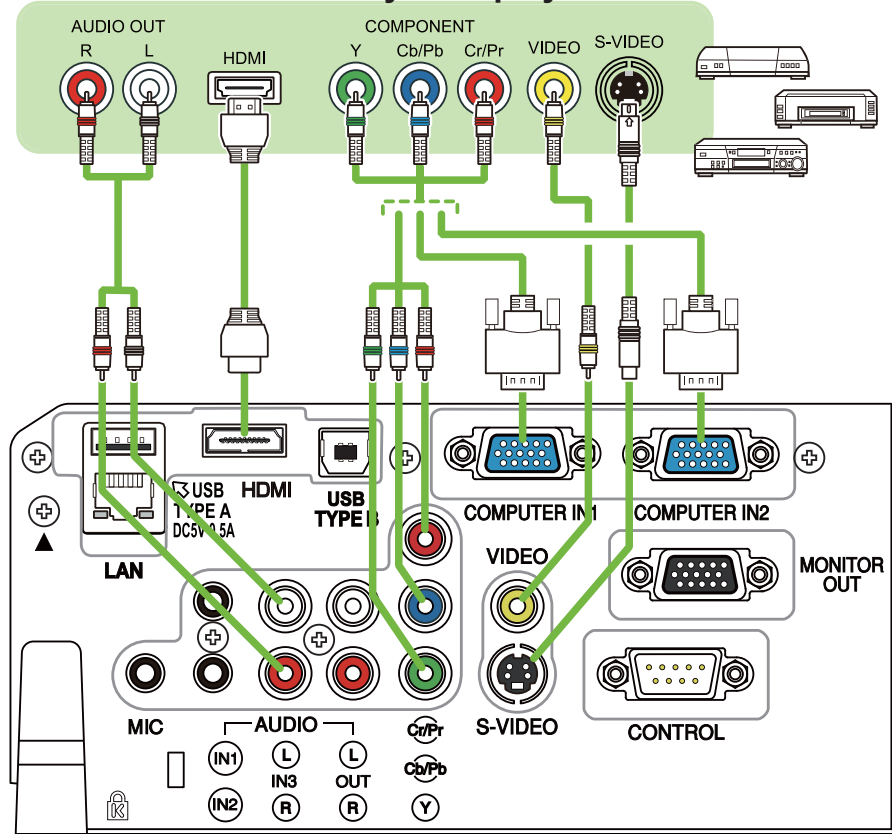

Speakers
(with an amplifier)

Monitor

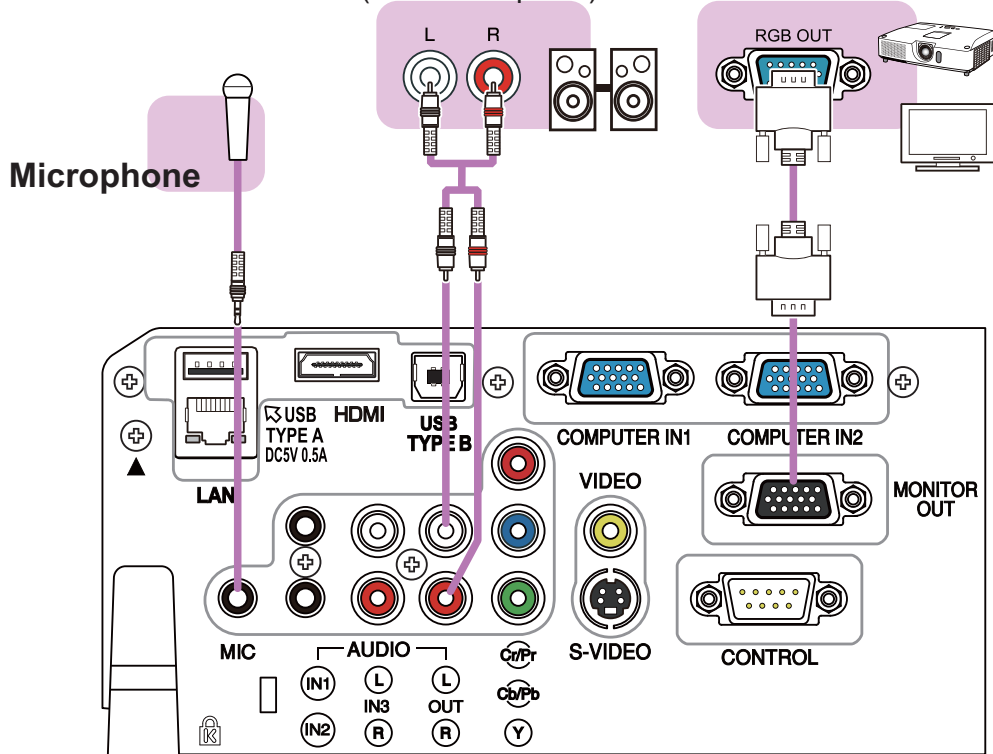

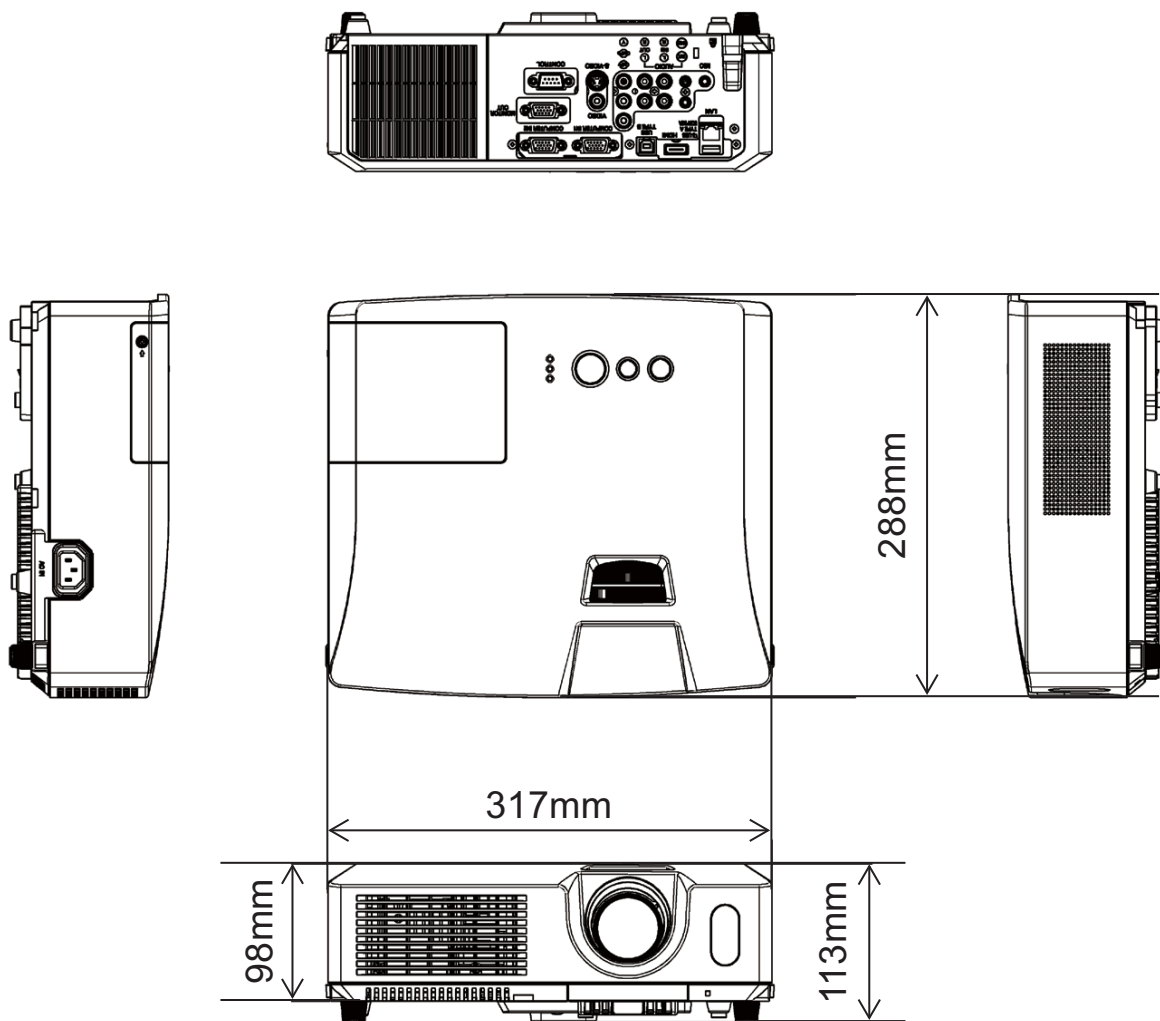

NOTE • The information in this manual is subject to change without notice. • The manufacturer assumes no responsibility for any errors that may appear in this manual. • The reproduction, transfer or copy of all or any part of this document is not permitted without express written consent.

REMARQUE • Les informations contenues dans ce manuel peuvent faire l'objet de changements sans avertissement préalable. • Le fabricant ne prend aucune responsabilité pour les erreurs qui pourraient se trouver dans ce manuel. • La reproduction, la transmission ou l'utilisation de ce document ou de son contenu est interdite sauf autorisation spéciale écrite.

HINWEIS • Die Informationen in diesem Handbuch können ohne vorherige Ankündigung geändert werden. • Der Hersteller übernimmt keine Verantwortung für etwaige in diesem Handbuch enthaltene Fehler. • Die Vervielfältigung, Übertragung oder Verwendung dieses Dokuments oder dessen Inhalts ist ohne ausdrückliche schriftliche Genehmigung nicht gestattet.

NOTA • La información de este manual puede sufrir modificaciones sin previo aviso. • El fabricante no asume ninguna responsabilidad por los errores que puedan aparecer en este manual. • No está permitida la reproducción, transmisión o utilización de este documento ni de su contenido sin autorización expresa por escrito.

NOTA • Le informazioni riportate in questo manuale sono soggette a modifica senza preavviso. • Il produttore declina qualsiasi responsabilità per eventuali errori che potrebbero comparire nel presente manuale. • E' vietata la riproduzione, la trasmissione o l'utilizzo del presente documento o del suo contenuto senza espressa autorizzazione scritta.

MERK • Informasjonen i denne håndboken kan endres uten varsel. • Produsenten påtar seg intet ansvar for eventuelle feil som fremkommer i denne håndboken. • Reproduksjon, overføring eller bruk av dette dokumentet eller deler av det, er ikke tillatt uten uttrykt skriftlig tillatelse.

OPMERKING • De informatie in deze handleiding kan zonder voorafgaande kennisgeving veranderd worden. • De fabrikant neemt geen enkele verantwoordelijkheid voor de eventuele fouten in deze handleiding. • Reproductie, overdracht of het gebruik van dit document is niet toegestaan, zonder uitdrukkelijke toestemming van de betreffende partij.

NOTA • As informações contidas neste manual estão sujeitas a alterações sem aviso prévio.
• O fabricante não se responsabiliza por quaisquer erros que possam surgir neste manual.
• A reprodução, transmissão ou utilização deste documento ou do seu conteúdo não é permitida sem autorização expressa por escrito.

通知事項 • 本书中刊载的内容有可能不经预告而发生变更。• 本产品的制造者对本书中的刊载错误不负任何责任。• 未经允许请勿复制、转载和使用本书的部分或全部内容。

알림 • 본서에 기재되어 있는 내용은 예고 없이 변경하는 일이 있습니다. • 본제품의 제조자는, 본서에 있어서의 기재 오류에 대해서 일절의 책임도 지지 않습니다. • 본서 내용의 일부 혹은 전부를 무단으로 복사하거나 전재하여 사용하는 것을 절대 금합니다.

NOTERA • Informationen i denna bruksanvisning kan komma att ändras utan förvarning. • Tillverkaren påtar sig inget ansvar för eventuella fel i denna bruksanvisning. • Återgivning, översändande eller användning av detta dokument eller dess innehåll är inte tillåten utan uttrycklig skriftligt medgivande.

ПРИМЕЧАНИЕ. • Содержание данного руководства может изменяться без предварительного уведомления. • Производитель не несет ответственности за ошибки в данном руководстве.
• Воспроизведение, передача и использование данного документа или его содержания запрещено без письменного разрешения.

HUOM! • Tämän ohjekirjan tiedot voivat muuttua ilman eri ilmoitusta. • Valmistaja ei ota mitään vastuuta ohjekirjassa mahdollisesti olevista virheistä. • Dokumentin tai sen sisällön jäljentäminen, siirto tai käyttö ei ole sallittua ilmannimenomaista kirjallista valtuutusta.

UWAGA • Informacje podane w tym podręczniku mogą ulec zmianie bez uprzedzenia. • Producent nie ponosi odpowiedzialności za ewentualne błędy w podręczniku. • Powielanie, przesyłanie lub inne wykorzystanie tego dokumentu lub jego treści nie jest dozwolone bez wyraźnej pisemnej zgody.

HITACHI

Inspire the Next

Hitachi America, Ltd.

Digital Media Division
900 Hitachi way, Chula Vista
CA 91914-3556 **USA** **CANADA**
Tel: +1 -800-225-1741
Fax: +1 -619-591-5418
► <http://www.hitachi-america.us/digitalmedia>

Hitachi Europe Ltd., Consumer Affairs Department

PO Box 3007
Maidenhead
Berkshire SL6 8ZE **UNITED KINGDOM**
Tel: 0844 481 0297
Email: consumer.mail@hitachi-eu.com

Hitachi Europe S.A.S., Digital Media Group

31 bis rue du 35ème Régiment de l'aviation
ZAC DU CHENE, 69500 BRON **FRANCE**
Tel: 047 281 9330
Email: france.consommateur@hitachi-eu.com

Hitachi Europe GmbH

Am Seestern 18
40547 Düsseldorf **GERMANY**
Tel: 211-5283-808
Fax: 211-5283-809
Hotline: 0180 - 551 25 51 (12ct/min.)
Email: Service.germany@hitachi-eu.com

Hitachi Europe S.A.

364, Kifissias Ave. & 1, Delfon Str.
152 33 Chalandri
Athens **GREECE**
Tel: 210 6837200
Fax: 210 6835694
Email: dmgservice.gr@hitachi-eu.com

Hitachi Europe S.r.l.

Via T. Gulli, 39
20147 MILANO **ITALY**
Tel: +39 02 2570094
Fax: +39 02 25712029
Email: customerservice.italy@hitachi-eu.com

Hitachi Europe S.A.

Gran Via Carles III, 86 Planta 5ª
Edificios Trade - Torre Este
08028 Barcelona **SPAIN**
Tel: 0034 934 092 5 50
Email: garantias@ltr-hitachi.es

Hitachi Europe AB

Frösundaviks Alle 15
169 29 Solna **SWEDEN**
Sweden Tel: +46 856 27 1100
Finland Tel: +358 10 8503 085
Norway Tel: +47 9847 3898
Denmark Tel: +45 43 43 6050
Email: rma.nordic@hitachi-eu.com

Hitachi Australia Pty Ltd.

Level 3, 82 Waterloo Road
North Ryde N.S.W 2113 **AUSTRALIA**
Tel: +61 -2-9888-4100
Fax: +61 -2-9888-4188
► <http://www.hitachi.com.au>

Hitachi (Hong Kong), Ltd.

18/F., Ever Gain Centre, 28 On Muk Street.,
Shatin, N.T. **HONG KONG**
Tel: +852 -2113-8883
Fax: +852 -2783-8535
► <http://www.hitachi-hk.com.hk>

Hitachi Sales (Malaysia) Sdn. Bhd.

Lot 12, Jalan Kamajuan, Bangi Industrial Estate,
43650 Bandar Baru Bangi, Selangor Darul Ehsan
MALAYSIA
Tel: +60 -3-8911-2670
Fax: +60 -3-8926-3013
► <http://www.hitachiconsumer.com.my>

Hitachi Home Electronics Asia (S) Pte. Ltd.

438A Alexandra Road #01-01/02/03
Alexandra Technopark, 119967 **SINGAPORE**
Tel: +65 -6536-2520
Fax: +65 -6536-2521
► <http://www.hitachiconsumer.com.sg>

Hitachi Sales Corp. of Taiwan

2nd Floor, No.65, Nanking East Road, Section 3,
Taipei 104 **TAIWAN**
Tel: +886-2-2516-0500
Fax: +886-2-2506-1053
► <http://www.hsct.com.tw>

Hitachi Sales (Thailand), Ltd.

994, 996 Soi Thonglor, Sukhumvit 55 Rd.,
Klongtonnua, Vadhana, Bangkok 10110
THAILAND
Tel: +66 2381 8381-98
Fax: +66 2391 0210, +66 2391 0021
► <http://www.hitachi-th.com>

Hitachi Consumer Electronics Co.,Ltd.

292 Yoshida-cho, Totsuka-ku
Yokohama 244-0817 **JAPAN**
Tel: +81-45-415-2625
Fax: +81-45-866-5821
► <http://www.hitachi.co.jp/proj/>