



LG

Life's Good

OWNER'S MANUAL

DLP PROJECTOR

Please read this manual carefully before operating your set and retain it for future reference.

HW300T

LICENSES

Supported licenses may differ by model. For more information about licenses, visit www.lg.com.



Manufactured under license from Dolby Laboratories. "Dolby" and the double-D symbol are trademarks of Dolby Laboratories.



ABOUT DIVX VIDEO: DivX® is a digital video format created by DivX, Inc. This is an official DivX Certified® device that plays DivX video. Visit www.divx.com for more information and software tools to convert your files into DivX video.

ABOUT DIVX VIDEO-ON-DEMAND: This DivX Certified® device must be registered in order to play purchased DivX Video-on-Demand (VOD) movies. To obtain your registration code, locate the DivX VOD section in your device setup menu. Go to vod.divx.com for more information on how to complete your registration. "DivX Certified® to play DivX® video up to HD 1080p, including premium content."

Covered by one or more of the following U.S. patents : 7,295,673; 7,460,668; 7,515,710; 7,519,274
DivX®, DivX Certified® and associated logos are trademarks of DivX, Inc. and are used under license.

NOTE

- Image shown may differ from your projector.
- Your projector's OSD (On Screen Display) may differ slightly from that shown in this manual.

SAFETY INSTRUCTIONS

Please take note of the safety instructions to prevent any potential accident or misuse of the projector.

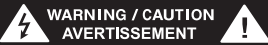

WARNING / CAUTION
AVERTISSEMENT

RISK OF ELECTRIC SHOCK, DO NOT OPEN.
RISQUE DE CHOC ÉLECTRIQUE, NE PAS OUVRIR.



The lightning flash with arrowhead symbol, within an equilateral triangle, is intended to alert the user to the presence of uninsulated “dangerous voltage” within the product’s enclosure that may be of sufficient magnitude to constitute a risk of electric shock to persons.



The exclamation point within an equilateral triangle is intended to alert the user to the presence of important operating and maintenance (servicing) instructions in the literature accompanying the appliance.

WARNING/CAUTION

- TO REDUCE THE RISK OF FIRE AND ELECTRIC SHOCK, DO NOT EXPOSE THIS PRODUCT TO RAIN OR MOISTURE.

Read these instructions.

Keep these instructions.

Heed all warnings.

Follow all instructions.

Indoor Installation

WARNING

- Do not place the Projector in direct sunlight or near heat sources such as radiators, fires, stove etc.
 - This may cause a fire hazard.
- Do not place flammable materials in, on or near the projector.
 - This may cause a fire hazard.
- Do not hang on the installed projector.
 - It may cause the projector to fall, causing injury or death.
- Do not block the vents of the projector or restrict air-flow in any way.
 - This would cause the internal temperature to increase and could cause a fire hazard or damage to the unit.
- Do not place the projector close to sources of steam or oil such as a humidifier.
 - This may create a fire hazard or an electric shock hazard.
- Do not place the projector where it might be exposed to excessive dust.
 - This may cause a fire hazard or damage to the unit.
- Do not use the projector in a damp place such as a bathroom where it is likely to get wet.
 - This may cause a fire or an electric shock hazard.

- Do not place the projector directly on a carpet, rug or place where ventilation is restricted.
 - This would cause its internal temperature to increase and might create a fire hazard or damage the unit.
- Ensure good ventilation around the projector. The distance between the projector and the wall should be more than 30 cm.
 - An excessive increase in its internal temperature may cause a fire hazard or damage to the unit.

NOTES

- When installing the projector on a table, be careful not to place it near the edge.
 - The projector could fall causing injury and damage to the projector. **Only use a suitable stand.**
- Disconnect from the power supply and remove all connections before moving, or cleaning.
- Only use the projector on a level and stable surface.
 - It may fall and cause injury and/or damage to the unit.
- Do not drop the projector when connecting to a external devices.
 - This may cause injury and/or damage to the unit.

Power

WARNING

- Earth wire should be connected.
 - Ensure that you connect the earth ground wire to prevent possible electric shock (That is a Projector with a three-prong grounded AC plug must be connected to a three-prong grounded AC outlet).
If grounding methods are not possible, have a qualified electrician install a separate circuit breaker. Do not try to ground the unit by connecting it to telephone wires, lightening rods, or gas pipes.
- The power cord should be inserted fully into the power outlet to avoid a fire hazard.
 - This may cause a fire hazard or damage the unit.
- Do not place heavy objects on the power cord.
 - This may cause a fire or an electric shock hazard.
- Never touch the power plug with a wet hand.
 - This may cause an electric shock hazard.
- Do not plug-in too many items into one power outlet.
 - It may result in overheating of the outlet and create a fire hazard.
- Prevent dust from collecting on the power plug pins or outlet.
 - This may cause a fire hazard.

NOTES

- Hold the plug firmly when unplugging. If you pull the cord, it may be damaged.
 - This may cause a fire hazard.
- Do not use if the power cord or the plug is damaged or any part of the power outlet is loose.
 - This may cause a fire or an electric shock hazard or damage to the unit.
- Ensure the power cord does not come into contact with sharp or hot objects.
 - This may cause a fire or an electric shock hazard or damage to the unit.
- Place the projector where people will not trip or tread on the power cord.
 - This may cause a fire or an electric shock hazard or damage to the unit.
- Do not turn the projector On/Off by plugging-in or unplugging the power plug to the wall outlet. (Allow the unit to cool before removing power.)
 - It may cause mechanical failure or could cause an electric shock.

Using**WARNING**

- Do not place anything containing liquid on top of the projector such as flowerpot, cup, cosmetics or candle.
 - This may cause a fire hazard or damage to the unit.
- In case of impact shock or damage to the projector switch it off and unplug it from the power outlet and contact an authorized service center.
 - This may cause a fire or an electric shock hazard or damage to the unit!
- Do not allow any objects to fall into the projector.
 - This may cause an electric shock hazard or damage to the unit!
- If water is spilt into the projector unplug it from the power supply immediately and consult your Service Agent.
 - This may cause an electric shock hazard or damage to the unit!
- Dispose of used batteries carefully and safely.
 - In the case of a battery being swallowed by a child please consult a doctor immediately.
- Do not remove any covers. High risk of Electric Shock.
- Don't look directly into the lens when the projector is in use. Eye damage may occur.
- Do not touch metal parts during or soon after operation since the vents will remain very hot.
- If the projector is in a room that experiences a gas leak, do not touch the projector.
 - It can cause a fire or a burn by a spark.
- Always open the lens door or remove the lens cap when the projector is on.
- Never touch this apparatus or power cord during a thunder or lightning storm.
 - This may cause an electric shock hazard.

- **CAUTION** concerning the Power Cord
It is recommend that most appliances be placed on a dedicated circuit; that is, a single outlet circuit which powers only that appliance and has no additional outlets or branch circuits. Check the specification page of this owner's manual to be certain. Do not overload wall outlets. Overloaded wall outlets, loose or damaged wall outlets, extension cords, frayed power cords, or damaged or cracked wire insulation are dangerous. Any of these conditions could result in electric shock or fire. Periodically examine the cord of your appliance, and if its appearance indicates damage or deterioration, unplug it, discontinue use of the appliance, and have the cord replaced with an exact replacement part by authorized service personnel.
Protect the power cord from physical or mechanical abuse, such as being twisted, kinked, pinched, closed in a door, or walked upon. Pay particular attention to plugs, wall outlets, and the point where the cord exits the appliance.

NOTES

- Do not place heavy objects on top of projector.
 - This may cause mechanical failure or personal injury.
- Take care not to impact the lens particularly when moving the projector.
- Do not touch the lens of the projector. It is delicate and easily damaged.
- Do not use any sharp tools on the projector as this will damage the casing.
- In the event that an image does not appear on the screen please switch it off and unplug it from the power outlet and contact your Service Agent.
 - This may cause a fire or an electric shock hazard or damage to the unit!
- Do not drop the projector or allow impact shock.
 - This may cause mechanical failure or personal injury.
- Keep the proper distance from the product.
 - Your vision may be impaired if you look at the product too closely.

Cleaning

WARNING

- Do not use water while cleaning the projector.
 - This may cause damage to the projector or an electric shock hazard.
- In the unlikely event of smoke or a strange smell from the projector, switch it off, unplug it from the wall outlet and contact your dealer or service center.
 - This may cause a fire or an electric shock hazard or damage to the unit!
- Use an air spray or soft cloth that is moist with a neutral detergent and water for removing dust or stains on the projection lens.

NOTES

- Contact the Service Center once a year to clean the internal parts of the projector.
 - Accumulated dust can cause mechanical failure.
- When cleaning the plastic parts such as projector case, unplug the power and wipe it with a soft cloth. Do not use cleanser, spray water or wipe with a wet cloth. Especially, never use cleanser (glass cleaner), automobile or industrial shiner, abrasive or wax, benzene, alcohol etc., which can damage the product. Use an air spray or soft cloth that is moist with a neutral detergent and water for removing dust or stains on the projection lens.
 - It can cause fire, electric shock or product damage (deformation, corrosion and damage).

Others

WARNING

- Do not attempt to service the projector yourself. Contact your dealer or service center.
 - This may cause damage to the projector and could give an electric Shock as well as invalidating the warranty.

NOTES

- Do not mix new batteries with old batteries.
 - This may cause the batteries to overheat and leak.
- Be sure to unplug if the projector is not to be used for a long period.
 - Accumulated dust may cause a fire hazard or damage to the unit!
- Only use the specified type of battery.
 - This could cause damage to the remote control.

ANTENNA

Outdoor Antenna Grounding

- If an outdoor antenna is installed, follow the precautions below. An outdoor antenna system should not be located in the vicinity of overhead power lines or other electric light or power circuits, or where it can come in contact with such power lines or circuits as death or serious injury can occur. Be sure the antenna system is grounded so as to provide some protection against voltage surges and built-up static charges. Section 810 of the National Electrical Code (NEC) in the U.S.A. provides information with respect to proper grounding of the mast and supporting structure, grounding of the lead-in wire to an antenna discharge unit, size of grounding conductors, location of antenna discharge unit, connection to grounding electrodes and requirements for the grounding electrode.

Antenna grounding according to the National Electrical Code, ANSI/NFPA 70

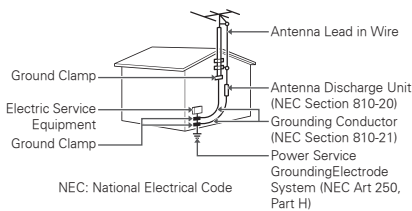

FCC NOTICE

Warning - Class B

(b) For a Class B Digital device or peripheral, the instructions furnished the user shall include the following or similar statement, placed in a prominent location in the text of the manual:

NOTE: This equipment has been tested and found to comply with the limits for a Class B digital device, pursuant to part 15 of the FCC Rules. These limits are designed to provide reasonable protection against harmful interference in a residential installation. This equipment generates, uses and can radiate radio frequency energy and, if not installed and used in accordance with the instructions, may cause harmful interference to radio communications. However, there is no guarantee that interference will not occur in a particular installation. If this equipment does cause harmful interference to radio or television reception, which can be determined by turning the equipment off and on, the user is encouraged to try to correct the interference by one or more of the following measures:

- Reorient or relocate the receiving antenna.
- Increase the separation between the equipment and receiver.
- Connect the equipment into an outlet on a circuit different from that to which the receiver is connected.
- Consult the dealer or an experienced radio/TV technician for help.

Disposal of your old appliance

1. When this crossed-out wheeled bin symbol is attached to a product it means the product is covered by the European Directive 2002/96/EC.
2. All electrical and electronic products should be disposed of separately from the municipal waste stream through designated collection facilities appointed by your government or your local authorities.
3. The correct disposal of your old appliance will help prevent potential negative consequences for the environment and human health.
4. For more detailed information about disposal of your old appliance, please contact your city office, waste disposal service or the shop where you purchased the product.

Disposal of waste batteries/accumulators

1. When this crossed-out wheeled bin symbol is attached to batteries/accumulators of Your product it means they are covered by European Directive 2006/66/EC.
2. This symbol may be combined with chemical symbols for mercury(Hg), cadmium(Cd) or lead(Pb) if the battery Contains more than 0.0005% of mercury, 0.002% of cadmium or 0.004% of lead.
3. All batteries/accumulators should be disposed separately from the municipal waste stream via designated collection facilities appointed by the government or the local authorities.
4. The correct disposal of Your old batteries/accumulators will help to prevent potential negative consequences for the environment, animal and human health.
5. For more detailed information about disposal of Your old batteries/accumulators, please contact Your city office, waste disposal service or the shop where You purchased the product.

For USA**NOTE TO CABLE/TV INSTALLER**

This reminder is provided to call the CATV system installer's attention to Article 820-40 of the National Electric Code (U.S.A.). The code provides guidelines for proper grounding and, in particular, specifies that the cable ground shall be connected to the grounding system of the building, as close to the point of the cable entry as practical.

TABLE OF CONTENTS

LICENSES	2	ENTERTAINMENT	27
SAFETY INSTRUCTIONS	3	Network Connection	27
ASSEMBLING AND PREPARING	12	- Connecting to	
Unpacking	12	a Wireless Network	27
Optional Extras	13	- Setting to a Wireless Network	28
Parts and Buttons	14	- Tips for Network Setting	30
Installation	15	- Network Status	32
- Installation Precautions	15	NETCAST	32
- Basic Operation of the Projector	16	- Using the NETCAST	32
- How to Install the Projector Using		MY MEDIA	36
a Tripod	17	- Connecting USB Storage	
- Kensington Security System	17	Devices	36
REMOTE CONTROL	18	- Connecting DLNA DMP (Digital	
WATCHING PROJECTOR	20	Living Network Alliance, Digital	
Connecting to an Antenna or Cable	20	Media Player)	38
- Connecting an Antenna or Basic		- Connecting DLNA DMR (Digital	
Cable	20	Living Network Alliance, Digital	
- Connecting a Cable Box	20	Media Render)	42
Watching Projector	21	- MOVIE LIST	43
- Turning on for the First Time	21	- PHOTO LIST	49
- Focus and Position of the Screen		- MUSIC LIST	51
Image	21	- FILE VIEWER	53
- Watching Projector	21	PLAY GAME	54
Managing Channels	22	CUSTOMIZING SETTINGS	55
- Setting Up Channels	22	The SETUP Menu	55
Using Additional Options	24	CHANNEL Settings	56
- Adjusting Aspect Ratio	24	PICTURE Settings	56
- Using Keystone Function	25	SCREEN Settings	60
- Using the Input List	25	AUDIO Settings	61
- Blank Function	26	TIME Settings	62
Using the Quick Menu	26	LOCK Settings	63
		OPTION Settings	65
		NETWORK Settings	66

MAKING CONNECTIONS 67**Connecting to a HD receiver, DVD, or VCR player 68**

- HDMI Connection 68
- Component Connection 68
- Composite Connection 69

Connecting to a PC 69

- RGB Connection 69

Connecting to a Headphone 70**MAINTENANCE 71****Updating the Projector Firmware 71****Cleaning the Projector 72**

- Cleaning the lens 72
- Cleaning the Projector Case 72

How to Fix the Lens Cap 73**SPECIFICATIONS 74**

ASSEMBLING AND PREPARING

Unpacking

Check your product box for the following items. If there are any missing accessories, contact the local dealer where you purchased your product. The illustrations in this manual may differ from the actual product and item.

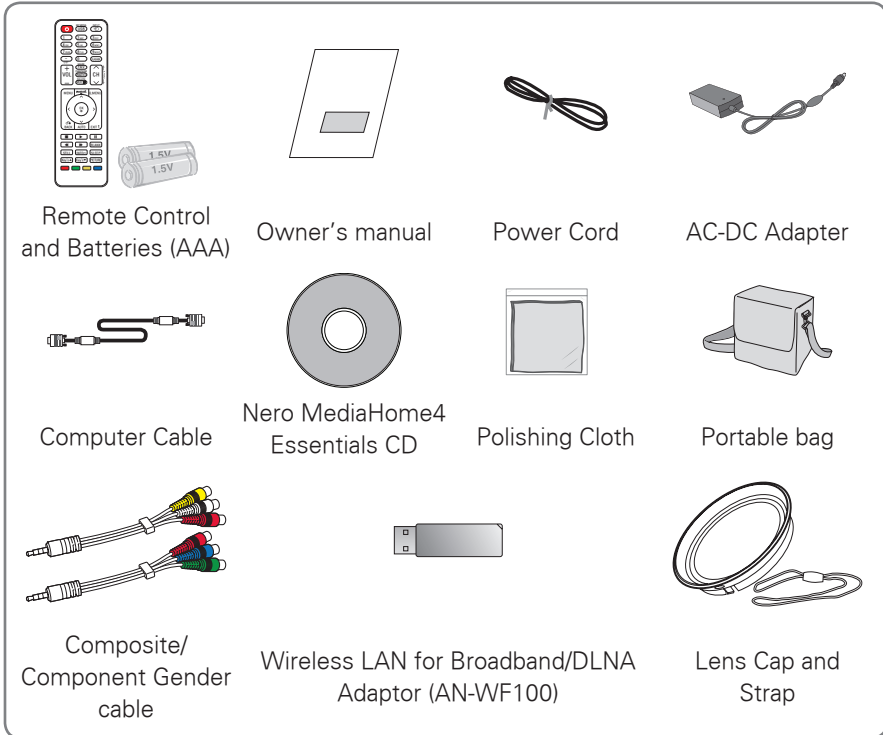

- Note that clearance is limited between the USB and HDMI inputs. Using devices of a non-standard size may block other ports.

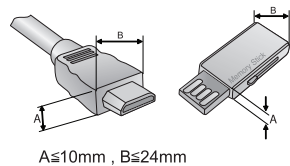

Optional Extras

Optional extras can be changed or modified for quality improvement without any notification.

Contact your dealer for buying these items.

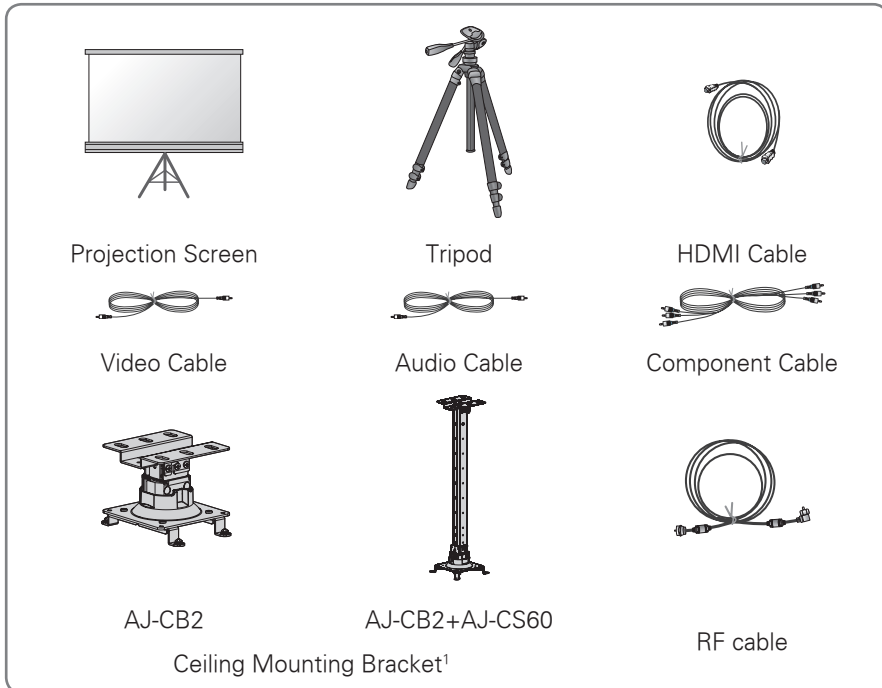

1 Use screw size: M4x6-M4x8

Parts and Buttons

* The projector is manufactured using high-precision technology. You may, however, see on the Projector screen tiny black points and/or bright points (red, blue, or green). This can be a normal result of the manufacturing process and does not always indicate a malfunction.

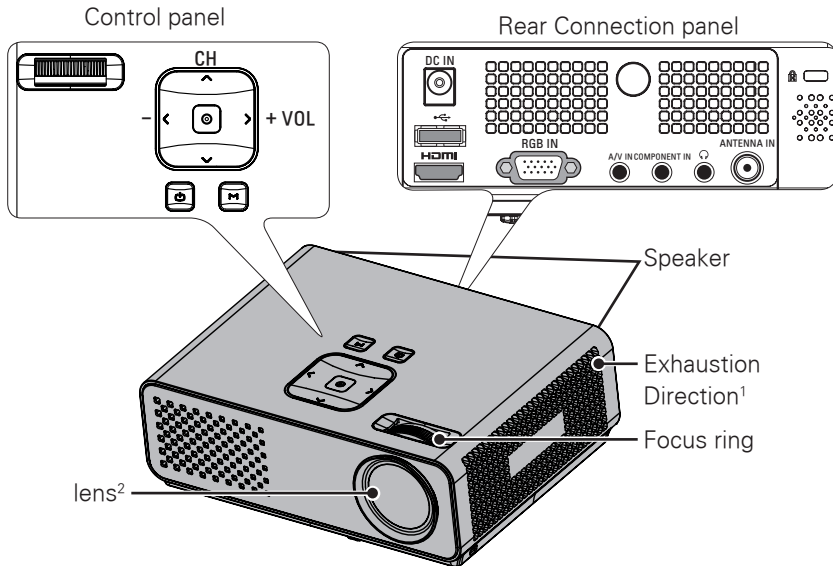

Button	Description
⏻ (POWER)	Turns the projector ON/OFF.
☰ (MENU)	Displays or closes menus.
CH ^, V	Scrolls through saved channels.
VOL -, +	Adjusts the volume level.
^, V, <, >	Adjusts functions of menus.
⊙ (OK)	Checks present mode and saves the change of functions.

1 High heat, keep the area near the exhaust clear.

2 Do not touch the lens when using the projector or opening the lens cap.

Installation

Installation Precautions

- Provide proper ventilation for this projector.
 - The projector is equipped with ventilation holes (intake) on the bottom and ventilation holes(exhaust) on the front. Do not block or place anything near these holes. Internal heat build-up may occur, causing picture degradation or damage to the projector.



- Do not place the projector on a carpet, rug or other similar surface. It may prevent a adequate ventilation of the projector bottom. This product should be mounted to a wall or ceiling only.



- Never push the projector or spill any kind of liquid into the projector.



- Leave an adequate distance (30 cm or more) around the projector.



- Place this projector in adequate temperature and humidity conditions.
 - Install this projector only in a location where adequate temperature and humidity is available. (See p.74)
- Don't place the projector where it can be covered with excessive dust.
 - This may cause overheating of the projector.
- Do not obstruct the slots and openings of the projector. This may cause overheating and cause a fire hazard.
- This projector is manufactured using high-precision technology. You may, however, see tiny black points and/ or bright points (red, blue or green) that continuously appear on the projector Screen. This is a normal result of the manufacturing process and does not indicate a malfunction.
- The remote control may not work when a lamp equipped with electronic ballast or a three-wavelength lamp is installed. Replace those lamps with international standard products to use the remote control normally.

Basic Operation of the Projector

- 1 Place the projector on a sturdy and horizontal surface.
- 2 Place the projector with the desired distance from the screen. The distance between the projector and the screen determines the actual size of the image.
- 3 Position the projector so that the lens is set at a right angle to the screen. If the projector is not set at a right angle, the screen image will be crooked. Although, slight angles can be counteracted using the Keystone adjustment. (See p.25).
- 4 After placing the projector in its desired location, connect the video input(s). Then connect the power cable to the projector and the wall outlet.

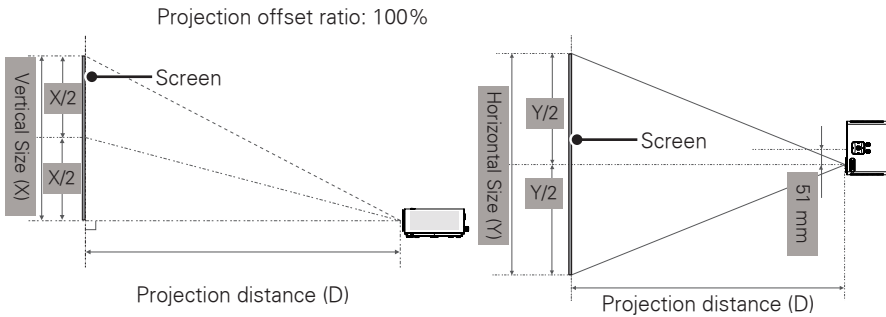

16 : 9 Scale			
Diagonal Size (mm)	Horizontal Size (Y) (mm)	Vertical Size (X) (mm)	Projection Distance (D) (mm)
508	431	269	586
635	538	337	737
762	646	404	887
889	754	471	1038
1016	861	539	1200
1143	969	606	1342
1270	1077	673	1492
1397	1185	741	1643
1524	1292	808	1794
1651	1400	875	1947
1778	1508	943	2097
1905	1615	1010	2248
2032	1723	1077	2399
2159	1831	1145	2552
2286	1938	1212	2702
2413	2046	1279	2853
2540	2154	1347	3004

How to Install the Projector Using a Tripod

- * You can install this projector using a camera tripod.
- * When stabilizing the tripod, we recommend using the locking bolt of standard size 4.5 mm or less. The maximum size allowed for the locking bolt is 6.5 mm. (If it is longer than the maximum allowed size, it may damage the projector.)

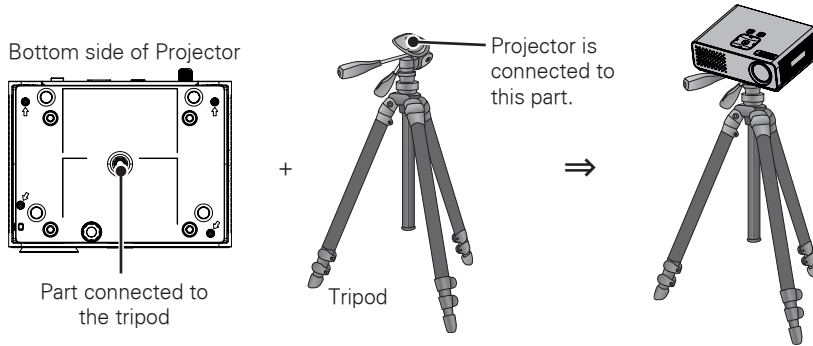

Kensington Security System

- This projector has a Kensington Security System Connector on the panel. Connect a Kensington Security System cable as below.
- For detailed installation and use of the Kensington Security System, refer to the user's guide included with the Kensington Security System set. And for further information, contact <http://www.kensington.com>, the internet homepage of the Kensington company that deals with expensive electronic equipment such as notebook PCs or projectors.
- The Kensington Security System is an optional item.

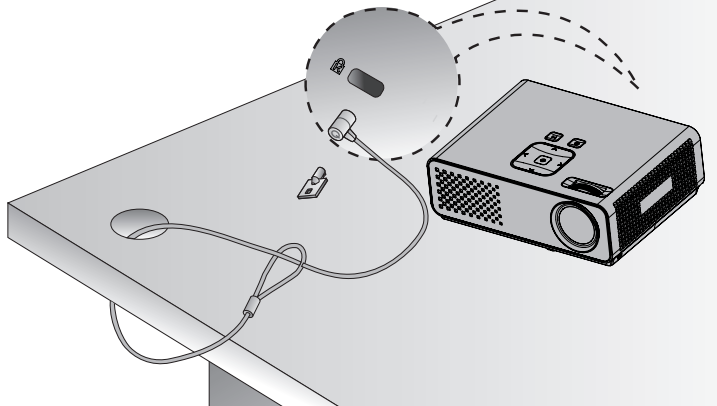

REMOTE CONTROL

The descriptions in this manual are based on the buttons on the remote control. Please read this manual carefully and use the projector correctly. To replace batteries, open the battery cover, replace batteries (1.5 V AAA) matching the ⊕ and ⊖ ends to the label inside the compartment, and close the battery cover. To remove the batteries, perform the installation actions in reverse.

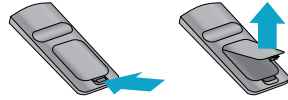

CAUTION

- RISK OF EXPLOSION IF BATTERY IS REPLACED WITH AN INCORRECT TYPE. DISPOSE OF USED BATTERIES AT A RECYCLING DROP-OFF LOCATION.
- Do not mix old and new batteries, as this may damage the remote control.

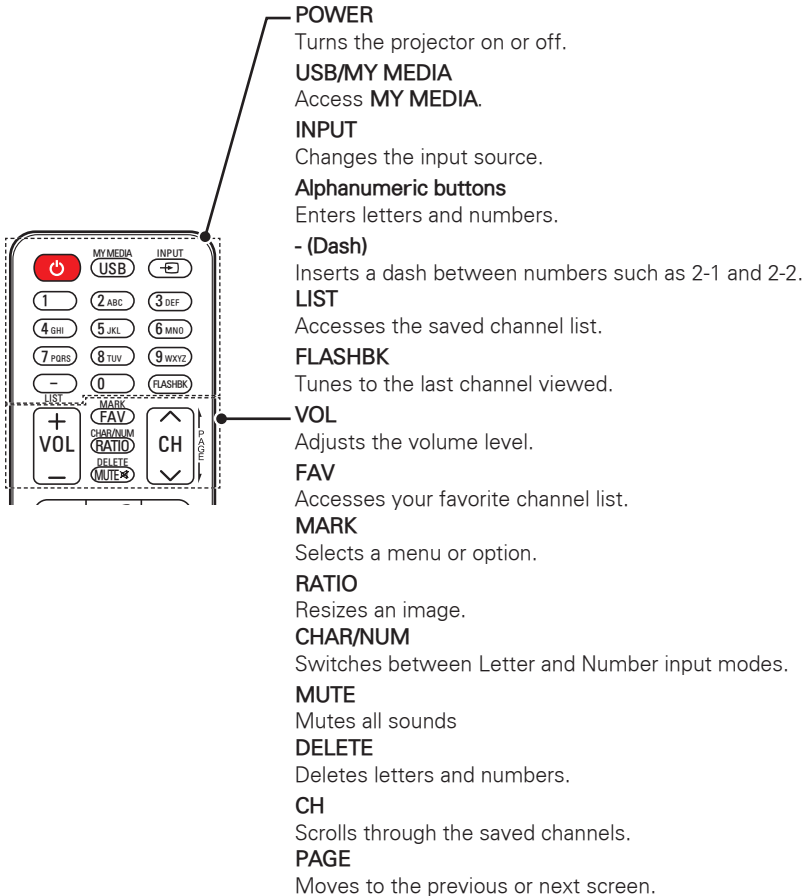

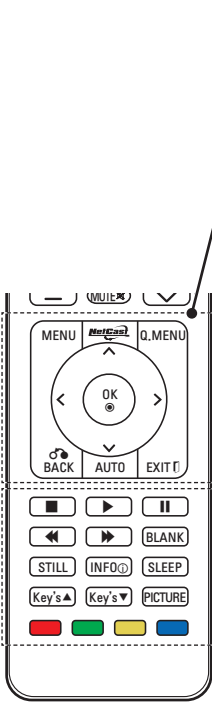

MENU

Accesses the menu.

NETCAST

Select the desired **NETCAST** menu source.

Q.MENU

Accesses the quick menu.

Navigation buttons (up/down/left/right)

Scrolls through menus or options.

OK

Selects menus or options and confirms your input.

BACK

Returns to the previous level.

AUTO

Automatically adjusting of the PC input image.

EXIT

Clears all on-screen displays and returns to projector viewing.

Control buttons

Controls the **NETCAST** or **MY MEDIA**.

BLANK

Turns the projector screen on or off.

STILL

Freeze the moving image.

Functions as the **STILL** button in any mode other than DivX.

INFO

Views the information of the current program and screen.

SLEEP

Sets the length of time until the projector turns off.

Key's

Adjusts Keystone.

PICTURE

Change the image mode.

Color buttons

These access special functions in some menus.

NOTE

- Optimal remote range is less than 6 meters and within a 60 degree arc of the IR receiver.
- The remote range may be less when cables are connected to the projector.
- When you carry the remote control in the portable bag, make sure that the buttons on the remote control are not pressed by the projector, cables, documents or any other accessories in the bag. Otherwise, it may reduce the battery life significantly.

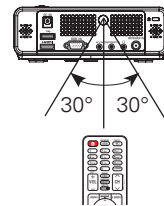

WATCHING PROJECTOR

Connecting to an Antenna or Cable

Connect an antenna, cable, or cable box to watch TV while referring to the following. The illustrations may differ from the actual items and a RF cable is optional.

Connecting an Antenna or Basic Cable

Connect the projector to a wall antenna socket with an RF cable (75 Ω).

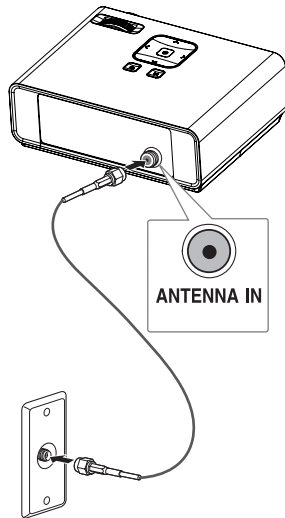

NOTE

- Use a signal splitter to use more than 2 projectors.
- Visit <http://lgknowledgebase.com> for more information about the antenna and cable connection. Search for antenna.

Connecting a Cable Box

Connect the projector to a cable box and the cable box to a wall antenna socket with 2 RF cables (75 Ω).

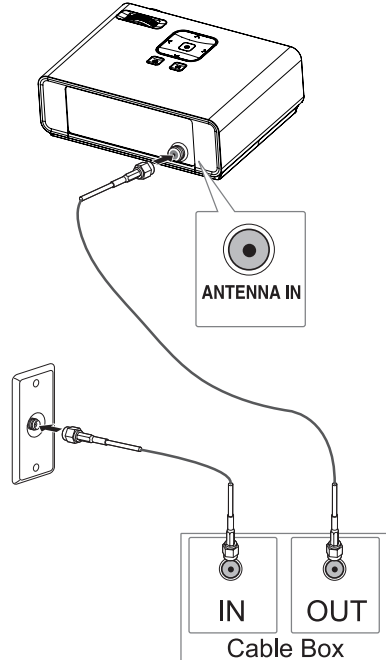

CAUTION

- Make sure not to bend the copper wire of the RF cable.

Copper wire

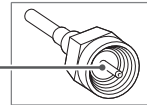

- Complete all connections between devices, and then connect the power cord to the power outlet to prevent damage to your projector.

Watching Projector

Turning on for the First Time

- 1 Make sure the power cord is connected correctly.
- 2 After wait for a moment, press the **POWER** button on the remote control or control panel. (The light on the control panel will be turned on.)
 - Check if the lens cap is removed before turning on the power.
- 3 Follow the on-screen instructions to customize your projector settings according to your preferences.

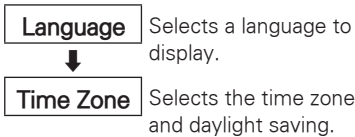

- 4 Press the **INPUT** button on the remote control to select the input signal you want.

Focus and Position of the Screen Image

When an image appears on the screen, check if it is in focus and fits the screen properly.

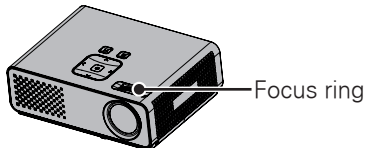

- To adjust the focus of the image, rotate the focus ring.

Watching Projector

- 1 In Standby mode, press the **POWER** to turn the projector on.
- 2 Press **INPUT** and select desired input.
- 3 Control the projector using the following buttons while you are watching projector.

Button	Description
CH\wedge, V	Scrolls through saved channels.
LIST	Selects a channel on the saved or recent watched channel list.
0 - 9	Selects a channel by entering numbers.
VOL -, +	Adjusts the volume level.
MUTE	Mutes all sounds.
Q.MENU	Accesses the quick menus. (See p.26)
FLASHBK	Alternates between the last two channels selected.
RATIO	Resizes an image.
Key's	Adjusts Keystone. (See p.25)

- 4 To turn the projector off, press the **POWER**.

Managing Channels

Setting Up Channels

Storing Channels

To store channels automatically,

- 1 Press **MENU** to access the menu.
- 2 Press the Navigation buttons to scroll to **CHANNEL** and press **OK**.
- 3 Press the Navigation buttons to scroll to **Auto Tuning** and press **OK**.
- 4 Select **Start** to start automatic tuning. The projector scans and saves available channels automatically.
- 5 When you are finished, press **EXIT**.

To store channels manually,

- 1 Press **MENU** to access the menu.
- 2 Press the Navigation buttons to scroll to **CHANNEL** and press **OK**.
- 3 Press the Navigation buttons to scroll to **Manual Tuning** and press **OK**.
- 4 Scroll through the channel types, and then add or delete channels.
- 5 When you are finished, press **EXIT**.

NOTE

- If the projector scans a blocked channel, you will be prompted to enter your password to keep the channel scanned.
- You can store up to 1000 channels. The number of channels that you can store differs depending on the broadcasting signal environment.
- The channels are stored in the order of DTV, TV, Cable DTV and Cable TV.

Editing Your Channel List

- 1 Press **MENU** to access the menu.
- 2 Press the Navigation buttons to scroll to **CHANNEL** and press **OK**.
- 3 Press the Navigation buttons to scroll to **Channel Edit** and press **OK**.
- 4 Edit channels using the following buttons.

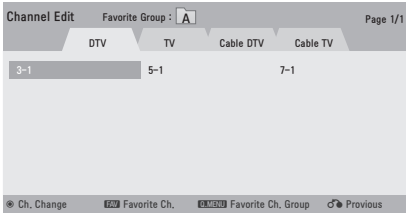

Button	Description
OK	Selects the highlighted channel to view.
^, v, <, >	Scrolls through channel types or channels.
FAV	Adds a favorite channel list.
CH	Moves to the previous or next page.
Q.MENU	Changes the favorite group.
Yellow	Block or unblock a channel.
Blue	Adds or deletes a channel. The deleted channel displays in blue.

- 5 When you are finished, press **EXIT**.

Favorite Channel Setup

- 1 Press **CH** or Number buttons to access to select your desired channel.
- 2 Press **FAV.** to access the **Favorite List**.
- 3 Press the **<, >** buttons to scrolls through channel group.
- 4 Press the **Yellow** button.

Favorite Channel List

- 1 Press **FAV.** to access the **Favorite List**.
- 2 Press the Navigation buttons to scroll to a channel.and press **OK**.



Button	Description
^, v	Scrolls through channels.
<, >	Scrolls through channel group.
CH	Moves to the previous or next page
Yellow	Register or cancel the current channel in favorite channel list.
Blue	Go to the "CHANNEL menu - Channel Edit".

Using Additional Options

Adjusting Aspect Ratio

Resize an image to view at its optimal size by pressing **RATIO** while you are watching projector.

! NOTE

- Some options may not be available depending on input signals.
- You can also change the image size by pressing **Q.MENU** or **MENU**.

- **16:9**: Resizes images to fit the screen width.



- **Just Scan**: Displays video images in the original size without cutting off the edges.



! NOTE

- If you select **Just Scan**, you may see image noises at the edge or edges of the screen.

- **Set By Program**: Displays images in the same aspect ratio as the original image.



- **4:3**: Resizes images to the previous standard.



- **Zoom**: Enlarges an image to fit the screen width. The top and bottom of the image may not appear.
 - Adjust proportion of Zoom, press **<** or **>**.
 - Move the image on the screen, press **^** or **v**.



- **Cinema Zoom**: Formats an image to the cinemscope ratio, 2.35:1.
 - To change the ratio of the cinema zoom, press **<** or **>** and its range is from 1 to 16.
 - To move the zoom focus up or down, press **^** or **v**.



! NOTE

- If you enlarge or reduce an image, the image may be distorted.

Using Keystone Function

Use this function when the screen is not at a right angle to the projector and the image is a trapezoid shape. Only use the **Keystone** function when you can't get the best angle by moving the projector.



- 1 Press **Key's▲**, **Key's▼** to adjust the screen condition as you want.
- 2 When you are finished, press **EXIT**.
 - **Keystone** can be adjusted from **-40** to **40**.

Using the Input List

Using the Input List

- 1 Press **INPUT** to access the input sources.
 - The connected device displays on each input sources, only TV and AV input are always active.

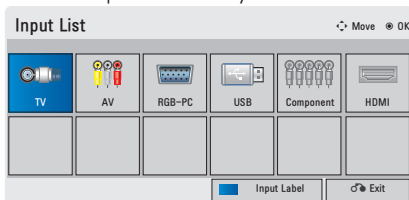

- 2 Selecting an input signal with the **INPUT** button will only change the projector only to connected inputs. Press the Navigation buttons to scroll to any inputs.

Adding an Input Label

Add a label to an input source so that you can easily identify a device connected to each input source.

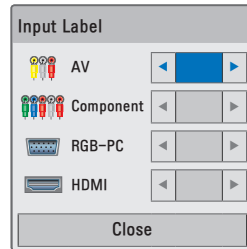

- 1 Press **INPUT** to access the input sources.
- 2 Press the **Blue**.
- 3 Press the Navigation buttons to scroll to one of the input sources.
- 4 Press the Navigation buttons to scroll to one of the input labels.
- 5 When you are finished, press **EXIT**.

Blank Function

Using Blank Function

This function may be effective if you need to get the attention of the audience during presentations, meetings or briefings.

- 1 Press the **BLANK** to turn off the screen.

You can choose the background color. (Refer to "Selecting Blank Image")

- 2 Press any button to cancel the blank function.

To temporarily turn off the image on the screen, press **BLANK**. Do not block the projection lens with any objects when the projector is under operation as this could cause the objects to become heated and deformed or even cause a fire.

Selecting Blank Image

- 1 Press **MENU** to access the menu.
- 2 Press the Navigation buttons to scroll to **OPTION** and press **OK**.
- 3 Press the Navigation buttons to scroll to **Blank Image** and press **OK**.
- 3 Press the Navigation buttons to scroll to the setting or option you want and press **OK**.
- 4 When you are finished, press **EXIT**.

Using the Quick Menu

Customize frequently used menus.

- 1 Press **Q.MENU** to access the quick menus.
- 2 Press the Navigation buttons to scroll through the following menus and press **OK**.

Menu	Description
Aspect Ratio	Changes the image size. (See p.24)
Picture Mode	Changes the image mode. (See p.57)
LED Mode	To adjust the brightness of the image. (See p.66)
Multi Audio	Changes the audio language (Digital signal)
SAP	Changes the MTS sound (Analog signal)
Sleep Timer	The sleep timer turns the projector off at the preset time.
Del/Add	Edits the channels to add or delete the channel.
PJT Mode	Turns the projected image upside down or flips horizontal.
USB Device	Eject a USB device. The menu is displayed only when the USB device is connected.

- 3 Press the Navigation buttons to scroll to the option you want.
- 4 When you are finished, press **Q.MENU**.

ENTERTAINMENT

Network Connection

Connecting to a Wireless Network

The LG Wireless LAN for Broadband/DLNA Adaptor, allows the projector to connect to a wireless LAN network.

The network configuration and connection method may vary depending on the equipment in use and the network environment. Refer to the setup instructions supplied with your access point or wireless router for detailed connection steps and network settings.

Setting up the AP (Access Point) or the wireless router is required before connecting the projector to the network. The easiest method is the WPS button method (Third method in this section).

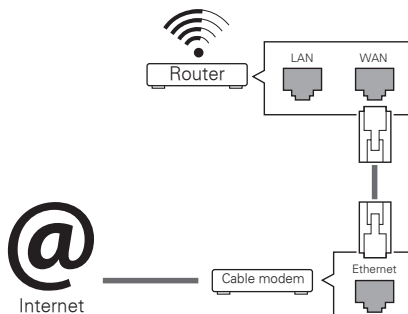
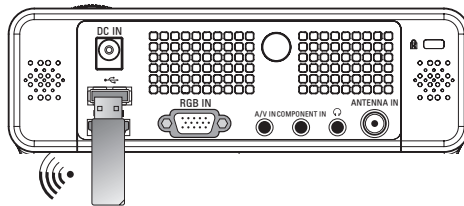

! NOTE

- When the wireless port of the router is used, there may be restrictions on some functions.

Setting to a Wireless Network

To set up the network settings,

- 1 Press **MENU** to access the menu.
- 2 Press the Navigation buttons to scroll to **NETWORK** and press **OK**.
- 3 Press the Navigation buttons to select **Network Setting** and press **OK**.
- 4 Press the Navigation buttons to select **Setting from the AP list** and press **OK**.

- Scan the all available AP (Access Point) or wireless routers within range and display them as a list.

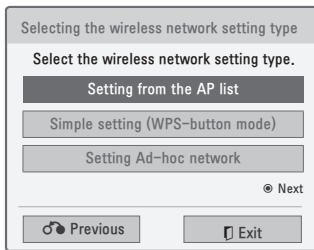

- 5 Press the Navigation buttons to select an AP (Access Point) or wireless router on the list. (If your AP is secured, you will be prompted for the key. and press **OK**).

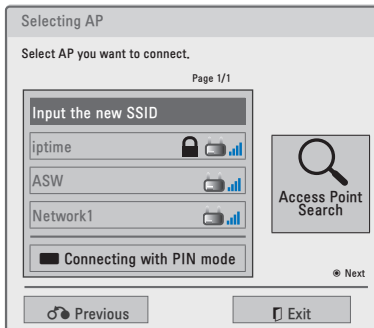

- 6 Press the Number buttons of the remote controller or select the proper buttons on the image to Input the security key of AP and press **OK**.

PIN(Personal Identification Number)

If your router is set to use a PIN , use the following instructions.

- 1 Repeat step 1-4 on "Setting to a Wireless Network".
- 2 Press the **Red** to connect the access point with **PIN** mode.
- 3 You can see the PIN number on your screen. Enter the PIN number to your device. PIN number is the unique 8 digit number of the dongle.
- 4 Press **OK** to select **Connect**.

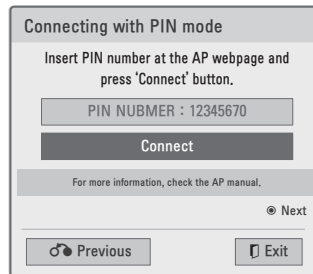

- 5 If you have already set the Network Setting, select **Resetting**. The new connection settings will reset the current network settings.

6 Select **IP Auto Setting** or **IP Manual Setting**.

- If selecting **IP Manual Setting**, press the Navigation and Number buttons. IP addresses will need to be input manually.
- **IP Auto Setting:** Select this if there is a DHCP server (Router) on the local area network (LAN) via wired connection, the projector will automatically be allocated an IP address. If you're using a broadband router or broadband modem that has a DHCP (Dynamic Host Configuration Protocol) server function, the IP address will automatically be determined.
- **IP Manual Setting:** Select if there is no DHCP server on the network or you want to set the IP address manually.

7 When you are finished, press **EXIT**.

WPS (Wi-Fi Protected Setup)

If your router or AP has a WPS button, there is the easiest connection method. You simply press the button on the router and then select the WPS on the projector within 120 seconds.

- 1 Repeat step 1-3 on "Setting to a Wireless Network".
- 2 Press the Navigation buttons to select the **Simple setting (WPS-button mode)**.
- 3 Press the WPS button on your router.
- 4 Go back to the projector and select **Connect**.

5 Repeat step 5-6 on "PIN(Personal Identification Number)".

Ad-hoc Mode

Ad-hoc mode allows the projector to use a wireless to connect to a computer without using a router or access point.

- 1 Repeat step 1-3 on "Setting to a Wireless Network".
- 2 Press the Navigation buttons to select **Setting Ad-hoc network** and press **OK**.
- 3 Press the Navigation buttons to select Enter and press **OK**.
- 4 Press **OK** to select Connect to connect Ad-hoc network.
 - You can see the Network ID and Security Key on your screen.
 - Enter this Network ID and Security Key to your device.
 - When needed, you can change the setting information using the **Red**.



NOTE

When searching for wireless networks on your PC using ad-hoc, the projector is named LGPJTO.

- LGPJTO that appears in the list. (Select the same name as the network ID that appears on your screen.)

5 Press the Navigation buttons to type in an IP address and press **OK**.

- **PC Setting:** Internet Protocol(TCP/IP) of PC needs to be set manually. IP address, Subnet Mask, and default Gateway can be set with your own discretion. e.g.) IP address: 192.168.0.1 / Subnet Mask: 255.255.255.0 / default Gateway: 192.168.0.10

- **Projector Setting:** Verify IP address and gateway of PC. Input Gateway address of PC to IP Address, and IP Address of PC to Gateway, and select Enter. e.g.) IP address: 192.168.0.10 / Subnet Mask: 255.255.255.0 / default Gateway: 192.168.0.1

6 Press the Navigation buttons to select **Close** after Network setting is completed.

7 Press the **OK**.

Tips for Network Setting

- Many network connection problems during set up can often be fixed by re-setting the router or modem. After connecting the player to the home network, quickly power off and/or disconnect the power cable of the home network router or cable modem. Then power on and/or connect the power cable again.
- Depending on the internet service provider (ISP), the number of devices that can receive internet service may be limited by the applicable terms of service. For details, contact your ISP.
- LG is not responsible for any malfunction of the projector and/or the internet connection failure due to communication errors/malfunctions associated with your broadband internet connection, or other connected equipment.
- LG is not responsible for problems within your internet connection.
- Some content available through the network connection may not be compatible with the projector. If you have questions about such content, please contact the producer of the content.
- You may experience undesired results if the network connection speed does not meet the requirements of the content being accessed.

- Some internet connection operations may not be possible due to certain restrictions set by the Internet service provider (ISP) supplying your broadband Internet connection.
- Any fees charged by an ISP including, without limitation, connection charges are your responsibility.
- A DSL modem is required to use DSL service and a cable modem is required to use cable modem service. Depending on the access method of and subscriber agreement with your ISP, you may not be able to use the internet connection feature contained in this projector or you may be limited to the number of devices you can connect at the same time. (If your ISP limits sub-scription to one device, this projector may not be allowed to connect when a PC is already connected.)
- The use of a "Router" may not be allowed or its usage may be limited depending on the policies and restrictions of your ISP. For details, contact your ISP directly.
- The wireless network operates at 2.4 GHz radio frequencies that are also used by other household devices such as cordless telephone, Bluetooth® devices, microwave oven, and can be affected by interference from them. It can be interrupted by the device using 5 GHz radio frequencies. It is same device as LG wireless media box, cordless telephone, other Wi-Fi device.
- It may decrease the service speed using Wireless network by surrounding wireless condition.
- Turn off all unused network equipment in your local home network. Some devices may generate network traffic.
- In some instances, placing the access point or wireless router higher up away from the floor may improve the reception.
- The reception quality over wireless depends on many factors such as type of the access point, distance between the projector and access point, and the location of the projector.
- When connecting internet through the wireless sharing machine, it may interrupt the connection because of the use limitation and confirmation of service company.
- To connect wireless AP, an AP that supports the wireless connection is necessary, and the wireless connection function of the AP needs to be activated. Please enquire to the AP supplier for the possibility of AP wireless connections.
- Please verify the security settings of AP SSID for wireless AP connection, and enquire to the AP supplier for the AP SSID security settings.
- The Projector can become slower or malfunction with wrong settings of network equipments (wired/ wireless router, hub, etc). Please install correctly by referring to the manual of the equipment, and set the network.

- When AP is set to include 802.11 n, and if Encryption is designated as WEP(64/128bit) or WPA(TKIP/AES), the connection may not be possible. There may be different connection methods according to the AP manufacturers.

Network Status

To set up the network settings,

- 1 Press **MENU** to access the menu.
- 2 Press the Navigation buttons to scroll to **NETWORK** and press **OK**.
- 3 Press the Navigation buttons to scroll to **Network Status.** and press **OK**.
- 4 Press **OK** to check the network status.

Option	Description
Setting	Return to the network setting menu or wireless network setting type menu.
Test	Test the current network status after setting the network.
Close	Return to the previous menu.

NETCAST

Stream movies, Game, SNS, Internet Radio or weather updates directly to your projector.

Using the NETCAST

- 1 Press **NETCAST** to access the menu option.
- 2 Press the Navigation buttons to scroll to the content you want and press **OK**.

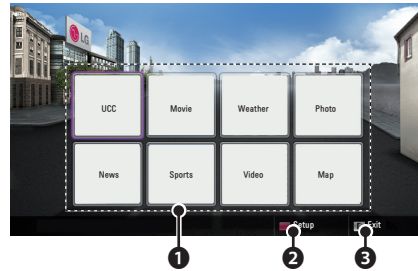

No.	Description
1	Selects your desired online service. If a service requires you to log in, you must first sign up for the service on your computer and then log into the service on the projector.
2	Set the option menu.
3	Exit NETCAST.

- 3 Enjoy the NETCAST features.

**NOTE**

- The videos list searched from the projector may differ with the list searched from a web browser on PC.
- The playback of videos may pause, stop, or buffer depending on your broadband speed.
- For service that requires log in, join the applicable service on the website using the PC and log in through the projector to enjoy various additional functionalities.
- When you set the city you want with Setup by pressing the red button, the background of NetCast will be set to the weather of the selected city.

Notice

- These services are provided by separate content providers.
- Please visit the content providers web site for specific information on their service.
- Premium menu can differ by country.
- Note that content may be updated automatically depending on the service provider, so the content layout or operation method may change without notice. Please refer to the help menu on the screen.
- All information, data, documents, communications, downloads, files, text, images, photographs, graphics, videos, webcasts, publications, tools, resources, software, code, programs, applets, widgets, applications, products and other content ("Content") and all services and offerings ("Services") provided or made available by or through any third party (each a "Service Provider") is the sole responsibility of the Service Provider from whom it originated.
- The availability of and access to Content and Services furnished by the Service Provider through the LGE Device are subject to change at any time, without prior notice, including, but not limited to the suspension, removal or cessation of all or any part of the Content or Services.

- Should you have any inquiry or problem related to the Content or Services, you may refer to the Service Provider's website for the most up-to-date information. LGE is neither responsible nor liable for customer service related to the Content and Services. Any question or request for service relating to the Content or Services should be made directly to the respective Content and Service Providers.
- Please note that LGE is not responsible for any Content or Services provided by the Service Provider or any changes to, removal of, or cessation of such Content or Services and does not warrant or guaranty the availability of or access to such Content or Services.
- Some content may be harmful to minors depending on the service provider. Parental guidance is necessary.
- The service may be interrupted if the Internet connection is unstable. Please check the connection status if you experience this problem.
- The videos list searched from the projector may differ with the list searched from a web browser on PC.
- The playback of videos may pause, stop, or buffer depending on your broadband speed.
- For service that requires log in, join the applicable service on the website using a PC and log in through the projector to enjoy various additional functions.

Legal Notice

IMPORTANT NOTICE RELATING TO NETWORK SERVICE

All content and services accessible through this device belong to third parties and are protected by copyright, patent, trademark and/ or other intellectual property laws. Such content and services are provided solely for your personal noncommercial use. You may not use any content or services in a manner that has not been authorized by the content owner or service provider. Without limiting the foregoing, unless expressly authorized by the applicable content owner or service provider, you may not copy, upload, post, transmit, translate, sell, modify, create derivative works, or distribute in any manner or medium any content or services displayed through this device. YOU EXPRESSLY ACKNOWLEDGE AND AGREE THAT THE DEVICE AND ALL THIRD PARTY CONTENT AND SERVICES ARE PROVIDED "AS IS" WITHOUT WARRANTY OF ANY KIND, EITHER EXPRESS OR IMPLIED. LG ELECTRONICS EXPRESSLY DISCLAIMS ALL WARRANTIES AND CONDITIONS WITH RESPECT TO ANY CONTENT AND SERVICES, EITHER EXPRESS OR, IMPLIED, INCLUDING BUT NOT LIMITED TO, WARRANTIES OF MERCHANTABILITY, OF SATISFACTORY QUALITY, FITNESS FOR A PARTICULAR PURPOSE, AND NON-INFRINGEMENT OF THIRD PARTY RIGHTS. LG DOES NOT GUARANTEE THE ACCURACY,

VALIDITY, TIMELINESS, LEGALITY, OR COMPLETENESS OF ANY CONTENT OR SERVICE MADE AVAILABLE THROUGH THIS DEVICE AND DOES NOT WARRANT THAT THE DEVICE OR SERVICES WILL MEET YOUR REQUIREMENTS, OR THAT OPERATION OF THE DEVICE OR SERVICES WILL BE UNINTERRUPTED OR ERROR-FREE. UNDER NO CIRCUMSTANCES, INCLUDING NEGLIGENCE, SHALL LG BE LIABLE, WHETHER IN CONTRACT OR TORT, FOR ANY DIRECT, INDIRECT, INCIDENTAL, SPECIAL OR CONSEQUENTIAL DAMAGES, OR ANY OTHER DAMAGES ARISING OUT OF, ANY INFORMATION CONTAINED IN, OR ANY CONTENT OR SERVICE ACCESSED BY YOU OR ANY THIRD PARTY, EVEN IF ADVISED OF THE POSSIBILITY OF SUCH DAMAGES.

Third party services may be changed, suspended, removed, terminated or interrupted, or access may be disabled at any time, without notice, and LG makes no representation or warranty that any content or service will remain available for any period of time. Content and services are transmitted by third parties by means of networks and transmission facilities over which LG has no control. LG may impose limits on the use of or access to certain services or content, in any case and without notice or liability. LG expressly disclaims any responsibility or liability for any change, interruption, disabling, removal of or suspension of any content or service made available

through this device.

LG is neither responsible nor liable for customer service related to the content and services. Any question or request for service relating to the content or services should be made directly to the respective content and service providers.

MY MEDIA

Connecting USB Storage Devices

Connect USB storage devices such as a USB flash drive or external hard drive to the projector and use multimedia features.

Connect a USB flash drive or USB memory card reader to the projector as shown in the following illustration.

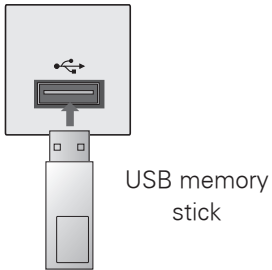

To disconnect a USB storage device, make sure to end the connection properly to prevent damages to the projector or files.

- 1 Press **Q.MENU** to access the quick menus.
- 2 Press the Navigation buttons to scroll to **USB Device** and press **OK**.
- 3 Disconnect the USB storage device only when the message says that it is safe to remove.

NOTE

- After Eject USB, USB memory cannot be read. Remove USB memory, and connect again.

Tips for Using

USB Storage Devices

- Only a USB storage device is recognizable.
- USB hubs are not supported.
- A USB storage device which uses its own driver may not be recognized.
- The recognition speed of a USB storage device will depend on each device.
- Please do not turn off the projector or unplug the USB device when the connected USB storage device is operating. When such a device is suddenly separated or unplugged, the stored files or the USB storage device may be damaged.
- Please do not connect the USB storage device which was artificially maneuvered on the PC. The device may cause the product to malfunction or fail to be played. Never forget to use only a USB storage device which has normal music files, image files, movie files or text files.
- Please use only a USB storage device which was formatted as a FAT16, FAT32 and NTFS file system provided with the Windows operating system. In case of a storage device formatted as a different utility programmed which is not supported by Windows, it may not be recognized.
- Please connect power to a USB storage device which requires an external power supply. If not, the device may not be recognized.
- Please connect a USB storage device with cable is offered by USB maker. If connected with cable is not offered by USB maker or an excessively long cable, the device may not be recognized.
- Some USB storage devices may not be supported or operate smoothly.
- If the name of a folder or file is too long, it will not be displayed or recognized.
- File alignment method of USB storage device is similar to Window XP and filename with up to 100 english characters can be recognized.
- Please backup important files because a data of USB device may be damaged. Data management is consumer's responsibility and in consequence the manufactures does not cover data damage.
- The recommended capacity is 1TB or less for a USB external hard disk and 32GB or less for USB memory. Any device with more than the recommended capacity may not work properly.
- If the USB memory device does not work properly, disconnect and reconnect it.
- If a USB external hard disk with a "Energy Saving" function does not work, turn the hard disk off and on again to make it work properly.
- USB storage devices below USB 2.0 are supported as well. But they may not work properly in the movie list.

Connecting DLNA DMP (Digital Living Network Alliance, Digital Media Player)

This projector can display and play many types of movie, photo and music files from your DLNA server. The Digital Living Network Alliance (DLNA) is a cross-industry organization of consumer electronics, computing industry and mobile device companies. DLNA provides consumers with easy sharing of digital media through a wired or wireless network in the home. The DLNA certification logo makes it easy to find products that comply with the DLNA Interoperability Guidelines. This unit complies with DLNA Interoperability Guidelines v1.5. When a PC running DLNA server software or other DLNA compatible device is connected to this projector, some setting changes of software or other devices may be required. Please refer to the operating instructions for the software or device for more information.

Please refer to "MY MEDIA" for additional information on supported file types and other instructions.

- The supplied Nero MediaHome 4 Essentials CD-ROM is a customized software edition only for sharing files and folders to this projector. The supplied Nero MediaHome 4 Essentials software does not support following functions: Transcoding, Remote UI, projector control, Internet services and Apple

iTunes

- This manual explains operations with the English version of Nero MediaHome 4 Essentials as examples. Follow the explanation referring to the actual operations of your language version.
- Check your network settings when the DLNA option does not work properly.
- If there is an abnormal operation or an error occurs in Nero Media Home, the DLNA option may not work properly. In this case, exit Nero Media Home and restart the programme. You can download the latest version of Nero Media Home by clicking the question mark at the bottom-left of the program.
- When the network is unstable, the device may be slower or may need to load during playback.
- When playing a video in DLNA mode, the Multi Audio and Closed Caption features are not supported.
- When selecting Full Screen in DLNA mode, the ratio of the outputted screen may differ from the original.
- When more than one projector is connected to a single server in DLNA mode, a file may not play properly, depending on the server performance.
- If the play time information is not provided by the server, it is displayed as "--:--:--."
- DLNA operation may not work properly according to the AP manufacturers.

Installing Nero MediaHome 4 Essentials

Nero MediaHome 4 Essentials is easy to use DLNA server software for Windows.

Computer requirements for Nero MediaHome 4 Essentials

- Windows® XP (Service Pack 2 or higher), Windows Vista® (no Service Pack required), Windows® XP Media Center Edition 2005 (Service Pack 2 or higher), Windows Server® 2003
- Windows Vista® 64-bit edition (application runs in 32-bit mode)
- Hard drive space: 200 MB hard drive space for a typical installation of Nero MediaHome stand-alone
- 1.2 GHz Intel® Pentium® III or AMD Sempron™ 2200+ processors
- Memory: 256 MB RAM
- Graphics card with at least 32 MB video memory, minimum resolution of 800 x 600 pixels, and 16-bit color settings
- Windows® Internet Explorer® 6.0 or higher
- DirectX® 9.0c revision 30 (August 2006) or higher
- Network environment: 100 Mb Ethernet, WLAN (IEEE 802.11a/b/g/n)

- 1 Close all Microsoft Windows programs and exit any anti-virus software that may be running.
- 2 Insert the Nero MediaHome 4 Essentials CD-ROM into your computer's CD-ROM drive.
- 3 Click **Nero MediaHome 4 Essentials**. The installation is prepared and the installation wizard appears.
- 4 Click the **Next** button to display the serial number input screen. Click **Next** to go to the next step.
- 5 If you accept all conditions, click **I accept the License Conditions** check box and click **Next**. Installation is not possible without this agreement.
- 6 Click **Typical** and click **Next**. The installation process is started.
- 7 If you want to take part in the anonymous collection of data, select the check box and click the **Next** button.
- 8 Click the **Exit** button to complete the installation.

Sharing Files and Folders

After installing Nero MediaHome, you must add folders you wish to share.

- 1 Double-click the **Nero MediaHome 4 Essentials** icon on the desktop.
- 2 Click **Network** icon on the left and define your network name in the **Network name** field. The Network name you enter will be recognized by your projector.
- 3 Click **Shares** icon on the left.
- 4 Click **Local Folders** tab on the **Shared** screen.
- 5 Click **Add** icon to open the **Browse Folder** window.
- 6 Select the folder containing the files you want to share. The selected folder is added to the list of shared folders.
- 7 Click **Start Server** icon to start the server.



NOTE

- If the shared folders or files are not displayed on the projector, click the folder on the **Local Folders** tab and click **Rescan Folder** at the **More** button.
- Visit www.nero.com for more information and software tools.

Playing Shared contents

You can display and play movie, photo and music content stored on your computer or other DLNA media servers.

- 1 Press the USB button. Then, move to **MOVIE/PHOTO/MUSIC LIST** with the Navigation buttons and press the **OK** button. Press the Blue buttons to search other network device.
2. Press the Navigation buttons move to a desired file and press the **OK** button.

Tips for using DLNA DMP

- To play the file on the media server, the projector and the media server must be connected to the same access point.
- Because the compatibility and available playback functions on the **MY MEDIA** menu are tested on the bundle DLNA server (Nero MediaHome 4 Essentials) environment, file requirements and playback functions on the **MY MEDIA** may differ depending on media servers.
- Even the files that are not supported can be displayed in photo thumbnail or music thumbnail.
- Movie thumbnail is not supported in DLNA Movie.
- If there is an unplayable music file in the **MY MEDIA** menu, the projector will skip the file and play next file.
- The file information indicated on the screen may not always correct for music and movie files in **MY MEDIA** menu
- This projector only supports movie subtitle files supplied by Nero MediaHome 4.
- The subtitle file name and movie file name have to be the same and located at the same folder.
- If subtitle files have been added after a directory has been indexed already, the user has to remove and re-add the folder to the list of shares.
- The playback and operating quality of the **MY MEDIA** function may be affected by your home network condition.
- The files from removable media such as USB drive, DVD-drive etc. on your media server may not share properly.
- When playing the Media through DLNA connection, it does not support the DivX file play which is protected by DRM.
- Up to 200 folders in one folder and 999 including folders and files can be recognized.
- If there are too many folders and files in one folder, it may not operate properly.

Connecting DLNA DMR (Digital Living Network Alliance, Digital Media Render)

This supports remote playing of media files. Media from a compatible device (Windows 7, Mobile Phone with PlayTo, or other compatible DLNA-DMC device) can be “pushed” to the projector.

The DMR function only works properly when the projector and PC are on the same local network.

- 1 To play a file, select the file by using the “Remote Play” feature in Windows 7.
To do this, right-click on the file you want to play.
- 2 You can play a file only on a single projector set or device even though multiple devices are connected. The playback speed depends on the network status.



NOTE

- Subtitle is supported only on some DMC devices.
- The DMR function may not work properly in a wireless network.
- The seek function of the DMC only works on video files.
- The DMR is not available when another function is operating (MY MEDIA work etc.).
- Refer to the owner’s manual of the mobile phone or other device to find out how to use it to play a file.
- You can change the name of a connected projector by double-clicking the item you want to change in Control Panel > Network and Internet > View network computers and devices (For Windows 7).
- You cannot change the name of a projector while DMR media is playing. Change it when playback is stopped.

MOVIE LIST

* The movie list is activated once USB is detected. It is used when playing movie files on projector.

Tips for playing video files

- Some user-created subtitles may not work properly.
- Some special characters are not supported in subtitles.
- HTML tags are not supported in subtitles.
- Time information in an external subtitle file should be arranged in ascending order to be played.
- Changing font and color in subtitles is not supported.
- Subtitles in languages other than one specified are not supported.
- Subtitle files of 1 MB or larger may not be played properly.
- The screen may suffer temporary interruptions (image stoppage, faster playback, etc.) when the audio language is changed.
- A damaged video file may not be played correctly, or some functions may not be usable.
- Video files produced with some encoders may not be played correctly.
- If the video and audio structure of recorded file is not interleaved, the file not playback properly.
- Video with resolution higher than maximum resolution supported for each frame, cannot be guaranteed for smooth playback.
- Video files other than the specified types and formats may not work properly.
- The movie file encoded by the GMC (Global Motion Compensation) and Qpel (Quarterpel Motion Estimation) is not supported.
- Only 10000 sync blocks are supported within the subtitle file.
- We do not guarantee smooth playback of profiles encoded level 4.1 or higher in H.264/AVC.
- DTS Audio codec is not supported.
- A video file more than 30GB in file size is not supported for playback.
- Playing a video via a USB connection that doesn't support high speed may not work properly.
- The video file and its subtitle file must be located in the same folder. At this time, a video file name and its subtitle file name must be identical for it to be displayed.
- When you are watching a movie via the Movie List function, user setup for each picture mode is not supported.
- Trick Mode does not support other functions than ►► if video files do not have index information.
- When playing video file using network, the Trick mode is limited to 2-times speed.
- Video file names that contain special characters may not be playable.

DivX supported mode

File Extensions	Audio/Video	Codec	Profile/Level Support	Explanation
.asf .wmv	Video	VC-1 Advanced Profile	Advanced Profile @ Level 3 (e.g. 720p 60, 1080i 60, 1080p 30)	Only streams compliant to SMPTE 421M VC-1 standard are supported.
		VC-1 Simple and Main Profiles	Simple Profile @ Medium Level (e.g. CIF, QVGA) Main Profile @ High Level (e.g. 1080p 30)	
	Audio	WMA Standard		
		WMA 9 Professional		
.divx .avi	Video	DivX3.11	Advanced Simple Profile(720p/1080i)	Global motion compensation or quarterpel motion estimation does not supported. Streams using this syntax are not supported.
		DivX4 DivX5 DivX6 XViD		
Audio	H.264 / AVC	Main Profile@ Level 4.1 High Profile@ Level 4.1 (e.g. 720p60, 1080i60, 1080p30)		
	MPEG-1 Layer I, II MPEG-1 Layer III (MP3) Dolby Digital			
.mp4 .m4v	Video	H.264 /AVC	Main Profile @Level 4.1 High Profile @Level 4.1 (e.g. 720p 60, 1080i 60, 1080p 30)	Global motion compensation or quarterpel motion estimation does not supported. Streams using this syntax are not supported.
		MPEG-4 Part 2	Advanced Simple Profile(e.g. 720p/1080i)	
Audio	AAC	AAC-LC and HE-AAC		
	Video	H.264 /AVC	Main Profile @Level 4.1 High Profile @Level 4.1 (e.g.720p 60, 1080i 60, 1080p 30)	Most of the MKV content available is encoded by the open source x264 codec.
Audio		HE-AAC	HE-AAC-LC and HE-AAC	
	Dolby Digital			
.ts .trp .tp		Video	H.264 /AVC	Main Profile @Level 4.1 High Profile @Level 4.1 (e.g. 720p 60, 1080i 60, 1080p 30)
	MPEG-2		Main Profile @High Level (e.g. 720p 60, 1080i 60)	
	Audio	VC-1	Simple Profile@Medium Level (e.g. CIF, QVGA) Main Profile@High Level (e.g. 1080p30) Advanced Profile@Level3 (e.g. 720p60, 1080i60, 1080p30)	
MPEG-1 Layer I, II MPEG-1 Layer III (MP3) Dolby Digital				
AAC	AAC-LC and HE-AAC			
	Video	MPEG-1		
MPEG-2		Main Profile @High Level (e.g. 720p 60, 1080i 60)		
.vob	Audio	Dolby Digital MPEG-1 Layer I, II DVD-LPCM		
		Video	MPEG-1	Main Profile@High Level (e.g. 720p60, 1080i60)
.mpg .mpeg .mpe	Audio	MPEG-1 Layer I, II		Only streams compliant configured properly for TS, PS or ES

Bit rate range : within 32 kbps - 320 kbps (MP3)

Subtitle format : *.smi/*.srt/*.sub(MicroDVD, SubViewer1.0/2.0)/*.ass/*.ssa/*.txt(TMPlayer)/*.psb(PowerDivX)

Browsing Movie List

Play video files on the screen. Your screen can display video files from a USB storage device.

- 1 Connect a USB storage device.
- 2 Press **USB** to access the Home menu.
- 3 Press the Navigation buttons to scroll to **Movie List** and press **OK**.
- 4 Press the Navigation buttons to scroll to the device you want and press **OK**.
- 5 Press Navigation buttons to select a folder or file you want and press **OK**.

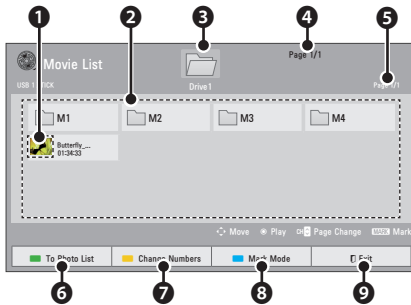

No.	Description	
1	Thumbnail	
	Abnormal files	
	Non-supported files	
2	Contents List	
3	Moves to upper level folder	
4	Current page/Total pages of folders	
5	Current page/Total pages of contents	
6	Move to Photo List.	
7	Changes the number or thumbnails displayed at a time.	
8	Allows you to mark certain files. Select files you want and press Color buttons .	
	Play Marked	Press Red . Play the first selected file.
	Mark All	Press Green . Mark all files in the folder.
	Unmark All	Press Yellow . Deselect all marked files.
	Exit Mark Mode	Press Blue . Enter or exit the Mark Mode.
9	Exit.	

- 6 Play a movie by using the following menus/buttons.



Button	Description
<, >	Move to a specific frame forward or backward while playing a video. A cursor indicating the position can be viewed on the screen. It may not work properly for some movie files.
■	Stop the media player. Back to the Movie List
▶	Return to normal playback.
	Pauses the media player. If no buttons are pressed on the remote control for 10 minutes after pausing, the projector returns to the playback state.
and ▶▶	Displays slow motion.
◀▶	Select the required speed: x2, x4, x8, x16, x32 (backward/forward).
Q.MENU Option	Popup Option menu. See "Options for Movie List".
Hide	Hide the menu on screen. To see the menu again, press OK .
Exit	Return to Movie List .

Options for Movie List

- 1 Press **Q.MENU**.
A pop-up window will appear.
- 2 Press the Navigation buttons to scroll to the option and press **OK**.
- 3 Press the Navigation buttons to scroll to one of the following options and press **OK**.

Set Video Play.

Option	Description
Picture Size	Selects your desired picture format for videos. <ul style="list-style-type: none"> • Full: Files are played in full screen mode regardless of the aspect ratio of video. • Original: Files are played according to the aspect ratio of video.
Audio Language	Changes the Language Group of the audio for video files. Files with a single audio track cannot be selected.

Option	Description
Subtitle Language	<p>The subtitles can be turned on or off.</p> <ul style="list-style-type: none"> • Language: Activated for SMI subtitles and can select the language within the subtitle. • Code Page: Subtitle font selection. When set to default, contents are displayed in the language set in OPTION - Menu Language. • Sync: When the video is not synchronized with the captions, it can be adjusted by 0.5 second. • Position: Move the location of the subtitles. • Size: Changes the subtitle font size.
Repeat	<p>Turn on/off repeat function of movie playback.</p> <p>When turned off, if the next file name is similar to the previous file, it can be played sequentially.</p>

- **Language**

Subtitle Language Group	Supported Language
Latin1	French, Spanish, Catalan Basque, Portuguese, Italian, Albanian, Rhaeto-Romanic, Dutch, German, Danish, Swedish, Norwegian, Finnish, Faeroese, Icelandic, Irish, Scottish, English
Korean	English, Korean

Set Video.

Allows you to change Video presets (Refer to "PICTURE Settings" on page 56).

Set Audio.

Allows you to change Audio presets (Refer to "AUDIO Settings" on page 61).

Registering the DivX code

- The DivX registration code allows you to rent or purchase the latest movies at www.divx.com/vod. To play a rented or purchased DivX file, the file's registration code should be same as your projector's DivX registration code.

- 1 Press **USB** to access the Home menu and press **Blue**.

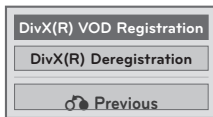

- 2 Press the Navigation buttons to scroll to **DivX(R) VOD Registration** and press **OK**.

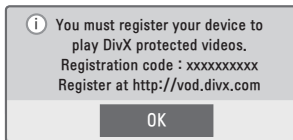

- 3 View the registration code of your projector.

! NOTE

- While you are checking the registration code, some buttons may not work.
- If you use the DivX registration code of another device, you cannot play the rented or purchased DivX file. Make sure to use the DivX registration code assigned to your projector.
- The video or audio files that are not converted by the standard DivX codec may be corrupted or not be played.
- The DivX VOD code allows you to activate up to 6 devices under one account.

Deactivating the DivX feature

- You can deactivate all of the devices through the web server and block devices from activating. Delete the existing authentication information to receive a new DivX user authentication for the projector. Once this function is executed, a DivX user authentication is required again to see DivX DRM files.

- 1 Press **USB** to access the Home menu and press **Blue**.
- 2 Press the Navigation buttons to scroll to **DivX(R) Deregistration** and press **OK**.
- 3 Select **Yes** to confirm.

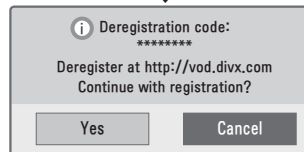
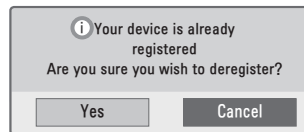

! NOTE

- DRM (Digital Rights Management) function: These are the technology and the service that prevents the illegal use of digital contents to protect the copyrights owners' benefits and rights. File can be played after the license is cleared through the methods of online, etc.

PHOTO LIST

* The projector can display JPEG files.

Photo Supported File Formats

PHOTO(*.JPEG) supporting file

Baseline: 64 pixel (width) x 64 pixel (height) to 15360 pixel (width) x 8640 pixel (height)



Progressive: 64 pixel (width) x 64 pixel (height) to 1920 pixel (width) x 1440 pixel (height)

- You can play JPEG files only.
- Non-supported files are displayed in the form of predefined icon.
- An error message occurs for corrupted files or file formats that cannot be played.
- Corrupted image files may not be displayed properly.
- It may take some time to view high-resolution images in full screen.

Browsing Photo List

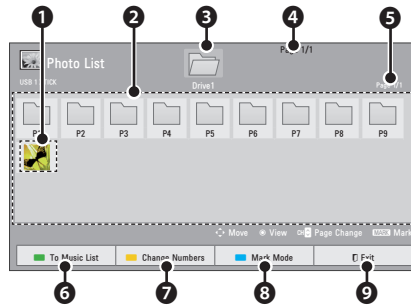
- 1 Connect a USB storage device.
- 2 Press **USB** to access the Home menu.
- 3 Press the Navigation buttons to scroll to **Photo List** and press **OK**.
- 4 Press the Navigation buttons to scroll to the device you want and press **OK**.
- 5 Press Navigation buttons to select a folder or file you want and press **OK**.



No.	Description
1	Thumbnail
	Abnormal files 
	Non-supported files 
2	Contents List
3	Moves to upper level folder
4	Current page/Total pages of folders
5	Current page/Total pages of contents
6	Move to Music List .
7	Changes the number or thumbnails displayed at a time.

No.	Description
8	Allows you to mark certain files. Select files you want and press Color buttons .
	View Marked Press Red . Display the selected photo.
	Mark All Press Green . Mark all files in the folder.
	Unmark All Press Yellow . Deselect all marked files.
	Exit Mark Mode Press Blue . Enter or exit the Mark Mode.
9	Exit.

6 The following options are available while viewing photos.



Option	Description
◀ 2/13 ▶	Select the previous or next photo.
Slideshow	Selected photos are displayed during the slide show. If no photo is selected, all photos in the current folder are displayed during slide show. <ul style="list-style-type: none"> Set the time interval of the slide show in Option-Set Photo View menu.
BGM	Listen to music while viewing photos in full size. <ul style="list-style-type: none"> Set the BGM device and album in Option-Set Photo View menu.

Option	Description
	Rotate photos. <ul style="list-style-type: none"> Rotates the photo 90°, 180°, 270°, 360° clockwise. Photos cannot be rotated if its width is greater than the available supported resolution height.
	View the photo in full mode or original mode.
Q.MENU Option	Popup Option menu. See "Options for Photo List".
Hide	Hide the menu on the full-sized screen. <ul style="list-style-type: none"> To see the menu again on the full-sized screen, press OK button to display.
Exit	Return to Photo List .

Options for Photo List

- 1 Press **Q.MENU**.
A pop-up window will appear.
- 2 Press the Navigation buttons to scroll to the option and press **OK**.
- 3 Press the Navigation buttons to scroll to one of the following options and press **OK**.

Set Photo View.

Option	Description
Slide Speed	Selects a slideshow speed (Fast, Medium, Slow).
BGM	Selects a music folder for the background music. Select Repeat or Random option. <ul style="list-style-type: none"> • You cannot change the music folder while the background music is playing.

Set Video Play.

Allows you to change Video presets (Refer to "PICTURE Settings" on page 56).

Set Audio.

Allows you to change Audio presets (Refer to "AUDIO Settings" on page 61)

MUSIC LIST

* You can use the Music List menu to play MP3 files from a USB storage device.

Music Supported File Formats



MUSIC (*.MP3) supporting file
Bit rate range 32 Kbps - 320 Kbps

- Sampling rate MPEG1 Layer3 :
32kHz, 44.1kHz, 48kHz
- Sampling rate MPEG2 Layer3 :
16kHz, 22.05kHz, 24kHz

Browsing Music List

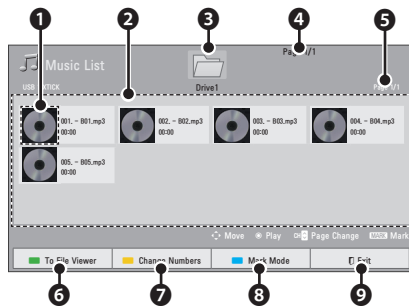
- 1 Connect a USB storage device.
- 2 Press **USB** to access the Home menu.
- 3 Press the Navigation buttons to scroll to **Music List** and press **OK**.
- 4 Press the Navigation buttons to scroll to the device you want and press **OK**.
- 5 Press Navigation buttons to select a folder or file you want and press **OK**.



No.	Description
❶	Thumbnail
	Abnormal files 
	Non-supported files 
❷	Contents List
❸	Moves to upper level folder
❹	Current page/Total pages of folders
❺	Current page/Total pages of contents
❻	Move to File Viewer .
❼	Changes the number or thumbnails displayed at a time.
❽	Allows you to mark certain files. Select files you want and press Color buttons .
	Play Marked Press Red . Play the selected songs..
	Mark All Press Green . Mark all files in the folder.
	Unmark All Press Yellow . Deselect all marked files.
	Exit Mark Mode Press Blue . Enter or exit the Mark Mode.
❾	Exit.

❻ Control playback by using the following buttons.

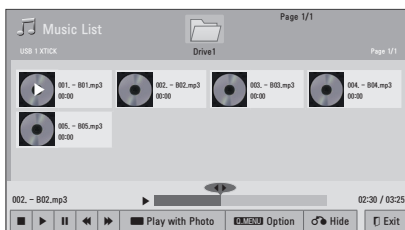

Option	Description
<, >	A cursor indicating the position can be played.
■	Stop playback.
▶	Return to normal playback.
	Paused playback.
◀ ▶	Select the previous or next song.
Play with Photo	Start playing the selected songs and then move to the Photo List .
Q.MENU Option	Popup Option menu.
Hide	Hide the menu on screen. <ul style="list-style-type: none"> To see the menu again on the full-sized screen, press OK button to display.
Exit	Return to Music List .

Options for Music List

- 1 Press **Q.MENU**.
A pop-up window will appear.
- 2 Press the Navigation buttons to scroll to the option and press **OK**.
- 3 Press the Navigation buttons to scroll to one of the following options and press **OK**.

Set Audio Play.

Select Repeat or Random option.

Set Audio.

Allows you to change Audio presets (Refer to "AUDIO Settings" on page 61)

FILE VIEWER

Supported File Formats

Supported File : XLS, DOC, PPT, TXT, XLSX, PPTX, DOCX, PDF

Microsoft Office Version 97 / 2000 / 2002 / 2003 / 2007

Adobe PDF Version 1.0 / 1.1 / 1.2 / 1.3 / 1.4

- File Viewer realigns the document, so it may look different than when viewed on a PC.
- For the documents that include images, the resolution may look lower during the realigning process.
- If the document volume is big or it has many pages, loading may take long time.
- Unsupported fonts may be replaced with other fonts.

Browsing File Viewer

- 1 Connect a USB storage device.
- 2 Press **USB** to access the Home menu.
- 3 Press the Navigation buttons to scroll to **File Viewer** and press **OK**.
- 4 Press the Navigation buttons to scroll to the device you want and press **OK**.
- 5 Press Navigation buttons to select a folder or file you want and press **OK**.

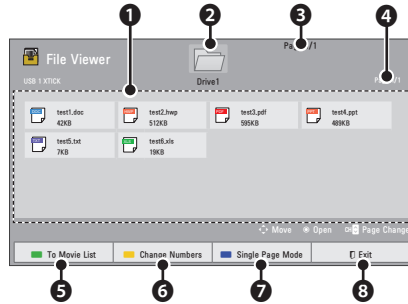

No.	Description	
1	Contents List	
2	Moves to upper level folder	
3	Current page/Total pages of folders	
4	Current page/Total pages of contents	
5	Move to Movie List .	
6	Changes the number or thumbnails displayed at a time.	
7	Single Page Mode	Loads and displays pages one by one. The initial loading time is short but a content-heavy page may be displayed slowly.
	Full Document Mode	Loads all pages of a file to memory before it starts to display them. The initial loading time is long but you can navigate pages quickly after loading is complete. If a file is too large, it may fail to load all the pages.
8	Exit.	

6 Control playback by using the following buttons.

- Press **CH** to move the previous or next page.
- Press **VOL** to Zoom in or zoom out.
- 1. Press **MENU**.
2. Press the Navigation buttons to scroll to **Go Page** or **Zoom** press **△**.

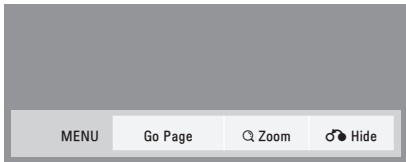

Option	Description
Go Page	Move to a desired page. Press the Navigation or Number buttons select a desired page and press OK .
Q Zoom	Zoom in or zoom out. Press the Navigation buttons select a desired page and press OK . * You can also use this function through the Vol button.
Hide	Close the menu. <ul style="list-style-type: none"> • To see the menu again on the full-sized screen, press MENU to display.

PLAY GAME

Allows you to enjoy the games installed on the projector.

- 1 Press **MENU** to access the menu.
- 2 Press the Navigation buttons to scroll to **OPTION** and press **OK**.
- 3 Press the Navigation buttons to scroll to **GAME** and press **OK**.

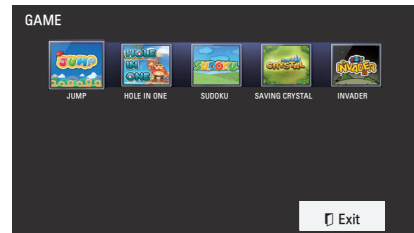











- 4 When you are finished, press **EXIT**.

CUSTOMIZING SETTINGS

The SETUP Menu

- 1 Press **MENU** to access the menu.
- 2 Press the Navigation buttons to scroll to one of the following menus and press **OK**.
- 3 Press the Navigation buttons to scroll to the setting or option you want and press **OK**.
- 4 When you are finished, press **OK**.

	Menu	Description
	CHANNEL	Sets up and edit channels.
	PICTURE	Adjusts the image quality or effect.
	SCREEN	Adjusts the screen size, or keystone.
	AUDIO	Adjusts the sound quality, effect, or volume level.
	TIME	Sets the time, date, or Timer feature.
	LOCK	Locks or unlocks channels and programs.
	OPTION	Customizes the general settings.
	NETWORK	Sets up the network setting.
	INPUT	Select the desired input source.
	MY MEDIA	Access the photo, music, movie, or file lists and browse files.

CHANNEL Settings

- 1 Press **MENU** to access the menu.
- 2 Press the Navigation buttons to scroll to **CHANNEL** and press **OK**.
- 3 Press the Navigation buttons to scroll to the setting or option you want and press **OK**.
- To return to the previous level, press **BACK**.
- 4 When you are finished, press **EXIT**.



The available channel settings are described in the following.

Setting	Description
Auto Tuning	Tunes and stores all available channels through antennas or cable inputs. (See p.22)
Manual Tuning	Tunes and stores the channels you want manually.
Channel Edit	Adds or deletes channels. (See p.23)

PICTURE Settings

- 1 Press **MENU** to access the menu.
- 2 Press the Navigation buttons to scroll to **PICTURE** and press **OK**.
- 3 Press the Navigation buttons to scroll to the setting or option you want and press **OK**.
- To return to the previous level, press **BACK**.
- 4 When you are finished, press **EXIT**.

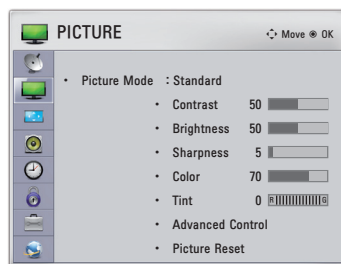

The available picture settings are described in the following.

Setting	Description														
Picture Mode	<p>Selects one of the preset image or customizes options in each mode for the best screen performance. You are also able to customize advanced options of each mode. You can also use this function through the PICTURE button.</p> <table border="1" data-bbox="375 418 1038 904"> <thead> <tr> <th colspan="2" data-bbox="375 418 1038 460">Mode</th> </tr> </thead> <tbody> <tr> <td data-bbox="375 460 488 557">Vivid</td> <td data-bbox="488 460 1038 557">Adjusts the video image for the retail environment by enhancing the contrast, brightness, color, and sharpness.</td> </tr> <tr> <td data-bbox="375 557 488 598">Standard</td> <td data-bbox="488 557 1038 598">Adjusts the image for the normal environment.</td> </tr> <tr> <td data-bbox="375 598 488 668">Cinema</td> <td data-bbox="488 598 1038 668">Optimizes video image for a cinematic look to enjoy movies as if you are in a movie theater.</td> </tr> <tr> <td data-bbox="375 668 488 765">Sport</td> <td data-bbox="488 668 1038 765">Optimizes the video image for high and dynamic actions by emphasizing primary colors such as white, grass, or sky blue.</td> </tr> <tr> <td data-bbox="375 765 488 835">Game</td> <td data-bbox="488 765 1038 835">Optimizes the video image for a fast gaming screen for PCs or games.</td> </tr> <tr> <td data-bbox="375 835 488 904">Expert</td> <td data-bbox="488 835 1038 904">Adjusts the detailed video image settings for video experts as well as general viewers.</td> </tr> </tbody> </table>	Mode		Vivid	Adjusts the video image for the retail environment by enhancing the contrast, brightness, color, and sharpness.	Standard	Adjusts the image for the normal environment.	Cinema	Optimizes video image for a cinematic look to enjoy movies as if you are in a movie theater.	Sport	Optimizes the video image for high and dynamic actions by emphasizing primary colors such as white, grass, or sky blue.	Game	Optimizes the video image for a fast gaming screen for PCs or games.	Expert	Adjusts the detailed video image settings for video experts as well as general viewers.
Mode															
Vivid	Adjusts the video image for the retail environment by enhancing the contrast, brightness, color, and sharpness.														
Standard	Adjusts the image for the normal environment.														
Cinema	Optimizes video image for a cinematic look to enjoy movies as if you are in a movie theater.														
Sport	Optimizes the video image for high and dynamic actions by emphasizing primary colors such as white, grass, or sky blue.														
Game	Optimizes the video image for a fast gaming screen for PCs or games.														
Expert	Adjusts the detailed video image settings for video experts as well as general viewers.														
Contrast	Increases or decreases the gradient of the video signal. You may use Contrast when the bright part of the picture is saturated.														
Brightness	Adjusts the base level of the signal in the picture.														
Sharpness	Adjusts the level of sharpness in the edges between the light and dark areas of the picture. The lower the level, the softer the image.														
Color	Adjusts intensity of all colors.														
Tint	Adjusts the balance between red and green levels.														
Advanced Control or Expert Control	Customizes the advanced options.														
Picture Reset	Restores the options of each mode to the factory default.														

Advanced / Expert Control Options

Setting	Description
Dynamic Contrast	Adjusts the contrast to keep it at the best level according to the brightness of the screen. The picture is improved by making bright parts brighter and dark parts darker.
Dynamic Color	Adjusts screen colors so that they look livelier, richer and clearer. This feature enhances hue, saturation and luminance so that red, blue, green and white look more vivid.
Clear White	Make the white area of screen brighter and more white.
Skin Color	It detects the skin area of video and adjusts it to express a natural skin color.
Noise Reduction	Reduces screen noise without compromising video quality.
Digital Noise Reduction	Removes noise caused by compressing video.
Gamma	<ul style="list-style-type: none"> • Low: Make dark and middle gray level area of the picture brighter. • Medium: Express original picture levels. • High: Make dark and middle gray level area of the picture darker. <p>You can adjust brightness of dark area and middle gray level area of the picture.</p>
Black Level	Sets black level of the screen to proper level. This option is disabled in RGB-PC mode.
Real Cinema	Makes video clips recorded in film look more natural by eliminating judder effect.
Color Gamut	<ul style="list-style-type: none"> • Standard: Displays standard color area. • Wide: Mode to use and set the rich color area of the display. <p>Maximize the utilization of color to increase color quality.</p>
Edge Enhancer	Show clearer and distinctive yet natural corners of the video.
xvYCC	This feature represents rich color as much as conventional video signal. This function is enabled in " Picture mode - Cinema, Expert " when a xvYCC signal is inputted through HDMI.
Expert Pattern	This is a pattern used for expert adjustment.
Color Filter	This function filters specific colors in the video. You can use the RGB filter to set color saturation and hue accurately.

Setting	Description
Color Temperature	<p>This is the function to adjust the overall color of the screen to the feeling you want.</p> <p>Select Cool, Medium, Warm. When Expert mode, customizes the options of each mode.</p> <p>Gamma: Select 1.9, 2.2, 2.4</p> <p>a. Method: 2 Points</p> <ul style="list-style-type: none"> - Pattern: Inner, Outer - Red/Green/Blue Contrast, Red/Green/Blue Brightness: The adjustment range is -50 - +50. <p>b. Method: 10 Points IRE</p> <ul style="list-style-type: none"> - Pattern: Inner, Outer - IRE (Institute of Radio Engineers) is the unit to display the size of the video signal and can be set among 10, 20, 30 - 90, 100. You can adjust Red, Green or Blue according to each setting. - Luminance: This function displays calculated luminance value for 2.2 gamma. You can input luminance value you want at 100 IRE, than the target luminance value for 2.2 gamma is displayed at every 10 steps from 10 IRE to 90 IRE. - Red/Green/Blue: The adjustment range is -50 - +50.
Color Management System	<p>As the tool used by the experts to make adjustments by using the test patterns, this does not affect other colors but can be used to selectively adjust the 6 color areas (Red/Green/Blue/Cyan/Mgt/Yellow).</p> <p>Color difference may not be distinctive even when you make the adjustments for the general video.</p> <p>Adjusts Red/Green/Blue/Yellow/Cyan, Magenta.</p> <ul style="list-style-type: none"> - Red/Green/Blue/Yellow/Cyan, Magenta Color: The adjustment range is -30 - +30. - Red/Green/Blue/Yellow/Cyan, Magenta Tint: The adjustment range is -30 - +30.

SCREEN Settings

- 1 Press **MENU** to access the menu.
- 2 Press the Navigation buttons to scroll to **SCREEN** and press **OK**.
- 3 Press the Navigation buttons to scroll to the setting or option you want and press **OK**.
- To return to the previous level, press **BACK**.
- 4 When you are finished, press **EXIT**.

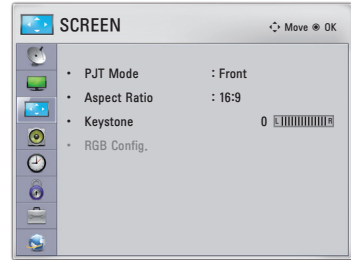

The available screen settings are described in the following.

Setting	Description	
PJT Mode	This function turns the projected image upside down or flips horizontal. Select Rear when projecting from the back of the transparent screen purchased separately. Select Ceiling when installing the product on the ceiling. When PJT Mode is Rear/Front Ceiling , the left/right of the speaker changes automatically.	
Aspect Ratio	Changes the image size to view images at its optimal size. (See p.24)	
Keystone	Use this function when the screen is not at a right angle to the projector and the image is a trapezoid shape. (See p.25)	
RGB Config.	Customizes the PC display options.	
	Option	
	Resolution	Selects a proper resolution when your PC uses 768 resolution (1024x768/1280x768/1360x768, 60Hz) and 1050 resolution (1400x1050/ 1680x1050, 60Hz).
	Auto Config.	Sets the projector to optimize the options automatically for the projector display. You can also use this function through the AUTO button.
	Position	Locates the image at the proper position.
	Size	Adjusts the image size.
	Phase	Eliminates horizontal streaking.
Reset	Restores the options to the default setting.	

AUDIO Settings

- 1 Press **MENU** to access the menu.
- 2 Press the Navigation buttons to scroll to **AUDIO** and press **OK**.
- 3 Press the Navigation buttons to scroll to the setting or option you want and press **OK**.
- To return to the previous level, press **BACK**.
- 4 When you are finished, press **EXIT**.

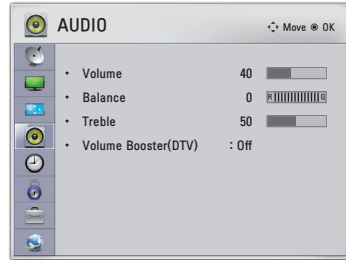

The available audio settings are described in the following.

Setting	Description
Volume	Adjusts the volume level. You can also use this function through the VOL button.
Balance	Adjust the left/right sound of speaker to suit your taste and room situations.
Treble	Adjust the treble to suit your taste and room situations.
Volume Booster(DTV)	Amplify the Volume Level. You can adjust this function in the DTV and Cable DTV.

TIME Settings

- 1 Press **MENU** to access the menu.
- 2 Press the Navigation buttons to scroll to **TIME** and press **OK**.
- 3 Press the Navigation buttons to scroll to the setting or option you want and press **OK**.
- To return to the previous level, press **BACK**.
- 4 When you are finished, press **EXIT**.

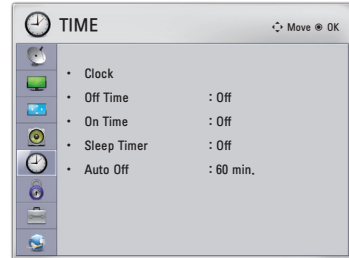

The available time settings are described in the following.

Setting	Description
Clock	Sets the time, date, time zone, and daylight-saving time feature. The time will be set automatically according to a digital channel signal which includes time information provided by the broadcasting station. If not, set the time and date manually.
Off Time /On Time	<p>Sets the time to turn on or off the projector automatically. To use this function, you should set the current time and date in advance.</p> <p>NOTE</p> <ul style="list-style-type: none"> • If you do not press any button within 2 hours after the projector turns on by the On Time feature, the projector enters the Standby mode automatically. • If you set both Off time and On time features to the same time, the Off time feature overrides the On time feature.
Sleep Timer	Sets the length of time until the projector turns off. When you turn the projector off and turn it on again, the Sleep timer feature will be set to off.
Auto Off	This function turns the projector off automatically after the preset time is passed when there is no signal.

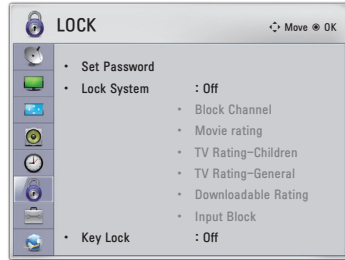

LOCK Settings

- 1 Press **MENU** to access the menu.
- 2 Press the Navigation buttons to scroll to **LOCK** and press **OK**.
- 3 Press the Navigation buttons to scroll to the setting or option you want and press **OK**.
- To return to the previous level, press **BACK**.
- 4 When you are finished, press **EXIT**.



The available lock settings are described in the following.

Setting	Description	
Set Password	Changes the 4-digit password. The default PIN is "0 0 0 0". If you forget your password, press "0-3-2-5" on the remote control.	
Lock System	Activates or deactivates the lock system.	
Block Channel	Blocks the channels that contain inappropriate contents for children. The channels can be selected but the screen blank and the audio is muted. To watch a locked channel, enter the password.	
Movie rating	Blocks the movies that are only broadcasted on the projector and contain inappropriate contents, based on the Motion Picture Association of America (MPAA) rating.	
	Rating	
	G	General audiences – All ages admitted
	PG	Parental guidance suggested – Some material may not be suitable for children
	PG-13	Patents strongly cautioned – Some material may be inappropriate for children under 13
	R	Restricted – Under 17 requires accompanying parent or adult guardian
	NC-17	No one 17 and under admitted.
	X	Adults only
Blocking Off	Permits all programs	

Setting	Description
TV Rating-Children	Blocks the children's TV programs that parents do not want their children to watch. To block other TV programs, you should set the TV Rating-General feature.
	Rating
	Age Applies to TV-Y, TV-Y7
	Fantasy Violence Applies to TV-Y7
TV Rating-General	Blocks the TV programs that you want based on the ratings by using the Parental Control Function (V-Chip).
	 NOTE <ul style="list-style-type: none"> The V-Chip electronically reads TV program ratings and allows parents to block program that are unsuitable for children.
	Rating
	Age applies to TV-G, TV-PG, TV-14, TV-MA
	Dialogue (sexual dialogue) applies to TV-PG, TV-14
	Language (adult language) applies to TV-PG, TV-14, TV-MA
	Sex (sexual situations) applies to TV-PG, TV-14, TV-MA
	Violence applies to TV-PG, TV-14, TV-MA
Downloadable Rating	This function operates only when projector has received Region5 Rating data. The name of the rating option may differ.
	 NOTE <ul style="list-style-type: none"> This feature is available only for digital channels.
Input Block	Block the input sources.
Key Lock	<p>This feature can be used to prevent unauthorized viewing by locking out the panel controls, so that it can only be used with the remote control.</p> <p>In Key Lock 'On', if the projector is turned off, press the Power button.</p> <p>With the Key Lock 'On', the display 'Key Lock' appears on the screen if any button on the panel is pressed while viewing the projector.</p>

OPTION Settings

- 1 Press **MENU** to access the menu.
- 2 Press the Navigation buttons to scroll to **OPTION** and press **OK**.
- 3 Press the Navigation buttons to scroll to the setting or option you want and press **OK**.
- To return to the previous level, press **BACK**.
- 4 When you are finished, press **EXIT**.

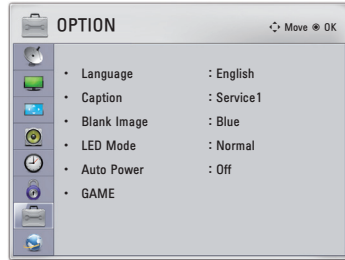

The available option settings are described in the following.

Setting	Description
Language	Selects a desired Menu Language.
Caption	Sets whether to display captions and customize your option in each mode.
	Mode
CC 1-4 (Closed Captioning)	Displays the audio portion of a TV program as text on the screen. CC1 is the most common mode in use. - Field 1 data channels: two Captions (CC1, CC2) and two Text (T1, T2).
Text 1-4	- Field 2 data channels: two Captions (CC3, CC4) and two Text (T3, T4).
Service 1-6	This is only available for the digital broadcasting system.
	Option (For Digital Broadcasting)
Size	Selects the wordsize.
Font	Selects a typeface for the text.
Text Color	Selects a color for the text.
Text Opacity	Adjusts the opacity for the text color.
Bg Color	Adjusts the opacity for the text color.
Bg Opacity	Adjusts the opacity for the background color.
Edge Type	Selects an edge type.
Edge Color	Selects a color for the edges.
Blank Image	You can choose the background color to the selected Blank function.(See p.26)

Setting	Description			
LED Mode	To adjust the brightness of the screen. LED Mode changes into Dimming mode automatically if use a portable battery. LED Mode changes into Dimming mode automatically if there is no input signal. You can also use this function through the Q.MENU button.			
Auto Power	To make projector turned on automatically when the plug of adapter is inserted.			
	Option			
	<table border="1"> <tr> <td>On</td> <td>When connect DC plug to the projector, projector turns on automatically.</td> </tr> <tr> <td>Off</td> <td>When connect DC plug to the projector, projector enters standby state.</td> </tr> </table>	On	When connect DC plug to the projector, projector turns on automatically.	Off
On	When connect DC plug to the projector, projector turns on automatically.			
Off	When connect DC plug to the projector, projector enters standby state.			
GAME	Allows you to enjoy the games installed on the projector.			

NETWORK Settings

- 1 Press **MENU** to access the menu.
- 2 Press the Navigation buttons to scroll to **NETWORK** and press **OK**.
- 3 Press the Navigation buttons to scroll to the setting or option you want and press **OK**.
- To return to the previous level, press **BACK**.
- 4 When you are finished, press **EXIT**.

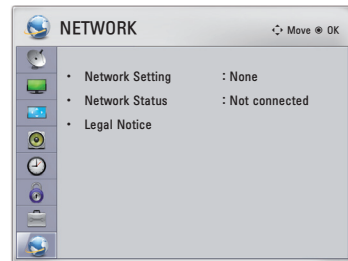

The available network settings are described in the following.

Setting	Description
Network Setting	Configure the network settings. (See p.28)
Network Status	Display the network status. (See p.32)
Legal Notice	Display the Legal notice. (See p.34)

MAKING CONNECTIONS

Connect various external devices to the ports on the projector.

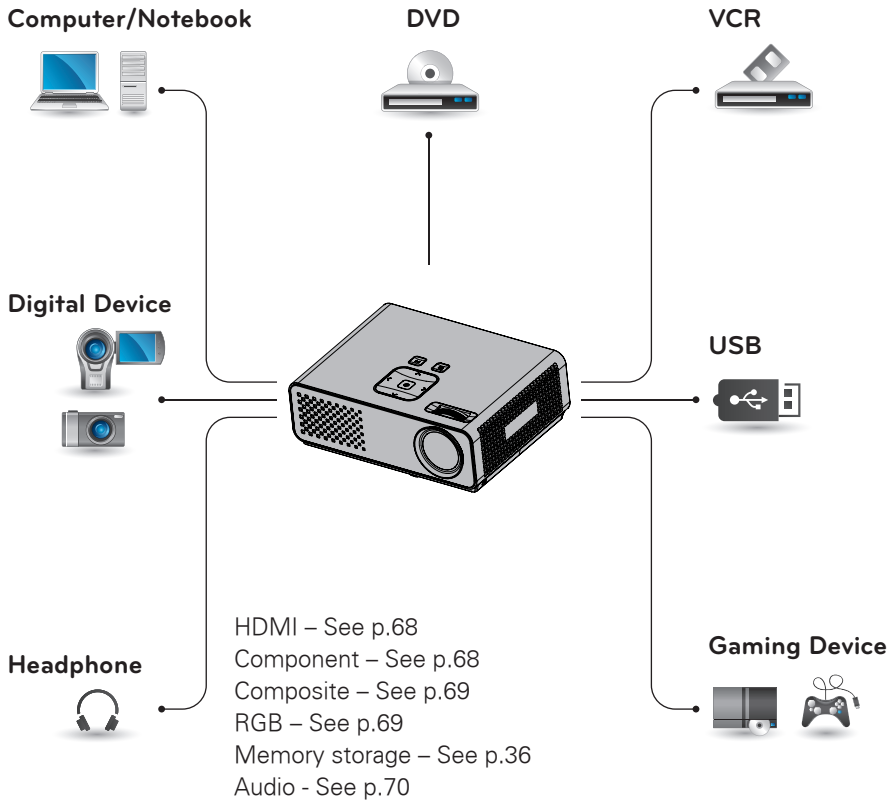

Connecting to a HD receiver, DVD, or VCR player

Connect a HD receiver, DVD, or VCR player to the projector and select an appropriate input mode.

HDMI Connection

Transmits the digital video and audio signals from an external device to the projector. Connect the external device and the projector with the HDMI cable as shown in the following illustration.

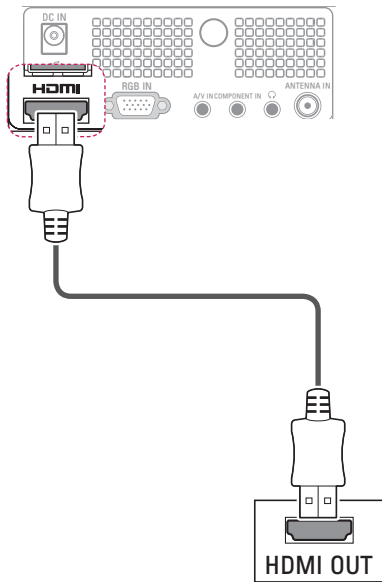

Component Connection

Transmits the analog video and audio signals from an external device to the projector. Connect the external device and the projector with the component cable as shown in the following illustration.

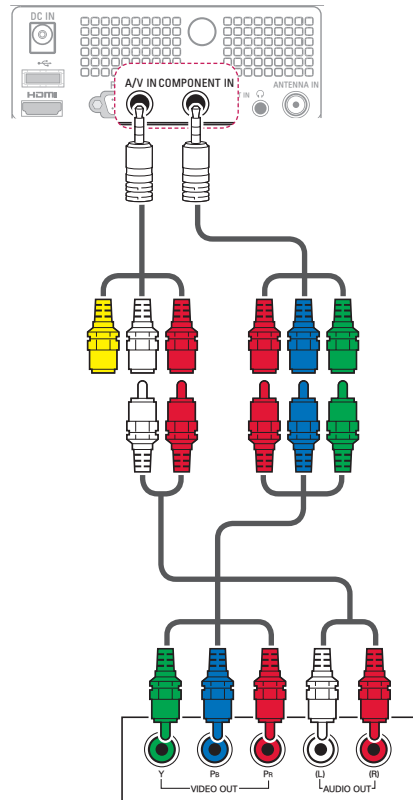

Composite Connection

Transmits the analog video and audio signals from an external device to the projector. Connect the external device and the projector with the composite cable as shown in the following illustration.

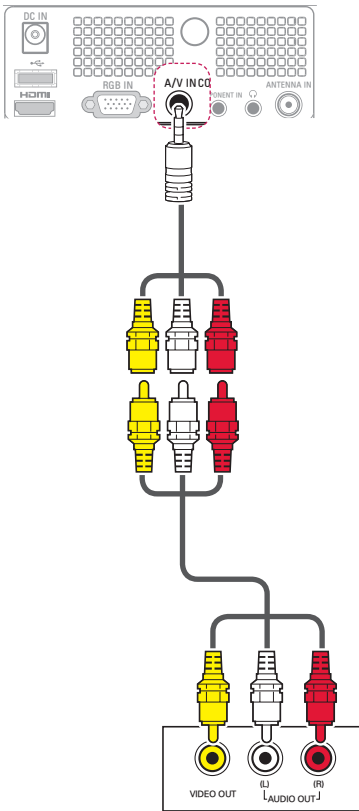

Connecting to a PC

This projector supports the Plug & Play. A PC will automatically recognize the projector and requires no driver to be installed.

RGB Connection

Transmits the analog video signal from your PC to the projector. Connect the PC and the projector with the D-sub 15 pin signal cable as shown in the following illustrations. To transmit an audio signal, connect a 3-pole audio cable from PC to the projector.

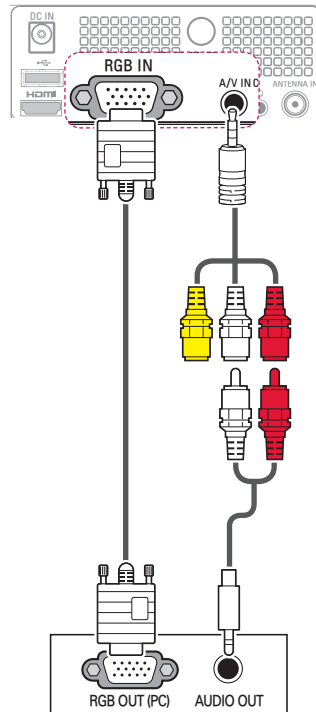

Connecting to a Headphone

Listen to the sound through a headphone.

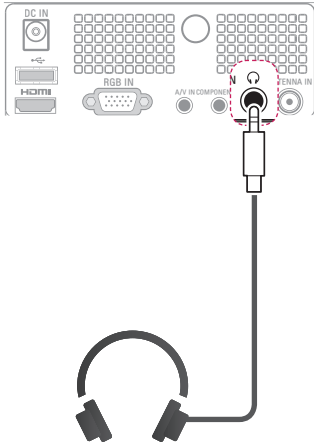

MAINTENANCE

Update and clean your projector regularly to keep the best performance and to extend the product lifespan.

Updating the Projector Firmware

Download and install the latest firmware by connecting to the firmware update server to enhance or change the product function, or add new features.

The firmware update may not work properly depending on the Internet environment. If so, you may obtain the latest firmware update from the authorized LG Electronics service center.

To check the current firmware version or update the firmware,

- 1 Press **MENU** to access the menu.
- 2 Press the **Red** buttons to access **Customer Support**.
- 3 Press the Navigation buttons to scroll to **Software Update** and press **OK**.

The current firmware version displays.

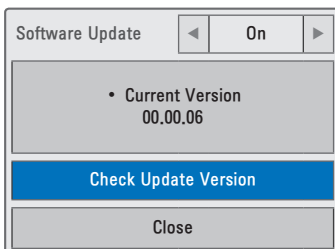

- 4 Select **Check Update Version** to check a new firmware version manually.

When selecting “**Software Update-On**”

- If the projector is connected to the internet and it finds a software update on the LG server, the update popup menu will appear automatically.
- If the updated digital software information is transmitted, the update popup menu will appear automatically.

NSU (Network Software Update):

When software update is on, the projector will automatically check for software updates. A pop-up window will appear on the screen when an update is available.

**NOTE**

- The software downloading time will vary depending on the software size and network conditions.
- During the software update procedure, do not turn off the projector or disconnect AC power, or disconnect the network.
- After software update, you can confirm the update software version at software Update menu.
- When update is completed, the projector will restart automatically in 5 seconds.
- The projector functions may be improved or changed by software update.
- The available time or functionality of NetCast menu may be depends on your ISP network conditions.
- When an update is completed, some CHANNEL, PICTURE, and AUDIO menu settings may need resetting.
- This projector cannot be updated to previous software version.
- Use the “**Check Update Version**” button to update the latest software on the Network server manually.
- You cannot open NetCast while the software is being updated.

Cleaning the Projector

Cleaning the lens

Use an air spray or cleaning cloth for product exterior, provided with the product, to lightly clean the product. Please use a recommended air spray or lens cleaning product. To clean lens, small amount of cleaning agent on a swab or a soft cloth and rub on the lens. Please be aware that liquid may flow pass through the lens if the product is sprayed on lens directly.

Cleaning the Projector Case

To clean the projector case, first unplug the power cable. To remove dirt or dust, wipe the casing with polish cloth provided. When you want to remove the dust or stain on the lens, use the cloth for product exterior, provided with the product. Do not use alcohol, benzene, thinners or other chemical detergents as these can cause the casing to be warped or discolored.

How to Fix the Lens Cap

- 1 Prepare the lens cap and the strap supplied as accessories.
- 2 Insert the end of the strap into the hole at the bottom of the lens section of the projector.

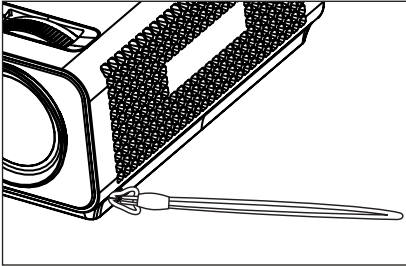

- 3 Fix the strap at the hole of the projector into the hole of the lens cap, and then pass the lens cap through the strap lasso.

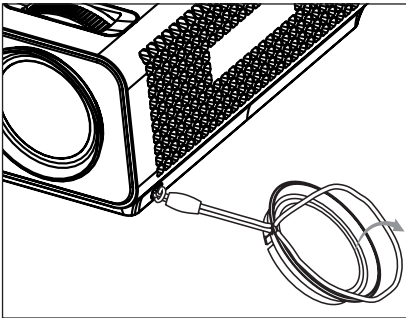

SPECIFICATIONS

MODEL	HW300T (HW300T-JE)	
Resolution (Pixel)	1280 (Horizontal) × 800 (Vertical)	
Ratio	16:10 (Horizontal:Vertical)	
Panel size (mm)	11.623	
Projection distance (Screen size)	0.59 m - 3.00 m (50.8 cm - 254.0 cm)	
Projection Offset	100 %	
Remote control distance	6 m	
Video compatibility	NTSC	
AC-DC Adapter	LG, SD-B191A, 19.5 V  , 5.64 A	
Audio Output	1 W + 1 W	
Television System	NTSC-M, ATSC, 64 & 256 QAM	
Program Coverage	VHF 2 - 13, UHF 14 - 69, CATV 1 - 135, DTV 2 - 69, CADTV 1 - 135	
External Antenna Impedance	75 Ω	
Height (mm)	54.0 (without foot), 57.0 (with foot)	
Width (mm)	160.0	
Length (mm)	119.5	
Weight (g)	780	
USB Device	5 V, 0.5 A (max)	
Operating Condition	Temperature	
	In operation	0°C - 40°C
	In storage and transit	-20°C - 60°C
	Humidity (relative humidity)	
	In operation	0 % - 80%
	Not in operation	0 % - 85%

RGB-PC supported mode

Format	Vertical Freq. (Hz)	Horizontal Freq.(kHz)
640X350	70.090	31.468
720X400	70.080	31.469
640X480	59.940	31.469
800X600	60.310	37.879
1024X768	60.000	48.363
1152X864	60.053	54.348
1280X768	59.870	47.776
1280X800	60.000	49.680
1360X768	60.015	47.712
1280X1024	60.020	63.981
1400X1050	59.979	65.317
1680X1050	60.000	65.300

- If the projector does not support the input signal, "Invalid Format" message appears on the screen.
- The projector supports DDC1/2B type as Plug & Play. (Auto recognition of PC monitor)
- PC synchronization signal types supported: Separate type synchronization.
- To get the the best picture quality, adjust the PC graphics card to 1280x800.

OPEN SOURCE LICENSE

To obtain the source code under GPL, LGPL, MPL and other open source licenses, that is contained in this product, please visit <http://opensource.lge.com>.

In addition to the source code, all referred license terms, warranty disclaimers and copyright notices are available for download.



The model and serial number of the projector is located on the back or one side of the projector. Record it below should you ever need service.

MODEL _____

SERIAL _____

LG Customer Information Center	
USA, Consumer User	1-800-243-0000
USA, Commercial User	1-888-865-3026
CANADA	1-888-542-2623