

USER'S MANUAL

UP-800

English

PLUS

IMPORTANT INFORMATION

Precautions

Please read this manual carefully before using your PLUS UP-800 Data Projector and keep the manual handy for future reference.

Your serial number is located next to the main power switch on the back of your UP-800. Record it here:



CAUTION

TO PREVENT SHOCK, DO NOT OPEN THE CABINET. NO USER-SERVICEABLE PARTS INSIDE. REFER SERVICING TO QUALIFIED PLUS SERVICE PERSONNEL.

WARNING

TO PREVENT FIRE OR SHOCK, DO NOT EXPOSE THIS UNIT TO RAIN OR MOISTURE. DO NOT USE THIS UNIT'S GROUNDED PLUG WITH AN EXTENSION CORD OR IN AN OUTLET UNLESS ALL THREE PRONGS CAN BE FULLY INSERTED. DO NOT OPEN THE CABINET. THERE ARE HIGH-VOLTAGE COMPONENTS INSIDE. ALL SERVICING MUST BE DONE BY QUALIFIED PLUS SERVICE PERSONNEL.

WARNING

TO PREVENT FIRE OR SHOCK, DO NOT EXPOSE THIS UNIT TO RAIN OR MOISTURE. DO NOT USE THIS UNIT'S GROUNDED PLUG WITH AN EXTENSION CORD OR IN AN OUTLET UNLESS ALL THREE PRONGS CAN BE FULLY INSERTED. DO NOT OPEN THE CABINET. THERE ARE HIGH-VOLTAGE COMPONENTS INSIDE. ALL SERVICING MUST BE DONE BY QUALIFIED PLUS SERVICE PERSONNEL.

DOC Compliance Notice

This Class A digital apparatus meets all requirements of the Canadian Interference-Causing Equipment Regulations.

RF Interference

WARNING

The Federal Communications Commission does not allow any modifications or changes to the unit EXCEPT those specified by PLUS Technologies in this manual. Failure to comply with this government regulation could void your right to operate this equipment.

This equipment has been tested and found to comply with the limits for a Class A digital device, pursuant to Part 15 of the FCC Rules. These limits are designed to provide reasonable protection against harmful interference in a commercial installation. This equipment generates, uses and can radiate radio frequency energy and, if not installed and used in accordance with the instructions, may cause harmful interference to radio communications. Operation of this equipment in a residential area is likely to cause harmful interference in which case the user will be required to correct the interference at their own expense.

Important Safeguards

These safety instructions are to ensure the long life of your Data projector and to prevent fire and shock. Please read them carefully and heed all warnings.

Installation

1. For best results, use your Data projector in a darkened room.
2. Place the projector on a flat, level surface in a dry area away from dust and moisture.
3. Do not place your Data projector in direct sunlight, near heaters or heat radiating appliances.
4. Exposure to direct sunlight, smoke or steam can harm internal components.
5. Handle your Data projector carefully. Dropping or jarring can damage internal components.
6. Do not place heavy objects on top of the Data projector.
7. If installing the Data projector on the ceiling:
 - a. The ceiling must be strong enough to support the Data projector and the installation must be in accordance with any local building codes.
 - b. The Data projector must be installed by qualified PLUS service personnel.

Power Supply

1. The Data projector is designed to operate on a power supply of 100-120 or 220-240 V 50/60 Hz AC. Ensure that your power supply fits this requirement before attempting to use your Data projector.
2. Handle the power cable carefully and avoid excessive bending. A damaged cord can cause electric shock or fire.
3. If the Data projector is not to be used for an extended period of time, disconnect the plug from the power outlet.

Cleaning

1. Unplug the Data projector before cleaning.
2. Clean the cabinet periodically with a damp cloth. If heavily soiled, use a mild detergent. Never use strong detergents or solvents such as alcohol or thinner.
3. Use a blower or lens paper to clean the lens, and be careful not to scratch or mar the lens.

Lamp Replacement

- Be sure to replace the lamp when the Status light comes on. If you continue to use the lamp after 1000 hours of use, the lamp will turn off.
- Allow a minimum of ONE minute to elapse between turning the lamp off and on. High voltage is applied to the lamp immediately when the power is turned on. Therefore turning the power off and quickly back on may shorten the life of your lamp and result in damage to your Data projector.

Fire and Shock Precautions

1. Ensure that there is sufficient ventilation and that vents are unobstructed to prevent the build-up of heat inside your Data projector. Allow at least 10cm (3 inches) of space between your Data projector and a wall.
2. Prevent foreign objects such as paper clips and bits of paper from falling into your Data projector. Do not attempt to retrieve any objects that might fall into your projector. Do not insert any metal objects such as a wire or screwdriver into your Data projector. If something should fall into your projector, disconnect it immediately and have the object removed by a qualified PLUS service person.
3. Do not place any liquids on top of your Data projector.

- Do not look into the lens while the projector is on. Serious damage to your eyes could result.

Carrying around

When carrying this device around, please use the carrying case that comes with it and to protect the lens from scratches, always install the lens cap. Also, do not subject the projector main unit to strong mechanical shock.

Table of contents

1. Introduction

Introduction To The UP-800 Data Projector	E-5
How Do You Get Started?	E-6
What's In The Box?	E-6
Getting To Know Your UP-800 Data Projector	E-7
Front Features	E-7
Rear Features	E-7
Left Side Features	E-7
Top Features	E-8
Terminal Panel Features	E-9
Remote Control Features	E-11

2. Installation

Setting Up Your UP-800 Data Projector	E-13
Using A Tabletop Or Cart	E-13
Moving the Projector	E-14
Using the ceiling hanging fixtures	E-15
Ceiling Installation	E-15
Wiring Diagram	E-16
Connecting Your PC Or Macintosh Computer	E-17
Connecting Your Document Camera	E-19
Connecting Your VCR Or Laser Disc Player	E-19
Connecting An External Monitor	E-19
Connecting Your Remote Mouse Receiver	E-20

3. Operation

General Controls	E-21
Using The Menus	E-22
Menu Descriptions & Functions	E-23
Source Menu	E-23
Image Adjust Menu	E-24
Power Menu	E-25
Settings Menu	E-26

4. Maintenance

Replacing The Lamp	E-27
Remote Control Battery Installation	E-28
Remote Control effective range	E-28

5. Troubleshooting

Status Light Messages	E-29
Common Problems & Solutions	E-30

6. Specifications

Optical	E-31
Electrical	E-31
Mechanical	E-31
Dimensions	E-32
D-Sub Pin Assignments	E-33
Timing Chart	E-34

This section introduces you to your new PLUS UP-800 Data Projector, provides a list of materials that comes with your projector and describes the features and controls.

Congratulations On Your Purchase Of The UP-800 Data Projector

The UP-800 is one of the very best Data projectors available today. The UP-800 enables you to project precise images up to 300 inches across (measured diagonally) from your PC or Macintosh computer (desktop or notebook), VCR, document camera, or even a laser disc player.

You can use the projector on a tabletop or cart, you can permanently mount it on a ceiling*, or you can use UP-800 Data Projector to project images from behind the screen. The remote control can be used wirelessly and you can even use the remote control with the remote mouse receiver to operate the mouse on your PC or Mac.

The features you'll enjoy include:

- Superior brightness of 600 ANSI lumens with A4 size and 4.5 kilograms.
The DMD and our own optical design interact in a geometric effect to increase the light usage efficiency. Now you can reproduce the 3 basic colors (RGB) required for color reproduction on a single DMD. That means superior brightness, smaller size and lighter weight.
- Sharp, clear images
There is no RGB color running, and the spaces between the individual bots do not stick out. That means sharp and clear reproduction of small characters and figures. Take a closer look and notice the difference in quality!
- Outstanding beauty when reproducing DVDs and other high picture-quality information sources.
Faithful reproduction of gradations of black and white for more natural image displays. The projector can bring its intrinsic display capacities even more to bear with DVDs and other high picture-quality information sources.
- Screen does not distort to a trapezoid when projecting to the height of the of vision.
Because the projection position is already set to the height of the line of vision, there is no distortion of the screen to a trapezoid.
- Fully compatible with SVGA, XGA compressed display.
There is complementing of thinned out information when displaying XGAs to eliminate missing characters.

Note: Composite video standards are as follows:

NTSC: U.S. TV standard for video in U.S. and Canada.

PAL: TV standard used in western Europe

SECAM: TV standard used in France and Eastern Europe

NTSC4.43: TV standard used in Middle East countries

- The remote control can be used with or without a cable, and you can even use the remote to operate your PC or Macintosh mouse wirelessly from across the room with the remote mouse receiver.
- You can control your UP-800 with a PC.
- The contemporary cabinet design is compact, easy to carry, and complements any office, board room or auditorium.

* Installing the UP-800 Data Projector on the ceiling must be done by authorized PLUS technicians. Consult your dealer for more information.

How Do You Get Started?

The fastest way to get started is to take your time and do everything right the first time. Taking a few minutes now to review the manual may save you hours later on. At the beginning of each section of the manual you'll find an overview. If the section doesn't apply, you can skip it.

What's In The Box?

Make sure your box contains everything listed. If any pieces are missing, contact your dealer. Please save the original box and packing materials if you ever need to ship your UP-800 Data Projector.

- Remote control
- Batteries (AA×2)
- Lens Cap
- Remote Mouse Receiver
- Serial mouse cable
- Mouse adapter (For IBM PS/2)
- Mouse adapter (For Macintosh)
- Monitor adapter
- PC/Macintosh MultiCable
- Power cable
- Audio Video cable
- User's manual
- Carrying case

Remote control



Batteries (AA×2)

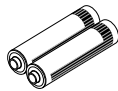

Lens Cap

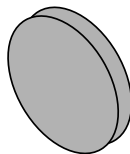

Remote Mouse Receiver



Serial mouse cable

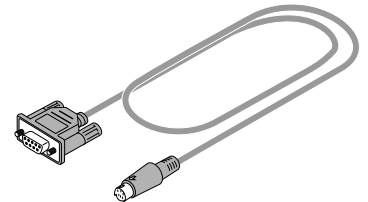

Mouse adapter (For IBM PS/2)

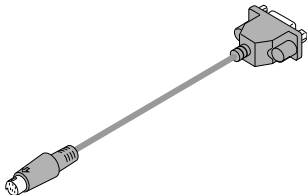

Mouse adapter (For Macintosh)

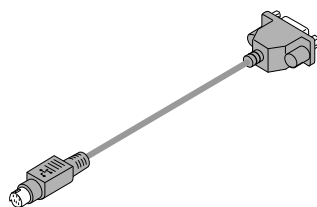

Monitor adapter

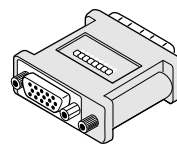

PC/Macintosh MultiCable
(15-Pin Mini D-Sub To 15-Pin D-Sub connector)

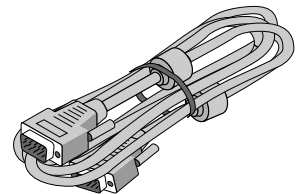

Power cable

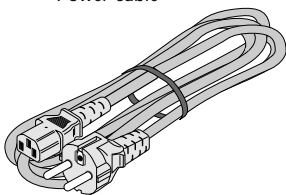

Audio Video cable

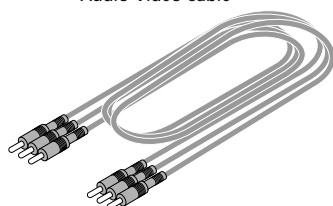

User's manual

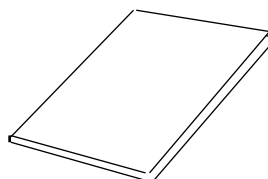

Carrying case

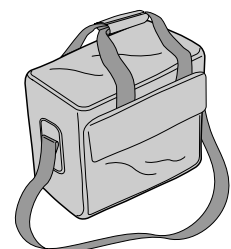

Getting To Know Your UP-800 Data Projector

Front Features

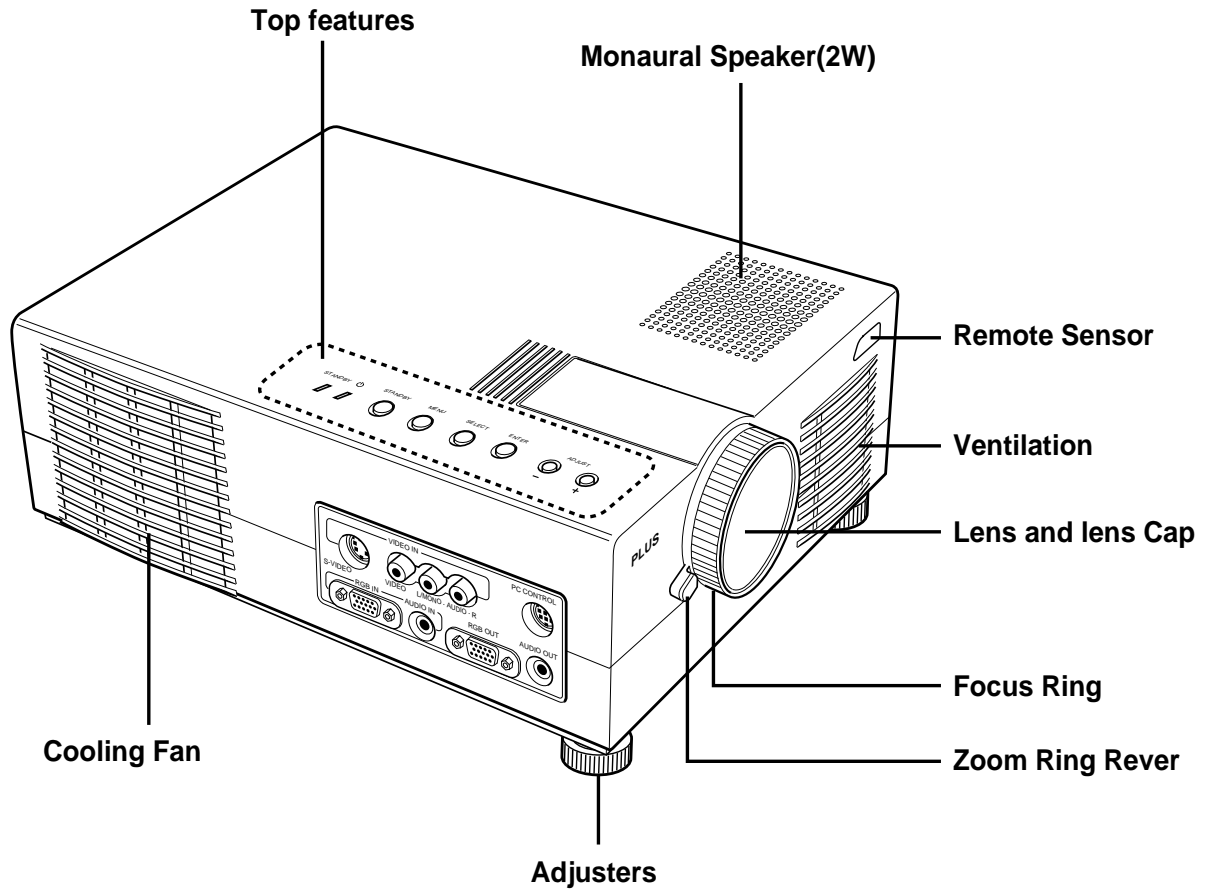

Rear Features

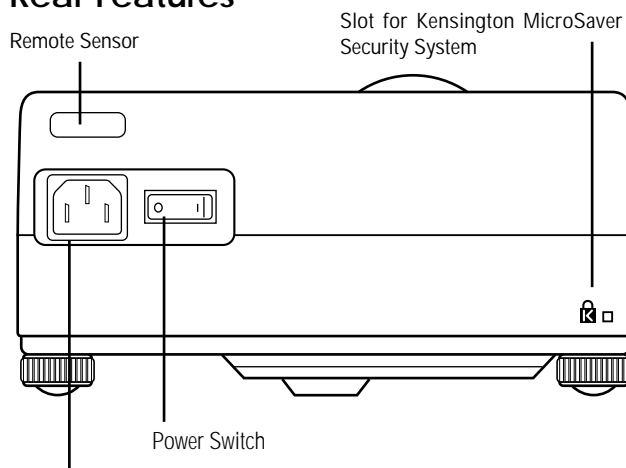

AC Input
Connect the supplied power cable's three-pin plug here.

Left Side Features

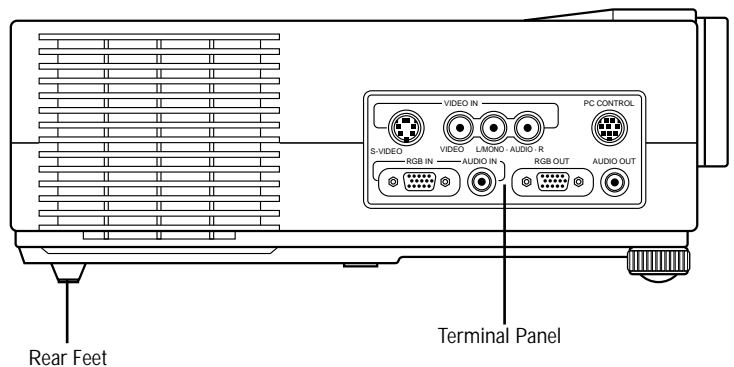

Top Features

① Standby Button

Use this button to turn the power on and off when Main Power Switch is on and the Data projector is on standby. (When this button is pressed and held for at least two seconds, the “Display Mute” mode will be canceled.)

② Menu Button

Displays the on- screen menu.

③ Select Button

After you press the “Menu” button, use this button to select the menu icon of the item you wish to adjust.

④ Enter Button

Executes your menu selection.

⑤ (+) (-) Adjust Button

Use these buttons while you're in the Image Adjust mode to change the level of a selected menu item. These buttons are also used to set an item in the Power or Settings menus.

⑥ STANDBY Indicator

When STANDBY is switched On, the green LED blinks for about one minute, then lights up.

If the power is on and you switch it off by pressing POWER OFF on the remote controller or the STANDBY button on the projector main unit operation section, the green LED blinks for one minute, then lights up and the projector goes on standby.

* The projector will not accept operation instructions for the one minute during which the LED is blinking during switching on or off as described above.

⑦ Status Indicator

When this is lit red continually, it's warning you that the projection lamp has exceed 1100 hours of service. After this light appears, it is advisable to replace the projection lamp as soon as possible.(See page E-27.)

When the operating time of the lamp exceeds 1000 hours, the STATUS indicator is lit red continually. In addition the message "LAMP USAGE XX HOURS" appears continually when the on-screen menu is not displayed.

If this light blinks red rapidly, it indicates that either the lamp house or filter cover is not attached properly; if the light blinks slowly it means the projector's internal temperature is too hot to operate safely. See the Status Light Messages on page E-29 for more details.

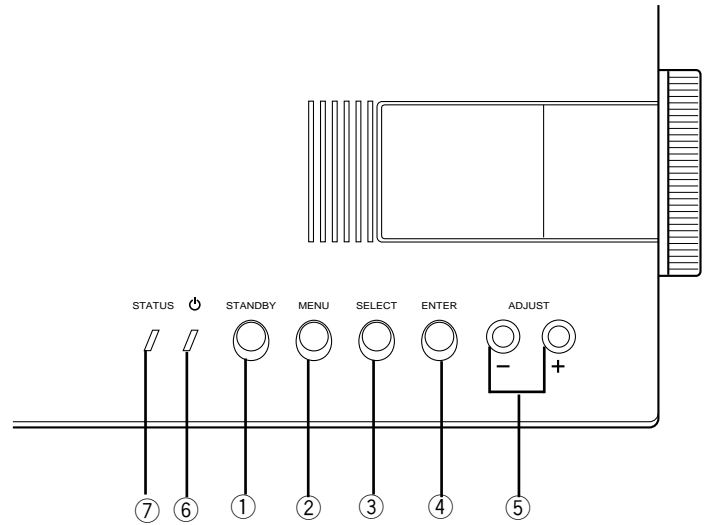

Terminal Panel Features

This panel is located in the side and is where you connect your cables.

① Video Input

Connect a VCR, laser disk player, or document camera here to project video.

Left Channel/Mono Audio Input Jack

This is your left channel audio input for stereo sound coming from video equipment or audio system. This also serves as your monaural audio input.

Right Channel Audio Input Jack

This is your right channel audio input for stereo sound.

S-Video Input

Here is where you connect S-Video input from an external source like a VCR.

② PC Control Port

Port for settings at time of shipment from factory.

③ RGB Input Connector (D-Sub 15 pin)

Connect your PC or other RGB equipment such as IBM or compatible computers. Use the signal cable that's supplied to connect to a PC.

RGB Audio Input Mini Jack

This is where you connect RGB audio output from a computer or another RGB source.

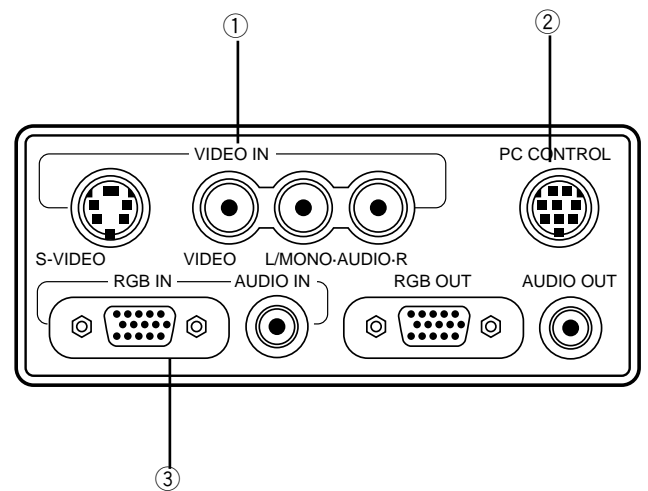

NOTE: S-Video provides more vivid color and higher resolution than the traditional composite video format.

④ RGB Output Connector (Mini D-Sub 15 pin)

The video image input to the RGB INPUT terminal is output on the monitor.

Even if VIDEO is selected, the video image input to the RGB INPUT terminal is output.

⑤ Built-in Security Slot ()

This security slot supports the MicroSaver® Security System.

MicroSaver® is a registered trademark of Kensington Microware Inc. The logo  is trademarked and owned by Kensington Microware Inc.

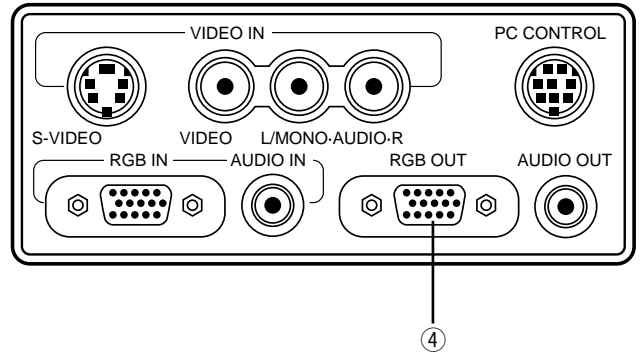

NOTE: The PC CONTROL terminal is for service personnel.

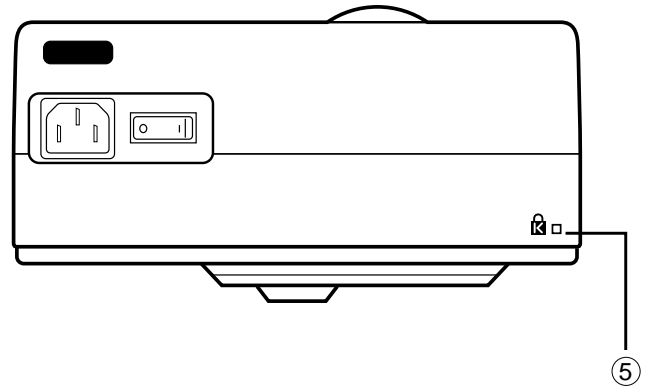

Remote Control Features

You can use your remote control wireless to operate your UP-800 Data Projector. With the remote mouse receiver connected to your computer, you can also use the projector's remote control to operate your computer's mouse wireless, too. (See page E-20 to connect the remote mouse receiver to your computer.)

NOTE: If you are using a Macintosh computer, you can click either the right or left button to activate the mouse.

① Left Click Button

Use this button to enter your menu selection. It works the same as the "Enter" button on the cabinet.

② Infrared Transmitter

Direct the remote control toward the remote sensor on the projector cabinet or the remote mouse receiver.

③ LED

Flashes when any button is pressed.

④ Power On And Off

If your main power switch is turned on, you can use this button to turn your UP-800 Data Projector on and off.

⑤ Video Button

Press to select an NTSC, PAL, SECAM or NTSC4.43 compatible video source from a VCR, laser disc player or document camera.

⑥ S-Video Button

Press to select an S-Video source from a VCR.

⑦ RGB Button

Press to select a video source from a computer connected to your RGB port.

⑧ Volume Buttons

Adjusts the volume for the projector main unit speakers.

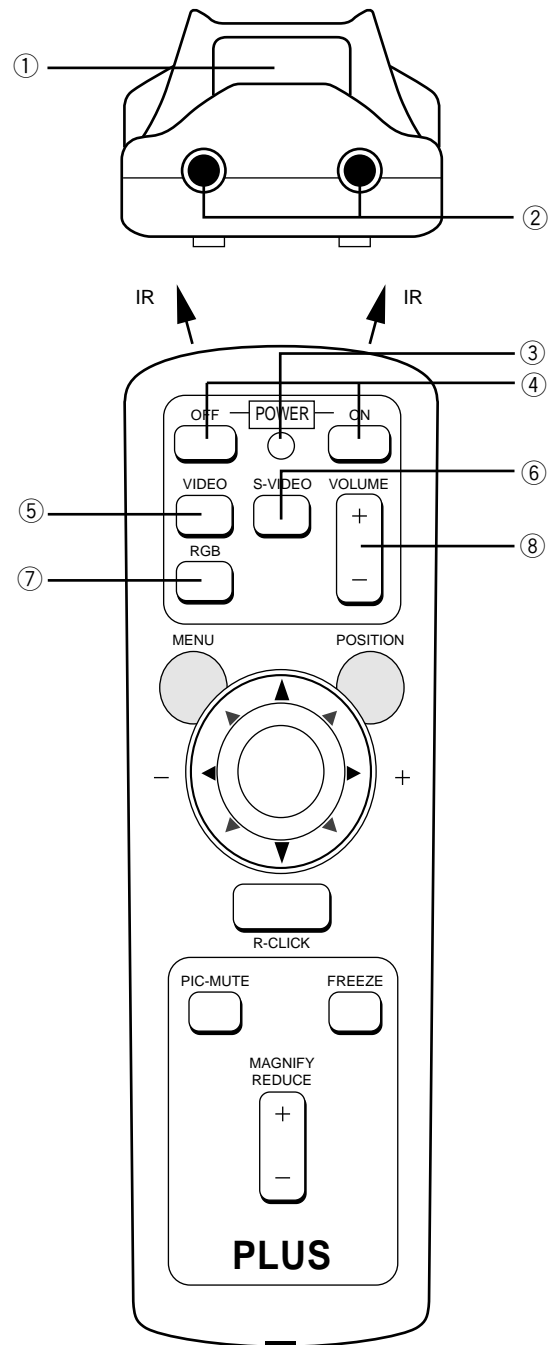

⑨ Menu Button

Use this button to call up the On-Screen Menu so you can adjust and set the image. After you press this button, it will light up. During this time you can use the mouse pointer and right / left click buttons to make menu selections. If no buttons are pressed within 10 seconds while it illuminates, the light goes out. To return to the main menu from a sub menu, press this button again.

⑩ Mouse Pointer Buttons

Works as a mouse for your projected computer image. This button is also used to adjust position.

These buttons select the submenu you want to adjust. (See page E-22.)

After you make your on-screen menu selection, use this button to adjust the level up or down. (See page E-22.)

⑪ Right Click Button

Press this button to exit "Menus" or "Position."

⑫ Picture Mute Button

This button turns off the image for a short period of time. Press again to restore the image.

⑬ Position Button

When the picture is magnified, press this button to activate the mouse buttons that you can use to reposition the image in eight directions. When you're finished, the "Position" button will remain lit for 10 seconds.

NOTE: When you are adjusting Position, the Mouse Pointer button is used to move the picture.

⑭ Freeze Button

This button will freeze a picture. Press again to resume motion.

⑮ Magnify/Reduce Button

Use the (+) or (-) button to adjust the image size up to 400%.

NOTE: You cannot use Menu and Position at the same time.

Remote Control Precautions

- Handle the remote control carefully.
- If the remote control gets wet, wipe it dry immediately.
- Avoid excessive heat and humidity.
- If you will not be using the remote control for a long time, remove the batteries.
- Do not mix new and old or different types of batteries.
- There are operations that can only be carried out by remote control. Be careful during use.

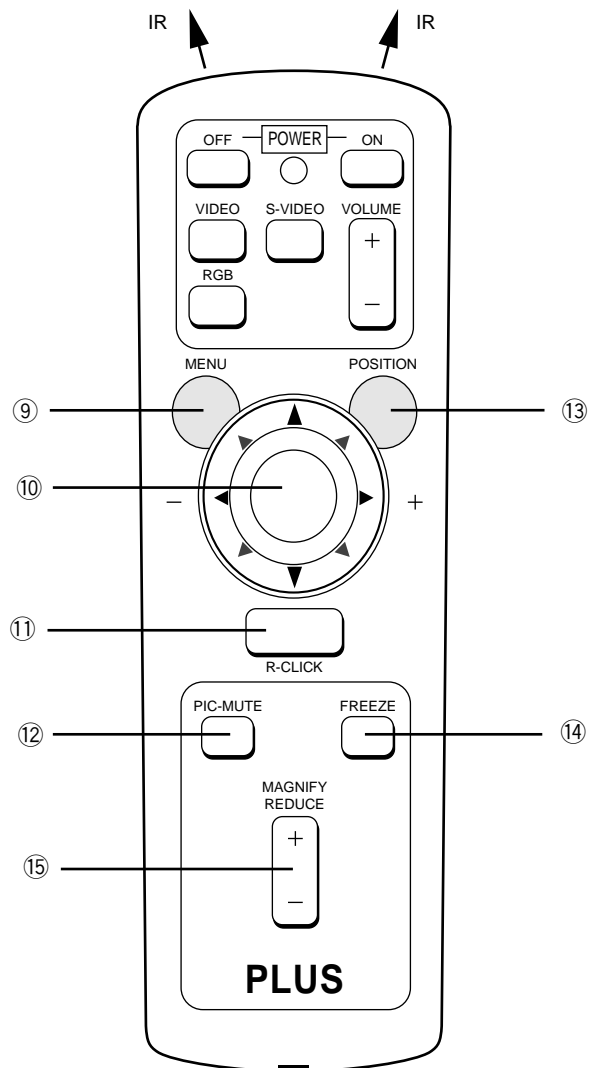

2 INSTALLATION

This section describes how to set up your UP-800 Data projector and how to connect video and audio sources.

Setting Up Your UP-800 Data Projector

Your UP-800 Data Projector is simple to set up and use. But before you get started, you must first:

1. Determine the image size
2. Set up a screen or select a non-glossy white wall onto which you can project your image.

Carrying The Data Projector Always carry your Data projector by the carrying case. Ensure that the power cord and any other cables connecting to video sources are disconnected before moving the projector. When moving the projector or when it is not in use, cover the lens with the lens cap.

Selecting A Location The further your Data projector is from the screen or wall, the larger the image. The minimum size the image can be is approximately 24" (0.61 m) measured diagonally when the projector is roughly 1.0 m (3 feet) from the wall or screen. The largest the image can be is 300" (7.6 m) when the projector is about 12.0 m (39.37 feet) from the wall or screen.

Using A Tabletop Or Cart

1. Place your Data projector on a flat level surface at the optimal distance from the screen or wall so you realize the size image you want. (Avoid having bright room lighting or sun light directly on the screen or wall where you'll be projecting the image.)
2. Connect the power cable, remove the lens cap and turn the projector on. (If no input signal is available, the projector will display a background image.)
3. Make sure that the projector is square to the screen.
4. Move the projector left or right to center the image horizontally on the screen. (A)
5. To center the image vertically (B),
6. To fine tune the image's position vertically on the screen, rotate each front foot.
7. Adjust the size of the screen with the zoom ring lever on the projector main unit.

Adjustment method

1. Set the adjuster to the most tight state.
2. If the screen is at an angle, turn the two adjusters to tilt the main unit and adjust until the main unit and screen are parallel.

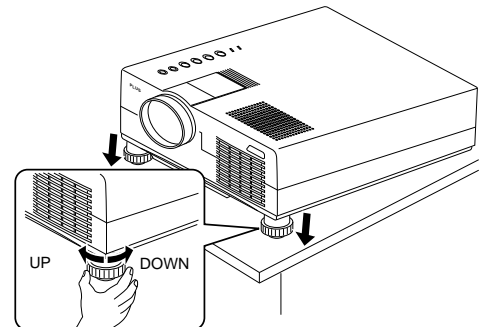
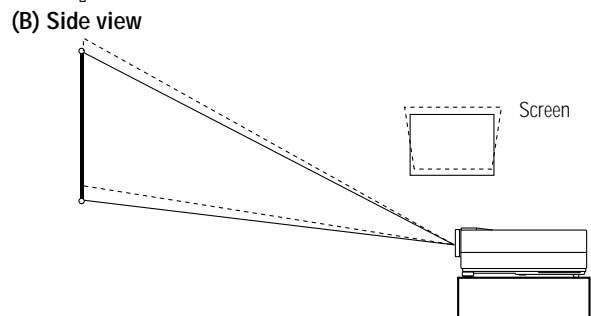
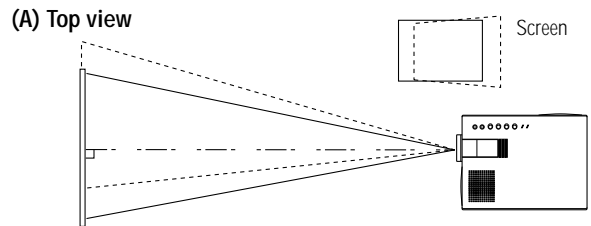
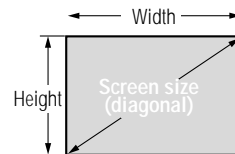
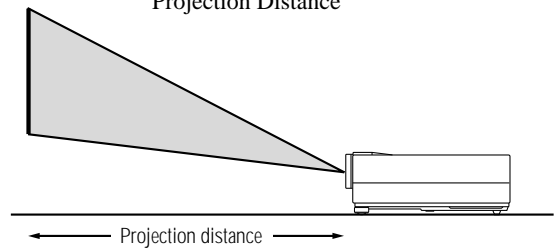
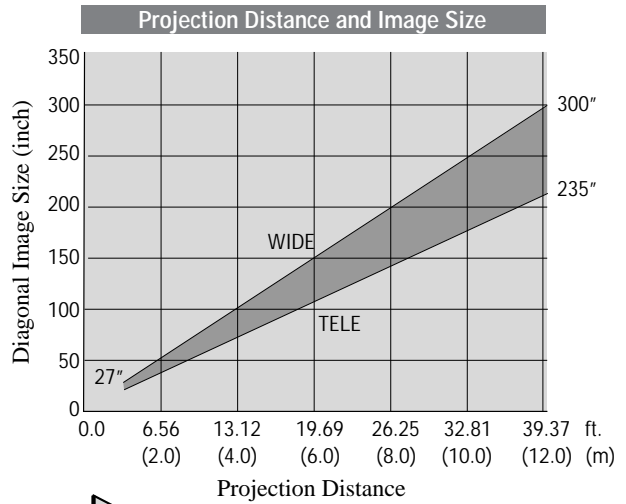

Note: Adjust with the adjusters so that the lens surface is parallel to the screen. If you use the projector with the screen tilted, the picture will be distorted.

Moving the projector

When moving the projector, use the carrying case that came with it.
How to store the projector in the carrying case

- 1.** Remove any accessories.

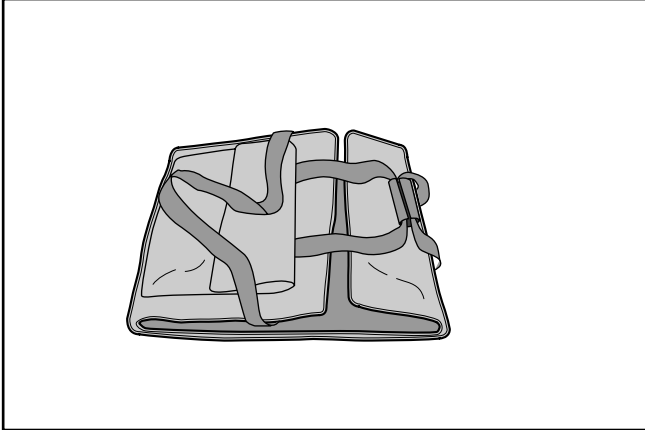

- 2.** From the folded state, open the carrying case.

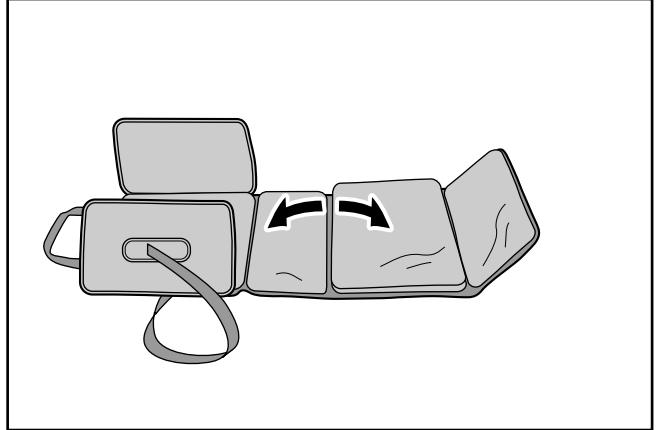

- 3.** Put the projector main unit in the square box section.

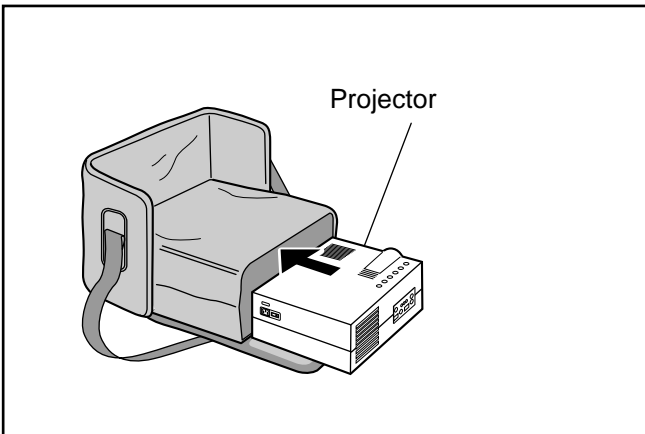

- 4.** With the projector packed in the carrying case this way, zip up the sides.

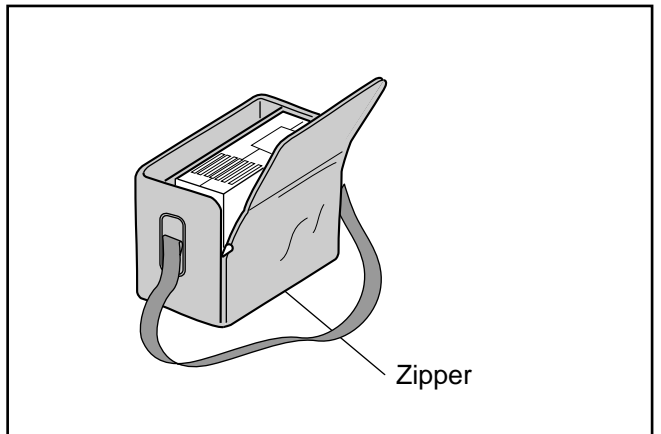

- 5.** Put the notebook PC into the carrying case too.
(Completely close the zipper.)

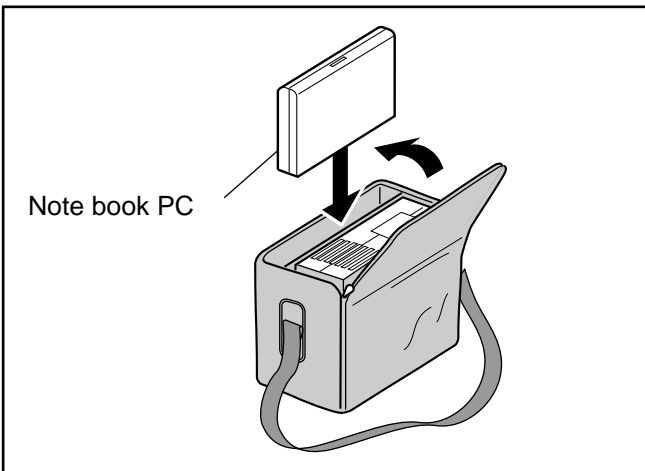

- 6.** Put the remote controller and other accessories into the carrying case.

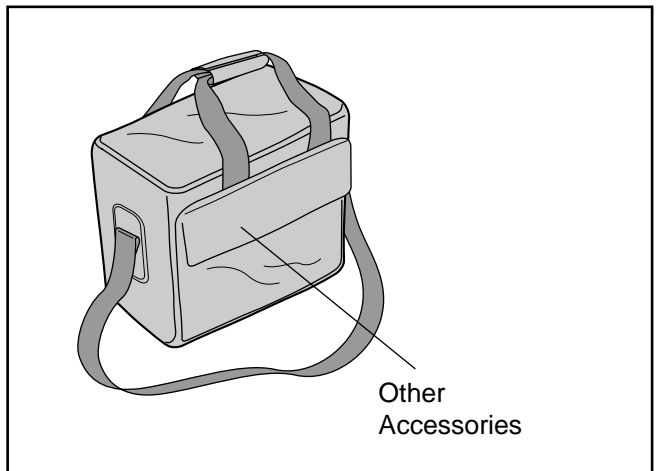

* Carry the projector carefully. Subjecting the projector to strong mechanical shock can cause breakdown.

Projection distance and screen size examples

- Horizontal projection position — Lens centered left to right
- Vertical projection position

Screen size Inches	Projection distance L m		Dimension H cm
	Wide (W)	Tele (T)	Both W & T
24	—	1.20	7.0
40	1.60	2.10	12.2
60	2.40	3.15	17.6
80	3.25	4.20	23.8
100	4.05	5.30	29.1
200	8.20	10.65	59.9
300	12.30	—	89.1

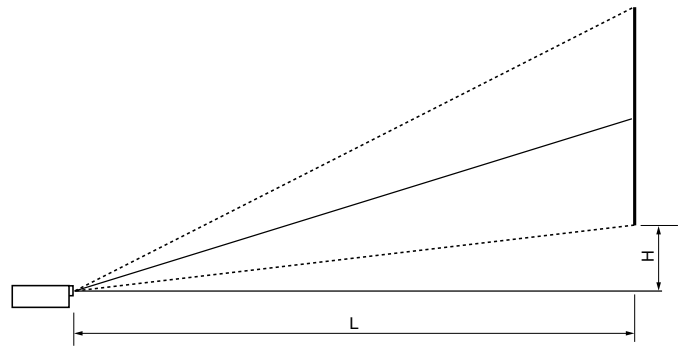

⚠ WARNING

- Only use your Data projector on a solid, level surface. If the projector falls to the ground, you can be injured and the projector severely damaged.
- Do not use the Data projector where temperatures vary greatly. The projector must be used at temperatures between 0°C (32°F) and 40°C (104°F).
- Do not expose the Data projector to moisture, dust, or smoke. This will harm the screen image.
- Ensure that you have adequate ventilation around your Data projector so heat can dissipate. Do not cover the vents on the bottom or the side of the projector.

Ceiling Installation

Installing your UP-800 Data Projector on the ceiling must be done by a qualified technician. Contact your PLUS dealer for more information.

Do not attempt to install the projector yourself.

If your projector is mounted on the ceiling and your image is upside down, use the “Menu” and “Select” buttons on your projector cabinet or (▲) (▼) buttons on your remote control to correct the orientation. (See page E-26.)

Using the ceiling hanging fixtures

When using the ceiling hanging fixtures, select Front/Ceiling hanging as the projection method on the detailed menu.

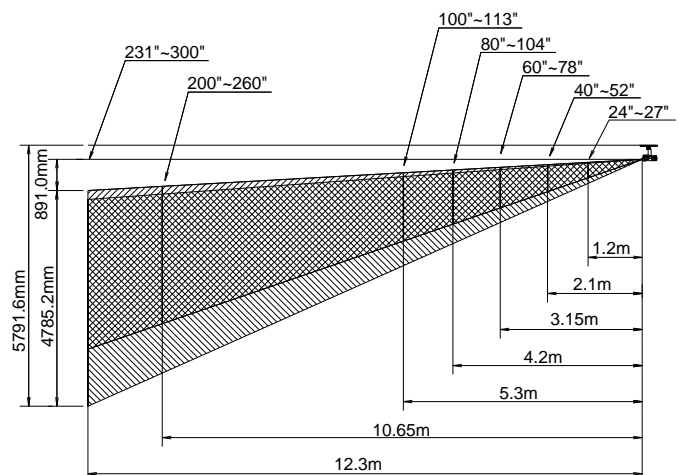

Wiring Diagram

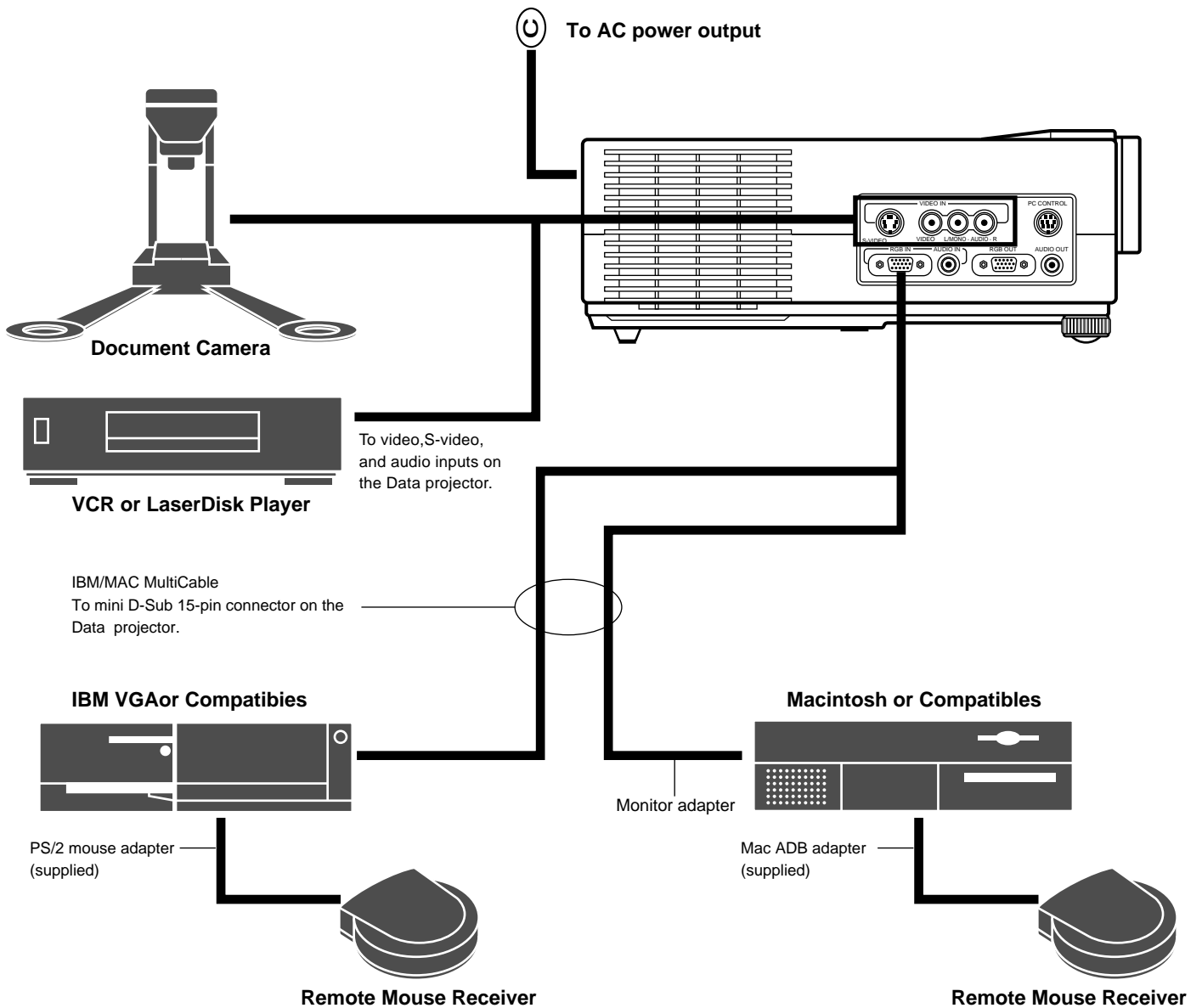

Remote Control Guideline

1. Plug the serial cable with the remote mouse receiver into your computer's mouse port and restart your computer to gain remote mouse control.
2. When using the remote control's built-in infrared mouse on a laptop computer, the laptop's mouse, trackball or trackpad will be disabled. Disconnect the infrared receiver and restart your computer to regain trackball or trackpad mouse control.
3. If the screen goes blank while using your remote control, it may be the result of the computer's screen-saver or power management software. If you accidentally hit the OFF button on the remote control, wait one full minute and then press the ON button to resume.

Connecting Your PC Or Macintosh Computer

Connecting your PC or Macintosh computer to your UP-800 Data Projector will enable you to project your computer's screen image for an impressive presentation. All of these following display standards are supported:

VGA 640×480 for graphics	VGA 640×400 for graphics
VGA 640×350 for graphics	VGA 720×400 for text
VGA 720×350 for text	SuperVGA 800×600
Macintosh at 640×480	Macintosh at 832×624

To connect to a PC, Macintosh or computer equipped with a SuperVGA/VGA adapter or compatible graphics adapter, simply:

1. Turn off the power to your Data projector and computer.
2. If your PC does not support SuperVGA/VGA you will need to install a SuperVGA/VGA graphics board. Consult your computer's owner's manual for your SuperVGA/VGA configuration. If you need to install a new board, see the manual that comes with your new graphics board for installation instructions.
3. Use the signal cable that's supplied to connect your PC or Macintosh computer to the Data projector. For a PC, use the smaller 15-pin connector on the cable to connect to your computer's video port; use the larger 15-pin connector on the cable to connect to the projector's RGB input. For Macintosh, use the larger 15-pin connector on the cable to connect to your computer's video port; use the smaller 15-pin connector on the cable to connect to the projector's RGB input. (You can also use your own video cable if you wish. For a PC cable, use the smaller 15-pin connector RGB on the projector. For a Macintosh cable, use the larger 15-pin connector RGB on the projector.)
4. Turn on the Data projector and the computer.
5. If the projector goes blank after a period of inactivity, it may be caused by a screen saver installed on the computer you've connected to the projector.

DIP switch setting (● = ON)

MONITOR	RESOLUTION	1	2	3	4	5	6
MULTIPLE SCAN 21		●	●				●
MULTIPLE SCAN 17		●	●			●	
MULTIPLE SCAN 16		●	●			●	●
VGA/SVGA				●	●		
21 COLOR	1152×870	●	●	●	●		
19 COLOR	1024×768		●	●			
16 COLOR	832×624		●		●		
13 COLOR	640×480	●	●				

Refer to the manual that came with the adaptor.

Inch 13

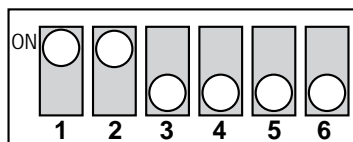

MULTIPLE SCAN 17

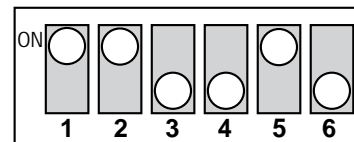

VGA/SVGA

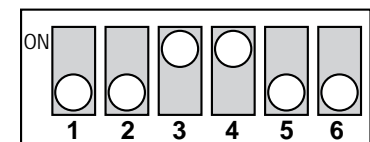

NOTE: Refer to your computer's owner's manual for more information about your computer's video output requirements and any special identification or configuring your projector's image and monitor may require.

Changing Video Resolutions

Depending on your computer's graphic capability, you may be able to select one of several resolutions. Generally a computer- either a PC or Macintosh- with 1 meg. of memory will run:

- 640 × 480 at 16.7 million colors (24 bit Truecolor)
- 800 × 600 at 65000 colors.
- 1024 × 768 at 256 colors.

As the resolution increases, the number of colors you can run decreases. With 2 meg. of memory a computer will run:

- 640 × 480 at 16.7 million colors (24 bit Truecolor).
- 800 × 600 at 16.7 million colors (24 bit Truecolor).
- 1024 × 768 at 65000 colors.
- 1280 × 1024 at 256 colors.

Windows 95

There are two methods you can use to change your resolution.

Method 1

1. Move your cursor to the background image and click.
2. In the "Properties" menu, select "Settings."
3. Change your resolution and click "OK."
4. You may be asked to reboot for the changes to take affect, or you' ll get a message that "Windows is about to resize your display." You' ll be asked if you want to keep your settings. Select "Yes."

Method 2

1. Click on your "My Computer" icon.
2. Open "Control Panel" and select "Display."
3. Change your resolution and click "OK." after the new resolution is selected.
4. You may be asked to reboot for the changes to take affect, or you' ll get a message that "Windows is about to resize your display." You' ll be asked if you want to keep your settings. Select "Yes."

Windows 3.1

1. Click on the "Main" icon and open "Control Panel."
2. Select "Change System Settings" and click on "Option."
3. Choose "Change Display Settings."
4. Select the resolution you want.
5. Choose the current drive or another.
6. Restart Windows for the changes to take affect.

Macintosh

1. Under the Apple menu, select "Control Panels" and open "Monitors."
2. Click and open "Options."
3. Select your new resolution and click "OK."

Notebook Computers And Resolution Standards

The UP-800 Data projector is designed to project industry standardized video such as VESA (Video Electronics Standards Association) or VGA (Video Graphics Array). Notebook computers do not use industry standards. They use whatever timing is necessary to match their local LCD display. The end result is typically not standards. By turning off your notebook's display, the timing parameters are a bit more like the real VESA or VGA signal.

For an optimal projected image with a notebook computer, it is recommended that you use the CUSTOM 6 memory data. This feature is useful when an S-VGA image (800×600) is displaying with a notebook computer supported by XGA (1024×768). See Source Menu on page E-23 for more information.

Connecting Your Document Camera

You can connect your UP-800 Data Projector to a document camera. To do so, simply:

1. Turn off the power to your Data projector and document camera.
2. Use a standard video cable to connect your document camera to the Video input on your Data projector.
3. Turn on the Data projector and the document camera.

NOTE: Refer to your document camera's owner's manual for more information about your camera's video output requirements .

Connecting Your VCR Or Laser Disc Player

You use common RCA cables (not provided) to connect your VCR or laser disc player to your UP-800 Data Projector. To make these connections, simply:

1. Turn off the power to your Data projector and VCR or laser disc player.
2. Connect one end of your RCA cable to the video output connector on the back of your VCR or laser disc player, connect the other end to the Video input on your projector. Use standard RCA audio patch cords to connect the audio from your VCR or laser disc player to your projector (if your VCR or laser disc player has this capability). Be careful to keep your right and left channel connections correct for stereo sound.
3. Turn on the Data projector and the VCR or laser disc player.

NOTE: Refer to your VCR or laser disc player owner's manual for more information about your equipment's video output requirements.

Connecting An External Monitor

You can connect a separate, external monitor to your Data projector to simultaneously view on a monitor the image you're projecting. To do so:

1. Turn off the power to your Data projector and computer, document camera or video source.
2. Use a 15-pin cable to connect your monitor to the RGB OUT connector on your Data projector.
3. Turn on the Data projector and the computer, document camera or video source.

Connecting Your Remote Mouse Receiver

The remote mouse receiver enables you to operate your computer's mouse functions from the remote control. It is a great convenience for clicking through your computer-generated presentations.

To connect the remote mouse receiver:

1. Turn off your computer.
2. For PCs: Remove your current mouse and connect the serial cable from the remote mouse receiver to your PC's mouse port. (Use the 6-pin adapter for connecting to a PS/2 computer.)
For Macintosh: Remove your current mouse from your computer, attach the Macintosh adapter to the remote mouse receiver's serial cable, and connect the receiver to your mouse port.
3. When the remote mouse receiver is installed, it will disable your regular mouse, disconnect the remote mouse receiver and restart your computer.

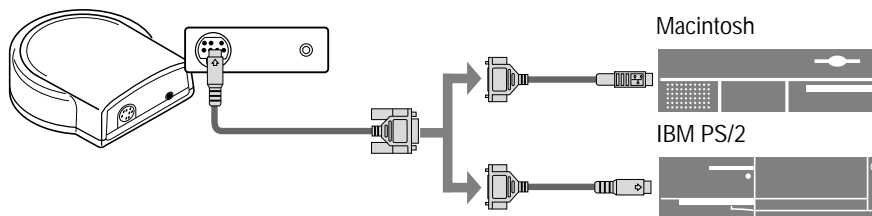
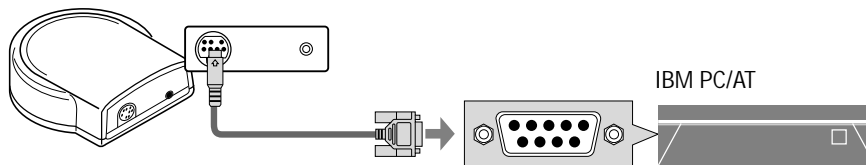

■ The Remote Mouse Receiver as a mouse for your computer

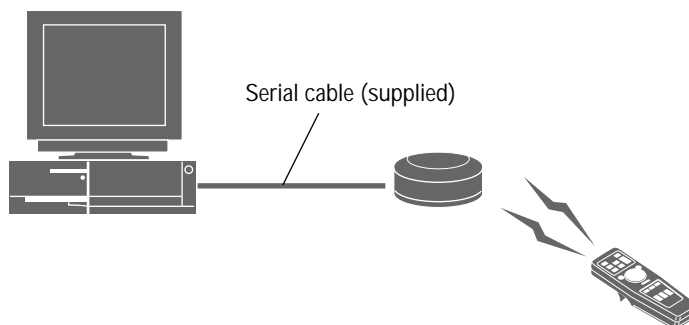

This section describes how to select a computer or video source and how to adjust the picture and sound.

General Controls Before you turn on your UP-800 Data Projector, ensure that the computer or video source is turned on and that your lens cap is removed.

1. **Turn On The Data Projector** The main power switch is on the back panel of the UP-800 Data Projector. By turning this switch on, the projector will go into its standby mode and the power light will glow amber. Only after you press the "On" button on the remote control or projector cabinet will the power light turn to green and the projector become ready to use.

NOTE: To turn the Data projector on and off with just the back panel switch, use the menu and enable the "auto start" feature. (See page E-25.)

2. **Select The Computer Or Video Source** Press the "Video" (VCR, document camera, or laser disc player), "S-video", or "RGB" (computer) button on the remote control to display the image. Or press the "Menu" button on the cabinet and use the icons to select your video source: "Video", "S-Video", or "RGB."
3. **Adjust The Image Size** Use the manual zoom control knob on the projector cabinet to make the image larger or smaller.
4. **Focus** Use the manual focus control ring projector cabinet to focus the image.
5. **Turning Off The Projector** First press the "off" button on the remote control or the projector cabinet. The power light will glow amber. Then turn off the main power switch on the back panel. The power light will go out.

IMPORTANT:

- The Data projector should be unplugged if it will not to be used for an extended period.
- To turn off the image briefly (five minutes or less), use the "Picture Mute" button instead of turning the projector off and on.
- The Data projector will display a black, blue, or loop image if no input signal is present.
- Do not turn the Data projector off and then immediately back on. The projector needs to cool for a minute before it can be restarted.

Using The Menus

1. Press the "Menu" button on the remote control or projector cabinet to display the Main Menu.
2. Press the "Select" button on the projector cabinet or (▲) (▼) buttons on your remote control to highlight the menu for the item you want to adjust.
3. Press the "Enter" button on the projector cabinet or the "Left Click" button on the remote control to select a submenu or item.
4. Adjust the level or turn the selected item on or off by using the "Adjust" (+) or (-) buttons on the remote control or cabinet. The on-screen gauge will show you the amount of increase or decrease. [The (+) button is "on" and (-) is "off".]
5. The change is stored until you adjust it again.
6. Repeat steps 2-5 to adjust an additional item, or press "Right Click" on your remote control to quit the menu display.

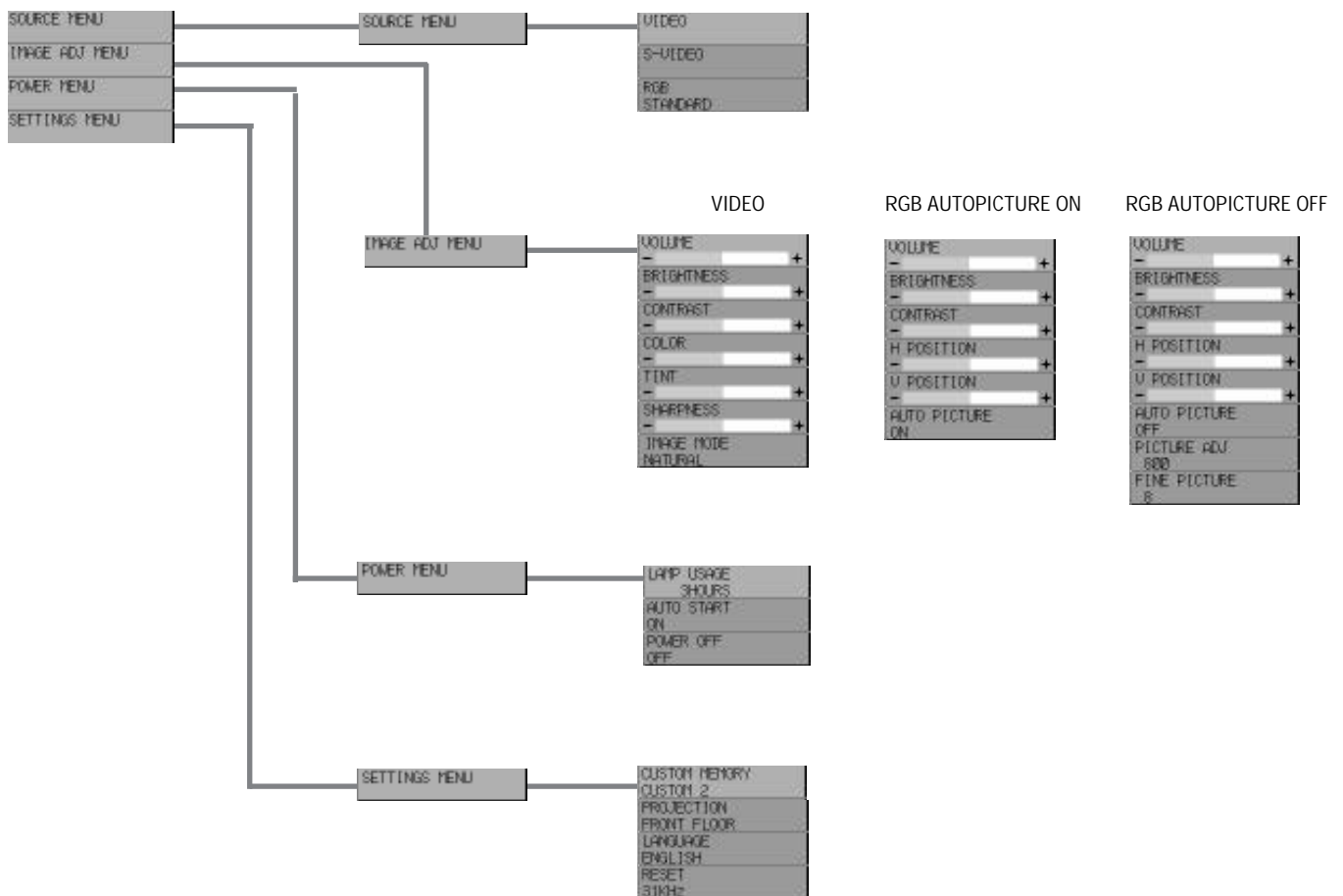

Menu Descriptions & Functions

Source Menu

A rectangular button with the text "SOURCE MENU" in all caps.

Enables you to select a video source such as a VCR, laser disk player, computer or document camera depending on what is connected to your inputs. Press the "Select" button on the projector cabinet or (▲) (▼) buttons on your remote control to highlight the menu for the item you want to adjust.

A rectangular menu item with the text "VIDEO" in all caps.

Video

Selects what is connected to your Video input-VCR, laser disk player or document camera.

A rectangular menu item with the text "S-VIDEO" in all caps.

S-Video

Selects what is connected to your S-Video input-VCR, or laser disk player.

A rectangular menu item with the text "RGB" in all caps.

RGB

Selects what is connected to your RGB input—a computer. Use the "Adjust" (+) or (-) buttons to select a standard* or one of six** custom settings you can create. Press the "Enter" button on the cabinet or the "Left Click" button on the remote control to save your selection.

A rectangular menu item with the text "STANDARD" in all caps.

NOTE:

* Standard is normally used and it can be user changed and automatically recalled.

** "Custom 6" is read only. This feature is useful when an S-VGA image (800×600) is displayed with a notebook computer supported by XGA (1024×768).

Image Adjustment Menu



Provides access to controls for your image and sound. Use the “Select” button on the projector cabinet or (▲) (▼) buttons on your remote control to highlight the menu for the item you want to adjust. The volume, brightness, contrast, color, tint, sharpness and Image Mode controls are available for Video or S-Video sources.

The volume, brightness, contrast, horizontal position, vertical position and auto picture controls are available for RGB source.



Volume

Use the “Adjust” (+) or (–) buttons to adjust the volume.

Brightness

Use the “Adjust” (+) or (–) buttons to adjust the brightness.

Contrast

Use the “Adjust” (+) or (–) buttons to adjust the contrast.

Color*

Use the “Adjust” (+) or (–) buttons to adjust the color.

Tint*

Use the “Adjust” (+) or (–) buttons to adjust the tint.

Sharpness*

Use the “Adjust” (+) or (–) buttons to adjust the sharpness.

Image Mode*

Use the “Adjust” (+) or (–) buttons to choose “Normal” for a regular picture “Natural” for true color reproduction, or “Document Camera” for a document camera or other low APL picture.

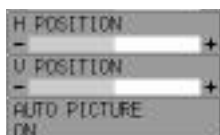

Horizontal Position**

Use the “Adjust” (+) button to move the image right; (-) to move it left.

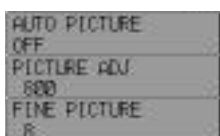

Vertical Position**

Use the “Adjust” (+) button to move the image up; (-) to move it down.

Auto Picture**

Use the “Adjust” (+) button to turn this feature on so “Picture” and “Fine Picture” adjustments are made automatically. Use the “Adjust” (-) button to turn this feature off so you can make “Picture and Fine Picture” adjustments manually.

Picture Adjustment** (when AUTO PICTURE is off)

Use this icon with the “Fine Picture Adjustment” to fine tune the computer image or to remove any vertical banding that might appear. This function adjusts the clock frequencies that eliminate the horizontal banding in the image. Press the “Adjust” (+) and (-) buttons until the banding disappears. This adjustment may be necessary when you connect your computer for the first time. This adjustment is made automatically when the Auto Picture is turned on.

Fine Picture** (when AUTO PICTURE is off)

Use this icon to adjust the clock phase or to reduce video noise, dot interference or cross talk. (This is evident when part of your image appears to be shimmering.) Use the “Adjust” (+) and (-) buttons to adjust the image. Use the Fine Adjustment only after the Picture Adjustment is complete. This adjustment is made automatically when the Auto Picture is turned on.

NOTE:

* Color, Tint, Sharpness and Image Mode controls will not work with an RGB source. The Tint control will not work with a PAL or SECAM source.

** Horizontal and Vertical position controls, and Picture, Fine Picture and Auto Picture adjustments will not work with a Video or S-Video source.

Power Menu



Provides access to Lamp Usage information and the Auto Start and Power Management features. Use the “Select” button on the projector cabinet or (▲) (▼) buttons on your remote control to access a submenu. Then press “Adjust” (+) or (-) to choose a specific option.

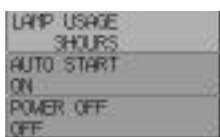

Lamp Usage

This tells you how long the lamp has been in operation. It is recommended that you replace a lamp after 1000 hours of service. After you install a new lamp, select this icon and press and hold the “Power On” button on the remote control for ten seconds to reset the lamp clock back to zero.

NOTE: The projector will turn off and be in standing by after 1100 hours of service. If this happens, press the “Power Off” button on the remote control for ten seconds to reset the lamp clock back to zero. Do this only after replacing the lamp.

Auto Start

Turns the Data projector on automatically when the main power switch is turned on. This eliminates the need to always use the “Power” button on the remote control or projector cabinet. Press (+) to turn this feature on and (-) to turn it off.

Power Management

When “Power Off” is on and there is no RGB input for five minutes or more, the projector will automatically turn itself off. Press the (+) to turn this feature on and (-) to turn it off. This feature does not work with Video or S-Video sources.

Settings Menu

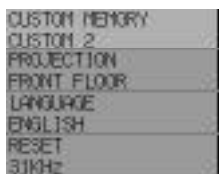

Enables you to set preferences and other operating options. Use the “Select” button on the projector cabinet or (▲) (▼) buttons on your remote control to access the submenu you want.

Custom Memory

This enables you to save your current settings for an RGB source in one of five memories, Custom 1-5.

“Custom 6” is read only. This feature is useful when an S-VGA image (800×600) is displayed with a notebook computer supported by XGA (1024×768).

To change the STANDARD settings, proceed as follows:

1. Connect your computer to the UP-800.
2. Select the "STANDARD" in RGB source.
3. Adjust the horizontal/vertical position, Picture, and Fine picture adjustments.
4. Select the Custom Memory icon.
5. Press the "Adjust" (+) or (–) buttons to choose a memory location, then press "Enter" on the cabinet or the "Left Click" on your remote control to save the new settings.

If you do not want to change the STANDARD settings, first select the Custom Memory icon, then do the same as step5.

Projection

This reorients your image for your type of projection. Press the “Adjust” (+) or (–) button until it is correct. Press “ENTER” on the cabinet or the “Left Click” on your remote control to save your change. The options are: front floor projection, rear ceiling projection, rear floor projection, and front ceiling projection.

Language

Use the “Adjust” (+) or (–) to choose one of six languages for on-screen instructions. Press “ENTER” on the cabinet or the “Left Click” on your remote control to save your change. The options are: English, German, French, Italian, Spanish and Swedish.

Reset

Changes all adjustments to the factory preset levels for each source individually. To activate, you must hold down the “Adjust” (+) button on the cabinet or remote control for at least two seconds. The adjustments that will be reset are horizontal and vertical control, picture and fine picture adjustment (for the current source only), brightness, contrast, color, tint, and sharpness.

4 Maintenance

This section describes the simple maintenance procedures you should follow to replace the lamp, clean and replace the batteries in the remote control.

Replacing The Lamp

After your lamp has been operating for 1000 hours or longer, the "status" light in the cabinet will go on. Even though the lamp may still be working, replace it at 1000 hours to maintain optimal projector performance.



CAUTION

- DO NOT TOUCH THE LAMP immediately after it has been used. It will be extremely hot. Allow at least one hour for the lamp to cool before handling.
- DO NOT REMOVE ANY SCREWS except the lamp cover set screw and two lamp case screws. You could receive an electric shock.
- Turn off the main power to the projector and disconnect the power cord. Allow at least one hour for the lamp to cool.
- The projector will turn off and be in standing by after 1100 hours of service. If this happens, be sure to replace the lamp.

Lamp replacement procedure

Preparations Carefully turning the projector main unit upside down in such a way that it does not get scratched makes it easier to replace the lamp. After the lamp has been replaced, return the projector main unit to the normal position.

1. Switch off the main power and unplug the power cord.
2. Turn the main unit so that the bottom is up.
3. Remove the lamp housing fastening screws.
4. Slide the lamp cover in the direction of the arrow and remove it.

CAUTION: Do not use a lamp other than the PLUS replacement lamp.
Order this from your PLUS dealer using your projector's model number.

5. Remove the three screws for the lamp housing.
Request This projector has a switch for safety.
6. Holding the handle, pull the lamp housing forward and take it off.
7. Install the new lamp housing and fasten with the three screws.
8. Fasten the three screws for the lamp housing.
9. Install the lamp cover back in its original position and fasten with the fastening screw.
10. Reset the lamp time.

Select the lamp usage time menu, then press the ON button on the remote controller and hold it down for at least ten seconds.

NOTE: If resetting the lamp clock back to zero after 1100 hours of service, press the "Power Off" (not "Power On") button on the remote control for ten seconds .

NOTE: When the lamp usage time reaches 1100 hours, it becomes impossible to switch on the power and menus are not displayed. In such a case, press the remote control OFF button for at least 10 seconds in the standby state. It is possible to confirm whether there has been reset or not by checking whether the STATUS indicator is extinguished. Obtain a replacement lamp at the store of purchase for this unit. When ordering a replacement lamp, specify the UP-800 special replacement lamp - model name UP-800L (Product code 28-861).

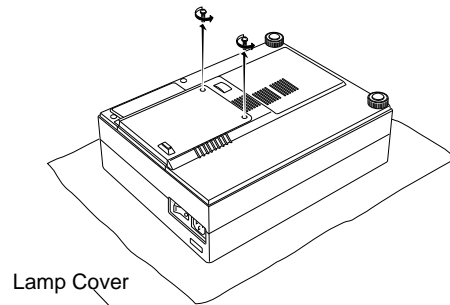

Step 3

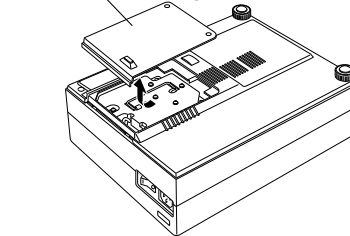

Step 4

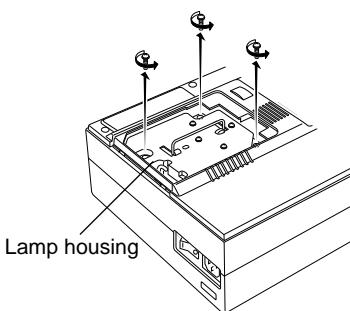

Step 5

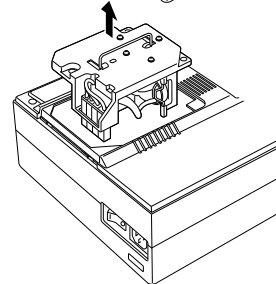

Step 6

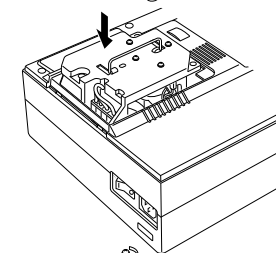

Step 7

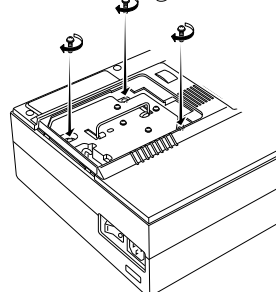

Step 8

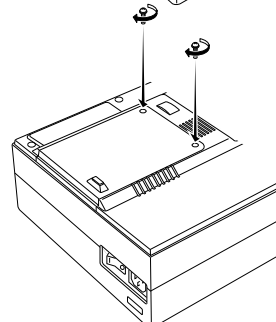

Step 9

Remote Control Battery Installation

1. Press firmly and slide the battery cover off.
2. Remove all two old batteries and install new ones (AA). Ensure that you have the batteries' polarity (+/-) aligned correctly.
3. Slip the cover back over the batteries until it snaps into place.

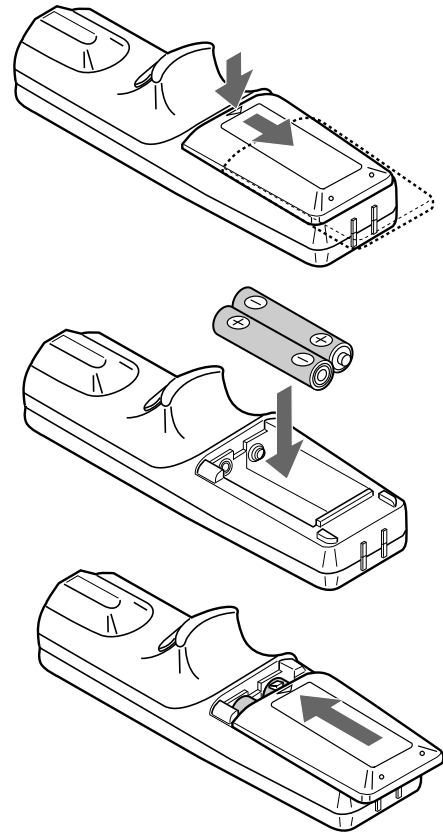

Remote control effective range

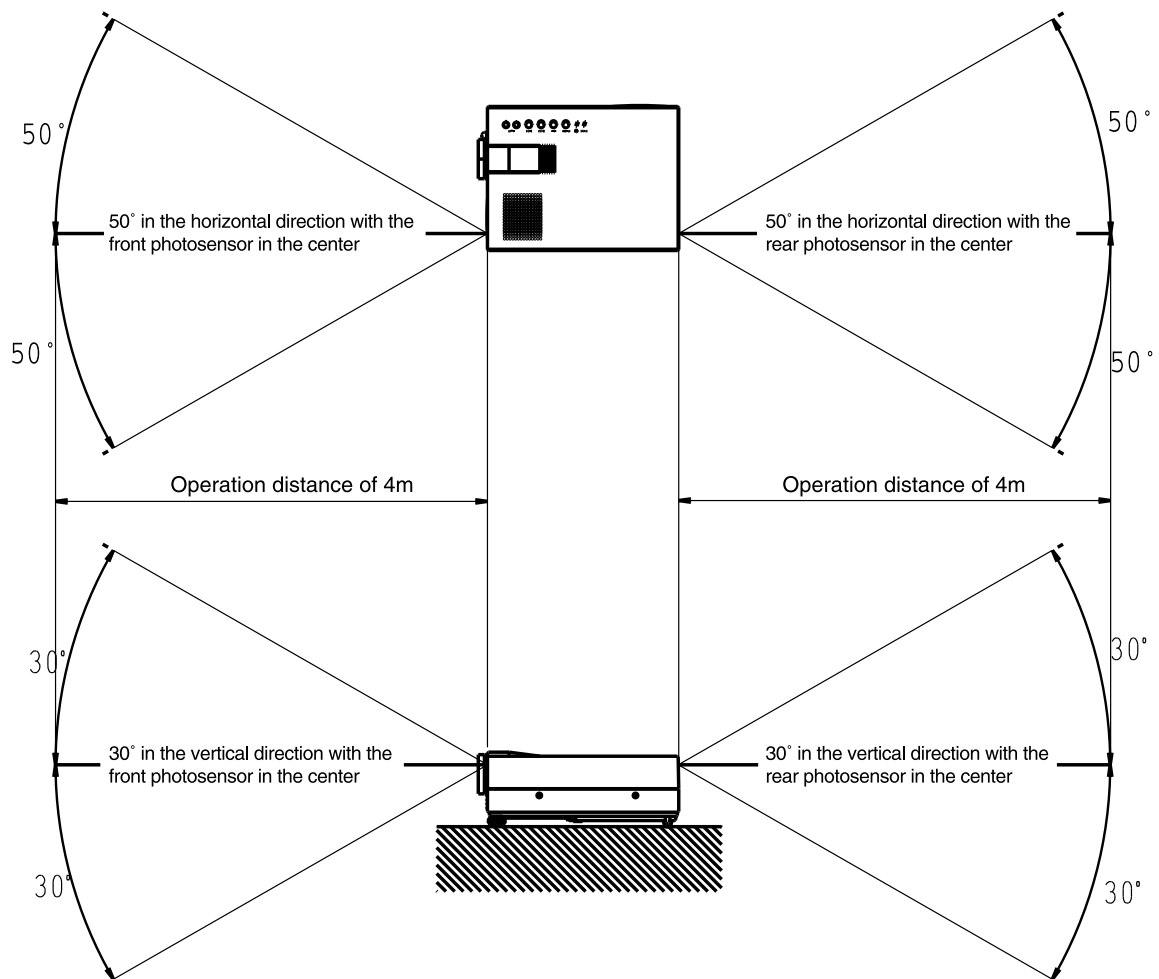

5 Troubleshooting

This section helps you resolve problems you may encounter while setting up or using your UP-800 Data Projector.

Status Light Messages

Condition	Status
<i>OFF</i>	<i>Normal</i>
<i>On Continually</i>	<i>The projector lamp has exceeded 1000 hours of operation and should be replaced.</i>
<i>Blinking Very Rapidly (On and off in a cycle of 1 sec.)</i>	<ul style="list-style-type: none"> • <i>The lamp housing is not correctly installed. Install it correctly.</i>
<i>Blinking Rapidly (On and off in a cycle of 4 sec.)</i>	<ul style="list-style-type: none"> • <i>The temperature protector has been triggered. If the room temperature is high, move the projector to a cool location. If the temperature within the projector is high, check the cooling fan ventilation hole and the ventilation hole on the bottom of the projector. If any of the holes are blocked, remove whatever is blocking them.</i> • <i>The temperature protector has been triggered. If you switch the main Power switch Off, then immediately switch it On again, sometimes the power does not come on. If this happens, wait one minute, then switch the power On again.</i> • <i>The lamp lighting voltage error detection protector has been triggered. Wait at least one minute then try switching on again. If this does not solve the problem, please contact the store of purchase.</i>
<i>Blinking Slowly (On and off in a cycle of 8 sec.)</i>	<i>The cooling fan has stopped. Contact your PLUS dealer for service.</i>
<i>Blinking Very Slowly (On and off in a cycle of 12 sec.)</i>	<p><i>The lamp is not turned on.</i></p> <ul style="list-style-type: none"> • <i>The projector was turned off and back on too quickly. Turn off the projector, wait one minute, then turn the projector back on. Or the lamp is burnt.</i>

Common Problems & Solutions

Problem	Check These Items
<i>Does not turn on</i>	<ul style="list-style-type: none"> • Check that the cord is plugged in and that the power switch on the back panel is on. • Check the status light to see if the projector has overheated or the lamp usage exceeds 1100 hours.
<i>No picture</i>	<ul style="list-style-type: none"> • Use the menu icons to select your source (Video, S-Video, or RGB). (See page E-23.) • Ensure your cables are connected properly. • Adjust the brightness and contrast. • Remove the lens cap. • Is the STNDBY indicator blinking?
<i>Image isn't square to the screen</i>	<ul style="list-style-type: none"> • Reposition the projector to improve its angle to the screen.
<i>Picture is blurred</i>	<ul style="list-style-type: none"> • Adjust the focus. (See page E-7 or E-11.) • Reposition the projector to improve its angle to the screen. • Ensure that the distance between the projector and screen is within the adjustment range of the lens.
<i>Image is scrolling vertically, horizontally or both</i>	<ul style="list-style-type: none"> • Select the source you want to input.
<i>Remote control does not work</i>	<ul style="list-style-type: none"> • Install new batteries. (See page E-28.) • Make sure there are no obstacles between you and the projector. • Stand within 13 feet (4m) of the projector.
<i>Status indicator is lit or blinking</i>	See the Status Light message chart on page E-29.
<i>Cross color in RGB mode</i>	If "Auto Picture" is off, turn it on. If "Auto Picture" is on, turn it off and balance the image with the Picture Adjustment icon and Fine Picture Adjustment icon.

6 Specifications

This section provides technical information about the UP-800 Data Projector's performance.

Optical

DMD™	Single Chip Digital Micro Device(DMD™), 800×600 dots
Lens	Manual zoom, manual focus F 3.0 f =27.5-35.75 mm
Lamp	Metal halide lamp 270 W
Image Size	610-7620 mm (24-300 inches) diagonal
Projection Distance	1.2 – 12.3m
Light Output	600 ANSI lumens (normally white)
Contrast Ratio	Greater than 200 : 1
Color Temperature	6000 Kelvin

Electrical

Inputs	Video (NTSC / PAL / SECAM / NTSC4.43) RGB (H:15-60 kHz, V: 50-85 Hz)
Video Bandwidth	60 MHz
Color Reproduction	Full color, 16.7 million colors simultaneously.
Horizontal Resolution	NTSC 550, PAL 350, SECAM 350, NTSC4.43 350 TV lines RGB 800 dots horizontal, 600 dots vertical
Power Requirement	100-120/220-240 VAC, 50/60 Hz
Input Current	6 A/3A (400W)

Mechanical

Dimensions	23.5 cm (W) x 12.2 cm (H) x 32.4 cm (D)
Net Weight	4.5 kg/9.9 lbs
Operational Temperatures	Date projector: 5° to 35°C (41°-95°F), 30-85% humidity Remote control: 0° to 60°C (32°-140°F) Remote mouse receiver: 0° to 60°C (32°-140°F)
Regulations	UL Approved (UL 1950, CSA 950) Meets DOC Canada requirements Meets FCC Class A requirements Meets EMC Directive (EN55022, EN61000-3-2, EN61000-3-3, EN50082-1) Meets Low Voltage Directive (EN60950, TÜV GS Approved)



Dimensions

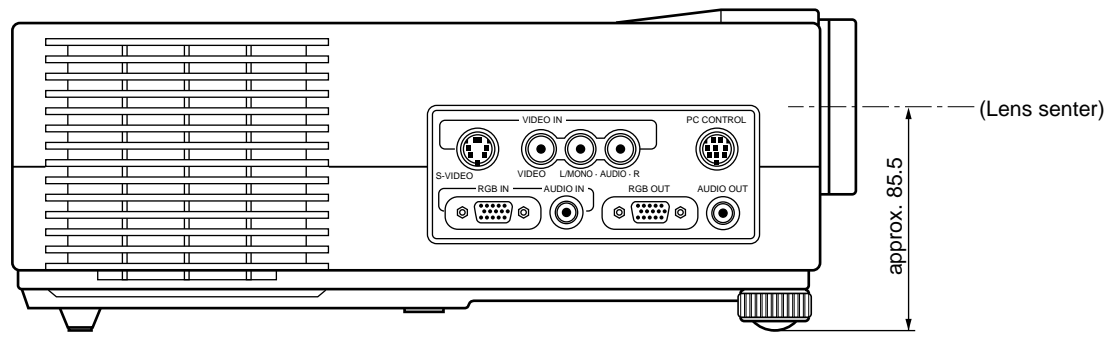
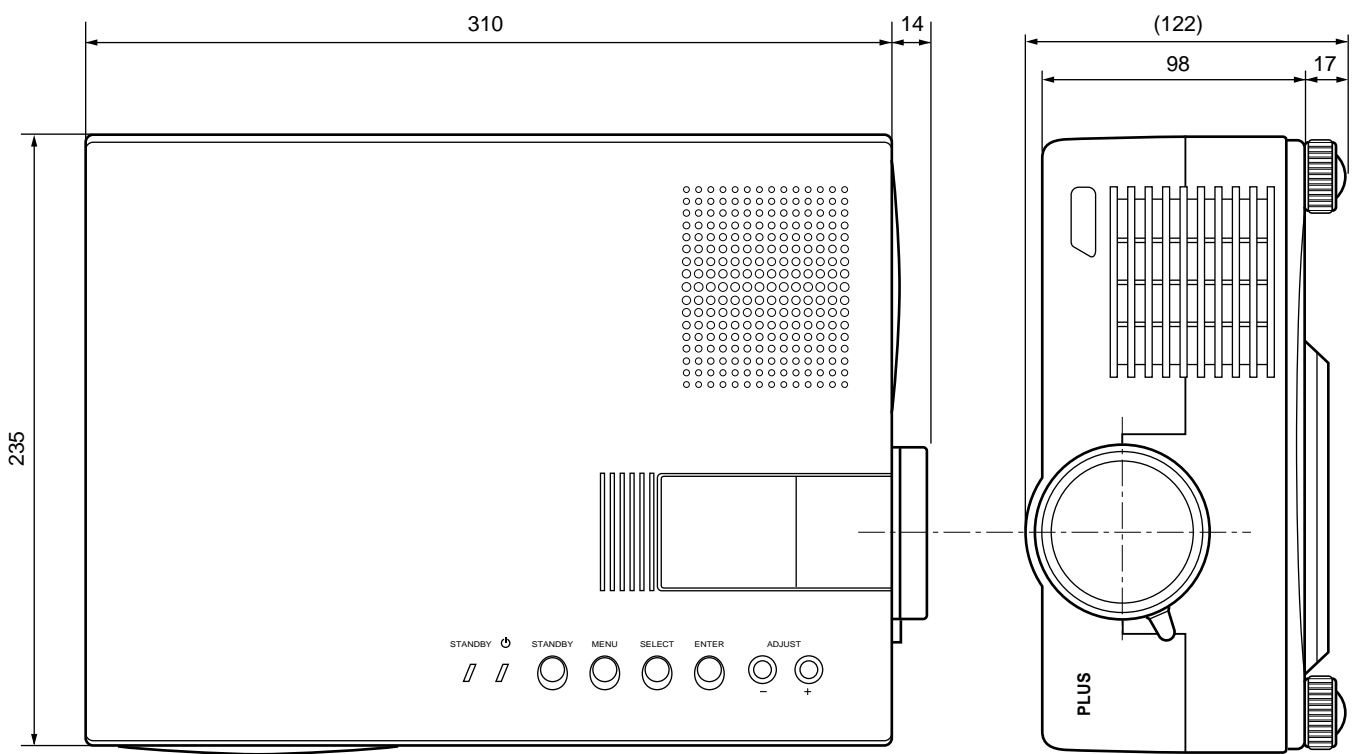

units : mm

D-Sub Pin Assignments

PC 15-Pin mini D-Sub

Pin No.	Signal to be connected
1	Red
2	Green
3	Blue
4	GND
5	GND
6	Red GND
7	Green GND
8	Blue GND
9	No Connection
10	Digital GND
11	GND
12	No Connection
13	Horizontal Sync
14	Vertical Sync
15	No Connection

PC 15-Pin mini D-Sub

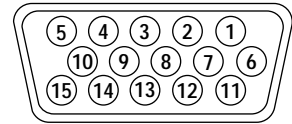

Timing Chart

Yes/No Signal	Resolution	Refresh Rate (Hz)	F.H. (kHz)	Dot Clk(MHz)	
Y	NTSC	640×480	60	15.734	-
Y	PAL	768×576	50	15.625	-
Y	SECAM	768×576	50	15.625	-
Y	VESA	640×350	85.08	37.86	31.5
Y	IBM	640×400	70	31.47	25.175
Y	VESA	640×400	85.08	37.86	31.5
Y	MAC	640×400	66	35	30.24
Y	VESA	640×480	59.94	31.47	25.175
Y	IBM	640×480	60	31.47	25.175
Y	MAC	640×480	60	31.47	25.175
Y	MAC	640×480	66.7	34.97	31.334
Y	MAC	640×480	66.67	35	30.24
Y	VESA	640×480	72.81	37.86	31.5
Y	VESA	640×480	75	37.5	31.5
Y	IBM	640×480	75	39.375	31.49
Y	VESA	640×480	85.01	43.269	36
Y	IBM	720×350	70.09	31.469	28.322
Y	IBM	720×400	70.09	31.4469	28.322
Y	VESA	720×400	85.04	37.927	40
Y	IBM	720×350	87.85	39.44	35.5
Y	IBM	720×400	87.7	39.375	35.5
Y	VESA	800×600	56.25	35.16	36
Y	VESA	800×600	60.32	37.879	40
Y	VESA	800×600	72.19	48.077	50
Y	VESA	800×600	75	46.88	49.5
Y	VESA	800×600	85.06	53.674	56.25
#	MAC	832×624	74.55	49.725	57.283
N	VESA	1024×768	43interlace	35.5	44.9
#	VESA	1024×768	60	48.363	65
#	VESA	1024×768	70.07	57.476	75
#	IBM	1024×768	72.03	58.131	79
#	MAC	1024×768	74.93	60.241	80
#	VESA	1024×768	75.03	60.023	78.75
N	VESA	1024×768	85	68.677	94.5

Incompatible signals are listed "N" and hatched. #1024×768 and #832×624 images are compressed into 800×600.

PLUS CORPORATION

3-B22, NAKASE 1-CHOME, MIHAMA-KU, CHIBA 261-01 JAPAN
PHONE: 043-296-3056 FAX: 043-296-3025
TELEX: J22113 PLUSJIM, CABLE PLUSJIMUK TOKYO