

Operating Instructions

Functional Manual

LCD Projector Commercial Use

Model No.	PT-EZ570E	PT-EZ570EL
	PT-EW630E	PT-EW630EL
	PT-EW530E	PT-EW530EL
	PT-EX600E	PT-EX600EL
	PT-EX500E	PT-EX500EL

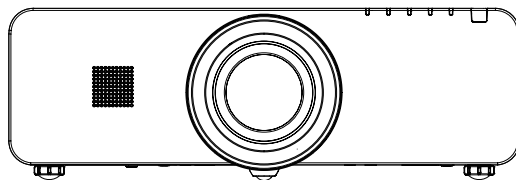

Thank you for purchasing this Panasonic Product.

- Before operating this product, please read the instructions carefully, and save this manual for future use.
- Before using your projector, be sure to read "Read this first!" (➔ pages 2 to 8).

The information of these instructions are shared use with multiple models of EZ570 series, EW630 series, EW530 series, EX600 series and EX500 series.

- Lens is optional for the projectors that "L" follows in model number.

Read this first!

WARNING: THIS APPARATUS MUST BE EARTHED.

WARNING: To prevent damage which may result in fire or shock hazard, do not expose this appliance to rain or moisture.

Machine Noise Information Ordinance 3. GSGV, January 18, 1991: The sound pressure level at the operator position is equal or less than 70 dB (A) according to ISO 7779.

WARNING:

1. Remove the plug from the mains socket when this unit is not in use for a prolonged period of time.
2. To prevent electric shock, do not remove cover. No user serviceable parts inside. Refer servicing to qualified service personnel.
3. Do not remove the earthing pin on the mains plug. This apparatus is equipped with a three prong earthing type mains plug. This plug will only fit an earthing-type mains socket. This is a safety feature. If you are unable to insert the plug into the mains socket, contact an electrician. Do not defeat the purpose of the earthing plug.

CAUTION: To assure continued compliance, follow the attached installation instructions, which includes using the provided power cord and shielded interface cables when connecting to computer or peripheral device. If you use serial port to connect PC for external control of projector, you must use optional RS-232C serial interface cable with ferrite core. Any unauthorized changes or modifications to this equipment will void the user's authority to operate.



WARNING: TURN OFF THE UV LAMP BEFORE OPENING THE LAMP COVER.

WARNING: TO REDUCE THE RISK OF FIRE OR ELECTRIC SHOCK, DO NOT EXPOSE THIS PRODUCT TO RAIN OR MOISTURE.

Power Supply: This Projector is designed to operate on 100 V - 240 V, 50 Hz/60 Hz AC, house current only.

WARNING: RISK OF ELECTRIC SHOCK, DO NOT OPEN.



The lightning flash with arrowhead symbol, within an equilateral triangle, is intended to alert the user to the presence of uninsulated "dangerous voltage" within the product's enclosure that may be of sufficient magnitude to constitute a risk of electric shock to persons.



The exclamation point within an equilateral triangle is intended to alert the user to the presence of important operating and maintenance (servicing) instructions in the literature accompanying the product.

Product information (for Turkey only)

EEE Yönetmeliğine Uygundur.
EEE Complies with Directive of Turkey.

IMPORTANT: THE MOULDED PLUG (U.K. only)FOR YOUR SAFETY, PLEASE READ THE FOLLOWING TEXT CAREFULLY.

This appliance is supplied with a moulded three pin mains plug for your safety and convenience. A 13 amp fuse is fitted in this plug. Should the fuse need to be replaced, please ensure that the replacement fuse has a rating of 13 amps and that it is approved by ASTA or BSI to BS1362.

Check for the ASTA mark  or the BSI mark  on the body of the fuse.

If the plug contains a removable fuse cover, you must ensure that it is refitted when the fuse is replaced. If you lose the fuse cover, the plug must not be used until a replacement cover is obtained. A replacement fuse cover can be purchased from an Authorised Service Center.

If the fitted moulded plug is unsuitable for the mains socket in your home, then the fuse should be removed and the plug cut off and disposed of safely. There is a danger of severe electrical shock if the cut off plug is inserted into any 13 amp socket.

If a new plug is to be fitted, please observe the wiring code as shown below.
If in any doubt, please consult a qualified electrician.

WARNING: THIS APPLIANCE MUST BE EARTHED.

IMPORTANT: The wires in this mains lead are coloured in accordance with the following code:

Green - and - Yellow:	Earth
Blue:	Neutral
Brown:	Live

As the colours of the wire in the mains lead of this appliance may not correspond with the coloured markings identifying the terminals in your plug, proceed as follows.

The wire which is coloured GREEN - AND - YELLOW must be connected to the terminal in the plug which is marked with the letter E or by the Earth symbol \perp or coloured GREEN or GREEN - AND - YELLOW.

The wire which is coloured BLUE must be connected to the terminal in the plug which is marked with the letter N or coloured BLACK.

The wire which is coloured BROWN must be connected to the terminal in the plug which is marked with the letter L or coloured RED.

How to replace the fuse: Open the fuse compartment with a screwdriver and replace the fuse.

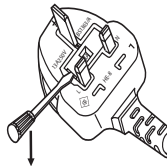

Read this first!

WARNING:

■ POWER

The wall outlet or the circuit breaker shall be installed near the equipment and shall be easily accessible when problems occur. If the following problems occur, cut off the power supply immediately.

Continued use of the projector in these conditions will result in fire or electric shock.

- If foreign objects or water get inside the projector, cut off the power supply.
- If the projector is dropped or the cabinet is broken, cut off the power supply.
- If you notice smoke, strange smells or noise coming from the projector, cut off the power supply.

Please contact an Authorized Service Center for repairs, and do not attempt to repair the projector yourself.

During a thunderstorm, do not touch the projector or the cable.

Electric shocks can result.

Do not do anything that might damage the power cord or the power plug.

If the power cord is used while damaged, electric shocks, short-circuits or fire will result.

- Do not damage the power cord, make any modifications to it, place it near any hot objects, bend it excessively, twist it, pull it, place heavy objects on top of it or wrap it into a bundle.

Ask an Authorized Service Center to carry out any repairs to the power cord that might be necessary.

Insert the power plug securely into the wall outlet.

If the plug is not inserted correctly, electric shocks or overheating will result.

- Do not use anything other than the provided power cord.
- Do not use the provided power cord for other electrical equipment.
- Do not use plugs which are damaged or wall outlets which are coming loose from the wall.

Clean the power plug regularly to prevent it from becoming covered in dust.

Failure to observe this will cause a fire.

- If dust builds up on the power plug, the resulting humidity can damage the insulation.
- If not using the projector for an extended period of time, pull the power plug out from the wall outlet.

Pull the power plug out from the wall outlet and wipe it with a dry cloth regularly.

Do not handle the power plug with wet hands.

Failure to observe this will result in electric shocks.

Do not overload the wall outlet.

If the power supply is overloaded (ex., by using too many adapters), overheating may occur and fire will result.

■ ON USE/INSTALLATION

Do not place liquid containers on top of the projector.

If water spills onto the projector or gets inside it, fire or electric shocks will result.

If any water gets inside the projector, contact an Authorized Service Center.

Do not place the projector on soft materials such as carpets or sponge mats.

Doing so will cause the projector to overheat, which can cause burns, fire or damage to the projector.

Do not set up the projector in humid or dusty places or in places where the projector may come into contact with oily smoke or steam, ex. a bathroom.

Using the projector under such conditions will result in fire, electric shocks or components deterioration.

Components deterioration (such as ceiling mount brackets) may cause the projector which is mounted on the ceiling to fall down.

Do not install this projector in a place which is not strong enough to take the full weight of the projector or on top of a surface which is sloped or unstable.

Failure to observe this will cause projector to fall down or tip over the projector, and severe injury or damage could result.

Do not place another projector or other heavy objects on top of the projector.

Failure to observe this will cause the projector to become unbalanced and fall, which could result in damage or injury. The projector will be damaged or deformed.

WARNING:**Installation work (such as ceiling mount bracket) should only be carried out by a qualified technician.**

If installation is not carried out and secured correctly it can cause injury or accidents, such as electric shocks.

- Do not use anything other than an authorized ceiling mount bracket.
- Be sure to use the wire provided with the projector mount base for ceiling mount as an extra safety measure to prevent the projector from falling down. (Install in a different location to the ceiling mount bracket.)

Do not cover the air inlet port or the air outlet port.

Doing so will cause the projector to overheat, which can cause fire or damage to the projector.

- Do not place the projector in narrow, badly ventilated places.
- Do not place the projector on cloth or papers, as these materials could be drawn into the air inlet port.

Do not place your hands or other objects close to the air outlet port.

Doing so will cause burns or damage your hands or other objects.

- Heated air comes out of the air outlet port. Do not place your hands or face, or objects which cannot withstand heat close to this port.

Do not look and place your skin into the lights emitted from the lens while the projector is being used.

Doing so can cause burns or loss of sight.

- Strong light is emitted from the projector's lens. Do not look or place your hands directly into this light.
- Be especially careful not to let young children look into the lens. In addition, turn off the power and disconnect the power plug when you are away from the projector.

Do not insert any foreign objects into the projector.

Doing so will cause fire or electric shocks.

- Do not insert any metal objects or flammable objects into the projector or drop them onto the projector.

Never attempt to remodel or disassemble the projector.

High voltages can cause fire or electric shocks.

- For any inspection, adjustment and repair work, please contact an Authorized Service Center.

Do not project an image with the lens cover attached.

Doing so can cause fire.

Do not allow metal objects, flammable objects, or liquids to enter inside of the projector. Do not allow the projector to get wet.

Doing so may cause short circuits or overheating, and result in fire, electric shock, or malfunction of the projector.

- Do not place containers of liquid or metal objects near the projector.
- If liquid enters inside of the projector, consult your dealer.
- Particular attention must be paid to children.

Use the ceiling mount bracket specified by Panasonic.

Defects in the ceiling mount bracket will result in falling accidents.

- Attach the supplied safety cable to the ceiling mount bracket to prevent the projector from falling down.

Read this first!

WARNING:

■ ACCESSORIES

Do not use or handle the batteries improperly, and refer to the following.

Failure to observe this will cause burns, batteries to leak, overheat, explode or catch fire.

- Use AAA/R03 or AAA/LR03 batteries.
- Do not use unspecified batteries.
- Do not disassemble dry cell batteries.
- Do not heat the batteries or place them into water or fire.
- Do not allow the + and – terminals of the batteries to come into contact with metallic objects such as necklaces or hairpins.
- Do not store batteries together with metallic objects.
- Store the batteries in a plastic bag and keep them away from metallic objects.
- Make sure the polarities (+ and –) are correct when inserting the batteries.
- Do not use a new battery together with an old battery or mix different types of batteries.
- Do not use batteries with the outer cover peeling away or removed.
- Remove the empty batteries from the remote control at once.
- Insulate the battery using tape or something similar before disposal.

Do not allow children to reach the batteries (AAA/R03 or AAA/LR03 type) and the lens antitheft screw.

- The battery and the lens antitheft screw can cause personal injury if swallowed.
- If swallowed, seek medical advice immediately.

If the battery fluid leaks, do not touch it with bare hands, and take the following measures if necessary.

- Battery fluid on your skin or clothing could result in skin inflammation or injury.
Rinse with clean water and seek medical advice immediately.
- Battery fluid coming in contact with your eyes could result in loss of sight.
In this case, do not rub your eyes. Rinse with clean water and seek medical advice immediately.

Do not disassemble the lamp unit.

If the lamp breaks, it could cause injury.

Lamp replacement

The lamp has high internal pressure. If improperly handled, an explosion and severe injury or accidents will result.

- The lamp can easily explode if struck against hard objects or dropped.
- Before replacing the lamp, be sure to disconnect the power plug from the wall outlet.
Electric shocks or explosions can result if this is not done.
- When replacing the lamp, turn the power off and allow the lamp to cool for at least 1 hour before handling it otherwise it can cause burns.

Do not allow infants or pets to touch the remote control unit.

- Keep the remote control unit out of the reach of infants and pets after using it.

Do not use the supplied power cord with devices other than this projector.

- Using the supplied power cord with devices other than this projector may cause short circuits or overheating, and result in electric shock or fire.

Remove the depleted batteries from the remote control promptly.

- Leaving them in the unit may result in fluid leakage, overheating, or explosion of the batteries.

CAUTION:

■ POWER

When disconnecting the power cord, be sure to hold the power plug and power connector.
If the power cord itself is pulled, the lead will become damaged, and fire, short-circuits or serious electric shocks will result.

When not using the projector for an extended period of time, disconnect the power plug from the wall outlet and remove the batteries from the remote control.

Disconnect the power plug from the wall outlet before carrying out any cleaning and replacing the unit.
Electric shocks can result if this is not done.

■ ON USE/INSTALLATION

Do not put your weight on this projector.
You could fall or the projector could break, and injury will result.

- Be especially careful not to let young children stand or sit on the projector.

Do not place the projector in extremely hot locations.
Doing so will cause the outer casing or internal components to deteriorate, or result in fire.

- Take particular care in locations exposed to direct sunlight or near stoves.

Always disconnect all cables before moving the projector.
Moving the projector with cables still attached can damage the cables, which will cause fire or electric shocks to occur.

Never plug headphones and earphones into AUDIO OUT jack.
Excessive sound pressure from earphones and headphones can cause hearing loss.

■ ACCESSORIES

Do not use the old lamp unit.
If used it could cause lamp explosion.

If the lamp has broken, ventilate the room immediately. Do not touch or bring your face close to the broken pieces.
Failure to observe this will cause the user to absorb the gas which was released when the lamp broke and which contains nearly the same amount of mercury as fluorescent lamps, and the broken pieces will cause injury.

- If you believe that you have absorbed the gas or that the gas has got into your eyes or mouth, seek medical advice immediately.
- Ask your dealer about replacing the lamp unit and check the inside of the projector.

Do not attach wet air filter.
Doing so may result in electric shocks or malfunctions.

- After washing the air filter, dry it thoroughly before attaching to the projector.



To remove the battery

Remote Control Battery

1. Press the guide and lift the cover.

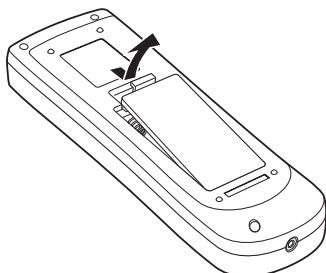

2. Remove the batteries.

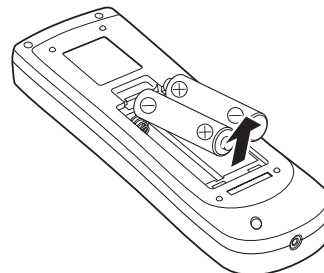

Read this first!

Trademarks

- HDMI, the HDMI logo and High-Definition Multimedia Interface is a trademark or registered trademark of HDMI Licensing LLC. The HDMI logo consists of the letters "HDMI" in a bold, sans-serif font. Below the letters, the words "HIGH-DEFINITION MULTIMEDIA INTERFACE" are written in a smaller, all-caps, sans-serif font.
- PJLink™ is a trademark or pending trademark in Japan, the United States, and other countries and region.
- RoomView and Crestron RoomView are registered trademarks of Crestron Electronics, Inc. Crestron Connected and Fusion RV are the trademarks of Crestron Electronics, Inc.
- Other names, company names or product names used in these operating instructions are the trademarks or registered trademarks of their respective holders.

Please note that the operating instructions do not include the ® and ™ symbols.

Illustrations in these operating instructions

- Note that illustrations of the projector and screens may differ from the ones you actually see.

Page references

- In these instructions, references to pages are indicated as: (➡ page 00).

Term

- In these instructions, the “Wireless/Wired remote control unit” accessory is referred to as the “Remote control”.

■ Features of the Projector

Direct Power Off Function

- ▶ With the Direct Power Off function, you can disconnect the power cord from the wall outlet or turn off the breaker even during projection.

Improved connectivity

- ▶ The inclusion of an HDMI terminal provides support for high quality video and HDMI audio.

Useful Functions for Presentations

- ▶ The digital zoom function allows you to focus on the crucial information during a presentation.

Shutter Function*

- ▶ The projector is equipped with the shutter that provides complete blackness when the projected image is not needed with keeping the projector on. The shutter management function allows you to set the timer. It prevents from keeping the projector on when the shutter is closed for a long time.

*This function is only for EZ570 series, EW630 series and EX600 series.

■ Quick steps

For details, see the corresponding pages.

1. **Set up your projector.**
(⇒ page 24)



2. **Connect with other devices.**
(⇒ page 34)



3. **Connect the power cord.**
(⇒ page 35)



4. **Power on.**
(⇒ page 37)



5. **Select the input signal.**
(⇒ page 40)



6. **Adjust the image.**
(⇒ page 40)

Contents

Be sure to read "Read this first!". (→ pages 2 to 8)

Important Information

Read this first!	2
Contents	10
Precautions for Use	12
Cautions when transporting.....	12
Cautions when handling the projector	12
Cautions when installing.....	12
Security	14
Disposal.....	14
Cautions on use	14
Accessories	16
Optional accessories	17

Preparation

About Your Projector	18
Remote control	18
Projector body	20
Side control and Indicators.....	21
Rear terminals	22
Using Remote control	23
Installing and Removing batteries	23
Setting Remote control ID numbers	23

Getting Started

Setting up	24
Projection method	24
Parts for ceiling mount (Optional).....	24
Removing and attaching the projection lens	25
Screen size and throw distance	26
Adjusting front adjustable feet.....	33
Connections	34
Before connecting to the projector	34
Connecting example.....	34

Basic Operation

Powering ON/OFF	35
Connecting the power cord	35
ON(G)/STANDBY(R) indicator.....	36
Turning On the Projector	37
Enter a PIN code	38
Turning Off the Projector	39
Projecting	40
Selecting the image.....	40
Adjusting the image.....	40

Basic operations by using the remote control..... 41

Using the SHUTTER/ AV MUTE button	41
Switching the input signal.....	41
Using the MENU button.....	42
Using the AUTO PC ADJ button	42
Controlling the volume of the speaker.....	42
Using the IMAGE SELECT button	42
Using the MUTE button	42
Using the IMAGE ADJUST button	42
Using the P-TIMER button	43
Using the ECO button	43
Using the SCREEN button	43
Using the FREEZE function	43
Using the D.ZOOM button.....	43
Using the LENS SHIFT button	43
Using the KEYSTONE button.....	44
Using the ZOOM +/- buttons	45
Using the FOCUS +/- buttons.....	45
Using the INFO button.....	45
Using the P IN P button	45

Settings

Menu Navigation	46
Navigating through the menu	46
Main menu.....	47
Sub menu	47
Input menu	49
Input 1	49
Input 2	49
Input 3	49
AUTO PC adjust	51
Auto PC adj.	51
Manual PC adjust	52
Fine sync	52
Total dots	52
Position H	52
Position V	52
Current mode	53
Clamp	53
Display area H.....	53
Display area V	53
Reset	53
Mode free	53
Store	53
Image select	54
Dynamic	54
Standard.....	54
Real	54
Cinema.....	54
Natural.....	54

Image 1-10	54
Image adjust.....	55
Contrast.....	55
Brightness	55
Color.....	55
Tint	55
Iris	55
Color temp.....	56
Red	56
Green	56
Blue	56
Offset.....	56
Daylight View.....	56
Sharpness	57
Gamma.....	57
Noise reduction	57
Progressive	57
Reset.....	57
Store.....	57
Screen	58
Normal.....	58
Full	58
Wide(16:9).....	58
Zoom	58
True	58
Natural wide	58
Custom.....	58
Custom adj.	59
Digital zoom +.....	59
Digital zoom -	59
Keystone	59
Ceiling	60
Rear.....	60
Screen aspect	60
Reset.....	60
Sound	61
Volume	61
Built-in SP.....	61
Mute	61
Setting	62
Language	62
Menu/Menu position	62
Input button	62
Display.....	63
Background	63
Logo	63
Picture in Picture	64
HDMI setup	65
DVI signal level.....	65
Lamp power.....	65
Fan control	65
Simple mode	66
Remote control	66
RC sensor	66

Eco management	66
Power management	67
Standby mode	67
Direct on	67
P-timer	67
Security	68
Shutter.....	68
Closed caption.....	69
Video delay control	69
Filter counter	70
Test pattern.....	70
Factory default.....	70

Information.....	71
Input Source Information Display	71
Network	72
Projector name	72
Network setup	72
Network control	72
Network status.....	73
Network factory default.....	73
Network connections	74
Accessing from the Web browser.....	75

Maintenance

About indicator status	89
If an indicator turns on.....	89
Maintenance/replacement.....	93
Before cleaning/replacing the unit.....	93
Maintenance.....	93
Replacing the unit.....	95
Troubleshooting	98

Appendix

Technical Information	100
PJLink protocol.....	100
Control commands via LAN.....	101
Serial terminal	103
Other terminals.....	106
List of Picture in Picture.....	108
List of compatible signals	109
Specifications	114
Dimensions.....	116
Ceiling mount bracket safeguards.....	116
Index	117

Precautions for Use

Cautions when transporting

- When transporting the projector, hold it securely by its bottom and avoid excessive vibration and impacts. Doing so may damage the internal parts and result in malfunctions. You can also use the handle grip in the back of the projector when transporting.
- Do not transport the projector with the adjustable feet extended. Doing so may damage the adjustable feet.
- If you have purchased a projector with a standard projection lens, please remove the lens cap on the lens before use, and keep it for later use. For transportation, press and hold the <LENS> button or <LENS SHIFT> button for more than 5 seconds to make the lens return to the central position, and then attach the lens cap to protect the lens. If you have purchased a projector without projection lens, please make the lens return to the central position, and then attach the lens cover.
- Use the handle grip when moving the projector.

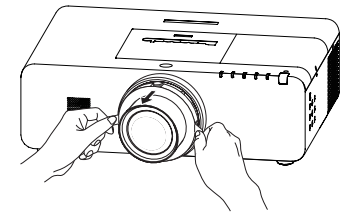
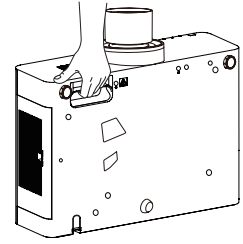

Cautions when handling the projector

- Do not hold the lens or the lens compartment tube when lifting or moving the projector. Doing so may cause damage to the lens and the projector.
- Care must be taken when handling the projector; do not drop, bump, subject it to strong forces, or put other things on the cabinet.
- Do not hold the lens and the peripheral part.

Cautions when installing

■ Do not set up the projector outdoors.

- The projector is designed for indoor use only.

■ Do not use under the following conditions.

- Places where vibration and impacts occur such as in a car or vehicle: Doing so may damage the internal parts and result in malfunctions.
- Near the exhaust of an air conditioner or near lights (studio lamps, etc.) where temperature changes greatly (Operating environment ►page 115): Doing so may shorten the life of the lamp or result in deformation of the outer case and malfunctions.
- Near high-voltage power lines or near motors: Doing so may interfere with the operation of the projector.

■ Be sure to ask authorized personnel or your supplier when mounting the product to a ceiling.

This requires an optional ceiling mount bracket.

Model No.: ET-PKE200H (for high ceilings), ET-PKE200S (for low ceilings),
ET-PKE200B (Projector Mount Base).

■ Do not install the projector at elevations of 2 700 m (8 858 ft) or higher above sea level.

Failure to do so may shorten the life of the internal parts and result in malfunctions.

Cautions when setting the projectors

- When installing and using the projector with a method other than the floor standing installation using the adjustable feet, fix the projector using the five screw holes for ceiling mounting (shown in the figure). (Screw diameter: M6, tapping depth inside the set: 12mm, torque: $4 \pm 0.5 \text{ N}\cdot\text{m}$)

Screw holes for ceiling mount (M6)

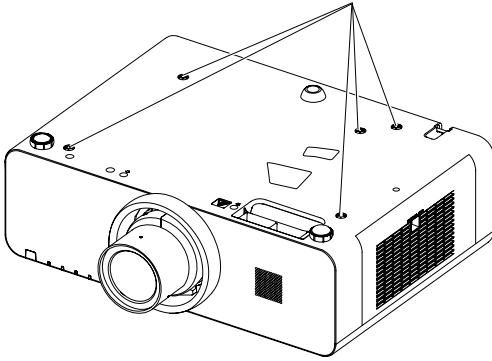

- Do not stack the projectors.
- Do not block the ventilation ports (intake and exhaust) of the projector.
- Avoid heating and cooling air from the air conditioning system directly blow to the ventilation ports (intake and exhaust) of the projector.

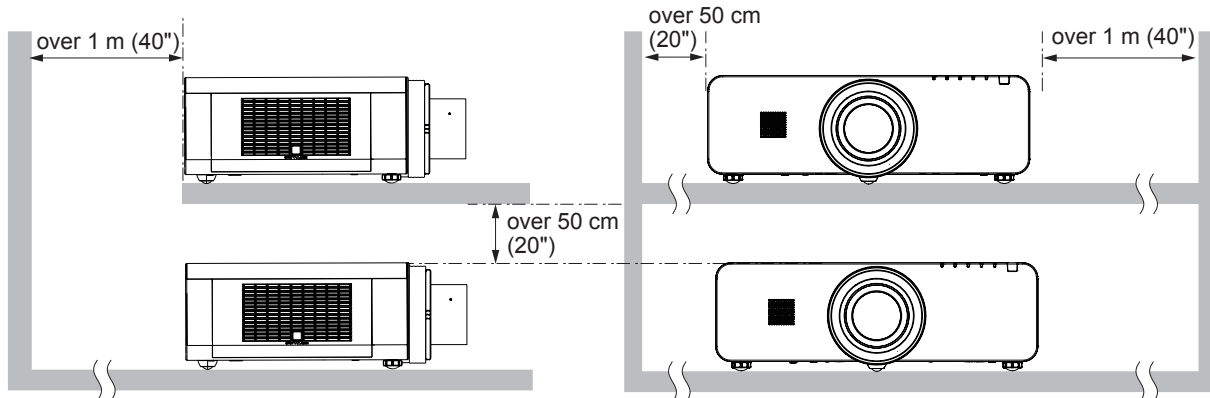
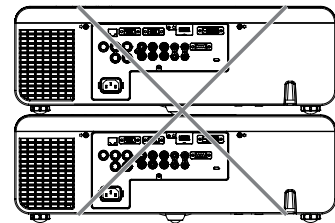

- Do not place the projector in a confined space. When it is necessary to install in a confined space, install the air conditioning or ventilating installation separately. Exhaust heat may accumulate when the ventilation is not enough, triggering the protection circuit of the projector.
- Do not use the projector tilted at an angle that exceeds ± 10 degrees vertically.

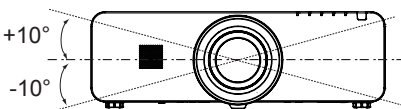

- In upward and downward projection, do not tilt the projector over 10 degrees right and left.

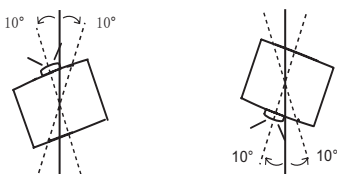

Precautions for Use

Security

■ Take safety measures against following incidents.

- Personal information being leaked via this product.
- Unauthorized operation of this product by a malicious third party.
- Interfering or stopping of this product by a malicious third party.

■ Security instruction (➔pages 68, 86)

- Make your password as difficult to guess as possible.
- Change your password periodically.
- Panasonic or its affiliate company never inquires a password directly to a customer. Do not tell your password in case you receive such an inquiry.
- The connecting network must be secured by firewall or others.
- Set a password for web control and restrict the users who can log in.

Disposal

When disposing of the product, ask your local authority or dealer about the correct methods of disposal.

The lamp contains mercury. When disposing of the used lamp unit, ask your nearest local authorities or dealer about proper disposal of the unit.

Dispose of used batteries according to the instructions or your local disposal rule or guidelines.

Cautions on use

■ In order to get the picture quality

- Draw curtains or blinds over windows and turn off any lights near the screen to prevent outside light or light from indoor lamps from shining onto the screen.
- Depending on where the projector is used, heated air from an exhaust port or warm or cold air from an air conditioner can cause a shimmering effect on screen.
Avoid use in locations where exhaust or streams of air from projector, other devices and air conditioners flow between the projector and the screen.
- The lens of projector is affected by the heat from the luminous source. Because of this, the focusing may not be stable right after the power is turned on. Focusing is stabled after projecting image for 30 minutes and longer.

■ Do not touch the surface of the projector lens with your bare hand.

If the surface of the lens becomes dirty from fingerprints or anything else, this will be magnified and projected onto the screen.

■ LCD Panel

The display unit of this projector comprises three LCD panels. Although an LCD panel is a product of high-precision technology, some of the pixels on the projected image may be missing or constantly lit. Please note that this is not a malfunction.

Displaying a still image for a longer time may result in an after-image on the LCD panels. If this happens, display the all white screen in the test pattern for an hour or more.

■ Optical components

Operating the projector in an environment with high temperature or heavy exposure to dust or tobacco smoke will reduce the service life of the optical components, such as the LCD panel and polarizing plate, and may necessitate their replacement within less than one year of use. For details, consult your dealer.

■ Lamp

The luminous source of the projector is a mercury lamp with high internal pressure.

A high pressure mercury lamp has following characteristics.

- The brightness of the lamp will decrease by duration of usage.
- The lamp may burst with sound or shorten life by shock or chipping.
- The life of the lamp varies greatly depending on individual specificities and usage conditions. In particular, continuous use over 12 hours and frequent on/off switching of the power greatly deteriorate the lamp and affect the lamp life.
- In rare cases, the lamp burst shortly after the projection.
- The risk of bursting increases when the lamp is used beyond its replacement cycle. Make sure to replace the lamp unit consistently. ("When to replace the lamp unit" (➔ page 96))
- If the lamp bursts, gas contained inside of the lamp is released in a form of smoke.
- It is recommended to store replacement lamps for contingency.
- It is recommended to have authorized engineer or your dealer replace the lamp unit.

Pursuant to at the directive 2004/108/EC, article 9(2)

Panasonic Testing Centre





Panasonic Service Europe, a division of Panasonic Marketing Europe GmbH



Winsbergring 15, 22525 Hamburg, F.R. Germany



Precautions for Use

Accessories

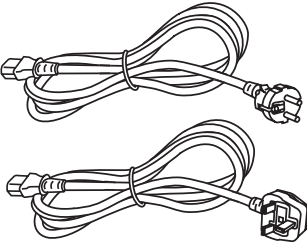
Make sure the following accessories are provided with your projector. Numbers in the brackets () show the number of accessories.

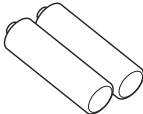
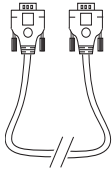
Wireless/Wired remote control unit (x1)			
<p>EX600 series</p>  <p>(6451055545)</p>	<p>EX500 series</p>  <p>(6451055552)</p>	<p>EZ570 series EW630 series</p>  <p>(6451055569)</p>	<p>EW530 series</p>  <p>(6451055576)</p>

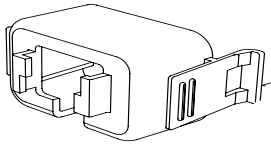
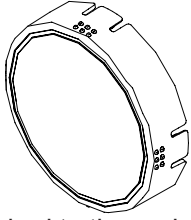
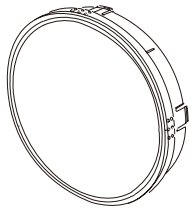
<p>Power cord (x2) (6103597768) (6103597775)</p> 	<p>CD-ROM (x1) (6103615899)</p> 	<p>Batteries (AAA/R03 or AAA/LR03 type) (x2)</p>  <p>(for remote control unit)</p>	<p>Computer cable (x1) (6103580425)</p> 
--	---	--	---

<p>AC power cord holder (x1) (6451052124)</p> 	<p>Lens cap*1 (x1) (6103543376)</p>  <p>(Attached to the projector at the time of purchase.)</p>	<p>Lens mount cover*2 (x1) (6103468303)</p>  <p>(Attached to the projector at the time of purchase.)</p>	<p>Lens antitheft screw*3 (x1) (4112195500)</p> 
---	---	--	---

*1 : Only for PT-EZ570E, PT-EW630E, PT-EW530E, PT-EX600E and PT-EX500E.

*2 : Only for PT-EZ570EL, PT-EW630EL, PT-EW530EL, PT-EX600EL and PT-EX500EL.

*3 : Be careful in the opening of projector when mounting the lens antitheft screw. It may cause such as electric shock, heavy exposure to dust, deviation adjustment. Please contact an Authorized Service Center for mounting, and do not attempt to mount the lens antitheft screw yourself. Dismounting the lens antitheft screw and replacing the lens, please follow above instructions.

Attention

- After unpacking the projector, discard the power cord cap and packaging material properly.
- For lost accessories, consult your dealer.
- The part numbers of accessories and separately sold components are subject to change without notice.
- Store small parts in an appropriate manner, and keep them away from young children.

Contents of CD-ROM

The following contents are stored on the supplied CD-ROM.

Instructions/List (PDF)	Software
<ul style="list-style-type: none"> ● Operating Instructions – Functional Manual ● Operation Manual Multi Projector Monitoring & Control Software 2.6 ● Operation Manual Logo Transfer Software 2.0 ● List of compatible projector models <ul style="list-style-type: none"> • This is a list of projectors that are compatible with the software (refer to the right column), and their restrictions. 	<ul style="list-style-type: none"> ● Multi Projector Monitoring & Control Software 2.6 (Windows) <ul style="list-style-type: none"> • This software allows you to monitor and control multiple projectors connected to the LAN. ● Logo Transfer Software 2.0 (Windows) <ul style="list-style-type: none"> • This software allows you to create original images, such as company logos to be displayed when projection starts, and transfer them to the projector.

Optional accessories

Options	Model No.
Ceiling Mount Bracket	ET-PKE200H (for high ceilings), ET-PKE200S (for low ceilings)
Projector Mount Base	ET-PKE200B
Replacement Lamp Unit	ET-LAE200
Replacement Filter Unit	ET-RFE200
Zoom lens	ET-ELW21 (Fixed-focus Lens), ET-ELW20 (Short Zoom Lens), ET-ELT20 (Long Zoom Lens), ET-ELT21 (Ultra Long Zoom Lens)

About Your Projector

Remote control

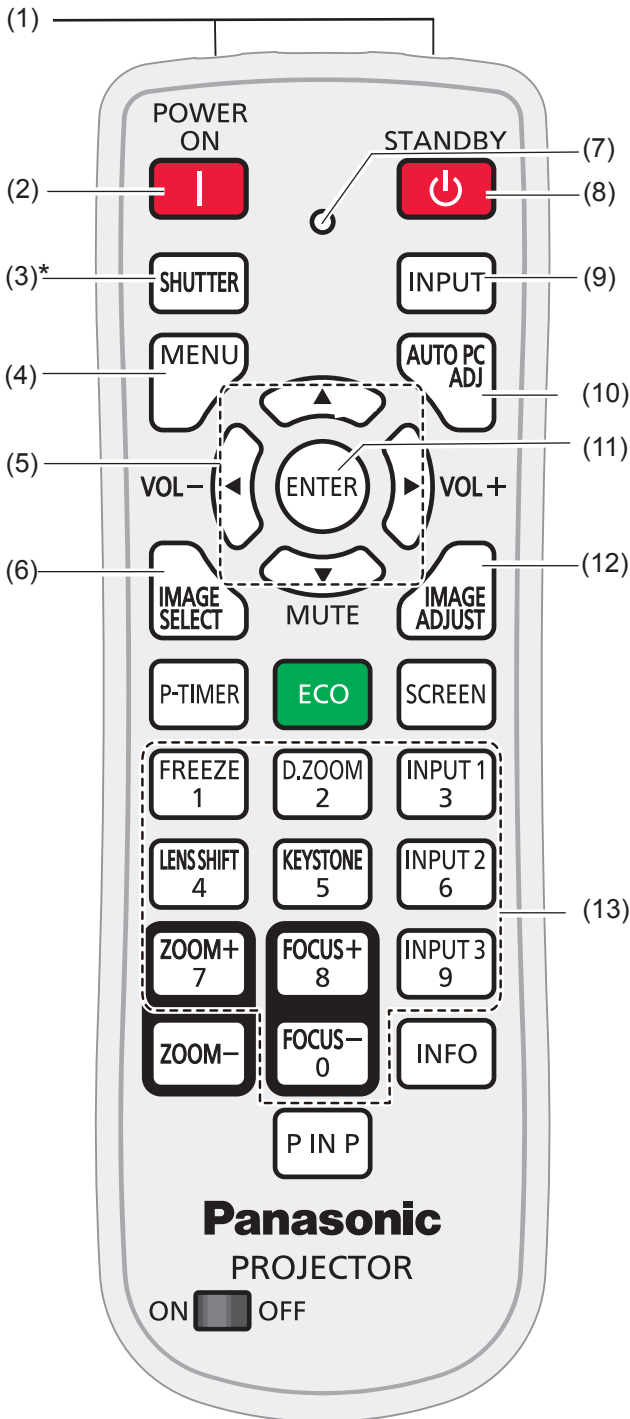

- (1) Remote control signal emitter**
- (2) <POWER ON> button**
Turn the projector on. (➔page 37)
- (3) <SHUTTER>/<AV MUTE> button**
* <SHUTTER> button (Only for EZ570 series, EW630 series and EX600 series.)
Close and open up the built-in shutter.
* <AV MUTE> button (Only for EW530 series and EX500 series.)
Temporarily turn off the image on the screen.
- (4) <MENU> button**
Open or close the On-Screen Menu. (➔page 46)
- (5) ▲ ▼ ◀ ▶ (MUTE, VOL-/+) buttons**
 - Navigate the menu display.
 - Pan the image in Digital zoom + mode.
 - Adjust the volume level (with ◀ ▶ buttons) or mute the sound (with ▼ button).
- (6) <IMAGE SELECT> button**
Operate the image selection function. (➔page 42)
- (7) Signal Emission indicator**
Light red while a signal is being sent from the remote control to the projector.
- (8) <STANDBY> button**
Turn the projector off. (➔page 39)
- (9) <INPUT> button**
Select an input source. (➔page 41)
- (10) <AUTO PC ADJ> button**
Automatically adjust the computer image to its optimum setting. (➔page 42)
- (11) <ENTER> button**
Execute the selected item.
- (12) <IMAGE ADJUST> button**
Operate the image adjustment function. (➔page 42)
- (13) Number buttons**
Act as number buttons. Use these buttons when setting the remote control codes (➔page 23) or entering the PIN code numbers (➔page 38).

Picture (1) Picture (2)

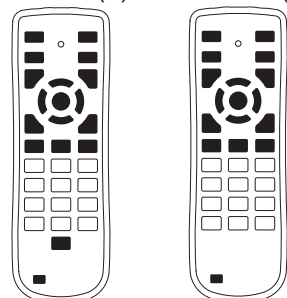

■ enable □ disable

Note

- Available keys in the simple mode as the left picture shown for different models.
Picture (1) is only for EZ570 series, EW630 series and EW530 series.
Picture (2) is only for EX600 series and EX500 series.

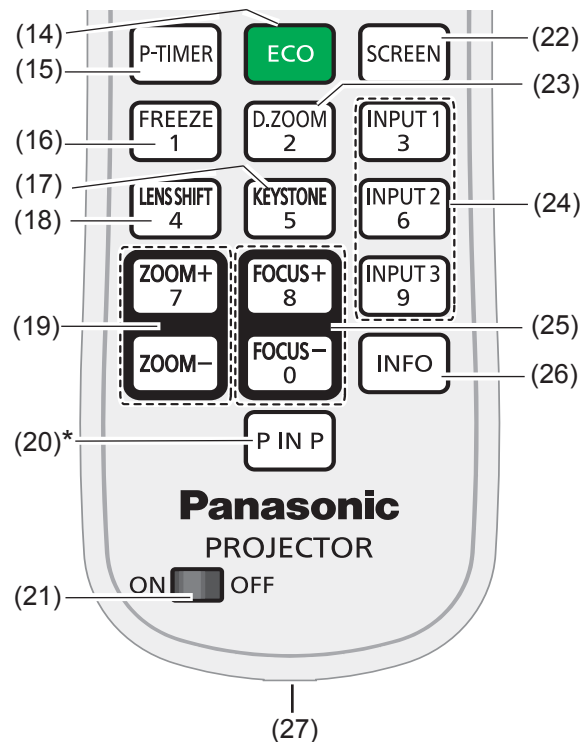

(14) <ECO> button

Display the Eco management function. (➡page 43)

(15) <P-TIMER> button

Operate the P-timer function. (➡page 43)

(16) <FREEZE > button

Pauses the projected image and sound tentatively. (➡page 43)

(17) <KEYSTONE> button

Correct keystone distortion. (➡page 44)

(18) <LENS SHIFT> button

Select the Lens Shift function. (➡page 43)

(19) <ZOOM +/-> button

Zoom in and out the images. (➡page 45)

(20) <P IN P> button

Operate the Picture in Picture function. (➡page 45)

*Only for EZ570 series, EW630 series and EW530 series.

(21) ON/OFF switch

When using the remote control, set this switch to "ON". Set it to "OFF" for power saving when it is not in use.

(22) <SCREEN> button

Select a screen mode. (➡page 43)

(23) <D.ZOOM> button

Select the Digital zoom +/- mode and resize the image. (➡page 43)

(24) Input Selection buttons: <INPUT 1>, <INPUT 2>, <INPUT 3>

Select an input source (Input 1 – Input 3).

(25) <FOCUS +/-> button

Adjust the focus. (➡page 45)

(26) <INFO> button

Operate the information function. (➡page 45)

(27) Wired remote jack

Connect the M3 stereo mini-jack cable (not supplied) to this jack when using as a wired remote control.

Attention

- Do not drop the remote control.
- Avoid contact with liquids.
- Do not attempt to modify or disassemble the remote control.

Note

- The remote control can be used within a distance of about 5 m (16.4 ft) if pointed directly at the remote control signal receiver. The remote control can control at angles of up to $\pm 30^\circ$ vertically and $\pm 30^\circ$ horizontally, but the effective control range may be reduced.
- If there are any obstacles between the remote control and the remote control signal receiver, the remote control may not operate correctly.
- You can operate the projector by reflecting the remote control signal on the screen. The operating range may differ due to the loss of light caused by the properties of the screen.
- When the remote control signal receiver is lit with a fluorescent light or other strong light source, the projector may become inoperative. Set the projector as far from the luminous source as possible.

About Your Projector

Projector body

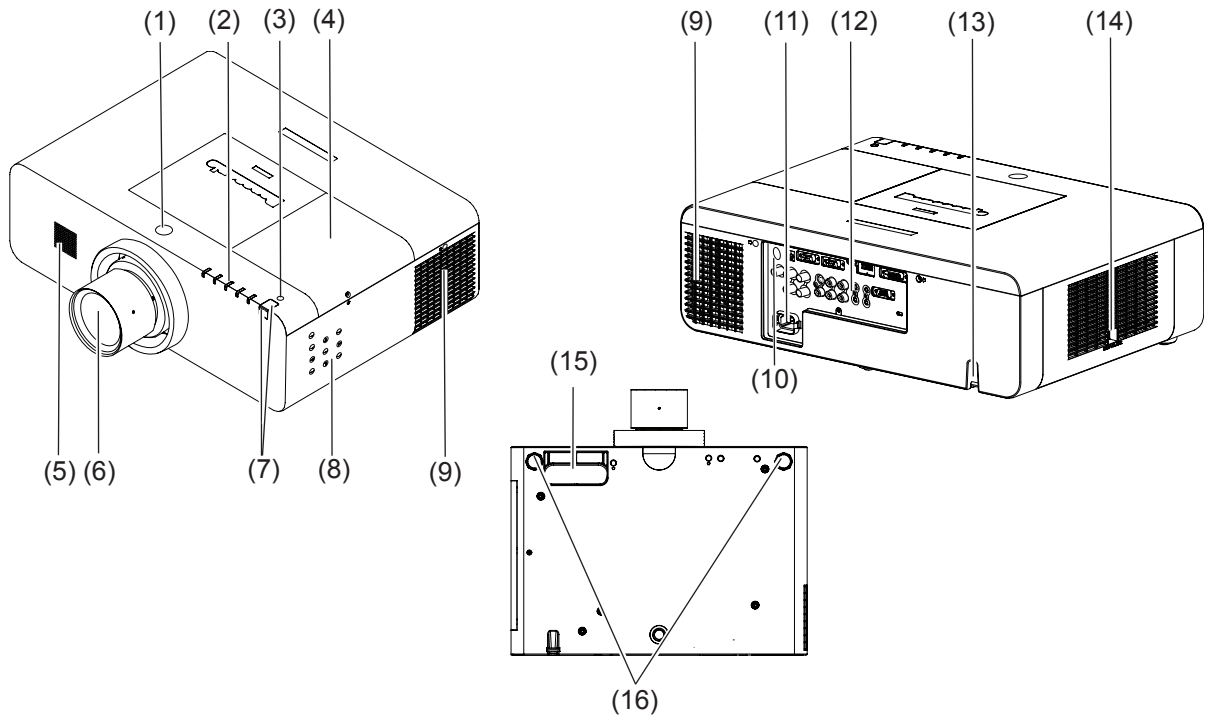

- (1) **Lens Release Button**
- (2) **Indicators** (➔page 21)
- (3) **Ambient Luminance sensor** (➔page 56)
- (4) **Lamp cover** (➔page 97)
The lamp unit is located inside.
- (5) **Speaker**
- (6) **Projection Lens**
(for PT-EZ570E, PT-EW630E, PT-EW530E, PT-EX600E and PT-EX500E)
- (7) **Remote control signal receiver (Front & Top)**
- (8) **Side Control** (➔page 21)
- (9) **Air outlet port**
 - Hot air is exhausted from the exhaust vent. Do not put heat-sensitive objects near this side.
- (10) **Remote control signal receiver (Back)**
- (11) **AC IN**
- (12) **Terminals** (➔page 22)
- (13) **Security Chain Hook**
- (14) **Air intake port / Air filter cover** (➔page 93)
- (15) **Hand Grip**
- (16) **Adjustable feet**
Adjusts the projection angle.

WARNING:

■ **Keep your hands and other objects away from the air exhaust port.**

- Keep your hand and face away.
- Do not insert your finger.
- Keep heat-sensitive articles away.

Heated air from the air exhaust port can cause burns or external damage.

Side control and Indicators

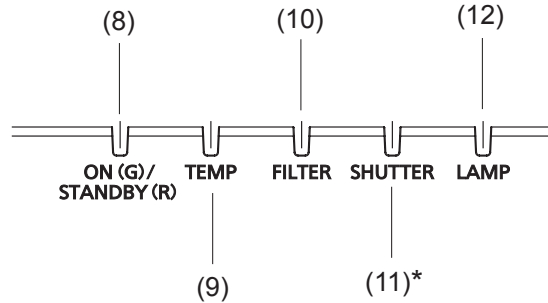
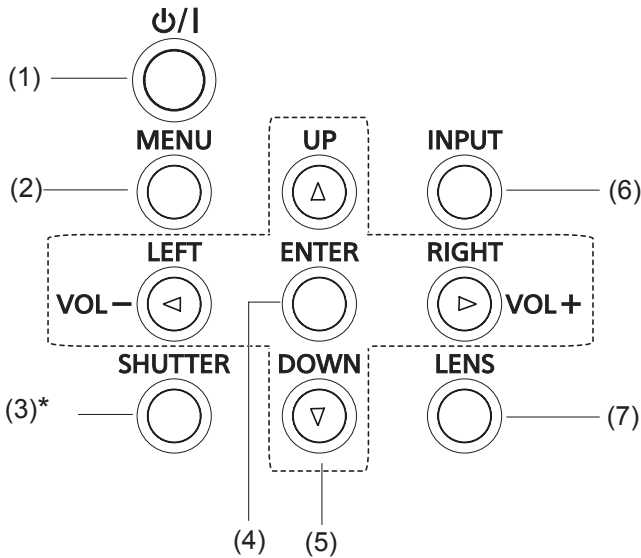

(1) <⏻/⏻> button

Turn the projector on or off.

(2) <MENU> button

Displays the menu screen. (➡page 46)

(3) <SHUTTER>/<AV MUTE> button

* <SHUTTER> button (Only for EZ570 series, EW630 series and EX600 series.)

Close and open up the built-in shutter.

* <AV MUTE> button (Only for EW530 series and EX500 series.)

Temporarily turn off the image on the screen.

(4) <ENTER> button

Execute the selected item.

(5) ▲▼◀▶ (VOL-/+) buttons

- Navigate the menu display.
- Pan the image in Digital zoom + mode.
- Adjust the volume level (with ◀▶ buttons).

(6) <INPUT> button

Select an input source.

(7) <LENS> button

Enter the focus, zoom, and lens shift adjustment mode. (➡page 40)

(8) <ON(G)/STANDBY(R)> indicator

- Light red while the projector is in stand-by mode.
- Light green during operations.
- Blink green in the Power management mode.

(9) <TEMP> indicator

Blink red when the internal temperature of the projector exceeds the operating range.

(10) <FILTER> indicator

Light orange when the clogging of the filter is detected or the filter counter reaches a time set in the timer setting, urging immediate filter replacement.

(11) <SHUTTER>/<AV MUTE> indicator

* <SHUTTER> indicator (Only for EZ570 series, EW630 series and EX600 series.)

Light blue when the shutter is closed.

* <AV MUTE> indicator (Only for EW530 series and EX500 series.)

Light blue when in AV MUTE mode.

(12) <LAMP> indicator

Light orange when the projection lamp reaches its end of life.

About Your Projector

Rear terminals

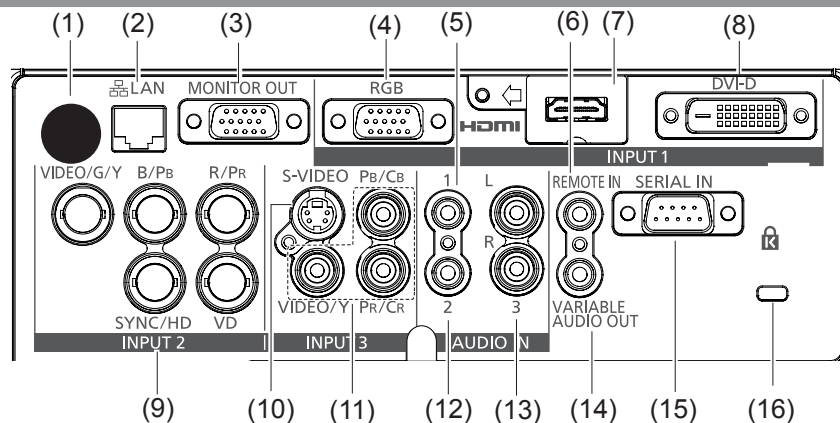

(1) Remote control signal receiver (Back)

The infrared remote receiver is also located in the front and top.

(2) LAN

Connect the LAN cable.

(3) MONITOR OUT

This terminal can be used to output the incoming analog RGB signal from INPUT 1-2 terminals to the other monitor.

(4) RGB

Connect the computer (or RGB scart) output signal to this terminal.

(5) AUDIO IN 1

Connect the audio output (stereo) signal from a computer or video equipment to INPUT 1 terminals.

(6) REMOTE IN

When using the wired remote control, connect the wired remote control to this jack with a remote control cable (not supplied).

(7) HDMI

Connect the HDMI signal (including sound signal) from video equipment or the DVI signal from computer to this terminal.

(8) DVI-D

Connect the computer output digital signal to this terminal. The HDTV (HDCP compatible) signal can also be connected.

(9) INPUT 2

Connect the component or composite video output signal from video equipment to VIDEO/G/Y, B/Pb and R/Pr jacks or connect the computer output signal (5 BNC Type [Green, Blue, Red, Horiz. Sync, and Vert. Sync.]) to VIDEO/G/Y, B/Pb, R/Pr, SYNC/HD, and VD jacks.

(10) S-VIDEO

Connect the S-VIDEO output signal from video equipment to this jack.

(11) VIDEO

Connect the component or the composite video output signal from video equipment to these jacks.

(12) AUDIO IN 2

Connect the audio output (stereo) signal from 5 BNC INPUT jacks (INPUT 2 jacks).

(13) AUDIO IN 3 (L/R)

Connect the audio output (stereo) signal from video equipment connected to INPUT 3 jacks. For a monaural audio signal (a single audio jack), connect it to the L jack.

(14) VARIABLE AUDIO OUT

This jack outputs the audio signal to external audio equipment.

(15) SERIAL IN

When controlling the projector with RS-232C, connect the control equipment to this connector with the serial control cable.

(16) Security slot

This slot is for a Kensington lock used to deter theft of the projector.

*Kensington is a registered trademark of ACCO Brands Corporation.

Attention

- When a LAN cable is directly connected to the projector, the network connection must be made indoors.

Using Remote control

Installing and Removing batteries

1) Open the cover

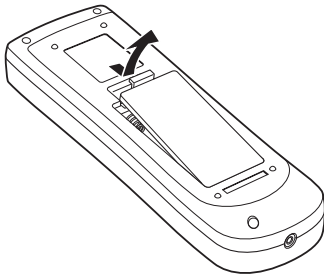

2) Install batteries and close the cover (Insert the – side first.)

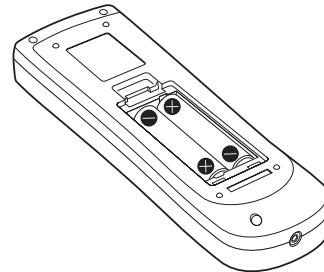

- Remove the batteries in the reverse order of installation.

Setting Remote control ID numbers

When you use the system with multiple projectors, you can operate all the projectors simultaneously or each projector individually using single remote control, if unique ID number is assigned to each projector. After setting the ID number of the projector, set the same ID number to the remote control. There are 65 different ID codes (All, Code 1~Code 64), the initial ID number is [All].

■ Setting the ID number

- 1) While holding down the <MENU> button, enter a 1-digit or 2-digit number corresponding to the desired ID code number by using the number buttons 0 to 9.
- 2) The ID code is changed when the <MENU> button is released.
- 3) The examples are as follows:
Code 1= <MENU>+<1> or <MENU>+ <0> + <1> ,
Code 2= <MENU>+<2> or <MENU>+ <0> + <2> ,
Code 16= <MENU>+ <1> + <6> ,
Code 64= <MENU>+ <6> + <4>

■ Resetting the ID number

The ID code is reset to [All] (default) by pressing the <MENU> button and <0> button at the same time for 5 seconds or more.

Attention

- The remote control transmission is disabled during the ID code change procedure.

Note

- For details, please refer to the [Remote control] of the [Setting] menu. (➡page 66)

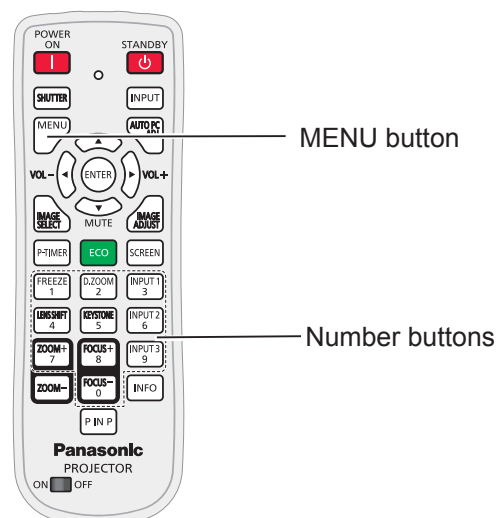

Setting up

Projection method

You can use the projector with any of the following 4 projection methods. To set the desired method in the projector.

■ Setting on a desk/floor and projecting forward

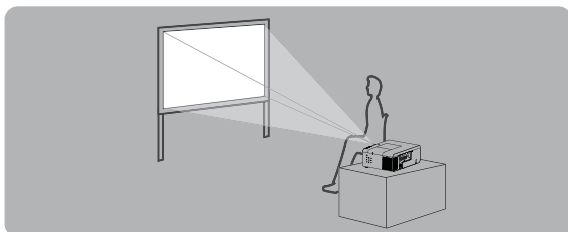

Menu setting*1

Ceiling	Off
Rear	Off

■ Mounting on the ceiling and projecting forward

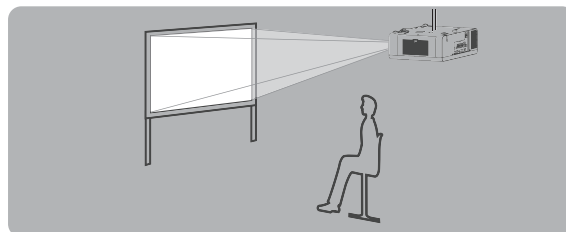

Menu setting*1

Ceiling	On
Rear	Off

■ Mounting on the ceiling and projecting from rear

(Using translucent screen)

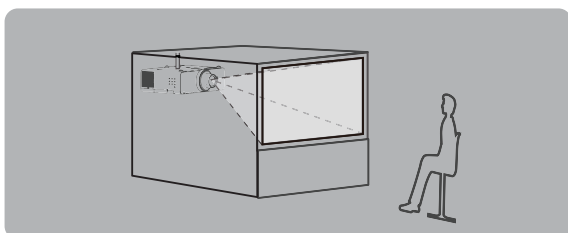

Menu setting*1

Ceiling	On
Rear	On

■ Setting on a desk/floor and projecting from rear

(Using translucent screen)

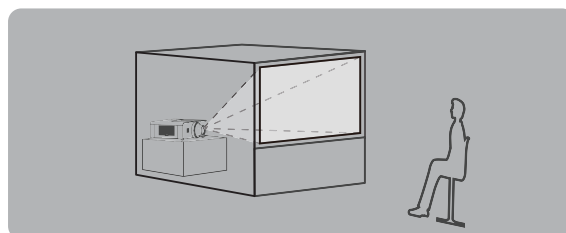

Menu setting*1

Ceiling	Off
Rear	On

*1 : For details about the menu setting, please refer to the [Screen] menu →[Ceiling] and [Rear]. (➡ page 60)

Attention

- For optimum viewing quality, install the projector in a location where screen exposure to outside light, light from light fixtures or other light is at a minimum. Also draw the curtains, close blinds and turn off light fixtures.

Parts for ceiling mount (Optional)

You can install the projector on the ceiling by using the optional ceiling mount bracket (ET-PKE200H: for high ceiling, ET-PKE200S: for low ceiling), and the optional projector mount base ET-PKE200B.

- Use only the ceiling mount brackets specified for this projector.
- Refer to the installation manual for the ceiling mount bracket when you install the bracket and the projector.

Attention

- To ensure projector performance and security, installation of the ceiling mount bracket must be carried by your dealer or a qualified technician.

Removing and attaching the projection lens

When replacing the lens or using an optional lens, install the lens by following the instructions below. Ask the sales dealer for detailed information of the optional lens specifications.

Removing the lens

1. Press and hold the <LENS> button or <LENS SHIFT> button for more than 5 seconds to make the lens return to the central position.
2. Turn off the projector and unplug the AC power cord.
3. While pressing the lens release button, rotate the projection lens counterclockwise, and remove the projection lens.

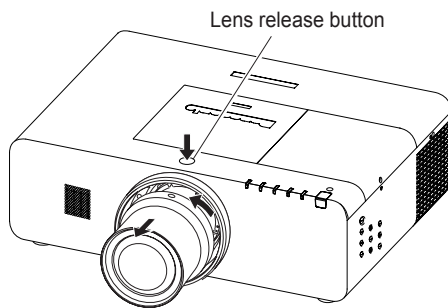

Attention

- Be careful when handling the lens. Do not drop.

Attaching the lens to the projector

1. Remove the lens mount cover.
2. Fit the lens to the projector by aligning the red dot on the lens with the red dot of the projector.
3. Slowly turn the lens clockwise until it clicks. Make sure that the lens is fully inserted to the projector.

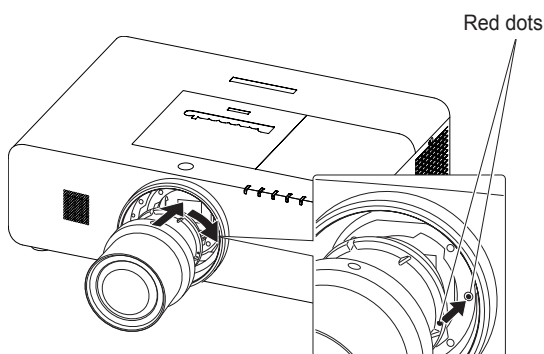

Attention

- Do not press the lens release button when attaching the lens.

Setting up

Screen size and throw distance

Place the projector referring to the diagram on the right and the figures of throwing distance. You can adjust the display size

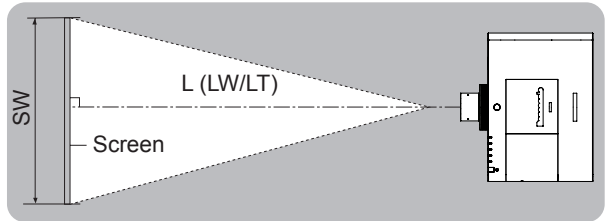
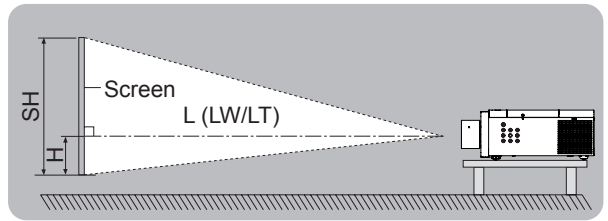
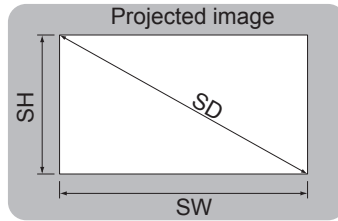

L (LW/LT) *1	Projection distance (m)
SH	Height of the projection area (m)
SW	Width of the projection area (m)
H	Distance from the center of lens to the image lower end (m)
SD	Diagonal length of the projection area (m)

*1 : LW : Minimum distance
LT : Maximum distance

Attention

- Before installing, please read "Precautions for Use" (➡ pages 12 to 17).

■ Projection distance by projection lens (for EZ570 series)

- For the screen aspect ratio of 16:10 (Unit: m)

Lens type			The standard zoom lens		The lens of optional accessories								Height position (H) ^{*2}
					Fixed-focus Lens	Short Zoom Lens	Long Zoom Lens	Ultra Long Zoom Lens					
Model number of projection lens			---		ET-ELW21	ET-ELW20	ET-ELT20	ET-ELT21					
Throw ratio ^{*1}			1.7 ~ 2.8:1		0.8:1	1.3 ~ 1.7:1	2.8 ~ 4.6:1	4.6 ~ 7.2:1					
Screen dimensions			Projection distance (L)										
Screen size	Height (SH)	Width (SW)	Min. (LW)	Max. (LT)	Fixed	Min. (LW)	Max. (LT)	Min. (LW)	Max. (LT)	Min. (LW)	Max. (LT)		
40"	0.538	0.862	1.36	2.35	0.63	1.02	1.41	2.29	3.81	3.72	6.03	-0.05~0.59	
50"	0.673	1.077	1.71	2.95	0.80	1.29	1.77	2.89	4.79	4.70	7.59	-0.06~0.73	
60"	0.808	1.292	2.06	3.55	0.97	1.55	2.14	3.49	5.77	5.68	9.15	-0.07~0.88	
70"	0.942	1.508	2.42	4.15	1.14	1.82	2.50	4.09	6.75	6.66	10.71	-0.08~1.02	
80"	1.077	1.723	2.77	4.76	1.32	2.09	2.87	4.69	7.73	7.64	12.27	-0.09~1.17	
90"	1.212	1.939	3.12	5.36	1.49	2.36	3.23	5.30	8.71	8.63	13.83	-0.11~1.32	
100"	1.346	2.154	3.48	5.96	1.66	2.63	3.60	5.90	9.69	9.61	15.39	-0.12~1.46	
120"	1.615	2.585	4.18	7.16	2.00	3.16	4.33	7.10	11.65	11.57	18.51	-0.14~1.76	
150"	2.019	3.231	5.24	8.96	2.52	3.97	5.42	8.90	14.59	14.52	23.19	-0.18~2.20	
200"	2.692	4.308	7.01	11.96	3.38	5.31	7.25	11.91	19.49	19.43	30.99	-0.24~2.93	
250"	3.365	5.385	8.77	14.96	4.24	6.65	9.07	14.91	24.39	24.34	38.79	-0.29~3.66	
300"	4.039	6.462	10.54	17.97	5.10	7.99	10.90	17.92	29.29	29.25	46.59	-0.35~4.39	
350"	4.712	7.539	12.30	20.97	5.95	9.33	12.73	20.92	34.19	34.16	54.39	-0.41~5.12	
400"	5.385	8.616	14.07	23.97	6.81	10.67	14.55	23.93	39.09	39.07	62.19	-0.47~5.85	

*1 : The throw ratio is based on the value during projection onto a 80" screen size.

*2 : When the fixed-focus lens (ET-ELW21) is attached, the lens shift cannot be used, so the height position (H) will be SH/2.

● For the screen aspect ratio of 16:9 (Unit: m)

Lens type			The standard zoom lens		The lens of optional accessories								Height position (H)* ²
					Fixed-focus Lens	Short Zoom Lens	Long Zoom Lens	Ultra Long Zoom Lens					
Model number of projection lens			---		ET-ELW21	ET-ELW20	ET-ELT20	ET-ELT21					
Throw ratio* ¹			1.7 ~ 2.8:1		0.8:1	1.3 ~ 1.7:1	2.8 ~ 4.6:1	4.6 ~ 7.2:1					
Screen dimensions			Projection distance (L)										
Screen size	Height (SH)	Width (SW)	Min. (LW)	Max. (LT)	Fixed	Min. (LW)	Max. (LT)	Min. (LW)	Max. (LT)	Min. (LW)	Max. (LT)		
40"	0.498	0.886	1.40	2.42	0.65	1.05	1.45	2.36	3.92	3.83	6.20	-0.08~0.57	
50"	0.623	1.107	1.76	3.04	0.83	1.32	1.82	2.97	4.92	4.83	7.81	-0.09~0.72	
60"	0.747	1.328	2.12	3.65	1.00	1.60	2.20	3.59	5.93	5.84	9.41	-0.11~0.86	
70"	0.872	1.550	2.49	4.27	1.18	1.87	2.57	4.21	6.94	6.85	11.01	-0.13~1.00	
80"	0.996	1.771	2.85	4.89	1.35	2.15	2.95	4.83	7.95	7.86	12.62	-0.15~1.15	
90"	1.121	1.992	3.21	5.51	1.53	2.43	3.32	5.45	8.95	8.87	14.22	-0.17~1.29	
100"	1.245	2.214	3.57	6.12	1.71	2.70	3.70	6.06	9.96	9.88	15.82	-0.19~1.44	
120"	1.494	2.657	4.30	7.36	2.06	3.25	4.45	7.30	11.97	11.90	19.03	-0.23~1.72	
150"	1.868	3.321	5.39	9.21	2.59	4.08	5.58	9.15	15.00	14.93	23.84	-0.28~2.15	
200"	2.491	4.428	7.20	12.29	3.47	5.46	7.45	12.24	20.03	19.98	31.86	-0.38~2.87	
250"	3.113	5.535	9.02	15.38	4.36	6.83	9.33	15.33	25.07	25.02	39.87	-0.47~3.59	
300"	3.736	6.641	10.83	18.47	5.24	8.21	11.20	18.42	30.10	30.07	47.89	-0.57~4.31	
350"	4.358	7.748	12.65	21.55	6.12	9.59	13.08	21.51	35.14	35.12	55.91	-0.66~5.02	
400"	4.981	8.855	14.46	24.64	7.00	10.97	14.96	24.60	40.18	40.17	63.92	-0.76~5.74	

● For the screen aspect ratio of 4:3 (Unit: m)

Lens type			The standard zoom lens		The lens of optional accessories								Height position (H)* ²
					Fixed-focus Lens	Short Zoom Lens	Long Zoom Lens	Ultra Long Zoom Lens					
Model number of projection lens			---		ET-ELW21	ET-ELW20	ET-ELT20	ET-ELT21					
Throw ratio* ¹			1.9 ~ 3.3:1		0.9:1	1.5 ~ 2.0:1	3.3 ~ 5.4:1	5.4 ~ 8.6:1					
Screen dimensions			Projection distance (L)										
Screen size	Height (SH)	Width (SW)	Min. (LW)	Max. (LT)	Fixed	Min. (LW)	Max. (LT)	Min. (LW)	Max. (LT)	Min. (LW)	Max. (LT)		
40"	0.610	0.813	1.54	2.67	0.72	1.16	1.60	2.61	4.33	4.24	6.85	-0.05~0.66	
50"	0.762	1.016	1.94	3.35	0.91	1.46	2.01	3.29	5.43	5.35	8.62	-0.07~0.83	
60"	0.914	1.219	2.34	4.03	1.11	1.77	2.43	3.97	6.54	6.46	10.39	-0.08~0.99	
70"	1.067	1.422	2.74	4.71	1.30	2.07	2.84	4.65	7.65	7.57	12.15	-0.09~1.16	
80"	1.219	1.626	3.14	5.39	1.50	2.37	3.25	5.33	8.76	8.68	13.92	-0.11~1.33	
90"	1.372	1.829	3.54	6.07	1.69	2.68	3.67	6.01	9.87	9.79	15.68	-0.12~1.49	
100"	1.524	2.032	3.94	6.75	1.89	2.98	4.08	6.69	10.98	10.91	17.45	-0.13~1.66	
120"	1.829	2.438	4.74	8.11	2.28	3.59	4.91	8.05	13.20	13.13	20.98	-0.16~1.99	
150"	2.286	3.048	5.94	10.15	2.86	4.50	6.15	10.09	16.53	16.47	26.28	-0.20~2.49	
200"	3.048	4.064	7.94	13.55	3.83	6.02	8.21	13.49	22.08	22.03	35.11	-0.27~3.31	
250"	3.810	5.080	9.94	16.95	4.80	7.53	10.28	16.90	27.62	27.58	43.94	-0.33~4.14	
300"	4.572	6.096	11.94	20.34	5.78	9.05	12.35	20.30	33.17	33.14	52.77	-0.40~4.97	
350"	5.334	7.112	13.93	23.74	6.75	10.57	14.41	23.70	38.72	38.70	61.60	-0.47~5.80	
400"	6.096	8.128	15.93	27.14	7.72	12.09	16.48	27.10	44.27	44.26	70.43	-0.53~6.63	

*1 : The throw ratio is based on the value during projection onto a 80" screen size.

*2 : When the fixed-focus lens (ET-ELW21) is attached, the lens shift cannot be used, so the height position (H) will be SH/2.

Setting up

■ Projection distance by projection lens (for EW630 series and EW530 series)

- For the screen aspect ratio of 16:10 (Unit: m)

Lens type			The standard zoom lens		The lens of optional accessories								Height position (H) ^{*2}
					Fixed-focus Lens	Short Zoom Lens	Long Zoom Lens	Ultra Long Zoom Lens					
Model number of projection lens			---		ET-ELW21	ET-ELW20	ET-ELT20	ET-ELT21					
Throw ratio ^{*1}			1.7 ~ 2.8:1		0.8:1	1.3 ~ 1.7:1	2.8 ~ 4.6:1	4.6 ~ 7.2:1					
Screen dimensions			Projection distance (L)										
Screen size	Height (SH)	Width (SW)	Min. (LW)	Max. (LT)	Fixed	Min. (LW)	Max. (LT)	Min. (LW)	Max. (LT)	Min. (LW)	Max. (LT)		
40"	0.538	0.862	1.39	2.40	0.64	1.04	1.43	2.34	3.89	3.80	6.15	-0.05~0.59	
50"	0.673	1.077	1.75	3.02	0.82	1.31	1.81	2.95	4.88	4.80	7.75	-0.06~0.74	
60"	0.808	1.292	2.11	3.63	0.99	1.59	2.18	3.57	5.88	5.80	9.34	-0.08~0.88	
70"	0.942	1.508	2.47	4.24	1.17	1.86	2.55	4.18	6.88	6.80	10.93	-0.09~1.03	
80"	1.077	1.723	2.83	4.85	1.34	2.14	2.92	4.79	7.88	7.80	12.52	-0.10~1.18	
90"	1.212	1.939	3.19	5.47	1.52	2.41	3.29	5.40	8.88	8.81	14.11	-0.11~1.33	
100"	1.346	2.154	3.55	6.08	1.69	2.68	3.67	6.02	9.88	9.81	15.70	-0.13~1.47	
120"	1.615	2.585	4.27	7.31	2.04	3.23	4.41	7.24	11.88	11.81	18.88	-0.15~1.77	
150"	2.019	3.231	5.35	9.15	2.57	4.05	5.53	9.08	14.88	14.82	23.66	-0.19~2.21	
200"	2.692	4.308	7.15	12.21	3.45	5.42	7.39	12.15	19.88	19.83	31.61	-0.25~2.95	
250"	3.365	5.385	8.95	15.28	4.32	6.79	9.25	15.22	24.87	24.84	39.57	-0.32~3.68	
300"	4.039	6.462	10.75	18.34	5.20	8.16	11.11	18.28	29.87	29.85	47.53	-0.38~4.42	
350"	4.712	7.539	12.55	21.41	6.07	9.53	12.97	21.35	34.87	34.86	55.48	-0.44~5.16	
400"	5.385	8.616	14.35	24.47	6.95	10.90	14.83	24.41	39.87	39.87	63.44	-0.51~5.89	

- For the screen aspect ratio of 16:9 (Unit: m)

Lens type			The standard zoom lens		The lens of optional accessories								Height position (H) ^{*2}
					Fixed-focus Lens	Short Zoom Lens	Long Zoom Lens	Ultra Long Zoom Lens					
Model number of projection lens			---		ET-ELW21	ET-ELW20	ET-ELT20	ET-ELT21					
Throw ratio ^{*1}			1.7 ~ 2.8:1		0.8:1	1.3 ~ 1.7:1	2.8 ~ 4.6:1	4.6 ~ 7.2:1					
Screen dimensions			Projection distance (L)										
Screen size	Height (SH)	Width (SW)	Min. (LW)	Max. (LT)	Fixed	Min. (LW)	Max. (LT)	Min. (LW)	Max. (LT)	Min. (LW)	Max. (LT)		
40"	0.498	0.886	1.43	2.47	0.66	1.07	1.48	2.41	4.00	3.91	6.33	-0.08~0.58	
50"	0.623	1.107	1.80	3.10	0.84	1.35	1.86	3.04	5.02	4.94	7.97	-0.10~0.72	
60"	0.747	1.328	2.17	3.73	1.02	1.63	2.24	3.67	6.05	5.97	9.60	-0.12~0.87	
70"	0.872	1.550	2.54	4.36	1.20	1.92	2.62	4.30	7.08	7.00	11.24	-0.14~1.01	
80"	0.996	1.771	2.91	4.99	1.38	2.20	3.01	4.93	8.11	8.03	12.87	-0.16~1.16	
90"	1.121	1.992	3.28	5.62	1.56	2.48	3.39	5.56	9.13	9.06	14.51	-0.18~1.30	
100"	1.245	2.214	3.65	6.25	1.74	2.76	3.77	6.19	10.16	10.09	16.14	-0.20~1.44	
120"	1.494	2.657	4.39	7.51	2.10	3.32	4.53	7.45	12.21	12.15	19.41	-0.24~1.73	
150"	1.868	3.321	5.50	9.40	2.64	4.17	5.68	9.34	15.30	15.24	24.32	-0.30~2.17	
200"	2.491	4.428	7.35	12.55	3.54	5.58	7.59	12.49	20.43	20.38	32.50	-0.40~2.89	
250"	3.113	5.535	9.20	15.70	4.44	6.99	9.51	15.64	25.57	25.53	40.68	-0.50~3.61	
300"	3.736	6.641	11.05	18.85	5.34	8.39	11.42	18.79	30.71	30.68	48.85	-0.60~4.33	
350"	4.358	7.748	12.90	22.00	6.24	9.80	13.33	21.94	35.84	35.83	57.03	-0.70~5.06	
400"	4.981	8.855	14.75	25.15	7.14	11.21	15.24	25.10	40.98	40.98	65.21	-0.80~5.78	

*1 : The throw ratio is based on the value during projection onto a 80" screen size.

*2 : When the fixed-focus lens (ET-ELW21) is attached, the lens shift cannot be used, so the height position (H) will be SH/2.

● For the screen aspect ratio of 4:3 (Unit: m)

Lens type			The standard zoom lens		The lens of optional accessories								Height position (H) ^{*2}
					Fixed-focus Lens	Short Zoom Lens	Long Zoom Lens	Ultra Long Zoom Lens					
Model number of projection lens			---		ET-ELW21	ET-ELW20	ET-ELT20	ET-ELT21					
Throw ratio ^{*1}			2.0 ~ 3.4:1		0.9:1	1.5 ~ 2.0:1	3.4~ 5.5:1	5.5 ~ 8.8:1					
Screen dimensions			Projection distance (L)										
Screen size	Height (SH)	Width (SW)	Min. (LW)	Max. (LT)	Fixed	Min. (LW)	Max. (LT)	Min. (LW)	Max. (LT)	Min. (LW)	Max. (LT)		
40"	0.610	0.813	1.58	2.73	0.74	1.19	1.63	2.66	4.41	4.32	6.99	-0.06~0.67	
50"	0.762	1.016	1.99	3.42	0.93	1.50	2.05	3.36	5.54	5.46	8.80	-0.07~0.83	
60"	0.914	1.219	2.39	4.11	1.13	1.81	2.47	4.05	6.68	6.59	10.60	-0.09~1.00	
70"	1.067	1.422	2.80	4.81	1.33	2.12	2.89	4.75	7.81	7.73	12.40	-0.10~1.17	
80"	1.219	1.626	3.21	5.50	1.53	2.43	3.32	5.44	8.94	8.86	14.20	-0.11~1.33	
90"	1.372	1.829	3.62	6.20	1.73	2.74	3.74	6.13	10.07	10.00	16.00	-0.13~1.50	
100"	1.524	2.032	4.03	6.89	1.93	3.05	4.16	6.83	11.20	11.13	17.80	-0.14~1.67	
120"	1.829	2.438	4.84	8.28	2.32	3.67	5.00	8.22	13.47	13.40	21.41	-0.17~2.00	
150"	2.286	3.048	6.06	10.36	2.92	4.60	6.26	10.30	16.86	16.80	26.81	-0.22~2.50	
200"	3.048	4.064	8.10	13.83	3.91	6.15	8.37	13.77	22.52	22.47	35.82	-0.29~3.34	
250"	3.810	5.080	10.14	17.30	4.90	7.70	10.48	17.24	28.18	28.15	44.82	-0.36~4.17	
300"	4.572	6.096	12.18	20.77	5.89	9.25	12.58	20.71	33.83	33.82	53.83	-0.43~5.00	
350"	5.334	7.112	14.21	24.24	6.88	10.80	14.69	24.18	39.49	39.49	62.84	-0.50~5.84	
400"	6.096	8.128	16.25	27.71	7.88	12.35	16.79	27.65	45.15	45.16	71.85	-0.57~6.67	

■ Projection distance by projection lens (for EX600 series and EX500 series)

● For the screen aspect ratio of 16:9 (Unit: m)

Lens type			The standard zoom lens		The lens of optional accessories								Height position (H) ^{*2}
					Fixed-focus Lens	Short Zoom Lens	Long Zoom Lens	Ultra Long Zoom Lens					
Model number of projection lens			---		ET-ELW21	ET-ELW20	ET-ELT20	ET-ELT21					
Throw ratio ^{*1}			1.7 ~ 2.8:1		0.8:1	1.3 ~ 1.7:1	2.8~ 4.6:1	4.6 ~ 7.2:1					
Screen dimensions			Projection distance (L)										
Screen size	Height (SH)	Width (SW)	Min. (LW)	Max. (LT)	Fixed	Min. (LW)	Max. (LT)	Min. (LW)	Max. (LT)	Min. (LW)	Max. (LT)		
40"	0.498	0.886	1.42	2.46	0.66	1.06	1.47	2.40	3.99	3.89	6.31	-0.08~0.58	
50"	0.623	1.107	1.79	3.09	0.84	1.40	1.85	3.03	5.01	4.92	7.94	-0.10~0.73	
60"	0.747	1.328	2.16	3.72	1.02	1.68	2.23	3.65	6.04	5.95	9.57	-0.12~0.87	
70"	0.872	1.550	2.53	4.34	1.20	1.96	2.62	4.28	7.06	6.97	11.21	-0.15~1.02	
80"	0.996	1.771	2.90	4.97	1.38	2.24	3.00	4.91	8.09	8.00	12.84	-0.17~1.16	
90"	1.121	1.992	3.27	5.60	1.56	2.52	3.38	5.54	9.11	9.02	14.47	-0.19~1.31	
100"	1.245	2.214	3.64	6.23	1.74	2.80	3.76	6.17	10.13	10.05	16.10	-0.21~1.45	
120"	1.494	2.657	4.38	7.48	2.10	3.36	4.52	7.42	12.18	12.10	19.36	-0.25~1.74	
150"	1.868	3.321	5.48	9.37	2.64	4.20	5.67	9.31	15.26	15.18	24.25	-0.31~2.18	
200"	2.491	4.428	7.33	12.50	3.54	5.60	7.57	12.45	20.38	20.32	32.41	-0.41~2.91	
250"	3.113	5.535	9.18	15.64	4.44	7.00	9.48	15.59	25.51	25.45	40.56	-0.52~3.63	
300"	3.736	6.641	11.02	18.78	5.33	8.40	11.39	18.73	30.63	30.58	48.72	-0.62~4.36	
350"	4.358	7.748	12.87	21.92	6.23	9.80	13.29	21.87	35.75	35.71	56.87	-0.73~5.08	
400"	4.981	8.855	14.72	25.05	7.13	11.20	15.20	25.01	40.88	40.84	65.03	-0.83~5.81	

*1 : The throw ratio is based on the value during projection onto a 80" screen size.

*2 : When the fixed-focus lens (ET-ELW21) is attached, the lens shift cannot be used, so the height position (H) will be SH/2.

Setting up

● For the screen aspect ratio of 4:3 (Unit: m)

Lens type			The standard zoom lens		The lens of optional accessories								Height position (H) ^{*2}
					Fixed-focus Lens	Short Zoom Lens	Long Zoom Lens	Ultra Long Zoom Lens					
Model number of projection lens			---		ET-ELW21	ET-ELW20	ET-ELT20	ET-ELT21					
Throw ratio ^{*1}			1.7 ~ 2.8:1		0.8:1	1.3 ~ 1.7:1	2.8~ 4.6:1	4.6 ~ 7.2:1					
Screen dimensions			Projection distance (L)										
Screen size	Height (SH)	Width (SW)	Min. (LW)	Max. (LT)	Fixed	Min. (LW)	Max. (LT)	Min. (LW)	Max. (LT)	Min. (LW)	Max. (LT)		
40"	0.610	0.813	1.30	2.26	0.60	0.97	1.35	2.19	3.65	3.56	5.78		
50"	0.762	1.016	1.64	2.83	0.77	1.23	1.70	2.77	4.59	4.50	7.27		
60"	0.914	1.219	1.98	3.41	0.93	1.49	2.05	3.34	5.53	5.44	8.77		
70"	1.067	1.422	2.32	3.98	1.10	1.74	2.40	3.92	6.47	6.38	10.27		
80"	1.219	1.626	2.66	4.56	1.26	2.00	2.75	4.50	7.41	7.32	11.77		
90"	1.372	1.829	3.00	5.14	1.43	2.26	3.10	5.07	8.35	8.27	13.26		
100"	1.524	2.032	3.33	5.71	1.59	2.51	3.45	5.65	9.29	9.21	14.76		
120"	1.829	2.438	4.01	6.86	1.92	3.03	4.15	6.80	11.17	11.09	17.75		
150"	2.286	3.048	5.03	8.59	2.42	3.80	5.20	8.53	14.00	13.92	22.24		
200"	3.048	4.064	6.72	11.47	3.24	5.08	6.95	11.41	18.70	18.63	29.73		
250"	3.810	5.080	8.42	14.35	4.07	6.37	8.70	14.30	23.40	23.34	37.21		
300"	4.572	6.096	10.11	17.23	4.89	7.65	10.45	17.18	28.11	28.05	44.70		
350"	5.334	7.112	11.81	20.11	5.72	8.94	12.20	20.06	32.81	32.76	52.18		
400"	6.096	8.128	13.50	22.99	6.54	10.22	13.95	22.94	37.51	37.47	59.67		

*1 : The throw ratio is based on the value during projection onto a 80" screen size.

*2 : When the fixed-focus lens (ET-ELW21) is attached, the lens shift cannot be used, so the height position (H) will be SH/2.

If the projector is used with a screen size not listed in this manual, check the diagonal dimension (m) of your screen and calculate the projection distance using the following formula.

■ Calculation formulas for projection distance by lens types (for EZ570 series)

Lens type		Aspect ratio	Projection distance (L) formula
The standard zoom lens		16:10	Min. (LW) $L = 0.138996 \times SD(m) - 0.054882$
			Max. (LT) $L = 0.236398 \times SD(m) - 0.048228$
		16:9	Min. (LW) $L = 0.14286 \times SD(m) - 0.054882$
			Max. (LT) $L = 0.242969 \times SD(m) - 0.048228$
		4:3	Min. (LW) $L = 0.157357 \times SD(m) - 0.054882$
			Max. (LT) $L = 0.267626 \times SD(m) - 0.048228$
Fixed-focus Lens	ET-ELW21	16:10	$L = 0.06763 \times SD(m) - 0.057678$
		16:9	$L = 0.06951 \times SD(m) - 0.057678$
		4:3	$L = 0.076564 \times SD(m) - 0.057678$
Short Zoom Lens	ET-ELW20	16:10	Min. (LW) $L = 0.105575 \times SD(m) - 0.055497$
			Max. (LT) $L = 0.143744 \times SD(m) - 0.053400$
		16:9	Min. (LW) $L = 0.10851 \times SD(m) - 0.055497$
			Max. (LT) $L = 0.14774 \times SD(m) - 0.053400$
		4:3	Min. (LW) $L = 0.119521 \times SD(m) - 0.055497$
			Max. (LT) $L = 0.162733 \times SD(m) - 0.053400$
Long Zoom Lens	ET-ELT20	16:10	Min. (LW) $L = 0.236622 \times SD(m) - 0.114022$
			Max. (LT) $L = 0.385831 \times SD(m) - 0.112874$
		16:9	Min. (LW) $L = 0.2432 \times SD(m) - 0.114022$
			Max. (LT) $L = 0.396557 \times SD(m) - 0.112874$
		4:3	Min. (LW) $L = 0.26788 \times SD(m) - 0.114022$
			Max. (LT) $L = 0.436799 \times SD(m) - 0.112874$
Ultra Long Zoom Lens	ET-ELT21	16:10	Min. (LW) $L = 0.386669 \times SD(m) - 0.212284$
			Max. (LT) $L = 0.614157 \times SD(m) - 0.210772$
		16:9	Min. (LW) $L = 0.397419 \times SD(m) - 0.212284$
			Max. (LT) $L = 0.631231 \times SD(m) - 0.210772$
		4:3	Min. (LW) $L = 0.437748 \times SD(m) - 0.212284$
			Max. (LT) $L = 0.695288 \times SD(m) - 0.210772$

Calculation formulas for projection distance by lens types (for EW630 series, EW530 series)

Lens type		Aspect ratio	Projection distance (L) formula
The standard zoom lens		16:10	Min. (LW) $L = 0.141732 \times SD(m) - 0.050400$
			Max. (LT) $L = 0.241339 \times SD(m) - 0.049700$
		16:9	Min. (LW) $L = 0.145672 \times SD(m) - 0.050400$
			Max. (LT) $L = 0.248048 \times SD(m) - 0.049700$
		4:3	Min. (LW) $L = 0.160455 \times SD(m) - 0.050400$
			Max. (LT) $L = 0.273219 \times SD(m) - 0.049700$
Fixed-focus Lens	ET-ELW21	16:10	$L = 0.068965 \times SD(m) - 0.057231$
		16:9	$L = 0.070882 \times SD(m) - 0.057231$
		4:3	$L = 0.078075 \times SD(m) - 0.057231$
Short Zoom Lens	ET-ELW20	16:10	Min. (LW) $L = 0.107874 \times SD(m) - 0.055400$
			Max. (LT) $L = 0.146457 \times SD(m) - 0.053400$
		16:9	Min. (LW) $L = 0.110873 \times SD(m) - 0.055400$
			Max. (LT) $L = 0.150528 \times SD(m) - 0.053400$
		4:3	Min. (LW) $L = 0.122124 \times SD(m) - 0.055400$
			Max. (LT) $L = 0.165804 \times SD(m) - 0.053400$
Long Zoom Lens	ET-ELT20	16:10	Min. (LW) $L = 0.241417 \times SD(m) - 0.113900$
			Max. (LT) $L = 0.393504 \times SD(m) - 0.112800$
		16:9	Min. (LW) $L = 0.248129 \times SD(m) - 0.113900$
			Max. (LT) $L = 0.404443 \times SD(m) - 0.112800$
		4:3	Min. (LW) $L = 0.273309 \times SD(m) - 0.113900$
			Max. (LT) $L = 0.445486 \times SD(m) - 0.112800$
Ultra Long Zoom Lens	ET-ELT21	16:10	Min. (LW) $L = 0.394488 \times SD(m) - 0.212700$
			Max. (LT) $L = 0.626457 \times SD(m) - 0.210700$
		16:9	Min. (LW) $L = 0.405455 \times SD(m) - 0.212700$
			Max. (LT) $L = 0.643872 \times SD(m) - 0.210700$
		4:3	Min. (LW) $L = 0.4466 \times SD(m) - 0.212700$
			Max. (LT) $L = 0.709212 \times SD(m) - 0.210700$

Calculation formulas for projection distance by lens types (for EX600 series, EX500 series)

Lens type		Aspect ratio	Projection distance (L) formula
The standard zoom lens		4:3	Min. (LW) $L = 0.133465 \times SD(m) - 0.055300$
			Max. (LT) $L = 0.226772 \times SD(m) - 0.048000$
		16:9	Min. (LW) $L = 0.14541 \times SD(m) - 0.055300$
			Max. (LT) $L = 0.247068 \times SD(m) - 0.048000$
Fixed-focus Lens	ET-ELW21	4:3	$L = 0.064961 \times SD(m) - 0.058500$
		16:9	$L = 0.070775 \times SD(m) - 0.058500$
Short Zoom Lens	ET-ELW20	4:3	Min. (LW) $L = 0.101181 \times SD(m) - 0.055800$
			Max. (LT) $L = 0.137795 \times SD(m) - 0.054000$
		16:9	Min. (LW) $L = 0.110237 \times SD(m) - 0.055800$
			Max. (LT) $L = 0.150128 \times SD(m) - 0.054000$
Long Zoom Lens	ET-ELT20	4:3	Min. (LW) $L = 0.226929 \times SD(m) - 0.114200$
			Max. (LT) $L = 0.370315 \times SD(m) - 0.112900$
		16:9	Min. (LW) $L = 0.247239 \times SD(m) - 0.114200$
			Max. (LT) $L = 0.403458 \times SD(m) - 0.112900$
Ultra Long Zoom Lens	ET-ELT21	4:3	Min. (LW) $L = 0.370906 \times SD(m) - 0.213200$
			Max. (LT) $L = 0.58937 \times SD(m) - 0.210900$
		16:9	Min. (LW) $L = 0.404102 \times SD(m) - 0.213200$
			Max. (LT) $L = 0.642119 \times SD(m) - 0.210900$

Adjusting front adjustable feet

The adjustable feet can be extended by turning it as shown in the figure. It is retracted by turning it in the opposite direction. (Projection angle can be adjusted vertically.)

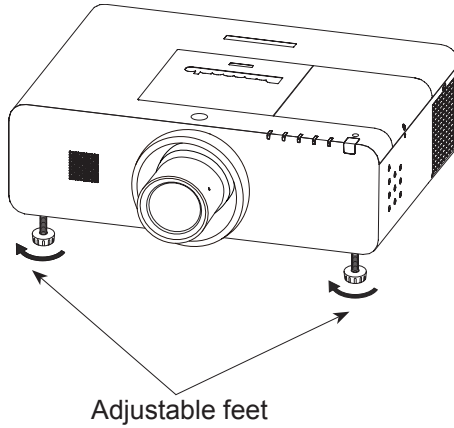
**Adjustable range**

Front adjustable feet : 30 mm (1.181")

Attention

- Heated air comes out of the air exhaust port while the lamp is lit. Do not touch the air exhaust port directly when you adjust the front adjustable feet.
- If keystone distortion occurs on the projected image, perform "KEYSTONE" from the "Screen" menu. (➡page 59)

Connections

Before connecting to the projector

- Read carefully the instruction manual for the device to be connected.
- Turn off the power switch of the devices before connecting cables.
- If any connection cable is not supplied with the device, or if no optional cable is available for connection of the device, prepare a necessary system connection cable to suit the device.
- Video signals containing too much jitter may cause the images on the screen to randomly wobble or wafture. In this case, a time base corrector (TBC) must be connected.
- The projector accepts the following signals: VIDEO, S-VIDEO, analogue-RGB (with TTL sync. Level) and digital signal.
- Some computer models are not compatible with the projector.
- When using long cables to connect with each of equipment to the projector, there is a possibility that the image will not be output correctly unless a compensator is used.
- For details on what video signals the projector supports, see "List of compatible signals". (➔pages 109 to 113)

Connecting example

Analog Out Signal Table

Input terminal and Input signals		Monitor Out	
Input 1	RGB	RGB(PC analog)	YES
		RGB(Scart)	NO
	DVI-D	DVI-D	NO
		DVI-D(HDCP)	NO
HDMI	HDMI	NO	
Input 2	G, B, R, SYNC/HD, VD	RGB	YES
	VIDEO	Video	NO
	Y, Pb/Cb, Pr/Cr	Y, Pb/Cb, Pr/Cr	NO
Input 3	Y, Pb/Cb, Pr/Cr	Y, Pb/Cb, Pr/Cr	NO
	S-VIDEO	S-video	NO
	VIDEO	Video	NO

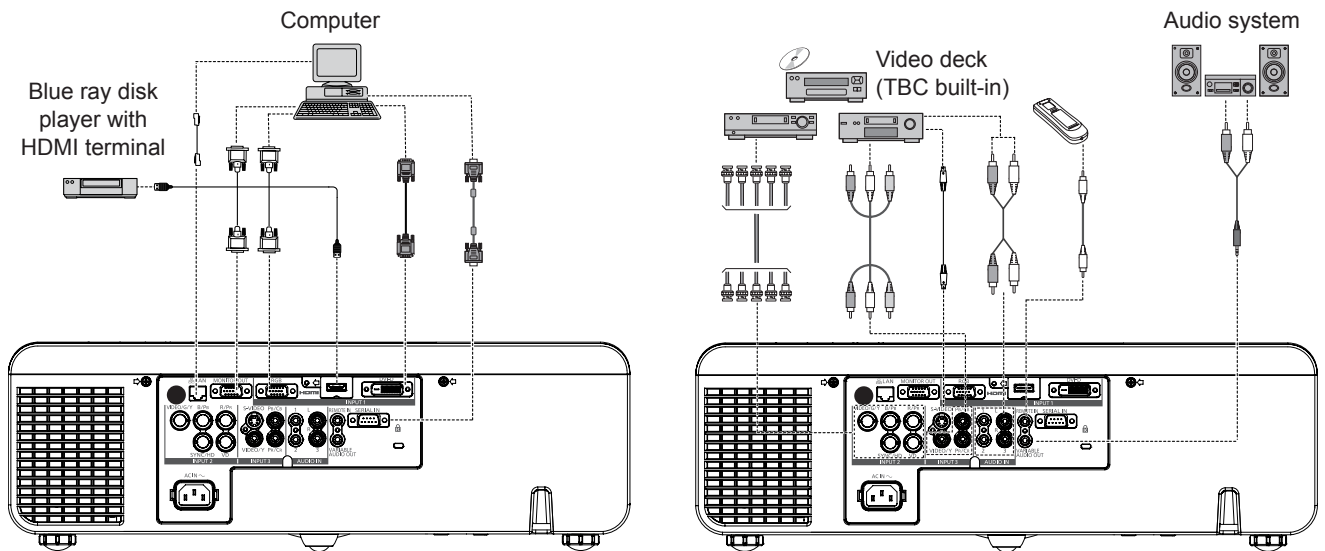

Attention

- When connecting with a video deck, be sure to use the one with a built-in time base corrector (TBC) or use a TBC between the projector and the video deck.
- If nonstandard burst signals are connected, the image may be distorted. If this is the case, connect a TBC between the projector and the video deck.

Note

- When using an HDMI cable, check that it is compliant with the HDMI standard. Using a cable that is not compliant with the HDMI standard may result in problems such as the image cutting out or not appearing. When connecting the 1 080p signal using HDMI, use a cable compliant with 1 080p signal.
- This projector does not support the Viera link (HDMI).
- For the specifications of the RGB signals that can be applied from the PC, refer to "List of compatible signals". (➔pages 109 to 113)

Powering ON/OFF

Connecting the power cord

Be sure to insert the attached power cord securely to its base to prevent it from coming off.

■ Power cord holder

A power cord holder is designed to prevent the AC power cord from coming off the projector. Please insert the power cord into the power cord holder correctly as Picture (1) shown:

AC Power cord holder

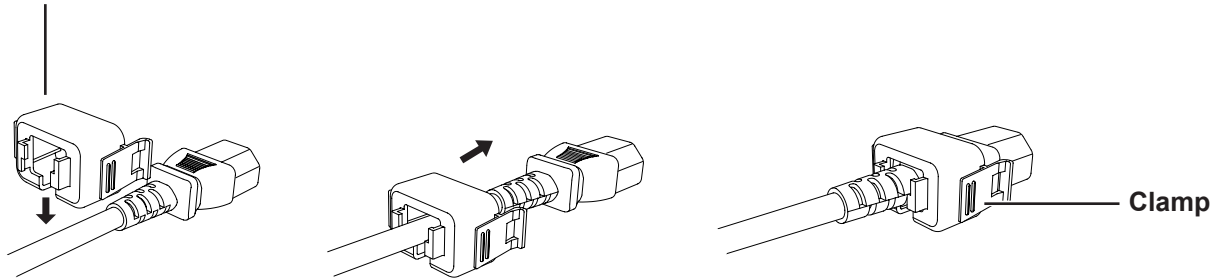

Picture (1)

■ Attaching

Attach the AC power cord with the power cord clamps to the projector as follows: Press the clamps on its sides, and then insert the AC power cord with the power cord clamps securely to the projector as Picture (2) shown. It is correctly attached until you hear the "CLICK" sound. See Picture (3) for correct attachment.

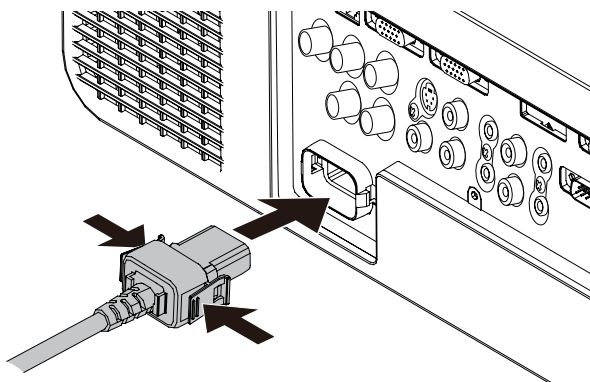

Picture (2)

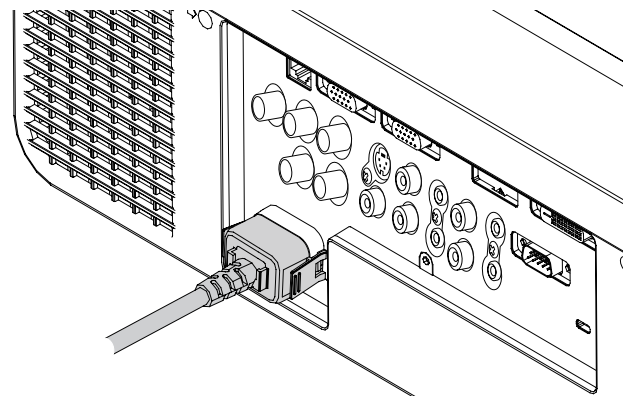

Picture (3)

■ Removal

Remove the AC power cord from the electrical outlet while pressing the clamps on its sides.

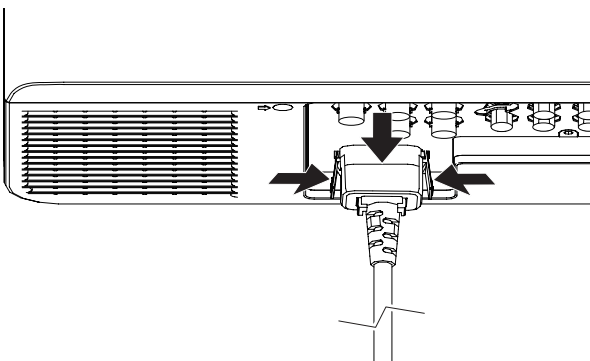

Powering ON/OFF

ON(G)/STANDBY(R) indicator

The <ON(G)/STANDBY(R)> indicator informs you the status of the power. Confirm the status of the <ON(G)/STANDBY(R)> indicator before operating the projector.

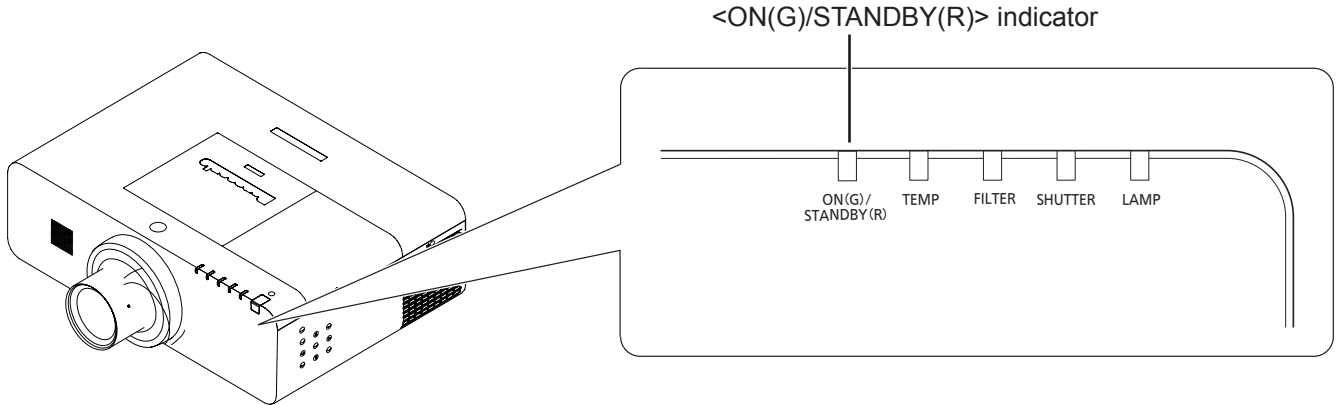

Indicator status		Status
No illumination or flashing		The power cord is unplugged.
RED	Lit	The power cord is plugged.
		The projector is in stand-by mode, after the cooling is completed.
ORANGE	Flashing	The projector is cooling down. The projector cannot be turned on until cooling is completed and the <ON(G)/STANDBY(R)> indicator stops blinking.
		The temperature inside the projector is abnormally high and the projector is cooling down. And the <TEMP> indicator also blinks in red (➡ page 91). The projector cannot be turned on until cooling is completed and the <ON(G)/STANDBY(R)> indicator stops blinking.
GREEN	Lit	Projecting.
	Flashing	The projector is in stand-by status with [Power management] function. The projection lamp will be turned on if the input signal is reconnected or any button on the control panel or remote control is pressed. (➡ page 67)

Turning On the Projector

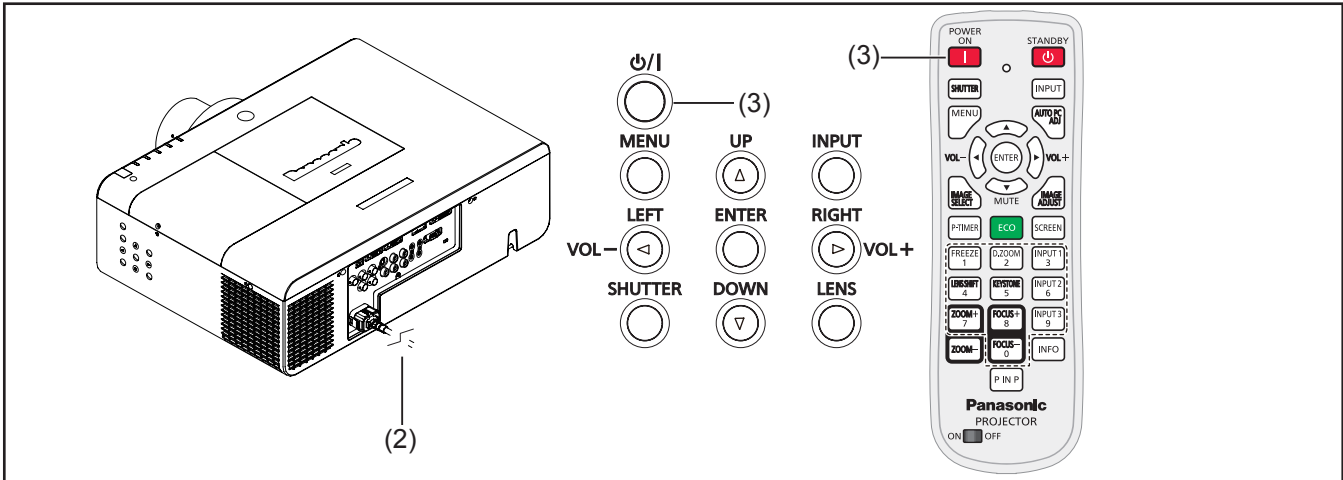

- 1) Complete peripheral connections (with a computer, VCR, etc.) before turning on the projector.
- 2) Connect the projector's AC power cord into an AC outlet. The <ON(G)/STANDBY(R)> indicator lights red.
- 3) Press the < ⏻/| > button on the side control or the <POWER ON> button on the remote control. The <ON(G)/STANDBY(R)> indicator lights green and the cooling fans start to operate. The preparation display appears on the screen and the count down starts.
- 4) After the countdown, the input source that was selected the last time and the lamp power status icon appear on the screen.

If the projector is locked with a PIN code, PIN code input dialog box will appear. Enter the PIN code as instructed on the next page.

Note

- When the [Logo select] function is set to [Off], the logo will not be shown on the screen (➡ page 63).
- When [Countdown off] or [Off] is selected in the [Display] function, the preparation display will not be shown on the screen (➡ page 63).
- When the [Direct on] function is set to [On], the projector will be turned on automatically by connecting the AC power cord to an AC outlet.
- The Lamp replacement icon and the Filter replacement icon may appear on the screen depending on the usage state of the projector.
- When the [Picture in Picture] function is set to User 1-5, User 1-5, Input source, Lamp power status, Lamp replacement icon and Filter warning icon will appear on the screen for 10 seconds.

Preparation display

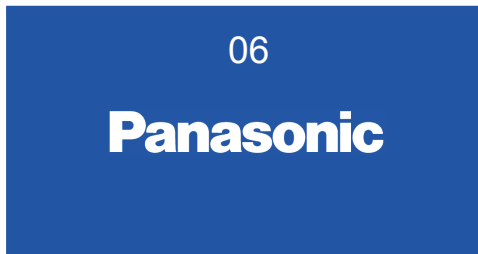

The preparation display will disappear after 30 seconds.

Initial display

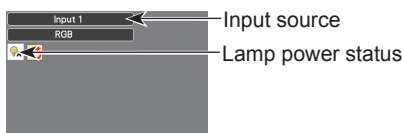

Powering ON/OFF

Enter a PIN code

■ When using the side control

Press ▲▼ to enter a number. Press ► to fix the number and move the red frame pointer to the next box. The number changes to *. If you fixed an incorrect number, use the ◀ button to move the pointer to the number you want to correct, and then enter the correct number.

Repeat this step to complete entering a four-digit number.

After entering the four-digit number, move the pointer to "Set". Press the <ENTER> button so that you can start to operate the projector.

■ When using the remote control

Press the Number buttons on the remote control to enter a number (►page 18). When you complete entering a four-digit number, the pointer moves to "Set". Press the <ENTER> button so that you can start to operate the projector.

If you fix an incorrect number, use the ◀ button to move the pointer to the number you want to correct, and then enter the correct number.

If you entered an incorrect PIN code, PIN code and the number (****) will turn red for a moment. Enter the correct PIN code all over again.

Note

- If the PIN code number is not entered or wrong PIN code number is entered within three minutes after the PIN code dialog box appeared, the projector will be turned off automatically.
- The "1234" is set as the initial PIN code at the factory.

PIN Code Input Dialog Box

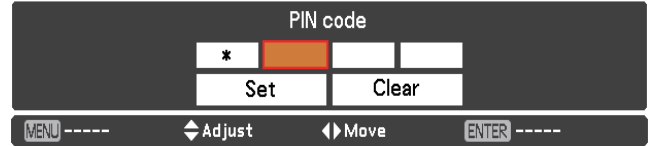

After the OK icon disappears, you can operate the projector.

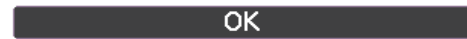

Turning Off the Projector

- 1) Press the < ⏻/| > button on the side control or the <STANDBY> button on the remote control, and **Power off?** appears on the screen.
- 2) Press the < ⏻/| > button on the side control or the <STANDBY> button on the remote control again to turn off the projector. The <ON(G)/STANDBY(R)> indicator starts to blink orange, and the cooling fans keep running. At this time, you can unplug the AC power cord even if the fans are still running.
- 3) When the projector has cooled down enough, the <ON(G)/STANDBY(R)> indicator stops blinking and you can turn on the projector.

Note

- Do not put the projector in a case before the projector is cooled enough.
- While the <ON(G)/STANDBY(R)> indicator is blinking, the lamp is being cooled down and the projector cannot be turned on. Wait until the <ON(G)/STANDBY(R)> indicator stops blinking to turn on the projector again.
- The projector can be turned on after the <ON(G)/STANDBY(R)> indicator turns red. The waiting time to restart will be shortened when the normal power-off processing for fan cooling is completed, compared with the time the AC power cord is immediately unplugged after the power-off.

Direct Power Off function

You can disconnect the power cord from the wall outlet or turn off the breaker even during projection without pressing the < ⏻/| > button.

Note

- When using the Direct Power Off function, you cannot restart the projector immediately after the power is disconnected. The lamp remains high temperature and needs to be cooled, so it sometimes takes longer time than usual for the lamp to light up again.

Power off ?

Power off? disappears after 4 seconds.

Note

- If the <STANDBY> button on the remote control is pressed, the time countdown will be brought to an end without appearing **Power off?** afterwards on the screen.

Projecting

Check the connections of the peripheral devices and connection of the power cord (➔page 35) and switch on the power (➔page 37) to start the projector. Select the image and adjust the state of the image.

Selecting the image

Select an input signal.

Side Control/Remote Control Operation

You can press the <INPUT> button on the side control or the remote control to select INPUT 1/2/3 as input source.

Remote Control Operation

Press the <INPUT 1>, <INPUT 2>, or <INPUT 3> button on the remote control. Each time you press the <INPUT 1/2/3> button, the input signal will be changed.

Attention

- Images may not be projected properly depending on the connected device and DVD, video tape, etc. to be played. Select a system format that is suitable for the input signal [Y, Pb/Cb, Pr/Cr] or [RGB] in the [Input] menu (➔page 49).
- Check the aspect ratio of the screen and the image and select the optimum aspect ratio under the [Screen] menu (➔page 58).

Adjusting the image

Adjusting the position of the lens

1) Press the <LENS SHIFT> button on the remote control or the <LENS> button on the side control.

- [Lens shift] is displayed on the screen for four seconds.

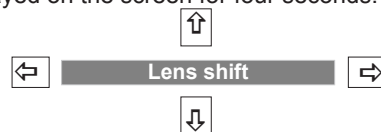

2) While the display appears, press ▲ ▼ ◀ ▶ to move the image horizontally and vertically.

- As you move the image, there is a certain position at which the arrows pointing up, down, left and right turn red. This position is the center for the lens.
- At positions of maximum shift, the arrows disappear.
- The projector stores the setting made using the lens shift function when the power is turned off.
- When the position of the image is shifted, the image may become a little darker.
- Press and hold the <LENS> button or <LENS SHIFT> button for more than 5 seconds, the lens shift will be return to the center position.

The figure below shows an example of when the standard lens is attached.

When the lens is shifted to top. When the lens is shifted to bottom. When the lens is shifted to leftmost. When the lens is shifted to rightmost.

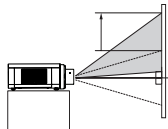

The display position can be shifted upward up to 60%* elevation of the display.

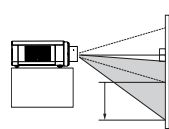

The display position can be shifted downward up to 60%* low level of the display.

*When it is 60%, it is only for EZ570 series, EW630 series and EW530 series. When it is 50%, it is only for EX600 series and EX500 series.

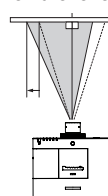

The display position can be shifted to the left in up to 10% width of the display.

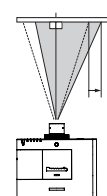

The display position can be shifted to the right in up to 10% width of the display.

Adjusting the zoom and focus

1) Press the <ZOOM +/-> button and the <FOCUS +/-> button on the remote control.

- [Zoom] and [Focus] are displayed on the screen for four seconds.

2) While the display appears, press ▲ ▼ to adjust the zoom and focus.

Note

- When [Display] is set to [Off], the adjustment screen will not appear.
- It is recommended that the images are projected continuously for at least 30 minutes before the focus is adjusted.

Basic operations by using the remote control



Note

- When use the <MUTE> button to release the [AV mute] function, the mute function cannot be operated at the same time.

Switching the input signal

You can switch the input signals to project.

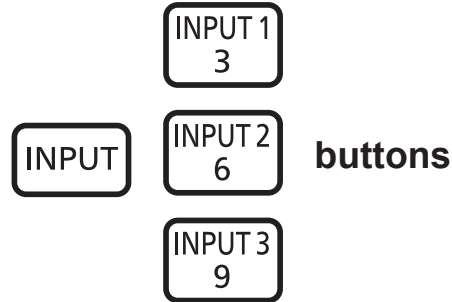

Press the <INPUT> button or the <INPUT 1>/<INPUT 2>/<INPUT 3> button on the remote control.

The input source changes each time you press the <INPUT> button as follows:

Input 1 --> Input 2 --> Input 3 --> ...

The input source changes each time you press the <INPUT 1>/<INPUT 2>/<INPUT 3> button as follows:

<INPUT 1>/<INPUT 2>/<INPUT 3> button as follows:

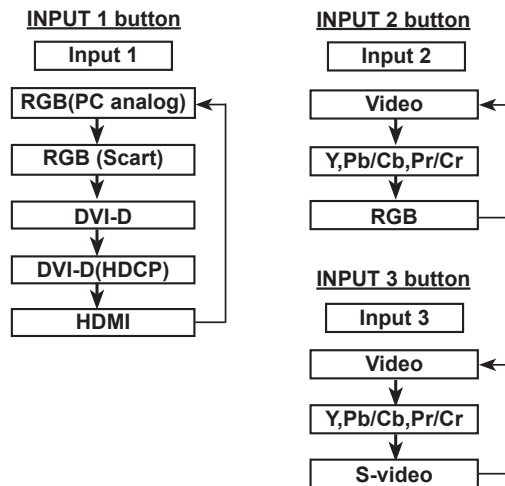

Note

- Whether the input search function is available or not after you pressed the <INPUT> button, it depends on the setting of the [Input button] in the Setting menu. (➡page 62)

Using the SHUTTER/ AV MUTE button

* <SHUTTER> button

Only for EZ570 series, EW630 series and EX600 series

This function allows you to completely block out light to the screen.



Press the <SHUTTER*> button on the remote control.

Note

- For details, see "Setting" of Main menu. (➡page 68)

* <AV MUTE> button

Only for EW530 series and EX500 series



Press the <AV MUTE*> button on the remote control.

Press the < AV MUTE> button on the remote control to black out the image. To restore to normal, press the < AV MUTE> button again or press any button.



Basic operations by using the remote control

Using the MENU button

This function allows you to open or close the On-Screen Menu.



Press the <MENU> button on the remote control.

Note

- For details, please refer to "Menu Navigation". (➔page 46)

Using the AUTO PC ADJ button

This function allows you to adjust the computer screen easily.



Press the <AUTO PC ADJ> button on the remote control.

Note

- For details, see "Auto PC adjust" of Main menu. (➔page 51)

Controlling the volume of the speaker

You can control the volume of the projector's speaker or audio output.



Press the <VOL> (-/+) buttons on the side control or on the remote control to adjust the volume. The volume dialog box appears on the screen for a few seconds.

Note

- For details, see "Volume" of "Sound" under Main menu. (➔page 61)

Using the IMAGE SELECT button

This function allows you to operate the image selection directly.



Press the <IMAGE SELECT> button on the remote control.

Note

- For details, see "Image select" of Main menu. (➔page 54)

Using the MUTE button

Press this button on the remote control to temporarily turn off the sound.



Press <MUTE> button on the remote control.

Note

- To turn the sound back on, press this button again or press the <VOL> (-/+) buttons. (➔page 61)

Using the IMAGE ADJUST button

This function allows you to adjust the image.



Press the <IMAGE ADJUST> button on the remote control.

Note

- For details, see "Image adjust" of Main menu. (➔page 55)

Basic operations by using the remote control

Using the P-TIMER button

Press the <P-TIMER> button on the remote control to operate the Count up/Count down function.



button

Press <P-TIMER> button on the remote control.

Note

- Press the <P-TIMER> button to start the count time. Press the <P-TIMER> button again to stop the count time. Press the <P-TIMER> button to restart the count. To cancel the [P-timer] function, press and hold the <P-TIMER> button. (➔page 67)

Using the ECO button

Press this button to display the Eco management menu.



button

Press <ECO> button on the remote control.

Note

- For details, see "Eco management" of "Setting". (➔page 66)

Using the SCREEN button

This function allows you to select screen mode or change the screen size.



button

Press the <SCREEN> button on the remote control.

Note

- For details, see "Screen" of Main menu. (➔page 58)

Using the FREEZE function

You can freeze the projected image and stop the sound temporarily, regardless of the playing condition of the connected device.



button

Press the <FREEZE> button on the remote control to freeze the picture on the screen, meanwhile, volume is muted. To cancel the Freeze function, press the <FREEZE> button again or press any other button.

Fig.1 will appear on the screen while the Freeze function is working.

Fig.1



Note

- When no signal inputs,  mark will appear.

Using the D.ZOOM button

This function allows you to enter to the Digital zoom +/- mode.



button

Press <D.ZOOM> button on the remote control.

Note

- For details, see "Screen" of Main menu. (➔page 59)

Using the LENS SHIFT button

This function allows you to position the screen to the desired point without having picture distortion.



button

Press <LENS SHIFT> button on the remote control to display [Lens shift] on the screen.

Note

- For details, please refer to "Adjusting the image". (➔page 40)
- Press and hold the <LENS> button or <LENS SHIFT> button for more than 5 seconds, the lens shift will be return to the center position.

Basic operations by using the remote control

Using the KEYSTONE button

This function allows you to correct keystone distortion.



For EW530 series and EX500 series.

Press the <KEYSTONE> button on the remote control. The Keystone dialog box appears. Press ▲▼ to correct keystone distortion. The keystone adjustment can be stored (➔page 59).

Operation	Screen image
Reduce the upper width with press ▲.	
Reduce the lower width with press ▼.	

For EZ570 series, EW630 series and EX600 series.

Press the <KEYSTONE> button on the remote control to switch the [Standard] (for Vertical/Horizontal) / [Corner correction] adjustment. The [Standard] or [Corner correction] adjustment dialog box appears. Press ▲▼◀▶ to correct the Standard or Corner distortion. The [Standard] or [Corner correction] adjustment can be stored. (➔page 59)

Standard



Reduce the lower width with press ▼.

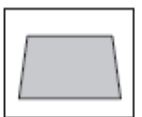

Reduce the right part with press ▶.

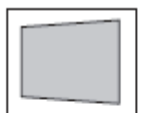

Reduce the upper width with press ▲.

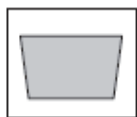

Reduce the left part with press ◀.

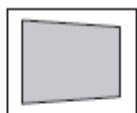

Corner correction



Press the <KEYSTONE> button on the remote control to switch [Corner correction] adjustment, press the <ENTER> button on the remote control to select the corner you want to adjust.

The top left corner adjustment as an example:

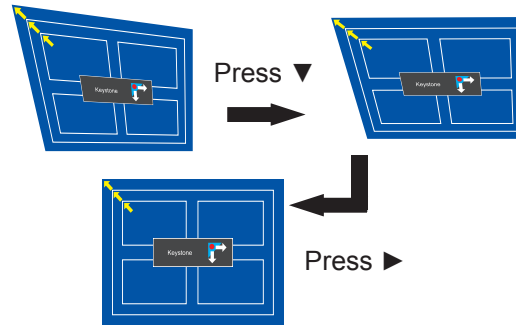

Reduce the top left corner part with press ▶▼.

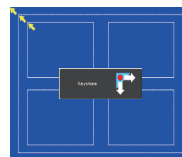

Press the <ENTER> button

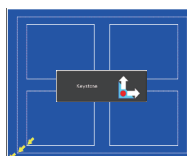

Reduce the bottom left corner part with press ▶▲.

Reduce the top right corner part with press ◀▼.

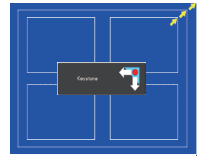

Press the <ENTER> button

Press the <ENTER> button

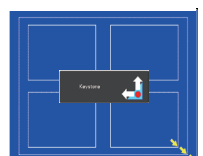

Reduce the bottom right corner part with press ◀▲.

Note

- The white arrows indicate that there is no correction.
- A red arrow indicates the direction of correction.
- An arrow disappears at the maximum correction.
- If you press and hold the <KEYSTONE> button for 3 seconds or more, the keystone adjustment will be canceled (➔page 59).
- The adjustable range is limited depending on the input signal.
- [Standard] and [Corner correction] functions cannot be adjusted at the same time. If one of the functions is adjusted, and then the other one will be reset automatically.

Basic operations by using the remote control

Using the ZOOM +/- buttons

Adjusts the zoom of the lens.

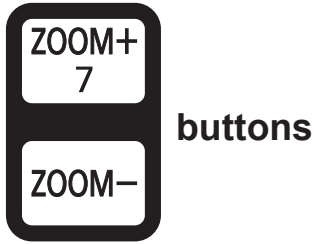

Press <ZOOM +/-> buttons on the remote control.

Note

- For details, please refer to "Adjusting the image" (➔page 40).

Using the FOCUS +/- buttons

This function allows you to to adjust focus of the image.

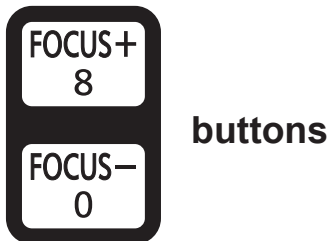

Press <FOCUS +/-> buttons on the remote control.

Note

- For details, please refer to "Adjusting the image" (➔page 40).

Using the INFO button

This function allows you to display the information menu.



Press <INFO> button on the remote control.

Note

- For details, see "Input Source Information Display" in "Information" under Main menu (➔page 71).

Using the P IN P button

Only for EZ570 series, EW630 series and EW530 series.

This function allows you to operate the Picture in Picture function.



Press <P IN P> button on the remote control.

Note

- For details, see "Picture in Picture" of "Setting" under Main menu (➔page 64).

Menu Navigation

Navigating through the menu

Operating procedure

For example: PT-EZ570E

1) Press the <MENU> button.

The Main Menu screen appears.

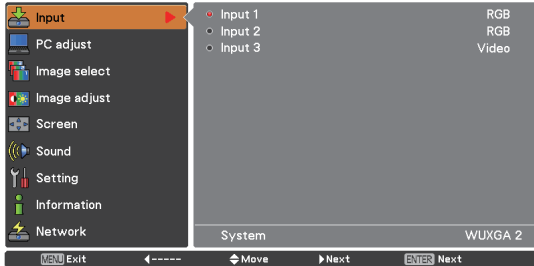

2) Press ▲ ▼ to select the Main Menu item.

Select the desired item from the 9 items: [Input], [PC adjust], [Image select], [Image adjust], [Screen], [Sound], [Setting], [Information] and [Network]. The selected item is highlighted with an orange cursor and the submenu of the selected item appears on the right.

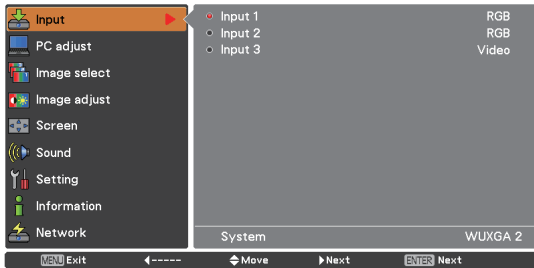

3) Press ► or the <ENTER> button.

The submenu appears so that you can select the sub-menu item.

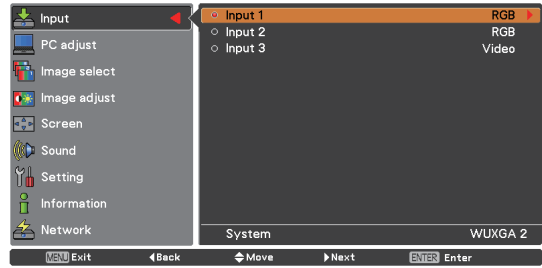

4) Press ▲ ▼ to select the desired sub-menu item.

5) Press the <ENTER> button or press ► to enter the desired item.

6) Press ▲ ▼ ◀ ▶ to set or adjust the parameter values.

7) Press ◀ to return the previous menu. Press the <MENU> button to exit the menu display.









Note

- Some items may not be adjusted or used for certain signal formats input to the projector. The MENU items that cannot be adjusted or used are shown in gray characters, and they cannot be selected.
- Some items can be adjusted even if signals are not input.
- See page 47 and 48 for details on the items of sub-menu.

Main menu

The main menu consists of the following 9 menu items.

When a main menu item is selected, the screen changes to a submenu selection screen.

	Input
	PC adjust
	Image select
	Image adjust
	Screen
	Sound
	Setting
	Information
	Network

Sub menu

The sub-menu screen of the selected main menu appears, and you can set and adjust the various items in the submenu.

Input []

Sub-menu item	Factory default	Page
Input 1	RGB(PC analog)	49
Input 2	Video	49
Input 3	Video	49

PC adjust []

Sub-menu item	Factory default	Page
Auto PC adj.	-	51
Fine sync.	-	52
Total dots	-	52
Position H	-	52
Position V	-	52

Sub-menu item	Factory default	Page
Current mode	-	53
Clamp	-	53
Display area H	-	53
Display area V	-	53
Reset	-	53
Mode free	-	53
Store	-	53

Note

- This function will be available when the input source come from computer.

Image select []

Sub-menu item	Factory default	Page
Dynamic	-	54
Standard	-	54
Real	-	54
Cinema*1	-	54
Natural*1	-	54
Image 1-10	-	54

*1 : When input video signal to the projector, these functions will be available.

Image adjust []

Sub-menu item	Factory default	Page
Contrast	32	55
Brightness	32	55
Color*1	32	55
Tint*1	32	55
Iris*2	-	55
Color temp.	Mid	56
Red	32	56
Green	32	56
Blue	32	56
Offset	32	56
Daylight View	Auto	56
Sharpness*3	8	57
Gamma	8	57
Noise Reduction*1	On	57
Progressive*1	On	57
Reset	-	57
Store	-	57

*1 : When input video signal to the projector, these functions will be available.

*2 : EZ570 series, EW630 series and EX600 series Only.

*3 : When input computer signal, the factory default of [Sharpness] is 8. When input video signal, the factory default of [Sharpness] is 15.

Menu Navigation

Screen []

Sub-menu item	Factory default	Page
Normal	-	58
Full	-	58
Wide (16:9)	-	58
Zoom	-	58
True*1	-	58
Natural wide*2	-	58
Custom	-	58
Custom adj.	-	59
Digital zoom + *1	-	59
Digital zoom - *1	-	59
Keystone	Store	59
Ceiling	Off	60
Rear	Off	60
Screen aspect*2	Default(16:10)	60
Reset	-	60

*1 : When input computer signal to the projector, these functions will be available.

*2 : This function is not available for EX600 series and EX500 series.

Sound []

Sub-menu item	Factory default	Page
Volume	15	61
Built-in SP	On	61
Mute	Off	61

Setting []

Sub-menu item	Factory default	Page
Language	English	62
Menu	Center	62
Input button	Mode 2	62
Display	On	63
Background	Blue	63
Logo	-	63
Picture in Picture*1	Off	64
HDMI setup	-	65
DVI signal level	-	65
Lamp power	Auto	65
Fan control	Off	65
Simple mode	Off	66
Remote control	All	66
RC sensor	Front & Back	66
Eco management	-	66
Power management	Shut down	67
Standby mode	Normal	67
Direct on	Off	67

Sub-menu item	Factory default	Page
P-timer	Count up	67
Security	-	68
Shutter*2	Off	68
Closed caption	Off	69
Video delay control	Off	69
Filter counter	Off	70
Test pattern	Color	70
Factory default	-	70

*1 : This function is not available for EX600 series and EX500 series.

*2 : This function is not available for EW530 series and EX500 series.

Information []

Sub-menu item	Factory default	Page
Input	-	71
System	-	71
H-sync freq.	-	71
V-sync freq.	-	71
Screen	-	71
Language	-	71
Lamp power	-	71
Lamp runtime	-	71
Filter counter	-	71
Power management	-	71
Key lock	-	71
PIN code lock	-	71
Shutter management	-	71
Simple mode	-	71
Remote control	-	71
Serial number	-	71

Network []

Sub-menu item	Factory default	Page
Projector name	-	72
Network setup	-	72
Network control	-	72
Network status	-	73
Network factory default	-	73

Input menu

Select [Input] from the Main Menu (see “Navigating through the menu” on page 46), then select the item from the sub-menu.

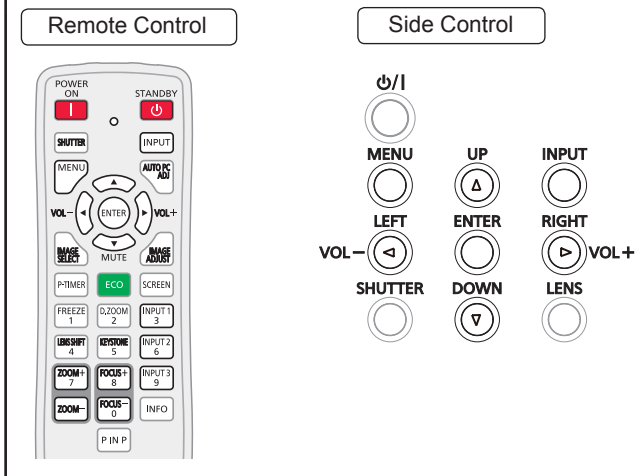

Input 1

- 1) Press ▲▼ to select [Input 1].
- 2) Press ► to access the submenu.
- 3) Press ▲▼ to select [RGB(PC analog)], [RGB(Scart)], [DVI-D], [DVI-D(HDCP)] or [HDMI].
- 4) Press the <ENTER> button.

Computer System Selection

This projector automatically tunes to various types of computers with its Multi-scan system and Auto PC Adjustment. If a computer is selected as a signal source, this projector automatically detects the signal format and tunes to project a proper image without any additional settings. (Signal formats provided in this projector are shown on pages 109 -113.)

Auto When the projector cannot recognize the connected signal conforming to the provided PC Systems, **Auto** is displayed on the System Menu box and the Auto PC adjustment function works to display proper images. If the image is not projected properly, a manual adjustment is required.

---- There is no signal input from the computer. Check the connection between your computer and the projector.

Mode 1 The preset system is manually adjusted in the PC adjust Menu. The adjusted data can be stored in Mode 1-10.

SVGA 1 PC Systems provided in this projector is chosen. The projector chooses a proper system provided in the projector and displays it.

* Mode 1 and SVGA 1 are examples.

- 1) Press ▲▼ to select [System].
- 2) Press ► or the <ENTER> button to access the submenu.
- 3) Press ▲▼ to select the desired system.

Input 2

- 1) Press ▲▼ to select [Input 2].
- 2) Press ► to access the submenu.
- 3) Press ▲▼ to select [Video], [Y, Pb/Cb,Pr/Cr], or [RGB].
- 4) Press the <ENTER> button.

Input 3

- 1) Press ▲▼ to select [Input 3].
- 2) Press ► to access the submenu.
- 3) Press ▲▼ to select [Video], [Y, Pb/Cb,Pr/Cr], or [S-video].
- 4) Press the <ENTER> button.

Video System Selection

Video or S-video

Auto

The projector automatically detects an incoming video system, and adjusts itself to optimize its performance. When Video System is [PAL-M] or [PAL-N], select the system manually.

PAL/SECAM/NTSC/NTSC4.43/PAL-M/PAL-N

If the projector cannot reproduce proper video image, select a specific broadcast signal format from among [PAL], [SECAM], [NTSC], [NTSC 4.43], [PAL-M] and [PAL-N].

Input menu

Y, Pb/Cb, Pr/Cr

Auto

The projector automatically detects an incoming video signal, and adjusts itself to optimize its performance.

Y, Pb/Cb, Pr/Cr SIGNAL FORMAT

If the projector cannot reproduce proper video image, select a specific component video signal format among [480i], [576i], [480p], [576p], [720p], [1 035i] [1 080i] and [1 080p].

- 1) Press ▲ ▼ to select [System].
- 2) Press ► or the <ENTER> button to access the submenu.
- 3) Press ▲ ▼ to select the desired system.

Note

- The AV System Menu cannot be selected when selecting [RGB (Scart)].

AUTO PC adjust

Select [PC adjust] from the Main Menu (see “Navigating through the menu” on page 46), then select the item from the sub-menu.

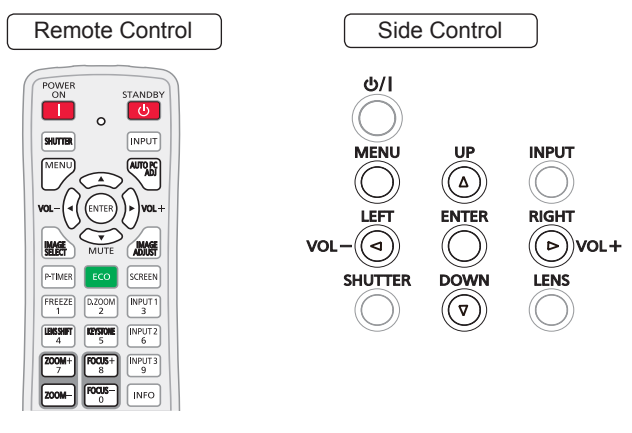

Auto PC adj.

Auto PC adjustment function is provided to automatically adjust [Fine sync], [Total dots], [Position H] and [Position V] to conform to your computer.

Press \blacktriangle \blacktriangledown to select [Auto PC adj.] and then press the <ENTER> button.

- [Please wait...] appears while the Auto PC adjustment is in process.

To store adjustment parameters

The adjusted parameters from the Auto PC adjustment can be stored in the projector. Once the parameters are stored, the setting can be done just by selecting a Mode (1–10) in the PC System Menu (see page 49). See also [Store] on page 53.

Attention

- [Fine sync], [Total dots], [Position H] and [Position V] of some computers cannot be fully adjusted with the Auto PC adjustment function. When the image is not provided properly with this operation, manual adjustments are required (► pages 52-53).
- The Auto PC adjustment cannot be operated when [480i], [576i], [480p], [576p], [720p], [1 035i] or [1 080i] is selected in the PC System Menu (► page 50), or when the signal is coming from the HDMI or DVI-D terminal.

Manual PC adjust

Select [PC adjust] from the Main Menu (see "Navigating through the menu" on page 46), then select the item from the sub-menu.

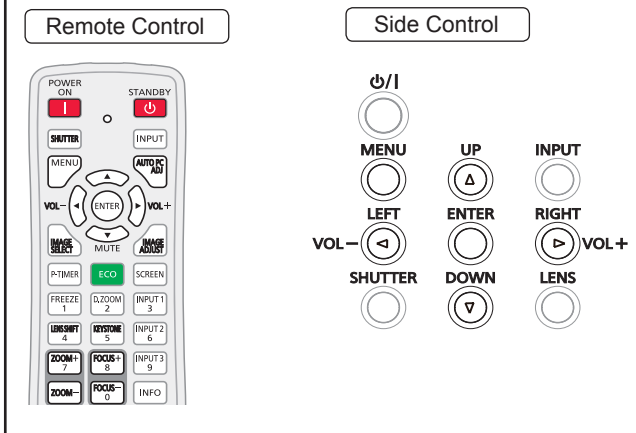

Some computers employ special signal formats which may not be tuned by Multi-scan system of this projector. Manual PC adjustment enables you to precisely adjust several parameters to match those signal formats. The projector has 10 independent memory areas to store those parameters manually adjusted. It allows you to recall the setting for a specific computer.

Fine sync

- 1) Press ▲ ▼ to select [Fine sync].
- 2) Press the <ENTER> button to display the adjustment dialog box.
- 3) Press ◀ ▶ to adjust the value.
 - The value can be adjusted from 0 to 31.

Total dots

- 1) Press ▲ ▼ to select [Total dots].
- 2) Press the <ENTER> button to display the adjustment dialog box.
- 3) Press ◀ ▶ to adjust the value.

Position H

- 1) Press ▲ ▼ to select [Position H].
- 2) Press the <ENTER> button to display the adjustment dialog box.
- 3) Press ◀ ▶ to adjust the horizontal picture position.

■ For horizontal (right and left) adjustment

Operation	Adjustment
Press ◀.	The picture position moves to the right.
Press ▶.	The picture position moves to the left.

Position V

- 1) Press ▲ ▼ to select [Position V].
- 2) Press the <ENTER> button to display the adjustment dialog box.
- 3) Press ◀ ▶ to adjust the vertical picture position.

■ For vertical (up and down) adjustment

Operation	Adjustment
Press ▶.	The picture position moves up.
Press ◀.	The picture position moves down.

Current mode

- 1) Press ▲▼ to select [Current mode].
- 2) Press ► or the <ENTER> button to enter the next submenu to show [H-sync freq.] and [V-sync freq.] of the connected computer.

Clamp

- 1) Press ▲▼ to select [Clamp].
- 2) Press the <ENTER> button to display the adjustment dialog box.
- 3) Press ◀▶ to adjust the clamp level.
 - When the image has dark bars, try this adjustment.

Display area H

- 1) Press ▲▼ to select [Display area H].
- 2) Press the <ENTER> button to display the adjustment dialog box.
- 3) Press ◀▶ to adjust the horizontal area displayed by this projector.

Display area V

- 1) Press ▲▼ to select [Display area V].
- 2) Press the <ENTER> button to display the dialog box.
- 3) Press ◀▶ to adjust the vertical area displayed by this projector.

Reset

To reset the adjusted data, all adjustments will return to their previous figures.

- 1) Press ▲▼ to select [Reset].
- 2) Press the <ENTER> button.
 - A confirmation box appears and then select [Yes].

Mode free

- 1) Press ▲▼ to select [Mode free].
- 2) Press ► or the <ENTER> button to enter the next submenu.
 - Move the highlight to the mode that you want to clear and then press the <ENTER> button. A confirmation box appears and then select [Yes].

Store

- 1) Press ▲▼ to select [Store].
- 2) Press ► or the <ENTER> button to enter the next submenu.
 - Move the highlight to one of the Modes 1 to 10 in which you want to store, and then press the <ENTER> button. A confirmation box appears and then select [Yes].

Image select

Select [Image select] from the Main Menu (see “Navigating through the menu” on page 46), then select the item from the sub-menu.

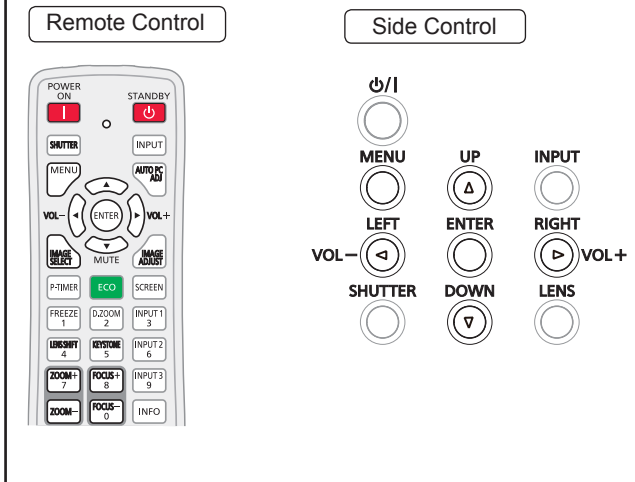

Note

- When you changed the image mode in the [Image select] menu, each item you have changed will return the factory default.

Dynamic

For viewing pictures in a bright room.

Press ▲ ▼ to select [Dynamic] and then press the <ENTER> button.

Standard

Normal picture mode preset on the projector.

Press ▲ ▼ to select [Standard] and then press the <ENTER> button.

Real

Picture mode with improved halftone for graphics.

Press ▲ ▼ to select [Real] and then press the <ENTER> button.

Cinema

Picture mode adjusted with fine tone.

Press ▲ ▼ to select [Cinema] and then press the <ENTER> button.

Natural

Natural picture level preset on the projector.

Press ▲ ▼ to select [Natural] and then press the <ENTER> button.

Image 1-10

For viewing with the user preset image mode in the Image adjust Menu.

Press ▲ ▼ to select [Image 1-10] and then press the <ENTER> button.

Image adjust

Select [Image adjust] from the Main Menu (see “Navigating through the menu” on page 46), then select the item from the sub-menu.

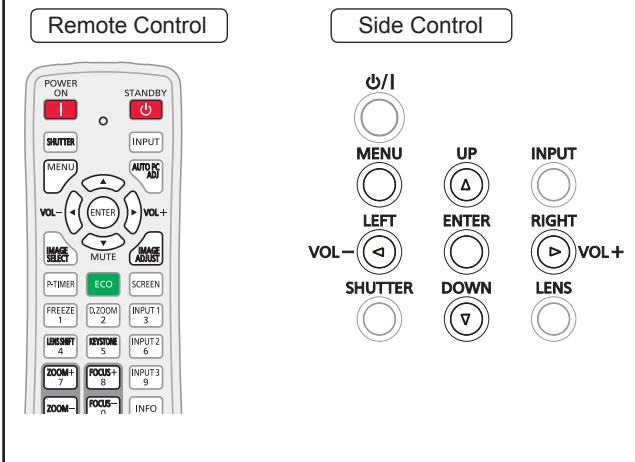

Note

- Make sure you selected [Store] after adjusting settings. Some settings can not be stored if not registered with [Store] function.
- After you changing the image mode via [Image select] menu, each item in [Image adjust] menu will return to factory default.

Contrast

- 1) Press ▲▼ to select [Contrast].
- 2) Press the <ENTER> button to display the adjustment dialog box.
- 3) Press ◀▶ to adjust the setting value.

Operation	Adjustment	Adjustment range
Press ▶.	increase the contrast	Maximum value 63
Press ◀.	decrease the contrast	Minimum value 0

Brightness

- 1) Press ▲▼ to select [Brightness].
- 2) Press the <ENTER> button to display the adjustment dialog box.
- 3) Press ◀▶ to adjust the setting value.

Operation	Adjustment	Adjustment range
Press ▶.	increase the brightness	Maximum value 63
Press ◀.	decrease the brightness	Minimum value 0

Color

- 1) Press ▲▼ to select [Color].
- 2) Press the <ENTER> button to display the adjustment dialog box.
- 3) Press ◀▶ to adjust the setting value.

Operation	Adjustment	Adjustment range
Press ▶.	increase the intensity of the color	Maximum value 63
Press ◀.	decrease the intensity of the color	Minimum value 0

Note

- When input video signal to the projector, [Color] will be available.

Tint

- 1) Press ▲▼ to select [Tint].
- 2) Press the <ENTER> button to display the adjustment dialog box.
- 3) Press ◀▶ to adjust the tint value to get a proper color balance.
 - Adjustments can be made between 0 and 63.

Note

- When you select [NTSC] or [NTSC4.43] in System menu under Video input signal, [Tint] will be available.

Iris

This iris function effectively increase the contrast intensity.

- 1) Press ▲▼ to select [Iris*].
- 2) Press the <ENTER> button to display the adjustment dialog box.
- 3) Press ◀▶ to select the desired items.

Off	Disabled
On	Contrast is prioritized over brightness.

* It is only for EZ570 series, EW630 series and EX600 series.

Image adjust

Color temp.

- 1) Press ▲ ▼ to select [Color temp.].
- 2) Press the <ENTER> button to display the adjustment dialog box.
- 3) Press ◀ ▶ to select the desired Color temp. level.
 - You can select the desired [Color temp.] from [XLow], [Low], [Mid] or [High].

Red

- 1) Press ▲ ▼ to select [Red].
- 2) Press the <ENTER> button to display the adjustment dialog box.
- 3) Press ◀ ▶ to adjust the setting value.

Operation	Adjustment	Adjustment range
Press ►.	deepen red tone	Maximum value 63
Press ◀.	lighten red tone	Minimum value 0

Green

- 1) Press ▲ ▼ to select [Green].
- 2) Press the <ENTER> button to display the adjustment dialog box.
- 3) Press ◀ ▶ to adjust the setting value.

Operation	Adjustment	Adjustment range
Press ►.	deepen green tone	Maximum value 63
Press ◀.	lighten green tone	Minimum value 0

Blue

- 1) Press ▲ ▼ to select [Blue].
- 2) Press the <ENTER> button to display the adjustment dialog box.
- 3) Press ◀ ▶ to adjust the setting value.

Operation	Adjustment	Adjustment range
Press ►.	deepen blue tone	Maximum value 63
Press ◀.	lighten blue tone	Minimum value 0

Offset

- 1) Press ▲ ▼ to select [Offset].
- 2) Press ► or the <ENTER> button to access the submenu.
- 3) Press ▲ ▼ to select the desired item and then press the <ENTER> button.
- 4) Press ◀ ▶ to adjust the setting value.

Operation	Adjustment	Adjustment range
Press ►.	deepen red/green/blue tone of the black level of an image	Maximum value 63
Press ◀.	lighten red/green/blue tone of the black level of an image	Minimum value 0

Daylight View

This function uses an ambient light sensor to detect the room's light intensity and adjust the projector output automatically to ensure a bright presentation.

- 1) Press ▲ ▼ to select [Daylight View].
- 2) Press the <ENTER> button to display the adjustment dialog box.
- 3) Press ◀ ▶ to switch between [Auto], [On] and [Off].

Note

- When [Rear] is set to [On], [Auto] is disabled.
- When this function is set to [On] or [Auto], the [Sharpness] is disabled.

Sharpness

- 1) Press ▲▼ to select [Sharpness].
- 2) Press the <ENTER> button to display the adjustment dialog box.
- 3) Press ◀▶ to adjust the setting value.

Operation	Adjustment	Adjustment range
Press ▶.	increase the sharpness of the image	Maximum value 31
Press ◀.	decrease the sharpness of the image	Minimum value 0

Note

- When [Daylight View] is set to [On] or [Auto], the function is disabled.

Gamma

- 1) Press ▲▼ to select [Gamma].
- 2) Press the <ENTER> button to display the adjustment dialog box.
- 3) Press ◀▶ to adjust the gamma value to obtain a better balance of contrast.
 - Adjustments can be made between 0 and 15.

Noise reduction

- 1) Press ▲▼ to select [Noise reduction].
- 2) Press the <ENTER> button to display the adjustment dialog box.
- 3) Press ◀▶ to select the desired item.

Off	Disabled
On	The function works

- Noise interference on the screen can be reduced. Select one of the above options to get smoother images.
- [Noise reduction] cannot be selected when [1 080p] is selected.

Note

- When input video signal to the projector, [Noise reduction] will become available.

Progressive

- 1) Press ▲▼ to select [Progressive].
- 2) Press the <ENTER> button to display the dialog box.
- 3) Press ◀▶ to select the desired item.
 - An interlaced video signal can be displayed in progressive mode. Select one of the following options.
 - [Progressive] cannot be selected when [480p], [576p], [720p] or [1 080p] is selected.

Off	Disabled
On	The function works
Film	For watching a film

Note

- When input video signal to the projector, [Progressive] will become available.

Reset

To reset the adjusted data, all adjustments will return to their previous figures.

- 1) Press ▲▼ to select [Reset].
- 2) Press the <ENTER> button.
 - A confirmation box appears and then select [Yes].

Note

- To reset the adjusted data except [Daylight View].

Store

- 1) Press ▲▼ to select [Store].
- 2) Press ▶ or the <ENTER> button.
- 3) Press ▲▼ to select one from Image 1 to 10 and press the <ENTER> button.
 - A confirmation box appears and then select [Yes].

Note

- To store the adjusted data except [Daylight View].
- Make sure you selected [Store] after adjusting settings. Some settings can not be stored if not registered with [Store] function.

Screen

Select [Screen] from the Main Menu (see “Navigating through the menu” on page 46), then select the item from the sub-menu.

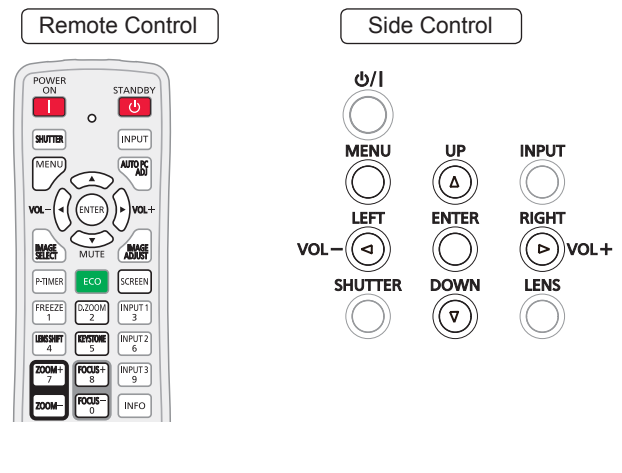

Normal

Provide the image to fit the screen size while maintaining the aspect ratio of the input signal.

Press **▲ ▼** to select [Normal] and then press the **<ENTER>** button.

Full

Provide the full screen image.

Press **▲ ▼** to select [Full] and then press the **<ENTER>** button.

Wide(16:9)

Provide the image at the 16:9 wide screen ratio.

Press **▲ ▼** to select [Wide(16:9)] and then press the **<ENTER>** button.

Zoom

Scale the image proportionally to fit the entire screen. Either side of image may go over the screen.

Press **▲ ▼** to select [Zoom] and then press the **<ENTER>** button.

True

Provide the image in its original size. When the original image size is larger than the panel size*, the projector enters to the panning mode automatically.

1) Press **▲ ▼** to select [True] and then press the **<ENTER>** button.

2) Press **▲ ▼ ◀ ▶** to pan the image.

- When adjusted, the arrows will turn red. When reached to the correction limits, the arrows will disappear.

*Different models have different Panel sizes.

Panel size	Model
1 920 x 1 200	EZ570 series
1 280 x 800	EW630 series, EW530 series
1 024 x 768	EX600 series, EX500 series

Note

- When input computer signal to the projector, [True] will be available.
- [True] is disabled and cannot be displayed when [480i], [576i], [480p], [576p], [720p], [1 035i] or [1 080i] is selected in the PC System Menu.
- When [True] is selected in the Screen menu, [Digital zoom +/-] cannot be selected.

Natural wide

Modify the 4:3 aspect ratio image to fit the screen size by stretching the image to make it look natural.

Press **▲ ▼** to select [Natural wide*] and then press the **<ENTER>** button.

*This function is not available for EX600 series, EX500 series.

Note

- When input video signal to the projector, [Natural wide] will be available.
- [Natural wide] is not available when [720p], [1 035i] or [1 080i] is selected in the PC System Menu.

Custom

Provide the last stored aspect screen image.

Press **▲ ▼** to select [Custom] and press the **<ENTER>** button.

Custom adj.

Adjust the screen scale and position manually with this function.

- 1) Press **▲▼** to select **[Custom adj.]**.
- 2) Press **▶** or the **<ENTER>** button to enter the next submenu.
- 3) Press **▲▼** to choose the item you want to adjust.
 - You can choose one from the items as below:

Scale H/V	Adjust the Horizontal/Vertical screen scale.
H&V	When set to [On], the aspect ratio is fixed.
Position H/V	Adjust the Horizontal/Vertical screen position.
Common	Save the adjusted scale or position to all the inputs.
Reset	Reset the all adjusted values.

Digital zoom +

Zoom in the images.

- 1) Press **▲▼** to select **[Digital zoom +]** and then press the **<ENTER>** button.
 - The On-Screen Menu disappears and [D. zoom +] appears.
- 2) Press the **<ENTER>** button to zoom in the image size and press **▲▼ ◀▶** to move the image to the top/bottom/left/right of the screen.
 - The Panning function can work only when the image is larger than the screen size. A projected image can be also expanded by pressing the **<D.ZOOM >** or the **<ENTER>** button.

Digital zoom -

Zoom out the images.

- 1) Press **▲▼** to select **[Digital zoom -]** and then press the **<ENTER>** button.
 - The On-Screen Menu disappears and [D.zoom -] appears.
- 2) Press the **<ENTER>** button to zoom out image size.
 - The projected image can be also compressed by pressing the **<D.ZOOM >** or the **<ENTER>** button.

To exit the Digital zoom +/- mode, press any button except the **<D.ZOOM >**, **<ENTER>** and **▲▼◀▶** buttons.

To return to the previous screen size, select a screen size from the Screen Size Adjustment Menu or select an input source from the Input Source Selection Menu (➔page 49) again, or adjust the screen size with the **<D.ZOOM >** button.

Note

- When input computer signal to the projector, this function will be available.
- [Digital zoom +/-] cannot be selected when [True] is selected in the Screen aspect.
- [Digital zoom +/-] are disabled and cannot be displayed when [480i], [576i], [480p], [576p], [720p], [1 035i] or [1 080i] is selected in the PC System Menu (➔page 50).
- When [Digital zoom +/-] functions are disabled, **!** mark will appear.

Keystone

This function is used to adjust keystone distortion of the projected image.

- 1) Press **▲▼** to select **[Keystone]**.
- 2) Press **▶** or the **<ENTER>** button.
- 3) Press **▲▼** to choose the item you want to adjust.

Standard	Adjust the Horizontal/Vertical keystone distortion of the projected image.*1
Corner correction	Adjust the corner distortion of the projected image.
Corner pattern	Choose a Corner pattern mode among [Red], [White], [Blue], and [Off].
Store	To store or reset the keystone correction.



The following items are the submenus of [Store].

Store	Keep the keystone correction even when the AC power cord is plugged out or turned off the projector.
Reset	Release the keystone correction when the AC power cord is plugged out.

*1 : Adjust the Vertical keystone distortion of the projected image.

Note

- For details, see "Using the KEYSTONE button" of "Basic operation by using the remote control" (➔page 44).

Screen

Ceiling

This function is used to project the image from a ceiling-mounted projector.

- 1) Press ▲ ▼ to select [Ceiling] and then press the <ENTER> button.
- 2) Press ▲ ▼ to change the image.
 - When this function is set to [On], the picture will be top/bottom and left/right reversed.

Rear

This function is used to project the image from rear of the screen.

- 1) Press ▲ ▼ to select [Rear] and then press the <ENTER> button.
- 2) Press ▲ ▼ to change the image.
 - When this function is set to [On], the picture will be left/right reversed.

Screen aspect

This function is used to project the image to a 4:3 or 16:9 projection screen.

- 1) Press ▲ ▼ to select [Screen aspect*] and then press the <ENTER> button.
- 2) Press ▲ ▼ to choose one from the items as below.

*This function is not available for EX600 series, EX500 series.

Default(16:10)	16:10 is the aspect of the LCD panel.
16:9	Set to a 16:9 projection screen.
4:3	Set to a 4:3 projection screen.

Note

- When the [4:3] function is selected, [Natural wide] is not available in the AV screen.
- When the [16:9] function is selected, [Wide (16:9)] is not available in the AV screen.

Reset

To reset the adjusted data, all adjustments will return to their previous figures.

Press ▲ ▼ to select [Reset] and then press the <ENTER> button.

- A confirmation box appears and then select [Yes].

Sound

Select [Sound] from the Main Menu (see “Navigating through the menu” on page 46), then select the item from the sub-menu.

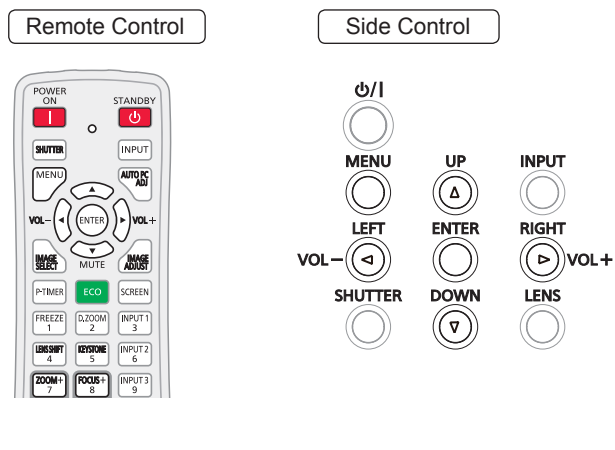

Mute

- 1) Press ▲ ▼ to select [Mute].
- 2) Press the <ENTER> button to switch the mute function between [On] and [Off].
 - Press the <MUTE> button on the remote control to temporarily turn off the sound. To turn the sound back on, press the <MUTE> button again or press the <VOL> (-/+) buttons.

On	turn off the sound
Off	turn on the sound

Volume

- 1) Press ▲ ▼ to select [Volume] and then press the <ENTER> button.
- 2) Press ◀ ▶ to adjust the volume.
 - Press <ENTER> button to set the volume.

Operation	Adjustment	Adjustment range
Press ▶.	turn up the volume	Maximum value 63
Press ◀.	turn down the volume	Minimum value 0

- You can also press <VOL> (-/+) buttons on the remote control or side control to adjust the volume.

Built-in SP

- 1) Press ▲ ▼ to select [Built-in SP] and then press the <ENTER> button.
- 2) Press ▲ ▼ to switch the [Built-in SP] function between [On] and [Off].

Off	When the Built-in SP sound is turned off
On	[Mute] is cancelled

Setting

Select [Setting] from the Main Menu (see “Navigating through the menu” on page 46), then select the item from the sub-menu.

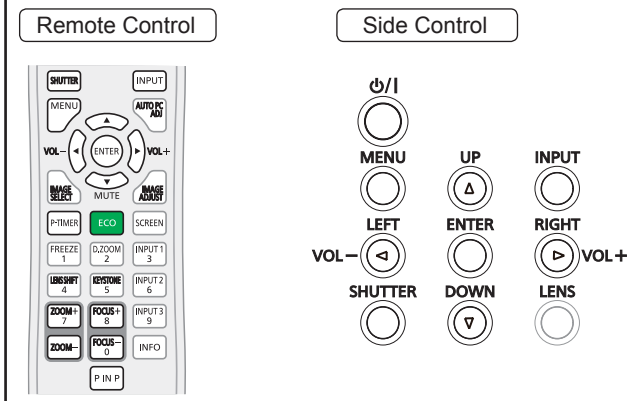

Language

- 1) Press ▲ ▼ to select [Language].
- 2) Press ► or the <ENTER> button.
- 3) Press ▲ ▼ to select the desired language.

For example: PT-EZ570E

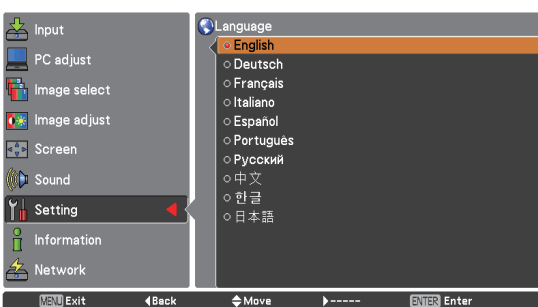
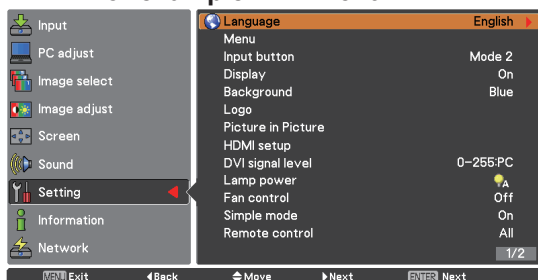

- The language used in the On-Screen Menu is available in English, German, French, Italian, Spanish, Portuguese, Russian, Chinese, Korean, and Japanese.

Menu/Menu position

[Menu] function is only for EZ570 series.
[Menu position] function is only for EW630 series, EW530 series, EX600 series and EX500 series.

Position

This function is used to change the position of the On-Screen Menu.

- 1) Press ▲ ▼ to select [Position].
- 2) Press the <ENTER> button to change the position.

- The Position changes each time you press <ENTER> button as follows:

the center → the bottom left → the bottom right → the top left → the top right → the center.....

Menu size*1

This function is used to change the display size of the On-Screen Menu.

- 1) Press ▲ ▼ to select [Menu size] and press the <ENTER> button.
- 2) Press ▲ ▼ to switch the [Menu size] function between [Normal] and [Double].

Normal	Display the On-Screen Menu on the screen in its normal size.
Double	Display the On-Screen Menu on the screen in its double normal size.

*1 : This function is only for EZ570 series.

Input button

This function detects the input signal automatically. When a signal is found, the search will stop.

- 1) Press ▲ ▼ to select [Input button].
- 2) Press the <ENTER> button.
- 3) Press ▲ ▼ to select these functions as follows:

Mode 1	Input search will not work*1
Mode 2	Input search works*2
Mode 3	Input search works*3

*1 : Input search will not work.

*2 : Input search works under the following situation:

- When pressing the <INPUT> button on the remote control or on the side control.

*3 : Input search works under the following situation:

- When turning on the projector by pressing the <POWER ON> button on the remote control or the <POWER ON> button on the side control.
- When pressing the <INPUT> button on the remote control or the side control.
- When no signal is detected.

Display

This function decides whether to display On-Screen Displays.

- 1) Press ▲▼ to select [Display].
- 2) Press the <ENTER> button.
- 3) Press ▲▼ to switch between each option as below.

On	Show all the On-Screen displays *1
Countdown off	Show the input image instead of the countdown when turning on the projector *2
Off	Hide the On-Screen Displays *3

- *1 : Use this function when you want to project images after the lamp becomes bright enough. The factory default setting is in this option.
- *2 : Use this function when you want to project the image as early as possible even when the lamp is not bright enough.
- *3 : Hide the On-Screen Displays except;
- On-Screen Menu.
 - [Power off?]
 - [P-timer] display.
 - No signal for [Power management]
 - [Please wait ...]
 - [Picture in Picture]
 - [Simple mode]
 - [Video delay control]
 - Arrows for the [True] function in the Screen Menu.
 - [Service]

Background

Select the background screen for when no input signal is detected.

- 1) Press ▲▼ to select [Background].
- 2) Press the <ENTER> button.
- 3) Press ▲▼ to switch between each option as below.

Blue	Blue colored background.
User	The logo transferred by "Logo Transfer Software *1 " is projected.
Black	Black colored background.

- *1 : "Logo Transfer Software" is included on the supplied CD-ROM.

Logo

This function allows you to customize the screen logo with [Logo select], [Logo PIN code lock] and [Logo PIN code change] functions.

- 1) Press ▲▼ to select [Logo].
- 2) Press ► or the <ENTER> button.
- 3) Press ▲▼ to choose the desired item.

■ Logo select

This function decides on the starting-up display from among following options.

Off	Show the countdown display only.
Default	Show the factory-set logo.
User	The logo transferred by "Logo Transfer Software *1 " is projected.

- *1 : "Logo Transfer Software" is included on the supplied CD-ROM.

■ Logo PIN code lock

This function prevents an unauthorized person from changing the screen logo.

Off	The screen logo can be changed freely from the Logo Menu.
On	The screen logo cannot be changed without a Logo PIN code.

Note

- If you want to change the Logo PIN code lock setting, press the <ENTER> button and the Logo PIN code dialog box appears. Enter a Logo PIN code by following the steps below. The initial Logo PIN code is set to "4321" at the factory.

■ Logo PIN code change

Logo PIN code can be changed to your desired four-digit number.

- 1) Press ▲▼ to select [Logo PIN code change] and press the <ENTER> button.
 - Current logo PIN code dialog box appears.
- 2) Press ▲▼ to enter the current code, press the ► button to fix the number and move the red frame pointer to the next box.
 - The New Logo PIN code input dialog box appears.
- 3) Repeat this step to set the new Logo PIN code.

Attention

- Be sure to note the new Logo PIN code and keep it on hand. If you lost the number, you could no longer change the Logo PIN code setting.

Picture in Picture

This function is used to project two images simultaneously by placing a separate small sub screen within or next to the main screen.

1) Press ▲ ▼ to select [Picture in Picture*].

- You can also press the <P IN P>button on the remote control for more than 3 seconds to display [Picture in Picture] menu.

2) Press the <ENTER> button to access the submenu.

- Only the sound from the source of Main picture is valid, while the source of Sub picture cannot output the sound.

*(Only for EZ570 series, EW630 series and EW530 series.)

■ User setting

Show the selected mode ([Off/User 1-5]) and its status ([Stored /Free/ Adj.]). [User 1] and [User 2] have stored default values.

■ P in P/P by P

P IN P	Provide the images of Main picture and Sub picture at the ratio of Screen aspect in the Screen Menu.
P by P	Provide the images of Main picture and Sub picture at the ratio of 4:3.

Note

- In [P in P] the larger picture is main picture, and the smaller one is sub picture; in [P by P], the left picture is main picture, and the right one is sub picture.

■ Main picture/ Sub picture

1) Press ▲ ▼ ◀ ▶ to adjust the display position of active frame indicated in white.

- The frame will disappear after 10 seconds or when the <ENTER> button is pressed.

Input	Select an input from Input 1-3.
Source	Select an input source.
Size	Select the display size.
Position	Press the <ENTER> button at Position and the display position setting screen appears.

● Selecting the Main picture or the Sub picture

During Picture in Picture mode, and being undisplayed On Screen Menu, press the <ENTER> button to select Main or Sub picture. (A red frame will be displayed on the selected picture.)

● Switching Input and Source

When selecting Main picture or Sub picture, input and source can be set by pressing the <INPUT> button on the side control or INPUT 1/2/3 button on the remote control. Operation on the On Screen Menu is not necessary.

■ Frame lock

Set the Frame Lock to Main picture or Sub picture.

■ Reset

Press the <ENTER> button at [Reset] to display a confirmation box. To reset, press the <ENTER> button at [Yes].

■ Mode free

Delete the data stored in the Mode and return to [Free]. Use the ▲ ▼ buttons to select [Mode free] and press the <ENTER> button to show the [Where to free?] dialog box. Move the highlight to one of the mode ([User 1 - 5]) which you want to delete and press the <ENTER> button. Then the confirmation box appears. To delete, select [Yes].

■ Store

Store the adjusted data in the [User 1-5]. Use the ▲ ▼ buttons to select [Store] and press the <ENTER> button to show the [Where to store?] dialog box. Move the highlight to one of the mode (User 1 - 5) which you want to store and press the <ENTER> button. Then the confirmation box appears. To store adjusted data, select [Yes].

Note

- The [Picture in Picture] function is not available depending on the input signals and the selected input terminals.
- When the input signal(s) is/are incompatible, x mark will be displayed on the Main/Sub picture.

HDMI setup

This function is only used for HDMI input source.

- 1) Press **▲▼** to select **[HDMI setup]**.
- 2) Press **▶** or the **<ENTER>** button.
 - The names for the output setting of Digital R/G/B vary from equipment to equipment.

HDMI signal level

64-940	When the output of Digital R/G/B equipment is set to Standard.
0-1023	When the output of Digital R/G/B equipment is set to Enhanced.

Sound

HDMI	When Digital input source is input, Sound is set to HDMI.
AUDIO 1	When DVI input source is changed to HDMI input source, Sound is set to AUDIO 1 .

Note

- For details, refer to the operating instructions of your Digital R/G/B equipment.

DVI signal level

This function is only used for DVI-D input source.





- 1) Press **▲▼** to select **[DVI signal level]** and then press the **<ENTER>** button.
- 2) Press **▲▼** to switch the item.

16-235	When you want to enhance the weakened signal.
0-255:PC	When in normal condition.

Lamp power

This function allows you to change brightness of the screen.

- 1) Press **▲▼** to select **[Lamp power]** and then press the **<ENTER>** button .
- 2) Press **▲▼** to select one among the modes as below.

 Auto	Brightness according to the input signal.
 Normal	The lamp power output is maximum.
 Eco1	The lamp power output is 80% of the Normal mode.
 Eco2	The lamp power output is 30% - 80% of the Normal mode.

Fan control

- 1) Press **▲▼** to select **[Fan control]** and then Press **<ENTER>** button.
- 2) Press **▲▼** to select one among options as below.
 - Choose the running speed of cooling fans from the following options according to the ground elevation under which you use the projector.

Off	Normal speed.*1
On 1	Faster than [Off] mode.*2
On 2	Faster than [On 1] mode.*3

- *1 : Set this function to [Off] when using the projector in non-high altitude environment.
- *2 : Select [On 1] when using the projector in high altitudes (about 1 000 m ~ 2 000 m or more above the sea level) where the fans have less cooling effect.
- *3 : Select [On 2] when using the projector in higher altitudes (about 2 000 m ~ 2 700 m or more above the sea level) where the fans have lesser cooling effect.

Note

- Failure to set the running speed of cooling fans properly may affect the projector life.
- The fan noise becomes louder in [On 1] and [On 2].

Setting

Simple mode

This function decides whether to activate the simple mode.

- 1) Press ▲ ▼ to select [Simple mode] and then press the <ENTER> button.
- 2) Press ▲ ▼ to switch between [On] and [Off].

On	Only the simple mode buttons are active.
Off	Simple mode function is off.

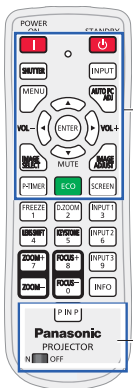

Only these buttons are active when the simple mode is set to [On]. [POWER ON, STANDBY, SHUTTER (AV MUTE), INPUT, MENU, AUTO PC ADJ., ▲, ▼ (MUTE), ◀ (VOLUME-), ▶ (VOLUME+), ENTER, IMAGE SELECT, IMAGE ADJUST, P-TIMER, ECO, SCREEN, P IN P, ON /OFF]. Number buttons also become active only when setting the remote control codes numbers or entering the PIN code numbers.

Note

- Warning icon and  [Simple mode : On] message appear on the screen for about 4 seconds when press the button which is not the simple mode button.

Remote control

This switching function prevents remote control interference when operating several projectors or video equipment at the same time.

- 1) Press ▲ ▼ to select [Remote control].
- 2) Press the <ENTER> button.
- 3) Press ▲ ▼ to select one among the sixty and five codes.
 - This projector provides 65 different remote control codes: [All], [Code 01]~[Code 64].

Note

- When operating the projector under [All] code, you can operate several projectors at the same time. If you want to operate the projector independently, you must switch to other code.
- When different codes are set on the projector and on the remote control, any operation cannot be made. In that case, switch the code on the remote control to fit the code on the projector.

RC sensor

Select a location of the infrared remote receiver of the remote control.

- 1) Press ▲ ▼ to select [RC sensor].
- 2) Press ▶ or the <ENTER> button.
- 3) Press ▲ ▼ to select one among options as below.

All	Activate all of the receivers.
Front & Top	Activate both the front and top receivers.
Top & Back	Activate both the top and back receivers.
Front & Back	Activate both the front and back receivers.
Front	Activate only the front receiver.
Top	Activate only the top receiver.
Back	Activate only the back receiver.

Eco management

Can optimize lamp power and reduce the power consumption according to the application.

- 1) Press ▲ ▼ to select [Eco management].
- 2) Press ▶ or the <ENTER> button.

Auto power save

- 1) Press ▲ ▼ to select [Auto power save] and press the <ENTER> button.
- 2) Press ▲ ▼ to choose [On] between [On] and [Off].
- 3) Press ▲ ▼ to select auto power save conditions.

Ambient light detection	Adjusts the lamp power according to the ambient brightness.
Signal detection	Drops the lamp power when no signal is input.
AV mute detection*1	Drops the lamp power in the AV mute mode.

*1 : This function is only for EW530 series and EX500 series.

Note

- When [Auto power save] is [Off], [Ambient light detection], [Signal detection] and [AV mute detection] are not available.

Power management

For reducing power consumption as well as maintaining the lamp life, the Power management function turns off the projection lamp when the projector is not operated for a certain period.

- 1) Press ▲▼ to select [Power management].
- 2) Press ► or the <ENTER> button to access the submenu.

■ Mode

- 1) Press ▲▼ and then press the <ENTER> button to select one mode among the items as below.

Ready	When the lamp has been fully cooled down, the <ON(G)/STANDBY(R)> indicator changes to green blinking. In this condition, the projection lamp will be turned on if the input signal is reconnected or any button on the side control or remote control is pressed.
Shut down	When the lamp has been fully cooled down, the power will be turned off.
Off	[Power management] function is off.

■ Timer

- 1) Press ▲▼ to select [Timer] and then press the <ENTER> button.
- 2) Press ▲▼ to set the Timer(1~30min).

Standby mode

This function can set the electric power when the projector is standing by.

- 1) Press ▲▼ to select [Standby mode] and then press the <ENTER> button.
- 2) Press ▲▼ to switch between the items as below.

Normal	The normal situation.
Eco	The power less than 0.5W.
Network	The power less than Normal.

Note

- When selecting [Network], the cooling fans may be running depending on the temperature inside the projector even if the projector is turned off.

- If [Standby mode] is set to [Eco], you cannot use network functions when the projector is standing by. Also, you cannot use some RS-232C protocol commands.
- If set to [Network], you can use network functions when the projector is standing by.

Direct on

- 1) Press ▲▼ to select [Direct on] and then press the <ENTER> button.
- 2) Press ▲▼ to switch between [On] and [Off].

- When this function is set to [On], the projector will be automatically turned on just by connecting the AC power cord to a wall outlet.
- Be sure to turn off the projector properly. If the projector is turned off in the incorrect sequence, the [Direct On] function does not work properly.

P-timer

This function allows you to change the setting of the P-timer and execute it.

- 1) Press ▲▼ to select [P-timer].
- 2) Press ► or <ENTER> button to access the submenu.

■ Mode

- 1) Press ▲▼ button to select one mode among the items as below.

Count up	The P-timer display 000:00 appears on the screen and the count up starts (000:00-180:00).
Count down	The time set in the Timer setting appears on the screen and the countdown starts.

■ Timer

- 1) Press ▲▼ to select [Timer] and then press the <ENTER> button.
- 2) Press ▲▼ to set the [Timer](1-180 Min).
 - [Timer] is available in [Count down] only. Factory default value is 10 Min.

Execute

- 1) Press ▲ ▼ to select one among the items as below and then press the <ENTER> button.

Start	It executes the count up or count down function.*1
Reset	Reset the P-timer values.*2
Exit	To exit the P-timer operation.

- *1 : Press the <ENTER> button at Start and the indication changes into Stop. To stop Count up or Count down, press the <ENTER> button at Stop on the screen menu, then the indication changes into Restart. Press the <ENTER> button at Restart to resume Count up or Count down.
- *2 : Press the <ENTER> button at Reset to return to the following value:

Count up	"000:00"
Count down	Timer that you set

Attention

- To stop the [P-timer] function, press the <P-TIMER> button.
- To cancel the [P-timer], press and hold the <P-TIMER> button for a few seconds.

Security

This function allows you to use the [Key lock] and [PIN code lock] function to set the security for the projector operation.

- 1) Press ▲ ▼ to select [Security].
- 2) Press ► or the <ENTER> button to access the submenu.

Key lock

This function locks the side control and remote control buttons to prevent operation by unauthorized persons.

- 1) Press ▲ ▼ to select the desired items as below.

	Unlocked.
	Lock the operation of the side control. To unlock, use the remote control.
	Lock the operation of the remote control. To unlock, use the side control.

PIN code lock

This function prevents the projector from being operated by unauthorized persons and provides the following setting options for security.

- 1) Press ▲ ▼ to select the desired items as below.

Off	Unlocked.
On 1	Enter the PIN code every time turning on the projector.
On 2	Enter the PIN code to operate the projector once the power cord is disconnected; as long as the AC power cord is connected, the projector can be operated without a PIN code.

Attention

- Whenever you change the PIN code lock setting or the PIN code (the four-digit number), you are required to enter the PIN code. The "1234" is set as the initial PIN code at the factory.

PIN code change

The PIN code can be changed to your desired four-digit number.

- 1) Press ▲ ▼ to select [PIN code change] and then press <ENTER> button.
 - Current Pin code dialog box appears.
- 2) Press ▲ ▼ to enter the current code. Press ► button to fix the number and move the red frame pointer to the next box.
 - The New PIN code input dialog box appears.
- 3) Repeat these steps to set a new PIN code.

Shutter

Shutter function is available to block out light to the screen, so that the screen can be used for the other presenters.





- 1) Press ▲ ▼ to select [Shutter*].
- 2) Press ► or the <ENTER> button to access the submenu.

*(Only for EZ570 series, EW630 series and EX600 series.)

Protection

Prohibit the shutter operation from the remote control and the projector's side control.

1) Press **▲▼** to select the desired items as below.

	Permit the shutter operation from both the remote control and the projector's side control.
	Prohibit the shutter operation from the remote control.
	Prohibit the shutter operation from the side control.
	Prohibit the shutter operation from both the remote control and the projector's side control.

■ Release key

By using the Release key function from the following options, the Shutter can be released when it stays activated.

Any	By pressing any button on the projector's side control or the remote control, the shutter can be released when it is closed, and meanwhile the function of the selected item will come into effect.
SHUTTER	Only by pressing the <SHUTTER> button on the projector's side control or the remote control the shutter can be released when it is closed.*1

*1 : In addition, when the [Shutter] is functioning, only the following buttons are active:

- <INPUT> button and  button on the projector's side control.
- <INPUT 1/2/3> buttons and <STANDBY> button on the remote control.

■ Management

The Shutter Management function turns off the projection lamp when the projector is left with the shutter closed and the set time has passed away. The count-down time can be set between 5 and 480 minutes. When the count-down time has elapsed, the shutter will be opened up automatically and the lamp will be turned off to cool itself down. The <SHUTTER> indicator is blinking blue during this cooling-off period. When the lamp has been fully cooled down, the <ON(G)/STANDBY(R)> indicator turns green lighting and the <SHUTTER> indicator keeps blinking. Should the  button be pressed in this condition, the projection lamp will be turned on and the <SHUTTER> indicator turns off.

Closed caption

[Only for NTSC, 480i input]

- 1) Press **▲▼** to select [Closed caption].
- 2) Press **▶** or the <ENTER> button to enter the submenu.

■ Closed caption

- 1) Press **▲▼** to select [Closed caption] and then press the <ENTER> button.
- 2) Press **▲▼** to select [Off], [CC1], [CC2], [CC3] or [CC4].

■ Color

- 1) Press **▲▼** to select [Color] and then press the <ENTER> button.
- 2) Press **▲▼** to select color or white.

Note

- The closed caption is mainly used in the north America. This function shows the text information contained in the image signal. Captions may not be displayed on some devices or software.
- You can select [Closed caption] when [NTSC] or [480i] signals are input.
- Part of characters may not displayed when high compensation values are set in [Keystone].
- Closed captions are not displayed while the menu screen appears.

Video delay control

This function allows you to make a digital processing of a projected image faster.

- 1) Press **▲▼** to select [Video delay control] and then press the <ENTER> button.
- 2) Press **▲▼** to select one item between [Off], [Low], [Mid] and [High]*.

*When this function is for these models (EW530 series and EX500 series), it only can switch between [On] and [Off].

Note

- [Noise reduction] and [Progressive] cannot be selected when [Video delay control] function is set to [On].
- The following functions are not available respectively when [Video delay control] is set to [Low]/[Mid]/[High].
Low ... [Keystone] cannot be selected.
Mid ... [Progressive] and [Noise reduction] cannot be selected.
High .. [Keystone], [Progressive] and [Noise reduction] cannot be selected.
- When [Video delay control] function is set to [Low] or [High] and press the <KEYSTONE> button on the remote control, [Video delay :On] will be displayed on the bottom left screen.

Setting

Filter counter

This function is used to set the frequency of cleaning or replacing the filter unit.

- 1) Press ▲ ▼ to select [Filter counter].
- 2) Press ► or the <ENTER> button to access the submenu items.

■ Filter counter

Show the total accumulated time of the filter use timer setting.

■ Filter counter remaining



The remaining time for the filter counter is displayed in units of 10%.

- This is displayed in red when the remaining time is 10%.



■ Filter counter timer

To set a timer. When the projector reaches the selected time the filter warning icon appears on the screen.

- 1) Press ▲ ▼ to select [Filter counter timer] and then press the <ENTER> button.
- 2) Press ▲ ▼ to set the timer.
 - Select from [Off/1000 H/2000 H/3000 H/4000 H/6000 H/8000 H/9000 H/12000 H] depending on the use environment.
 - The situation which different icons appear as below shown:

	When the remaining time is less than 10%.
	When the remaining time is 0, the filter replacement is necessary.
	When the projector reaches a time set by user in the timer setting.

Attention

- [Filter counter remaining] disappears,  will be displayed.  appeared about 10 hours later, and powered on the projector about 3 minutes later, the projector will power off automatically and enter the standby mode in order to protect the inner parts of the projector. When  is displayed, please clean or replace the air filter units as soon as possible and then reset the [Filter counter].

■ Filter counter reset

After cleaning or replacing the filter unit, be sure to reset the timer.

- 1) Press ▲ ▼ to select [Filter counter reset].
- 2) Press the <ENTER> button.
 - [Filter counter Reset?] appears. Select [Yes] to continue. Another confirmation dialog box appears, select [Yes] to reset the [Filter counter].

Test pattern

Results of adjustment of the position, size and other factors are not reflected in test patterns. Ensure the input signal is displayed before performing various kinds of setting.

- 1) Press ▲ ▼ to select [Test pattern].
- 2) Press ► or the <ENTER> button to access the submenu items.
- 3) Press ▲ ▼ to go backwards and forwards between test patterns as below.
 - [Color], [Gradation 1], [Gradation 2], [Gradation 3], [Gradation 4], [All white], [All black] and [Cross].

Note

- Even while the test pattern is displayed, the zoom, focus, lens shift, shutter, and power off functions take priority.

Factory default

This function returns all setting values except for [PIN code lock], [Logo PIN code lock] and [Filter counter] to the factory default settings.

- 1) Press ▲ ▼ to select [Factory default].
- 2) Press the <ENTER> button.
 - [Return to Factory default?] appears. Select [Yes] to continue. Another confirmation dialog box appears, select [Yes] to return to [Factory default].

Information

Select [Information] from the Main Menu (see “Navigating through the menu” on page 46), then select the item from the sub-menu.

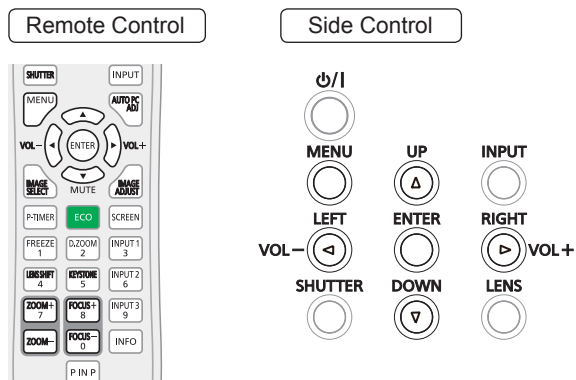

Input Source Information Display

The Information Menu is used for checking the status of the image signal being projected and the operation of the projector.

You can also press the <INFO> button on the remote control to display the Information menu.

■ Input

The selected input source is displayed.

■ System

The selected system is displayed.

■ H-sync freq.

The selected H-sync freq. is displayed.

The horizontal frequency of the input signal is displayed in kHz, or - - - kHz when no signal.

■ V-sync freq.

The selected V-sync freq. is displayed.

The vertical frequency of the input signal is displayed in Hz, or - - - Hz when no signal. Numbers of Hz doubles when during Interlace.

■ Screen

The selected Screen size is displayed.

■ Language

The selected language is displayed.

■ Lamp power

The selected lamp mode is displayed.

■ Lamp runtime

The cumulative lamp operating time is displayed.

■ Filter counter

The filter using time filter is displayed.

■ Power management

[Off], [Ready] or [Shut down], and [Timer] are displayed.

■ Key lock

The selected Key lock icon is displayed.

■ PIN code lock

[Off], [On 1] or [On 2] is displayed.

■ Shutter management*

To display the setting of [Protection] and time.

*(Only for EZ570 series, EW630 series and EX600 series.)

■ Simple mode

To display the configuration of a simple remote control mode.

■ Remote control

The selected remote control code is displayed.

■ Serial number

The serial number of the projector is displayed.

The serial number is used to service the projector.

Network

Select [Network] from the Main Menu (see “Navigating through the menu” on page 46), then select the item from the sub-menu.

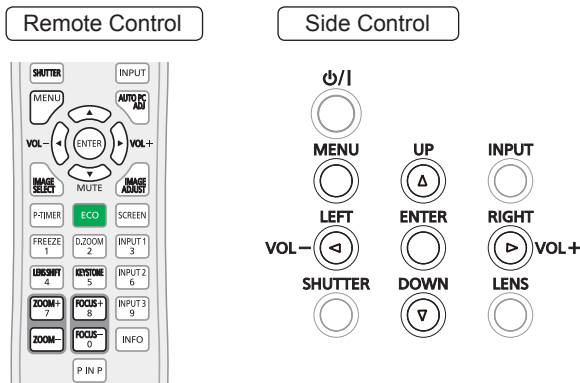

Projector name

You can change the projector name to be displayed on the network.

- 1) Press ▲▼ to select [Projector name].
- 2) Press the <ENTER> button.
- 3) Press ▲▼◀▶ buttons to set the [Projector name].

Network setup

You can make detailed wired LAN settings.

- 1) Press ▲▼ to select [Network setup], and press <ENTER> button.
- 2) Press ▲▼ to select an item, and change the setting according to the instructions.

DHCP (DHCP client function)	On: If a DHCP server exists in the network to which the projector is connected, the IP address will automatically be acquired. Off: If a DHCP server does not exist in the network to which the projector is connected, additionally set [IP address], [Subnet mask] and [Default gateway].
IP address (Display of IP address and setting)	Enter the IP address if DHCP server is not used.
Subnet mask (Displaying and setting the subnet mask)	If not using a DHCP server, enter the subnet mask

Default gateway (Display of gateway address and setting)	Enter the gateway address if DHCP server is not used.
DNS1 (Display of Preferred DNS server address and setting)	Enter the DNS server address if DHCP server is not used.
DNS2 (Display of Alternate DNS server address and setting)	Enter the alternate DNS server address if DHCP server is not used.

3) Press ▲▼◀▶ to select [Set], and press <ENTER> button.

- Default wired LAN settings
The following settings are set before the projector leaves the factory.

DHCP	Off
IP address	192.168.10.100
Subnet mask	255.255.255.0
Default gateway	192.168.10.1
DNS 1/DNS 2	NONE

Note

- Before using the DHCP server, make sure the DHCP server is already functioning.
- For details of IP address, subnet mask, gateway and DNS, ask the network administrator.

Network control

Set when you want to control the projector from a computer connected to the network.

- 1) Press ▲▼ to select [Network control].
- 2) Press ▶ or the <ENTER> button to access the submenu items.
- 3) Press ▲▼ to select one item and press ◀▶ to switch the function between [On] and [Off].

WEB control	Set to [On] to control with the Web browser.
PJLink control	Set to [On] to control with the PJLink protocol.
Command control	Set to [On] to control with the SERIAL IN terminal control command format.
AMX D. D.	Set to [On] to control with the AMX Device Discovery.
RoomView	Set to [On] to control with the Crestron RoomView®.

This projector supports the following application software from Crestron company.

- RoomView® Express
- Fusion RV™
- RoomView® Server Edition

"Crestron RoomView" is a system developed by Crestron Electronics, Inc. which collectively manage and control multiple system devices connected via the network, from a computer. This projector supports "Crestron RoomView".

- For details of "RoomView", refer to the Crestron Electronics, Inc. website. (Provided only in English.).

<http://www.crestron.com>.

For the download of "Crestron RoomView Express", refer to the Crestron Electronics, Inc. website. (Provided only in English.).

<http://www.crestron.com/getroomview>.

Note

- For more details about the AMX Device Discovery, please visit:
<http://www.amx.com>.

Network status

This function shows the LAN setting environment of the currently selected projector.

- 1) Press **▲▼** to select **[Network status]**.
- 2) Press **▶** or the **<ENTER>** button to show the information of the current projector status.

Network factory default

You can reset the network setting to the factory default of the projector.

- 1) Press **▲▼** to select **[Network factory default]**.
- 2) Press the **<ENTER>** button.
 - [Return to Network factory default?] appears. Select [Yes] to continue. Another confirmation dialog box appears, select [Yes] to return to [Factory default].

Network

Network connections

The projector has a network function, and the following operations are available from the computer using the web browser control.

- Setting and adjustment of the projector.
- Display of the projector status.
- Transmission of an E-mail message when there is a problem with the projector.

Note

- A LAN cable is required to use the network function.

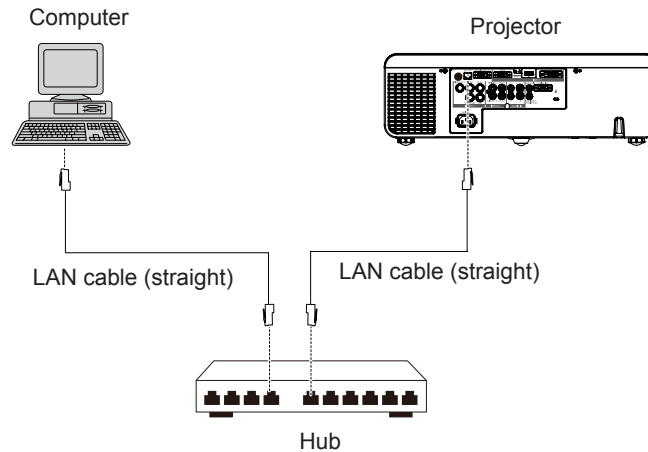

- A Web browser is required to use this function . Confirm that the Web browser can be used beforehand.
Compatible OS : Windows XP/Windows Vista/Windows 7, Mac OS X v10.4/v10.5/v10.6/v10.7
Compatible Web Browser : Internet Explorer 7.0/8.0/9.0, Safari 4.0/5.0 (Mac OS)
- Communication with an E-mail server is required to use the E-mail function. Confirm that the E-mail can be used beforehand.
- Use shielded LAN cable (STP cable) that is compatible with category 5 or above.
- Use a LAN cable with length of 100m or shorter.

■ Name and function of network function parts

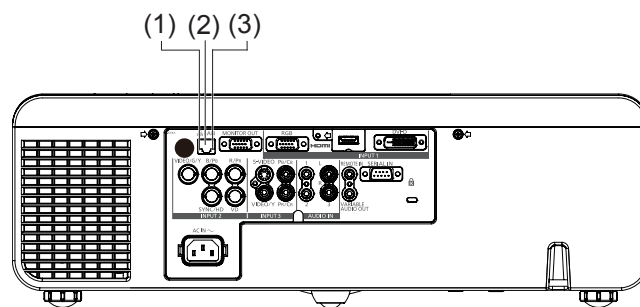

(1) LAN LINK/ACT lamp (yellow)

Lights on when connected.
Flashes when transmitting/receiving data.

(2) LAN terminal (10BASE-T/100BASE-TX)

Used to connect the LAN cable here.

(3) LAN 10/100 lamp (green)

Lights on when connected to the 100BASE-TX.

Attention

- Connect the LAN to the indoor equipment.

Accessing from the Web browser

- 1) Activate the Web browser in the personal computer.
- 2) Enter the IP address set by the projector into the URL input field of the Web browser.
- 3) Enter your“ User name” and“ Password”.
 - The factory default settings are user1 (user privileges) or admin1 (administrator privileges) for the use name and panasonic (lowercase letters) for the password.
- 4) Click [OK] to display the Projector status page.
 - “Projector status” page is displayed.



Note

- Avoid activating two or more Web browser simultaneously to work out setting or control actions.
- Change the password first of all.
- Administrator privileges enable the use of all functions. User privileges enable the use of only “Projector status”, “Network status”, “Basic control”, and “Change password”.
- If you want to control the projector using a Web browser, set [Network control] in the network menu to [On].
- There are some control items used with the JavaScript function in the setting pages. If the web browser is set not to use this JavaScript function, it may not control the projector properly.

Description of each item



- 1 Page selection tabs
Click these to switch pages.
- 2 Monitor information button
Click this item, and the status of the projector is displayed.
- 3 Projector control button
Click this item to display the projector control page.
- 4 Detailed set up button
Click this item to display the advanced settings page.
- 5 Change password button
Click this button to display the password change page.
- 6 CRESTRON RoomView button
Click this button to monitor and control the projector through the CRESTRON RoomView®.
- 7 Language switch button
Click this button to switch language between English and Japanese.

Projector status page

Click [Status], then [Projector status] to display the Status information page.
This page displays the projector statuses established for the items shown below.



- 1 Displays the type of projector.
- 2 Displays the firmware version of the projector main unit.
- 3 Displays the power source status.
- 4 Displays the video mode status.
- 5 Displays the serial number of the projector.
- 6 Displays the firmware version of the network.
- 7 Displays the AV mute status.
- 8 Displays the volume status.
- 9 Displays the status of input switch.
- 10 Displays the intake temperature status of the projector.
- 11 Displays the the around lamp temperature status of the projector.
- 12 Displays the optics module temperature status of the projector.
- 13 Displays the use time of the lamp.
- 14 Displays the self diagnostics information.
(➡ page 77)
- 15 Displays the runtime of the projector.

■ Error information page

If [Error (Detail)] is displayed in the self-diagnosis information display column on the [Projector status] screen, click the part to display the details of the error.

- Depending on the nature of the error, the projector may be placed in the standby mode for its own protection.

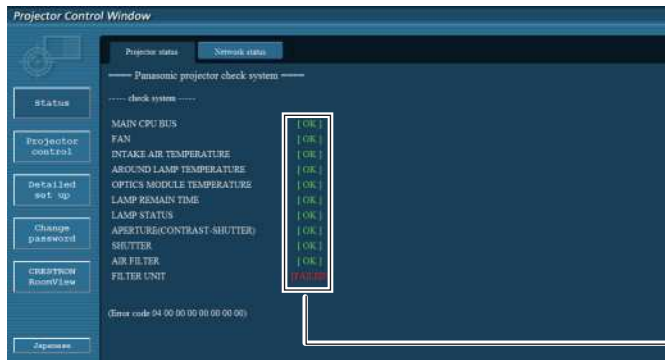

OK: Normal operation
 FAILED: Occurrence of trouble
 WARNING: Warning

When [FAILED] has appeared for an item

Parameter	Description
MAIN CPU BUS	Trouble has occurred in the microcomputer circuitry. Consult your dealer.
FAN	Trouble has occurred in the fan or its drive circuit. Consult your dealer.
INTAKE AIR TEMPERATURE	Intake air temperature is high. It could be because it is used in an environment of high temperature such as close to a heating device, etc., the air intake is blocked, or the air filter is clogged.
AROUND LAMP TEMPERATURE	The temperature around the lamp is too high. Exhaust may be blocked, or [Fan control] mode may be set wrong. See [Fan control] of the Functional Manual. (▶page 65)
OPTICS MODULE TEMPERATURE	Optics module temperature is high. The exhaust air port maybe blocked or the air filter is clogged.
LAMP REMAIN TIME	The lamp runtime has exceeded the prescribed cumulative time, and it is now time to replace the lamp.
LAMP STATUS	The lamp has failed to light. Wait a short while for the lamp to cool off, and then turn on the power.
APERTURE(CONTRAST-SHUTTER)	Trouble has occurred in the contrast shutter circuitry. Consult your dealer.
SHUTTER	There is a problem with shutter.
AIR FILTER	There is a problem with the air filter unit.
FILTER UNIT	The air filter unit is not installed.

■ Network status page

Displays the current configuration information of the network.

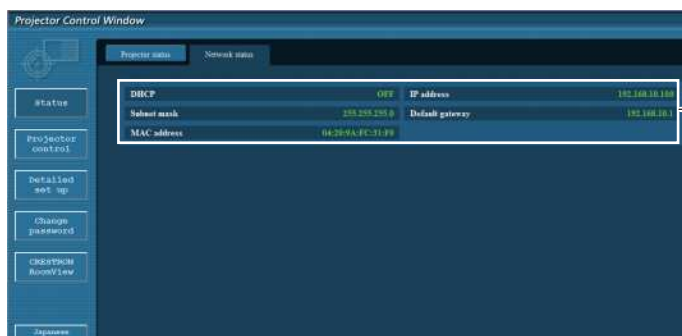

*Displays the configuration details of wired LAN.

Network

Basic control page

To move from another page, click [Projector control], then [Basic control].



- 1 Power standby/on control
- 2 Use these to select the input signals
- 3 Switches image mode
- 4 Turn on or off the SHUTTER*/AV MUTE* function

*When it displays SHUTTER, it is only for EZ570 series, EW630 series and EX600 series.

*When it displays AV MUTE, it is only for EW530 series and EX500 series.

Detail control page

Click [Projector control], then [Advanced control] to display the Detail control page.



- 1 Execute Auto PC ADJ. function
- 2 Operations on Image adjust
- 3 Operations on Screen mode*
- 4 Operations on Rear/Ceiling

*[NATURAL WIDE] will not be displayed for EX600 series and EX500 series.

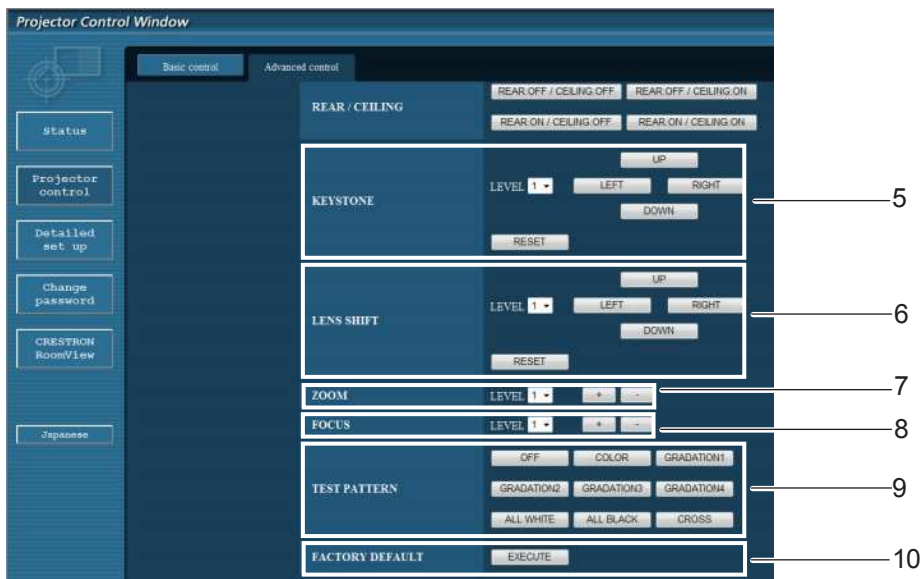

- 5 Operations on Keystone* function
- 6 Operations on Lens shift
- 7 Operations on Zoom
- 8 Operations on Focus
- 9 Operations on Test pattern
- 10 Return to factory default setting

*For EW530 series and EX500 series, the <LEFT> and <RIGHT> buttons will display in gray and are not available.

Network config page

You can change network settings on projector when connecting with the administrator authority.

● LAN settings

- 1) Click [Detailed set up] in the menu.
- 2) Click [Change] to change the LAN settings.
 - To return to the previous window, click [Back].
- 3) Complete the detailed settings and click [Next].
 - When [Next] is clicked, the next page appears, enabling you to complete the detailed settings as desired. Settings performed here are the same as the settings performed with the [Network] menu of the projector.
- 4) Click [Submit].
 - The settings will be registered.

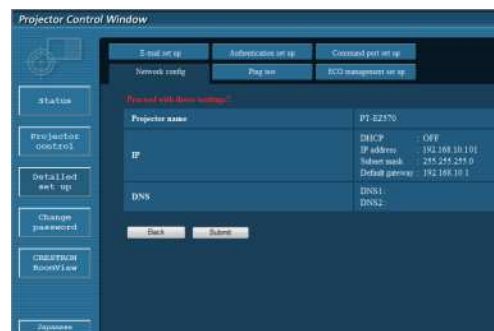
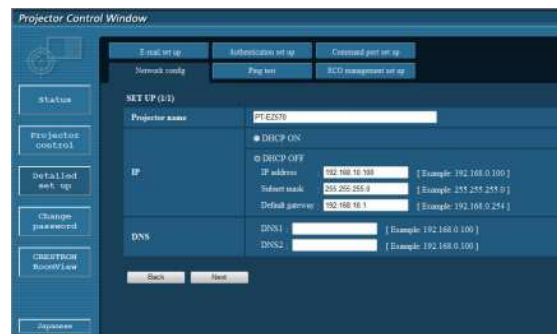

Note

- Changing the setting of LAN while connected with LAN might disconnect the connection.

■ Ping test page

This page makes it possible to check whether the network is connected to the e-mail server, POP server, DNS server, etc.

Click [Detailed set up], then [Ping test] to display the Ping test page.

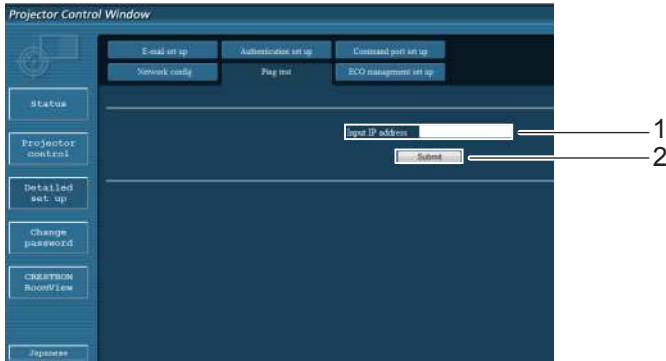

- 1 Enter the IP address of the server to be tested.
- 2 Button for conducting the test.

Display which appears when the connection was successful.

```
PING 198.245.80.20 (198.245.80.20): 56 data bytes
64 bytes from 198.245.80.20: seq=0 ttl=64 time=0.837 ms
64 bytes from 198.245.80.20: seq=1 ttl=64 time=0.488 ms
64 bytes from 198.245.80.20: seq=2 ttl=64 time=0.479 ms
64 bytes from 198.245.80.20: seq=3 ttl=64 time=0.485 ms

--- 198.245.80.20 ping statistics ---
4 packets transmitted, 4 packets received, 0% packet loss
round-trip min/avg/max = 0.479/0.571/0.837 ms
```

Display which appears when the connection failed.

```
PING 198.245.80.15 (198.245.80.15): 56 data bytes
Request timed out
Request timed out
Request timed out
Request timed out

--- 198.245.80.15 ping statistics ---
4 packets transmitted, 0 packets received, 100% packet loss
```

■ ECO management set up page

This page makes it possible to set the savings of power consumption.

Click [Detailed set up], then [Eco management set up] to display the ECO management set up page.

Click [Submit] to execute the items you have set.



- 1 Set the brightness of the screen.
- 2 Set the conditions of the AUTO POWER SAVE*.
- 3 Set the time of the countdown when no signal input.

*For EW530 series and EX500 series, AV mute detection will be appear in the AUTO POWER SAVE.

E-mail set up page

With this projector, if a problem occurs or if the lamp usage time reaches a set value, an e-mail message can be sent to one or more preset e-mail addresses (maximum two addresses). Click [Detailed set up], then [E-mail set up] to display the E-mail setup page.

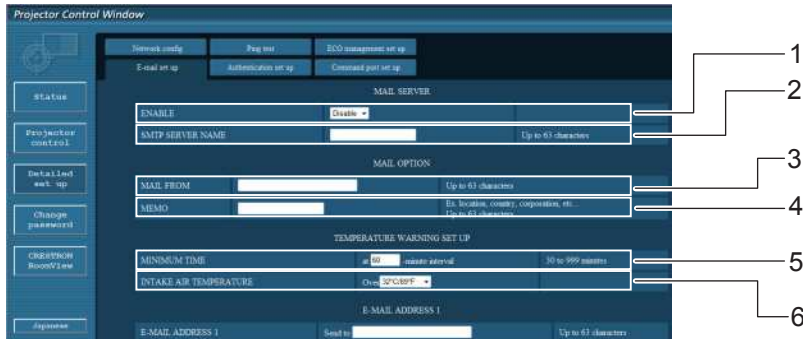

- 1 Select Enable to use the e-mail function.
- 2 Enter the IP address or server name of the e-mail server (SMTP). The DNS server must be set if the server name is entered.
- 3 Enter the e-mail address of the projector. (maximum 63 characters)
- 4 The user can enter the location of, for example, the installed projector so that the recipient may easily identify the originator of the e-mail. (maximum 63 characters)
- 5 The user can modify the minimum time interval of temperature warning mail. The default value is 60 minutes. In this case, the user cannot send another mail for 60 minutes after sending previous temperature warning mail even the set warning temperature is reached again.
- 6 Select the temperature of the intake sensor at which to send a warning message.

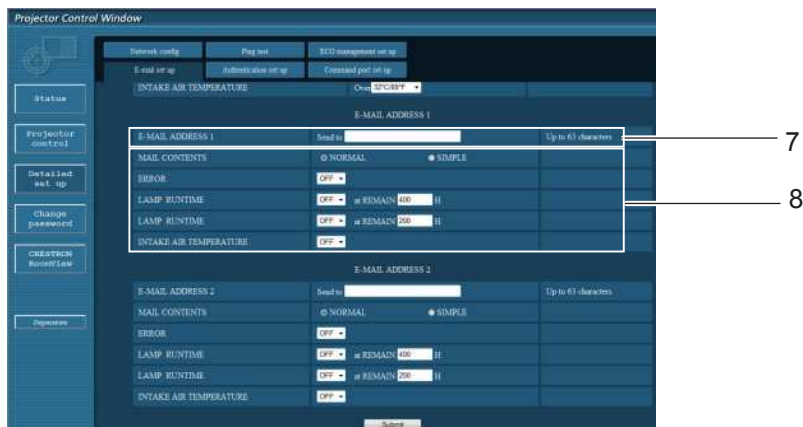

- 7 Enter the E-mail Address1 of your desired recipient.
- 8 Select the conditions for sending e-mail.

MAIL CONTENTS: Select [NORMAL] or [SIMPLE].
ERROR: An error is detected by self-diagnosis.
LAMP RUNTIME: Remaining lamp service time has reached the value set in the field.
INTAKE AIR TEMPERATURE: Intake air temperature has reached the value set in the field.

E-mail set up page (continued)

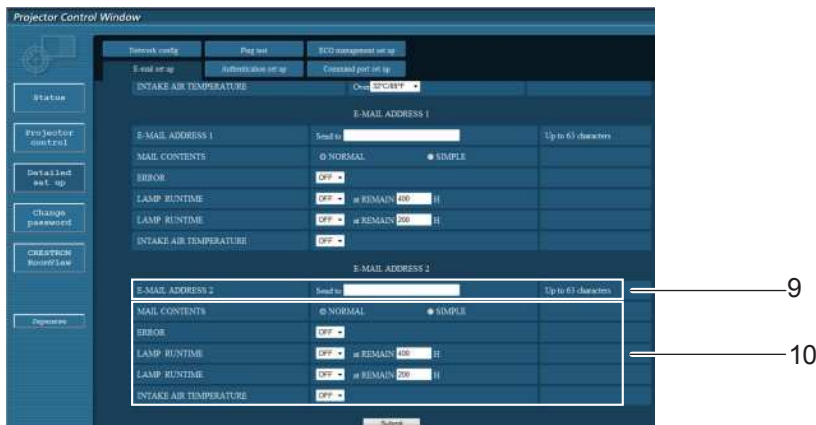

9 Enter the E-mail Address2 of your desired recipient.

10 Select the conditions for sending e-mail.

- MAIL CONTENTS:** Select [NORMAL] or [SIMPLE].
- ERROR:** An error is detected by self-diagnosis.
- LAMP RUNTIME:** Remaining lamp service time has reached the value set in the field.
- INTAKE AIR TEMPERATURE:** Intake air temperature has reached the value set in the field.

Authentication set up page

The POP/SMTP server is set on this page when POP/SMTP authentication is required for mail transmissions. Click [Detailed set up], then [Authentication set up] to display the Authentication server setup page.

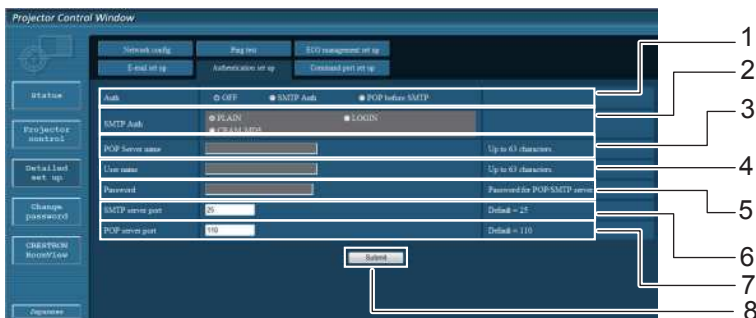

- 1 Select the authentication method specified by your Internet service provider.
- 2 Set this if SMTP authentication has been selected.
- 3 POP server name field
Available input characters:
Alphanumeric characters (A - Z, a - z, 0 - 9), hyphen (-), period (.)
- 4 POP/SMTP server user name field
- 5 POP/SMTP server password field
- 6 Enter the port number for the SMTP server (normally "25").
- 7 Enter the port number for the POP server (normally "110").
- 8 Button to update settings

■ Contents of mail sent

- Mail with the contents shown below is sent when the e-mail settings have been established.

```

=== Panasonic projector report(CONFIGURE) ===
Projector Type      : PT-EZ570
Serial No          : 000000000
----- E-mail setup data -----
TEMPERATURE WARNING SETUP
MINIMUM TIME       at [ 60] minutes interval
INTAKE AIR TEMPERATURE Over [ 32degC / 89degF ]

ERROR              [ OFF ]
LAMP RUNTIME       [ OFF ] at REMAIN [ 400] H
LAMP RUNTIME       [ OFF ] at REMAIN [ 200] H
INTAKE AIR TEMPERATURE [ OFF ]

----- check system -----
MAIN CPU BUS       [ OK ]
FAN                [ OK ]
INTAKE AIR TEMPERATURE [ OK ]
AROUND LAMP TEMPERATURE [ OK ]
OPTICS MODULE TEMPERATURE [ OK ]
LAMP REMAIN TIME   [ OK ]
LAMP STATUS        [ OK ]
APERTURS (CONTRAST-SHUTTER) [ OK ]
SHUTTER           [ OK ]
AIR FILTER         [ OK ]
FILTER UNIT        [ OK ]

(Error code 00 00 00 00 00 00 00 00)

Intake air temperature  :[ 31 degC / 87 degF ]
AROUND LAMP temperature  :[ 37 degC / 98 degF ]
Optics module temperature :[ 39 degC / 102 degF ]

PROJECTOR RUNTIME      1 H

LAMP ECO               500 H
LAMP NORMAL            300 H
LAMP REMAIN            2400 H

----- Current status -----
MAIN VERSION          1.00
NETWORK VERSION       1.00
LAMP STATUS           LAMP=ON
INPUT                 RGB
SIGNAL NAME           XGA6
SIGNAL FREQUENCY      0.00kHz / 0.00Hz

----- Wired Network configuration -----
DHCP Client           OFF
IP address            192.168.10.100
MAC address           04:20:9A:00:00:00

----- Memo -----

```

- Mail with the contents shown below is sent when an error has occurred.

```

=== Panasonic projector report(ERROR) ===
Projector Type      : PT-EZ570
Serial No          : 000000000
----- check system -----
MAIN CPU BUS       [ OK ]
FAN                 [ OK ]
INTAKE AIR TEMPERATURE [ OK ]
AROUND LAMP TEMPERATURE [ OK ]
OPTICS MODULE TEMPERATURE [ OK ]
LAMP REMAIN TIME   [ OK ]
LAMP STATUS        [ FAILED ]
APERTURS (CONTRAST-SHUTTER) [ OK ]
SHUTTER            [ OK ]
AIR FILTER         [ OK ]
FILTER UNIT        [ OK ]

(Error code 00 40 00 00 00 00 00 08)

Intake air temperature  :[ 31 degC / 87 degF ]
AROUND LAMP temperature :[ 37 degC / 98 degF ]
Optics module temperature :[ 39 degC / 102 degF ]

PROJECTOR RUNTIME      1 H

LAMP ECO               500 H
LAMP NORMAL            300 H
LAMP REMAIN            2400 H

----- Current status -----
MAIN VERSION           1.00
NETWORK VERSION        1.00
LAMP STATUS            LAMP=OFF
INPUT                  NETWORK

----- Wired Network configuration -----
DHCP Client            OFF
IP address              192.168.10.100
MAC address             04:20:9A:00:00:00

----- Memo -----
    
```

■ Command port set up page

Set the port number to be used with command control.
 Click [Detailed set up] → [Command port set up].

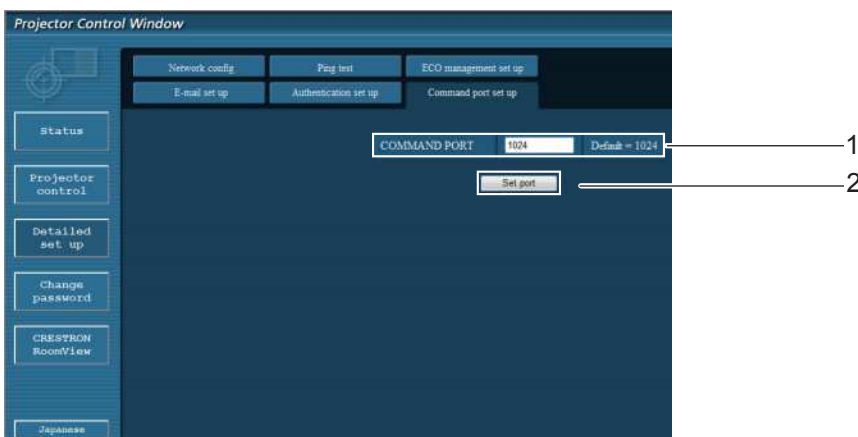

- 1 Input the port number to be used with command control
- 2 Setting update button

Change Password page

Click [Change password].

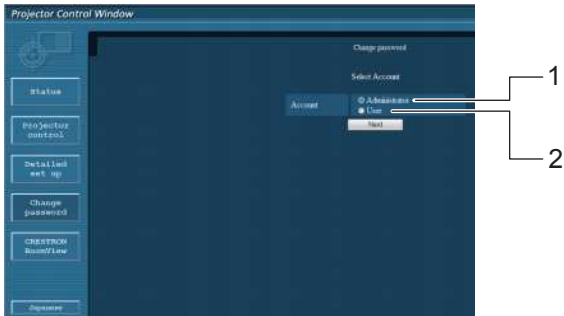

- 1 Administrator
- 2 User

Administrator mode

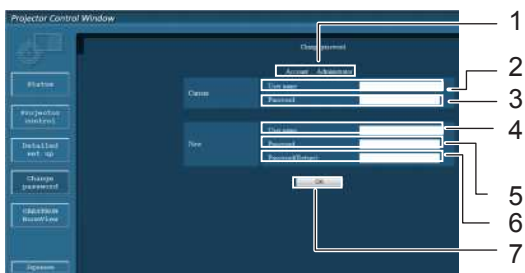

- 1 Account
- 2 Current user name input field
- 3 Current password input field
- 4 New user name input field
- 5 New password input field
- 6 New password input field (re-enter for confirmation)
- 7 Button for executing password change

User account

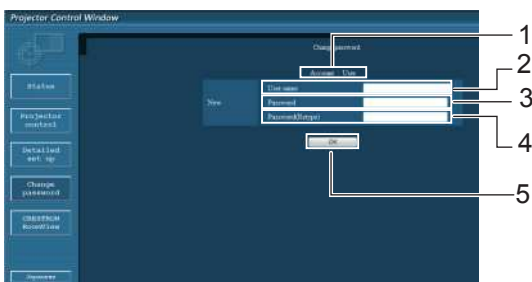

- 1 Account
- 2 New user name input field
- 3 New password input field
- 4 New password input field (re-enter for confirmation)
- 5 Button for executing password change

User mode

A user can change password only.

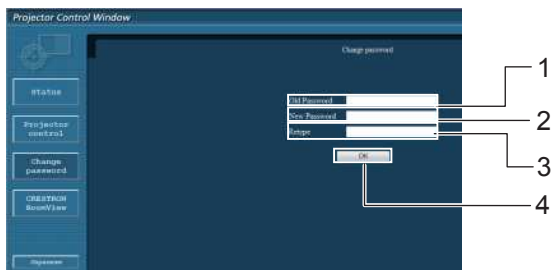

- 1 Current password input field
- 2 New password input field
- 3 New password input field (re-enter for confirmation)
- 4 Button for executing password change

Note

- When changing the administrator account, both “Current user name” and “Current password” are required.
- No account is not available .
- Administrator account and user account should be differed.

■ CRSTRON RoomView page

You can monitor or control the projector using RoomView.

To display the operation page of RoomView from Web Control screen, access with the administrator rights is required. (The [CRESTRON RoomView] button is not displayed on the Web Control screen for user rights.)

When you click [CRESTRON RoomView], the RoomView operation page is displayed.

If Adobe Flash Player is not installed in your computer, or if the browser does not support Flash, this page does not appear. In this case, return to the previous page by clicking [Back] in the operation page.

Operation page



1 Logout, Tools, Info, Help

Exit the page when the password has changed and switches the pages for tools, information, help using the tab.

2 POWER

Switches between on and off of the power.

3 VOL DOWN, AV MUTE, VOL UP

Sets the volume, AV mute. When the power of the projector is turned off, VOL DOWN, AV MUTE and VOL UP are not available.

4 Input Select

Sets the input selection. When the power of the projector is turned off, this operation is not available.

5 Operation buttons on the menu screen

Operates on the menu screen.

6 Freeze, image quality adjustment

Sets freeze, image quality details.

7 Back

Returns to the previous page.

Tools page

Click Tools on the operation page.



1 Control system

Sets the information required for the communication with the controller that is connected to the projector.

2 User Password

Sets the password for the user rights in the operation page of RoomView.

3 Admin Password

Sets the password for the administrator rights in the operation page of RoomView.

4 Network status

Displays the setting of wired LAN.

DHCP: Displays the value in the current setting.

IpAddress: Displays the value in the current setting.

SubnetMask: Displays the value in the current setting.

DefaultGateway: Displays the value in the current setting.

DNSServer: Displays the value in the current setting.

5 Exit

Return to the operation page.

Network

Info page

Click Info on the operation page.

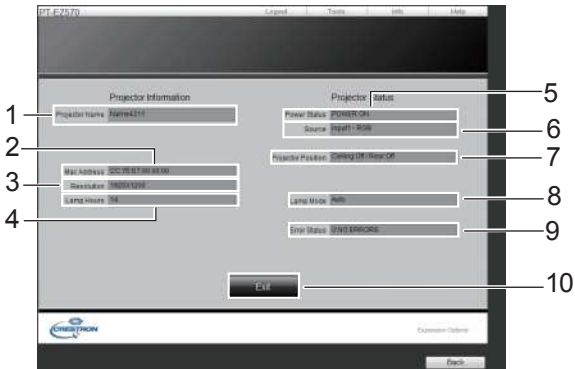

- 1 **Projector name**
Displays the name of the projector.
- 2 **Mac Address**
Displays the MAC address.
- 3 **Resolution**
Displays the resolution of the projector.
- 4 **Lamp Hours**
Displays the lamp usage time (converted value).
- 5 **Power Status**
Displays the status of the power.
- 6 **Source**
Displays the selected video input.
- 7 **Projector Position**
Displays the projection method of the projector.
- 8 **Lamp Mode**
Displays the lamp mode.
- 9 **Error Status**
Displays the error status.
- 10 **Exit**
Return the operation page.

User mode

A user can change password only.



- 1 **Help Desk**
Sends or receive messages to the administrator who uses Crestron RoomView.

About indicator status

If an indicator turns on

If a problem occurs within the projector, it will be notified with the temperature indicator <TEMP>, the filter indicator <FILTER>, the shutter indicator <SHUTTER*/AV MUTE*>, and the lamp indicator <LAMP>. Check the status of the indicators and take the following action.

*<SHUTTER> indicator (Only for EZ570 series, EW630 series and EX600 series.)

<AV MUTE> indicator (Only for EW530 series and EX500 series.)

CAUTION

- Before you take a remedial measure, follow the procedure of switching the power off indicated in “Turning off the projector”. (➔page 39)
- If multiple indicators light or blink, verify the status of the projector by looking at each indicator.

Note

- Confirm the status of the power indicated on the <ON(G)/STANDBY(R)> indicator.

When operating correctly

The status of the indicator is displayed with the following symbols.

▲: Off, ●: On, ★: Flashing, ■: Off or On or Flashing

Indicators					Status of the projector
<ON(G)/STANDBY(R)> Green/Red/ Orange	<TEMP> Red	<FILTER> Orange	<SHUTTER/ AV MUTE> Blue	<LAMP> Orange	
▲/▲/▲	▲	▲	▲	▲	The power plug has been removed from the outlet.
▲/●/▲	■*1	■*1	■*1	■*1	The projector is in the standby mode. Turns on when pressing the <POWER ON> button on the remote control or the < ⏻/ > button on the side control.
●/▲/▲	■*1	■*1	■*1	■*1	The projector is operating normally.
▲/▲/★*2	■*1	■*1	■*1	■*1	The lamp is cooling down. The projector does not turn on when pressing the <POWER ON> button on the remote control or the < ⏻/ > button on the side control until the standby indicator <ON(G)/STANDBY(R)> changes to red.
★*2/▲/▲	■*1	■*1	■*1	■*1	The projector is in the power management mode. The lamp will turn on when controlling the projector, allowing the user to start operating it.
▲/▲/★*2	■*1	■*1	■*1	■*1	Power management mode is [On] and the lamp is cooling down.
●/▲/▲	■*1	■*1	●	■*1	The shutter function has been turned on. Press any button on the remote control or the side control to cancel the function.
▲/●/▲	■*1	■*1	★*2	■*1	The projector is in the shutter management mode. The lamp will turn on when controlling the projector, allowing the user to start operating it.
▲/▲/★*2	■*1	■*1	★*2	■*1	Shutter management mode is [On] and the lamp is cooling down.

*1: The indicator will change according to different conditions, regardless of the status of other indicators.

*2: The indicator will flash in approximately 1-second intervals.

About indicator status

■ When there is a problem with internal temperature

The status of the indicator is displayed with the following symbols.

▲: Off, ●: On, ★: Flashing, ■: Off or On or Flashing

Indicators					Status of the projector
<ON(G)/STANDBY(R)> Green/Red/Orange	<TEMP> Red	<FILTER> Orange	<SHUTTER/AV MUTE> Blue	<LAMP> Orange	
●/▲/▲	★ *1	■ *2	■ *2	■ *2	If the temperature within the projector becomes too high, the temperature indicator <TEMP> will start to flash slowly.
▲/▲/★ *3	★ *4	■ *2	■ *2	■ *2	If the temperature within the projector becomes even higher, the temperature indicator <TEMP> will flash faster, the power indicator <ON(G)/STANDBY(R)> will turn off, and the projector will turn off automatically. The projector will not turn back on even when pressing the <POWER ON> button on the remote control or the <⏻/ > button on the side control. When the projector returns to the normal operating temperature, the standby indicator <ON(G)/STANDBY(R)> will change to on. The projector will turn back on when pressing the <POWER ON> button on the remote control or the <⏻/ > button on the side control. (The temperature indicator <TEMP> will remain flashing.) Check the air filter.
▲/●/▲	★ *4	■ *1	■ *1	■ *1	The projector has cooled inside, and returned to operating temperature. Pressing the <POWER ON> button on the remote control or the <⏻/ > button on the side control will make the temperature indicator <TEMP> stop flashing and operate the projector. Check the air filter.

*1: The indicator will flash in approximately 2-second intervals.

*2: The indicator will change according to different conditions, regardless of the status of other indicators.

*3: The indicator will flash in approximately 1-second intervals.

*4: The indicator will flash in approximately 0.5-second intervals.

■ When there is a problem with internal power

The status of the indicator is displayed with the following symbols.

▲: Off, ●: On, ★: Flashing, ■: Off or On or Flashing

Indicators					Status of the projector
<ON(G)/STANDBY(R)> Green/Red/ Orange	<TEMP> Red	<FILTER> Orange	<SHUTTER/ AV MUTE> Blue	<LAMP> Orange	
▲/▲/★*1	★*1	★*1	★*1	★*1	<p>A problem has been detected within the projector.</p> <p>The projector will not turn back on even when pressing the <POWER ON> button on the remote control or the <⏻/ > button on the side control. Remove the power plug from the outlet, and plug it back in again.</p> <p>If the power turns off, or the indicator turns on or flashes again, remove the power plug from the outlet and contact your dealer to request an inspection and repair. Do not leave the projector plugged in with the indicator on or flashing. Doing so may cause a fire or electric shock.</p>

*1: The indicator will flash in approximately 0.5-second intervals.

■ When there is a problem with the air filter

The status of the indicator is displayed with the following symbols.

▲: Off, ●: On, ★: Flashing, ■: Off or On or Flashing

Indicators					Status of the projector
<ON(G)/STANDBY(R)> Green/Red/ Orange	<TEMP> Red	<FILTER> Orange	<SHUTTER/ AV MUTE> Blue	<LAMP> Orange	
●/■*1/■*1	■*1	●	■*1	■*1	<p>The indicator notifies you when the time set with [Filter counter timer] has been reached. Replace the air filter. (Filter replacement icon will be shown at the top right of the screen simultaneously.*2)</p> <p>Alternatively, the indicator notifies you when [Filter counter remaining] becomes 0%. Replace the air filter.</p>
▲/●/▲	★*2	★*2	★*2	★*2	<p>When the air filter unit isn't installed, the projector is forced shutdown. Install the air filter unit.</p>

*1: The indicator will change according to different conditions, regardless of the status of other indicators.

*2: The indicator will flash in approximately 0.5-second intervals.

*3: When [Display] (➡ page 63) is set to [Off], the freeze function (➡ page 43) or shutter function (➡ page 41) will not be displayed on the screen during operation.

About indicator status

■ When there is a problem with the lamp

The status of the indicator is displayed with the following symbols.

▲: Off, ●: On, ★: Flashing, ■: Off or On or Flashing

Indicators					Status of the projector
<ON(G)/ STANDBY(R)> Green/Red/ Orange	<TEMP> Red	<FILTER> Orange	<SHUTTER/ AV MUTE> Blue	<LAMP> Orange	
▲/▲/★*2	■*1	■*1	■*1	★*2	The lamp does not turn on and the lamp is cooling down.
▲/●/▲	■*1	■*1	■*1	★*2	The lamp does not turn on and the lamp has been cooled enough after cooling down.
■*1/■*1/■*1	■*1	■*1	■*1	●	The recommended time to replace the lamp has been reached. The lamp replacement icon will be displayed at the top right of the screen to notify the user of replacement. Replace the lamp unit as soon as possible. Replacing the lamp will cause the lamp indicator <LAMP> to turn off.

*1: The indicator will change according to different conditions, regardless of the status of other indicators.

*2: The indicator will flash in approximately 1-second intervals.

■ When there is a problem with the shutter (Only for the models which with shutter)

The status of the indicator is displayed with the following symbols.

▲: Off, ●: On, ★: Flashing, ■: Off or On or Flashing

Indicators					Status of the projector
<ON(G)/ STANDBY(R)> Green/Red/ Orange	<TEMP> Red	<FILTER> Orange	<SHUTTER> Blue	<LAMP> Orange	
▲/▲/★*2	■*1	■*1	★*2	■*1	There is a problem with opening or closing the shutter and the projector is cooling down.
▲/●/▲	■*1	■*1	★*2	■*1	There is a problem with opening or closing the shutter and the projector has been cooled enough after cooling down.
■*1/■*1/■*1	■*1	■*1	★*2	■*1	There is a problem with opening or closing the shutter.

*1: The indicator will change according to different conditions, regardless of the status of other indicators.

*2: The indicator will flash in approximately 0.5-second intervals.

Maintenance/replacement

Before cleaning/replacing the unit

- When you perform maintenance or replacement of the parts, make sure to turn off the power and disconnect the power plug from the wall outlet. (▶ pages 35, 39)
- Be sure to observe the procedure “Turning off the projector” (▶ page 39) when performing power supply operation.

Maintenance

Outer Case

Wipe off dirt and dust using a soft dry cloth.

- If the dirt is persistent, soak the cloth with water and wring it thoroughly before wiping. Dry off the projector with a dry cloth.
- Do not use benzene, thinner, or rubbing alcohol, other solvents, household cleaners. Using them may cause deterioration of the outer case.
- When using chemical treated dusters, follow its instruction.

Front glass surface of the lens

Wipe off the dirt and dust off the front surface of the lens with soft clean cloth.

- Do not use a cloth that has an abrasive surface or a cloth that is moist, oily, or covered with dust.
- Do not use excessive force when wiping the lens as it is fragile.

Attention

- The lens is made of glass. Impacts or excessive force when wiping may scratch its surface. Please handle with care.

Air filter unit

Clean the air filter unit in the following cases.

- When the replacement message is displayed and the filter indicator <FILTER> lights up due to a blockage.
- The temperature inside the projector becomes high and the temperature indicator <TEMP> lights, causing the projector turn off, due to a blockage. (When the power is turned off, the temperature indicator <TEMP> flashes and the standby indicator <ON(G)/STANDBY(R)> lights.)

- 1) Turn off the projector, and unplug the AC power cord from the AC outlet.
- 2) Clean up the dust on the projector and around the air vents.
- 3) Press ▼ downwards on the filter cover to release the latch and open the filter cover.
- 4) Pull out the air filter unit.
 - Pick the tab and frame of the air filter unit, release the lock with pressing the tab rightwards in the figure, and then pull.

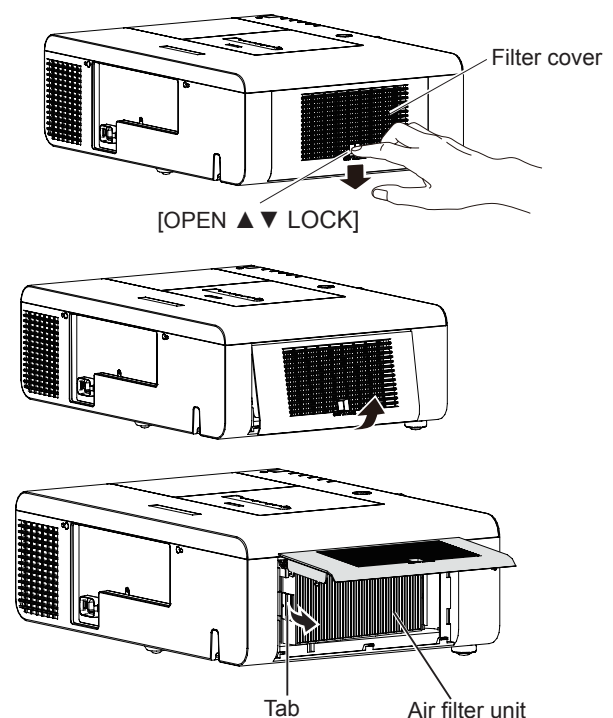

5) Clean the air filter unit

- Removing the dust from the air filter unit
 - (i) Remove the dust from the air filter unit using a vacuum or other cleaner.
 - If the dust persists after cleaning with a vacuum, wash the air filter unit in water.
- Washing the air filter unit
 - (i) Soak the air filter unit in water or warm water and rinse it lightly.
 - Do not use materials such as brushes or detergent.
 - When you rinse the air filter unit, hold the frame and avoid excessive force on the filter part.
 - (ii) Change the water two or three times while you rinse the air filter unit.
 - Rinse it until the cloud of the water clears. If the air filter unit is not rinsed sufficiently, odor may result.

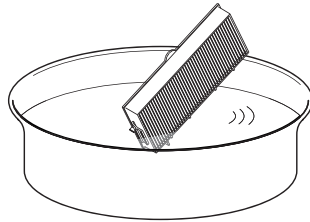

- Drying the air filter unit

Naturally dry the air filter unit in a well-ventilated place, avoiding dust and direct sunlight.

 - Do not use a hair drier or other drier.

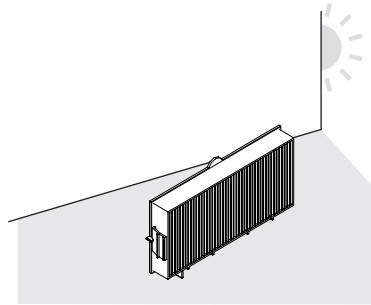

6) Attach the air filter unit.

- Hold the air filter unit that the tab is in left side in the figure, put the right side in the figure first, and press the tab side until make a click sound.

7) Close and press up to lock the filter cover.

- Make sure that the air filter cover is closed tightly.

8) Reset the filter counter.

- Turn on the power and perform [Filter counter reset] in the [Setting] menu.

Attention

- After washing the air filter unit, dry it thoroughly before attaching to the projector. Attaching wet air filter unit may cause electric shock or malfunction.

Note

- Be sure to attach the air filter unit properly. If you use the projector without attaching the air filter unit, the projector may be damaged due to the dirt or dust.
- If the air filter unit has been damaged or dirt remains even after washing it, replace it with a new filter (Product No.: ET-RFE200).
- It is recommended that the air filter unit is replaced after two times of cleaning and reusing.
- After washing, the capability of the air filter unit may decrease.
- After washing the air filter unit, reset the filter counter. Otherwise, the power of the projector may be turned off for safety.

Replacing the unit

■ Replacement of the air filter unit

- 1) Turn off the projector, and unplug the AC power cord from the AC outlet.
- 2) Clean up the dust on the projector and around the air vents.
- 3) Press ▼ downwards on the filter cover to release the latch and open the filter cover.
- 4) Pull out the air filter unit.
 - Pick the tab and frame of the air filter unit, release the lock with pressing the tab rightwards in the figure, and then pull.
- 5) Attach the air filter unit.
 - Hold the air filter unit that the tab is in left side in the figure, put the right side in the figure first, and press the tab side until make a click sound.
- 6) Close and press up to lock the filter cover.
 - Make sure that the air filter cover is closed tightly.
- 7) Reset the filter counter.
 - Turn on the power and perform [Filter counter reset] in the [Setting] menu.

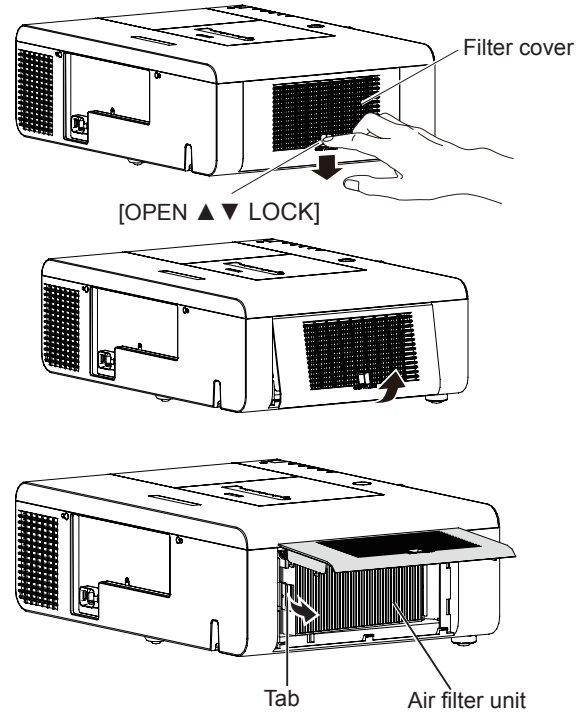

Attention

- Turn off the power before you replace the air filter unit.
- When attaching the air filter unit, make sure that the projector is stable, and work in an environment that is safe, even in the event of the air filter unit dropping.
- Do not operate the projector with the air filter unit removed. Dust may accumulate on the optical elements degrading picture quality.
- Do not put anything into the air vents. Doing so may result in malfunction of the projector.
- The air filter unit to be replaced should be an unused product.

Maintenance/replacement

Lamp unit

The lamp unit is a consumable component. You can check the total usage time using Lamp runtime in the Information menu on page 71.

It is recommended to ask an authorized engineer to replace the lamp unit. Contact your dealer. Consult your dealer to purchase a replacement lamp unit (ET-LAE200).

CAUTION:

- **Do not replace the lamp unit when it is hot. (Wait at least 1 hour after use.)**

The inside of the cover can become very hot, take care to avoid burn injuries.

Notes on the replacement of the lamp unit

- The luminous source of the lamp is made of glass and may burst if you hit it against a hard surface or drop it. Please handle with care.
- A Phillips screwdriver is required for replacement of the lamp unit.
- When replacing the lamp unit, be sure to hold it by the handle.
- When replacing the lamp because it has stopped illuminating, there is a possibility that the lamp may be broken. If replacing the lamp of a projector which has been installed on the ceiling, you should always assume that the lamp is broken, and you should stand to the side of the lamp cover, not underneath it. Remove the lamp cover gently. Small pieces of glass may fall out when the lamp cover is opened. If pieces of glass get into your eyes or mouth, seek medical advice immediately.
- The lamp contains mercury. Consult your local municipality or your dealer about correct disposal of used lamp units.

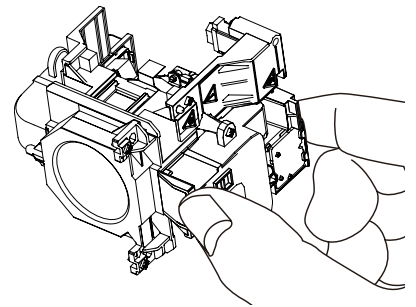



Attention

- Do not use other than designated lamp units.
- The part numbers of accessories and separately sold components are subject to change without notice.

When to replace the lamp unit

The lamp unit is a consumable component. Brightness decreases according to duration of usage, so periodical replacement of the lamp unit is necessary.

When the projection lamp of the projector reaches its end of life, the Lamp replacement icon appears on the screen and <LAMP> indicator lights orange. Replace the lamp with a new one promptly.

Lamp runtime	On screen Lamp replacement icon 	LAMP indicator 
Over 3 000 hours *	The message is displayed for 10 seconds. If you press any button within the 10 seconds, the message disappears.	Lights in orange (even in stand-by mode).
Over 3 200 hours *	If the power is turned on without replacing the lamp, the power automatically turns off after approximately ten minutes to prevent the malfunction of the projector.	

*3 200 hours of use is a rough guideline, but is not a guarantee. The lamp runtime differs depending on the setting of "Lamp power" menu.

Note

- The Lamp replacement icon will not appear when the [Display] function is set to [Off] (➔page 63), or during "Freeze" (➔page 43).

■ Replacing the Lamp unit

CAUTION:

- When the projector is mounted on a ceiling, do not work with your face close to the projector.
- Attach the lamp unit and the lamp cover securely.
- When you experience difficulty in installing the lamp, remove it and try again. If you use force to install the lamp, the connector may be damaged.

1) Turn off the Power by following the procedure in “Turning off the projector (→page 39). Unplug the AC power cord. Wait at least 1 hour and make sure the lamp unit and surroundings are cool.

2) Use a Phillips screwdriver to loosen the lamp cover fixing screw and open the lamp cover.

- Open the lamp cover by pulling it slowly toward the direction of the arrow.

3) Use a Phillips screwdriver to loosen the three lamp unit fixing screws until the screws turn freely. Hold the used lamp unit by its handles, and pull it gently from the projector.

4) Insert the new lamp unit in correct direction. Tighten the three lamp unit fixing screws securely with a Phillips screwdriver

5) Close the lamp cover, and tighten the lamp cover fixing screw securely with a Phillips screwdriver.

- Close the lamp cover by pushing it slowly opposite the direction of the arrow.

Note

- When you replace the new lamp unit (ET-LAE200), the projector resets the total usage time of the lamp unit automatically.

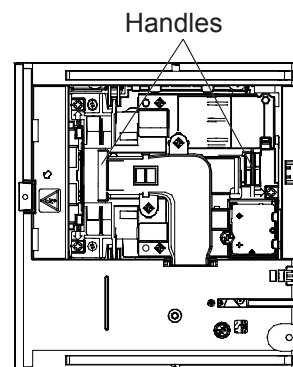
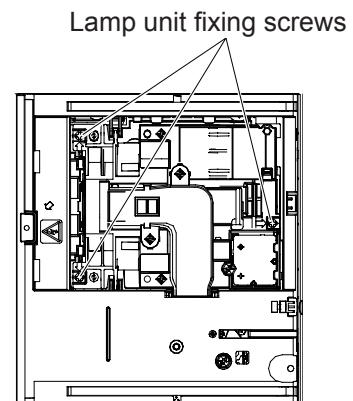
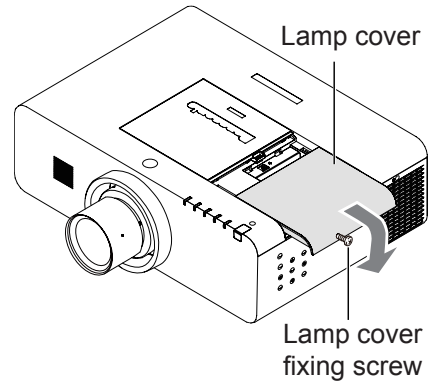

Troubleshooting

Please check following points. For details, see the corresponding pages.

Problem	Cause	Reference page
Power does not turn on.	● The power cord may not be connected.	—
	● No electric supply is at the wall outlet.	—
	● The circuit breakers have tripped.	—
	● Is the <LAMP> indicator, <ON(G)/STANDBY(R)> indicator, or <TEMP> indicator lit or blinking?	36, 89-92
	● The lamp cover has not been securely installed.	97
No picture appears.	● The video signal input source may not be connected to a terminal properly.	34
	● The input selection setting may not be correct.	41
	● The [Brightness] adjustment setting may be at the minimum setting.	55
	● The input source which is connected to the projector may have a problem.	—
	● The [Shutter] function may be in use.	41
The picture is fuzzy.	● The lens focus may not have been set correctly.	40
	● The projector may not be at the correct distance from the screen.	26
	● The lens may be dirty.	14
	● The projector may be tilted too much.	—
	● The lens cap is still attached to the lens.	16
The color is pale or grayish.	● [Color] or [Tint] adjustment may be incorrect.	55
	● The input source which is connected to the projector may not be adjusted correctly.	—
	● Computer cable is damaged.	—
No sound from the internal speaker	● The input terminals may not have been correctly connected.	34
	● The volume may have been set to the minimum level.	42, 61
	● The [Shutter] function may have been turned on.	41
	● When the AUDIO OUT is plugged-in, the projector's built-in speaker is not available.	22
	● The [Mute] function may have been turned on.	42, 61
	● Check the Build-in SP function.	61
The remote control does not operate.	● The batteries may be weak.	—
	● The batteries may not have been inserted correctly.	23
	● The remote control signal receptor on the projector may be obstructed.	19
	● The remote control unit may be out of the operation range.	19
	● Strong light such as fluorescent shine onto the signal receptor.	19
	● When different codes are set on the projector and on the remote control.	66
	● Check if the ON/OFF switch on the remote control is set to "ON."	—
	● Make sure that the simple mode in the remote control function is set to [Off].	66
		66
		66
The control buttons of the projector do not operate.	● The side control is not available if the side control is locked at [Key lock] under [Security] of [Setting] section.	68

Problem	Cause	Reference page
The picture does not display correctly.	<ul style="list-style-type: none"> There may be a problem with the VCR or other signal source. A signal which is not compatible with the projector is being input. 	— 109-113
Picture from a computer does not appear.	<ul style="list-style-type: none"> The cable may be longer than the optional cable. The external video output from a laptop computer may not be correct. 	— —
Picture from a HDMI device does not appear or picture is not stable.	<ul style="list-style-type: none"> Is the HDMI cable securely connected? Turn off the power of the projector and the connected devices. Then turn the power of the projector and the connected devices back on. Isn't unsupported signal cable connected? 	34 — 109-113
No sound is output from a HDMI device.	<ul style="list-style-type: none"> Set the sound channel of the attached device to Linear PCM. If no audio signal is output during HDMI cable connection, connect the audio cable to AUDIO IN 1 terminal and set to "Audio 1" in "Sound" of "Setting" menu. 	— 65
The image is distorted or runs off.	<ul style="list-style-type: none"> Check [PC adj.] or [Screen] and adjust them. 	52, 58
The exclamation mark  appears on the screen.	<ul style="list-style-type: none"> Your operation is invalid. Operate correctly. 	—
The shutter does not work.	<ul style="list-style-type: none"> Check [Protection] or [Release key] of the [Shutter] function. 	68

Note

- If the problem persists, after confirming the contents of the table, please consult your dealer.

Technical Information

PJLink protocol

The network function of the projector supports PJLink class 1, and the PJLink protocol can be used to perform projector setting and projector status query operations from a computer.

■ Control commands

The following table lists the PJLink protocol commands that can be used to control the projector.

Command	Control details	Notes
POWR	Power supply control	Parameters 0 = Standby 1 = Power ON
POWR ?	Power supply status query	Parameters 0 = Standby 1 = Power ON 2 = Cool-down in progress 3 = Warm-up in progress
INPT	Input selection	Parameters
INPT ?	Input selection query	11 = RGB 1 12 = RGB 2 13 = Scart 21 = VIDEO 1 22 = VIDEO 2 23 = S-VIDEO 24 = COMPONENT 1 25 = COMPONENT 2 31 = DIGITAL 1 32 = DIGITAL 2 33 = DIGITAL 3 46 = INPUT 1 47 = INPUT 2 48 = INPUT 3
AVMT	AV MUTE control	Parameters
AVMT ?	AV MUTE status query	30 = AV MUTE mode off 31 = AV MUTE mode on
ERST ?	Error status query	Parameters 1st byte : Indicates fan errors, range 0 – 2 2nd byte : Indicates lamp errors, range 0 – 2 3rd byte : Indicates temperature errors, range 0 – 2 4th byte : Fixed at 0 5th byte : Indicates filter errors, range 0 – 2 6th byte : Indicates other errors, range 0 – 2 Definitions for each value from 0 to 2 are as follows. 0 = No error known 1 = Warning 2 = Error
LAMP ?	Lamp status query	Parameters 1st digits (1 – 5 digits) : Lamp cumulative operating time 2nd digit : 0 = Lamp off, 1 = Lamp on
INST ?	Input selection list query	The followings are returned as parameters. “ 11 12 13 21 22 23 24 25 31 32 33 46 47 48”
NAME ?	Projector name query	The name set for [Projector name] in [Network] is returned.
INF1 ?	Manufacturer name query	“Panasonic” is returned.
INF2 ?	Model name query	Answer the model name with either “EZ570”, “EW630”, “EW530”, “EX600”, or “EX500”.
INF0 ?	Other information query	Information such as version number is returned.
CLSS ?	Class information query	“1” is returned.

■ PJLink security authorization

When using PJLink with security authorization, either of the password set for administrator privileges and the password set for user privileges with Web browser control can be used as the password for PJLink (➔page 86). When using PJLink without security authorization, set use without the password for administrator privileges and the password for user privileges of Web browser control.

For specifications regarding PJLink, refer to the Japan Business Machine and Information System Industries Association website.

<http://pjlink.jbmia.or.jp/>

Control commands via LAN

■ When WEB Control administrator rights password is set (Protect mode)

● Connection method

- 1) Obtain the IP address and port number (Initial set value = 1 024) of the projector and make a request for connection to the projector.

Acquire the IP address from the menu screen of the projector, and the port number from the WEB control page.

IP address : Obtain from MAIN MENU → [Network] → [Network status]

Port No. : Acquire from the WEB control “Detailed set up” → “Command port set up” page

- 2) There is a response from the projector.

Response data

Data section	Blank	Mode	Blank	Random number section	Termination symbol
“NTCONTROL” (ASCII string)	‘ ’ 0x20	‘1’ 0x31	‘ ’ 0x20	“zzzzzzzz” (ASCII code hexadecimal number)	(CR) 0x0d
9 bytes	1 byte	1 byte	1 byte	8 bytes	1 byte

Mode : 1 = Protect mode

- 3) Generate a 32-byte hash value from the following data using MD5 algorithm.

“xxxxxx:yyyyy:zzzzzzzz”

xxxxxx : Administrator rights user name for WEB CONTROL (Default user name is “admin1”)

yyyyy : Password of above administrator rights user (Default password is “panasonic”)

zzzzzzzz : 8-byte random number obtained in Step 2

● Command transmission method

Transmit using the following command format.

Transmitted data

Header		Data section	Termination symbol
Hash value (See above <Connection method>)	‘0’ 0x30	Control command (ASCII string)	(CR) 0x0d
32 bytes	1 byte	Undefined length	1 byte

Receive data

Header	Data section	Termination symbol
‘0’ 0x30	Control command (ASCII string)	(CR) 0x0d
1 byte	Undefined length	1 byte

Error response

Error message	Termination symbol
“ERR1” “ERR2” “ERR3” “ERR4” “ERR5” “ERRA”	(CR) 0x0d
Undefined control command Out of parameter range Busy state or no-acceptable period Timeout or no-acceptable period Wrong data length Password mismatch	
4 bytes	1 byte

■ When WEB Control administrator rights password is not set (Non-protect mode)

● Connection method

- 1) Obtain the IP address and port number (Initial set value = 1 024) of the projector and make a request for connection to the projector.

Acquire the IP address from the menu screen of the projector, and the port number from the WEB control page.

IP address : Obtain from MAIN MENU → [Network] → [Network status]

Port No. : Acquire from the WEB control “Detailed set up” → “Command port set up” page

- 2) There is a response from the projector.

Response data

Data section	Blank	Mode	Termination symbol
“NTCONTROL” (ASCII string)	‘ ’ 0x20	‘0’ 0x30	(CR) 0x0d
9 bytes	1 byte	1 byte	1 byte

Mode : 0 = Non-protect mode

● Command transmission method

Transmit by the following command format.

Transmitted data

Header		Data section	Termination symbol
‘0’ 0x30 1 byte	‘0’ 0x30 1 byte	Control command (ASCII string) Undefined length	(CR) 0x0d 1 byte

Receive data

Header		Data section	Termination symbol
‘0’ 0x30 1 byte	‘0’ 0x30 1 byte	Control command (ASCII string) Undefined length	(CR) 0x0d 1 byte

Receive data

Error message	Termination symbol
“ERR1” “ERR2” “ERR3” “ERR4” “ERR5” “ERRA”	(CR) 0x0d
Undefined control command Out of parameter range Busy state or no-acceptable period Timeout or no-acceptable period Wrong data length Password mismatch	
4 bytes	1 byte

Serial terminal

The serial connector which is on the connector panel of the projector conforms to the RS-232C interface specification, so that the projector can be controlled by a personal computer which is connected to this connector.

■ Connection

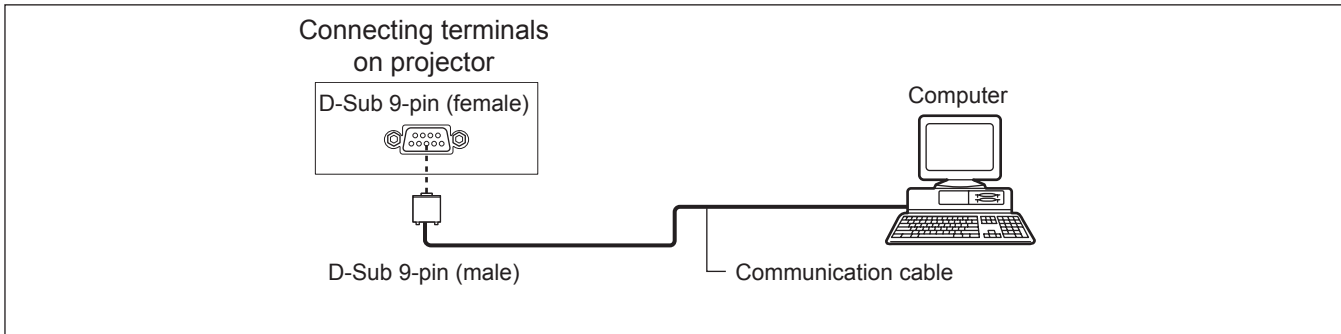

■ Pin assignments and signal names

D-Sub 9-pin (female) Outside view	Pin No.	Signal name	Contents
		①	—
②		TXD	Transmitted data
③		RXD	Received data
④		—	NC
⑤		GND	Earth
⑥		—	NC
⑦		RTS	Connected internally
⑧		CTS	
⑨		—	NC

■ Communication conditions

Signal level	RS-232C-compliant
Sync. method	Asynchronous
Baud rate	19 200 bps
Parity	None

Character length	8 bits
Stop bit	1 bit
X parameter	None
S parameter	None

Note

- When [AMX D. D.] function is set to [On] under the [Network] menu, the Baud rate will change to 9 600 bps automatically.

Basic format

Transmission from the computer begins with STX, then the command, parameter, and ETX are sent in this order. Add parameters according to the details of control.

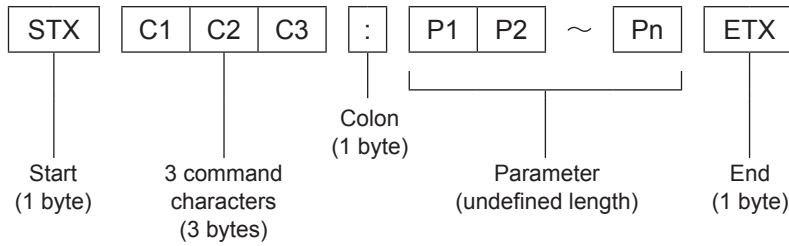

*: When sending commands without parameters, a colon (:) is not necessary.

Basic format (with sub command)

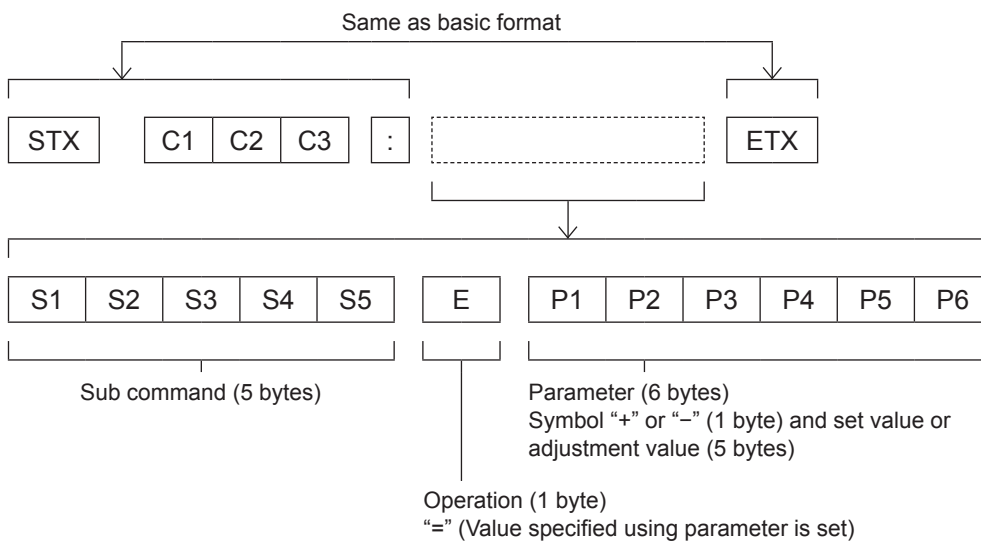

*: When transmitting a command which does not need a parameter, the operation (E) and parameter are not necessary.

■ Cable specifications

[When connected to a computer]

Projector	1	NC	NC	1	Computer (DTE specifications)
	2			2	
	3			3	
	4	NC	NC	4	
	5			5	
	6	NC	NC	6	
	7			7	
	8			8	
	9	NC	NC	9	

■ Control commands

When controlling the projector from a computer, the following commands are available:

[Projector control command]

Command	Control contents	Remarks
PON	Power [ON]	
POF	Power [OFF]	
IIS	INPUT selection	(Parameter) PC1 = PC1 PC2 = PC2 RG1 = RGB1 RG2 = RGB2 CP1 = INPUT 2 :Y, Pb/Cb, Pr/Cr CP2 = INPUT 3 :Y, Pb/Cb, Pr/Cr VD1 = INPUT 2 VIDEO VD2 = INPUT 3 VIDEO SVD = S-VIDEO DVI = DVI HD1 = HDMI SCT = Scart
OSH	AV mute function	Turn off the projection and sound temporarily. Do not send the command consecutively. (Parameters) 0 = AV MUTE mode off 1 = AV MUTE mode on
OFZ	Freeze	(Parameters) 0 = Freeze mode off 1 = Freeze mode on
AUU	Volume up	
AUD	Volume down	
DZU	D. ZOOM up	
DZD	D. ZOOM down	
QPW	Power query	000 = Standby 001 = Power on
Q\$\$	Lamp condition query	(Call back) 0 = Stand-by 1 = Lamp ON control active 2 = Lamp ON 3 = Lamp OFF control active

Other terminals

Pin assignments and signal names of <S-VIDEO IN> terminal

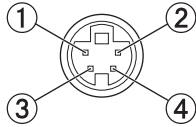
Outside view	Pin No.	Signal names
	①	GND (luminance signal)
	②	GND (color signal)
	③	Luminance signal
	④	Color signal

Pin assignments and signal names of <RGB> terminal

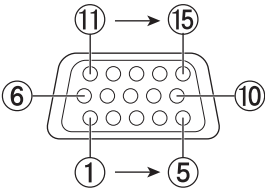
Outside view	Pin No.	Signal names
	①	R/P _R
	②	G/G · SYNC/Y
	③	B/P _B
	⑨	+ 5 V
	⑫	DDC data
	⑬	HD/SYNC
	⑭	VD
	⑮	DDC clock
	④	
	⑤ - ⑧, ⑩, ⑪	

④ : Not assigned
⑤ - ⑧, ⑩, ⑪ : GND terminals

Pin assignments and signal names of <MONITOR OUT> terminal

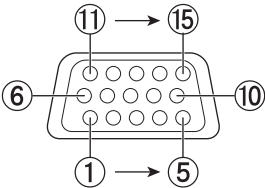
Outside view	Pin No.	Signal names
	①	R/P _R
	②	G/G · SYNC/Y
	③	B/P _B
	⑬	HD/SYNC
	⑭	VD
	④, ⑨, ⑪, ⑫, ⑮	
⑤ - ⑧, ⑩		

④, ⑨, ⑪, ⑫, ⑮ : Not assigned
⑤ - ⑧, ⑩ : GND terminals

Pin assignments and signal names of <HDMI> terminal

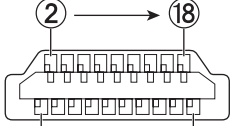
Outside view	Pin No.	Signal names	Pin No.	Signal names
<p>Even-numbered pins ② to ⑮</p>  <p>Odd-numbered pins ① to ⑮</p>	①	T.M.D.S data 2+	⑪	T.M.D.S clock shield
	②	T.M.D.S data 2 shield	⑫	T.M.D.S clock -
	③	T.M.D.S data 2-	⑬	CEC
	④	T.M.D.S data 1+	⑭	—
	⑤	T.M.D.S data 1 shield	⑮	SCL
	⑥	T.M.D.S data 1-	⑯	SDA
	⑦	T.M.D.S data 0+	⑰	DDC/CEC GND
	⑧	T.M.D.S data 0 shield	⑱	+5V
	⑨	T.M.D.S data 0-		Hot plug detection
	⑩	T.M.D.S clock +		

Pin assignments and signal names of <DVI-D> terminal

Outside view	Pin No.		Pin No.	Signal names
	1	T.M.D.S. Data2-	15	Ground (for +5V)
	2	T.M.D.S. Data2+	16	Hot Plug Detect
	3	T.M.D.S. Data2 Shield	17	T.M.D.S. Data0-
	6	DDC Clock	18	T.M.D.S. Data0+
	7	DDC Data	19	T.M.D.S. Data0 Shield
	9	T.M.D.S. Data1-	22	T.M.D.S. Clock Shield
	10	T.M.D.S. Data1+	23	T.M.D.S. Clock+
	11	T.M.D.S. Data1 Shield	24	T.M.D.S. Clock-
	14	+5V Power		

4, 5, 8, 12, 13, 20, 21: Not assigned

Technical Information

List of Picture in Picture

Sub Window \ Main Window		INPUT 1					INPUT 2			INPUT 3		
		RGB(PC analog)	RGB(Scart)	DVI-D	DVI-D(HDCP)	HDMI	Video	Y, Pb/Cb, Pr/Cr	RGB	Video	Y, Pb/Cb, Pr/Cr	S-video
INPUT 1	RGB(PC analog)	x	x	○	○	○	○	○	○	○	○	○
	RGB(Scart)	x	x	○	○	○	x	○	○	x	○	x
	DVI-D	○	○	x	x	x	○	○	○	○	○	○
	DVI-D(HDCP)	○	○	x	x	x	○	○	○	○	○	○
	HDMI	○	○	x	x	x	○	○	○	○	○	○
INPUT 2	Video	○	x	○	○	○	x	x	x	x	x	x
	Y, Pb/Cb, Pr/Cr	○	○	○	○	○	x	x	x	○	○	○
	RGB	○	○	○	○	○	x	x	x	○	○	○
INPUT 3	Video	○	x	○	○	○	x	○	○	x	x	x
	Y, Pb/Cb, Pr/Cr	○	○	○	○	○	x	○	○	x	x	○
	S-video	○	x	○	○	○	x	○	○	x	○	x

○ : Picture in Picture combinations are enabled.

x : Picture in Picture combinations are disabled

Note

- When the input signal(s) is/are incompatible, **x** mark will be displayed on the Main/Sub picture.
- Depending on the frequency or signal type of PC/AV input, the display resolution may be lowered or images may not be displayed on the Main/Sub picture.

<Display resolution is lowered when;>

Inputting PC analog signals: Between 100-162*1 MHz

<Images are not displayed and **x** mark appears when;>

- Inputting PC analog signals: More than 162*2 MHz
- Inputting PC digital signals: More than 100 MHz
- Inputting AV analog signals: 1 080p

<Picture in Picture is disabled when;>

- Inputting signal formats: SXGA 20, WUXGA 1, WUXGA 2, WSXGA+1, WXGA+2, UXGA 1, UXGA 2, UXGA 3, UXGA 4, D-1 080p.

*1 : Between 100-162 MHz (Only for EZ570 series.)

Between 100-140 MHz (Only for EW630 series, EW530 series, EX600 series and EX500 series.)

*2 : More than 162 MHz (Only for EZ570 series.)

More than 140 MHz (Only for EW630 series, EW530 series, EX600 series and EX500 series.)

List of compatible signals

The following table specifies the types of signals compatible with the projectors.

Format : V = VIDEO, S = S-VIDEO, C = COMPUTER, Y = YP_BP_R, H = HDMI, D = DVI-D

Mode	Display resolution *1 (dots)	Scanning frequency		Dot clock frequency (MHz)	Picture quality *2			PnP*3	Format
		H (kHz)	V (Hz)		EW630 series EW530 series	EX600 series EX500 series	EZ570 series		
NTSC/NTSC4.43/ PAL-M/PAL60	720 x 480i	15.700	59.900	—	A	A	A		V/S
PAL/PAL-N/ SECAM	720 x 576i	15.600	50.000	—	A	A	A		V/S
480p	640 x 480	31.470	59.880	25.20	A	A	A		C/Y
480i	640 x 480i	15.734	60.000	12.273	A	A	A		
576p	768 x 576	31.250	50.000	29.500	A	A	A		
576i	768 x 576i	15.625	50.000	14.750	A	A	A		
720p	1 280 x 720	37.500	50.000	74.250	AA	A	A		
		45.000	60.000	74.250	AA	A	A		
1 035i	1 920 x 1 035i	33.750	60.000	74.250	A	A	AA		
1 080i	1 920 x 1 080i	28.125	50.000	74.250	A	A	AA		
		33.750	60.000	74.250	A	A	AA		
1 080p	1 920 x 1 080	33.750	30.000	74.250	A	A	AA		
		28.125	25.000	74.250	A	A	AA		
		27.000	24.000	74.250	A	A	AA		
		67.500	60.000	148.50	B	B	AA		
		56.250	50.000	148.50	B	B	AA		
1 080psf/30	1 920 x 1 080	33.750	60.000	74.250	A	A	AA		
1 080psf/25		28.125	50.000	74.250	A	A	AA		
1 080psf/24		27.000	48.000	74.250	A	A	AA		
1 920 x 1 080/60	1 920 x 1 080	67.079	60.020	172.80	B	B	B		
MAC	1 280 x 960	75.000	75.080	126.00	A	A	A		
	1 280 x 1 024	80.000	75.080	135.20	A	A	A		
MAC 13	640 x 480	35.000	66.670	30.240	A	A	A		
MAC 16	832 x 624	49.720	74.550	57.283	A	A	A		
MAC 19	1 024 x 768	60.240	75.080	80.010	A	AA	A		
MAC 21	1 152 x 870	68.680	75.060	100.000	A	A	A		
MAC LC13	640 x 480	34.970	66.600	31.330	A	A	A		
VGA	640 x 480	31.470	59.880	25.149	A	A	A	○	
		37.860	74.380	31.500	A	A	A		
		37.860	72.810	31.500	A	A	A	○	
		37.500	75.000	31.500	A	A	A	○	
	640 x 400	43.269	85.000	36.000	A	A	A		
720 x 400	31.470	70.090	25.175	A	A	A			
SVGA	800 x 600	35.156	56.250	36.000	A	A	A	○	
		37.880	60.320	40.000	A	A	A	○	
		46.875	75.000	49.500	A	A	A	○	
		53.674	85.060	56.250	A	A	A		
		48.080	72.190	50.000	A	A	A	○	
		37.900	61.030	40.020	A	A	A		
		34.500	55.380	36.432	A	A	A		

Technical Information

Mode	Display resolution *1 (dots)	Scanning frequency			Picture quality *2			PnP*3	Format
		H (kHz)	V (Hz)	Dot clock frequency (MHz)	EW630 series EW530 series	EX600 series EX500 series	EZ570 series		
SVGA	800 x 600	38.000	60.510	40.128	A	A	A		C
		38.600	60.310	38.600	A	A	A		
		32.700	51.090	32.700	A	A	A		
		38.000	60.510	40.128	A	A	A		
XGA	1 024 x 768	48.360	60.000	65.000	A	AA	A	○	
		68.677	84.997	94.504	A	AA	A		
		60.023	75.030	78.750	A	AA	A	○	
		56.476	70.070	75.000	A	AA	A	○	
		60.310	74.920	79.252	A	AA	A		
		48.500	60.020	65.179	A	AA	A		
		44.000	54.580	59.129	A	AA	A		
		63.480	79.350	83.410	A	AA	A		
		62.040	77.070	84.375	A	AA	A		
		61.000	75.700	81.000	A	AA	A		
	46.900	58.200	63.030	A	AA	A			
	47.000	58.300	61.664	A	AA	A			
	58.030	72.000	74.745	A	AA	A			
	1 024 x 768i	36.000	87.170	47.300	A	A	A		
35.522	86.960	44.900	A	A	A				
SXGA	1 152 x 864	64.200	70.400	94.560	A	A	A		
	1 152 x 900	61.200	65.200	92.000	A	A	A		
		71.400	75.600	105.100	A	A	A		
	1 280 x 1 024	61.850	66.000	94.500	A	A	A		
		62.500	58.600	108.000	A	A	A		
		63.900	60.000	107.350	A	A	A		
		63.340	59.980	108.180	A	A	A		
		63.740	60.010	109.497	A	A	A		
		71.690	67.190	117.004	A	A	A		
		81.130	76.107	135.008	A	A	A		
		63.980	60.020	108.00	A	A	A		
		79.976	75.025	135.00	A	A	A		
		63.370	60.010	111.520	A	A	A		
	76.970	72.000	130.080	A	A	A			
	63.790	60.180	108.190	A	A	A			
	91.146	85.024	157.500	B	B	A			
1 280 x 960	60.000	60.000	108.000	A	A	A			
1 280 x 1 024i	50.000	86.000	80.000	A	A	A			
	50.000	94.000	80.000	A	A	A			
WXGA	1 280 x 768	46.430	86.700	78.745	A	A	A		
		47.776	59.870	79.500	AA	A	A		
		60.289	74.893	102.250	AA	A	A		
		68.633	84.837	117.500	AA	A	A		
		55.993	69.991	94.964	AA	A	A		
57.675	72.004	97.817	AA	A	A				

Technical Information

Mode	Display resolution *1 (dots)	Scanning frequency		Dot clock frequency (MHz)	Picture quality *2			PnP*3	Format
		H (kHz)	V (Hz)		EW630 series EW530 series	EX600 series EX500 series	EZ570 series		
WXGA	1 280 x 800	49.600	60.050	79.360	AA	A	A		C
		41.200	50.000	68.557	AA	A	A		
		49.702	59.810	83.500	AA	A	A	○*4	
		63.980	60.020	108.000	AA	A	A		
		58.289	69.975	98.858	AA	A	A		
		60.044	71.995	102.795	AA	A	A		
		62.790	74.928	106.492	AA	A	A		
	71.553	84.879	122.498	AA	A	A			
	1 366 x 768	48.360	60.000	86.670	A	A	A		
	1 360 x 768	47.700	60.000	86.670	A	A	A		
56.160		72.000	100.190	A	A	A			
1 376 x 768	48.360	60.000	86.670	A	A	A			
UXGA	1 600 x 1 200	75.000	60.000	162.000	B	B	A		
		81.250	65.000	175.500	B	B	B		
		87.500	70.000	189.000	B	B	B		
		93.750	75.000	202.500	B	B	B		
		106.250	85.000	229.500	B	B	B		
SXGA+	1 400 x 1 050	63.970	60.190	107.990	A	A	A		
		63.350	60.120	122.850	A	A	A		
		65.120	59.900	122.430	A	A	A		
		64.030	60.010	108.160	A	A	A		
		62.500	58.600	108.000	A	A	A		
		64.744	59.948	101.000	A	A	A		
WXGA+	1 400 x 900	55.935	59.887	106.500	A	A	A		
	1 400 x 900	74.918	60.000	161.850	B	B	A		
WSXGA+ 1	1 680 x 1 050	65.290	59.954	146.250	B	B	A		
WUXGA	1 920 x 1 200	74.556	59.885	193.250	B	B	B	○*5	
		74.038	59.950	154.000	B	B	AA		
D-480p	720 x 480	31.470	60.000	27.000	A	A	A	○	
D-480i *6	720 x 480	15.734	60.000	-	A	A	A		
D-576p	720 x 576	31.205	50.000	27.000	A	A	A	○	
D-576i *6	720 x 576	15.625	50.000	-	A	A	A		
D-720p	1 280 x 720	45.000	60.000	74.250	A	A	A	○	
		37.500	50.000	74.250	A	A	A	○	
D-1 035i	1 920 x 1 035i	33.750	60.000	74.250	A	A	AA		
D-1 080i	1 920 x 1 080i	33.750	60.000	74.250	A	A	AA	○	
		28.125	50.000	74.250	A	A	AA	○	
D-1 080p	1 920 x 1 080	33.750	30.000	74.250	A	A	AA		
		28.125	25.000	74.250	A	A	AA		
		27.000	24.000	74.250	A	A	AA		
		67.500	60.000	148.500	B	B	AA		
		56.250	50.000	148.500	B	B	AA		
D-1 080psf/30	1 920 x 1 080	33.750	60.000	74.250	A	A	AA		
D-1 080psf/25	1 920 x 1 080	28.125	50.000	74.250	A	A	AA		
D-1 080psf/24	1 920 x 1 080	27.000	48.000	74.250	A	A	AA		

Technical Information

Mode	Display resolution *1 (dots)	Scanning frequency			Picture quality *2			PnP*3	Format
		H (kHz)	V (Hz)	Dot clock frequency (MHz)	EW630 series EW530 series	EX600 series EX500 series	EZ570 series		
D-VGA	640 x 480	31.470	59.940	25.175	A	A	A	○	H/D
D-XGA	1 024 x 768	43.363	60.000	65.000	A	AA	A	○	
D-SVGA	800 x 600	37.879	60.320	40.000	A	A	A	○	
D-SXGA	1 280 x 1 024	63.980	60.020	108.000	A	A	A		
		60.276	58.069	93.067	A	A	A		
D-WXGA	1 280 x 768	47.776	59.870	79.500	AA	A	A		
		60.289	74.893	102.250	AA	A	A		
		68.633	84.837	117.500	AA	A	A		
		49.600	60.050	79.360	AA	A	A		
		41.200	50.000	68.557	AA	A	A		
		49.702	59.810	83.500	AA	A	A		
		63.980	60.020	108.000	AA	A	A		
		55.993	69.991	94.964	AA	A	A		
	57.675	72.004	97.817	AA	A	A			
	1 280 x 800	49.600	60.050	79.360	AA	A	A		
		41.200	50.000	68.557	AA	A	A		
		49.702	59.810	83.500	AA	A	A		
		63.980	60.020	108.000	AA	A	A		
		58.289	69.975	98.858	AA	A	A		
		60.044	71.995	102.795	AA	A	A		
		62.790	74.928	106.492	AA	A	A		
	71.553	84.879	122.498	AA	A	A			
	1 360 x 768	47.700	60.000	86.670	A	A	A		
		56.160	72.000	100.190	A	A	A		
	1 366 x 768	48.360	60.000	86.670	A	A	A		
46.500		50.000	67.400	A	A	A			
1 376 x 768	48.360	60.000	86.670	A	A	A			
D-SXGA+	1 400 x 1 050	63.970	60.190	107.990	A	A	A		
		65.350	60.120	122.850	A	A	A		
		65.120	59.900	122.430	A	A	A		
		64.030	60.010	108.160	A	A	A		
		62.500	58.600	108.000	A	A	A		
		64.744	59.948	101.000	A	A	A		
		65.317	59.978	121.750	A	A	A		
D-UXGA	1 600 x 1 200	75.000	60.000	162.000	A	A	A		
D-WUXGA	1 920 x 1 200	74.038	59.950	154.000	A	A	AA		
D-WSXGA+	1 680 x 1 050	65.290	59.954	146.250	A	A	A		
D-WXGA+	1 440 x 900	55.935	59.887	106.500	A	A	A		

- *1 : "i" added to the resolution value indicates an interlaced signal.
- *2 : Picture quality is indicated by the following symbols.
 - AA: Maximum picture quality can be obtained.
 - A: Signals are converted by the image processing circuit.
 - B: Some loss of data occurs to make projection easier.
- *3 : Where marked "o" signals indicates in Plug and Play is compatible with EDID of projector. Unmarked signals in Plug and Play may also be compliant if input terminals are written in the format list. Where Plug and Play is unmarked and nothing is written in the format list, difficulties in projecting image may occur even when computer and projector appear to have same resolution.
- *4 : Only for EW630 series and EW530 series.
- *5 : Only for EZ570 series.
- *6 : D-480i and D-576i are only for HDMI input.

Note

- The number of display dots is 1 920 x 1 200 for the EZ570 series ,1 280 x 800 for the EW630 series and EW530 series, 1 024 x 768 for the EX600 series and EX500 series.
 - A signal with a different resolution will be projected after converting the resolution to match the projector display.
- When interlaced signals are connected, flicker may occur on the projected image.

Specifications

Model No.		EW530 series	EW630 series	EX500 series	EX600 series	EZ570 series
Power supply		AC100 V - 240 V 50 Hz/60 Hz				
Power consumption		100 V - 240 V 4.9 A-2.0 A 490 W				
		When [Standby mode] of [Setting] is set to [ECO]: 0.4W				
		When [Standby mode] of [Setting] is set to [Network]: 11W				
		When [Standby mode] of [Setting] is set to [Normal]: 15W				
LCD panel	Panel size	1.91 cm(0.75") (aspect ratio 16 : 10)		1.93 cm(0.8") (aspect ratio 4 : 3)		2.0 cm(0.76") (aspect ratio 16 : 10)
	Display method	3 transparent LCD panels (RGB)				
	Drive method	Active matrix method				
	Pixels	1 024 000 (1 280 x 800) x 3 panels		786 432 (1 024 x 768) x 3 panels		2 304 000 (1 920 x 1 200) x 3 panels
Lens*1		Motorised zoom: 1.6~2.8:1 Motorised focus: F 1.7 to 2.3, f 26.9 mm to 45.4 mm				
Luminous lamp		330 W UHM lamp				
Light output *2		4 500 lm	5 500 lm	5 000 lm	6 000 lm	5 000 lm
Applicable scanning frequency *3	for RGB signal	Horizontal 15 kHz to 120 kHz, Vertical 48 Hz to 100 Hz				
		Dot clock frequency: up to 140 MHz				up to 162 MHz
	for YP _B Pr signal	[525i(480i)]	Horizontal 15.75 kHz, Vertical 60 Hz			
		[525p(480p)]	Horizontal 31.5 kHz, Vertical 60 Hz			
		[750(720)/60p]	Horizontal 45 kHz, Vertical 60 Hz			
[1 125(1 080)/60i]		Horizontal 33.75 kHz, Vertical 60 Hz				
for Video signal (including S-video)	[625i(576i)]	Horizontal 15.63 kHz, Vertical 50 Hz				
	[625p(576p)]	Horizontal 31.25 kHz, Vertical 50 Hz				
	[750(720)/50p]	Horizontal 37.5 kHz, Vertical 50 Hz				
	[1 125(1 080)50i]	Horizontal 28.13 kHz, Vertical 50 Hz				
for HDMI signal	525p(480p), 625p(576p), 750(720)/60p, 750(720)/50p, 1 125(1 080)/60p, 1 125(1 080)/50p, 1 125(1 080)/60i, 1 125(1 080)/50i					
	● Displayable resolution: VGA to WUXGA (non-interlace) ● Dot clock frequency: 162 MHz or less					
Color system		7 (NTSC, NTSC4.43, PAL, PAL-N, PAL-M, SECAM, PAL60)				
Projection size		40"- 400" (For aspect ratio : 16 : 10)		40"- 400" (For aspect ratio : 4 : 3)		40"- 400" (For aspect ratio : 16 : 10)
Screen aspect ratio		16 : 10		4 : 3		16 : 10
Projection scheme		Front / Rear / Mount on Ceiling / Floor (Menu setting system)				
Speaker		1 (3.7 cm round-type)				
Maximum usable volume output		10W				
Contrast ratio *2		2 000 : 1 (all white / all black)	5 000 : 1 (all white / all black)	2 000 : 1 (all white / all black)	5 000 : 1 (all white / all black)	

*1 : It is only for the model which with lens.

*2 : Measurement, measuring conditions and method of notation all comply with ISO21118 international standards.

*3 : For details of video signals that can be projected using this projector, refer to "List of compatible signals".
(➡ pages 109 -113)

Specifications

Model No.		EW530 series	EW630 series	EX500 series	EX600 series	EZ570 series
Terminals	INPUT 1 <DVI-D> <HDMI> <RGB>	※Choose one item in the menu DVI-D 24-pin (Single link), DVI 1.0 compatible, HDCP compatible HDMI 19-pin (HDCP and Deep color compatible) D-sub HD 15-pin (female) [RGB signal] 0.7 V [p-p] 75 Ω (When G-SYNC is set: 1.0 V [p-p] 75 Ω) HD/SYNC TTL high impedance, automatic positive/negative polarity compatible VD TTL high impedance, automatic positive/negative polarity compatible				
	INPUT 2 <VIDEO> <YPbPr> <RGB, SYNC/ HD, VD>	※Choose one item in the menu BNC×1 [VIDEO signal] (1.0 V [p-p] 75 Ω) BNC×3 [YPbPr signal] Y: 1.0 V [p-p] including synchronization signal, PbPr: 0.7 V [p-p] 75 Ω BNC×5 [RGB signal] 0.7 V [p-p] 75 Ω (When G-SYNC: 1.0 V [p-p] 75 Ω) HD/SYNC TTL high impedance, automatic positive/negative polarity compatible VD TTL high impedance, automatic positive/negative polarity compatible				
	INPUT 3 <VIDEO> <YPbPr/YCbCr> <S-VIDEO>	※Choose one item in the menu RCA×1 [VIDEO signal] 1.0 V [p-p] 75 Ω RCA×3 [YPbPr signal] Y: 1.0 V [p-p] including synchronization signal, PbPr: 0.7 V [p-p] 75 Ω Mini DIN 4 pin [S-VIDEO signal] Y: 1.0 V [p-p], C: 0.286 V [p-p] 75 Ω, S1 signal compatible				
	<MONITOR OUT>	1 (D-sub HD 15 pin (female)) [RGB signal] 0.7 V [p-p] 75 Ω (When G-SYNC is set: 1.0 V [p-p] 75 Ω)				
	<AUDIO IN>	2 (M3 stereo mini jack, 0.5 V [rms], input impedance 22 kΩ and more) 1 (RCA pin jack x 2 (L-R), 0.5 V [rms], input impedance 22 kΩ and more)				
	<VARIABLE AUDIO OUT>	1 (M3 stereo mini jack, stereo monitor output compatible, 0 V [rms] to 2.0 V [rms] valuable, output impedance 2.2 kΩ and less)				
	<SERIAL IN>	1 (D-sub 9 pin, RS-232C compliant, for computer control use)				
<LAN>	1 (for RJ-45 network connection, PLink compatible,)					
Power cable length		3.0 m (118.1")				
Cabinet		Molded plastic				
Dimensions		Width: 489.5 mm (19.27") Height: 164 mm (6.46") (when front adjustable feet shortened) Depth: 370.1 mm (14.57")*4 (including protractions) 433.8 mm (17.08")*5 (including protractions)				
Weight		Approx. 9.5 kg (20.94 lbs.) *6 Approx. 10.2 kg (22.49 lbs.) *7	Approx. 9.6 kg (21.12 lbs.) *6 Approx. 10.3 kg (22.71 lbs.) *7	Approx. 9.5 kg (20.94 lbs.) *6 Approx. 10.2 kg (22.49 lbs.) *7	Approx. 9.6 kg (21.12 lbs.) *6 Approx. 10.3 kg (22.71 lbs.) *7	
Operating environment		Operating environment temperature : 0 °C (32 °F) to 40 °C (104 °F)*8 Operating environment humidity: 20 % to 80 % (no condensation)				
Remote control	Power supply	DC 3 V (battery (AAA/R03 or AAA/LR03 Type) x 2)				
	Operating range	Approx. 5 m (196.9") (when operated directly in front of receptor)				
	Weight	102 g (3.60 ozs.) (including batteries)				
	Dimensions	Width : 48 mm (1.89"), Length : 145 mm (5.71"), Height : 27 mm (1.06")				

*4 : The depth is for the projector that without the projection lens.

*5 : The depth is for the projector that with the standard projection lens.

*6 : This is an average value. It may differ depending on individual product. It is only for PT-EW530EL, PT-EW630EL, PT-EX500EL, PT-EX600EL and PT-EZ570EL.

*7 : This is an average value. It may differ depending on individual product. It is only for PT-EW530E, PT-EW630E, PT-EX500E, PT-EX600E and PT-EZ570E.

*8 : When using the projector at high elevation 1 000 m to 2 700 m sea level, the operating environment temperature will be 0°C to 30°C.

● The part numbers of accessories and separately sold components are subject to change without notice.

Specifications

Dimensions

<Unit : mm (inch)>

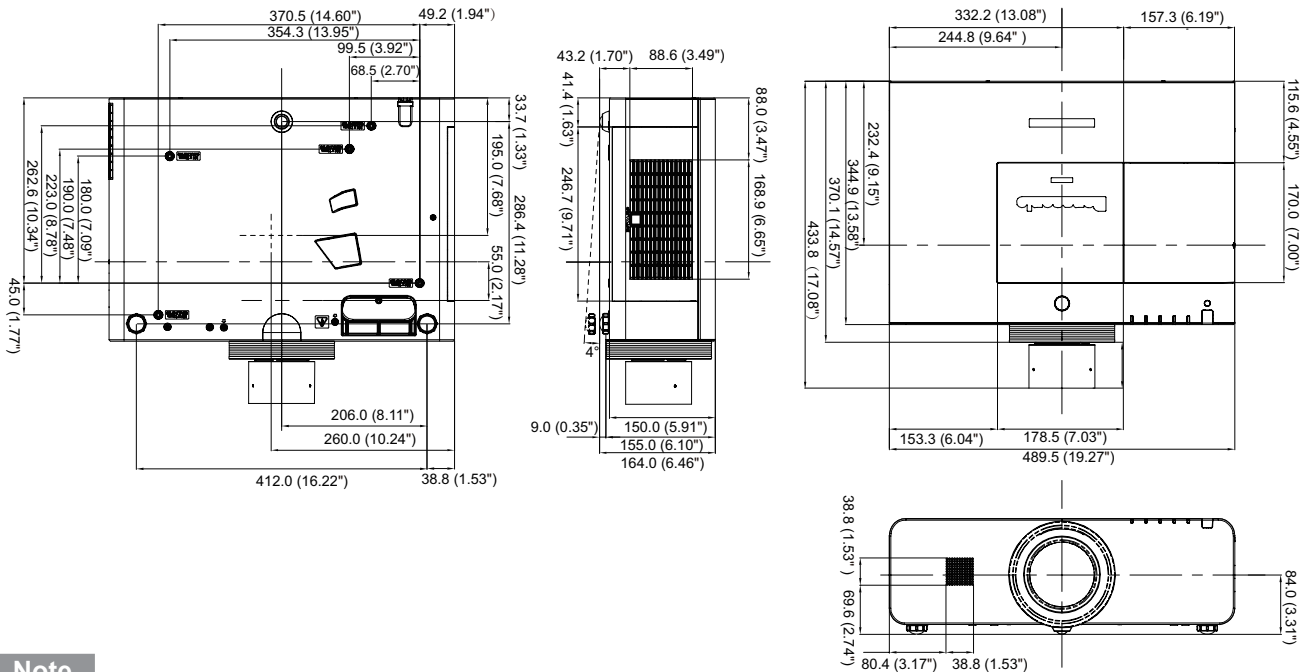

Note

- Actual dimension may differ by product.
- The dimension is for the projector with a standard lens.
- The dimension of the lens center is when the lens shift to the center position.

Ceiling mount bracket safeguards

- Installation work of the ceiling mount bracket should only be carried by a qualified technician.
- Even if it is during guaranteed period, the manufacturer is not responsible for any hazard or damage caused by using a ceiling mount bracket which is not purchased from an authorized distributors, or environmental conditions.
- Remove an unused ceiling mount bracket promptly.
- Ensure to use a torque driver and do not use an electrical screwdriver or an impact screwdriver.
- For details, see the work instruction manual packed together with the ceiling mount bracket.
- The model Nos. of the accessories and the parts sold separately are subject to change without notice.
- Make sure the screws on the ceiling mount kit cannot touch the metal parts materials (metallic lath, wire or board) in the ceiling board. Otherwise it may result in fire hazard.

Bottom view

Model No. of ceiling mount bracket:
 ET-PKE200H (for high ceilings)
 ET-PKE200S (for low ceilings)
 Model No. of projector mount base:
 ET-PKE200B

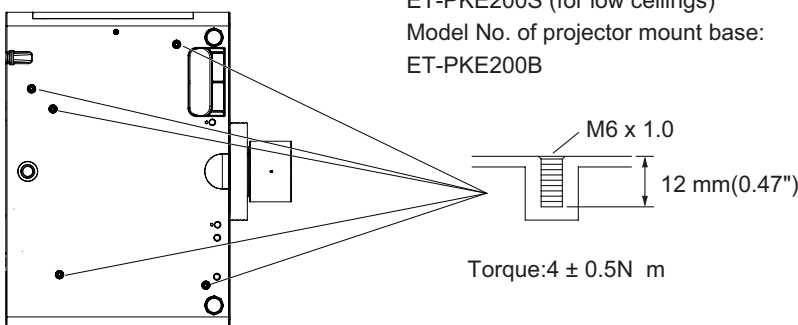

Index

A			
About Your Projector.....	18	Image adjust.....	55
Accessing from the Web browser...75		Image select.....	54
Accessories.....	16	Indicators.....	21
Adjusting front adjustable feet.....33		Information.....	71
Adjusting the image.....	40	Input button.....	62
AUTO PC adjust.....	51	Input menu.....	49
		Installing and Removing batteries ..23	
B		Iris.....	55
Background.....	63	K	
Basic operations by using the remote control.....41		Keystone.....	44, 59
Brightness.....	55	L	
Built-in SP.....	61	Lamp power.....	65
C		Lamp unit.....	96
Cautions on use.....	14	Language.....	62
Cautions when handling the projector.....12		List of compatible signals.....109	
Cautions when installing.....	12	List of Picture in Picture.....108	
Cautions when transporting.....	12	Logo.....	63
CD-ROM.....	17	M	
Ceiling.....	60	Main menu.....	47
Cinema.....	54	Maintenance.....	93
Closed caption.....	69	Manual PC adjust.....	52
Color.....	55	Menu/Menu position.....	62
Color temp.....	56	Menu Navigation.....	46
Computer System Selection.....49		Mute.....	61
Connecting.....	34	N	
Connecting the power cord.....35		Natural.....	54
Contrast.....	55	Natural wide.....	58
Control commands via LAN.....101		Network.....	72
Custom.....	58	Network connections.....	74
Custom adj.....	59	Noise reduction.....	57
		Normal.....	58
D		O	
Daylight View.....	56	Offset.....	56
Digital zoom.....	59	ON(G)/STANDBY(R) indicator.....36	
Direct on.....	67	Optional accessories.....	17
Direct Power Off function.....39		Other terminals.....	106
Display.....	63	P	
Disposal.....	14	Picture in Picture.....	64
DVI signal level.....	65	PIN code.....	38
Dynamic.....	54	PJLink protocol.....	100
E		Power management.....	67
ECO.....	43	Precautions for Use.....	12
Eco management.....	66	Progressive.....	57
F		Projecting.....	40
Factory default.....	70	Projection distance.....26, 28, 29	
Fan control.....	65	Projection method.....	24
Filter counter.....	70	Projector body.....	20
FREEZE.....	43	P-timer.....	67
Full.....	58	R	
G		RC sensor.....	66
Gamma.....	57	Read this first!.....	2
H		Real.....	54
HDMI setup.....	65	Rear.....	60
I		Rear terminals.....	22
ID numbers.....	23	Remote control.....	18, 66
If an indicator turns on.....89		Removing and attaching the projection lens.....25	
		Replacing the Lamp unit.....97	
		Replacing the unit.....	95
		S	
		Screen.....	58
		Screen aspect.....	60
		Screen size and throw distance.....26	
		Security.....	14, 68
		Selecting the image.....	40
		Serial terminal.....	103
		Setting.....	62
		Setting the ID number.....	23
		Setting up.....	24
		Sharpness.....	57
		Shutter.....	68
		SHUTTER/ AV MUTE.....	41
		Side control.....	21
		Simple mode.....	66
		Sound.....	61
		Specifications.....	114
		Standard.....	54
		Standby mode.....	67
		Sub menu.....	47
		Switching the input signal.....41	
		T	
		Test pattern.....	70
		Tint.....	55
		Troubleshooting.....	98
		True.....	58
		Turning Off the Projector.....39	
		Turning On the Projector.....37	
		V	
		Video delay control.....	69
		Video System Selection.....49	
		Volume.....	61
		W	
		Wide(16:9).....	58
		Z	
		Zoom.....	58

Information for Users on Collection and Disposal of Old Equipment and used Batteries



These symbols on the products, packaging, and/or accompanying documents mean that used electrical and electronic products and batteries should not be mixed with general household waste. For proper treatment, recovery and recycling of old products and used batteries, please take them to applicable collection points, in accordance with your national legislation and the Directives 2002/96/EC and 2006/66/EC.



By disposing of these products and batteries correctly, you will help to save valuable resources and prevent any potential negative effects on human health and the environment which could otherwise arise from inappropriate waste handling.

For more information about collection and recycling of old products and batteries, please contact your local municipality, your waste disposal service or the point of sale where you purchased the items.



Penalties may be applicable for incorrect disposal of this waste, in accordance with national legislation.

For business users in the European Union

If you wish to discard electrical and electronic equipment, please contact your dealer or supplier for further information.

Information on Disposal in other Countries outside the European Union

These symbols are only valid in the European Union. If you wish to discard these items, please contact your local authorities or dealer and ask for the correct method of disposal.

Note for the battery symbol (bottom two symbol examples):

This symbol might be used in combination with a chemical symbol. In this case it complies with the requirement set by the Directive for the chemical involved.

Panasonic Corporation

Web Site : <http://panasonic.net/avc/projector/>

© Panasonic Corporation 2012

M0412HZ1052 -ST