

SHARP®

PROJECTOR

MODEL

XV-Z30000

OPERATION MANUAL

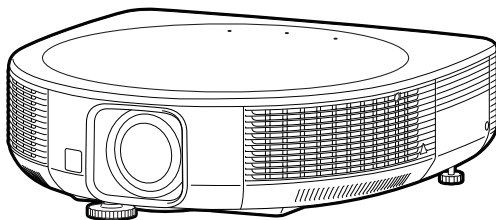

3D



HDMI™
HIGH-DEFINITION MULTIMEDIA INTERFACE

Introduction

Easy Start

Setup

Connections

Basic
Operation

Useful
Features

Appendix

IMPORTANT

- For your assistance in reporting the loss or theft of your Projector, please record the Model and Serial Number located on the bottom of the projector and retain this information.
- Before recycling the packaging, please ensure that you have checked the contents of the carton thoroughly against the list of "Supplied accessories" on page **12**.

Model No.:

Serial No.:

The supplied CD-ROM contains operation instructions in English, German, French, Spanish, Swedish, Portuguese and Chinese. Carefully read through the operation instructions before operating the projector.

Die mitgelieferte CD-ROM enthält Bedienungsanleitungen in Englisch, Deutsch, Französisch, Spanisch, Schwedisch, Portugiesisch und Chinesisch. Bitte lesen Sie die Bedienungsanleitung vor der Verwendung des Projektors sorgfältig durch.

Le CD-ROM fourni contient les instructions de fonctionnement en anglais, allemand, français, espagnol, suédois, portugais et chinois. Veuillez lire attentivement ces instructions avant de faire fonctionner le projecteur.

El CD-ROM suministrado contiene instrucciones de operación en inglés, alemán, francés, español, sueco, portugués y chino. Lea cuidadosamente las instrucciones de operación antes de utilizar el proyector.

Den medföljande CD-ROM-skivan innehåller bruksanvisningar på engelska, tyska, franska, spanska, svenska, portugisiska och kinesiska. Läs noga igenom bruksanvisningen innan projektorn tas i bruk.

O CD-ROM fornecido contém instruções de operação em Inglês, Alemão, Francês, Espanhol, Sueco, Português e Chinês. Leia cuidadosamente todas as instruções de operação antes de operar o projetor.

附送之CD-ROM光碟中，有用英文、德文、法文、西班牙文、瑞典文、葡萄牙文和中文所寫的使用說明書。在操作本投影機之前，請務必仔細閱讀整本使用說明書。

Authorized representative responsible for the European Union Community Market

SHARP ELECTRONICS (Europe) GmbH
Sonninstraße 3, D-20097 Hamburg

E.U. ONLY

Before using the projector, please read this operation manual carefully.

Introduction



ENGLISH

WARNING: High brightness light source. Do not stare into the beam of light, or view directly. Be especially careful that children do not stare directly into the beam of light.



WARNING: To reduce the risk of fire or electric shock, do not expose this product to rain or moisture.

See bottom of projector.

	CAUTION RISK OF ELECTRIC SHOCK. DO NOT REMOVE SCREWS EXCEPT SPECIFIED USER SERVICE SCREW.	
CAUTION: TO REDUCE THE RISK OF ELECTRIC SHOCK, DO NOT REMOVE COVER. NO USER-SERVICEABLE PARTS EXCEPT LAMP UNIT. REFER SERVICING TO QUALIFIED SERVICE PERSONNEL.		



The lightning flash with arrowhead symbol, within an equilateral triangle, is intended to alert the user to the presence of uninsulated “dangerous voltage” within the product's enclosure that may be of sufficient magnitude to constitute a risk or electric shock to persons.



The exclamation point within a triangle is intended to alert the user to the presence of important operating and maintenance (servicing) instructions in the literature accompanying the product.

WARNING:

This is a Class A product. In a domestic environment this product may cause radio interference in which case the user may be required to take adequate measures.

WARNING: FCC Regulations state that any unauthorized changes or modifications to this equipment not expressly approved by the manufacturer could void the user's authority to operate this equipment.

U.S.A. ONLY

PRODUCT DISPOSAL

This product utilizes lamp containing a small amount of mercury. Disposal of these materials may be regulated due to environmental considerations. For disposal or recycling information, please contact your local authorities, the Electronics Industries Alliance: www.eiae.org, the lamp recycling organization www.lamprecycle.org, or Sharp at 1-800-BE-SHARP.

U.S.A. ONLY

This product contains a CR Coin Lithium Battery which contains Perchlorate Material – special handling may apply, California residents, See www.dtsc.ca.gov/hazardouswaste/perchlorate/

U.S.A. ONLY

INFORMATION

This equipment has been tested and found to comply with the limits for a Class B digital device, pursuant to Part 15 of the FCC Rules. These limits are designed to provide reasonable protection against harmful interference in a residential installation. This equipment generates, uses, and can radiate radio frequency energy and, if not installed and used in accordance with the operation manual, may cause harmful interference to radio communications. However, there is no guarantee that interference will not occur in a particular installation. If this equipment does cause harmful interference to radio or television reception, which can be determined by turning the equipment off and on, the user is encouraged to try to correct the interference by one or more of the following measures:

- Reorient or relocate the receiving antenna.
- Increase the separation between the equipment and the receiver.
- Connect the equipment into an outlet on a circuit different from that to which the receiver is connected.
- Consult the dealer or an experienced radio/TV technician for help.

U.S.A. ONLY

Declaration of conformity

SHARP PROJECTOR, MODEL XV-Z30000

This device complies with Part 15 of the FCC rules. Operation is subject to the following conditions: (1) This device may not cause harmful interference, and (2) this device must accept any interference received, including interference that may cause undesired operation.

Responsible Party:

SHARP ELECTRONICS CORPORATION
Sharp Plaza, Mahwah, New Jersey 07495-1163
TEL: 1-800-BE-SHARP (1-800-237-4277)

Caution Concerning Lamp Replacement

- This projector utilizes a pressurized mercury lamp. A loud sound may indicate lamp failure. Lamp failure can be attributed to numerous sources such as: excessive shock, improper cooling, surface scratches or deterioration of the lamp due to a lapse of usage time.
The period of time up to failure largely varies depending on the individual lamp and/or the condition and the frequency of use. It is important to note that failure can often result in the bulb cracking.
- When the lamp replacement indicator and on-screen display icon are illuminated, it is recommended that the lamp be replaced with a new one immediately, even if the lamp appears to be operating normally.
- Should the lamp break, there is also a possibility that glass particles may spread inside of the projector. In such a case, it is recommended you contact your nearest Sharp Authorized Projector Dealer or Service Center to assure safe operation.
- Should the lamp break, the glass particles may spread inside the lamp cage or gas contained in the lamp may be vented into the room from the exhaust vent. Because the gas in this lamp includes mercury, ventilate the room well if the lamp breaks and avoid all exposure to the released gas. In case of exposure to the gas, consult a doctor as soon as possible.



Caution

- Do not remove the lamp unit from the projector right after use. The lamp will be very hot and may cause burns or injury.
 - Wait at least one hour after the power cord is disconnected to allow the surface of the lamp unit to fully cool before removing the lamp unit.
 - Do not touch the glass surface of the lamp unit or the inside of the projector.
 - Do not loosen other screws except for the lamp unit cover and lamp unit.
 - Make sure to reset the lamp timer only when replacing the lamp. If you reset the lamp timer and continue to use the same lamp, this may cause the lamp to become damaged or explode.
- **Carefully change the lamp by following the instructions described on pages 78 to 80.**
* **If you wish, you may have the lamp replaced at your nearest Sharp Authorized Projector Dealer or Service Center.**

* If the new lamp does not light after replacement, take your projector to the nearest Sharp Authorized Projector Dealer or Service Center for repair.

How to Read this Operation Manual

- The specifications are slightly different, depending on the model. However, you can connect and operate all models in the same manner.
- In this operation manual, the illustration and the screen display are simplified for explanation, and may differ slightly from the actual display.

Using the Menu Screen

RETURN button
 • Press **RETURN** to return to the previous screen when the menu is displayed.

ENTER button
 Adjustment buttons
 (▲▼◀▶)
 MENU button

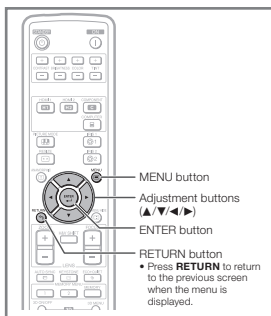
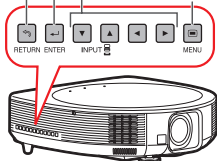

Buttons used in this operation

Menu Selections (Adjustments)

Example: Adjusting "Bright".

- This operation can also be performed by using the buttons on the projector.

1 Press **MENU**.

- The "Picture" menu screen for the selected input mode is displayed.

2 Press **▶** or **◀** and select "Picture" to adjust.

Example: "Picture" screen menu
 Menu item

Picture Mode	SIG	SCR	PEU	Net.
Picture Mode		Standard		
Contrast	0	0	1	1
Bright	0	0	1	1
Color	0	0	1	1
Tint	0	0	1	1
Sharp	0	0	1	1
Red Gain	0	0	1	1
Green Gain	0	0	1	1
Blue Gain	0	0	1	1
CLR Temp	0	0	1	1
IRIS (Manual)		High Brightness		
IRIS2 (Auto)		On		
Eco+Quiet		Off		
Advanced				
Reset				
SEL/ADJ.				
RETURN				

Button used in this step

On-screen display

42

InfoIndicates safeguards for using the projector.

Note Indicates additional information for setting up and operating the projector.

For Future Reference

Maintenance

➔ P. 75

Troubleshooting

➔ PP. 83 to 85

Index

➔ P. 89

Contents

Preparing

Introduction

How to Read this Operation Manual	3
Contents	4
IMPORTANT SAFEGUARDS	6
How to Access the PDF Operation Manuals.....	11
Accessories	12
Part Names and Functions.....	13
Side View	13
Top View	13
Front View	13
Rear View (Terminals).....	14
Inserting the Batteries.....	16
Usable Range.....	17

Easy Start

Easy Start	18
Setup and Projection	18

Setup

Setting Up the Projector	20
Video Setup.....	20
Setting Up the Projector	20
Standard Setup (Front Projection).....	20
Screen Size and Projection Distance	21
Projection (PRJ) Mode	22
Ceiling-Mount Setup.....	22

Connections

Connecting the Projector to Other Equipment.....	23
Connecting to Video Equipment	24
Connecting to a Computer.....	25
Controlling the Projector by a Computer	26
Connecting the Power Cord.....	27

Using

Basic Operation

Turning the Projector On/Off	28
Turning the Projector On	28
Turning the Power Off (Putting the Projector into Standby Mode)	28
Image Projection	29
Shifting the Lens.....	29
Using the Adjustment Feet.....	30
Adjusting the Focus.....	30
Adjusting the Projected Image Size.....	30
Correcting Trapezoidal Distortion	31
Switching the Input Mode.....	35
Resize Mode	36

Useful Features

Operating with the Remote Control.....	37
Adjusting the Image.....	37
Selecting the Picture Mode.....	37
Switching the Iris Setting	38
Auto Sync (Auto Sync Adjustment)	38
Hiding the Menu Temporarily	38
Switching the Eco+Quiet Mode	38
Menu Items.....	39
Using the Menu Screen	42
Menu Selections (Adjustments)	42
Picture Adjustment (“Picture” Menu)	44
Selecting the Picture Mode.....	44
Adjusting the Image.....	45
Switching the Iris Setting	45
Eco+Quiet	45
Using the Advanced	45
Correcting Gradation of Video (Gamma Correction)	45
Custom Gamma.....	46
Adjusting the Colors	46
Adjusting the Bright Boost.....	48
Selecting the Film Mode	48
Setting Color Enhancement.....	48
Setting Detail Enhancement.....	48
Reducing Image Noise (DNR)	48
Mosquito Noise Reduction (MNR).....	48
Resetting All Adjustment Items	48
Computer Image Adjustment (“SIG-ADJ” Menu)	49
Adjusting the Computer Image	49
Setting the Resolution	49
Auto Sync (Auto Sync Adjustment)	49
Signal Type Setting	50
Setting the Video Setup.....	50
Adjusting the Dynamic Range.....	50
Signal Info	50
Adjusting the Projected Image (“SCR-ADJ” Menu).....	51
Setting the Resize Mode.....	51
Adjusting the Image Position	51
Trigger	51
Anamorphic.....	51
Adjusting the Overscan.....	52
Black Mask	52
CBNR.....	52
Setting On-screen Display	52
Setting the Brightness of the Menu Screen.....	52
Selecting the Background Image	52
Selecting the Menu Screen Position	53
Reversing/Inverting Projected Images.....	53
Selecting the On-screen Display Language	53

Adjusting the Projector Function	
("PRJ-ADJ" Menu)	54
Setting Auto Power Off Mode	54
Setting No Operation Off Mode	54
Setting the Power Save Mode	
(Economy Mode)	54
Setting One Touch Play, System	
Standby and Input Name	55
Turning LED Off	56
Setting the Demo Mode	56
Fan Mode Setting	56
Memory Menu	56
Returning to the Default Settings	57
Lamp Timer (Life)	57
Setting Up the Projector Network	
Environment ("Network" Menu)	58
Setting a Password	58
DHCP Client Setting	59
TCP/IP Setting	59
Returning to Default Settings (Network) ..	59
Restart Network Function	59
Confirming the Projector Information	60
Enjoying 3D Image Viewing	61
Precautions on using the 3D Glasses	61
Precautions on installing the IR emitter ...	61
Precautions on viewing 3D images	62
Supplied Accessories for	
the 3D Glasses	64
Part Names	64
Before Using the 3D Glasses	65
Replacing the Button Cell Battery	65
Attaching the Nose Pad	66
Attaching the 3D Glasses Band	66
Using the 3D Glasses	66
Connecting the IR Emitter to	
the Projector	67
Viewing 3D Images	68
3D Settings ("3D MENU")	70
Setting the 3D Format Menu	71
Specifications – 3D Glasses	73
Specifications – IR Emitter	74
Dimensions	74
Effective Distance	74

Reference

Appendix

Maintenance	75
Maintenance Indicators	76
Regarding the Lamp	78
Lamp	78
Caution Concerning the Lamp	78
Replacing the Lamp	78
Removing and Installing the	
Lamp Unit	79
Resetting the Lamp Timer	80
Compatibility Chart	81

Troubleshooting	83
For SHARP Assistance	86
Specifications	87
Dimensions	88
Index	89

IMPORTANT SAFEGUARDS

CAUTION: Please read all of these instructions before you operate this product and save these instructions for later use.

Electrical energy can perform many useful functions. This product has been engineered and manufactured to assure your personal safety. BUT IMPROPER USE CAN RESULT IN POTENTIAL ELECTRICAL SHOCK OR FIRE HAZARDS. In order not to defeat the safeguards incorporated in this product, observe the following basic rules for its installation, use and servicing.

1. Read Instructions

All the safety and operating instructions should be read before the product is operated.

2. Retain Instructions

The safety and operating instructions should be retained for future reference.

3. Heed Warnings

All warnings on the product and in the operating instructions should be adhered to.

4. Follow Instructions

All operating and use instructions should be followed.

5. Cleaning

Unplug this product from the wall outlet before cleaning. Do not use liquid cleaners or aerosol cleaners. Use a damp cloth for cleaning.

6. Attachments

Do not use attachments not recommended by the product manufacturer as they may cause hazards.

7. Water and Moisture

Do not use this product near water—for example, near a bath tub, wash bowl, kitchen sink, or laundry tub; in a wet basement; or near a swimming pool; and the like.

8. Accessories

Do not place this product on an unstable cart, stand, tripod, bracket, or table. The product may fall, causing serious injury to a child or adult, and serious damage to the product. Use only with a cart, stand, tripod, bracket, or table recommended by the manufacturer, or sold with the product. Any mounting of the product should follow the manufacturer's instructions, and should use a mounting accessory recommended by the manufacturer.

9. Transportation

A product and cart combination should be moved with care. Quick stops, excessive force, and uneven surfaces may cause the product and cart combination to overturn.



10. Ventilation

Slots and openings in the cabinet are provided for ventilation to ensure reliable operation of the product and to protect it from overheating, and these openings must not be blocked or covered. The openings should never be blocked by placing the product on a bed, sofa, rug, or other similar surface. This product should not be placed in a built-in installation such as a bookcase or rack unless proper ventilation is provided or the manufacturer's instructions have been adhered to.

11. Power Sources

This product should be operated only from the type of power source indicated on the marking label. If you are not sure of the type of power supply to your home, consult your product dealer or local power company. For products intended to operate from battery power, or other sources, refer to the operating instructions.

12. Grounding or Polarization

This product is provided with one of the following types of plugs. If the plug should fail to fit into the power outlet, please contact your electrician.

Do not defeat the safety purpose of the plug.

- Two-wire type (mains) plug.
- Three-wire grounding type (mains) plug with a grounding terminal.
This plug will only fit into a grounding type power outlet.

13. Power-Cord Protection

Power-supply cords should be routed so that they are not likely to be walked on or pinched by items placed upon or against them, paying particular attention to cords at plugs, convenience receptacles, and the point where they exit from the product.

14. Lightning

For added protection for this product during a lightning storm, or when it is left unattended and unused for long periods of time, unplug it from the wall outlet and disconnect the cable system. This will prevent damage to the product due to lightning and power-line surges.

15. Overloading

Do not overload wall outlets, extension cords, or integral convenience receptacles as this can result in a risk of fire or electric shock.

16. Object and Liquid Entry

Never push objects of any kind into this product through openings as they may touch dangerous voltage points or short-out parts that could result in a fire or electric shock.

Never spill liquid of any kind on the product.

17. Servicing

Do not attempt to service this product yourself as opening or removing covers may expose you to dangerous voltage or other hazards. Refer all servicing to qualified service personnel.

18. Damage Requiring Service

Unplug this product from the wall outlet and refer servicing to qualified service personnel under the following conditions:

- a. When the power-supply cord or plug is damaged.
- b. If liquid has been spilled, or objects have fallen into the product.
- c. If the product has been exposed to rain or water.
- d. If the product does not operate normally by following the operating instructions. Adjust only those controls that are covered by the operating instructions, as an improper adjustment of other controls may result in damage and will often require extensive work by a qualified technician to restore the product to normal operation.

- e. If the product has been dropped or damaged in any way.
- f. When the product exhibits a distinct change in performance, this indicates a need for service.

19. Replacement Parts

When replacement parts are required, be sure the service technician has used replacement parts specified by the manufacturer or have the same characteristics as the original part. Unauthorized substitutions may result in fire, electric shock, or other hazards.

20. Safety Check

Upon completion of any service or repairs to this product, ask the service technician to perform safety checks to determine that the product is in proper operating condition.

21. Wall or Ceiling Mounting

This product should be mounted to a wall or ceiling only as recommended by the manufacturer.

22. Heat

This product should be situated away from heat sources such as radiators, heat registers, stoves, or other products (including amplifiers) that produce heat.

- DLP® and the DLP logo are registered trademarks of Texas Instruments.
- Microsoft® and Windows® are registered trademarks of Microsoft Corporation in the United States and/or other countries.
- PC/AT is a registered trademark of International Business Machines Corporation in the United States.
- Adobe® Reader® is a trademark of Adobe Systems Incorporated.
- Macintosh® is a registered trademark of Apple Computer, Inc. in the United States and/or other countries.
- HDMI, the HDMI logo and High-Definition Multimedia Interface are trademarks or registered trademarks of HDMI Licensing LLC.
- All other company or product names are trademarks or registered trademarks of their respective companies.
- Some IC chips in this product include confidential and/or trade secret property belonging to Texas Instruments. Therefore you may not copy, modify, adapt, translate, distribute, reverse engineer, reverse assemble or disassemble the contents thereof.

Observe the following safeguards when setting up your projector.

Caution concerning the lamp unit

- Potential hazard of glass particles if lamp ruptures. In case of lamp rupture, contact your nearest Sharp Authorized Projector Dealer or Service Center for replacement. See “Regarding the Lamp” on page 78.



Caution concerning the setup of the projector

- For minimal servicing and to maintain high image quality, SHARP recommends that this projector be installed in an area free from humidity, dust and cigarette smoke. When the projector is subjected to these environments, the vents and lens must be cleaned more often. As long as the projector is regularly cleaned, use in these environments will not reduce the overall operation life of the unit. Internal cleaning should only be performed by a Sharp Authorized Projector Dealer or Service Center.

Rest your eyes occasionally.

- Continuously watching the screen for long hours will cause eye strain. Take regular breaks to rest your eyes.

Do not set up the projector in places exposed to direct sunlight or bright light.

- Position the screen so that it is not in direct sunlight or room light. Light falling directly on the screen washes out the colors, making viewing difficult. Close the curtains and dim the lights when setting up the screen in a sunny or bright room.

Caution regarding placing of the projector

- Place the projector on a level site within the adjustment range (9 degrees) of the adjustment foot.

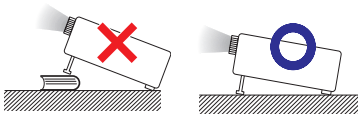

- After the projector is purchased, a faint smell from the vent may appear when the power is first turned on. This is normal and is not a malfunction. It will disappear after the projector is used for a while.

When using the projector in high-altitude areas such as mountains (at altitudes of approximately 1,500 meters (4,900 feet) or more)

- When you use the projector in high-altitude areas with thin air, set “Fan Mode” to “High”. Neglecting this can affect the longevity of the optical system.
- Use the projector at altitudes of 2,300 meters (7,500 feet) or less.

Warning about placing the projector in a high position

- When placing the projector in a high position, make certain it is carefully secure to avoid personal injury caused by the projector falling down.

Do not subject the projector to hard impact and/or vibration.

- Protect the lens so as not to hit or damage the surface of the lens.

Avoid locations with extremes of temperature.

- The operating temperature of the projector is from 41°F to 95°F (+5°C to +35°C).
- The storage temperature of the projector is from -4°F to 140°F (-20°C to +60°C).

Do not block the exhaust and intake vents.

- Allow at least 11 ¹³/₁₆ inches (30 cm) of space between the exhaust vent and the nearest wall or obstruction.
- Ensure that the intake vent and the exhaust vent are not obstructed.
- If the cooling fan becomes obstructed, a protection circuit will automatically put the projector into Standby mode to prevent overheat damage. This does not indicate a malfunction. (See pages 76 and 77.) Remove the projector power cord from the wall outlet and wait at least 10 minutes. Place the projector where the intake and exhaust vents are not blocked, plug the power cord back in and turn on the projector. This will return the projector to the normal operating condition.

Caution regarding usage of the projector

- If you are not to use the projector for a long time or before moving the projector, make certain you unplug the power cord from the wall outlet, and disconnect any other cables connected to it.
- Do not carry the projector by holding the lens.
- When storing the projector, ensure you attach the lens cover to the projector.
- Do not expose the projector to direct sunlight or place next to heat sources. Doing so may affect the cabinet color or cause deformation of the plastic cover.

Other connected equipment

- When connecting a computer or other audio-visual equipment to the projector, make the connections AFTER unplugging the power cord of the projector from the AC outlet and turning off the equipment to be connected.
- Please read the operation manuals of the projector and the equipment to be connected for instructions on how to make the connections.

Using the projector in other countries

- The power supply voltage and the shape of the plug may vary depending on the region or country you are using the projector in. When using the projector overseas, make sure you use an appropriate power cord for the country you are in.

Temperature monitor function



- If the temperature inside the projector increases, due to blockage of the air vents, or the setting location, the temperature warning indicator will blink. And if the temperature keeps on rising, “ TEMP.” will illuminate in the lower left corner of the picture with the temperature warning indicator blinking. If this state continues, the lamp will turn off, the cooling fan will run and then the projector will enter Standby mode. Refer to “Maintenance Indicators” on pages [76](#) and [77](#) for details.

Info

- The cooling fan regulates the internal temperature, and its performance is automatically controlled. The sound of the fan may change during projector operation due to changes in the fan speed. This does not indicate malfunction.

Observe the following safeguards when using the 3D Glasses.

Prevention of accidental ingestion

- Keep the batteries and band accessory out of the reach of small children. Small children can accidentally swallow these parts.
 - If a child accidentally swallows any of these parts, seek immediate medical attention.

Do not disassemble

- Do not disassemble or modify the 3D Glasses.

Caution for lithium battery

- Batteries must not be exposed to excessive heat such as direct sunlight or fire.
- Replace only with the same or equivalent type of battery. The battery may explode if improperly replaced.
- Take care not to reverse the battery poles (+ and –) when loading the battery. Follow the correct procedure when loading the battery. (See page 65.) Loading the battery incorrectly may damage the battery or cause it to leak battery fluid, which could result in a fire, injury or damage.

Handling the 3D Glasses

- Do not drop, exert pressure on, or step on the 3D Glasses. Doing so may damage the glass section, which may result in injury.
- Be careful not to trap your finger in the hinge section of the 3D Glasses. Doing so may result in injury.
 - Pay special attention when children are using this product.

Using the 3D Glasses

- Parents/guardians should monitor children's viewing habits to avoid their prolonged use without rest periods.
- Use only the 3D Glasses recommended for this product.
- Use the 3D Glasses only for the specified purpose.
- Do not move around while wearing the 3D Glasses. The surrounding area appears dark, which may result in falling or other accidents that may cause injury.

Caring for the 3D Glasses

- Use only the cloth provided with the 3D Glasses to clean the lenses. Remove dust and soil from the cloth. Any dust or other soiling on the cloth may result in scratches on the product. Do not use solvents such as benzene or thinners as doing so may cause the coating to peel off.
- When cleaning the 3D Glasses, take care not to allow water or other fluids to come into contact with the glasses.
- Always store the 3D Glasses in the case provided when not in use.
- When storing the 3D Glasses, avoid very humid or hot locations.

Viewing 3D images

- If you experience dizziness, nausea, or other discomfort while viewing 3D images, discontinue use and rest your eyes.
- Do not use the 3D Glasses if they are cracked or broken.

How to Access the PDF Operation Manuals

PDF operation manuals in several languages are included in the CD-ROM. To utilize these manuals, you need to install Adobe® Reader® on your computer (Windows® or Macintosh®).

Please download Adobe® Reader® from the Internet (<http://www.adobe.com>).

Accessing the PDF Manuals

For Windows®:

- ① Insert the CD-ROM in the CD-ROM drive.
- ② Double click the “My Computer” icon.
- ③ Double click the “CD-ROM” drive.
- ④ **When you want to view the operation manual**
 - 1) Double click the “MANUALS” folder.
 - 2) Double click the language (name of the folder) that you want to view.
 - 3) Double click the pdf file to access the projector manuals.

When you want to view the SETUP MANUAL

- 1) Double click the “SETUP” folder.
- 2) Double click the language (name of the folder) that you want to view.
- 3) Double click the pdf file to access the SETUP MANUAL.

For Macintosh®:

- ① Insert the CD-ROM in the CD-ROM drive.
- ② Double click the “CD-ROM” icon.
- ③ **When you want to view the operation manual**
 - 1) Double click the “MANUALS” folder.
 - 2) Double click the language (name of the folder) that you want to view.
 - 3) Double click the pdf file to access the projector manuals.

When you want to view the SETUP MANUAL

- 1) Double click the “SETUP” folder.
- 2) Double click the language (name of the folder) that you want to view.
- 3) Double click the pdf file to access the SETUP MANUAL.

Note

- If the desired pdf file cannot be opened by double clicking the mouse, start Adobe® Reader® first, then specify the desired file using the “File”, “Open” menu.

SETUP MANUAL

Refer to the “SETUP MANUAL” contained on the supplied CD-ROM for details.

Connecting Pin Assignments	2
RS-232C Specifications and Commands	4
Setting up the Projector Network Environment	8
Resetting the Lamp Timer of the Projector via LAN	13
Troubleshooting	15

Accessories

Supplied accessories



Remote control
<RRMCGA999WJSA>



Two R-6 batteries
("AA" size, UM/SUM-3,
HP-7 or similar)



Two pairs of 3D Glasses*1
<KOPTLA002WJN1>

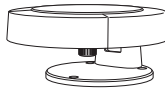

IR emitter
<DSETNA007FMF0>



IR emitter cable
(33' (10 m))
<QCNWGA170WJPZ>

Power cord*2
(1)

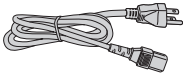

For U.S. and
Canada, etc.
(6' (1.8 m))
<QACDA082WJPZ>

(2)

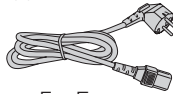

For Europe,
except U.K.
(6' (1.8 m))
<QACVA024WJPZ>

(3)

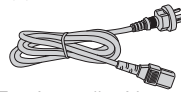

For Australia, New
Zealand and Oceania
(6' (1.8 m))
<QACCLA055WJPZ>

*1 See pages 64 to 66 for details of the 3D Glasses and their accessories.

*2 Which power cords are supplied along with your projector depends on the region. Use the power cord that corresponds to the wall outlet in your country.

- Operation manuals (this manual <TINS-F383WJZZ> and CD-ROM <UDSKAA138WJZZ>)

Note

- Codes in "< >" are Replacement parts codes.

Optional accessories

- | | |
|--|-----------------------------|
| ■ Lamp unit | AN-K30LP |
| ■ Ceiling-mount adaptor | AN-60KT |
| ■ Ceiling-mount bracket | AN-XGCM55 (for U.S.A. only) |
| ■ Ceiling-mount unit | AN-TK201 <for AN-60KT> |
| | AN-TK202 <for AN-60KT> |
| ■ Ceiling-mount extension tube | AN-EP101B <for AN-XGCM55> |
| | (for U.S.A. only) |
| ■ 3 RCA to mini D-sub 15 pin cable (10' (3.0 m)) | AN-C3CP2 |
| ■ 3D Glasses | AN-3DG10-S |

Note

- Some of the optional accessories may not be available depending on the region. Please check with your nearest Sharp Authorized Projector Dealer or Service Center.

Part Names and Functions

Numbers in refer to the main pages in this operation manual where the topic is explained.

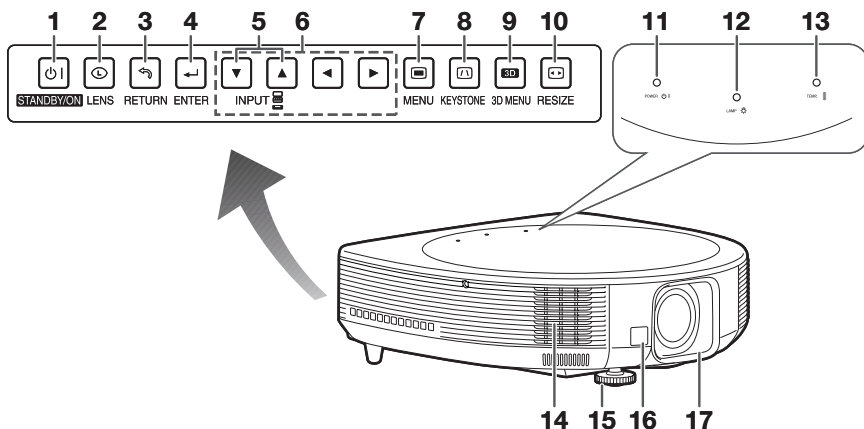

Side View

- 1** STANDBY/ON button 28
For turning the power on and putting the projector into Standby mode.
- 2** LENS button
For toggling the menu screens for adjustments of the lens (LENS SHIFT, FOCUS, ZOOM, etc.).
- 3** RETURN button 42
For returning to the previous menu screen during menu operations.
- 4** ENTER button 42
For setting items selected or adjusted on the menu.
- 5** INPUT buttons (▼/▲) 35
For switching input mode.
- 6** Adjustment buttons (▲/▼/◀/▶) 42
For selecting menu items.
- 7** MENU button 42
For displaying adjustment and setting screens.

- 8** KEYSTONE button 31
For entering the Keystone Correction mode.
- 9** 3D MENU button 69, 70
For displaying the 3D MENU screen.
- 10** RESIZE button 36
For switching the picture size (NORMAL, 16:9, etc.).

Top View

- 11** Power indicator 76
- 12** Lamp indicator 76
- 13** Temperature warning indicator 76

Front View

- 14** Exhaust vent 75
- 15** Adjustment foot 30
- 16** Remote control sensor 17
- 17** Lens cover 75

Part Names and Functions (Continued)

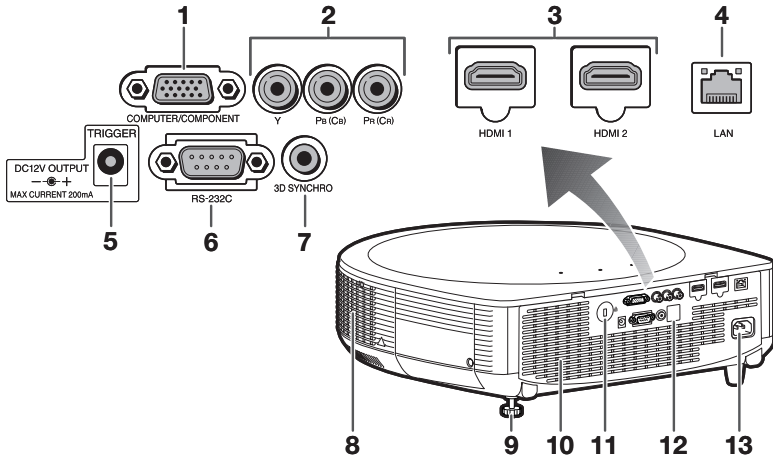

Rear View (Terminals)

- 1 **COMPUTER/COMPONENT** input terminal **23, 25**
Terminal for computer RGB and component signals.
- 2 **Component (Y_P(C_B)P_R(C_R))** terminals **23**
Terminals for connecting video equipment with component output terminal.
- 3 **HDMI** terminals **23, 24**
Terminals for HDMI input.
- 4 **LAN** terminal **27**
Terminal for controlling the projector using a computer via network.
- 5 **TRIGGER** terminal **51**
When the projector is turned on, a control signal (DC 12V) is output from this terminal. This can be connected to a retractable projection screen or anamorphic lens that supports the trigger function.
- 6 **RS-232C** terminal **26**
Terminal for controlling the projector using a computer.
- 7 **3D SYNCHRO** terminal **67**
Terminal for connecting the IR emitter.
- 8 **Exhaust vent** **75**
- 9 **Rear adjustment foot** **30**
- 10 **Intake vent** **75**
- 11 **Kensington Security Standard** connector
- 12 **Remote control sensor** **17**
- 13 **AC socket** **27**
Connect the supplied power cord.

Using the Kensington Lock

- This projector has a Kensington Security Standard connector for use with a Kensington MicroSaver Security System. Refer to the information that came with the system for instructions on how to use it to secure the projector.

Numbers in **[]** refer to the main pages in this operation manual where the topic is explained.

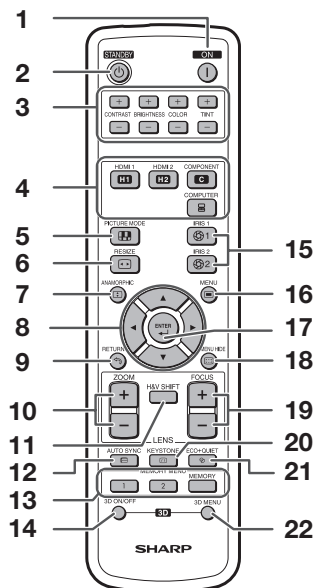

- 1 ON button **28**
For turning the power on.
- 2 STANDBY button **28**
For putting the projector into the Standby mode.
- 3 CONTRAST, BRIGHTNESS, COLOR and TINT buttons **37**
For adjusting the contrast, brightness, color and tint.
- 4 HDMI 1/2, COMPONENT and COMPUTER buttons **35**
For switching to the respective input modes.
- 5 PICTURE MODE button **37**
For displaying the Picture Mode list.
- 6 RESIZE button **36**
For switching the picture size (NORMAL, 16:9, etc.).
- 7 ANAMORPHIC button
For switching the Anamorphic lens.
- 8 Adjustment buttons (▲/▼/◀/▶) **42**
For selecting and adjusting menu items.
- 9 RETURN button **42**
For returning to the previous menu screen during menu operations.
- 10 ZOOM buttons **30**
For adjusting the projected image size.
- 11 H&V SHIFT button **29**
For shifting the lens horizontally and vertically.
- 12 AUTO SYNC button **38**
For automatically adjusting images when connected to a computer.
- 13 MEMORY 1/2 buttons **56**
For displaying each "Load Memory" screen of "Memory Menu".
MEMORY button **56**
For displaying the Memory Menu screen.
- 14 3D ON/OFF button **68, 69**
For switching between 2D and 3D modes.
- 15 IRIS 1/2 buttons **38**
For adjusting the quantity of the projected light and the contrast of the image.
- 16 MENU button **42**
For displaying adjustment and setting screens.
- 17 ENTER button **42**
For setting items selected or adjusted on the menu.
- 18 MENU HIDE button **38**
For temporarily hiding menu screen.
- 19 FOCUS buttons **30**
For adjusting the focus.
- 20 KEYSTONE button **31**
For entering the Keystone Correction mode.
- 21 ECO+QUIET button **38**
For lowering the noise of the cooling fan and extending the lamp life.
- 22 3D MENU button **69, 70**
For displaying the 3D MENU screen.

Part Names and Functions (Continued)

Inserting the Batteries

- 1** Pull down the tab on the cover and remove the cover towards the direction of the arrow.

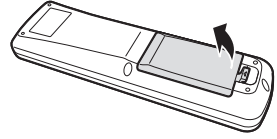

- 2** Insert the batteries.
- Insert the batteries making sure the polarities correctly match the ⊕ and ⊖ marks inside the battery compartment.

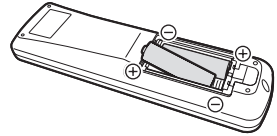

- 3** Insert the upper tab of the cover into the opening, and lower the cover until it clicks in place.

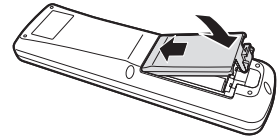

Incorrect use of the batteries may cause them to leak or explode. Please follow the precautions below



Caution

- Danger of explosion if battery is incorrectly replaced.
Replace only with alkaline or manganese batteries.
- Insert the batteries making sure the polarities correctly match the ⊕ and ⊖ marks inside the battery compartment.
- Batteries of different types have different properties, therefore do not mix batteries of different types.
- Do not mix new and old batteries.
This may shorten the life of new batteries or may cause old batteries to leak.
- Remove the batteries from the remote control once they have run out, as leaving them in can cause them to leak.
Battery fluid from leaked batteries is harmful to skin, therefore ensure you wipe them first and then remove them using a cloth.
- The batteries included with this projector may run down in a short period, depending on how they are kept.
Be sure to replace them as soon as possible with new batteries.
- Remove the batteries from the remote control if you will not be using the remote control for a long time.
- Comply with the rules (ordinance) of each local government when disposing of worn-out batteries.

Usable Range

The remote control can be used to control the projector within the ranges shown in the illustration.

Note

- **Another remote control sensor is located on the rear of the projector. (See pages 13 and 14.)**
- The signal from the remote control can be reflected off a screen for easy operation. However, the effective distance of the signal may differ depending on the screen material.

When using the remote control

- Ensure that you do not drop it or expose it to moisture or high temperature.
- The remote control may malfunction under a fluorescent lamp. In this case, move the projector away from the fluorescent lamp.

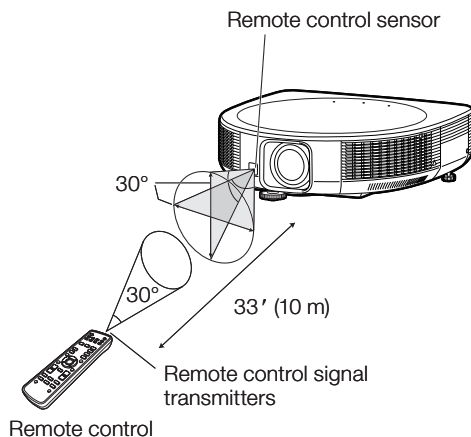

Easy Start

This section shows the basic operation (projector connecting with video equipment). For details, see the page described below for each step.

Setup and Projection

In this section, connection of the projector and video equipment is explained using one example.

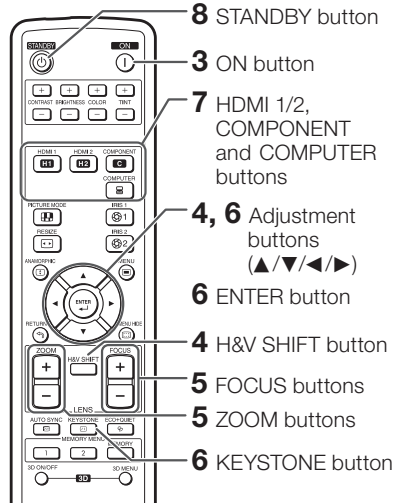
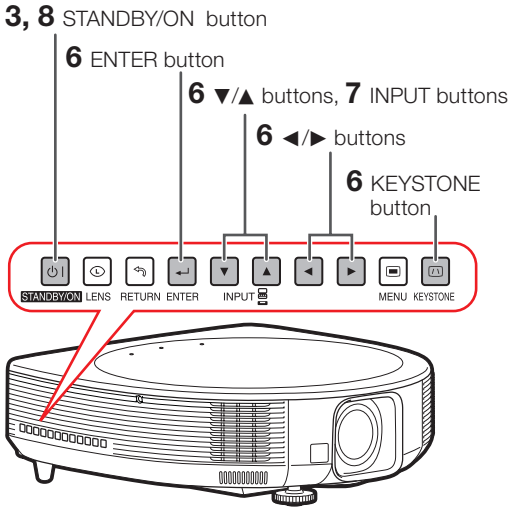

1. Place the projector facing a wall or a screen → P. 20

2. Connect the projector to the video equipment and plug the power cord into the AC socket of the projector

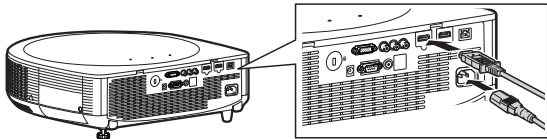

→ PP. 23 to 27

3. Turn the projector on

Press **STANDBY/ON** on the projector or **ON** on the remote control.

→ P. 28

4. Adjust the angle

Adjust the projector angle:

- Shift the lens horizontally and vertically.
- 1 Press **H&V SHIFT** on the remote control.
 - 2 Press **▲**, **▼**, **◀** or **▶** on the remote control.
- Adjust the projector angle by rotating the adjustment feet.

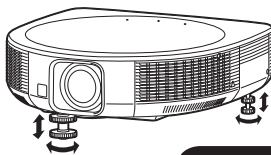

➔ PP. 29, 30

5. Adjust the focus and the zoom

- 1 Press **FOCUS +/-** on the remote control to adjust the focus.
- 2 Press **ZOOM +/-** on the remote control to adjust the zoom.

➔ P. 30

6. Correcting the image distortion due to the projection angle

- 1 Press **KEystone** on the projector or on the remote control.
- 2 Press **ENTER** on the projector or on the remote control.
- 3 Press **▲**, **▼**, **◀** or **▶** to move the position for the upper left of the image.
- 4 Press **ENTER** to set the position.
- 5 Repeat the same procedure with the positions for the upper right, lower right and lower left of the image.
 - When the position of the lower left is set, the correction is made and the display disappears.

➔ P. 31

7. Select the Input mode

On the projector:

Press **INPUT ▼/▲** to display the INPUT list. Use **INPUT ▼/▲** to select the input mode.



INPUT list

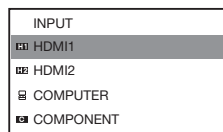

On-screen display (HDMI1)

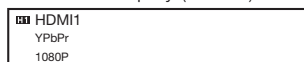

On the remote control:

Press **HDMI 1/2**, **COMPONENT** or **COMPUTER** to select the input mode.

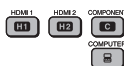

➔ P. 35

8. Turn the power off

Press **STANDBY/ON** on the projector or **STANDBY** on the remote control, and then press the button again while the confirmation message is displayed to put the projector into Standby mode.

On the projector



On the remote control



On-screen display

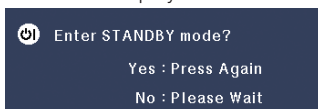

➔ P. 28



Setting Up the Projector

Video Setup

If using this projector outside the U.S.A., please change setting to "0 IRE" in Video Setup. (See page 50.)

Setting Up the Projector

For optimal image quality, position the projector perpendicular to the screen with the projector's feet flat and level. Doing so will eliminate the need for Keystone correction and provide the best image quality. (See pages 31 to 34.)

Standard Setup (Front Projection)

- Place the projector at the required distance from the screen according to the desired picture size. (See page 21.)

Indication of the Projection Image Size and Projection Distance

Example: When using a wide screen (16:9)

Picture Size

500" (1270 cm)

200" (508 cm)

100" (254 cm)

80" (203 cm)

40" (102 cm)

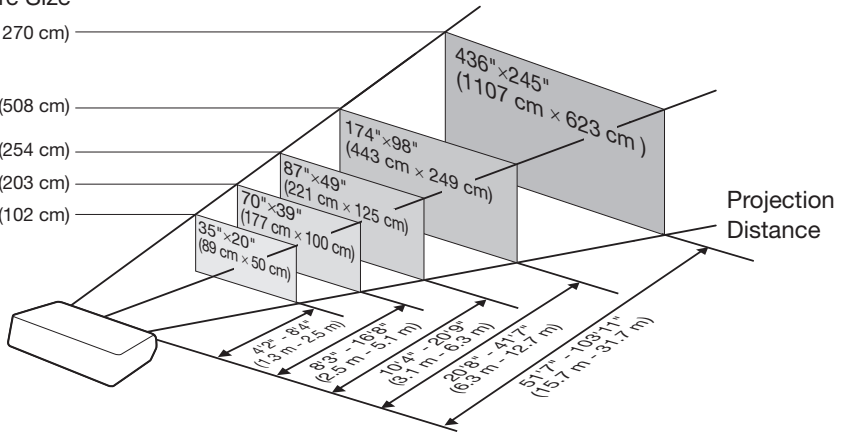

Screen Size and Projection Distance

When using a wide screen (16:9): In case of displaying the 16:9 picture on the whole of the 16:9 screen

Picture (Screen) size			Projection distance [L]		Distance from the lens center to the bottom of the image [H]		Distance from the lens center to the center of the image[W]
Diag. [x]	Width	Height	Minimum [L1]	Maximum [L2]	Lower[H1]	Upper[H2]	
500* (1270 cm)	1107 cm (436")	623 cm (245")	15.7 m (51' 7")	31.7 m (103' 11")	-623 cm (-245 9/16")	0 cm (0")	+210 cm (+82 1/8")
400* (1016 cm)	886 cm (349")	498 cm (196")	12.6 m (41' 4")	25.3 m (83' 2")	-498 cm (-196 7/16")	0 cm (0")	+168 cm (+66 15/16")
300* (762 cm)	664 cm (261")	374 cm (147")	9.4 m (31' 0")	19.0 m (62' 4")	-374 cm (-147 5/16")	0 cm (0")	+126 cm (+49 9/16")
250* (635 cm)	553 cm (218")	311 cm (123")	7.9 m (25' 10")	15.8 m (52' 0")	-311 cm (-122 9/16")	0 cm (0")	+105 cm (+41 13/16")
200* (508 cm)	443 cm (174")	249 cm (98")	6.3 m (20' 8")	12.7 m (41' 7")	-249 cm (-98 1/16")	0 cm (0")	+84 cm (+33 1/8")
150* (381 cm)	332 cm (131")	187 cm (74")	4.7 m (15' 6")	9.5 m (31' 2")	-187 cm (-73 35/64")	0 cm (0")	+63 cm (+24 9/16")
120* (305 cm)	266 cm (105")	149 cm (59")	3.8 m (12' 5")	7.6 m (24' 11")	-149 cm (-58 33/64")	0 cm (0")	+50 cm (+19 7/8")
100* (254 cm)	221 cm (87")	125 cm (49")	3.1 m (10' 4")	6.3 m (20' 9")	-125 cm (-49 1/32")	0 cm (0")	+42 cm (+16 5/8")
80* (203 cm)	177 cm (70")	100 cm (39")	2.5 m (8' 3")	5.1 m (16' 8")	-100 cm (-39 7/16")	0 cm (0")	+34 cm (+13 1/2")
60* (152 cm)	133 cm (52")	75 cm (29")	1.9 m (6' 2")	3.8 m (12' 6")	-75 cm (-29 27/64")	0 cm (0")	+25 cm (+9 15/16")
40* (102 cm)	89 cm (35")	50 cm (20")	1.3 m (4' 2")	2.5 m (8' 4")	-50 cm (-19 39/64")	0 cm (0")	+17 cm (+6 5/8")

x : Picture size (diag.) (in/cm): 40" - 500"

L1 : Minimum projection distance (m/ft)

L2 : Maximum projection distance (m/ft)

H1 : Lower distance from the lens center to the bottom of the image (cm/in)

H2 : Upper distance from the lens center to the bottom of the image (cm/in)

W : Distance from the lens center to the center of the image (cm/in)

The formula for picture size and projection distance

[m/cm] [Feet/inches]

L1 (m) = 0.03147 x L1 (ft) = 0.03147 x / 0.3048

L2 (m) = -0.06337 x L2 (ft) = -0.06337 x / 0.3048

H1 (cm) = -1.2453 x H1 (in) = -1.2453 x / 2.54

H2 (cm) = 0 x H2 (in) = 0 x / 2.54

W (cm) = 0.42062 x W (in) = 0.42062 x / 2.54

When using a normal screen (4:3): In case of displaying the 4:3 picture on the whole of the 4:3 screen.

Picture (Screen) size			Projection distance [L]		Distance from the lens center to the bottom of the image [H]		Distance from the lens center to the center of the image[W]
Diag. [x]	Width	Height	Minimum [L1]	Maximum [L2]	Lower[H1]	Upper[H2]	
400* (1016 cm)	813 cm (320")	610 cm (240")	15.4 m (50' 8")	31.0 m (101' 9")	-610 cm (-240")	0 cm (0")	+206 cm (+81 1/16")
300* (762 cm)	610 cm (240")	457 cm (180")	11.6 m (37' 11")	23.3 m (76' 4")	-457 cm (-180")	0 cm (0")	+154 cm (+60 5/16")
250* (635 cm)	508 cm (200")	381 cm (150")	9.6 m (31' 7")	19.4 m (63' 7")	-381 cm (-150")	0 cm (0")	+129 cm (+50 15/16")
200* (508 cm)	406 cm (160")	305 cm (120")	7.7 m (25' 3")	15.5 m (50' 11")	-305 cm (-120")	0 cm (0")	+103 cm (+40 11/32")
150* (381 cm)	305 cm (120")	229 cm (90")	5.8 m (18' 11")	11.6 m (38' 2")	-229 cm (-90")	0 cm (0")	+77 cm (+30 13/32")
120* (305 cm)	244 cm (96")	183 cm (72")	4.6 m (15' 2")	9.3 m (30' 6")	-183 cm (-72")	0 cm (0")	+62 cm (+24 3/16")
100* (254 cm)	203 cm (80")	152 cm (60")	3.9 m (12' 8")	7.8 m (25' 5")	-152 cm (-60")	0 cm (0")	+51 cm (+20 1/16")
80* (203 cm)	163 cm (64")	122 cm (48")	3.1 m (10' 1")	6.2 m (20' 4")	-122 cm (-48")	0 cm (0")	+41 cm (+16 1/32")
70* (178 cm)	142 cm (56")	107 cm (42")	2.7 m (8' 10")	5.4 m (17' 10")	-107 cm (-42")	0 cm (0")	+36 cm (+14 1/16")
60* (152 cm)	122 cm (48")	91 cm (36")	2.3 m (7' 7")	4.7 m (15' 3")	-91 cm (-36")	0 cm (0")	+31 cm (+12 1/32")
40* (102 cm)	81 cm (32")	61 cm (24")	1.5 m (5' 1")	3.1 m (10' 2")	-61 cm (-24")	0 cm (0")	+21 cm (+8 3/16")

x : Picture size (diag.) (in/cm): 40" - 400"

L1 : Minimum projection distance (m/ft)

L2 : Maximum projection distance (m/ft)

H1 : Lower distance from the lens center to the bottom of the image (cm/in)

H2 : Upper distance from the lens center to the bottom of the image (cm/in)

W : Distance from the lens center to the center of the image (cm/in)

The formula for picture size and projection distance

[m/cm] [Feet/inches]

L1 (m) = 0.03851 x L1 (ft) = 0.03851 x / 0.3048

L2 (m) = 0.07755 x L2 (ft) = 0.07755 x / 0.3048

H1 (cm) = -1.52404 x H1 (in) = -1.52404 x / 2.54

H2 (cm) = 0 x H2 (in) = 0 x / 2.54

W (cm) = 0.51477 x W (in) = 0.51477 x / 2.54

When using a normal screen (4:3): In case of setting the 16:9 picture to the full horizontal width of the 4:3 screen

Picture (Screen) size			Projection distance [L]		Distance from the lens center to the bottom of the image [H]		Distance from the lens center to the center of the image[W]
Diag. [x]	Width	Height	Minimum [L1]	Maximum [L2]	Lower[H1]	Upper[H2]	
500* (1270 cm)	1016 cm (400")	762 cm (300")	14.4 m (47' 5")	29.1 m (95' 5")	-572 cm (-225")	0 cm (0")	+193 cm (+76")
400* (1016 cm)	813 cm (320")	610 cm (240")	11.6 m (37' 11")	23.3 m (76' 4")	-457 cm (-180")	0 cm (0")	+154 cm (+60 5/16")
300* (762 cm)	610 cm (240")	457 cm (180")	8.7 m (28' 5")	17.5 m (57' 3")	-343 cm (-135")	0 cm (0")	+116 cm (+45 15/16")
250* (635 cm)	508 cm (200")	381 cm (150")	7.2 m (23' 8")	14.5 m (47' 9")	-286 cm (-112 1/2")	0 cm (0")	+97 cm (+38")
200* (508 cm)	406 cm (160")	305 cm (120")	5.8 m (18' 11")	11.6 m (38' 2")	-229 cm (-90")	0 cm (0")	+77 cm (+30 13/32")
150* (381 cm)	305 cm (120")	229 cm (90")	4.3 m (14' 3")	8.7 m (28' 8")	-171 cm (-67 1/2")	0 cm (0")	+58 cm (+22 3/16")
120* (305 cm)	244 cm (96")	183 cm (72")	3.5 m (11' 4")	7.0 m (22' 11")	-137 cm (-54")	0 cm (0")	+46 cm (+18 3/16")
100* (254 cm)	203 cm (80")	152 cm (60")	2.9 m (9' 6")	5.8 m (19' 1")	-114 cm (-45")	0 cm (0")	+39 cm (+15 3/16")
80* (203 cm)	163 cm (64")	122 cm (48")	2.3 m (7' 7")	4.7 m (15' 3")	-91 cm (-36")	0 cm (0")	+31 cm (+12 1/32")
70* (178 cm)	142 cm (56")	107 cm (42")	2.0 m (6' 8")	4.1 m (13' 4")	-80 cm (-31 1/2")	0 cm (0")	+27 cm (+10 3/16")
60* (152 cm)	122 cm (48")	91 cm (36")	1.7 m (5' 8")	3.5 m (11' 5")	-69 cm (-27")	0 cm (0")	+23 cm (+9 1/16")
40* (102 cm)	81 cm (32")	61 cm (24")	1.2 m (3' 9")	2.3 m (7' 8")	-46 cm (-18")	0 cm (0")	+15 cm (+6 5/16")

x : Picture size (diag.) (in/cm): 40" - 500"

L1 : Minimum projection distance (m/ft)

L2 : Maximum projection distance (m/ft)

H1 : Lower distance from the lens center to the bottom of the image (cm/in)

H2 : Upper distance from the lens center to the bottom of the image (cm/in)

W : Distance from the lens center to the center of the image (cm/in)

The formula for picture size and projection distance

[m/cm] [Feet/inches]

L1 (m) = 0.02889 x L1 (ft) = 0.02889 x / 0.3048

L2 (m) = 0.05817 x L2 (ft) = 0.05817 x / 0.3048

H1 (cm) = -1.14303 x H1 (in) = -1.14303 x / 2.54

H2 (cm) = 0 x H2 (in) = 0 x / 2.54

W (cm) = 0.38608 x W (in) = 0.38608 x / 2.54

Note

- When the distance from the lens center to the bottom of the image [H] is a negative number, this indicates that the bottom of the image is below the lens center.
- Allow a margin of error in the value in the diagrams above.

Setting Up the Projector (Continued)

Projection (PRJ) Mode

The projector can use any of the 4 projection modes shown in the diagram below. Select the mode most appropriate for the projection setting in use. (You can set the PRJ mode in “SCR-ADJ” menu. See page 53.)

- Table mounted, front projection
[Menu item → “Front”]

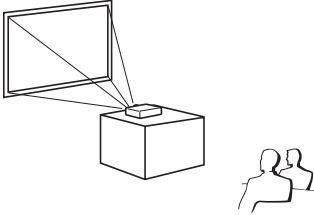

- Ceiling mounted, front projection
[Menu item → “Ceiling + Front”]

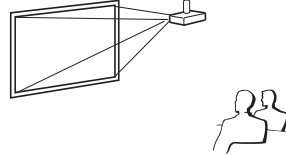

- Table mounted, rear projection
(with a translucent screen)
[Menu item → “Rear”]

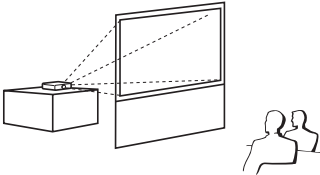

- Ceiling mounted, rear projection
(with a translucent screen)
[Menu item → “Ceiling + Rear”]

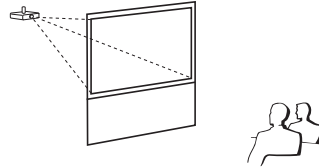

■ Ceiling-Mount Setup

It is recommended that you use the optional Sharp ceiling-mount adaptor and unit for this installation. Before mounting the projector, contact your nearest Sharp Authorized Projector Dealer or Service Center to obtain the recommended ceiling-mount adaptor and unit (sold separately).

Connecting the Projector to Other Equipment

Before connecting, ensure that the power cord of the projector is unplugged from the AC outlet and turn off the equipment to be connected. After making all connections, turn on the projector and then the other pieces of equipment. When connecting a computer, ensure that it is the last equipment to be turned on after all the connections are made.

- For more details of connection and cables, refer to the operation manual of the connecting equipment.
- You may need other cables or connectors not listed below.

Terminals on the Projector

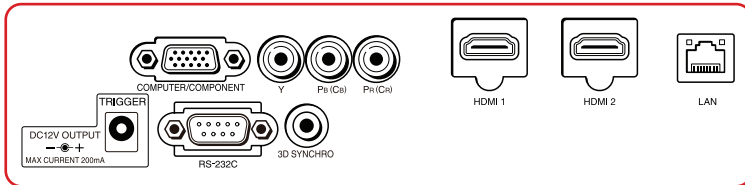

Equipment	Terminal on connected equipment	Cable	Terminal on the projector
Video equipment 	HDMI output terminal 	HDMI cable (commercially available) 	HDMI 1, 2
	Component video output terminal 	3 RCA to mini D-sub 15 pin cable Component cable (commercially available) 	COMPUTER/COMPONENT Component (Y P_B(C_B) P_R(C_R))
Camera/Video game 	Component video output terminal 	Cables for a camera or a video game/3 RCA to mini D-sub 15 pin cable RCA adaptor plug (commercially available)	COMPUTER/COMPONENT
Computer 	RGB output terminal 	RGB cable (commercially available) 	COMPUTER/COMPONENT
	HDMI output terminal 	HDMI cable (commercially available) 	HDMI 1, 2

Connecting to Video Equipment

Before connecting, be sure to unplug the power cord of the projector from the AC outlet and turn off the devices to be connected. After making all connections, turn on the projector and then the other devices.

Connecting equipment with HDMI output terminal to the HDMI terminal on the projector

For video connection, use a cable that conforms to HDMI standards. Using cables that do not conform to HDMI standards may result in a malfunction.

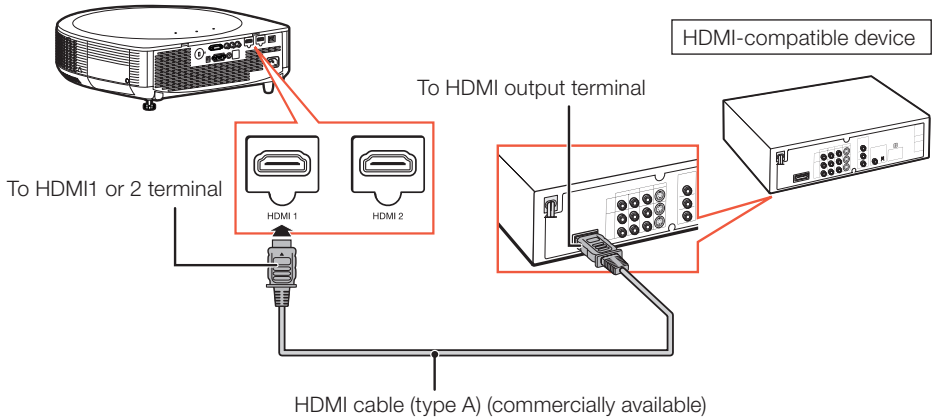

Note

- Depending on specifications of equipment or the DVI↔HDMI digital cable, the signal transmission may not work properly. (The HDMI specification does not support all connections to equipment that has digital output terminal using a DVI↔HDMI digital cable.)
- HDMI (High-Definition Multimedia Interface) is a digital AV interface that can deliver a high-definition video signal, multi-channel audio signal, and bi-directional control signal all in just one cable.
- Because it is compatible with the HDCP (High-bandwidth Digital Content Protection) system, the digital video signal does not degrade when transmitted, and a high-quality image with a simple connection can be enjoyed.

Connecting to a Computer

Ensure that the computer is the last device to be turned on after all the connections are made.

Connecting to a computer using the RGB cable

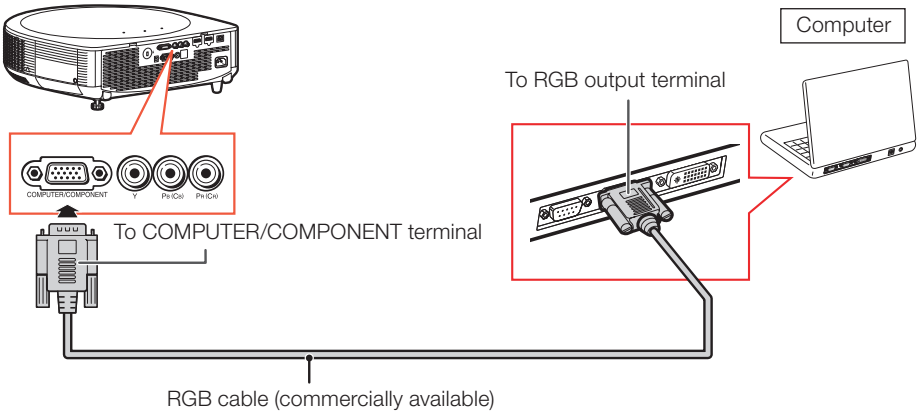

Note

- See page 81 "Compatibility Chart" for a list of computer signals compatible with the projector. Use with computer signals other than those listed may cause some of the functions to not work.
- A Macintosh adaptor may be required for use with some Macintosh computers. Contact your nearest Macintosh Dealer.
- **Depending on the computer you are using, an image may not be projected unless the computer's external output port is switched on (e.g. Press "Fn" and "F5" keys simultaneously when using a SHARP notebook computer).** Refer to the specific instructions in your computer's operation manual to enable your computer's external output port.

Controlling the Projector by a Computer

When the RS-232C terminal on the projector is connected to a computer with an RS-232C serial control cable (cross type, commercially available), the computer can be used to control the projector and check the status of the projector. Refer to the "SETUP MANUAL" contained on the supplied CD-ROM for "RS-232C Specifications and Commands".

When connecting to a computer using an RS-232C serial control cable

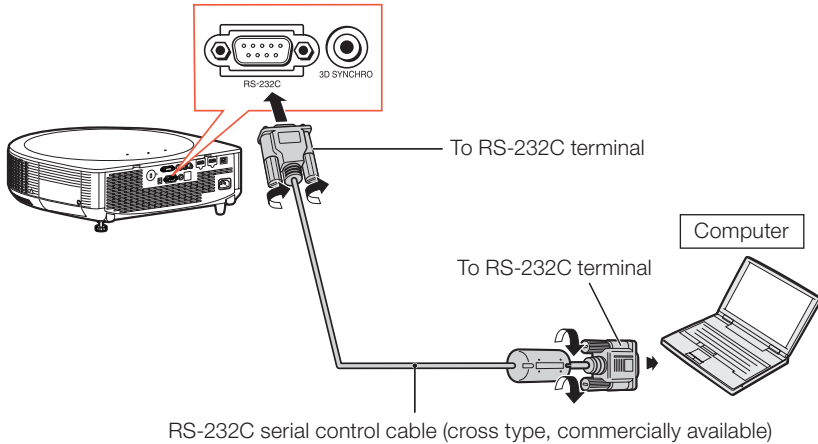

Note

- The RS-232C function may not operate if your computer terminal is not correctly set up. Refer to the operation manual of the computer for details.
- Refer to pages **2** to **7** of the "SETUP MANUAL" contained on the supplied CD-ROM for "Connecting Pin Assignments" and "RS-232C Specifications and Commands".

Info

- Do not connect the RS-232C cable to a port other than the RS-232C terminal on the computer. This may damage your computer or projector.
- Do not connect or disconnect an RS-232C serial control cable to or from the computer while it is on. This may damage your computer.

When connecting to the LAN terminal using a LAN cable

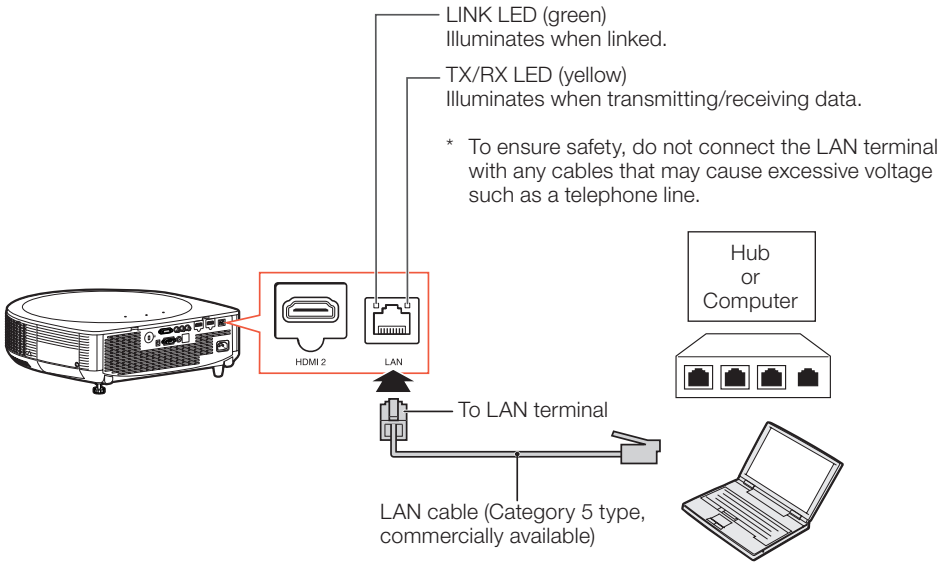

Note

- When connecting to a hub, use a straight-through Category 5 (CAT.5) type cable (commercially available).
- When connecting to a computer, use a cross-over Category 5 (CAT.5) type cable (commercially available).

Connecting the Power Cord

Plug the supplied power cord into the AC socket on the rear of the projector. Then plug into AC outlet.

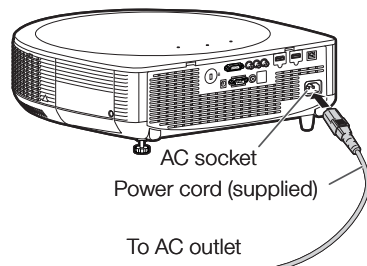

Turning the Projector On/Off

Turning the Projector On

Note that the connections to external equipment and power outlet should be done before performing the operations written below. (See pages 23 to 27.)

Press **STANDBY/ON** on the projector or **ON** on the remote control.

- The power indicator illuminates green.
- After the lamp indicator illuminates, the projector is ready to start operation.

Note

• About the Lamp Indicator

The lamp indicator illuminates to indicate the status of the lamp.

Green: The lamp is on.

Blinking in green: The lamp is warming up.

Red: The lamp is shut down abnormally or the lamp should be replaced.

- When switching on the projector, a slight flickering of the image may be experienced within the first minute after the lamp has been illuminated. This is normal operation as the lamp's control circuitry is stabilising the lamp output characteristics. It should not be regarded as faulty operation.
- If the projector is put into Standby mode and immediately turned on again, the lamp may take some time to start projection.

Info

- English is the factory default language. If you want to change the on-screen display to another language, change the language according to the procedure on page 53.

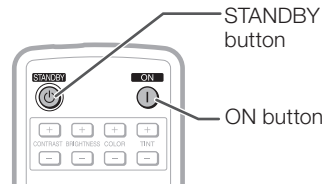
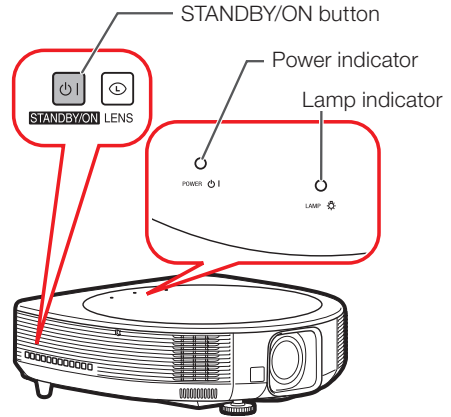

Turning the Power Off (Putting the Projector into Standby Mode)

Press **STANDBY/ON** on the projector or **STANDBY** on the remote control, then press that button again while the confirmation message is displayed, to put the projector into Standby mode.

- The projector cannot be turned on while cooling.

On-screen display (confirmation message)

 Enter STANDBY mode?
Yes : Press Again
No : Please Wait

Info

• Direct Power Off function:

You can unplug the power cord from the AC outlet even if the cooling fan is still running.

Image Projection

Shifting the Lens

In addition to the zoom function and adjustment of projection angle using the adjustment feet, you can adjust the position of the projection using the lens shift function. This is a useful function in cases such as when the screen cannot be moved.

When moving upward or downward

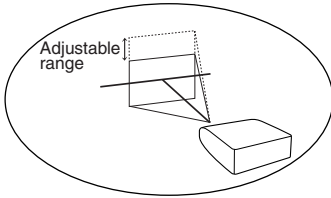

When moving in the left and right direction

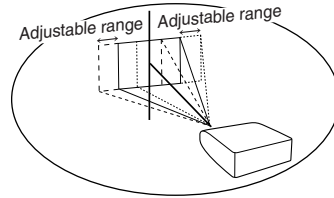

Adjustable range

- The adjustable range is shown below.
Horizontal range: $\pm 20\%$
Vertical range: $\pm 50\%$
The adjustable range has limitations even within the range shown above.
- The image can be adjusted as shown on the diagram.
- Allow a margin of error in the value.

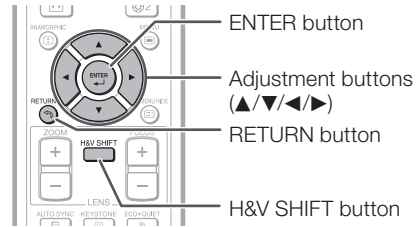

1 Press H&V SHIFT on the remote control.

- Pressing **ENTER** on the projector or on the remote control displays the test pattern. Checking the test pattern is useful for more accurate adjustment.

▼On-screen display

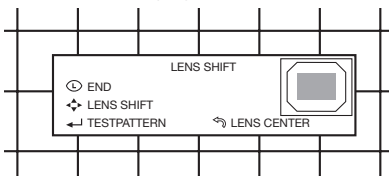

2 Press \uparrow , \downarrow , \leftarrow or \rightarrow on the projector or the remote control to adjust the image position.

Note

- When **RETURN** is pressed, the lens shift reset screen is displayed. Lens shift can be reset to factory default with this screen.

Position of the image when the image is centered, both vertically and horizontally, in lens shift

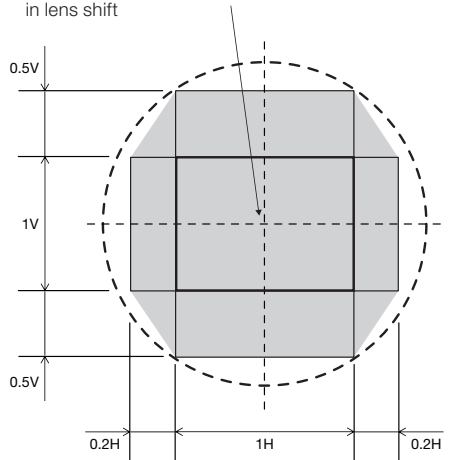

V: Height of the image
H: Width of the image

Image Projection (Continued)

Using the Adjustment Feet

- When the position of the projected image cannot be adjusted with the lens shift function, use the adjustment feet to adjust the projected angle.
- The height of the projector can be adjusted using the adjustment feet when the screen is inclined higher than the projector, the screen is inclined or when the installation site is slightly inclined.
- Install the projector so that it is as perpendicular to the screen as possible.

Rotate the adjustment feet to adjust the projected angle.

- The projector is adjustable up to approximately 9 degrees (front) and approximately ± 2 degrees (rear) from the standard position.

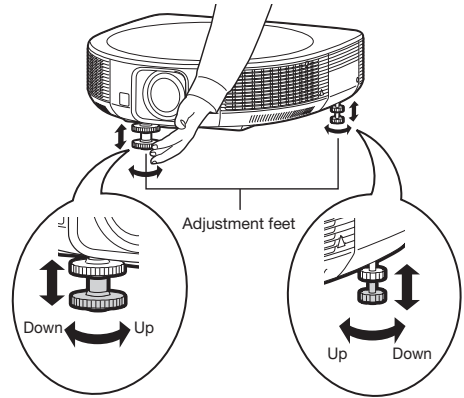

Warning!

- Do not hold the lens and lens cover when projector angle is adjusted.
- Use caution not to pinch your finger in the space between the adjustment foot and the projector when the projector angle is lowered.

Adjusting the Focus

Press **FOCUS +/-** on the remote control to adjust the focus.

▼On-screen display

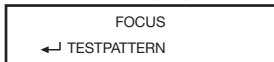

Info

- It is recommended that the focus be adjusted after the projector has warmed up for at least 30 minutes.

Adjusting the Projected Image Size

Press **ZOOM +/-** on the remote control to adjust the projected image size.

▼On-screen display

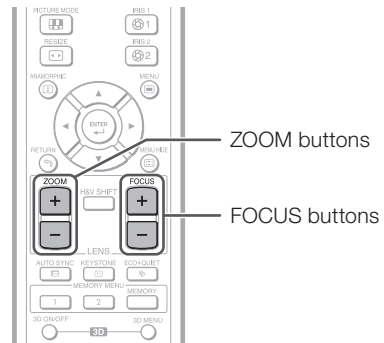
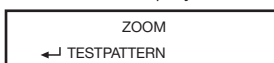

Note

- After you have pressed **FOCUS** or **ZOOM** on the remote control, you can display the test pattern by pressing **ENTER**. The test pattern is useful for making more accurate adjustments.
- For fine adjustments, when **H&V SHIFT**, **FOCUS** or **ZOOM** is pressed, the projected image moves a small amount in the desired direction for approximately one second. Hold down the buttons to move the projected image quickly.

Correcting Trapezoidal Distortion

When the image is projected either from the top or from the bottom towards the screen at an angle, the image becomes distorted trapezoidally. The function for correcting trapezoidal distortion is called Keystone Correction.

There are three types of the Keystone Correction.

- 1) "GEOMETRIC ADJUSTMENT" for correcting an image designating the corner of the projected image
- 2) "H&V KEYSTONE" for designating the correction of the horizontal and vertical axes
- 3) "SPHERE" for correcting the distortion of an image projected on a spherical or cylindrical screen

Selecting the Type of the Correction

- 1 Press **KEYSTONE**.
 - The KEYSTONE MODE list appears.

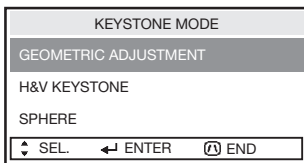

- 2 Press **▲/▼** to select the desired Keystone mode, and then press **ENTER**.
 - The menu guide appears.

- 3 Press **▲/▼/◀/▶** to adjust the Keystone Correction.

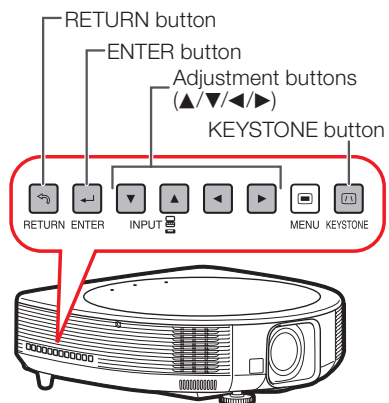
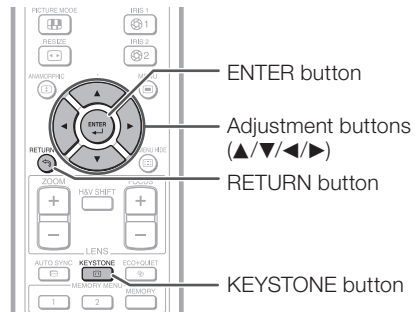

Image Projection (Continued)

GEOMETRIC ADJUSTMENT

1 Press **KEYSTONE**.
• The KEYSTONE MODE list appears. (See page 31.)

2 Press **▲/▼** to select “**GEOMETRIC ADJUSTMENT**”, and then press **ENTER**.

3 Press **▲, ▼, ◀** or **▶** to move the position for the upper left of the image.

4 Press **ENTER** to set the position.

5 Repeat the same procedure with the positions for the upper right, lower right and lower left of the image.
• At this time, pressing **RETURN** on the projector or on the remote control returns to the previous screen.
• When the position of the lower left is set, the correction is made and the display disappears.

▼On-screen display

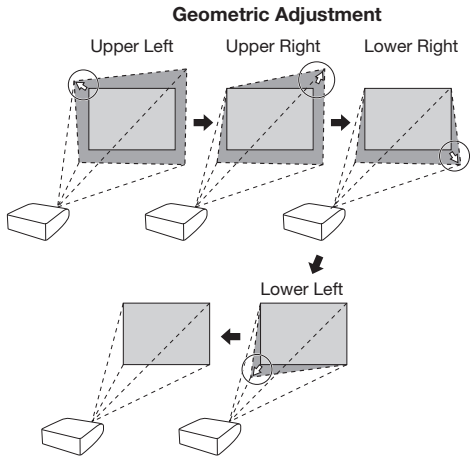
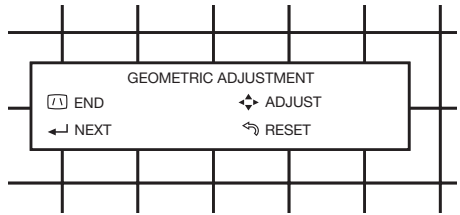

H&V KEYSTONE

- 1 Press **KEYSTONE**.
 - The KEYSTONE MODE list appears. (See page 31.)

- 2 Press **▲/▼** to select “H&V KEYSTONE”, and then press **ENTER**.

- 3 Press **▲** or **▼** to parallelize the left and right sides of the projected image.

- 4 Press **◀** or **▶** to parallelize the upper and lower sides of the projected image.

- 5 Press **KEYSTONE** to set the position.

▼On-screen display

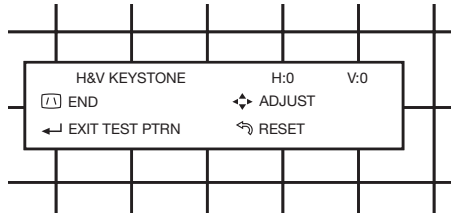

Vertical Keystone Correction
(Adjustment with ▲ / ▼)

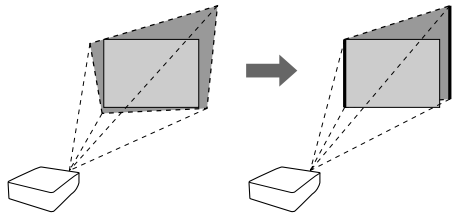

Horizontal Keystone Correction
(Adjustment with ◀ / ▶)

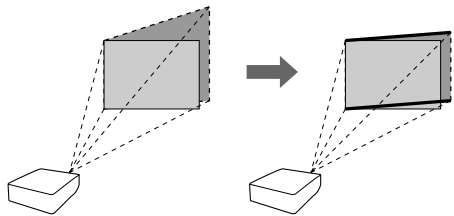

Image Projection (Continued)

SPHERE

- 1 Press **KEYSTONE**.
 - The KEYSTONE MODE list appears. (See page 31.)

- 2 Press **▲/▼** to select “**SPHERE**”, and then press **ENTER**.

- 3 Press **▲/▼/◀/▶** to adjust the sphere correction.

- 4 Press **KEYSTONE** to set the position.

▼On-screen display

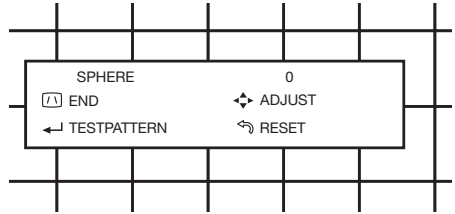

Concave Distortion Correction
(Adjustment with **▲/▶**)



Convex Distortion Correction
(Adjustment with **▼/◀**)

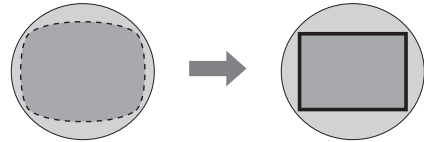

Switching the Input Mode

Select the appropriate input mode for the connected equipment.

Press **HDMI 1/2**, **COMPONENT** or **COMPUTER** on the remote control to select the input mode.

- When you select the input mode with **INPUT** ▼/▲ on the projector:
 - When ▼/▲ is pressed, the **INPUT** list appears. While the **INPUT** list is displayed, follow the procedure below to switch the input mode.

INPUT list

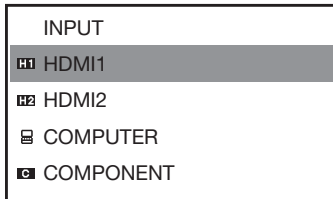



- Press ▼/▲ to select the desired input mode and then press **ENTER**.
 - If **ENTER** is not pressed, the projector switches to the selected input mode in a few seconds.

Note

- When you switch the input mode, the image as shown below will be displayed in the upper right corner of the screen. (You can confirm the selected input mode and information on the input signal.)



- When  is displayed, "3D" is set to "On".
- If  is displayed, it means that a 3D image signal that can be automatically detected is being input.

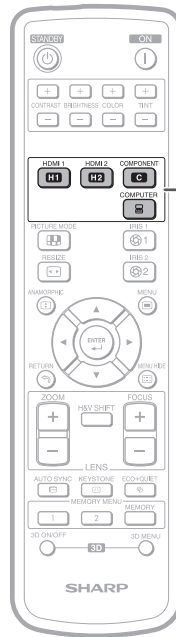

HDMI 1/2, COMPONENT and COMPUTER buttons

Image Projection (Continued)

Resize Mode

This function allows you to modify or customize the Resize mode to enhance the input image. Depending on the input signal, you can choose a desired image.

Press RESIZE on the remote control or on the projector.

- See page 51 for setting on menu screen.

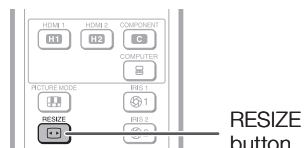

RESIZE	Output screen image
NORMAL	<p>The image is displayed with the original aspect ratio.</p>
16:9	<p>An image compressed from a 16:9 aspect ratio to a 4:3 aspect ratio is restored to a 16:9 aspect ratio and displayed at full-screen.</p>
CINEMA ZOOM	<p>A CinemaScope image or an image with a 16:9 aspect ratio is displayed at full-screen.</p>
ZOOM 14:9	<p>An image with a 14:9 aspect ratio and letterboxing is enlarged while maintaining the original aspect ratio.</p>
SMART ZOOM	<p>An image with a 4:3 aspect ratio is slightly enlarged.</p>
NATIVE	<p>The image is displayed according to the original input signal.</p>

About Copyrights

- When using the Resize function to select an image size with a different aspect ratio to a TV program or video image, the image will look different from its original appearance. Keep this in mind while choosing an image size.
- The use of the Resize, Keystone Correction, Overscan or Anamorphic function to compress or stretch the image for commercial purposes/public displays in a café, hotel, etc. may be an infringement of copyright protected by law for copyright holders. Please use caution.

Operating with the Remote Control

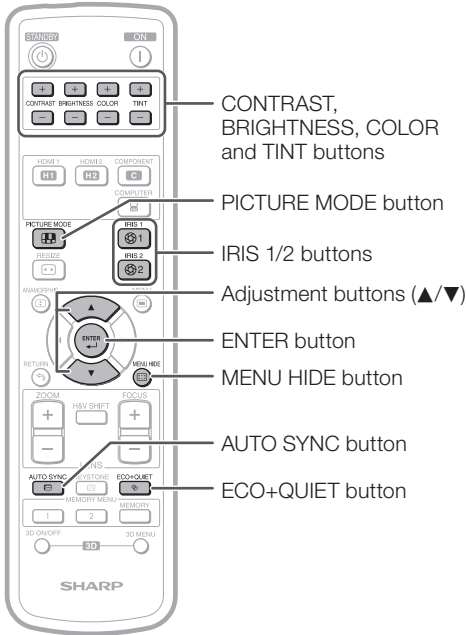

Adjusting the Image

You can adjust the contrast, brightness, color and tint.

Press image adjustment buttons.

Button	+ button	- button
CONTRAST	For more contrast.	For less contrast.
BRIGHTNESS	For more brightness.	For less brightness.
COLOR	For more color intensity.	For less color intensity.
TINT	For making skin tones greenish.	For making skin tones purplish.

Selecting the Picture Mode

You can select the appropriate Picture mode for the projected image, such as movie or video game.

- 1 Press **PICTURE MODE** to display the Picture Mode list.
- 2 Press **▲/▼** to select the appropriate picture mode, and then press **ENTER**.

Picture Mode list

Picture Mode
Standard
Movie1
Movie2
Monochrome
Anime
Sports
Stage
Dynamic
User1
User2
Game

Note

- You can also select a picture mode when projecting images in 3D mode.
- See page 44 for details on the Picture mode.

Operating with the Remote Control (Continued)

Switching the Iris Setting

This function controls the quantity of the projected light and the contrast of the image.

Press **IRIS 1** or **2**.

- Each time the button is pressed while the display is on, the mode changes in the following order:
 - IRIS 1 High Brightness ↔ High Contrast
 - IRIS 2 On ↔ Off

Note

- For details, see page [45](#).

Auto Sync (Auto Sync Adjustment)

Auto Sync function works when detecting input signal after the projector turns on.

Press **AUTO SYNC** to manually adjust with Auto Sync function.

Note

- When the optimum image cannot be achieved with Auto Sync adjustment, use manual adjustments. (See page [49](#).)

Hiding the Menu Temporarily

When the menu screen is displayed, you can temporarily hide the menu screen by pressing and holding **MENU HIDE** on the remote control. This is useful when, for example, checking the video adjustment information.

Switching the Eco+Quiet Mode

Press **ECO+QUIET** to switch the Eco+Quiet mode between on and off.

- When the Eco+Quiet Mode is set to "On", the sound of the cooling fan will turn down, the power consumption will decrease, and the lamp life will extend.

Note

- Refer to "Eco+Quiet" on page [45](#) for details.

Menu Items

The following shows the items that can be set in the projector.

“Picture” menu

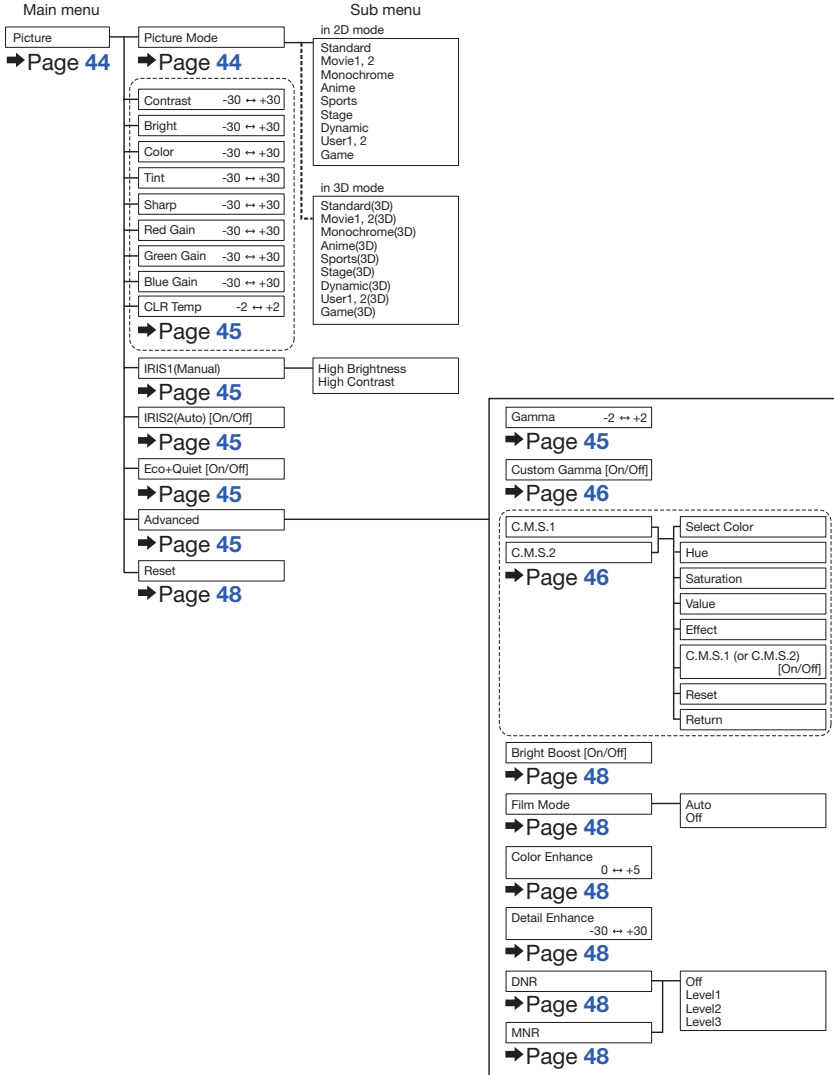

Menu Items (Continued)

“Signal adjustment (SIG-ADJ)” menu

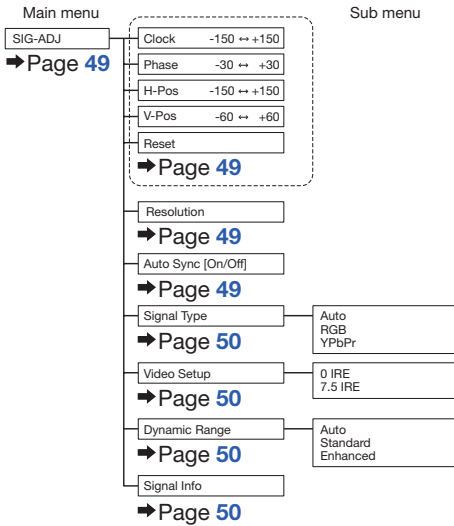

“Screen adjustment (SCR-ADJ)” menu

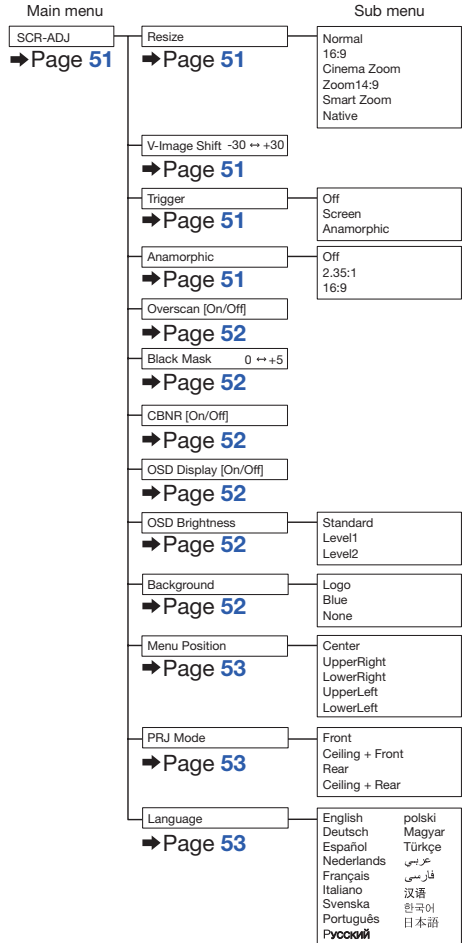

“Projector adjustment (PRJ-ADJ)” menu

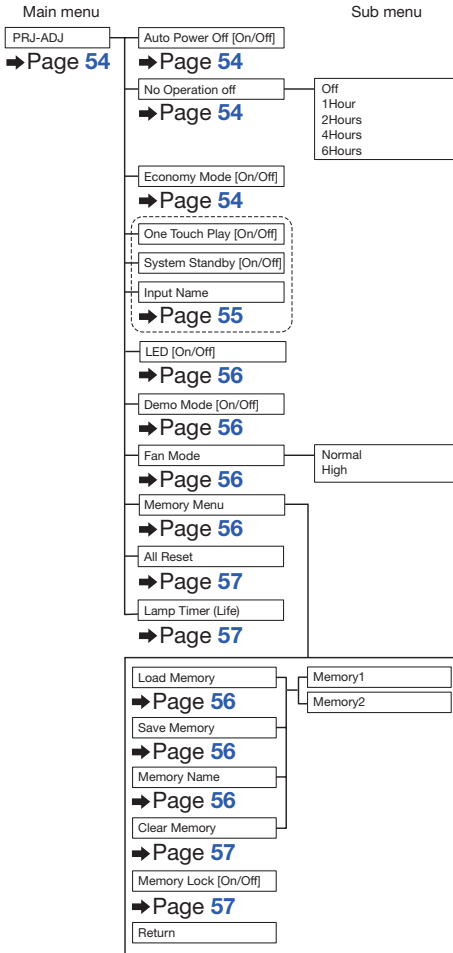

“Network” menu

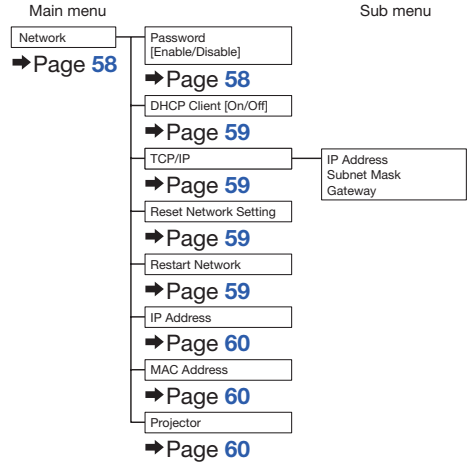

“3D MENU”

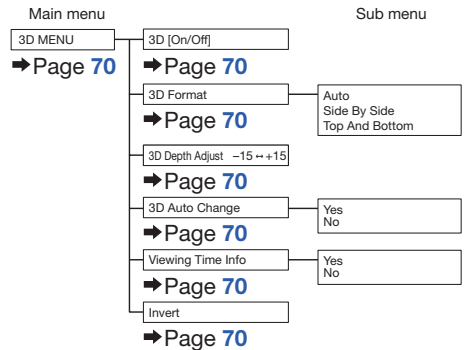

Using the Menu Screen

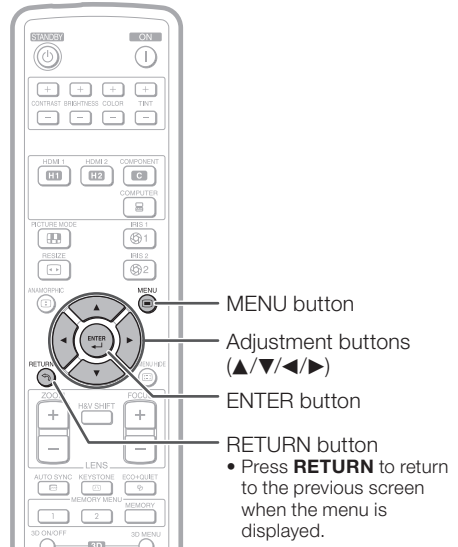
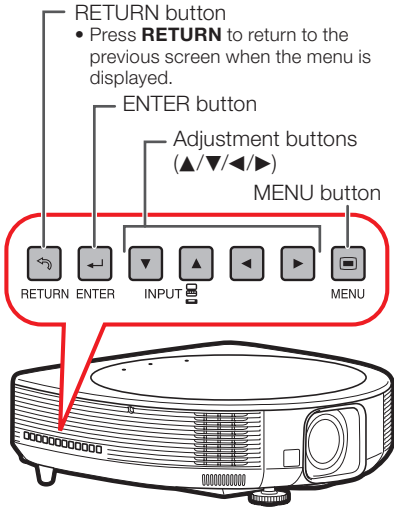

Menu Selections (Adjustments)

Example: Adjusting “Bright”.

- This operation can also be performed by using the buttons on the projector.

1 Press MENU.
 • The “Picture” menu screen for the selected input mode is displayed.

2 Press ▶ or ◀ and select “Picture” to adjust.

Example: “Picture” screen menu

Picture	SIG	SCR	PRJ	Net.
Picture Mode		↕ Standard		
Contrast	0	▬	▬	▬
Bright	0	☼	▬	☼
Color	0	☼	▬	☼
Tint	0	▬	▬	▬
Sharp	0	▬	▬	▬
Red Gain	0	▬	▬	▬
Green Gain	0	▬	▬	▬
Blue Gain	0	▬	▬	▬
CLR Temp	0	☼	▬	☼
IRIS1 (Manual)		↕ High Brightness		
IRIS2 (Auto)		↕ On		
Eco+Quiet		↕ Off		
Advanced				
◆◆Reset				
↕ SEL./ADJ.		↕ ENTER		
↶ RETURN		☼ END		

3 Press ▲ or ▼ and select “Bright” to adjust.

- The selected item is highlighted.

To adjust the projected image while watching it

Press ENTER.

- The selected item (e.g. “Bright”) is displayed by itself at the bottom of the screen.
- When pressing ▲ or ▼, the following item (“Color” after “Bright”) will be displayed.

Note

- Press **ENTER** again to return to the previous screen.

4 Press ◀ or ▶ to adjust the item selected.

- The adjustment is stored.

5 Press MENU.

- The menu screen will disappear.

Picture	SIG	SCR	PRJ	Net.
Picture Mode		⇅	Standard	
Contrast	0			
Bright	0			
Color	0			
Tint	0			
Sharp	0			
Red Gain	0			
Green Gain	0			
Blue Gain	0			
CLR Temp	0			
IRIS1 (Manual)		⇅	High Brightness	
IRIS2 (Auto)		⇅	On	
Eco+Quiet		⇅	Off	
Advanced				
◆◆ Reset				
◆ SEL./ADJ.		⇐ ENTER		
↶ RETURN		⏻ END		

Items to be adjusted

Pict.	SIG-ADJ	SCR	PRJ	Net.
Clock	0	⇅		
Phase	0			
H-Pos	0			
V-Pos	0			
◆◆ Reset				

↑ ↓ Press **ENTER**.

The item displayed by itself

Bright	0			
--------	---	--	--	--

Picture	SIG	SCR	PRJ	Net.
Picture Mode		⇅	Standard	
Contrast	0			
Bright	15			
Color	0			
Tint	0			
Sharp	0			
Red Gain	0			
Green Gain	0			
Blue Gain	0			
CLR Temp	0			
IRIS1 (Manual)		⇅	High Brightness	
IRIS2 (Auto)		⇅	On	
Eco+Quiet		⇅	Off	
Advanced				
◆◆ Reset				
◆ SEL./ADJ.		⇐ ENTER		
↶ RETURN		⏻ END		

Picture Adjustment (“Picture” Menu)

Menu operation → Page 42

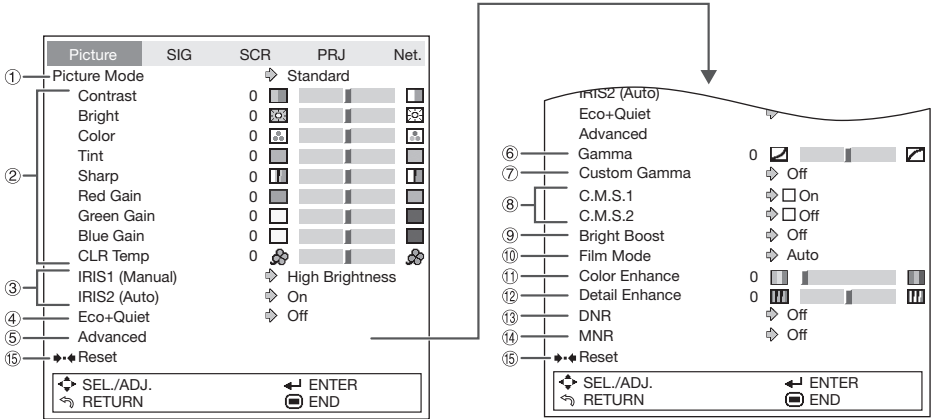

1 Selecting the Picture Mode

This function allows you to select the picture mode that best suits the room brightness and the type of image being projected.

Selectable items	Description
Standard	For standard image.
Movie1	For viewing movies with a lot of bright scenes.
Movie2	For viewing movies with a lot of dark scenes.
Monochrome	For viewing black-and-white movies.
Anime	For viewing anime or animated movies.
Sports	For viewing sports and other images with fast-moving subjects.
Stage	For viewing live performances.
Dynamic	A vivid image is obtained.
User1, 2	For customizing the picture mode settings as desired.
Game	Use this when the audio and image are not synched or when you want to create a sharper image.

- You can set or adjust each item in the “Picture” menu to your preference. Any changes you make are retained in memory.

Note

- You can also select a picture mode when projecting images in 3D mode.
- You can also press **PICTURE MODE** on the remote control to select the picture mode. (See page 37.)
- The default settings are subject to change without notice.

② Adjusting the Image

Adjustment items	◀ button	▶ button
Contrast	For less contrast.	For more contrast.
Bright	For less brightness.	For more brightness.
Color	For less color intensity.	For more color intensity.
Tint	For making skin tones purplish.	For making skin tones greenish.
Sharp	For less sharpness.	For more sharpness.
Red Gain	For making images less reddish.	For making images more reddish.
Green Gain	For making images less greenish.	For making images more greenish.
Blue Gain	For making images less bluish.	For making images more bluish.
CLR Temp	For making images slightly more reddish (slightly warmer colors).	For making images slightly more bluish (slightly cooler colors).

Note

- You can also use **CONTRAST**, **BRIGHTNESS**, **COLOR** or **TINT** on the remote control to adjust each item. (See page 37.)

③ Switching the Iris Setting

This function controls the quantity of the projected light and the contrast of the image.

■ IRIS1 (Manual)

Selectable items	Description
High Brightness	This mode gives priority to brightness over contrast.
High Contrast	This mode gives priority to contrast over brightness.

■ IRIS2 (Auto)

This automatically selects the optimal contrast to match the image.

Selectable items	Description
On	This mode gives priority to contrast with the use of auto adjustment.
Off	This mode gives priority to brightness without the use of auto adjustment.

Note

- You can also use **IRIS 1/2** on the remote control to change the Iris. (See page 38.)

④ Eco+Quiet

Selectable items	Power consumption
On	Approx. 70%
Off	100%

Note

- When "Eco+Quiet" is set to "On", the power consumption will decrease and the lamp life will extend.
- You can also use **Eco+QUIET** on the remote control to switch the Eco+Quiet mode. (See page 38.)

⑤ Using the Advanced

"Advanced" allows you to make even finer adjustments to the image so that it appears just the way you want it to.

To display the Advanced menu, select "Advanced" and press **ENTER**.

Note

- When the "Advanced" settings are displayed, select "Advanced" again and press **ENTER** to return to the "Picture" menu.

⑥ Correcting Gradation of Video (Gamma Correction)

When the darker areas of the image become difficult to see because of the image or the projection environment, you can correct the gamma setting to make the image brighter and easier to see.

Selectable items	Description
+2	Provides a brighter gradation.
+1	
0	Standard setting
-1	Provides a darker gradation.
-2	

Picture Adjustment (“Picture” Menu) (Continued)

Menu operation → Page 42

⑦ Custom Gamma

The Custom Gamma function can be used when “Picture Mode” is set to “User1” or “User2”.

You can adjust the gamma curve and save your custom setting. Adjust it to suit the picture brightness.

- 1 Press ▲/▼ to select “Custom Gamma” on the gamma adjustment screen, and then press ►.

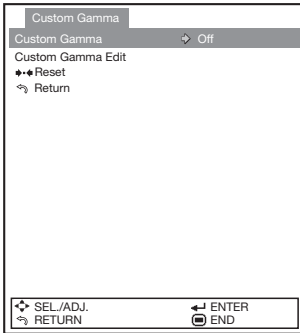

- 2 Press ▲/▼ to select “On”.

- 3 Press ▼ to select “Custom Gamma Edit”, and then press ENTER.

- 4 Adjust the curve to adjust the image brightness.

- Press ◀/▶ to adjust the white level. Select from 10 levels, from 5% to 80%.
- Press ▲/▼ to adjust the optical output value. Select a value from 0% to 100%.

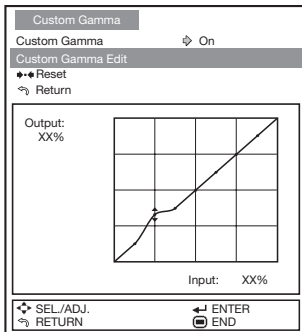

- 5 Press ENTER to display the confirmation screen. Use ▲/▼ to select “Save” and press ENTER.

- 6 To complete the Custom Gamma adjustment, select “Return” and press ENTER.

⑧ Adjusting the Colors

You can select the color of the projected image to correct and then adjust it to the desired color by setting “Hue”, “Saturation”, “Value”, and “Effect”.

Note

- Before performing this adjustment, prepare the image to be adjusted.
- You can perform this adjustment easier in the still image than in the moving image.

- 1 Select “C.M.S.1” or “C.M.S.2” (C.M.S.: Color Management System) in the “Advanced” menu, and press ►.

- If there is no data for the stored corrected color, the color selection screen and the picker is displayed. (Go to step 2.)

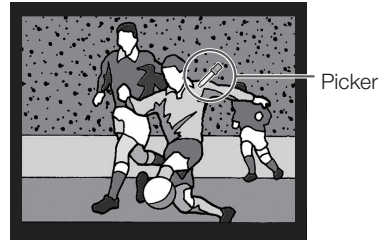

- If there is data for the stored corrected color, the C.M.S. color adjustment screen is displayed. (Go to step 3.)

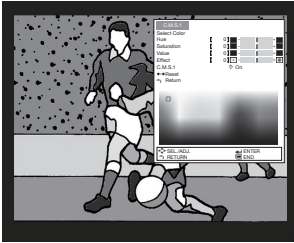

2 Use the picker and select the color of the projected image to correct. The picker can be operated by adjustment buttons (▲/▼/◀/▶) on the remote control.

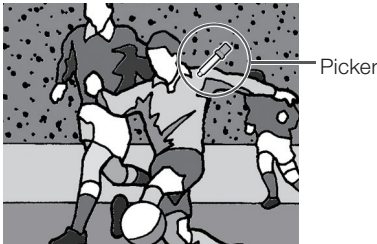

- By continuing to press the adjustment buttons (▲/▼/◀/▶), the picker moves rapidly.

After selecting the color of the projected image to correct, press **ENTER**. The C.M.S. color adjustment screen is displayed. (Go to step 3.)

3 Set or adjust each item in the C.M.S. color adjustment screen.

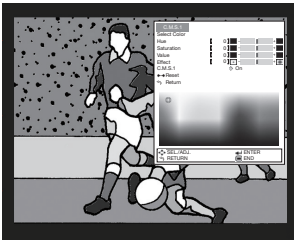

C.M.S. color adjustment screen:

Selectable items	Description
Select Color	Starts over the selection of the color to be corrected.
Hue	Sets the hue of the main colors.
Saturation	Sets the saturation of the main colors.
Value	Sets the value of the main colors.
Effect*1	Specifies the range of color correction.
C.M.S.1 ² (or C.M.S.2)	Checks the appearance of the projected image after above correction.
Reset	Sets "Hue", "Saturation", "Value", and "Effect" to their default values.
Return	Completes the correction and closes the C.M.S. color adjustment screen.

*1 To specify the range of color correction, select "Effect" and press ◀ or ▶.

◀ button	Specifies smaller range.
▶ button	Specifies larger range.

*2 To check the appearance of the projected image, select "C.M.S.1" (or "C.M.S.2") and set to "On" or "Off".

On	The appearance of the projected image after above color adjustment reflected can be checked.
Off	The appearance of the projected image in former color adjustment can be checked.

4 To complete the C.M.S. color adjustment, select "Return" and press ENTER.

Note

- The C.M.S. color adjustment can be made to one color each in "C.M.S.1" and "C.M.S.2".

Picture Adjustment (“Picture” Menu) (Continued)

Menu operation → Page 42

⑨ Adjusting the Bright Boost

Bright Boost uses Texas Instruments’ Bright Boost technology. The image becomes brighter while the color reproduction is kept at a high level.

Selectable items	Description
On	The Bright Boost function is activated.
Off	The Bright Boost function is not activated.

⑩ Selecting the Film Mode

This function provides high-quality playback of images originally projected at 24 fps, such as movies on DVDs.

Selectable items	Description
Auto	Films are detected automatically.
Off	Films are not detected.

⑪ Setting Color Enhancement

This function makes the projected images clearer and crisper.

◀ button	Provides less color enhancement.
▶ button	Provides more color enhancement.

⑫ Setting Detail Enhancement

This function enhances the details in images and, thereby, creates a greater sense of depth.

◀ button	Provides less detail enhancement.
▶ button	Provides more detail enhancement.

⑬ Reducing Image Noise (DNR)

Video digital noise reduction (DNR) provides high quality images with minimal dot crawl and cross color noise.

Selectable items	Description
Off	The DNR function is not activated.
Level 1	Sets the DNR level for viewing a clearer picture.
Level 2	
Level 3	

Note

- Set “DNR” to “Off” in the following cases:
 - When the image is blurry.
 - When the contours and colors of moving images drag.
 - When TV broadcasts with weak signals are projected.
- This function is available for the following signals.
 - 480I/480P
 - 576I/576P

⑭ Mosquito Noise Reduction (MNR)

The so-called Mosquito Noise (flickering) can be reduced.

Selectable items	Description
Off	MNR does not function.
Level 1	Sets the MNR level for viewing a clearer picture.
Level 2	
Level 3	

Note

- Set “MNR” to “Off” in the following cases:
 - When the image is blurry.
 - When the contours and colors of moving images drag.
 - When TV broadcasts with weak signals are projected.
- This function is available for the following signals.
 - 480I/480P
 - 576I/576P

⑮ Resetting All Adjustment Items

To reset all adjustment items to the default settings, select “Reset” and press **ENTER**.

Computer Image Adjustment (“SIG-ADJ” Menu)

Menu operation → Page 42

	Pict.	SIG-ADJ	SCR	PRJ	Net.
①	Clock	0	[↑]	[↓]	[↑]
	Phase	0	[←]	[→]	[↔]
	H-Pos	0	[←]	[→]	[↔]
	V-Pos	0	[↑]	[↓]	[↕]
	◆◆◆ Reset				
②	Resolution		◇		
③	Auto Sync		◇ On		
④	Signal Type		◇ Auto		
⑤	Video Setup		◇ 0 IRE		
⑥	Dynamic Range		◇ Auto		
⑦	Signal Info : 1080P H : XX.X kHz/ V : XX.X Hz				
	◆◆◆ SEL./ADJ.		← ENTER		
	↶ RETURN		END		

* Displayed when the input mode is HDMI input.

① Adjusting the Computer Image

Use the SIG-ADJ function in case of irregularities such as vertical stripes or flickering in portions of the screen.

Selectable items	Description
Clock	Adjusts vertical noise.
Phase	Adjusts horizontal noise (similar to tracking on your VCR).
H-Pos	Centers the on-screen image by moving it to the left or right.
V-Pos	Centers the on-screen image by moving it up or down.

Note

- You can automatically adjust the computer image by setting “Auto Sync” in the “SIG-ADJ” menu to “On”, or pressing **AUTO SYNC** on the remote control.
- Depending on the type of input signal, the adjustment range for each setting may vary or the adjustment may not be available at all.
- To reset all adjustment items, select “Reset” and press **ENTER**.

② Setting the Resolution

Ordinarily, the type of input signal is detected and the correct resolution mode is automatically selected. However, for some signals, the optimal resolution mode in “Resolution” in the “SIG-ADJ” menu may need to be selected to match the computer display mode.

Note

- Avoid displaying computer patterns which repeat every other line (horizontal stripes). (Flickering may occur, making the image hard to see.)
- Information on the currently selected input signal can be confirmed in item ⑦ on page 50.

③ Auto Sync (Auto Sync Adjustment)

Selectable items	Description
On	Auto Sync adjustment will occur when the projector is turned on or when the input signals are switched, when connected to a computer.
Off	Auto Sync adjustment is not automatically performed.

Note

- Auto Sync adjustment is also performed by pressing **AUTO SYNC** on the remote control.
- When setting “Auto Sync” to “Off”, and if **AUTO SYNC** is pressed, Auto Sync will be executed in “On” mode. If the button is pressed again within one minute, Auto Sync will be executed in “On” mode.
- The Auto Sync adjustment may take some time to complete, depending on the image of the computer connected to the projector.
- When the optimum image cannot be achieved with Auto Sync adjustment, use manual adjustments.

Computer Image Adjustment (“SIG-ADJ” Menu) (Continued)

Menu operation → Page 42

④ Signal Type Setting

When using an input mode of HDMI1, HDMI2, or COMPUTER, set the signal type to the corresponding input signal type (RGB or YPbPr).

Selectable items	Description
Auto	Automatically selects the appropriate input signal between RGB and YPbPr.
RGB	Set when RGB signals are received.
YPbPr	Set when YPbPr signals are received.

⑤ Setting the Video Setup

Selectable items	Description
0 IRE	Sets the black level to 0 IRE.
7.5 IRE	Sets the black level to 7.5 IRE.

Note

- This function is available for the following signal.
- 480I

⑥ Adjusting the Dynamic Range

An optimum picture may not be displayed if an HDMI-capable device's output signal type and the projector's input signal type do not match. If this should occur, switch “Dynamic Range”.

Selectable items	Description
Auto	In most circumstances, “Auto” should be selected.
Standard	When the black levels of the image show banding or appear faded, select the item that results in the best picture quality.
Enhanced	

⑦ Signal Info

Input signal information is displayed.

Adjusting the Projected Image (“SCR-ADJ” Menu)

Menu operation → Page 42

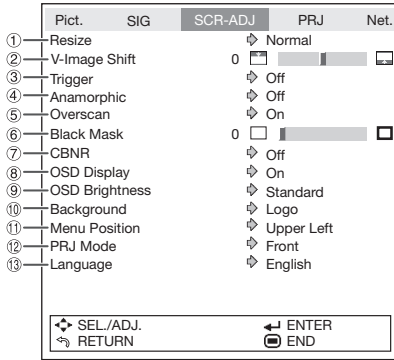

① Setting the Resize Mode

Note

- For details of the Resize mode, see page 36.
- You can also press **RESIZE** on the remote control to set the resize mode. (See page 36.)

② Adjusting the Image Position

You can move the projected image vertically.

◀ button	▶ button
Downward	Upward

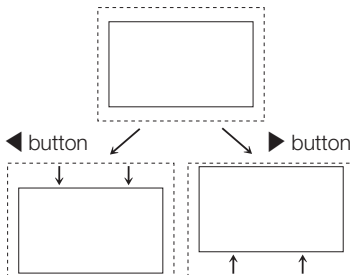

Note

- The adjustable range of the image shift may vary depending on:
 - the Resize mode
 - the Picture mode
 - the input signal resolution
 - the input 3D signal type

③ Trigger

This function allows you to set whether to output a control signal (DC 12V) that is output from the trigger terminal to a trigger-supported screen or anamorphic lens.

Selectable items	Description
Screen	A control signal (DC 12V) is output to a trigger-supported screen while linked with the power of the main unit. The screen extends and retracts automatically when the power of the projector is turned on and off.
Anamorphic	A control signal (DC 12V) is output when the Anamorphic function is set to "2.35:1" or "16:9".
Off	The Trigger function is not activated. (A control signal (DC 12V) is not output.)

④ Anamorphic

This function adjusts the vertical and horizontal directions of the image when projected using an anamorphic lens.

Selectable items	Description
2.35:1	Stretches a 2.35:1 image in the vertical direction of the panel resolution.
16:9	Select this when viewing images other than 2.35:1 while using an anamorphic lens. This compresses a 16:9 image in the horizontal direction while leaving the height of the panel resolution unchanged.
Off	The input image is projected as is. (Black bands are displayed on the top, bottom, left and right.)

Note

- RESIZE does not function when "Anamorphic" is set to "2.35:1" or "16:9".

Adjusting the Projected Image (“SCR-ADJ” Menu) (Continue)

Menu operation → Page 42

⑤ Adjusting the Overscan

This function allows you to adjust the Overscan area (display area).

Selectable items	Description
On	The input area is displayed without screen edges.
Off	The whole input area is displayed.

Note

- You can adjust the Overscan area for the following input signals and the RESIZE function.
 - Input signal:
 - 480I/480P
 - 540P
 - 576I/576P
 - 720P
 - 1035I
 - 1080I/1080P
 - RESIZE function:
 - NORMAL
 - 16:9
 - CINEMA ZOOM
 - ZOOM 14:9
- If the display area ratio is set too large, noise may appear at the screen edges. If this happens, set the display area ratio to a smaller value.
- Also read “About Copyrights” on page 36.

⑥ Black Mask

This function allows you to apply a black mask around the outside of the image to hide flicker on the edges. Select a level from 0 (%) to 5 (%).

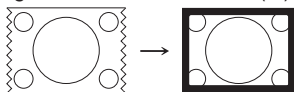

⑦ CBNR

This function reduces the color break noise.

Selectable items	Description
On	The CBNR function is activated.
Off	The CBNR function is not activated.

Note

- When “3D” is set to “On”, the CBNR function is disabled.
- When “CBNR” is set to “On”, the brightness is reduced.
- This function is available for the following signal.
 - 1080P (24Hz)

⑧ Setting On-screen Display

Selectable items	Description
On	All on-screen displays are displayed.
Off	INPUT/AUTO SYNC/RESIZE/ CONTRAST/BRIGHTNESS/COLOR/ TINT/ECO+QUIET/3D ON/OFF (3D/2D mode change) message are not displayed.

⑨ Setting the Brightness of the Menu Screen

Sets the brightness of the menu screen.

Selectable items	Description
Standard	Standard brightness
Level 1	Darker than the “Standard” brightness
Level 2	Darker than the “Level 1” brightness

⑩ Selecting the Background Image

Selectable items	Description
Logo	SHARP logo screen
Blue	Blue screen
None	— (Black screen)

⑪ Selecting the Menu Screen Position

Select “Menu Position” in the “SCR-ADJ” menu and the desired position for the menu screen.

Selectable items	Description
Center	Displayed on the center of the image.
Upper Right	Displayed on the upper right of the image.
Lower Right	Displayed on the lower right of the image.
Upper Left	Displayed on the upper left of the image.
Lower Left	Displayed on the lower left of the image.

⑫ Reversing/Inverting Projected Images

This function allows the projector to be used in a wider range of projection styles by allowing the image to be inverted to suit the projection environment (location).

Selectable items	Description
Front	Normal image (Projected from the front of the screen)
Ceiling + Front	Inverted image (Projected from the front of the screen with an inverted projector)
Rear	Reversed image (Projected from the rear of the screen or with a mirror)
Ceiling + Rear	Reversed and inverted image (Projected with a mirror)

See page 22 for details of Projection (PRJ) Mode.

⑬ Selecting the On-screen Display Language

The projector can switch the on-screen display language among 17 languages.

Adjusting the Projector Function (“PRJ-ADJ” Menu)

Menu operation → Page 42

	Pict.	SIG	SCR	PRJ-ADJ	Net.
①				↕ On	
②				↕ Off	
③				↕ Off	
④	One Touch Play			↕ Off	
	System Standby			↕ Off	
	Input Name				
⑤	LED			↕ Off	
⑥	Demo Mode			↕ Off	
⑦	Fan Mode			↕ Normal	
⑧	Memory Menu				
⑨	◆◆All Reset				
⑩	Lamp Timer (Life) [X]h [XX]min (XX%)				
	↕ SEL./ADJ.		↵ ENTER		
	↶ RETURN		⏻ END		

① Setting Auto Power Off Mode

This function automatically switches the projector to Standby mode if no signals are received for a set period.

Selectable items	Description
On	When no input signal is detected for more than 15 minutes, the projector will automatically enter Standby mode.
Off	The Auto Power Off function will be disabled.

Note

- When the Auto Power Off function is set to “On”, 5 minutes before the projector enters Standby mode, the message “Enter STANDBY mode in X min.” will appear on the screen to indicate the remaining minutes.

② Setting No Operation Off Mode

This function automatically switches the projector to Standby mode if there is no operation.

Selectable items	Description
Off	The No Operation Off function will be disabled.
1 Hour	Select the length of time the projector will take to automatically enter to Standby mode.
2 Hours	
4 Hours	
6 Hours	

Note

- When a time is set for the No Operation Off function and no operation has been performed, 5 minutes before the projector enters Standby mode, “Enter STANDBY mode in X min.” will appear on the screen to indicate the remaining minutes.

③ Setting the Power Save Mode (Economy Mode)

■ Economy Mode

Selectable items	Description
On	This enables the Economy mode.
Off	You can use the linked functions. RS-232C and network can be used to control the projector in Standby mode.

Note

- Set this function to “Off” when you want to use RS-232C and network to control the projector from a computer.
- One Touch Play is set to “Off” when the Economy mode is set to “On”.

4 Setting One Touch Play, System Standby and Input Name

When a Sharp product equipped with Consumer Electronics Control (HDMI CEC) is connected to the projector with an HDMI cable, you can use the linked function with HDMI CEC (“One Touch Play” and “System Standby”).

Note

- The CEC function may not work with some CEC devices. (When the projector is connected to a non-Sharp product, the CEC function may not work.)

Setting the One-Touch Playback Function (One Touch Play)

One Touch Play turns on the projector and selects the input automatically when you turn on or begin playback on connected HDMI-compliant Sharp Video Products.

Selectable items	Description
On	This enables One Touch Play.
Off	This disables One Touch Play.

Note

- When enabling One Touch Play, be sure to enable the CEC setting on the HDMI-compliant Sharp Video Products connected to the projector.
- The Economy mode is set to “Off” when One Touch Play is set to “On”.
- In the following cases, One Touch Play is not enabled.
 - When playback is paused
 - When the cooling fan is running (See page 76.)
 - When the lamp is warming up (See page 76.)

Setting the System Standby Function (System Standby)

When you turn off the projector, the HDMI-compliant video equipment connected to the projector enters Standby mode.

Selectable items	Description
On	This enables System Standby.
Off	This disables System Standby.

Note

- When enabling System Standby, be sure to enable the CEC setting on the HDMI-compliant Sharp Video Products connected to the projector.

Setting the Input Terminal Names (Input Name)

Set the name of the input terminal (up to 14 alphanumeric characters).

1 Press ▲/▼ to select “Input Name” and then press ENTER.

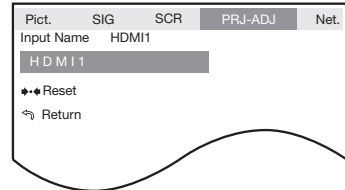

◀ or ▶ button	Selects a character column.
▲ or ▼ button	Selects a character.
ENTER button	Sets the input terminal name.

2 Press ▲/▼ to select “Return” and then press ENTER to return to the previous screen.

- To return to the previous setting, select “Reset” and then press **ENTER**.

Note

- When connecting the projector to a Sharp Video Product with an HDMI cable using an input mode of HDMI1 or HDMI2 and the linked function with HDMI CEC (“One Touch Play” or “System Standby”) works normally, the name of the connected Sharp Video Product is automatically captured.
- When the input terminal name has been changed by a user, the changed name is displayed.
- To return to the default name, select “Reset” and press **ENTER**.

Adjusting the Projector Function (“PRJ-ADJ” Menu) (Continued)

Menu operation → Page 42

⑤ Turning LED Off

LEDs (indicators) on the projector can be turned off when they are disturbing the projection.

Selectable items	Description
On	LEDs are turned on.
Off	LEDs are turned off while the projector is in operation. (LEDs turn on while the projector is in the Standby mode, warming up or indicating problems.)

Note

- When Auto Power Off function is set to “Off”, “LED” is set to “On” automatically. Be sure to set Auto Power Off function to “On” to use LED Off function. (See page 54.)

⑥ Setting the Demo Mode

Set the Demo Mode to “On” or “Off”.

Selectable items	Description
On	This enables Demo Mode.
Off	This disables Demo Mode.

⑦ Fan Mode Setting

This function changes the fan rotation speed.

Selectable items	Description
Normal	Suitable for normal environments.
High	Select this when using the projector at altitudes of approximately 4,900 feet (1,500 meters) or more.

- When “Fan Mode” is set to “High”, the fan rotation speeds up, and the fan noise becomes louder.

⑧ Memory Menu

You can store the settings of the projector's lens shift (ZOOM, FOCUS) and others (such as INPUT, PICTURE MODE, RESIZE, PRJ Mode, V-Image Shift, KEYSTONE and Anamorphic), or activate the stored settings.

The Memory Menu screen can also be displayed by pressing **MEMORY** on the remote control.

Load Memory

To activate the desired settings, select the item where the settings are stored.

Note

- Pressing any button while the projector is in the process of activating the “Load Memory” function will display messages:
 - “STOP”: stops the activation of the “Load Memory” function.
 - “CONTINUE”: allows the projector to the already set position.
 - “Return to the initial position.”: let the projector go back to the initial position.
- The confirmation screen of “Load Memory” will also be displayed by pressing **MEMORY 1/2** on the remote control. Press **MEMORY 1/2** again to perform the “Load Memory” function.
- The memory has a margin of error of approximately $\pm 2\%$. Use the remote control to make fine adjustments.

Save Memory

Select an item where you want to store the setting.

Note

- When you select an item where some setting has been stored, the stored setting will be overwritten and erased.

Memory Name

Select the item name you want to change. Use ◀/▶ to choose the characters to change, and ▲/▼ to select the characters to enter.

■ Clear Memory

Select the item where the settings you want to erase are stored. In this case, the memory name you have changed returns to the default setting.



Note

- Selecting “All Clear” erases all the stored settings.

■ Memory Lock

Selectable items	Description
On	Protects the stored memories.
Off	Does not protect the stored memories.

⑨ Returning to the Default Settings

Use “All Reset” to initialize all the adjustments you have made to the default settings.



Note

The following items cannot be initialized.

- “SIG-ADJ” menu
Resolution
- “SCR-ADJ” menu
Language
- “PRJ-ADJ” menu
Lamp Timer (Life)
Memory Menu

⑩ Lamp Timer (Life)

You can confirm the cumulative lamp usage time and the remaining lamp life (percentage).

Lamp usage condition	Remaining lamp life	
	100%	5%
Operated exclusively with “Eco+Quiet” set to “On”	Approx. 3,000 hours	Approx. 150 hours
Operated exclusively with “Eco+Quiet” set to “Off”	Approx. 2,000 hours	Approx. 100 hours



Note

- It is recommended that the lamp be changed when the remaining lamp life becomes 5%.
- The lamp life may vary depending on the usage condition.

Setting Up the Projector Network Environment (“Network” Menu)

Menu operation → Page 42

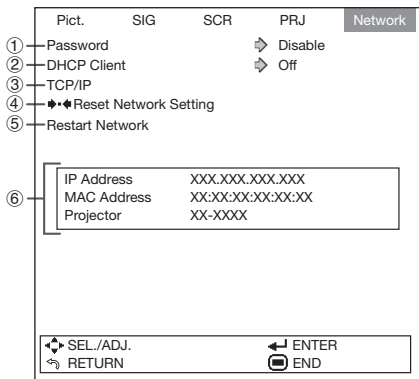

① Setting a Password

If you do not want others to change the setting for the “Network” menu, set a password.

■ Setting a Password

1 Select “Password”, then press ►.

- The screen for entering the password appears.

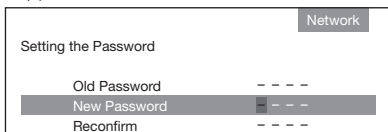

2 Press ▲ or ▼ to set the first digit in “New Password”, then press ►.

3 Enter the remaining 3 digits, then press ENTER.

- To return to the previous digit, press ◀.

4 Enter the same password in “Reconfirm”, then press ENTER.

- The status for “Password” changes to “Enable”.

Note

- Once the password is set, you must enter the password to change the “Network” menu settings.

■ Changing the Password

1 Select “Password”, then press ►.

- The screen for entering the password appears.

2 Enter the password in “Old Password” using ▲, ▼, ► and ◀, then press ENTER.

3 Enter the password in “New Password” using ▲, ▼, ► and ◀, then press ENTER.

4 Enter the same password again in “Reconfirm” using ▲, ▼, ► and ◀, then press ENTER.

Note

- If you do not need the password protection for the “Network” menu settings anymore, press ENTER without entering new password in steps 3 and 4.
- To cancel the password settings, press RETURN.

If you forget the password

If you forget the password, perform the following procedure to delete it, then set a new password.

On the projector, press



Note

- You cannot use the buttons on the remote control to delete the password.

② DHCP Client Setting

Connect the LAN cable before turning the projector on. If not, the DHCP Client function does not work.

Selectable items	Description
On	Obtains configuration parameters for TCP/IP network automatically.
Off	Sets the TCP/IP manually.

Select “On” for “DHCP Client”. “Obtaining IP Address...” appears, then the menu screen appears. Confirm the parameters of IP Address, Subnet Mask and Gateway on the TCP/IP screen.

If the DHCP server is not available, “Could not obtain IP Address.” appears.

In this case, set the TCP/IP manually. (See the item ③.)

③ TCP/IP Setting

Set the TCP/IP manually.

1 Select “Off” for “DHCP Client”, then press **ENTER**.

2 Select “TCP/IP”, then press **ENTER**.

3 Enter “IP Address” using **▲**, **▼**, **▶** and **◀**, then press **ENTER**.

Setting the TCP/IP		Network
IP Address	1 9 2 . 1 6 8 . 1 5 0 . 0 0 2	
Subnet Mask	2 5 5 . 2 5 5 . 2 5 5 . 0 0 0	
Gateway	0 0 0 . 0 0 0 . 0 0 0 . 0 0 0	

4 Enter “Subnet Mask” using **▲**, **▼**, **▶** and **◀**, then press **ENTER**.

5 Enter “Gateway” using **▲**, **▼**, **▶** and **◀**, then press **ENTER**.

Selectable items	Description
IP Address	Factory default setting: 192.168.150.002 Enter an IP address appropriate for the network.
Subnet Mask	Factory default setting: 255.255.255.000 Set the subnet mask to the same as that of the computer and equipment on the network.
Gateway	Factory default setting: 000.000.000.000 * When not in use, set to “000.000.000.000”.

Note

- Confirm the existing network’s segment (IP address group) to avoid setting an IP address that duplicates the IP addresses of other network equipment or computers. If “192.168.150.002” is not used in a network with an IP address of “192.168.150.XXX”, you don’t have to change the projector IP address.
- For details about each setting, consult your network administrator.

④ Returning to Default Settings (Network)

This function allows you to initialize the Network settings you have made in the projector.

Note

- If the values for IP Address, Subnet Mask or Gateway of the projector have been returned to the default settings, the computer cannot be connected to the projector depending on the computer’s network settings.

⑤ Restart Network Function

Restarts the network function.

Perform this function when the projector cannot be controlled via the network.

Setting Up the Projector Network Environment ("Network" Menu) (Continued)

Menu operation → Page 42

⑥ Confirming the Projector Information

You can confirm the following items.

Selectable items	Description
IP Address	The IP address of the projector is displayed.
MAC Address	The MAC address of the projector is displayed.
Projector	The projector name is displayed.

Note

- For information on how to change the projector name, see "SETUP MANUAL" contained in the supplied CD-ROM.

Enjoying 3D Image Viewing

CAUTION: Before viewing 3D images, please read this section carefully.

You can use special 3D Glasses to watch 3D-supported images on this projector.

- You can enjoy 3D images by viewing the video images through the 3D Glasses supplied with the projector or through optional 3D glasses sold separately.
- To produce 3D images, liquid crystal shutters in the 3D Glasses alternately open and close imperceptibly fast to exactly match alternating left and right video images displayed by the projector.
- Not all consumers can experience and enjoy 3D images. Some people suffer from stereo blindness which prevents them from perceiving the intended depth of 3D entertainment. Also, some people who watch 3D programming may experience initial feelings of motion sickness as they adjust to the picture. Others may experience headaches, eye fatigue or continued motion sickness. Like a roller coaster, the experience is not for everyone.

Precautions on using the 3D Glasses

- The 3D Glasses are precision equipment. Handle them with care.
- Improper use of the 3D Glasses or failure to follow these instructions can result in eye strain.
- If you experience dizziness, nausea, or other discomfort while viewing 3D images, immediately discontinue use of the 3D Glasses. Using the binocular disparity 3D system of this projector with incompatible 3D broadcasts or software can make images appear with a cross talk blur or create overlapping images.
- If you are nearsighted or farsighted or have astigmatism or a different level of eyesight between the left and right eyes, you should take the necessary steps, such as wearing eyeglasses, to correct your eyesight before viewing 3D images. The 3D Glasses can be worn over eyeglasses.
- The 3D Glasses are only recommended for people ages 5 and older.
- When children are viewing 3D images, be sure a parent or guardian is present. Monitor children viewing 3D images, and if

they show signs of discomfort, immediately discontinue use of the 3D Glasses.

- People with a known history of photosensitivity and people with heart problems or poor health should not use the 3D Glasses. This can worsen existing health conditions.
- Do not use the 3D Glasses for other purposes (such as general eyeglasses, sunglasses, or protective goggles).
- Do not use the 3D function or 3D Glasses while walking or moving around. This may result in injuries due to running into objects, tripping, and/or falling.
- When using the 3D Glasses, take care not to accidentally strike the screen or other people. Viewing 3D images may cause you to misjudge the distance to the screen and accidentally strike the screen, resulting in possible injury.

Precautions on installing the IR emitter

- Make sure that the bolts and screws are securely fastened. Otherwise, the unit may fall, resulting in injury or accident.
- Do not drop, disassemble, or modify the product, as this may result in damage or malfunction.
- Do not install the IR emitter with it directly facing the projector, as this may prevent the remote control of the projector from functioning properly.
- The IR emitter may interfere with other infrared communication equipment.
- When installing the IR emitter to a wall or ceiling, use screws that suit the material and strength of the wall or ceiling. Otherwise, it may damage the material of the wall or ceiling.
- When using a screw, provide a hole in the sponge at the bottom of the stand in advance.
- Request your authorized dealer or installation service provider to install the IR emitter securely while taking the necessary safety measures.
- SHARP will not be liable for any accident or damage due to improper installation, insufficient mounting strength, misuse, or natural disasters.

Enjoying 3D Image Viewing (Continued)

Precautions on viewing 3D images

- When viewing 3D images continuously, be sure to take a break periodically to prevent eye strain.
- Take regular breaks, at least 5 to 15 minutes after every 30 to 60 minutes of 3D viewing.
 - * Based on the guidelines issued by the 3D Consortium revised December 10, 2008.
- View 3D images at the appropriate distance from the screen. The recommended distance is three times the effective height of the picture. Examples of recommended distances
100-inch 16:9 picture: Approx. 12.3 ft (3.8 m)
Viewing should not be done closer than the recommended distance.
Refer to page 21 for details on the diagonal size and height of the picture.
- Maintain an appropriate distance from the screen. Viewing from too close a distance can strain your eyes. If you experience eye strain, immediately discontinue viewing. If you experience any of the following symptoms during viewing:
 - nausea
 - queasiness/dizziness
 - headache
 - blurry vision or double vision that lasts longer than few secondsDo not engage in any potentially hazardous activity (for example, driving a vehicle) until your symptoms have completely gone away.
If symptoms persist, discontinue use and do not resume 3D viewing without discussing your symptoms with a physician.
- Be careful of your surroundings when viewing 3D images. When you view 3D images, objects may appear at a distance closer or farther than the actual screen. This may cause you to misjudge the distance to the screen and possibly result in injury if you accidentally hit the screen or surrounding objects.

As you get more comfortable viewing 3D images:

- Operate the “3D Depth Adjust” function to adjust the 3D effect. (See page 70.)
- Adjust the projected image to the most comfortable viewing size by zooming. (Projecting images on the smallest or largest screen size possible may eliminate the 3D effect and strain your eyes.)
- Use the Invert function to properly set the video for your left and right eyes. (For details on using “Invert”, see page 70.)
- A picture simultaneously projected from more than two projectors may not appear 3D.

Info

- The projected image may become dark when using the 3D projection function (with “3D” set to “On”).
- When “3D” is set to “On”, the following functions may not work fully or may not be available at all.
 - GEOMETRIC ADJUSTMENT/H&V KEYSTONE/ SPHERE
 - V-Image Shift
 - CBNR
- If the power of your left and right eyes greatly differs and you primarily use one eye for viewing the images, the images will not appear in 3D. In addition, images may be difficult to view in 3D or images may not be able to be viewed in 3D depending on the individual or the content being displayed. The 3D effect varies with the individual.

WARNING

- The following people should limit stereoscopic 3D viewing:
 - Children under 6 years of age (to protect the eye growth process)
 - People with a history of photosensitivity
 - People with heart disease
 - People in poor health
 - People who are sleep deprived
 - People who are physically tired
 - People under the influence of drugs or alcohol

■ **Epilepsy**

A small percentage of the population may experience epileptic seizures when viewing certain types of images that contain flashing patterns of light.

IF YOU OR ANY MEMBER OF YOUR FAMILY HAS A HISTORY OF EPILEPSY

The following people should consult a physician before viewing stereoscopic 3D images.

- Anyone with a history of epilepsy, or who has a family member with a history of epilepsy
- Children under 6 years of age
- Anyone who has ever experienced epileptic seizures or sensory disturbances triggered by flashing light effects

SOME LIGHT PATTERNS MAY INDUCE SEIZURES IN PERSONS WITH NO PRIOR HISTORY OF EPILEPSY

Discontinue use if you experience any of the following symptoms while viewing stereoscopic 3D images.

- Involuntary movements, eye or muscle twitching
- Muscle cramps
- Nausea, dizziness, or queasiness
- Convulsions
- Disorientation, confusion, or loss of awareness of your surroundings

Enjoying 3D Image Viewing (Continued)

Supplied Accessories for the 3D Glasses

Make sure the following accessories are provided with the 3D Glasses. Two sets of 3D Glasses are provided.



3D Glasses (x2)
Pages [65](#), [66](#), [68](#) and [69](#)



3D Glasses band * (x2)
Page [66](#)



Nose pad * (Large x2, small x2)
Page [66](#)



Glasses case
(x2)



Cleaning cloth
(x2)



Precision screwdriver
(Phillips x2, slotted x2)
Page [65](#)

* Use the 3D Glasses band and nose pad as needed.



Note

- Please contact your local authority for the correct method of disposal of this product and/or packaging.

Part Names

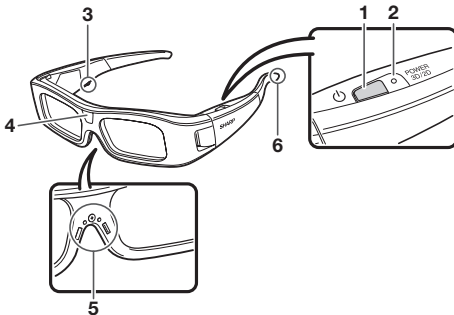

1 Power button

- Press for at least 2 seconds to turn on and off the 3D Glasses.
- When the 3D Glasses are turned on, pressing this button switches between 2D and 3D modes. (See page [66](#).)

2 LED light

- Blinks 3 times when the power is turned on.
- Blinks 2 times when 2D mode is selected.
- Blinks 3 times when 3D mode is selected.
- Blinks 6 times when the battery power is low.
- Lights for 2 seconds when the power is turned off.

3 Service terminal

This terminal is for service use only. Please do not connect any other device to this terminal.

4 Infrared receiver

Receives an infrared signal sent from the IR emitter. The 3D Glasses turn off automatically after 3 minutes if no signal is received.

5 Nose pad mount [66](#)

The dedicated nose pad can be mounted here.

6 3D Glasses band mount [66](#)

The dedicated 3D Glasses band can be mounted here.



Note

- Do not soil or apply stickers or other obstacles to the infrared receiver. Doing so may block signals from the IR emitter and prevent the 3D Glasses from working correctly.
- Interference from other infrared communication equipment may prevent you from viewing 3D images correctly.

Before Using the 3D Glasses

Before using the 3D Glasses for the first time, remove the insulating sheet attached to them.

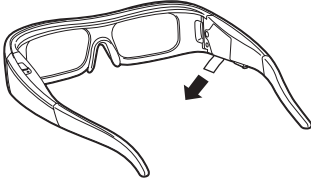

Replacing the Button Cell Battery

The battery has an expected service life of approximately 75 hours.

- When the battery power is low, the LED light blinks six times after the power is turned on.
- When replacing the button cell, use only the designated battery type (Maxell branded CR2032 lithium button battery).

- 1 Loosen the screw used to secure the battery cover, and then remove the battery cover.**

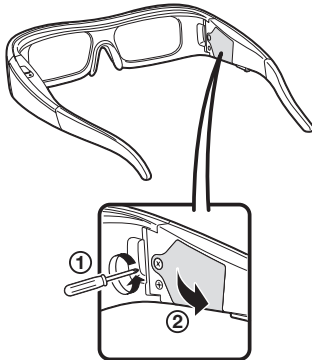

- 2 Remove the button cell battery.**

- ① Place the tip of the slotted precision screwdriver into the opening between the button cell and the socket.
- ② Lift up the button cell while taking care not to get the screwdriver caught on the metal latch.

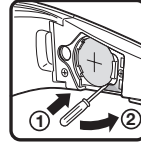

- 3 When the battery comes loose from the socket, pick it out with your fingers.**

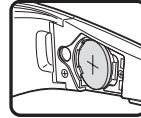

- 4 Hook a new button cell to the metal latch and insert it into the socket.**

- Take care not to reverse the battery polarity (+ and -) when inserting the button cell.

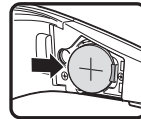

- 5 Close the battery cover.**

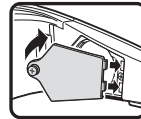

- 6 Insert the screw to secure the battery cover.**

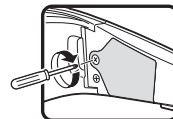

Note

- Used batteries should be disposed of in accordance with local laws and regulations.

Enjoying 3D Image Viewing (Continued)

Attaching the Nose Pad

Attach either of the supplied nose pads as needed (such as when the glasses do not fit properly). The glasses come with a large and small nose pad.

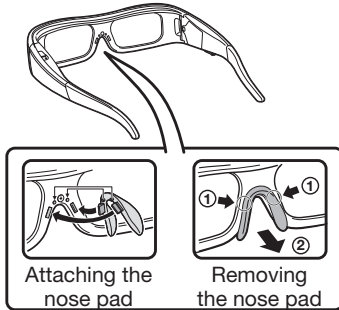

Attaching the 3D Glasses Band

Attach the supplied 3D Glasses band strap as needed (such as when the glasses do not fit properly). Insert the ends of the 3D Glasses into the 3D Glasses band until they are secure.

- Pull the cord stopper on the strap to adjust the strap length.

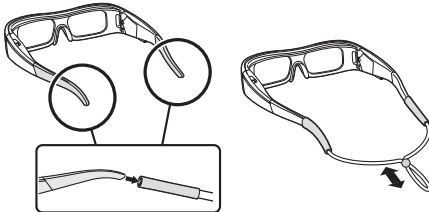

Using the 3D Glasses

Turning On/Off the Power

Turn on the power of the 3D Glasses.

- Press the power button for at least 2 seconds.
- The LED light blinks 3 times.

Turn off the power on the 3D Glasses.

- Press the power button for at least 2 seconds.
- The LED light lights for 2 seconds.

Note

- When the battery power is low, the LED light blinks 6 times after the power is turned on.

Switching to 3D and 2D Mode

When viewing 3D images, you can press the power button to switch between 2D and 3D modes. This is useful when several people are viewing the same 3D images with some people wanting to watch in 3D and some people wanting to watch in 2D.

Viewing 2D images

- When you press the power button twice while viewing 3D images, the LED light blinks 2 times and the 3D images switch to 2D images.

Viewing 3D images

- When you press the power button twice while viewing 2D images, the LED light blinks 3 times and the 2D images switch to 3D images.

Connecting the IR Emitter to the Projector

1 Install the IR emitter unit to the stand.

- Tilting the adjuster of the stand upward during installation makes the bottom of the IR emitter easier to see. In addition, the IR emitter can be more easily adjusted, enabling smooth installation.

2 Insert the IR emitter cable to the unit.

3 Connect the IR emitter and the projector.

4 Position the IR emitter.

- 3D images are intended to be viewed while facing the screen from the front. Position the IR emitter so that the 3D Glasses can easily receive the infrared signals while viewing the screen from the front.
- Do not install in a location where objects may obstruct the infrared signals between the IR emitter and 3D Glasses.
- Adjust the angle of the IR emitter to suit your viewing location.
- Make sure the vertical tilt angle is within 45°. Otherwise, the IR emitter may become unstable and tend to fall over easily.
- You can find some grooves on the adjuster of the stand. Setting the adjuster to the uppermost groove makes approximately 45°.

! Caution

Wall or ceiling mount setup

- Request your authorized dealer or installation service provider to install the IR emitter securely while taking the necessary safety measures.
- Use screws that suit the material and strength of the wall or ceiling. Otherwise, it may damage the material of the wall or ceiling.

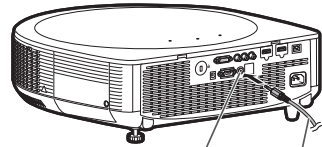
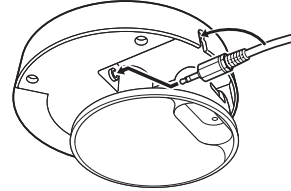
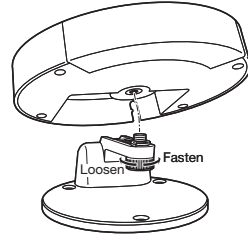

To 3D SYNCHRO terminal

IR emitter cable

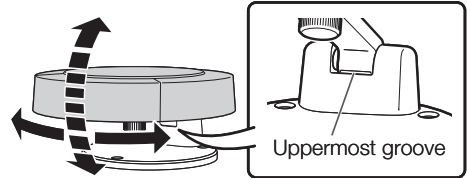
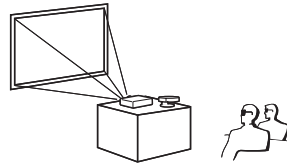

Note

- When you connect the IR emitter, make sure the power is turned off.
- The supplied IR emitter is exclusively designed for this projector. Do not connect it to other equipment.
- Also refer to "Precautions on installing the IR emitter" on page 61.

Enjoying 3D Image Viewing (Continued)

3D MENU button

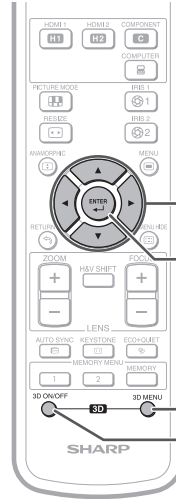
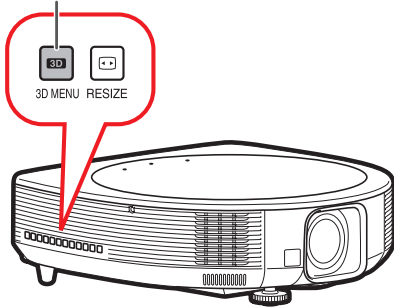

Adjustment buttons
(▲/▼/◀/▶)

ENTER button

3D MENU button

3D ON/OFF button

Note

- The screen may temporarily become black when the projector is trying to detect a 3D image signal and when switching from 3D to 2D mode.

Viewing 3D Images

Receiving a 3D Image Signal That Can Be Detected Automatically

The image signal may contain a 3D identification signal. You can enable the projector to automatically detect the 3D image type by selecting “3D MENU” > “3D Auto Change”. (See page 70.)

- 1 When “3D Auto Change” is set to “Yes”**
 - The 3D image type is detected automatically and the appropriate 3D image is displayed.

When “3D Auto Change” is set to “No”

- The following message is displayed. Press **3D ON/OFF**.

3D picture is detected.
Press the 3D ON/OFF button on the remote control.
(Need to wear the 3D glasses to watch 3D picture)

- 2 Turn on the 3D Glasses and place them over your eyes.**
 - Press the power button for at least 2 seconds.
 - The LED light blinks 3 times.

- 3 You can now view 3D images.**

Receiving a 3D Image Signal That Cannot Be Detected Automatically

- 1 Press 3D MENU.**
 - The 3D MENU screen is displayed.
- 2 Press ▲/▼ to select “3D”.**
- 3 Press ◀/▶ to select “On” or “Off”.**
 - To view in 3D mode: Select “On”, and then go to step 4.
 - Refer to “Setting the 3D Format Menu” on page 71 for supported 3D signals and formats.
 - If you select “Off”, the video source will be displayed with no conversion.
- 4 Press ▲/▼ to select “3D Format”, and then press ENTER.**
- 5 Press ▲/▼ to select a supported format from the list, and then press ENTER.**

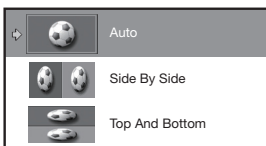

- If you select the same system as that of the input signal, 3D images are displayed.

- 6 Turn on the 3D Glasses and place them over your eyes.**
 - Press the power button for at least 2 seconds.
 - The LED light blinks 3 times.
- 7 You can now view 3D images.**

Ending 3D Image Viewing

- 1 Press 3D ON/OFF during the 3D mode.**
- 2 Take off the 3D Glasses and turn off the power.**
 - Press the power button for at least 2 seconds.
 - The LED light lights for 2 seconds.



Note

- If the input signal switches to 2D, 2D images are displayed automatically.
- 3D mode is canceled automatically in the following cases:
 - When the signal is no longer received
 - When the signal type changes
 - When input selection is changed
 - When the power is turned off

Enjoying 3D Image Viewing (Continued)

3D Settings ("3D MENU")

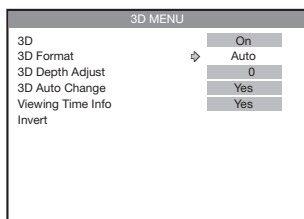

3D

You can switch between 2D and 3D mode.

Selectable items	Description
On	Projects 3D images.
Off	Projects 2D images instead of 3D images.

Note

- When "3D Auto Change" is set to "Yes" and a 3D signal is detected, "3D" switches to "On".
- When a 3D identification signal is not detected:
 - If you selected "On", select the format with "3D Format".
 - If you select "Off", the video source will be displayed with no conversion.

3D Format

You can set the 3D format manually for when a 3D signal that cannot be detected automatically is received.

Selectable items	Description
Auto	When a 3D identification signal is detected, the format is selected automatically.
Side By Side	Select the same format type of the received 3D signal.
Top And Bottom	

Note

- Refer to "Setting the 3D Format Menu" on page 71 for supported signals and 3D formats.

3D Depth Adjust

You can adjust the stereoscopic effect of 3D image.

◀ button	For less stereoscopic effect.
▶ button	For greater stereoscopic effect.

Note

- Use this function to get more comfortable 3D images.
- When you use this function, the 3D image will look different from its original 3D appearance. Keep this in mind while using this function.
- The use of this function for commercial purposes/public displays in a café, hotel, etc., may be an infringement of copyright protected by law for copyright holders. Please use caution.

3D Auto Change

This setting can be used to switch to 3D mode automatically when a 3D identification signal is detected.

Selectable items	Description
Yes	When a 3D signal is detected, 3D mode is selected automatically.
No	Auto change is not performed.

Viewing Time Info

This displays the elapsed time of 3D image viewing.

















Selectable items	Description
Yes	Displays the elapsed viewing time on the screen every hour.
No	Does not display the elapsed viewing time.

Invert

Pressing **ENTER** switches between the image for the left eye and the image for the right eye, so that you can make the settings for more natural viewing.

Setting the 3D Format Menu

Select the appropriate 3D format for viewing while referring to the table below.

Input signal				Support	When "3D" is OFF	When "3D" is ON		
						3D Format		
						Auto	Side By Side	Top And Bottom
Frame Packing 	with 3D identification signal	720P 50Hz	✓	Displays image for left eye (2D mode) 	Displays correct 3D image (3D mode) 	- *1	- *1	
		720P 60Hz	✓					
		1080I 50Hz						
		1080I 60Hz						
		1080P 24Hz	✓					
		1080P 50Hz						
1080P 60Hz								
Side By Side 	with 3D identification signal	720P 50Hz	✓	Displays image for left eye (2D mode) 	Displays correct 3D image (3D mode) 	- *1	- *1	
		720P 60Hz	✓					
		1080I 50Hz	✓					
		1080I 60Hz	✓					
		1080P 24Hz						
		1080P 50Hz	✓					
	1080P 60Hz	✓						
	without 3D identification signal	720P 50Hz	✓	Displays raw input signal 	Displays raw input signal 	Displays correct 3D image (3D mode) 	Garbled display (Incorrect setting) 	
		720P 60Hz	✓					
		1080I 50Hz	✓					
		1080I 60Hz	✓					
		1080P 24Hz						
1080P 50Hz		✓						
1080P 60Hz	✓							
Top And Bottom 	with 3D identification signal	720P 50Hz	✓	Displays image for left eye (2D mode) 	Displays correct 3D image (3D mode) 	- *1	- *1	
		720P 60Hz	✓					
		1080I 50Hz						
		1080I 60Hz						
		1080P 24Hz	✓					
		1080P 50Hz	✓					
	1080P 60Hz	✓						
	without 3D identification signal	720P 50Hz	✓	Displays raw input signal 	Displays raw input signal 	Garbled display (Incorrect setting) 	Displays correct 3D image (3D mode) 	
		720P 60Hz	✓					
		1080I 50Hz						
		1080I 60Hz						
		1080P 24Hz	✓					
1080P 50Hz		✓						
1080P 60Hz	✓							

*1 "3D Format" is set to "Auto" automatically.

*2 The frame rate is changed.

Enjoying 3D Image Viewing (Continued)

Note

- These 3D Glasses can only be used with Sharp 3D-compatible LCD TVs or projectors that use infrared control technology.

3D Glasses lenses

- Do not apply pressure to the lenses of the 3D Glasses. Also, do not drop or bend the 3D Glasses.
- Do not scratch the surface of the lenses of the 3D Glasses with a pointed instrument or other object. Doing so may damage the 3D Glasses and reduce the quality of the 3D image.
- Use only the cloth provided with the 3D Glasses to clean the lenses.

3D Glasses infrared receiver

- Do not allow the infrared receiver to become dirty, and do not attach stickers to or otherwise cover the infrared receiver. Doing so may prevent the receiver from operating normally.
- If the 3D Glasses are affected by other infrared data communication equipment, the 3D images may not be displayed correctly.

Caution during viewing

- Do not use devices that emit strong electromagnetic waves (such as cellular phones or wireless transceivers) near the 3D Glasses. Doing so may cause the 3D Glasses to malfunction.
- The 3D Glasses cannot operate fully at extreme high or low temperatures. Please use them within the specified usage temperature range.
- If the 3D Glasses are used in a room with fluorescent lighting (60 Hz), the light within the room may appear to flicker. In this case, either darken or turn off the fluorescent lights when using the 3D Glasses.
- Wear the 3D Glasses correctly. 3D images will not be correctly visible if the 3D Glasses are worn upside down or back-to-front.
- Other displays (such as computer screens, digital clocks, and calculators) may appear dark and difficult to view while wearing the 3D Glasses. Do not wear the 3D Glasses when watching anything other than 3D images.
- If you lie on your side while watching the screen with 3D Glasses, the picture may look dark or may not be visible.
- Be sure to stay within the viewing angle and optimum viewing distance when watching 3D images. Otherwise, you may not be able to enjoy the full 3D effect.
- The 3D Glasses may not work properly if there is any other 3D product or electronic devices turned on near the glasses or projector. If this occurs, turn off the other 3D product or electronic devices or keep the devices as far away as possible from the 3D Glasses.
- Stop using this product in any of the following situations:
 - When images consistently appear doubled while you are wearing the 3D Glasses
 - When you have difficulty perceiving the 3D effect
- If the 3D Glasses are faulty or damaged, stop using them immediately. Continued use of the 3D Glasses may cause eye fatigue, headaches and illness.
- If you have any abnormal skin reaction, stop using the 3D Glasses. In very rare instances, such reactions may be due to an allergic reaction to the coating or materials used.
- If your nose or temples become red or you experience any pain or itchiness, stop using the 3D Glasses. Pressure caused by long periods of use may lead to such reactions and may result in skin irritation.

Enjoying 3D Image Viewing (Continued)

Specifications – IR Emitter

Dimensions [W × H × D]	5 ³ / ₃₂ " × 2 ²⁷ / ₆₄ " × 5 ³ / ₃₂ " (129 × 61.5 × 129 mm)
Weight (approx.)	0.4 lbs. (180 g)

Dimensions

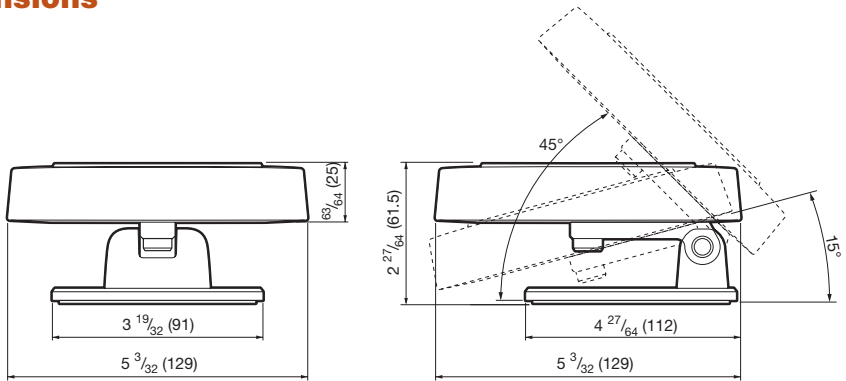

Effective Distance

The 3D Glasses can receive infrared signals sent from the IR emitter within the range indicated in the diagram.

Operating range (Distance from the IR emitter):
Approx. 33 ft (10 m)

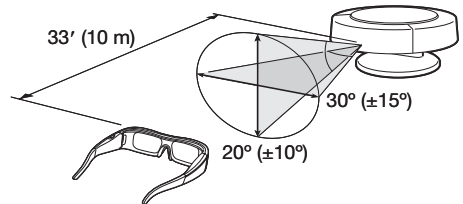

- Be sure to stay within the operating range when watching 3D images. Otherwise, the 3D Glasses may not work properly and you may not be able to enjoy the 3D images.
- The operating range described above is when the IR emitter is placed in front of the 3D Glasses. The operating range may vary depending on the position of the IR emitter and your viewing position. (The operating range decreases when you view the screen at an angle.)

Info

- Do not install the IR emitter with it directly facing the projector, as this may prevent the remote control of the projector from functioning properly.
- The IR emitter may interfere with other infrared communication equipment.
- Interference from other infrared communication equipment may prevent you from viewing 3D images correctly.
- 3D images are intended to be viewed while facing the screen from the front. Position the IR emitter so that the 3D Glasses can easily receive the infrared signals while viewing the screen from the front.

Maintenance

Cleaning the projector

- Ensure that you have unplugged the power cord before cleaning the projector.
- The cabinet as well as the operation panel is made of plastic. Avoid using benzene or thinner, as these can damage the finish on the cabinet.
- Do not use volatile agents such as insecticides on the projector. Do not attach rubber or plastic items to the projector for long periods. The effects of some of the agents in the plastic may cause damage to the quality or finish of the projector.
- Wipe off dirt gently with a soft flannel cloth. Using a chemical cloth (wet/dry sheet type cloth, etc.) may deform the components of the cabinet or cause cracking.
- Wiping with a hard cloth or using strong force may scratch the cabinet surface.
- When the dirt is hard to remove, soak a cloth in a mild detergent diluted with water, wring the cloth well and then wipe the projector. Strong cleaning detergents may discolor, warp or damage the coating on the projector. Make sure to test on a small, inconspicuous area on the projector before use.

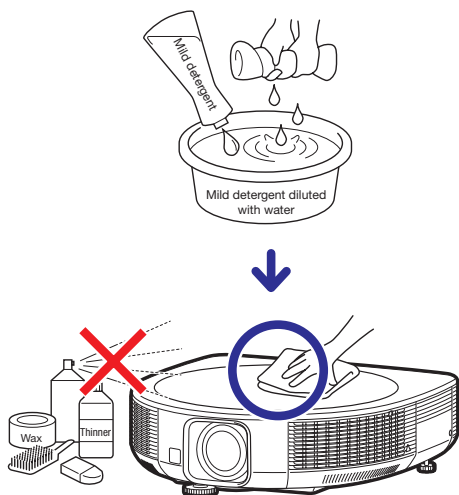

Cleaning the lens or lens cover

- Use a commercially available blower or lens cleaning paper (for glasses and camera lenses) for cleaning the lens or lens cover. Do not use any liquid type cleaning agents, as they may wear off the coating film on the surface of the lens or lens cover.
- As the surface of the lens or lens cover can easily get damaged, be careful not to scrape or hit the lens or lens cover.

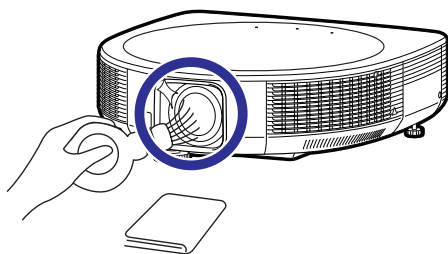

Cleaning the exhaust and intake vents

- Use a vacuum cleaner to clean dust from the exhaust vent and the intake vent.

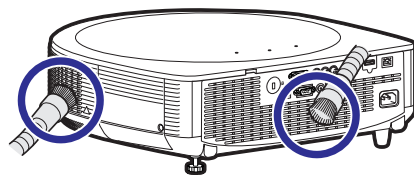

Info

- If you want to clean the air vents during projector operation, ensure you press **STANDBY/ON** on the projector or **STANDBY** on the remote control and put the projector into Standby mode. After the cooling fan has stopped, clean the vents.



Maintenance Indicators

- The warning lights (power indicator, lamp indicator and temperature warning indicator) on the projector indicate problems inside the projector.
- If a problem occurs, either the temperature warning indicator or the lamp indicator will illuminate red, and the projector will enter Standby mode. After the projector has entered Standby mode, follow the procedures given below.

Top View

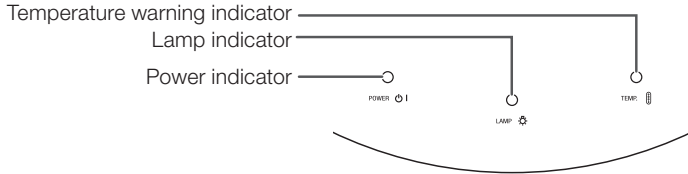

About the temperature warning indicator



If the temperature inside the projector increases, due to blockage of the air vents, or the setting location, the temperature warning indicator will blink. And if the temperature keeps on rising, "TEMP." will illuminate in the lower left corner of the picture with the temperature warning indicator blinking. If this state continues, the lamp will turn off, the cooling fan will run and then the projector will enter Standby mode. When you find the temperature warning indicator blinking, be sure to perform the measures described on page 77.

About the lamp indicator



- When the remaining lamp life becomes 5% or less, (yellow) and "Change The Lamp." will be displayed on the screen. When the percentage becomes 0%, it will change to (red), the lamp will automatically turn off and then the projector will automatically enter Standby mode. At this time, the lamp indicator will illuminate in red.
- **If you try to turn on the projector a fourth time without replacing the lamp, the projector will not turn on.**

Indicators on the Projector

Power indicator	Red on	Normal (Standby)
	Green on	Normal (Power on)
	Red blinks	Abnormal (See page 77.)
	Green blinks	Normal (Cooling)
Lamp indicator	Green on	Normal
	Green blinks	The lamp is warming up.
	Red on	The lamp is shut down abnormally or requires to be changed. (See page 77.)
Temperature warning indicator	Off	Normal
	Red on/Red blinks	The internal temperature is abnormally high. (See page 77.)

Maintenance indicator			Problem	Cause	Possible Solution
	Normal	Abnormal			
Temperature warning indicator	Off	Red blinks (On)/ Red on (Standby)	The internal temperature is abnormally high.	<ul style="list-style-type: none"> • Temperatures around the projector are high. • Blocked air intake 	<ul style="list-style-type: none"> • Use the projector in an area with a temperature of lower than 95°F (+35°C). • Relocate the projector to an area with proper ventilation. (See page 8.)
				<ul style="list-style-type: none"> • Cooling fan breakdown • Internal circuit failure • Clogged air intake 	
Lamp indicator	Green on (Green blinks when the lamp is warming up.)	Red on	The lamp does not illuminate.	<ul style="list-style-type: none"> • The lamp is shut down abnormally. 	<ul style="list-style-type: none"> • Disconnect the power cord from the AC outlet, and then connect it again. • Carefully replace the lamp. (See page 78.) • Take the projector to your nearest Sharp Authorized Projector Dealer or Service Center (see page 86) for repair. • Please exercise care when replacing the lamp. • Securely install the cover.
		Red on (Standby)	Time to change the lamp. The lamp does not illuminate.	<ul style="list-style-type: none"> • Remaining lamp life becomes 5% or less. • Burnt-out lamp • Lamp circuit failure 	
Power indicator	Green on/ Red on Green blinks (Cooling)	Red blinks	The power indicator blinks in red when the projector is on.	<ul style="list-style-type: none"> • The lamp unit cover is open. 	<ul style="list-style-type: none"> • If the power indicator blinks in red even when the lamp unit cover are securely installed, contact your nearest Sharp Authorized Projector Dealer or Service Center (see page 86) for advice.

Info

- If the temperature warning indicator illuminates, and the projector enters Standby mode, follow the possible solutions above and then wait until the projector has cooled down completely before plugging in the power cord and turning the power back on. (At least 10 minutes.)
- If the power is turned off for a brief moment due to power outage or some other cause while using the projector, and the power supply recovers immediately after that, the lamp indicator will illuminate in red and the lamp may not be lit. In this case, unplug the power cord from the AC outlet, replace the power cord in the AC outlet and then turn the power on again.
- The cooling fan keeps the internal temperature of the projector constant and this function is controlled automatically. The sound of the cooling fan may change during operation because the fan speed may change and this is not a malfunction.

Regarding the Lamp

Lamp

- It is recommended that the lamp (sold separately) be replaced when the remaining lamp life becomes 5% or less, or when you notice a significant deterioration in the picture and color quality. The lamp life (percentage) can be checked with the on-screen display. (See page 57.)
- Purchase a replacement lamp of type AN-K30LP from your place of purchase, nearest Sharp Authorized Projector Dealer or Service Center.

IMPORTANT NOTE TO U.S. CUSTOMERS:

The lamp included with this projector is backed by a 90-day parts and labor limited warranty. All service of this projector under warranty, including lamp replacement, must be obtained through a Sharp Authorized Projector Dealer or Service Center. For the name of the nearest Sharp Authorized Projector Dealer or Service Center, please call toll-free: 1-888-GO-SHARP (1-888-467-4277).

Hg LAMP CONTAINS MERCURY For State Lamp Disposal Information

www.lamprecycle.org or 1-800-BE-SHARP

U.S.A ONLY

Caution Concerning the Lamp

- This projector utilizes a pressurized mercury lamp. A loud sound may indicate lamp failure. Lamp failure can be attributed to numerous sources such as: excessive shock, improper cooling, surface scratches or deterioration of the lamp due to a lapse of usage time.
The period of time up to failure largely varies depending on the individual lamp and/or the condition and the frequency of use. It is important to note that failure can often result in the bulb cracking.
- When the lamp replacement indicator and on-screen display icon are illuminated, it is recommended that the lamp be replaced with a new one immediately, even if the lamp appears to be operating normally.
- Should the lamp break, there is also a possibility that glass particles may spread inside of the projector. In such a case, it is recommended you contact your nearest Sharp Authorized Projector Dealer or Service Center to assure safe operation.
- Should the lamp break, the glass particles may spread inside the lamp cage or gas contained in the lamp may be vented into the room from the exhaust vent. Because the gas in this lamp includes mercury, ventilate the room well if the lamp breaks and avoid all exposure to the released gas. In case of exposure to the gas, consult a doctor as soon as possible.

Replacing the Lamp



Caution

- Do not remove the lamp unit from the projector right after use. The lamp will be very hot and may cause burns or injury.
 - Wait at least one hour after the power cord is disconnected to allow the surface of the lamp unit to fully cool before removing the lamp unit.
 - **Carefully change the lamp by following the instructions described in this section.**
 - * **If you wish, you may have the lamp replaced at your nearest Sharp Authorized Projector Dealer or Service Center.**
- * If the new lamp does not light after replacement, take your projector to the nearest Sharp Authorized Projector Dealer or Service Center for repair.

Removing and Installing the Lamp Unit

Warning!

- Do not remove the lamp unit from the projector right after use. The lamp and parts around the lamp will be very hot and may cause burns or injury.

Info

- Do not touch the glass surface of the lamp unit or the inside of the projector.
- To avoid injury to yourself and damage to the lamp, make sure you carefully follow the steps below.
- Do not loosen other screws except for the lamp unit cover and lamp unit.

Optional
accessory

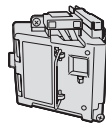

Lamp unit
AN-K30LP

- 1 Press **STANDBY/ON** on the projector or **STANDBY** on the remote control to put the projector into Standby mode.**

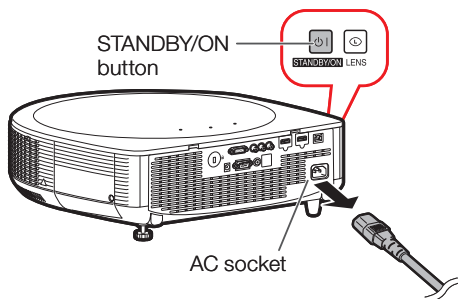

- 2 Disconnect the power cord.**
 - Unplug the power cord from the AC socket.
 - Leave the lamp until it has fully cooled down (about 1 hour).

- 3 Remove the lamp unit cover.**
 - Loosen the user service screw (1) that secures the lamp unit cover. Remove the lamp unit cover (2).

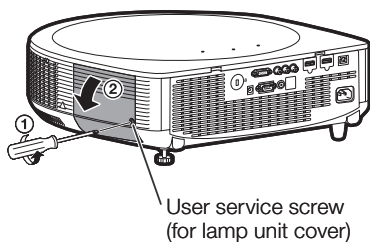

Regarding the Lamp (Continued)

4 Remove the lamp unit.

- Loosen the securing screws from the lamp unit. Hold the lamp unit by the handle and pull it in the direction of the arrow. At this time, keep the lamp unit horizontal and do not tilt it.

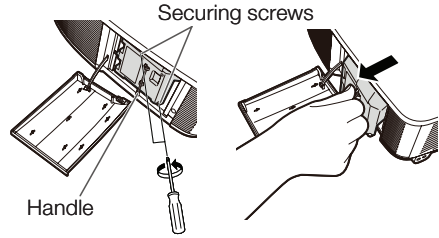

5 Insert the new lamp unit.

- Press the lamp unit firmly into the lamp unit compartment. Fasten the securing screw.

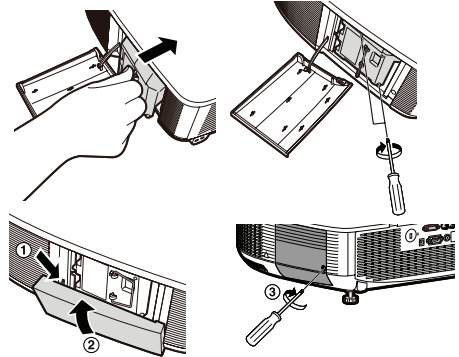

6 Replace the lamp unit cover.

- Align the tab on the lamp unit cover (1) and close it (2). Be careful not to get the strap caught in the cover. Then tighten the user service screw (3) to secure the lamp unit cover.

Info

- If the lamp unit and lamp unit cover are not correctly installed, the power will not turn on, even if the power cord is connected to the projector.

Resetting the Lamp Timer

Reset the lamp timer after replacing the lamp.

Info

- Make sure to reset the lamp timer only when replacing the lamp. If you reset the lamp timer and continue to use the same lamp, this may cause the lamp to become damaged or explode.

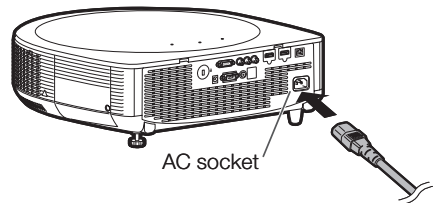

1 Connect the power cord.

- Plug the power cord into the AC socket of the projector.

2 Reset the lamp timer.

- While simultaneously holding down **MENU**, **ENTER** and **▼** on the projector, press **STANDBY/ON** on the projector and keep all four buttons pressed down until the lamp indicator starts blinking green.
- "LAMP 0000H" is displayed, indicating that the lamp timer is reset.

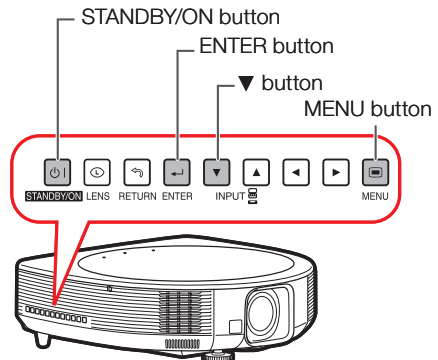

Compatibility Chart

Computer

- Multiple signal support
Horizontal Frequency: 15–110 kHz, Vertical Frequency: 43–85 Hz, Pixel Clock: 12–170 MHz
- Compatible with sync on green and composite sync signals (TTL level)

PC/MAC	Mode	Resolution	Horizontal Frequency [kHz]	Vertical Frequency [Hz]	Analog Support	Digital Support	Display	
PC	VGA	640 × 400	27.0	60	✓		Upscale	
			31.5	70	✓			
			37.9	85	✓			
		720 × 400	27.0	60	✓			
			31.5	70	✓	✓		
			37.9	85	✓			✓
		640 × 480	26.2	50	✓			
			31.5	60	✓			✓
			34.7	70	✓			✓
			37.9	72	✓			✓
			37.5	75	✓			✓
			43.3	85	✓			
	31.3		50	✓				
	35.2		56	✓		✓		
	37.9		60	✓		✓		
	SVGA	800 × 600	46.6	70	✓			
			48.1	72	✓			✓
			46.9	75	✓			✓
			53.7	85	✓			
			40.3	50	✓			
			48.4	60	✓			✓
			56.5	70	✓			✓
			60.0	75	✓			✓
			68.7	85	✓			
	WXGA	1280 × 720	45.0	60	✓			✓
			47.8	60	✓			
			49.7	60	✓			
			47.7	60	✓			
			47.8	60	✓			
			47.8	60	✓			
	WXGA+	1440 × 900	55.9	60	✓			
			55.0	60	✓			✓
	SXGA	1152 × 864	66.2	70	✓			
67.5			75	✓		✓		
60.0			60	✓		✓		
64.0			60	✓		✓		
SXGA+	1400 × 1050	64.0	60	✓		✓		
		65.3	60	✓		✓		
		65.3	60	✓		✓		
WSXGA+	1600 × 900	55.9	60	✓		✓		
		1680 × 1050	65.3	60	✓			
		1920 × 1080 ^{*1}	66.8	60	✓			
		1920 × 1080 ^{*2}	67.5	60	✓		✓	
MAC 13"	VGA	640 × 480	34.9	67	✓		Upscale	
MAC 16"	SVGA	832 × 624	49.7	75	✓			
MAC 19"	XGA	1024 × 768	60.2	75	✓			
MAC 21"	SXGA	1152 × 870	68.7	75	✓			

*1 When a 1920 × 1080 analog signal is input, the image is compressed before it is displayed on the screen.

*2 Full image display when "Resolution" is set to "1920 × 1080"

Note

- This projector may not be able to display images from notebook computers in simultaneous (CRT/LCD) mode. Should this occur, turn off the LCD display on the notebook computer and output the display data in "CRT only" mode. Details on how to change display modes can be found in your notebook computer's operation manual.
- When "Screen resolution" of the computer is different from the resolution displayed on the projected image, follow the procedures shown below.
 - Refer to "Resolution" on the "SIG-ADJ" menu and select the same resolution as the resolution in "Screen resolution" of the computer.
 - Depending on the computer you are using, the output signal may not be faithful to the "Screen resolution" adjustment. Check the settings of the computer's signal output. If the settings cannot be changed, it is recommended that the resolution be set to "1920 × 1080" or "1280 × 720".



Compatibility Chart (Continued)



DTV

Signal	Horizontal Frequency (kHz)	Vertical Frequency (Hz)	Analog Support	Digital Support	Signal	Horizontal Frequency (kHz)	Vertical Frequency (Hz)	Analog Support	Digital Support
480I	15.7	60	✓		1080I	28.1	50	✓	✓
480P	31.5	60	✓	✓	1080I	33.8	60	✓	✓
540P	33.8	60	✓		1080P	27.0	24		✓
576I	15.6	50	✓		1080P	28.1	25		✓
576P	31.3	50	✓	✓	1080P	33.8	30		✓
720P	37.5	50	✓	✓	1080P	56.3	50	✓	✓
720P	45.0	60	✓	✓	1080P	67.5	60	✓	✓

3D

Format	Signal	Horizontal Frequency (kHz)	Vertical Frequency (Hz)	Analog Support	Digital Support
Frame Packing	720P	75.0	50		✓
	720P	90.0	60		✓
	1080P	54.0	24		✓
Side By Side	720P	37.5	50		✓
	720P	45.0	60		✓
	1080I	28.1	50		✓
	1080I	33.8	60		✓
	1080P	56.3	50		✓
	1080P	67.5	60		✓
Top And Bottom	720P	37.5	50		✓
	720P	45.0	60		✓
	1080P	27.0	24		✓
	1080P	56.3	50		✓
	1080P	67.5	60		✓

Troubleshooting

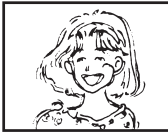
Problem	Check	Page
 <p>No picture or projector does not start.</p>	<ul style="list-style-type: none"> • Projector power cord is not plugged into the wall outlet. 	27
	<ul style="list-style-type: none"> • Power to the external connected devices is off. 	–
	<ul style="list-style-type: none"> • The selected input mode is wrong. 	35
	<ul style="list-style-type: none"> • Cables are incorrectly connected to the projector. 	23-27
	<ul style="list-style-type: none"> • Remote control battery has run out. 	16
	<ul style="list-style-type: none"> • External output has not been set when connecting notebook computer. 	–
	<ul style="list-style-type: none"> • The lamp unit cover is not installed correctly. 	79, 80
	<ul style="list-style-type: none"> • The selected “Signal Type” is wrong. 	50
	<ul style="list-style-type: none"> • “Bright” is set to minimum position. 	45
 <p>Color is faded or poor.</p>	<ul style="list-style-type: none"> • Image adjustments are incorrectly set. 	45
	(COMPONENT, COMPUTER/COMPONENT or HDMI1, 2 input) <ul style="list-style-type: none"> • Input signal type is incorrectly set. 	50
 <p>Picture is blurred; noise appears.</p>	<ul style="list-style-type: none"> • Adjust the focus. 	30
	<ul style="list-style-type: none"> • The projection distance exceeds the focus range. 	21
	(Computer input) <ul style="list-style-type: none"> • Perform “SIG-ADJ” Adjustments (“Clock” and “Phase” Adjustment) • Noise may appear depending on the computer. 	49 –
	<ul style="list-style-type: none"> • The “DNR” (Digital Noise Reduction) or “MNR” (Mosquito Noise Reduction) setting is not correct. 	48
	<ul style="list-style-type: none"> • There is fog on the lens. If the projector is carried from a cold room into a warm room, or if it is suddenly heated, condensation may form on the surface of the lens and the image will become blurred. Please set up the projector at least one hour before it is to be used. If condensation should form, remove the power cord from the wall outlet and wait for it to clear. 	–
An unusual sound is occasionally heard from the cabinet.	<ul style="list-style-type: none"> • If the picture is normal, the sound is due to cabinet shrinkage caused by a room temperature changes. This will not affect operation or performance. 	–
Maintenance indicator on the projector illuminates.	<ul style="list-style-type: none"> • See “Maintenance Indicators”. 	76
Picture is green when receiving YPbPr signals and the video equipment is connected to the Component (YP _B (C _B)P _R (C _R)) or COMPUTER/COMPONENT terminal on the projector.	<ul style="list-style-type: none"> • Change the input signal type setting. 	50
Picture is pink when receiving RGB signals and the video equipment is connected to the Component (YP _B (C _B)P _R (C _R)) or COMPUTER/COMPONENT terminal on the projector.		

Troubleshooting (Continued)

Problem	Check	Page
The black levels of the image show banding or appear faded when HDMI1 or 2 is selected.	<ul style="list-style-type: none"> Make adjustments that result in the best picture quality in the “Dynamic Range” setting. 	50
Picture is too bright and whitish.	<ul style="list-style-type: none"> Image adjustments are incorrectly set. 	45
The lens shift function does not work.	<ul style="list-style-type: none"> The lens cover is not attached correctly. 	13
The cooling fan becomes noisy.	<ul style="list-style-type: none"> When temperature inside the projector increases, the cooling fan runs faster. 	–
The lamp does not light up even after the projector turns on.	<ul style="list-style-type: none"> The lamp indicator is illuminating in red. Replace the lamp. 	28, 76, 79
The lamp suddenly turns off during projection.		
The image sometimes flickers.	<ul style="list-style-type: none"> Cables are incorrectly connected to the projector or the connected equipment works improperly. If this happens frequently, replace the lamp. 	23-27 79
The lamp needs much time to turn on.	<ul style="list-style-type: none"> The lamp will eventually need to be changed. While the remaining lamp life draws to a close, replace the lamp. 	79
Picture is dark.		
One Touch Play is not enabled.	<ul style="list-style-type: none"> Non-Sharp Video Products are connected. One Touch Play function may not work when the projector is connected to non-Sharp Video Products. 	55
	<ul style="list-style-type: none"> An HDMI cable is not used for connection between the projector and the Sharp Video Products. One Touch Play function is enabled when the projector is connected to the Sharp Video Products with an HDMI cable. 	24
	<ul style="list-style-type: none"> One Touch Play function of the projector is not set to “On”. 	55
	<ul style="list-style-type: none"> CEC settings of connected Sharp Video Products or other CEC devices are incorrect. 	–
	<ul style="list-style-type: none"> One Touch Play is set to “Off” and disabled when the Economy mode is set to “On”. 	54, 55
System Standby is not enabled.	<ul style="list-style-type: none"> Non-Sharp Video Products are connected. System Standby function may not work when the projector is connected to non-Sharp Video Products. 	55
	<ul style="list-style-type: none"> An HDMI cable is not used for connection between the projector and the Sharp Video Products. System Standby function is enabled when the projector is connected to the Sharp Video Products with an HDMI cable. 	24
	<ul style="list-style-type: none"> System Standby function of the projector is not set to “On”. 	55
	<ul style="list-style-type: none"> CEC settings of connected Sharp Video Products or other CEC devices are incorrect. 	–
The remote control cannot be used.	<ul style="list-style-type: none"> Operate the remote control while pointing it at the projector’s remote control sensor. The remote control may be too far away from the projector. If direct sunlight or a strong fluorescent light is shining on the projector’s remote control sensor, place the projector where it will not be affected by strong light. 	17 17 17
	<ul style="list-style-type: none"> The batteries may be depleted or inserted incorrectly. Make sure the batteries are inserted correctly or insert new ones. 	16

Problem	Check	Page
3D images are not displayed.	• Switch to 3D mode.	68-70
	• Is "3D Auto Change" set to "No"? Press 3D ON/OFF to switch to 3D mode.	70
	• If "3D Auto Change" is set to "Yes" but no 3D images are displayed, check the display format of the content being viewed. Some 3D image signals may not be recognized as 3D images automatically. Press 3D MENU to select the appropriate display format for the 3D image.	70, 71
	• The IR emitter is not correctly connected to the projector.	67
	• Make sure that the IR emitter is located within the proper operating range.	67
	• The 3D Glasses are not turned on.	66
	• The 3D Glasses are set to 2D mode.	66
	• The 3D Glasses operate by receiving the infrared signal from the IR emitter. Do not place anything between the IR emitter and the infrared receiver on the 3D Glasses.	74
3D Images flicker when watching in a room.	• Images may appear to flicker when fluorescent light or ambient light enters your vision. -Turn off the lights. -Block any ambient light.	-
Ghosting (a double image) occurs without the image appearing in 3D.	• Use "Invert" to change the setting.	70
	• A signal that does not support 3D is being received. Check whether a signal that supports 3D is being received.	82
	• If the projector is connected to a computer for 3D image playback, check that a stereoscopically-enabled application is being used. - Use the applicable software. - Configure your 3D application at the correct 3D format, resolution and refresh rate. To support 3D, your 3D application must be configured to run at the correct settings for this projector.	-
	• If there is strong ambient light, block the light. High intensity lighting can interfere with communication between the 3D Glasses and the screen, resulting in some flicker.	-
	• A picture simultaneously projected from more than two projectors may not appear 3D. Use only one projector at a time.	-
The projected image is dark.	• When a 3D image is projected, the screen may appear darker than normal.	-
The 3D Glasses turn off automatically.	• Is there an obstacle between the 3D Glasses and the IR emitter, or is something covering the infrared receiver on the 3D Glasses? The 3D Glasses turn off automatically after 3 minutes if no signal is received. Do not place anything between the IR emitter and the infrared receiver on the 3D Glasses.	-
Pressing the power button on the 3D Glasses does not cause the LED light to light.	• The battery in the 3D Glasses is exhausted. If the LED light does not light after pressing the power button for more than one second, the battery is exhausted. Replace the battery.	65

This unit is equipped with a microprocessor. Its performance could be adversely affected by incorrect operation or interference. If this should happen, unplug the unit and plug it in again after more than 5 minutes.

For SHARP Assistance

If you encounter any problems during setup or operation of this projector, first refer to the “Troubleshooting” section on pages 83 to 85. If this operation manual does not answer your question, please contact the SHARP Service departments listed below.

U.S.A.	Sharp Electronics Corporation 1-888-GO-SHARP (1-888-467-4277) lcdsupport@sharpsec.com http://www.sharpsusa.com	Benelux	SHARP Electronics Benelux BV 0900-SHARPCE (0900-7427723) Nederland 9900-0159 Belgium http://www.sharp.nl http://www.sharp.be http://www.sharp.lu
Canada	Sharp Electronics of Canada Ltd. (905) 568-7140 http://www.sharp.ca	Australia	Sharp Corporation of Australia Pty. Ltd. 1300-135-022 http://www.sharp.net.au
Mexico	Sharp Electronics Corporation Mexico Branch (525) 716-9000 http://www.sharp.com.mx	New Zealand	Sharp Corporation of New Zealand Phone: (09) 573-0111 Fax: (09) 573-0112 http://www.sharp.net.nz
Latin America	Sharp Electronics Corp. Latin American Group (305) 264-2277 www.servicio@sharpsec.com http://www.sharpla.com	Singapore	Sharp-Roxy Sales (S) Pte. Ltd. 65-226-6556 ckng@srs.global.sharp.co.jp http://www.sharp.com.sg
Germany	Sharp Electronics (Europe) GMBH 01805-234675 http://www.sharp.de	Hong Kong	Sharp-Roxy (HK) Ltd. (852) 2410-2623 dcmktg@srh.global.sharp.co.jp http://www.sharp.com.hk
U.K.	Sharp Electronics (U.K.) Ltd. 08705 274277 http://www.sharp.co.uk/customersupport	Taiwan	Sharp Corporation (Taiwan) 0800-025111 http://www.sharp-scot.com.tw
Italy	Sharp Electronics (Italy) S.P.A. (39) 02-89595-1 http://www.sharp.it	Malaysia	Sharp-Roxy Sales & Service Co. (60) 3-5125678
France	Sharp Electronics France 01 49 90 35 40 hotlinecd@sef.sharp-eu.com http://www.sharp.fr	U.A.E.	Sharp Middle East Fze 971-4-81-5311 helpdesk@smef.global.sharp.co.jp
Spain	Sharp Electronica Espana, S.A. 93 5819700 sharpdcd@sees.sharp-eu.com http://www.sharp.es	Thailand	Sharp Thebnakorn Co. Ltd. 02-236-0170 svc@stcl.global.sharp.co.jp http://www.sharp-th.com
Switzerland	Sharp Electronics (Schweiz) AG 0041 1 846 63 11 cattaneo@sez.sharp-eu.com http://www.sharp.ch	Korea	Sharp Electronics Incorporated of Korea (82) 2-3660-2002 lcd@sharp-korea.co.kr http://www.sharpkorea.co.kr
Sweden	Sharp Electronics (Nordic) AB (46) 8 6343600 vision.support@sen.sharp-eu.com http://www.sharp.se	India	Sharp Business Systems (India) Limited (91) 11- 6431313 service@sharp-oa.com
Austria	Sharp Electronics (Europe) GMBH Branch Office Austria 0043 1 727 19 123 pogats@sea.sharp-eu.com http://www.sharp.at		

Specifications

Model		XV-Z30000	
Display devices		0.65" DLP® Chip ×1	
Resolution		1080P (1920 × 1080)	
Lens	F number	F 2.5 – 3.7	
	Zoom	Power, ×2.0 (f = 21.2 – 42.0 mm)	
	Focus	Power	
Input terminals	HDMI	×2	
	Computer/Component (mini D-sub 15 pin)	×1	
	Component (3RCA)	×1 (Y, P _B (C _B), P _R (C _R))	
Output terminals	TRIGGER	×1 (Power jack DC 12V output)	
	3D SYNCHRO	×1	
Control and communication terminals	LAN (RJ-45)	×1	
	RS-232C (mini DIN 9 pin)	×1	
Projection lamp		250 W	
Rated voltage		AC 100 – 240 V	
Rated frequency		50/60 Hz	
Input current		3.5 A	
Power consumption (Eco + Quiet)	Off	AC 100 V	348 W
		AC 240 V	328 W
	On	AC 100 V	242 W
		AC 240 V	232 W
Power consumption (Economy Mode)	Off	AC 100 V	8.1 W
		AC 240 V	8.8 W
	On	AC 100 V	0.3 W
		AC 240 V	0.7 W
Operation temperature		41°F to 95°F (+5°C to +35°C)	
Cabinet		Plastic	
Dimensions (main body only) [W × H × D]		15 ⁶¹ / ₆₄ " × 4 ³³ / ₆₄ " × 16" (405 × 114.5 × 406.5 mm)	
Weight (approx.)		16.1 lbs. (7.3 kg)	

As a part of policy of continuous improvement, SHARP reserves the right to make design and specification changes for product improvement without prior notice. The performance specification figures indicated are nominal values of production units. There may be some deviations from these values in individual units.

This SHARP projector uses a DLP® chip. This very sophisticated panel contains 2,073,600 pixels (micromirrors). As with any high technology electronic equipment such as large screen TVs, video systems and video cameras, there are certain acceptable tolerances that the equipment must conform to.

This unit has some inactive pixels within acceptable tolerances which may result in inactive dots on the picture screen. This will not affect the picture quality or the life expectancy of the unit.



Dimensions

Units: inches (mm)

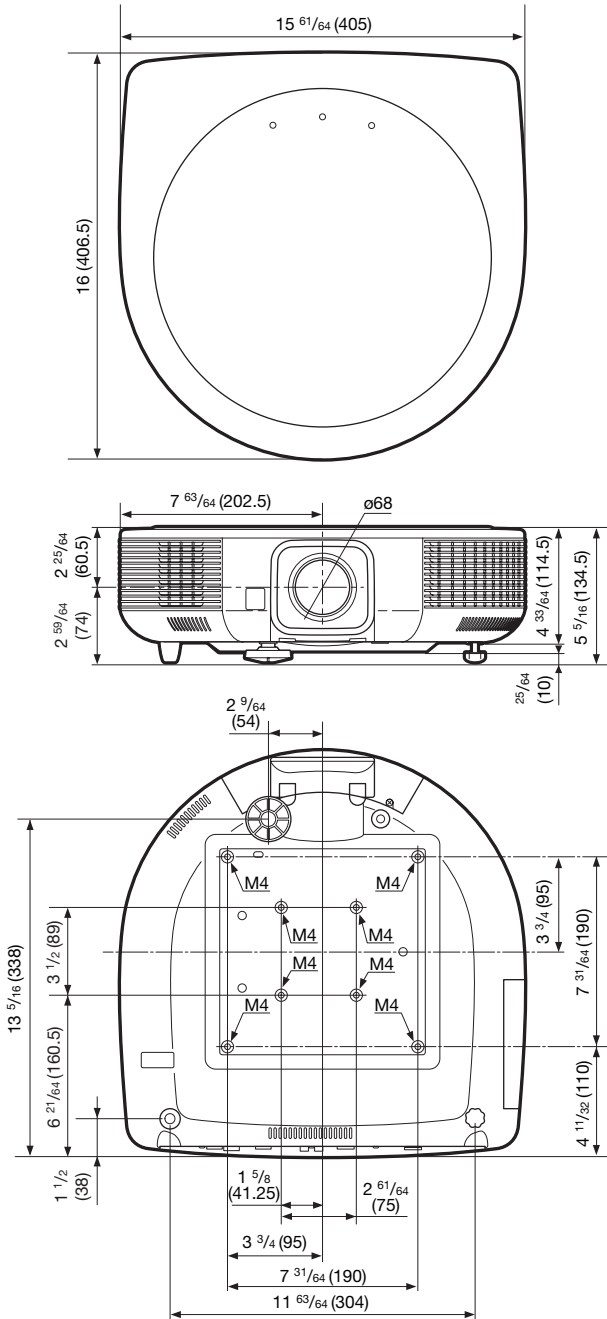

Index

16:9	36	Lamp indicator	76
3D Auto Change	70	Lamp Timer (Life)	57
3D Depth Adjust	70	Language (on-screen display language)	53
3D Format	70	LAN terminal	27
3D Glasses	64-66	LED	56
3D MENU	70	LENS button	13
3D MENU button	69, 70	MAC address	60
3D ON/OFF button	68, 69	MEMORY 1, 2 buttons	56
3D SYNCHRO terminal	67	MEMORY button	56
Accessories	12	Memory Menu	56
AC socket	27	MENU button	42
Adjustment buttons	42	MENU HIDE button	38
Adjustment foot	30	Menu Position	53
Advanced	45	MNR	48
All Reset	57	NATIVE	36
Anamorphic	51	Network	58
ANAMORPHIC button	15	No Operation Off	54
Auto Power Off	54	ON button	28
Auto Sync	49	One Touch Play	55
AUTO SYNC button	38	Optional accessories	12
Background	52	OSD Brightness	52
Batteries	16	OSD Display	52
Black Mask	52	Overscan	52
Bright	45	Password	58
Bright Boost	48	PDF	11
BRIGHTNESS button	37	Phase	49
CBNR	52	Picture	44
CINEMA ZOOM	36	Picture Mode	44
Clock	49	PICTURE MODE button	37
CLR Temp (Color Temperature)	45	Power cord	12, 27
C.M.S.	46	Power indicator	28, 76
Color	45	PRJ-ADJ	54
COLOR button	37	PRJ mode	22, 53
Color Enhance	48	Remote control	15
COMPONENT button	35	Remote control sensors	17
Component (YPb(Cb)Pr(Cr)) terminals	23	Replacing the lamp	78
COMPUTER button	35	Reset Network Setting	59
COMPUTER/COMPONENT terminal	23, 25	RESIZE button	36
Contrast	45	Restart Network	59
CONTRAST button	37	RETURN button	42
Custom Gamma	46	RS-232C terminal	26
Detail Enhance	48	SCR-ADJ	51
DHCP Client	59	Screen Size and Projection Distance	21
DNR	48	Sharp	45
Dynamic Range	50	SIG-ADJ	49
Economy Mode	54	Signal Info	50
ECO+QUIET button	38	Signal Type	50
ENTER button	42	SMART ZOOM	36
Exhaust vent	13, 14, 75	SPHERE	34
Fan Mode	56	STANDBY button	28
Film Mode	48	STANDBY/ON button	28
FOCUS buttons	30	System Standby	55
Gamma	45	TCP/IP	59
GEOMETRIC ADJUSTMENT	32	Temperature warning indicator	76
H&V KEYSTONE	33	Tint	45
H&V SHIFT button	29	TINT button	37
HDMI1, 2 buttons	35	Trigger	51
HDMI1, 2 terminals	23, 24	TRIGGER terminal	14
H-Pos	49	Video Setup	50
INPUT modes	35	Viewing Time Info	70
Input Name	55	V-Image Shift	51
Intake vent	14, 75	V-Pos	49
Invert	70	ZOOM 14:9	36
IP address	60	ZOOM buttons	30
IR emitter	67		
IRIS1, 2	45		
IRIS1, 2 buttons	38		
Kensington Security Standard connector	14		
KEYSTONE button	31		
Keystone Correction	31		

SHARP[®]
SHARP CORPORATION