

Panasonic®

Operating Instructions

Functional Manual

LCD Projector Commercial Use

Model No. PT-VW435NEA
PT-VX505NEA

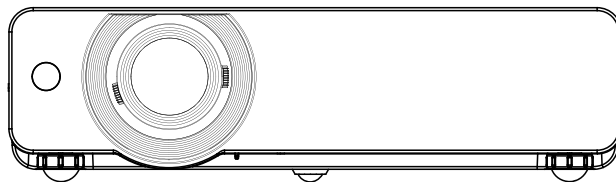

Thank you for purchasing this Panasonic Product.

- Before operating this product, please read the instructions carefully, and save this manual for future use.
- Before using your projector, be sure to read "Read this first!" (➡ pages 2 to 10).

Read this first!

WARNING: THIS APPARATUS MUST BE EARTHED.

WARNING: To prevent damage which may result in fire or shock hazard, do not expose this appliance to rain or moisture.

Machine Noise Information Ordinance 3. GSGV, January 18, 1991: The sound pressure level at the operator position is equal or less than 70 dB (A) according to ISO 7779.

WARNING:

1. Remove the plug from the mains socket when this unit is not in use for a prolonged period of time.
2. To prevent electric shock, do not remove cover. No user serviceable parts inside. Refer servicing to qualified service personnel.
3. Do not remove the earthing pin on the mains plug. This apparatus is equipped with a three prong earthing type mains plug. This plug will only fit an earthing-type mains socket. This is a safety feature. If you are unable to insert the plug into the mains socket, contact an electrician. Do not defeat the purpose of the earthing plug.

CAUTION: To assure continued compliance, follow the attached installation instructions, which includes using the provided power cord and shielded interface cables when connecting to computer or peripheral device. If you use serial port to connect PC for external control of projector, you must use optional RS-232C serial interface cable with ferrite core. Any unauthorized changes or modifications to this equipment will void the user's authority to operate.



WARNING: TURN OFF THE UV LAMP BEFORE OPENING THE LAMP COVER.

WARNING: TO REDUCE THE RISK OF FIRE OR ELECTRIC SHOCK, DO NOT EXPOSE THIS PRODUCT TO RAIN OR MOISTURE.

WARNING: RISK OF ELECTRIC SHOCK, DO NOT OPEN.



The lightning flash with arrowhead symbol, within an equilateral triangle, is intended to alert the user to the presence of uninsulated "dangerous voltage" within the product's enclosure that may be of sufficient magnitude to constitute a risk of electric shock to persons.



The exclamation point within an equilateral triangle is intended to alert the user to the presence of important operating and maintenance (servicing) instructions in the literature accompanying the product.

IMPORTANT: THE MOULDED PLUG (U.K. only)

FOR YOUR SAFETY, PLEASE READ THE FOLLOWING TEXT CAREFULLY.

This appliance is supplied with a moulded three pin mains plug for your safety and convenience. A 13 amp fuse is fitted in this plug. Should the fuse need to be replaced, please ensure that the replacement fuse has a rating of 13 amps and that it is approved by ASTA or BSI to BS1362.

Check for the ASTA mark  or the BSI mark  on the body of the fuse.

If the plug contains a removable fuse cover, you must ensure that it is refitted when the fuse is replaced. If you lose the fuse cover, the plug must not be used until a replacement cover is obtained. A replacement fuse cover can be purchased from an Authorised Service Center.

If the fitted moulded plug is unsuitable for the mains socket in your home, then the fuse should be removed and the plug cut off and disposed of safely. There is a danger of severe electrical shock if the cut off plug is inserted into any 13 amp socket.

If a new plug is to be fitted, please observe the wiring code as shown below.
If in any doubt, please consult a qualified electrician.

WARNING: THIS APPLIANCE MUST BE EARTHED.

IMPORTANT: The wires in this mains lead are coloured in accordance with the following code:

Green - and - Yellow:	Earth
Blue:	Neutral
Brown:	Live

As the colours of the wire in the mains lead of this appliance may not correspond with the coloured markings identifying the terminals in your plug, proceed as follows.

The wire which is coloured GREEN - AND - YELLOW must be connected to the terminal in the plug which is marked with the letter E or by the Earth symbol  or coloured GREEN or GREEN - AND - YELLOW.

The wire which is coloured BLUE must be connected to the terminal in the plug which is marked with the letter N or coloured BLACK.

The wire which is coloured BROWN must be connected to the terminal in the plug which is marked with the letter L or coloured RED.

How to replace the fuse: Open the fuse compartment with a screwdriver and replace the fuse.

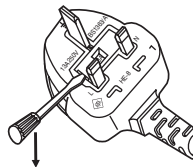

Read this first!

WARNING:

■ POWER

The wall outlet or the circuit breaker shall be installed near the equipment and shall be easily accessible when problems occur. If the following problems occur, cut off the power supply immediately.

Continued use of the projector in these conditions will result in fire or electric shock.

- If foreign objects or water get inside the projector, cut off the power supply.
- If the projector is dropped or the cabinet is broken, cut off the power supply.
- If you notice smoke, strange smells or noise coming from the projector, cut off the power supply.

Please contact an Authorized Service Center for repairs, and do not attempt to repair the projector yourself.

During a thunderstorm, do not touch the projector or the cable.

Electric shocks can result.

Do not do anything that might damage the power cord or the power plug.

If the power cord is used while damaged, electric shocks, short-circuits or fire will result.

- Do not damage the power cord, make any modifications to it, place it near any hot objects, bend it excessively, twist it, pull it, place heavy objects on top of it or wrap it into a bundle.

Ask an Authorized Service Center to carry out any repairs to the power cord that might be necessary.

Insert the power plug securely into the wall outlet.

If the plug is not inserted correctly, electric shocks or overheating will result.

- Do not use anything other than the provided power cord.
- Do not use the provided power cord for other electrical equipment.
- Do not use plugs which are damaged or wall outlets which are coming loose from the wall.

Clean the power plug regularly to prevent it from becoming covered in dust.

Failure to observe this will cause a fire.

- If dust builds up on the power plug, the resulting humidity can damage the insulation.
- If not using the projector for an extended period of time, pull the power plug out from the wall outlet.

Pull the power plug out from the wall outlet and wipe it with a dry cloth regularly.

Do not handle the power plug with wet hands.

Failure to observe this will result in electric shocks.

Do not overload the wall outlet.

If the power supply is overloaded (ex., by using too many adapters), overheating may occur and fire will result.

■ ON USE/INSTALLATION

Do not place liquid containers on top of the projector.

If water spills onto the projector or gets inside it, fire or electric shocks will result.

If any water gets inside the projector, contact an Authorized Service Center.

Do not place the projector on soft materials such as carpets or sponge mats.

Doing so will cause the projector to overheat, which can cause burns, fire or damage to the projector.

Do not set up the projector in humid or dusty places or in places where the projector may come into contact with oily smoke or steam, ex. a bathroom.

Using the projector under such conditions will result in fire, electric shocks or components deterioration.

Components deterioration (such as ceiling mount brackets) may cause the projector which is mounted on the ceiling to fall down.

Do not install this projector in a place which is not strong enough to take the full weight of the projector or on top of a surface which is sloped or unstable.

Failure to observe this will cause projector to fall down or tip over the projector, and severe injury or damage could result.

Do not place another projector or other heavy objects on top of the projector.

Failure to observe this will cause the projector to become unbalanced and fall, which could result in damage or injury. The projector will be damaged or deformed.

WARNING:**Installation work (such as ceiling mount bracket) should only be carried out by a qualified technician.**

If installation is not carried out and secured correctly it can cause injury or accidents, such as electric shocks.

- Do not use anything other than an authorized ceiling mount bracket.
- Be sure to use the wire provided with the projector mount base for ceiling mount as an extra safety measure to prevent the projector from falling down. (Install in a different location to the ceiling mount bracket.)

Do not cover the air inlet port or the air outlet port.

Doing so will cause the projector to overheat, which can cause fire or damage to the projector.

- Do not place the projector in narrow, badly ventilated places.
- Do not place the projector on cloth or papers, as these materials could be drawn into the air inlet port.

Do not place your hands or other objects close to the air outlet port.

Doing so will cause burns or damage your hands or other objects.

- Heated air comes out of the air outlet port. Do not place your hands or face, or objects which cannot withstand heat close to this port.

Do not look and place your skin into the lights emitted from the lens while the projector is being used.

Doing so can cause burns or loss of sight.

- Strong light is emitted from the projector's lens. Do not look or place your hands directly into this light.
- Be especially careful not to let young children look into the lens. In addition, turn off the power and disconnect the power plug when you are away from the projector.

Do not insert any foreign objects into the projector.

Doing so will cause fire or electric shocks.

- Do not insert any metal objects or flammable objects into the projector or drop them onto the projector.

Never attempt to remodel or disassemble the projector.

High voltages can cause fire or electric shocks.

- For any inspection, adjustment and repair work, please contact an Authorized Service Center.

Do not project an image with the lens cover attached.

Doing so can cause fire.

Do not allow metal objects, flammable objects, or liquids to enter inside of the projector. Do not allow the projector to get wet.

Doing so may cause short circuits or overheating, and result in fire, electric shock, or malfunction of the projector.

- Do not place containers of liquid or metal objects near the projector.
- If liquid enters inside of the projector, consult your dealer.
- Particular attention must be paid to children.

Use the ceiling mount bracket specified by Panasonic.

Defects in the ceiling mount bracket will result in falling accidents.

- Attach the supplied safety cable to the ceiling mount bracket to prevent the projector from falling down.

Read this first!

WARNING:

■ ACCESSORIES

Do not use or handle the batteries improperly, and refer to the following.

Failure to observe this will cause burns, batteries to leak, overheat, explode or catch fire.

- Use AAA/R03 or AAA/LR03 batteries.
- Do not use unspecified batteries.
- Do not disassemble dry cell batteries.
- Do not heat the batteries or place them into water or fire.
- Do not allow the + and – terminals of the batteries to come into contact with metallic objects such as necklaces or hairpins.
- Do not store batteries together with metallic objects.
- Store the batteries in a plastic bag and keep them away from metallic objects.
- Make sure the polarities (+ and –) are correct when inserting the batteries.
- Do not use a new battery together with an old battery or mix different types of batteries.
- Do not use batteries with the outer cover peeling away or removed.
- Remove the empty batteries from the remote control at once.
- Insulate the battery using tape or something similar before disposal.

Do not allow children to reach the batteries (AAA/R03 or AAA/LR03 type).

- The battery can cause personal injury if swallowed.
- If swallowed, seek medical advice immediately.

If the battery fluid leaks, do not touch it with bare hands, and take the following measures if necessary.

- Battery fluid on your skin or clothing could result in skin inflammation or injury.
Rinse with clean water and seek medical advice immediately.
- Battery fluid coming in contact with your eyes could result in loss of sight.
In this case, do not rub your eyes. Rinse with clean water and seek medical advice immediately.

Do not disassemble the lamp unit.

If the lamp breaks, it could cause injury.

Lamp replacement

The lamp has high internal pressure. If improperly handled, an explosion and severe injury or accidents will result.

- The lamp can easily explode if struck against hard objects or dropped.
- Before replacing the lamp, be sure to disconnect the power plug from the wall outlet.
Electric shocks or explosions can result if this is not done.
- When replacing the lamp, turn the power off and allow the lamp to cool for at least 1 hour before handling it otherwise it can cause burns.

Do not allow infants or pets to touch the remote control unit.

- Keep the remote control unit out of the reach of infants and pets after using it.

Do not use the supplied power cord with devices other than this projector.

- Using the supplied power cord with devices other than this projector may cause short circuits or overheating, and result in electric shock or fire.

Remove the depleted batteries from the remote control promptly.

- Leaving them in the unit may result in fluid leakage, overheating, or explosion of the batteries.

CAUTION:

■ **POWER**

When disconnecting the power cord, be sure to hold the power plug and power connector.
If the power cord itself is pulled, the lead will become damaged, and fire, short-circuits or serious electric shocks will result.

When not using the projector for an extended period of time, disconnect the power plug from the wall outlet and remove the batteries from the remote control.

Disconnect the power plug from the wall outlet before carrying out any cleaning and replacing the unit.
Electric shocks can result if this is not done.

■ **ON USE/INSTALLATION**

Do not put your weight on this projector.
You could fall or the projector could break, and injury will result.
● Be especially careful not to let young children stand or sit on the projector.

Do not place the projector in extremely hot locations.
Doing so will cause the outer casing or internal components to deteriorate, or result in fire.
● Take particular care in locations exposed to direct sunlight or near stoves.

Always disconnect all cables before moving the projector.
Moving the projector with cables still attached can damage the cables, which will cause fire or electric shocks to occur.

Never plug headphones and earphones into VARIABLE AUDIO OUT jack.
Excessive sound pressure from earphones and headphones can cause hearing loss.

■ **ACCESSORIES**

Do not use the old lamp unit.
If used it could cause lamp explosion.

If the lamp has broken, ventilate the room immediately. Do not touch or bring your face close to the broken pieces.
Failure to observe this will cause the user to absorb the gas which was released when the lamp broke and which contains nearly the same amount of mercury as fluorescent lamps, and the broken pieces will cause injury.
● If you believe that you have absorbed the gas or that the gas has got into your eyes or mouth, seek medical advice immediately.
● Ask your dealer about replacing the lamp unit and check the inside of the projector.



To remove the battery

Remote Control Battery

1. Press the guide and lift the cover.

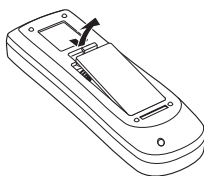

2. Remove the batteries.

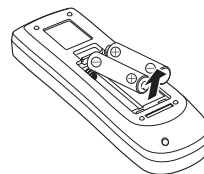

Read this first!

Trademarks

- Microsoft® and its logos, Windows®, Windows® XP, Windows Vista®, Windows® 7, and Internet Explorer® are the registered trademarks or trademarks of Microsoft Corporation in the United States and/or other countries.
- Macintosh, Mac OS and Safari are the trademarks of Apple Inc. registered in the United States and other countries.
- HDMI, the HDMI logo and High-Definition Multimedia Interface is a trademark or registered trademark of HDMI Licensing LLC. 
- PJLink™ is a trademark or pending trademark in Japan, the United States, and other countries and regions.
- RoomView, Crestron RoomView are registered trademarks of Crestron Electronics, Inc. Crestron Connected and Fusion RV are the trademarks of Crestron Electronics, Inc.
- iPad, iPhone, and iPod touch are trademarks of Apple Inc., registered in the U.S. and other countries.
- Other names, company names or product names used in these operating instructions are the trademarks or registered trademarks of their respective holders.

Please note that the operating instructions do not include the ® and ™ symbols.

Illustrations in these operating instructions

- Note that illustrations of the projector and screens may differ from the ones you actually see.

Page references

- In these instructions, references to pages are indicated as: (➡ page 00).

Term

- In these instructions, the “Wireless remote control unit” accessory is referred to as the “Remote control”.

Declaration of Conformity



Declaration of Conformity (DoC)

This equipment is in compliance with the essential requirements and other relevant provisions of Directive 1999/5/EC.

Customers can download a copy of the original DoC for this product from our DoC server: <http://www.doc.panasonic.de>

Contact in the EU: Panasonic Services Europe, a Division of Panasonic Marketing Europe GmbH, Panasonic Testing Centre, Winsbergring 15, 22525 Hamburg, F.R.Germany

This product is intended to be used in the following countries.

Austria, Belgium, Bulgaria, Czech, Cyprus, Denmark, Estonia, Finland, France, Germany, Greece, Hungary, Iceland, Ireland, Italy, Latvia, Lithuania, Luxembourg, Malta, Netherlands, Norway, Poland, Portugal, Romania, Slovenia, Slovak, Spain, Sweden, Switzerland & UK



Konformitätserklärung (KE)

Dieses Gerät entspricht den grundlegenden Anforderungen und den weiteren entsprechenden Vorgaben der Richtlinie 1999/5/EU.

Kunden können eine Kopie der Original-KE für dieses Produkt von unserem KE-Server herunterladen: <http://www.doc.panasonic.de>

Kontaktadresse in der EG: Panasonic Services Europe, a Division of Panasonic Marketing Europe GmbH, Panasonic Testing Centre, Winsbergring 15, 22525 Hamburg, F.R.Germany

Dieses Produkt ist für den Einsatz in den folgenden Ländern vorgesehen.

Österreich, Belgien, Bulgarien, Tschechische Republik, Zypern, Dänemark, Estland, Finnland, Frankreich, Deutschland, Griechenland, Ungarn, Island, Irland, Italien, Lettland, Litauen, Luxemburg, Malta, Niederlande, Norwegen, Polen, Portugal, Rumänien, Slowenien, Slowakei, Spanien, Schweden, Schweiz und Großbritannien



Déclaration de Conformité (DC)

Cet appareil est conforme aux exigences essentielles et aux autres dispositions pertinentes de la Directive 1999/5/EC.

Les clients peuvent télécharger une copie de la DC originale pour ce produit à partir de notre serveur DC: <http://www.doc.panasonic.de>

Coordonnées dans l'UE : Panasonic Services Europe, a Division of Panasonic Marketing Europe GmbH, Panasonic Testing Centre, Winsbergring 15, 22525 Hamburg, F.R.Germany

Ce produit est conçu pour l'utilisation dans les pays suivants.

Autriche, Belgique, Bulgarie, République Tchèque, Chypre, Danemark, Estonie, Finlande, France, Allemagne, Grèce, Hongrie, Islande, Irlande, Italie, Lettonie, Lituanie, Luxembourg, Malte, Pays-Bas, Norvège, Pologne, Portugal, Roumanie, Slovaquie, Espagne, Suède, Suisse et Royaume-Uni



Declaración de conformidad (DC)

Este equipo cumple con los requisitos esenciales así como con otras disposiciones de la Directiva 1999/5/CE.

El cliente puede descargar una copia de la DC original de este producto desde nuestro servidor DC: <http://www.doc.panasonic.de>

Contacto en la U.E.: Panasonic Services Europe, a Division of Panasonic Marketing Europe GmbH, Panasonic Testing Centre, Winsbergring 15, 22525 Hamburg, F.R.Germany

Este producto ha sido desarrollado para el uso en los siguientes países.

Austria, Bélgica, Bulgaria, República Checa, Chipre, Dinamarca, Estonia, Finlandia, Francia, Alemania, Grecia, Hungría, Islandia, Irlanda, Italia, Letonia, Lituania, Luxemburgo, Malta, Holanda, Noruega, Polonia, Portugal, Rumania, Eslovenia, Eslovaquia, España, Suecia, Suiza y el Reino Unido



Dichiarazione di conformità (DoC)

Questo apparecchio è conforme ai requisiti essenziali ed agli altri principi sanciti dalla Direttiva 1999/5/CE.

I clienti possono scaricare la copia del DoC originale per questo prodotto dal nostro server DoC: <http://www.doc.panasonic.de>

Contatto nella EU: Panasonic Services Europe, a Division of Panasonic Marketing Europe GmbH, Panasonic Testing Centre, Winsbergring 15, 22525 Hamburg, F.R.Germany

I prodotti sono stati prodotti per l'uso nei seguenti paesi.

Austria, Belgio, Bulgaria, Repubblica Ceca, Cipro, Danimarca, Estonia, Finlandia, Francia, Germania, Grecia, Irlanda, Islanda, Italia, Lettonia, Lituania, Lussemburgo, Malta, Olanda, Norvegia, Polonia, Portogallo, Romania, Regno Unito, Slovenia, Slovacchia, Spagna, Svezia, Svizzera, Ungheria

Read this first!

България

Това устройство отговаря на съществените изисквания и останалите приложими разпоредби на Директива 1999/5/ЕО.

Česky

Toto zařízení je v souladu se základními požadavky a ostatními odpovídajícími ustanoveními Směrnice 1999/5/EC.

Dansk

Dette udstyr er i overensstemmelse med de væsentlige krav og andre relevante bestemmelser i Direktiv 1999/5/EF.

Eesti

See seade vastab direktiivi 1999/5/EÜ olulistele nõuetele ja teistele asjakohastele sätetele.

Ελληνική

Αυτός ο εξοπλισμός είναι σε συμμόρφωση με τις ουσιώδεις απαιτήσεις και άλλες σχετικές διατάξεις της Οδηγίας 1999/5/ΕΚ.

Íslenska

Þetta tæki er samkvæmt grunnkröfum og öðrum viðeigandi ákvæðum Tilskipunar 1999/5/EC.

Latviski

Šī iekārta atbilst Direktīvas 1999/5/EK būtiskajām prasībām un citiem ar to saistītajiem noteikumiem.

Lietuvių

Šis įrenginys tenkina 1999/5/EB Direktyvos esminius reikalavimus ir kitas šios direktyvos nuostatas.

Nederlands

Dit apparaat voldoet aan de essentiële eisen en andere van toepassing zijnde bepalingen van de Richtlijn 1999/5/EC.

Malti

Dan I-apparat huwa konformi mal-ħtiġiet essenzjali u I-provedimenti I-oħra rilevanti tad-Direttiva 1999/5/EC.

Magyar

Ez a készülék teljesíti az alapvető követelményeket és más 1999/5/EK irányelvben meghatározott vonatkozó rendelkezéseket.

Norsk

Dette utstyret er i samsvar med de grunnleggende krav og andre relevante bestemmelser i EU-direktiv 1999/5/EF.

Polski

Urządzenie jest zgodne z ogólnymi wymaganiami oraz szczególnymi warunkami określonymi Dyrektywą UE: 1999/5/EC.

Português

Este equipamento está em conformidade com os requisitos essenciais e outras provisões relevantes da Directiva 1999/5/EC.

România

Acest echipament este conform cu cerințele de bază și celelalte prevederi relevante ale Directivei 1999/5/CE.

Slovensko

Ta naprava je skladna z bistvenimi zahtevami in ostalimi relevantnimi pogoji Direktive 1999/5/EC.

Slovensky

Toto zariadenie je v zhode so základnými požiadavkami a inými príslušnými nariadeniami direktív: 1999/5/EC.

Suomi

Tämä laite täyttää direktiivin 1999/5/EY olennaiset vaatimukset ja on siinä asetettujen muiden laitetta koskevien määräysten mukainen.

Svenska

Denna utrustning är i överensstämmelse med de väsentliga kraven och andra relevanta bestämmelser i Direktiv 1999/5/EC.

■ Features of the Projector

Auto Setup Function

- ▶ This function enables Input search, Auto Keystone correction and Auto PC adjustment by pressing the <AUTO SETUP> button.

Direct Power Off Function

- ▶ With the Direct Power Off function, you can disconnect the power cord from the wall outlet or turn off the breaker even during projection.

Wired and Wireless LAN Function

- ▶ This function allows you to project an image on a computer as well as operate and manage the projector via network.

Useful Functions for Presentations

- ▶ The digital zoom function allows you to focus on the crucial information during a presentation.
- ▶ The MIC function and 10W audio output allows you to make a presentation without any external audio equipment.

■ Quick steps

For details, see the corresponding pages.

1. **Set up your projector.**
(⇒ page 27)



2. **Connect with other devices.**
(⇒ page 31)



3. **Connect the power cord.**
(⇒ page 32)



4. **Power on.**
(⇒ page 34)



5. **Select the input signal.**
(⇒ page 37)



6. **Adjust the image.**
(⇒ page 37)

Contents

Be sure to read "Read this first!". (➔ pages 2 to 10)

Important Information

Read this first!	2
Declaration of Conformity	9
Contents	12
Precautions for Use	14
Cautions when transporting.....	14
Cautions when installing.....	14
Disposal.....	15
Cautions on use	16
Notes on Using Wireless Connection	17
Security	18
Accessories	19
Optional accessories	20

Preparation

About Your Projector	21
Remote control	21
Projector body	23
Control panel	24
Rear terminals	25
Using Remote control	26
Installing and Removing batteries	26
Setting Remote control ID numbers	26

Getting Started

Setting up	27
Projection method	27
Parts for ceiling mount (Optional).....	27
Screen size and throw distance	28
Adjusting front adjustable feet.....	30
Adjusting the position using the vertical lens shift function	30
Connections	31
Before connecting to the projector	31
Connecting example.....	31

Basic Operation

Powering ON/OFF	32
Connecting the power cord	32
ON(G)/STANDBY(R) indicator.....	33
Turning On the Projector	34
Enter a PIN code	35
Turning Off the Projector	36
Projecting	37
Selecting the image.....	37
How to adjust the state of the image.....	37
Basic operations by using the remote control	38

Using the AUTO SETUP function	38
Using the IMAGE button.....	38
Using the MENU button.....	38
Using the INFO button.....	38
Controlling the volume of the speaker.....	38
Using the wireless mouse function	39
Using the PAGE UP/DOWN buttons	39
Using the POINTER button	39
Using the KEYSTONE button.....	39
Switching the input signal.....	40
Using the MUTE button	40
Using the D.ZOOM +/- buttons.....	40
Using the FREEZE function	40
Using the AV MUTE function	41
Using the SCREEN button	41
Using the P-TIMER button	41
Using the LAMP button	41

Settings

Menu Navigation	42
Navigating through the menu	42
Main menu.....	43
Sub menu	43
Input menu	45
Computer 1: RGB/Component /RGB (Scart)	45
Computer 2: RGB.....	45
HDMI	45
Video	45
S-video	45
Network	46
AUTO PC adjust	47
Auto PC adj.	47
Manual PC adjust	48
Fine sync	48
Total dots	48
Horizontal	48
Vertical.....	48
Current mode	49
Clamp	49
Display area H.....	49
Display area V	49
Reset	49
Mode free	49
Store.....	49
Image select	50
Dynamic	50
Standard.....	50
Real	50
Cinema	50
Blackboard(Green).....	50
Colorboard.....	50
Image 1-4	50
Image adjust	51
Contrast.....	51

Brightness	51
Color	51
Tint	51
Iris	51
Color temp.	52
Red	52
Green	52
Blue	52
Daylight View	52
Sharpness	53
Gamma	53
Noise reduction	53
Progressive	53
Reset	53
Store	53
Screen	54
Normal	54
Full	54
Wide(16:9)	54
Zoom	54
True	54
Natural wide (PT-VW435NEA Only)	54
Custom	54
Custom adj.	55
Digital zoom +	55
Digital zoom -	55
Keystone	55
Ceiling	56
Rear	56
Screen aspect (PT-VW435NEA Only)	56
Reset	56
Sound	57
Volume	57
Mute	57
MIC	57
MIC gain	57
Standby MIC out	57
Setting	58
Language	58
Menu position	58
Auto setup	58
Background	59
Display	59
Logo	59
HDMI setup	60
USB terminal	60
Pointer	60
Terminal	60
Power management	61
Direct on	61
Standby mode	61
P-timer	61
Closed caption	62
Lamp power	62
Remote control	62
Security	63
Fan	63

Fan control	63
Video delay control	64
Filter counter	64
Emulate	64
Warning log	65
Factory default	65
Information	66
Input Source Information Display	66
Network	67
Wired LAN	67
Wireless LAN	67
Wireless detailed setup	68
Projector name	71
Password	71
Network control	71
Live mode cut in	72
Multi-live	72
Network status	72
AMX D.D.	72
RoomView	72
Memory viewer	73
Network factory default	73
Network connections	74
Connecting with Wired LAN	75
Connecting with Wireless LAN	75
Accessing from the Web browser	77
Memory Viewer function	90

Maintenance

LAMP and WARNING Indicators	94
Managing the indicated problems	94
Replacement	95
Before replacing the unit	95
Maintenance	95
Replacing the unit	95
Attaching the Lens Cap	99
Troubleshooting	100

Appendix

Technical Information	102
PJLink protocol	102
Control commands via LAN	103
Serial terminal	105
Other terminals	108
List of compatible signals	110
Specifications	114
Dimensions	116
Ceiling mount bracket safeguards	116
Glossary	117
Index	119

Precautions for Use

Cautions when transporting

- When transporting the projector, hold it securely by its bottom and avoid excessive vibration and impacts. Doing so may damage the internal parts and result in malfunctions.
- Do not transport the projector with the adjustable feet extended. Doing so may damage the adjustable feet.

Cautions when installing

■ Do not set up the projector outdoors.

- The projector is designed for indoor use only.

■ Do not use under the following conditions.

- Places where vibration and impacts occur such as in a car or vehicle: Doing so may damage the internal parts and result in malfunctions.
- Near the exhaust of an air conditioner or near lights (studio lamps, etc.) where temperature changes greatly (Operating environment ►page 115): Doing so may shorten the life of the lamp or result in deformation of the outer case and malfunctions.
- Near high-voltage power lines or near motors: Doing so may interfere with the operation of the projector.

■ Be sure to ask a specialized technician when installing the product to a ceiling.

This requires an optional ceiling mount bracket.

Model No.: ET-PKV100H (for high ceilings), ET-PKV100S (for low ceilings),
ET-PKV200B (Projector Mount Base).

■ When using the projector in the elevation of below 1 200 m, make sure [Fan control] is set to [Off].

Failure to do so may shorten the life of the internal parts and result in malfunctions.

■ When using the projector in the elevation of above 1 200 m and below 2 000m, make sure [Fan control] is set to [On 1].

Failure to do so may shorten the life of the internal parts and result in malfunctions.

■ When using the projector in the elevation of above 2 000 m and below 2 700m, make sure [Fan control] is set to [On 2].

Failure to do so may shorten the life of the internal parts and result in malfunctions.

■ Do not install the projector at elevations of 2 700 m (8 858 ft) or higher above sea level.

Failure to do so may shorten the life of the internal parts and result in malfunctions.

■ Do not tilt the projector or place it on its side.

Do not tilt the projector body more than approximately ± 30 degrees vertically or ± 15 degrees horizontally. Over tilting may result in shortening the life of the components.

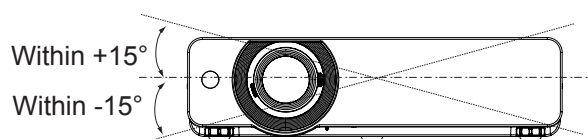
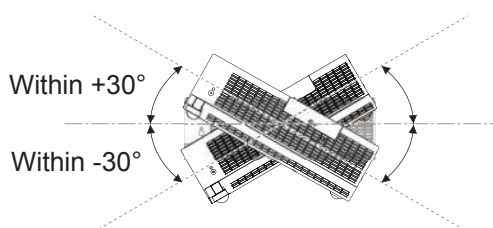

Cautions when setting the projectors

- Do not stack the projectors.
- Do not block the ventilation ports (intake and exhaust) of the projector.
- Avoid heating and cooling air from the air conditioning system directly blow to the ventilation ports (intake and exhaust) of the projector.

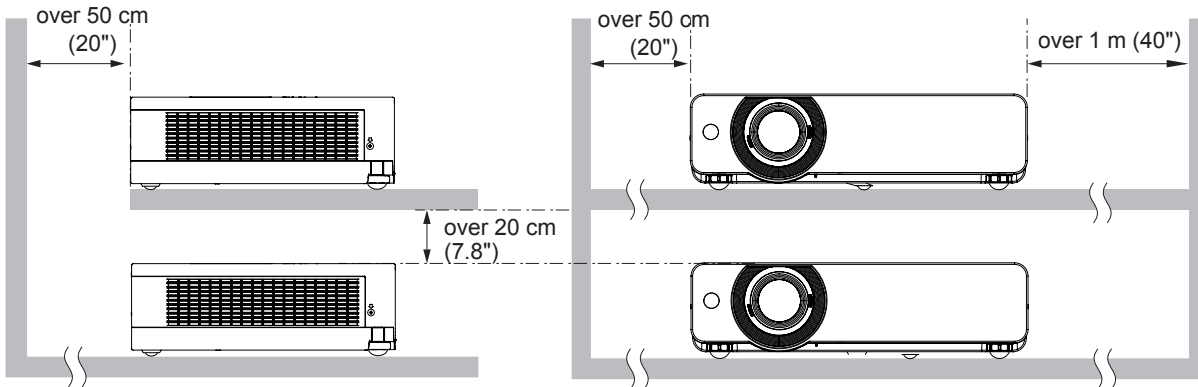
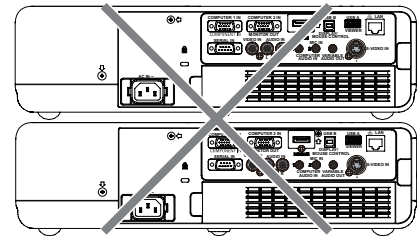

- Do not place the projector in an enclosed space.
If you need to place the projector in an enclosed space, additional air conditioning and ventilation system must be equipped. When ventilation is insufficient, remaining heat may trigger the protection circuit of the projector.

Disposal

When disposing of the product, ask your local authority or dealer about the correct methods of disposal. The lamp contains mercury. When disposing of the used lamp unit, ask your nearest local authorities or dealer about proper disposal of the unit. Dispose of used batteries according to the instructions or your local disposal rule or guidelines.

Precautions for Use

Cautions on use

■ In order to get the picture quality

- Draw curtains or blinds over windows and turn off any lights near the screen to prevent outside light or light from indoor lamps from shining onto the screen.
- Depending on where the projector is used, heated air from an exhaust port or warm or cold air from an air conditioner can cause a shimmering effect on screen.
Avoid use in locations where exhaust or streams of air from projector, other devices and air conditioners flow between the projector and the screen.
- The lens of projector is affected by the heat from the luminous source. Because of this, the focusing may not be stable right after the power is turned on. Focusing is stabled after projecting image for 30 minutes and longer.

■ Do not touch the surface of the projector lens with your bare hand.

If the surface of the lens becomes dirty from fingerprints or anything else, this will be magnified and projected onto the screen.

■ LCD Panel

The display unit of this projector comprises three LCD panels. Although an LCD panel is a product of high-precision technology, some of the pixels on the projected image may be missing or constantly lit. Please note that this is not a malfunction.

Displaying a still image for a longer time may result in an after-image on the LCD panels. If this happens, display the all white screen in the test pattern for an hour or more.

■ Optical components

Operating the projector in an environment with high temperature or heavy exposure to dust or tobacco smoke will reduce the service life of the optical components, such as the LCD panel and polarizing plate, and may necessitate their replacement within less than one year of use. For details, consult your dealer.

■ Lamp

The luminous source of the projector is a mercury lamp with high internal pressure.

A high pressure mercury lamp has following characteristics.

- The brightness of the lamp will decrease by duration of usage.
- The lamp may burst with sound or shorten life by shock or chipping.
- The life of the lamp varies greatly depending on individual specificities and usage conditions. In particular, continuous use over 12 hours and frequent on/off switching of the power greatly deteriorate the lamp and affect the lamp life.
- In rare cases, the lamp burst shortly after the projection.
- The risk of bursting increases when the lamp is used beyond its replacement cycle. Make sure to replace the lamp unit consistently. ("When to replace the lamp unit" (➡ page 97))
- If the lamp bursts, gas contained inside of the lamp is released in a form of smoke.
- It is recommended to store replacement lamps for contingency.
- It is recommended to have authorized engineer or your dealer replace the lamp unit.

<Software Information regarding this product>

© Panasonic Corporation 2012

This product incorporates the following software:

(1) the software which is developed independently by or for Panasonic Corporation

(2) the software which is licensed under the GNU GENERAL PUBLIC LICENSE,
and

(3) the software which is licensed under the GNU LESSER GENERAL PUBLIC LICENSE.

For the software categorized as (2) and (3), the license is available in accordance with GNU GENERAL PUBLIC LICENSE and GNU LESSER GENERAL PUBLIC LICENSE respectively. As for the terms and conditions, please refer to the software licence of the supplied CD-ROM.

If you wish to ask any questions as to the software, please contact (sav.pj.gpl.pavc@ml.jp.panasonic.com) by email.

Pursuant to at the directive 2004/108/EC, article 9(2)

Panasonic Testing Centre

Panasonic Service Europe, a division of Panasonic Marketing Europe GmbH

Winsbergring 15, 22525 Hamburg, F.R. Germany

Notes on Using Wireless Connection

Wireless connection function of the projector uses radio waves in the 2.4 GHz band. A radio station license is not required, but be sure to read and fully understand the following items before use.

■ **Do not use near other wireless equipment.**

The following equipment may use radio waves in the same band as the projector. When the projector is used near these devices, radio wave interference may make communication impossible, or the communication speed may become slower.

- Microwave ovens, etc.
- Industrial, chemical and medical equipment, etc.
- In-plant radio stations for identifying moving objects such as those used in factory manufacturing lines, etc.
- Designated low-power radio stations

■ **If at all possible, avoid the use of cellular phones, TV sets or radios near the projector.**

Cellular phones, TV sets, radios and similar devices use different radio bands from the projector, so there is no effect on wireless communication or the transmission and reception of these devices. However, radio waves from the projector may produce audio or video noise.

■ **Wireless communication radio waves cannot penetrate steel reinforcements, metal, concrete, etc.**

Communication is possible through walls and floors made from materials such as wood and glass (except glass containing wire mesh), but not through walls and floors made from steel reinforcements, metal, concrete, etc.

■ **Avoid using the projector in locations prone to static electricity.**

If the projector is used in a location prone to static electricity, such as on a carpet, the wireless LAN* or wired LAN connection may be lost.

*"Glossary" (➡page 117 – 118)

If this happens, eliminate the source of static electricity or electromagnetic noise and reconnect to the wireless LAN or wired LAN.

In rare cases static electricity or electromagnetic noise may make it impossible to establish a connection to the LAN.

If this happens, press the power button on the remote control or on the projector to power off the projector temporarily.

After the cooling fan stops operating (after <ON(G)/STANDBY(R)> indicator on the projector changes from blinking in orange to lighting in red), power on the projector and reconnect to the LAN.

■ **Using the projector outside the country**

It is forbidden to take the projector outside the country or region where you purchased it, so use it only in the said country or region. Also, note that depending on countries or regions there are restrictions on the channels and frequencies at which you can use the wireless LAN.

■ **Available wireless LAN channels**

The channels (frequency range) that can be used differ according to the country or region. Refer to the table below.

Country or region	Standard	Channels used	Frequency band (Center frequency)
England, Germany, France, Spain, Italy, Belgium, Austria, Sweden, Norway, Denmark, Switzerland, Holland, Finland, Portugal, Greece, Thailand, South Korea	ETSI 300.328	1 – 13	2,412 MHz - 2,472 MHz
Singapore	IDA		
Australia, New Zealand	C-Tick		
Malaysia	SIRIM		
United States	FCC part 15	1 – 11	2,412 MHz - 2,462 MHz
Taiwan	DGT		

Security

■ Take safety measures against following incidents.

- Personal information being leaked via this product.
- Unauthorized operation of this product by a malicious third party.
- Interfering or stopping of this product by a malicious third party.

■ Security instruction (➔page 63, 87)

- Make your password as difficult to guess as possible.
- Change your password periodically.
- Panasonic or its affiliate company never inquires a password directly to a customer. Do not tell your password in case you receive such an inquiry.
- The connecting network must be secured by firewall or others.
- Set a password for web control and restrict the users who can log in.

About Wireless LANs

The advantage of a wireless LAN is that information can be exchanged between a PC or other such equipment and an access point using radio waves as long as you are within range for radio transmissions. On the other hand, because the radio waves can travel through obstacles (such as walls) and are available everywhere within a given range, problems of the type listed below may occur if security-related settings are not made.

- A malicious third-part may intentionally intercept and monitor transmitted data including the content of e-mail and personal information such as your ID, password, and/or credit card numbers.
- A malicious third-party may access your personal or corporate network without authorization and engage in the following types of behavior.
 - Retrieve personal and/or secret information (information leak)
 - Spread false information by impersonating a particular person (spoofing)
 - Overwrite intercepted communications and issue false data (tampering)
 - Spread harmful software such as a computer virus and crash your data and/or system (system crash)

Since most wireless LAN adapters or access points are equipped with security features to take care of these problems, you can reduce the possibility of these problems occurring when using this product by making the appropriate security settings for the wireless LAN device.

Some wireless LAN devices may not be set for security immediately after purchase. To decrease the possibility of occurrence of security problems, before using any wireless LAN devices, be absolutely sure to make all security-related settings according to the instructions given in the operation manuals supplied with them.

Depending on the specifications of the wireless LAN, a malicious third-party may be able to break security settings by special means.







Please contact Panasonic if you need help taking care of security settings or other such.

If you cannot perform security settings for your wireless LAN by yourself, please contact the Panasonic Support Center.

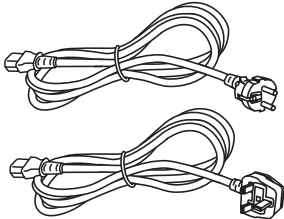
Panasonic asks customers to thoroughly understand the risk of using this product without making security settings, and recommends that the customer make security settings at their own discretion and responsibility.

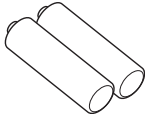
Accessories

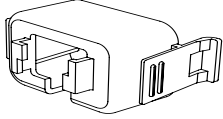
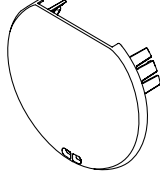
Make sure the following accessories are provided with your projector. Numbers in the brackets () show the number of accessories.

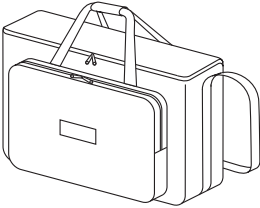
<p>Remote control unit (x1) (6451056016)</p>	<p>Power cord (x2) (6103580203) (6103580210)</p>	<p>CD-ROM (x1) (6103589404)</p>	<p>Batteries (AAA/R03 or AAA/LR03 type) (x2)</p>
			 (for remote control unit)
<p>RGB signal cable (x1) (6103580425)</p>	<p>AC power cord holder (x1) (6451052124)</p>	<p>Lens cap (x1) (6103594279)</p>	<p>String (x1) (6103430249)</p>
		 (Attached to the projector at the time of purchase.)	
<p>Soft Carrying Case (x1) (6103601861)</p>			
			

Attention

- After unpacking the projector, discard the power cord cap and packaging material properly.
- For lost accessories, consult your dealer.
- The part numbers of accessories and separately sold components are subject to change without notice.
- Store small parts in an appropriate manner, and keep them away from young children.

Precautions for Use

■ Contents of the supplied CD-ROM

The contents of the supplied CD-ROM are as follow.

Manual/list (PDF)	Software
<ul style="list-style-type: none"> ● Operating Instructions – Functional Manual ● Operation Manual Multi Projector Monitoring & Control Software 2.7 ● Operation Manual Logo Transfer Software 2.0 ● Operation Manual Wireless Manager ME6.0 ● List of compatible projector models <ul style="list-style-type: none"> • This is a list of projectors that are compatible with the software (refer to the right column), and their restrictions. ● Software license (GNU GENERAL PUBLIC LICENSE and GNU LESSER GENERAL PUBLIC LICENSE) 	<ul style="list-style-type: none"> ● Multi Projector Monitoring & Control Software 2.7(Windows) <ul style="list-style-type: none"> • This software allows you to monitor and control multiple projectors connected to the LAN. ● Logo Transfer Software 2.0(Windows) <ul style="list-style-type: none"> • This software allows you to create original images, such as company logos to be displayed when projection starts, and transfer them to the projector. ● Wireless Manager ME6.0 (Windows/ Mac) <ul style="list-style-type: none"> • This software allows you to send computer screen displays over wireless/wired LAN.

Optional accessories

Options	Model No.
Ceiling Mount Bracket	ET-PKV100H (for high ceilings), ET-PKV100S (for low ceilings)
Projector Mount Base	ET-PKV200B
Replacement Lamp Unit	ET-LAV200
Replacement Filter Unit	ET-RFV200
Easy Wireless Stick*¹	ET-UW100

*¹ This product can be purchased in the U.S., Canada, Japan and the European Communities.

About Your Projector

Remote control

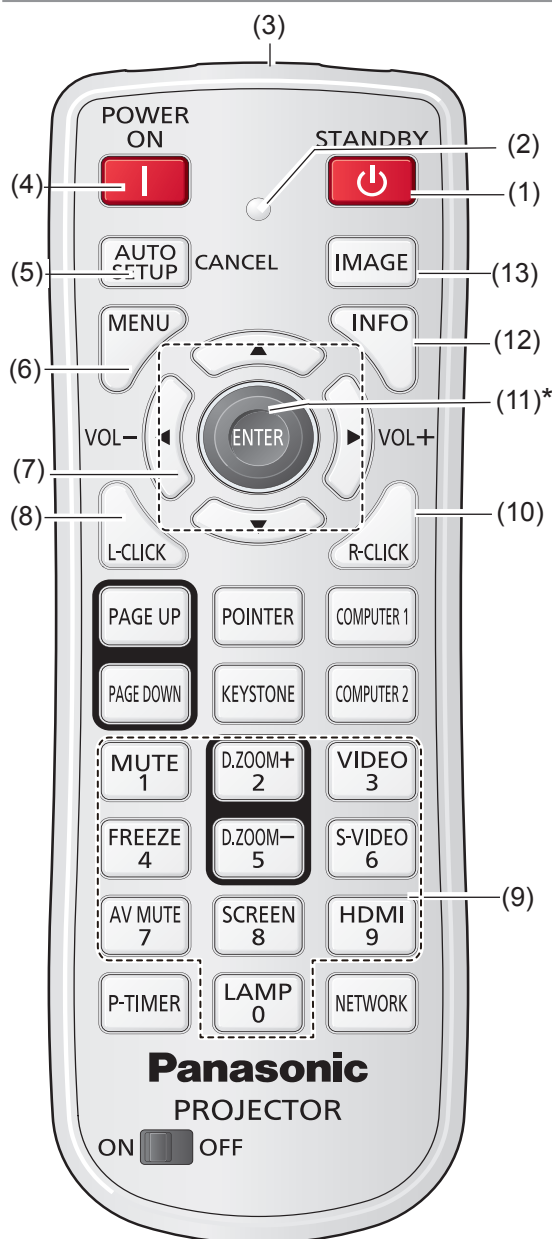

* Center part is <ENTER> Button.
Outer part is <MOUSE CONTROL> Button.

- (1) <STANDBY> Button**
Turn the projector off (➔page 36).
- (2) Signal Emission indicator**
Light red while a signal is being sent from the remote control to the projector.
- (3) Remote control signal emitter**
- (4) <POWER ON> Button**
Turn the projector on (➔page 34).
- (5) <AUTO SETUP/CANCEL> Button**
Execute the setting of Auto setup in the setting menu (➔page 58).
Cancel the playing of the memory viewer function (➔page 91).
- (6) <MENU> Button**
Open or close the On-Screen Menu (➔page 42).
- (7) ▲ ▼ ◀ ▶ (VOL-/+) Buttons, <ENTER> Button**
 - Navigate the MENU display (➔page 42).
 - Adjust the volume level or mute the sound.
- (8) <L-CLICK> Button**
Act as the left mouse button for wireless mouse operation (➔page 39).
- (9) Number Buttons**
Act as number buttons. Use these buttons when setting the remote control codes (➔page 26) or entering the PIN code numbers (➔page 35).
- (10) <R-CLICK> Button**
Act as the right mouse button for wireless mouse operation (➔page 39).
- (11) <MOUSE CONTROL> Button**
Move a pointer of the projector or a pointer for wireless mouse operation (➔page 39).
- (12) <INFO> Button**
Operate the information function (➔page 38).
- (13) <IMAGE> Button**
Select the image mode (➔page 38).

Note

- The remote control can be used as a wireless mouse for your computer.
- Before operating the wireless mouse, connect your computer and the projector with a USB cable (➔page 39).
- When a USB cable is connected to the computer and the projector, turn on the projector first, then the computer.
- (8), (10), (11), (15) are available when a USB cable is connected to the computer and the projector.

About Your Projector

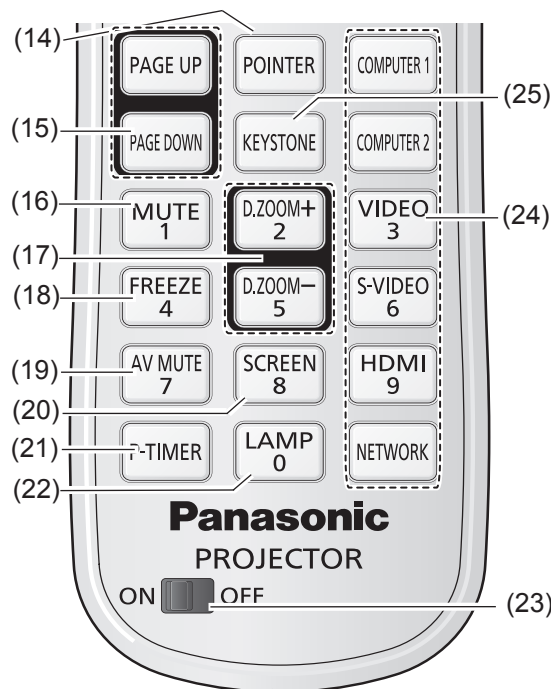

(14) <POINTER> Button

Act as the On-Off switch for the Pointer.
(➔page 39)

(15) <PAGE UP/DOWN> Buttons

Scroll back and forth the pages on the screen when giving a presentation. To use these buttons, connect the projector and your computer with a USB cable.(➔page 39)

(16) <MUTE> Button

Mute the sound. (➔page 40)

(17) <D.ZOOM +/-> Buttons

Zoom in and out the images. (➔page 40)

(18) <FREEZE> Button

Pause the projected image and sound tentatively.
(➔page 40)

(19) <AV MUTE> Button

Temporarily turn off the image on the screen.
(➔page 41)

(20) <SCREEN> Button

Select a screen mode. (➔page 54)

(21) <P-TIMER> Button

Operate the P-timer function. (➔page 41)

(22) <LAMP> Button

Select a lamp mode. (➔page 41)

(23) ON/OFF switch

When using the remote control, set this switch to "ON". Set it to "OFF" for power saving when it is not in use.

(24) Input Selection buttons: <COMPUTER 1>, <COMPUTER 2>, <VIDEO>, <S-VIDEO>, <HDMI>, <NETWORK>.

These buttons are used to select the input signal.
(➔page 40)

(25) <KEYSTONE> Button

Correct keystone distortion. (➔page 39)

Attention

- Do not drop the remote control.
- Avoid contact with liquids.
- Do not attempt to modify or disassemble the remote control.

Note

- The remote control can be used within a distance of about 7 m (22.97 ft) if pointed directly at the remote control signal receiver. The remote control can control at angles of up to $\pm 30^\circ$ vertically and $\pm 30^\circ$ horizontally, but the effective control range may be reduced.
- If there are any obstacles between the remote control and the remote control signal receiver, the remote control may not operate correctly.
- You can operate the projector by reflecting the remote control signal on the screen. The operating range may differ due to the loss of light caused by the properties of the screen.
- When the remote control signal receiver is lit with a fluorescent light or other strong light source, the projector may become inoperative. Set the projector as far from the luminous source as possible.

Projector body

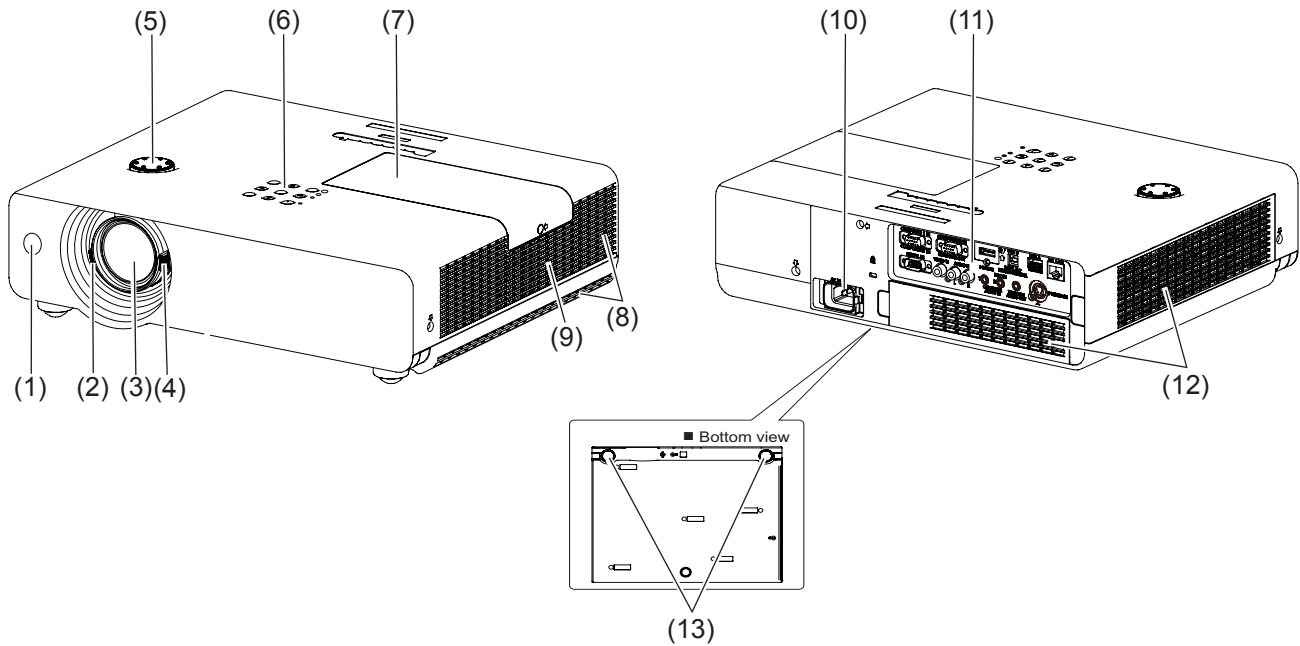

(1) Remote control signal receiver

(2) Focus Lever (➔ page 37)

Adjust the focus.

(3) Projection Lens

(4) Zoom Lever (➔ page 37)

Adjust the zoom.

(5) Vertical lens shift ring (➔ page 30)

Adjust the vertical position of the projected image.

(6) Control Panel and Indicators (➔ page 24)

(7) Lamp cover (➔ page 98)

The lamp unit is located inside.

(8) Air outlet port

- Hot air is exhausted from the exhaust vent. Do not put heat-sensitive objects near this side.

(9) Speaker

(10) AC IN

(11) Terminals (➔ page 25)

(12) Air intake port / Air filter covers (➔ page 95)

(13) Adjustable feet

Adjust the projection angle.

WARNING:

- Keep your hands and other objects away from the air exhaust port.
- Keep your hand and face away.
- Do not insert your finger.
- Keep heat-sensitive articles away.

Heated air from the air exhaust port can cause burns or external damage.

About Your Projector

Control panel

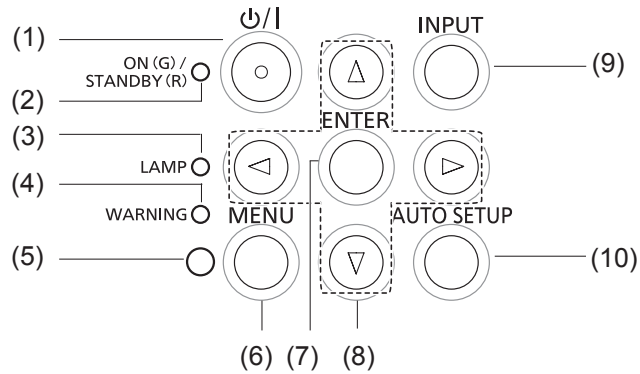

(1) <⏻/⏷> button

Turn the projector on/off.

(2) <ON(G)/STANDBY(R)> indicator

Indicate the power status.

(3) <LAMP> indicator

Light yellow when the projection lamp reaches its end of life.

(4) <WARNING> indicator

Indicate the abnormal conditions of the projector.

(5) Daylight view sensor

Detect room's light, select proper image quality.

(6) <MENU> button

Display the MENU screen. (➡page 42)

(7) <ENTER> button

Execute the selected item.

(8) ▲ ▼ ◀ ▶ (VOL-/+) buttons

Navigate the MENU screen.
Adjust the volume level or mute the sound.

(9) <INPUT> button

Select the input signal. (➡page 40)

(10) <AUTO SETUP> button

Execute the setting of Auto setup in the setting menu.

Rear terminals

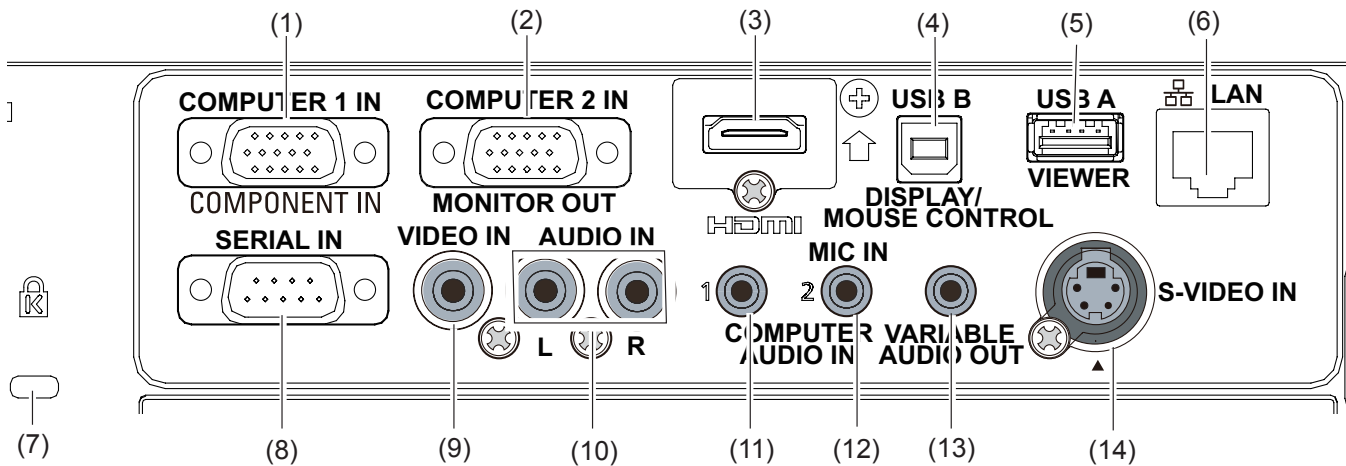

(1) COMPUTER 1 IN/ COMPONENT IN

Connect to COMPUTER 1 IN/ COMPONENT IN input signals.

(2) COMPUTER 2 IN/ MONITOR OUT

Connect to COMPUTER 2 IN/ MONITOR OUT input signals or outputs the analog RGB signals input to the projector.

(3) HDMI

Connect to HDMI input signals.

(4) USB Connector (Series B)

- In order to operate the computer with the remote control and use the <PAGE UP/DOWN> buttons on the remote control during a presentation, connect the USB port of the computer to the USB terminal with a USB cable (not supplied).
- The projector provides the "USB display" function that the image and sound are sent to the projector by connecting the computer to the projector with a USB cable.

For details, please refer to the "Operation Manual Wireless Manager ME6.0" in CD-ROM.

(5) USB Connector (Series A)

Insert the USB thumb drive directly (➡ page 90).

(6) LAN

Connect to a LAN cable for network connection.

(7) Security slot

Attach the commercial shackle lock, manufactured by Kensington, to protect your projector. Compatible with the Kensington MicroSaver Security System.

(8) SERIAL IN

Connect to a computer via an RS-232C cable.

(9) VIDEO IN

Connect to VIDEO input signals.

(10) AUDIO IN

Connect to the audio input signals. AUDIO IN has left and right (L and R) terminals.

(11) COMPUTER AUDIO IN 1

Connect to the audio input signals.

(12) COMPUTER AUDIO IN 2 (MIC IN)

Connect to the audio input signals. Or connect the MIC to this jack.

(13) VARIABLE AUDIO OUT

Output the audio signals input to the projector.

(14) S-VIDEO IN

Connect to S-VIDEO input signals.

Attention

- When a LAN cable is directly connected to the projector, the network connection must be made indoors.

Using Remote control

Installing and Removing batteries

1) Open the cover

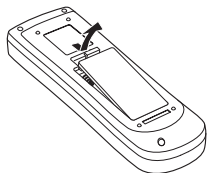

2) Install batteries and close the cover (Insert the – side first.)

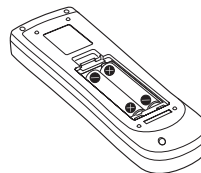

- Remove the batteries in the reverse order of installation.

Setting Remote control ID numbers

When you use the system with multiple projectors, you can operate all the projectors simultaneously or each projector individually using single remote control, if unique ID number is assigned to each projector. After setting the ID number of the projector, set the same ID number to the remote control. There are 7 different ID codes (ALL, Code 1~Code 6), the initial ID number is [ALL].

■ Setting the ID number

- 1) While holding down the <MENU> button, press the Number Buttons, the number you press the Number buttons corresponds to the desired ID code number.
- 2) The number you press the number buttons is as follows: Code 1= <1 MUTE>, Code 2= <2 D.ZOOM +>, Code 3= <3 VIDEO>, Code 4= <4 FREEZE>, Code 5= <5 D.ZOOM ->, Code 6= <6 S-VIDEO>.

■ Resetting the ID number

- 1) The ID code is reset to [ALL] (default) by pressing the <MENU> button and <0 LAMP> button at the same time for 5 seconds or more.

Note

- For details, please refer to the [Remote control] of the [Setting] menu. (➡page 62)

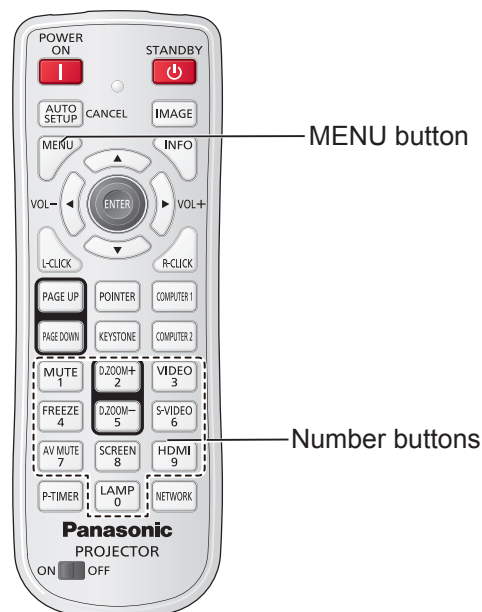

Setting up

Projection method

You can use the projector with any of the following 4 projection methods. To set the desired method in the projector.

■ Setting on a desk/floor and projecting forward

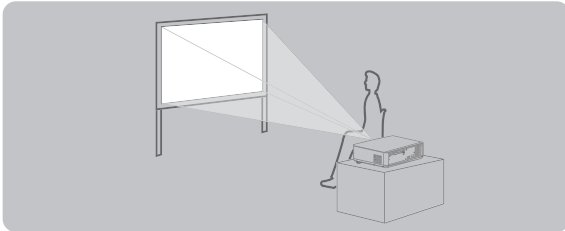

Menu setting*1

Ceiling	Off
Rear	Off

■ Mounting on the ceiling and projecting forward

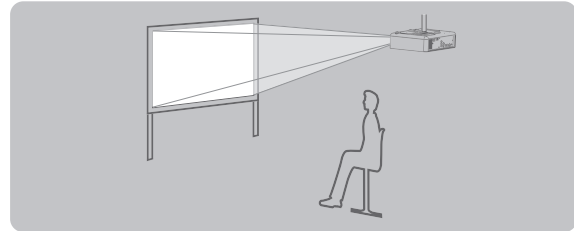

Menu setting*1

Ceiling	On
Rear	Off

■ Mounting on the ceiling and projecting from rear

(Using translucent screen)

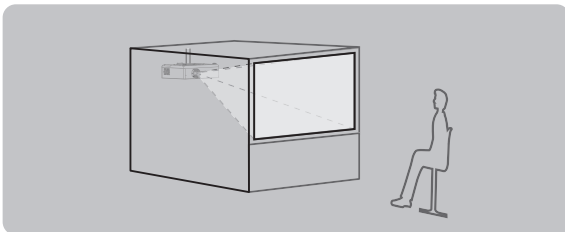

Menu setting*1

Ceiling	On
Rear	On

■ Setting on a desk/floor and projecting from rear

(Using translucent screen)

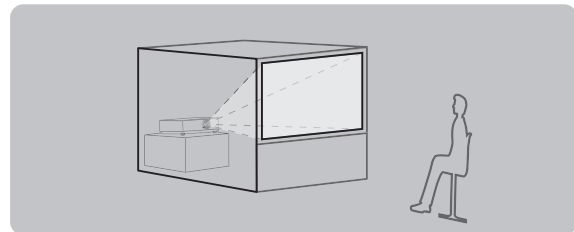

Menu setting*1

Ceiling	Off
Rear	On

*1 : For details about the menu setting, please refer to the [Screen] menu → [Ceiling] and [Rear]. (➔page 56)

Parts for ceiling mount (Optional)

You can install the projector on the ceiling by using the optional ceiling mount bracket (ET-PKV100H: for high ceiling, ET-PKV100S: for low ceiling), and the optional projector mount base ET-PKV200B.

- Use only the ceiling mount brackets specified for this projector.
- Refer to the installation manual for the ceiling mount bracket when you install the bracket and the projector.

Attention

- To ensure projector performance and security, installation of the ceiling mount bracket must be carried by your dealer or a qualified technician.

Setting up

Screen size and throw distance

Place the projector referring to the diagram on the right and the figures of throwing distance. You can adjust the display size.

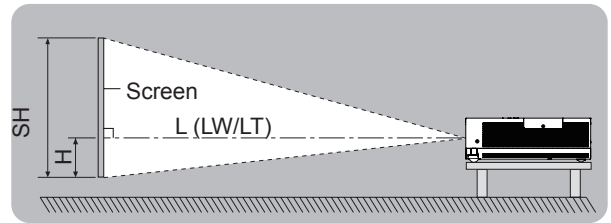
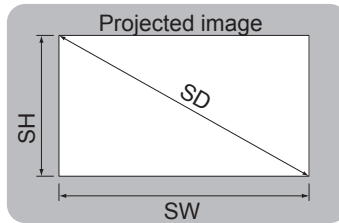

L (LW/LT) *1	Projection distance (m)
SH	Height of the projection area (m)
SW	Width of the projection area (m)
H	Distance from the center of lens to the image lower end (m)
SD	Diagonal length of the projection area (m)

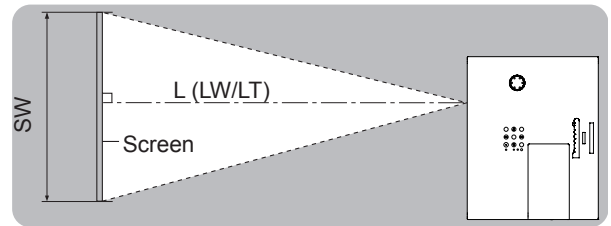

*1 : LW : Minimum distance
LT : Maximum distance

Attention

- Before installing, please read "Precautions for Use" (➡ pages 14 to 20).

■ Projection distance for PT-VW435NEA

All measurements below are approximate and may differ slightly from the actual measurements. (Unit: m)

Projection size	For 4:3 aspect ratio			For 16:9 aspect ratio			For 16:10 aspect ratio		
	Screen diagonal (SD)	Minimum distance (LW)	Maximum distance (LT)	Height position (H)	Minimum distance (LW)	Maximum distance (LT)	Height position (H)	Minimum distance (LW)	Maximum distance (LT)
30"	0.8	1.4	0.009~0.229	0.8	1.3	0.007~0.187	0.7	1.2	0.008~0.202
40"	1.1	1.8	0.012~0.305	1.0	1.7	0.010~0.249	1.0	1.6	0.011~0.269
50"	1.4	2.3	0.015~0.381	1.3	2.1	0.012~0.311	1.3	2.0	0.013~0.337
60"	1.7	2.8	0.018~0.457	1.6	2.5	0.015~0.374	1.5	2.5	0.016~0.404
70"	2.0	3.3	0.021~0.533	1.8	3.0	0.017~0.436	1.8	2.9	0.019~0.471
80"	2.3	3.7	0.024~0.610	2.1	3.4	0.020~0.498	2.0	3.3	0.022~0.538
90"	2.6	4.2	0.027~0.686	2.3	3.8	0.022~0.560	2.3	3.7	0.024~0.606
100"	2.9	4.7	0.030~0.762	2.6	4.2	0.025~0.623	2.5	4.1	0.027~0.673
120"	3.5	5.6	0.037~0.914	3.1	5.1	0.030~0.747	3.1	4.9	0.032~0.808
150"	4.3	7.0	0.046~1.143	3.9	6.4	0.037~0.934	3.8	6.2	0.040~1.010
200"	5.8	9.4	0.061~1.524	5.3	8.5	0.050~1.245	5.1	8.3	0.054~1.346
250"	7.3	11.7	0.076~1.905	6.6	10.6	0.062~1.557	6.4	10.3	0.067~1.683
300"	8.7	14.0	0.091~2.286	7.9	12.7	0.075~1.868	7.7	12.4	0.081~2.019

Any other projection distance can be obtained according to the screen dimensions (m) using the following calculations.

The calculated distance may contain a certain error.

If the screen dimensions are written as "SD",

	For 4:3 aspect ratio	For 16:9 aspect ratio	For 16:10 aspect ratio
Screen height (SH)	= SD(m) × 0.6	= SD(m) × 0.490	= SD(m) × 0.530
Screen width (SW)	= SD(m) × 0.8	= SD(m) × 0.872	= SD(m) × 0.848
Minimum distance (LW)	= 0.11461 × SD(m) - 0.02936	= 0.10402 × SD(m) - 0.02936	= 0.10122 × SD(m) - 0.02936
Maximum distance (LT)	= 0.18465 × SD(m) - 0.03190	= 0.16764 × SD(m) - 0.03190	= 0.16311 × SD(m) - 0.03190

■ Projection distance for PT-VX505NEA

All measurements below are approximate and may differ slightly from the actual measurements. (Unit: m)

Projection size	For 4:3 aspect ratio			For 16:9 aspect ratio		
	Minimum distance (LW)	Maximum distance (LT)	Height position (H)	Minimum distance (LW)	Maximum distance (LT)	Height position (H)
30"	0.7	1.1	0.046~0.229	0.8	1.3	0.037~0.187
40"	0.9	1.5	0.061~0.305	1.0	1.7	0.050~0.249
50"	1.2	1.9	0.076~0.381	1.3	2.1	0.062~0.311
60"	1.4	2.3	0.091~0.457	1.6	2.5	0.075~0.374
70"	1.7	2.7	0.107~0.533	1.8	3.0	0.087~0.436
80"	1.9	3.1	0.122~0.610	2.1	3.4	0.100~0.498
90"	2.2	3.5	0.137~0.686	2.4	3.8	0.112~0.560
100"	2.4	3.9	0.152~0.762	2.6	4.2	0.125~0.623
120"	2.9	4.7	0.183~0.914	3.1	5.1	0.149~0.747
150"	3.6	5.8	0.229~1.143	3.9	6.4	0.187~0.934
200"	4.8	7.8	0.305~1.524	5.3	8.5	0.249~1.245
250"	6.0	9.7	0.381~1.905	6.6	10.6	0.311~1.557
300"	7.3	11.7	0.457~2.286	7.9	12.7	0.374~1.868

Any other projection distance can be obtained according to the screen dimensions (m) using the following calculations.

The calculated distance may contain a certain error.

If the screen dimensions are written as "SD",

	For 4:3 aspect ratio	For 16:9 aspect ratio
Screen height (SH)	= SD(m) × 0.6	= SD(m) × 0.490
Screen width (SW)	= SD(m) × 0.8	= SD(m) × 0.872
Minimum distance (LW)	= 0.09547 × SD(m) - 0.02937	= 0.10402 × SD(m) - 0.02937
Maximum distance (LT)	= 0.15390 × SD(m) - 0.03189	= 0.16768 × SD(m) - 0.03189

Setting up

Adjusting front adjustable feet

Lift the front of the projector and press the feet lock latches on both side of the projector. Release the feet lock latches to lock the adjustable feet and rotate the adjustable feet to a proper height and tilt. You can turn the front adjustable feet to extend them. You can turn them in the opposite direction to contract them.

(You can adjust the projection angle vertically.)

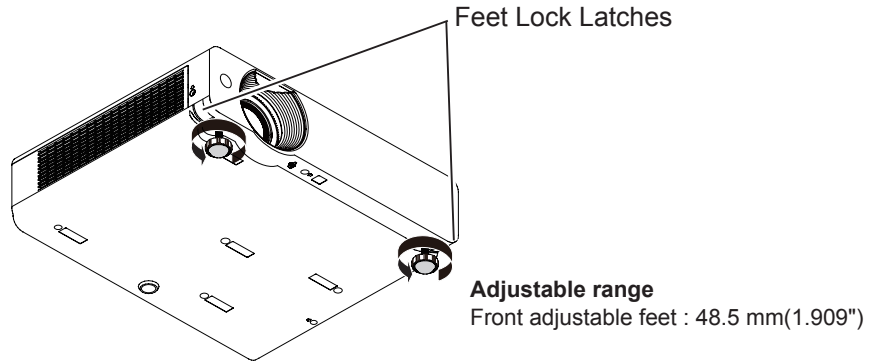

Attention

- Heated air comes out of the air exhaust port while the lamp is lit. Do not touch the air exhaust port directly when you adjust the front adjustable feet.
- If keystone distortion occurs on the projected image, perform "KEYSTONE" from the "Screen" menu. (▶ page 55)

Note

- Screw up the adjustable feet, and an audible click will be heard as the limit.

Adjusting the position using the vertical lens shift function

If the projector is not positioned right in front of the center of the screen, you can adjust the vertical position of projected image by moving the vertical lens shift ring within the shift range of the lens.

1) Lens shift adjustment for PT-VX505NEA

The display position can be shifted upward up to 40% elevation of the display. (When turn the vertical lens shift ring to the right (left), the display moves up (down)).

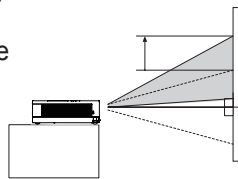

Lens shift adjustable range

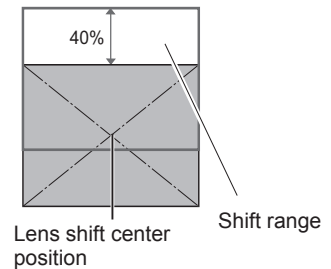

2) Lens shift adjustment for PT-VW435NEA

The display position can be shifted upward up to 48% elevation of the display. (When turn the vertical lens shift ring to the right (left), the display moves up (down)).

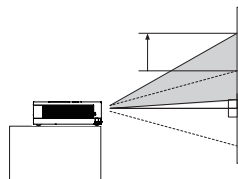

Lens shift adjustable range

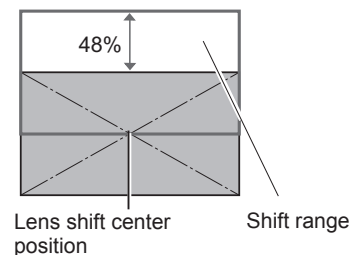

Attention

Please note the followings when using the projector.

- Do not touch the lens while it is moving as this could cause injury to the fingers.
- Never allow children to touch the lens.

Connections

Before connecting to the projector

- Read carefully the instruction manual for the device to be connected.
- Turn off the power switch of the devices before connecting cables.
- If any connection cable is not supplied with the device, or if no optional cable is available for connection of the device, prepare a necessary system connection cable to suit the device.
- Video signals containing too much jitter may cause the images on the screen to randomly wobble or wafure. In this case, a time base corrector (TBC) must be connected.
- The projector accepts the following signals: VIDEO, S-VIDEO, analogue-RGB (with TTL sync. Level) and digital signal.
- Some computer models are not compatible with the projector.
- When using long cables to connect with each of equipment to the projector, there is a possibility that the image will not be output correctly unless a compensator is used.
- For details on what video signals the projector supports, see "List of compatible signals". (▶page 110-113)

Connecting example

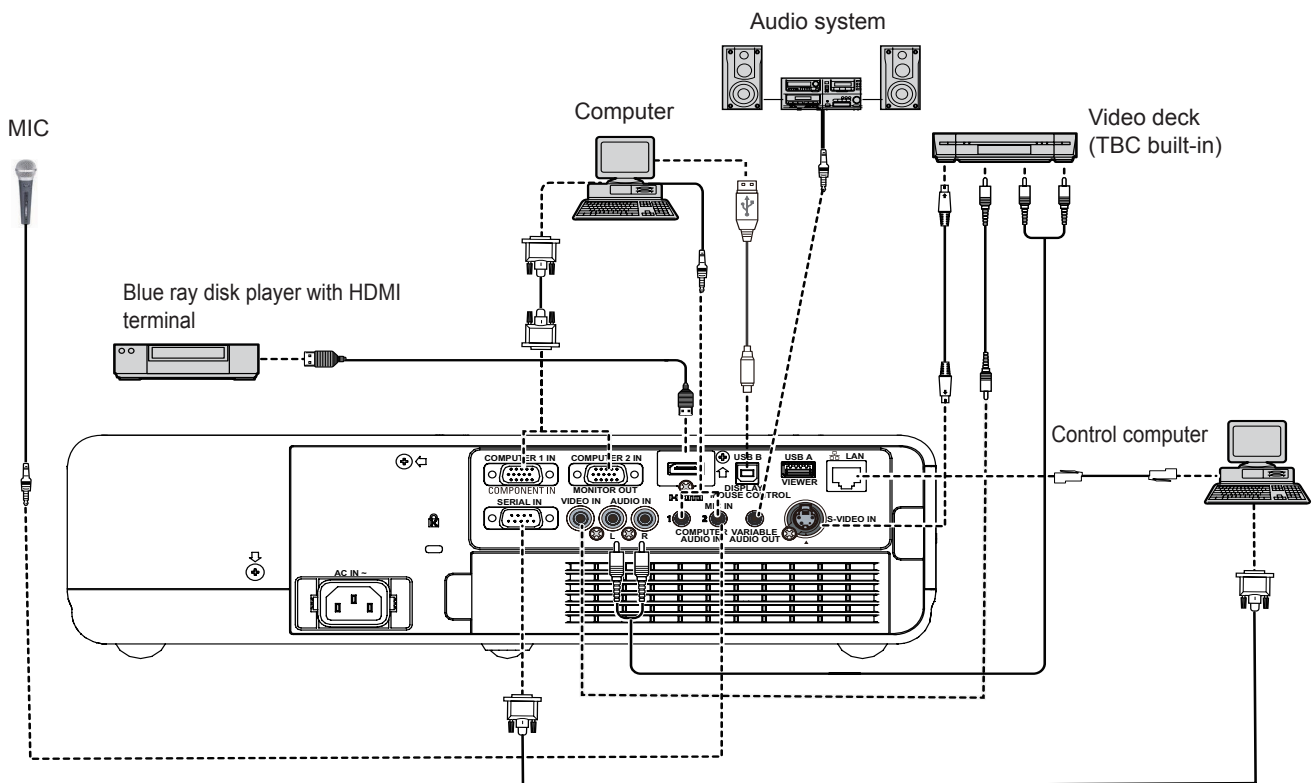

Attention

- When connecting with a video deck, be sure to use the one with a built-in time base corrector (TBC) or use a TBC between the projector and the video deck.
- If nonstandard burst signals are connected, the image may be distorted. If this is the case, connect a TBC between the projector and the video deck.

Note

- When using an HDMI cable, check that it is compliant with the HDMI standard. Using a cable that is not compliant with the HDMI standard may result in problems such as the image cutting out or not appearing. When connecting the 1 080p signal using HDMI, use a cable compliant with 1 080p signal.
- This projector does not support the Viera link (HDMI).
- For the specifications of the RGB signals that can be applied from the PC, refer to "List of compatible signals". (▶page 110-113)
- The details of wired LAN and wireless communication between the projector and computer, please see "Network". (▶page 67-93)

Powering ON/OFF

Connecting the power cord

Be sure to insert the attached power cord securely to its base to prevent it from coming off.

■ Power cord holder

A power cord holder is designed to prevent the AC power cord from coming off the projector. Please insert the power cord into the power cord holder correctly as Picture (1) shown:

AC Power cord holder

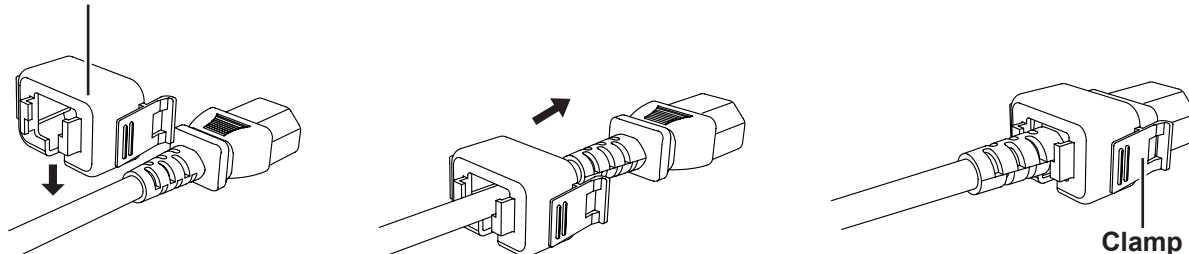

Picture (1)

■ Attaching

Attach the AC power cord with the power cord clamp to the projector as follows:

Press the clamp on its sides, and then insert the AC power cord with the power cord clamp securely to the projector as Picture (2) shown. It is correctly attached until you hear the "CLICK" sound. See Picture (3) for correct attachment.

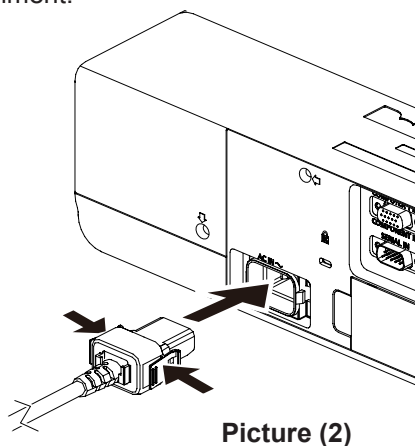

Picture (2)

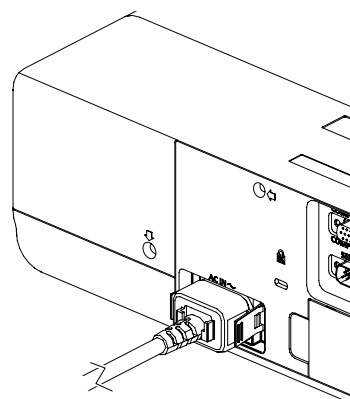

Picture (3)

■ Removal

Remove the AC power cord from the electrical outlet while pressing the clamp on its sides.

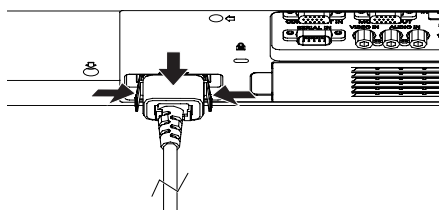

ON(G)/STANDBY(R) indicator

The power indicator informs you the status of the power. Confirm the status of the <ON(G)/STANDBY(R)> indicator before operating the projector.

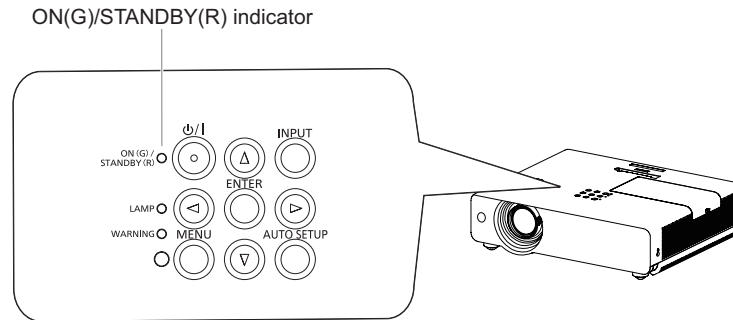

Indicator status		Status
No illumination or flashing		The power cord is unplugged.
RED	Lit	The power cord is plugged.
		The projector is in stand-by mode, after the cooling is completed.
ORANGE	Flashing	The projector is cooling down. The projector cannot be turned on until cooling is completed and the <ON(G)/STANDBY(R)> indicator stops blinking.
		The temperature inside the projector is abnormally high. And the <WARNING> indicator also blinks in red (➡ page 94). The projector cannot be turned on until cooling is completed and the <ON(G)/STANDBY(R)> indicator stops blinking.
GREEN	Lit	Projecting.
	Flashing	The projector is in stand-by status with [Power management] function. The projection lamp will be turned on if the input signal is reconnected or any button on the control panel or remote control is pressed. (➡ page 61)

Powering ON/OFF

Turning On the Projector

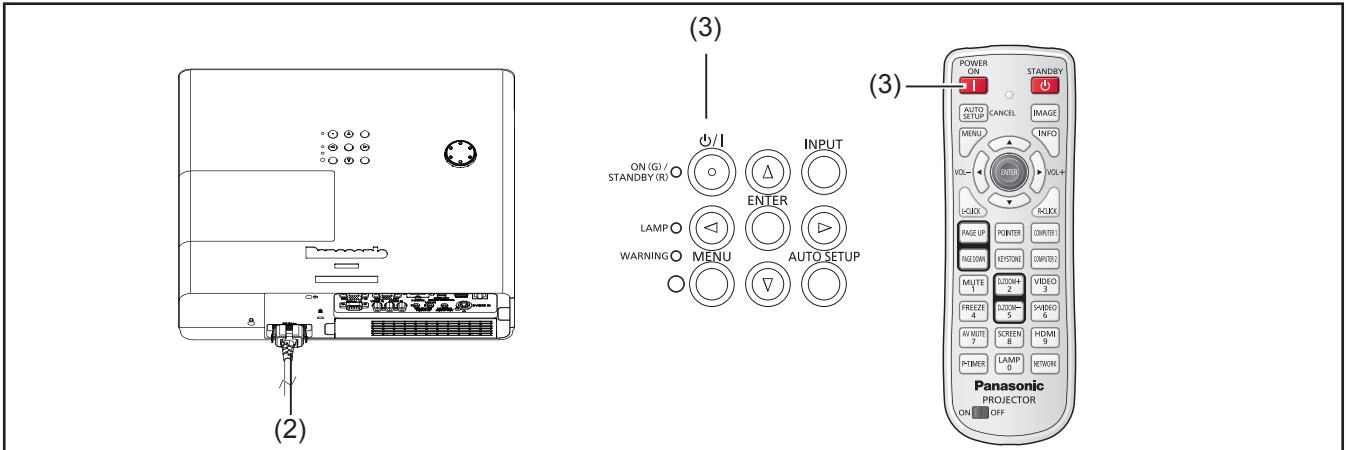

- 1) Complete peripheral connections (with a computer, VCR, etc.) before turning on the projector.
- 2) Connect the projector's AC power cord into an AC outlet. The <ON(G)/STANDBY(R)> indicator lights red. Open the lens cap.
- 3) Press the <POWER ON> button on the control panel or the <POWER ON> button on the remote control. The <ON(G)/STANDBY(R)> indicator lights green and the cooling fans start to operate. The preparation display appears on the screen and the count down starts.
- 4) After the countdown, the Input guide (include the latest input source, lamp power status and network information) appears on the screen.
- 5) If there is no signal input when start on the projector, or the current signal is missed while operating the projector, the Video/Computer selection window will be displayed on the screen, please move the pointer to input source desired by pressing the ▲▼ and the <ENTER> button. And then follow the input signal guidance window to correct the signal and connection.

If the projector is locked with a PIN code, PIN code input dialog box will appear. Enter the PIN code as instructed on the next page.

Note

- When the [Logo select] function is set to [Off], the logo will not be shown on the screen (➡ page 59).
- When [Countdown off] or [Off] is selected in the [Display] function, the preparation display will not be shown on the screen (➡ page 59).
- When the [Input search] function is set to [On 2], the input signal will be searched automatically (➡ page 58).
- When the [Direct on] function is set to [On], the projector will be turned on automatically by connecting the AC power cord to an AC outlet.

Preparation Screen

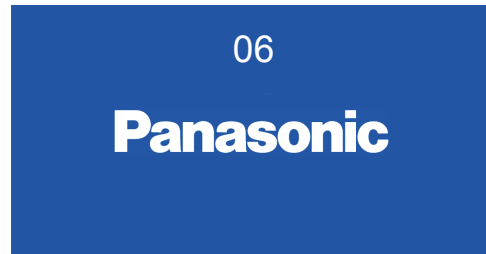

The preparation display will disappear after 30 seconds.

Input Guide

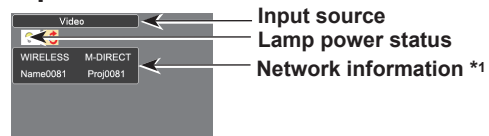

*1 Please refer to [Verifying the network information] (➡ page 67).

Video/Computer selection

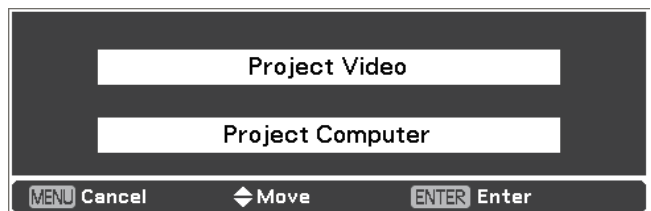

Enter a PIN code

When using the top control

Press ▲ ▼ to enter a number. Press ► to fix the number and move the red frame pointer to the next box. The number changes to *. If you fixed an incorrect number, use the ◀ button to move the pointer to the number you want to correct, and then enter the correct number.

Repeat this step to complete entering a four-digit number.

After entering the four-digit number, move the pointer to “Set”. Press the <ENTER> button so that you can start to operate the projector.

When using the remote control

Press the Number buttons on the remote control to enter a number (➡ page 21). When you complete entering a four-digit number, the pointer moves to “Set”. Press the <ENTER> button so that you can start to operate the projector.

If you fix an incorrect number, use the ◀ button to move the pointer to the number you want to correct, and then enter the correct number.

If you entered an incorrect PIN code, PIN code and the number (****) will turn red for a moment. Enter the correct PIN code all over again.

Note

- If the PIN code number is not entered or wrong PIN code number is entered within three minutes after the PIN code dialog box appeared, the projector will be turned off automatically.
- The “1234” is set as the initial PIN code at the factory.

PIN Code Input Dialog Box

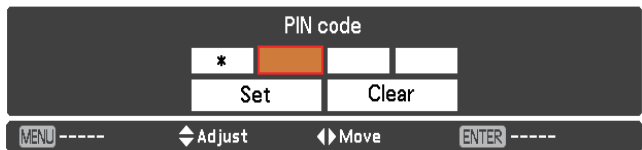

After the OK icon disappears, you can operate the projector.



Powering ON/OFF

Turning Off the Projector

- 1) Press the <⏻/|> button on the control panel or the <STANDBY> button on the remote control, and **Power off?** appears on the screen.
- 2) Press the <⏻/|> button on the control panel or the <STANDBY> button on the remote control again to turn off the projector. The <ON(G)/STANDBY(R)> indicator starts to blink orange, and the cooling fans keep running. At this time, you can unplug the AC power cord even if the fans are still running.
- 3) When the projector has cooled down enough, the <ON(G)/STANDBY(R)> indicator stops blinking and you can turn on the projector.

Power off ?

Power off? disappears after 4 seconds.

Note

- Do not put the projector in a case before the projector is cooled enough.
- While the <ON(G)/STANDBY(R)> indicator is blinking, the lamp is being cooled down and the projector cannot be turned on. Wait until the <ON(G)/STANDBY(R)> indicator stops blinking to turn on the projector again.
- The projector can be turned on after the <ON(G)/STANDBY(R)> indicator turns red. The waiting time to restart will be shortened when the normal power-off processing for fan cooling is completed, compared with the time the AC power cord is immediately unplugged after the power-off.

■ Direct Power Off function

You can disconnect the power cord from the wall outlet or turn off the breaker even during projection without pressing the <⏻/|> button on the control panel or the <STANDBY> button on the remote control.

Note

- When using the Direct power Off function, you can not restart the projector immediately after the power is disconnected. The lamp remains high temperature and needs to be cooled, so it sometimes takes longer time than usual for the lamp to light up again.

Projecting

Check the connections of the peripheral devices and connection of the power cord (➔page 32) and switch on the power (➔page 34) to start the projector. Select the image and adjust the state of the image.

Selecting the image

Select an input signal.

The image selected with the <COMPUTER 1>, <COMPUTER 2>, <VIDEO>, <S-VIDEO>, <HDMI> or <NETWORK> button is projected (➔page 40).

Attention

- Images may not be projected properly depending on the connected device and DVD, video tape, etc. to be played. Select a system format that is suitable for the input signal in [Component] or [RGB] in the [Input] menu (➔page 45).
- Check the aspect ratio of the screen and the image and select the optimum aspect ratio under the [Screen] menu (➔page 54).

How to adjust the state of the image

1) Adjust the projection angle.

- Place the projector parallel to the screen, and then install it on a flat surface so that the screen becomes rectangle.
- If the screen is tilted lower than the screen, extend the adjustable feet to make a rectangle screen.
- For details, see "Adjusting front adjustable feet" (➔page 30).

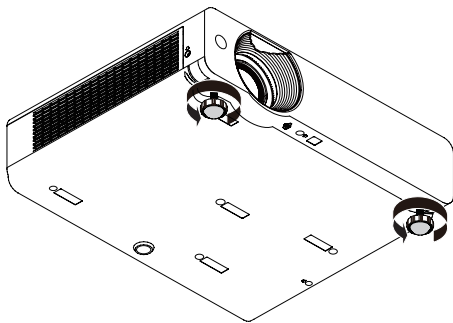

2) Adjust the lens shift.

- Adjust the projection position with the vertical lens shift ring.
- For details, see "Adjusting the position using the vertical lens shift function" (➔page 30).

3) Adjust the zoom and the focus.

Turn [Zoom lever] and [Focus lever] to adjust the image.

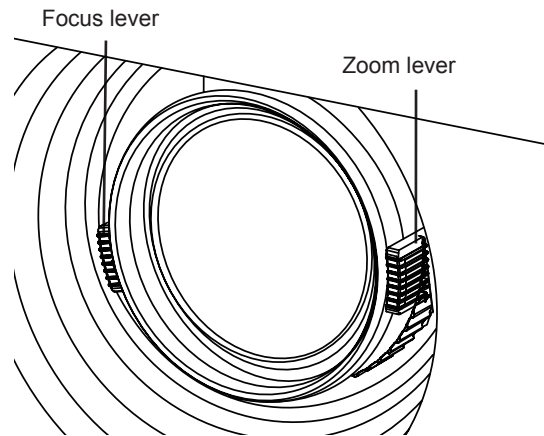

Note

- It is recommended that the images are projected continuously for at least 30 minutes before the focus is adjusted.
- If you adjust the focus, you may need to adjust the size of the image by moving the zoom lever again.
- If keystone distortion occurs, see "KEYSTONE" (➔page 55).

Basic operations by using the remote control



Using the AUTO SETUP function

This function allows you to automatically adjust Input search, Auto Keystone correction and Auto PC adjustment during signal input from a computer.



Press the <AUTO SETUP> button on the remote control.

Note

- For details, see "Setting" of Main menu. (➔page 58)

Using the IMAGE button

This function allows you to select a desired image mode of the screen.



Press <IMAGE> button on the remote control to select the desired image mode among [Dynamic], [Standard], [Real], [Cinema], [Blackboard (Green)], [Colorboard], [Image 1], [Image 2], [Image 3] and [Image 4].

Note

- For details, see "Image select" of Main menu. (➔page 50)

Using the MENU button

This function allows you to open or close the On-Screen Menu.



Press the <MENU> button on the remote control.

Note

- For details, see "Menu Navigation". (➔page 42)

Using the INFO button

This function allows you to display the information menu.



Press <INFO> button on the remote control.

Note

- For details, see "Input Source Information Display" in "Information" under Main menu. (➔page 66)

Controlling the volume of the speaker

You can control the volume of the projector's speaker or audio output.



Press the <VOL -/+> buttons on the control panel or on the remote control to adjust the volume. The volume dialog box appears on the screen for a few seconds.

Note

- For details, see "Volume" of "Sound" under Main menu. (➔page 57)

Basic operations by using the remote control

Using the wireless mouse function

<L-CLICK/R-CLICK> buttons act as left/right mouse button while the projector and a computer are connected with a USB cable, and move the pointer on the screen with <MOUSE CONTROL> button.

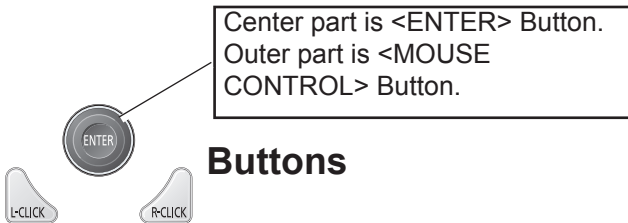

Buttons

Press <MOUSE CONTROL> or <L-CLICK/R-CLICK> buttons on the remote control.

Note

- When using wireless mouse function, please select [Mouse control] in the [USB terminal] first. (➡page 60)
- When a USB cable is connected to the computer and the projector, turn on the projector first, then the computer. If you turn on the computer first, the wireless mouse function may not operate properly.
- When the pointer displays on the screen, you can use the <MOUSE CONTROL> button on the remote control to move the pointer, but can not use it to move the mouse cursor at the same time.

Using the PAGE UP/DOWN buttons

Scroll back and forth the pages on the screen when giving a presentation.



Buttons

Press the <PAGE UP/DOWN> buttons on the remote control.

Note

- To use these buttons, connect the projector and your computer with a USB cable.

Using the POINTER button

Act as the On-Off switch for the Pointer. When the pointer displays on the screen, you can use the <MOUSE CONTROL> button on the remote control to move the pointer.



Button

Press the <POINTER> button on the remote control.

Note

- For details, see "Setting" of Main menu. (➡page 60)

Using the KEYSTONE button

This function allows you to correct keystone distortion.



Button

If a projected picture still has keystone distortion after pressing the <AUTO SETUP> button, correct the image manually as follows:

Press the <KEYSTONE> button on the remote control. The Keystone dialog box appears. Press ▲ ▼ to correct keystone distortion. The keystone adjustment can be stored (➡page 55).

Operation	Screen image
Reduce the upper width with press ▲.	
Reduce the lower width with press ▼.	

Note

- The white arrows indicate that there is no correction.
- A red arrow indicates the direction of correction.
- An arrow disappears at the maximum correction.
- If you press the <KEYSTONE> button on the remote control once more while the keystone dialog box is being displayed, the keystone adjustment will be canceled (➡page 55).
- The adjustable range is limited depending on the input signal.

Basic operations by using the remote control

Switching the input signal

You can switch the input signals to project.



Buttons

Press (<COMPUTER 1>, <COMPUTER 2>, <HDMI>, <VIDEO>, <S-VIDEO>, or <NETWORK>) button on the remote control.

COMPUTER 1	Switch to Computer 1 (RGB)/ Computer 1 (Component)/ Computer 1 (Scart) input.
COMPUTER 2	Switches to Computer 2 (RGB) input.
HDMI	Switches to HDMI input.
VIDEO	Switches to Video input.
S-VIDEO	Switches to S-video input.
NETWORK	Switches to Network input.

Note

- Each press of the <INPUT> button on the Control Panel of the main unit switches the settings as shown below. (➔page 24)

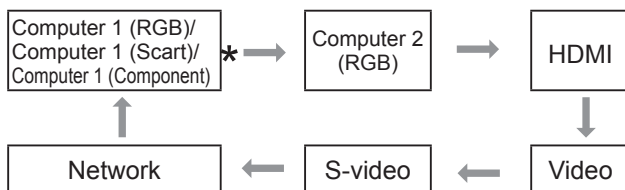

* It depends on the item you selected in the [Computer 1] submenu of the [Input] menu.

Using the MUTE button

Press this button on the remote control to select [On] to temporarily turn off the sound.



Button

Press <MUTE> button on the remote control.

Note

- To turn the sound back on, press this button again or press the <VOL +/-> buttons. (➔page 57)

Using the D.ZOOM +/- buttons

This function allows you to enter to the Digital zoom +/- mode.



Buttons

Press <D.ZOOM +/-> buttons on the remote control.

Note

- For details, see "Screen" of Main menu. (➔page 55)

Using the FREEZE function

You can freeze the projected image and stop the sound temporarily, regardless of the playing condition of the connected device.



Button

Press the <FREEZE> button on the remote control to freeze the picture on the screen, meanwhile, volume is muted. To cancel the Freeze function, press the <FREEZE> button again or press any other button.

Fig.1 will appear on the screen while the Freeze function is working.

Fig.1



Note

- When no signal inputs,  mark will appear.

Basic operations by using the remote control

Using the AV MUTE function

Button

Press the < AV MUTE> button on the remote control to black out the image. To restore to normal, press the < AV MUTE> button again or press any button.

- When the Logo is not set, the screen changes each time you press the < AV MUTE> button as follows.



- The projected Logo (the logo can be set according to users' favorite) is transferred from computer to the projector by "Logo Transfer Software" on the supplied CD-ROM and is set as [User] in the Logo selection (➔page 59), the screen changes each time you press the < AV MUTE> button as follows.



Note

- When use the <MUTE> button to release the [AV mute] function, the mute function can not be operated at the same time.

Using the SCREEN button

This function allows you to select screen mode or change the screen size.

Button

Press the <SCREEN> button on the remote control.

Note

- For details, see "Screen" of Main menu. (➔page 54)

Using the P-TIMER button

Press the <P-TIMER> button on the remote control to operate the [Count up]/[Count down] function.

Button

Press <P-TIMER> button on the remote control.

Note

- To stop the count time, press the <P-TIMER> button. To cancel the [P-timer] function, press and hold the <P-TIMER> button. (➔page 61)

Using the LAMP button

This function allows you to select the lamp mode for changing the brightness on the screen.

Button

Press <LAMP> button on the remote control.

Note

- For details, see "Lamp Power" of "Setting" under Main menu. (➔page 62)

Menu Navigation

Navigating through the menu

Operating procedure

1) Press the <MENU> button.

The Main Menu screen appears.

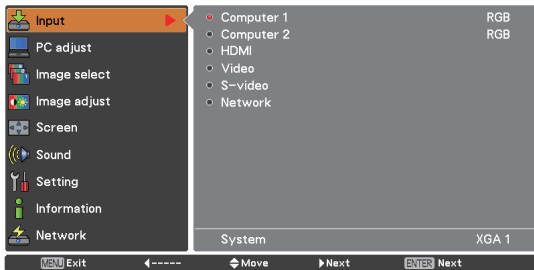

2) Press ▲ ▼ to select the Main Menu item.

Select the desired item from the 9 items: [Input], [PC adjust], [Image select], [Image adjust], [Screen], [Sound], [Setting], [Information] and [Network]. The selected item is highlighted with an orange cursor and the submenu of the selected item appears on the right.

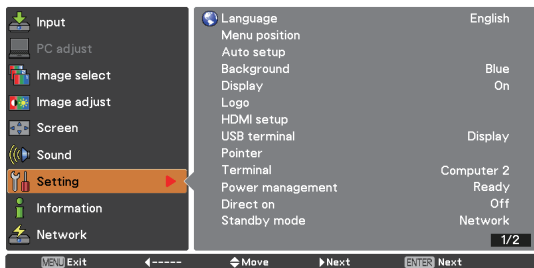

3) Press ► or the <ENTER> button.

The submenu appears so that you can select the sub-menu item.

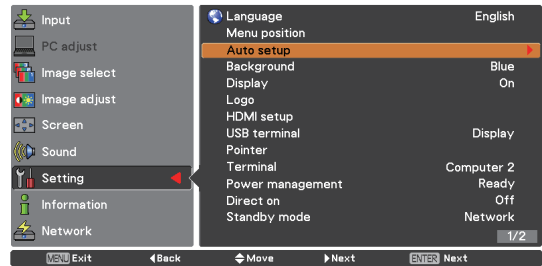

4) Press ▲ ▼ to select the desired sub-menu item.

5) Press the <ENTER> button or press ► to enter the desired item.

6) Press ▲ ▼ ◀ ▶ to set or adjust the parameter values.

7) Press ◀ to return the previous menu. Press the <MENU> button to exit the menu display.









Note

- Some items may not be adjusted or used for certain signal formats input to the projector. The MENU items that cannot be adjusted or used are shown in gray characters, and they cannot be selected.
- Some items can be adjusted even if signals are not input.
- See pages 43 and 44 for details on the items of sub-menu.

Main menu

The main menu consists of the following 9 menu items.

When a main menu item is selected, the screen changes to a submenu selection screen.

	Input
	PC adjust
	Image select
	Image adjust
	Screen
	Sound
	Setting
	Information
	Network

Sub menu

The sub-menu screen of the selected main menu appears, and you can set and adjust the various items in the submenu.

Input []

Sub-menu item	Factory default	Page
Computer 1	RGB	45
Computer 2	RGB	45
HDMI	-	45
Video	-	45
S-video	-	45
Network	-	46

PC adjust []

Sub-menu item	Factory default	Page
AUTO PC adj.	-	47
Fine sync.	-	48
Total dots	-	48
Horizontal	-	48

Sub-menu item	Factory default	Page
Vertical	-	48
Current mode	-	49
Clamp	-	49
Display area H	-	49
Display area V	-	49
Reset	-	49
Mode free	-	49
Store	-	49

Note

- This function will be available when the input source come from computer.

Image select []

Sub-menu item	Factory default	Page
Dynamic	-	50
Standard	-	50
Real	-	50
Cinema	-	50
Blackboard(Green)	-	50
Colorboard	Red	50
Image 1-4	-	50

Image adjust []

Sub-menu item	Factory default	Page
Contrast	32	51
Brightness	32	51
Color* ¹	32	51
Tint* ¹	32	51
Iris	-	51
Color temp.	-	52
Red	32	52
Green	32	52
Blue	32	52
Daylight View	-	52
Sharpness	8	53
Gamma	8	53
Noise reduction* ¹	L 1	53
Progressive* ¹	L 1	53
Reset	-	53
Store	-	53

*1 : When input video signal to the projector, these functions will be available.

Menu Navigation

Screen []

Sub-menu item	Factory default	Page
Normal	-	54
Full	-	54
Wide (16:9)	-	54
Zoom	-	54
True*1	-	54
Natural wide*2	-	54
Custom	-	54
Custom adj.	-	55
Digital zoom +*1	-	55
Digital zoom -*1	-	55
Keystone	Store	55
Ceiling	Off	56
Rear	Off	56
Screen aspect*2	Default(16:10)	56
Reset	-	56

*1 : When input computer signal to the projector, these functions will be available.

*2 : PT-VW435NEA Only.

Sound []

Sub-menu item	Factory Default	Page
Volume	32	57
Mute	Off	57
MIC	Off	57
MIC gain	32	57
Standby MIC out	Off	57

Setting []

Sub-menu item	Factory Default	Page
Language	English	58
Menu position	Center	58
Auto setup	-	58
Background	Blue	59
Display	On	59
Logo	-	59
HDMI setup	-	60
USB terminal	Display	60
Pointer	Spotlight L	60
Terminal	Computer 2	60
Power management	Shutdown	61
Direct on	Off	61
Standby mode	Eco	61
P-timer	Count up	61
Closed caption	Off	62
Lamp power	Normal	62
Remote control	ALL	62

Sub-menu item	Factory Default	Page
Security	-	63
Fan	L 2	63
Fan control	Off	63
Video delay control	Off	64
Filter counter	-	64
Emulate	Default	64
Warning log	-	65
Factory default	-	65

Information []

Sub-menu item	Factory default	Page
Input	-	66
System	-	66
H-sync freq.	-	66
V-sync freq.	-	66
Screen	-	66
Language	-	66
Lamp power	-	66
Lamp runtime	-	66
Power management	-	66
Key lock	-	66
PIN code lock	-	66
Remote control	-	66
Serial number	-	66

Network []

Sub-menu item	Factory default	Page
Wired LAN	-	67
Wireless LAN	-	68
Wireless detailed setup	-	68
Projector name	-	71
Password	Off	72
Network control	On	72
Live mode cut in	-	72
Multi-live	-	72
Network status	-	72
AMX D.D.	Off	73
Room View	Off	73
Memory viewer	-	73
Network factory default	-	73

Input menu

Select [Input] from the Main Menu (see “Navigating through the menu” on page 42), then select the item from the sub-menu.

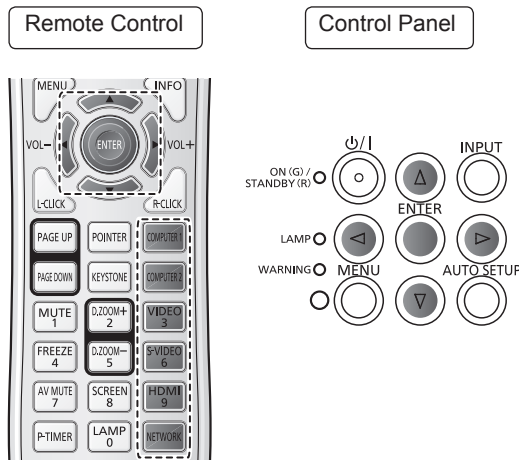

Computer 1: RGB/Component /RGB (Scart)

- 1) Press ▲ ▼ to select [Computer 1].
- 2) Press ► to access the submenu.
- 3) Press ▲ ▼ to select RGB, Component or RGB(Scart) and then press the <ENTER> button.

Computer 2: RGB

Press ▲ ▼ to select [Computer 2 (RGB)] and then press the <ENTER> button.

■ Computer System Selection

This projector automatically tunes to various types of computers with its Multi-scan system and Auto PC Adjustment. If a computer is selected as a signal source, this projector automatically detects the signal format and tunes to project a proper image without any additional settings. (Signal formats provided in this projector are shown on pages 110-113.)

AUTO When the projector can not recognize the connected signal conforming to the provided PC Systems, [Auto] is displayed on the System Menu box and the Auto PC adjustment function works to display proper images. If the image is not projected properly, a manual adjustment is required.

---- There is no signal input from the computer. Check the connection between your computer and the projector.

Mode 1 The preset system is manually adjusted in the PC adjust Menu. The adjusted data can be stored in Mode 1-10.

SVGA 1 PC Systems provided in this projector is chosen. The projector chooses a proper system provided in the projector and displays it.

* Mode 1 and SVGA 1 are examples.

- 1) Press ▲ ▼ to select [System].
- 2) Press ► or the <ENTER> button to access the submenu.
- 3) Press ▲ ▼ to select the desired system.

HDMI

Press ▲ ▼ to select [HDMI] and then press the <ENTER> button.

Video

Press ▲ ▼ to select [Video] and then press the <ENTER> button.

S-video

Press ▲ ▼ to select [S-video] and then press the <ENTER> button.

■ Video System Selection

Video or S-video

Auto

The projector automatically detects an incoming video system, and adjusts itself to optimize its performance. When Video System is [PAL-M] or [PAL-N], select the system manually.

PAL/SECAM/NTSC/NTSC.4.43/PAL-M/PAL-N

If the projector cannot reproduce proper video image, select a specific broadcast signal format from among [PAL], [SECAM], [NTSC], [NTSC 4.43], [PAL-M] and [PAL-N].

Input menu

Component

Auto

The projector automatically detects an incoming video signal, and adjusts itself to optimize its performance.

COMPONENT VIDEO SIGNAL FORMAT

If the projector cannot reproduce proper video image, select a specific component video signal format among [480i], [576i], [480p], [576p], [720p], [1 035i] and [1 080i].

- 1) Press ▲ ▼ to select [System].
- 2) Press ► or the <ENTER> button to access the submenu.
- 3) Press ▲ ▼ to select the desired system.

Note

- When the [Input Search] function is set to [On 1] or [On 2] in the [Auto setup] function, the input signal will be searched automatically.
- The AV System Menu cannot be selected when selecting [RGB (Scart)].

Network

Press ▲ ▼ to select [Network] and then press the <ENTER> button.

Note

- For details please refer to Network operations on page 67-93.

AUTO PC adjust

Select [PC adjust] from the Main Menu (see “Navigating through the menu” on page 42), then select the item from the sub-menu.

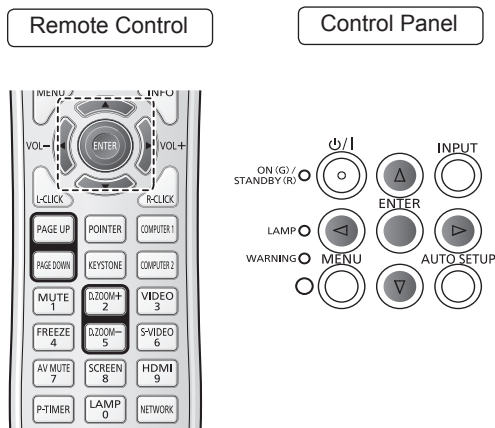

Auto PC adj.

Auto PC adjustment function is provided to automatically adjust Fine sync, Total dots, Horizontal and Vertical positions to conform to your computer.

Press **▲ ▼** to select [Auto PC adj.] and then press the **<ENTER>** button.

- **Please wait...** appears while the Auto PC adjustment is in process.

To store adjustment parameters

The adjusted parameters from the Auto PC adjustment can be stored in the projector. Once the parameters are stored, the setting can be done just by selecting a Mode (1–10) in the PC System Menu (see page 45). See also [Store] on page 49.

Attention

- [Fine sync], [Total dots], [Horizontal] and [Vertical] position of some computers cannot be fully adjusted with the Auto PC adjustment function. When the image is not provided properly with this operation, manual adjustments are required (➔ pages 48–49).
- The Auto PC adjustment cannot be operated when [480i], [576i], [480p], [576p], [720p], [1 035i] or [1 080i] is selected in the PC System Menu (➔ page 45), or when the signal is coming from the HDMI terminal.

Manual PC adjust

Select [PC adjust] from the Main Menu (see "Navigating through the menu" on page 42), then select the item from the sub-menu.

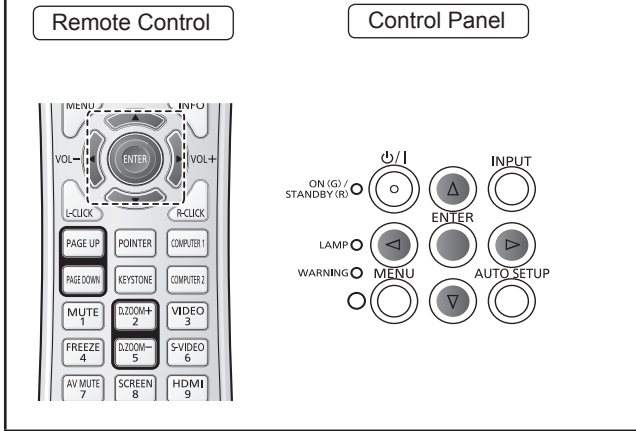

Some computers employ special signal formats which may not be tuned by Multi-scan system of this projector. Manual PC adjustment enables you to precisely adjust several parameters to match those signal formats. The projector has 10 independent memory areas to store those parameters manually adjusted. It allows you to recall the setting for a specific computer.

Fine sync

- 1) Press ▲ ▼ to select [Fine sync].
- 2) Press the <ENTER> button to display the adjustment dialog box.
- 3) Press ◀ ▶ to adjust the value.
 - The value can be adjusted from 0 to 31.

Total dots

- 1) Press ▲ ▼ to select [Total dots].
- 2) Press the <ENTER> button to display the adjustment dialog box.
- 3) Press ◀ ▶ to adjust the value.

Horizontal

- 1) Press ▲ ▼ to select [Horizontal].
- 2) Press the <ENTER> button to display the adjustment dialog box.
- 3) Press ◀ ▶ to adjust the horizontal picture position.

■ For horizontal (right and left) adjustment

Operation	Adjustment
Press ◀.	The picture position moves to the right.
Press ▶.	The picture position moves to the left.

Vertical

- 1) Press ▲ ▼ to select [Vertical].
- 2) Press the <ENTER> button to display the adjustment dialog box.
- 3) Press ◀ ▶ to adjust the vertical picture position.

■ For vertical (up and down) adjustment

Operation	Adjustment
Press ▶.	The picture position moves up.
Press ◀.	The picture position moves down.

Current mode

- 1) Press ▲▼ to select [Current mode].
- 2) Press ► or the <ENTER> button to enter the next submenu to show H-sync freq. and V-sync freq. of the connected computer.

Clamp

- 1) Press ▲▼ to select [Clamp].
- 2) Press the <ENTER> button to display the adjustment dialog box.
- 3) Press ◀▶ to adjust the clamp level.
 - When the image has dark bars, try this adjustment.

Display area H

- 1) Press ▲▼ to select [Display area H].
- 2) Press the <ENTER> button to display the adjustment dialog box.
- 3) Press ◀▶ to adjust the horizontal area displayed by this projector.

Display area V

- 1) Press ▲▼ to select [Display area V].
- 2) Press the <ENTER> button to display the dialog box.
- 3) Press ◀▶ to adjust the vertical area displayed by this projector.

Reset

To reset the adjusted data, all adjustments will return to their previous figures.

- 1) Press ▲▼ to select [Reset].
- 2) Press the <ENTER> button.
 - A confirmation box appears and then select [Yes].

Mode free

- 1) Press ▲▼ to select [Mode free].
- 2) Press ► or the <ENTER> button to enter the next submenu.
 - Move the highlight to the mode that you want to clear and then press the <ENTER> button.
 - A confirmation box appears and then select [Yes].

Store

- 1) Press ▲▼ to select [Store].
- 2) Press ► or the <ENTER> button to enter the next submenu.
 - Move the highlight to one of the Modes 1 to 10 in which you want to store, and then press the <ENTER> button.
 - A confirmation box appears and then select [Yes].

Image select

Select [Image select] from the Main Menu (see “Navigating through the menu” on page 42), then select the item from the sub-menu.

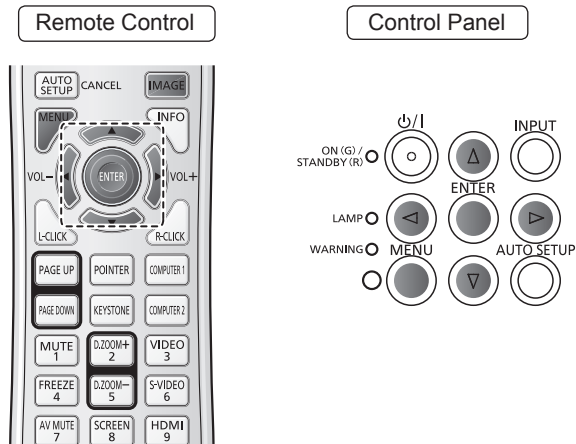

Dynamic

For viewing pictures in a bright room.

Press ▲ ▼ to select [Dynamic] and then press the <ENTER> button.

Standard

Normal picture mode preset on the projector.

Press ▲ ▼ to select [Standard] and then press the <ENTER> button.

Real

Picture mode with improved halftone for graphics.

Press ▲ ▼ to select [Real] and then press the <ENTER> button.

Cinema

Picture mode adjusted with fine tone.

Press ▲ ▼ to select [Cinema] and then press the <ENTER> button.

Blackboard(Green)

For the image projected on a blackboard.

Press ▲ ▼ to select [Blackboard(Green)] and then press the <ENTER> button.

- This mode helps enhance the image projected on a blackboard. This is mainly effective on a green colored board, not truly effective on a black colored board.

Colorboard

For the image projected on a colorboard.

- 1) **Press ▲ ▼ to select [Colorboard].**
- 2) **Press ► or the <ENTER> button to display the submenu.**
- 3) **Press ▲ ▼ to select a color, and press the <ENTER> button.**

- At the time of simple projection on the colored wall, you can get the close color image to the color image projected on a white screen by selecting the similar color to the wall color from the preset four colors (Red, Blue, Yellow and Green).

Image 1-4

For viewing with the user preset image mode in the Image adjust Menu. This Image memory is provided in each computer, component and video input source.

Press ▲ ▼ to select [Image 1-4] and then press the <ENTER> button.

Image adjust

Select [Image adjust] from the Main Menu (see “Navigating through the menu” on page 42), then select the item from the sub-menu.

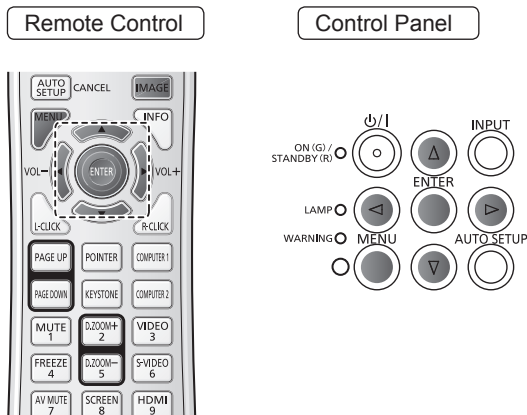

Note

- Make sure you selected [Store] after adjusting settings. Some settings can not be stored if not registered with [Store] function

Contrast

- 1) Press ▲▼ to select [Contrast].
- 2) Press the <ENTER> button to display the adjustment dialog box.
- 3) Press ◀▶ to adjust the setting value.

Operation	Adjustment	Adjustment range
Press ▶.	increase the contrast	Maximum value 63
Press ◀.	decrease the contrast	Minimum value 0

Brightness

- 1) Press ▲▼ to select [Brightness].
- 2) Press the <ENTER> button to display the adjustment dialog box.
- 3) Press ◀▶ to adjust the setting value.

Operation	Adjustment	Adjustment range
Press ▶.	increase the brightness	Maximum value 63
Press ◀.	decrease the brightness	Minimum value 0

Color

- 1) Press ▲▼ to select [Color].
- 2) Press the <ENTER> button to display the adjustment dialog box.
- 3) Press ◀▶ to adjust the setting value.

Operation	Adjustment	Adjustment range
Press ▶.	increase the intensity of the color	Maximum value 63
Press ◀.	decrease the intensity of the color	Minimum value 0

Note

- When input video signal to the projector, [Color] will be available.

Tint

- 1) Press ▲▼ to select [Tint].
- 2) Press the <ENTER> button to display the adjustment dialog box.
- 3) Press ◀▶ to adjust the tint value to get a proper color balance.
 - Adjustments can be made between 0 and 63.

Note

- When you select [NTSC] or [NTSC4.43] in System menu under Video input signal, [Tint] will be available.

Iris

- 1) Press ▲▼ to select [Iris].
- 2) Press the <ENTER> button to display the adjustment dialog box.
- 3) Press ◀▶ to select [Off] or [On].

Off	Disabled
On	Contrast is prioritized over brightness

Image adjust

Color temp.

- 1) Press ▲ ▼ to select [Color temp.].
- 2) Press the <ENTER> button to display the adjustment dialog box.
- 3) Press ◀ ▶ to select the desired Color temp. level.
 - You can select the desired [Color temp.] from [XLow], [Low], [Mid] or [High].

Note

- [Color temp.] level displays [Blackbord] or [Colorboard] when the [Blackboard(Green)] or [Colorboard] is selected in the [Image select] menu.

Red

- 1) Press ▲ ▼ to select [Red].
- 2) Press the <ENTER> button to display the adjustment dialog box.
- 3) Press ◀ ▶ to adjust the setting value.

Operation	Adjustment	Adjustment range
Press ▶.	deepen red tone	Maximum value 63
Press ◀.	lighten red tone	Minimum value 0

Green

- 1) Press ▲ ▼ to select [Green].
- 2) Press the <ENTER> button to display the adjustment dialog box.
- 3) Press ◀ ▶ to adjust the setting value.

Operation	Adjustment	Adjustment range
Press ▶.	deepen green tone	Maximum value 63
Press ◀.	lighten green tone	Minimum value 0

Blue

- 1) Press ▲ ▼ to select [Blue].
- 2) Press the <ENTER> button to display the adjustment dialog box.
- 3) Press ◀ ▶ to adjust the setting value.

Operation	Adjustment	Adjustment range
Press ▶.	deepen blue tone	Maximum value 63
Press ◀.	lighten blue tone	Minimum value 0

Daylight View

This function uses an ambient light sensor to detect the room's light intensity and automatically adjust the projector output to ensure a bright presentation.

- 1) Press ▲ ▼ to select [Daylight View].
- 2) Press the <ENTER> button to display the adjustment dialog box.
- 3) Press ◀ ▶ to select the desired item.

Auto	Always works and improve image performance in brightly lit places.
On	Enabled
Off	Disabled

Note

- When [Rear] is set to [On], [Auto] is disabled.
- When this function is set to [On] or [Auto], the [Sharpness] is disabled.

Sharpness

- 1) Press ▲▼ to select [Sharpness].
- 2) Press the <ENTER> button to display the adjustment dialog box.
- 3) Press ◀▶ to adjust the setting value.

Operation	Adjustment	Adjustment range
Press ▶.	increase the sharpness of the image	Maximum value 15
Press ◀.	decrease the sharpness of the image	Minimum value 0

Note

- When [Daylight View] is set to [On] or [Auto], the [Sharpness] is disabled.

Gamma

- 1) Press ▲▼ to select [Gamma].
- 2) Press the <ENTER> button to display the adjustment dialog box.
- 3) Press ◀▶ to adjust the gamma value to obtain a better balance of contrast.
 - Adjustments can be made between 0 and 15.

Noise reduction

- 1) Press ▲▼ to select [Noise reduction].
- 2) Press the <ENTER> button to display the adjustment dialog box.
- 3) Press ◀▶ to select the desired item.

Off	Disabled
L 1	Lower reduction
L 2	Higher reduction

- Noise interference on the screen can be reduced. Select one of the above options to get smoother images.
- [Noise reduction] cannot be selected when [480p], [576p], [720p], [1 035i] or [1 080i] is selected.

Note

- When input video signal to the projector, [Noise reduction] will become available.

Progressive

- 1) Press ▲▼ to select [Progressive].
- 2) Press the <ENTER> button to display the dialog box.
- 3) Press ◀▶ to select the desired item.
 - An interlaced video signal can be displayed in progressive mode. Select one of the following options.
 - [Progressive] cannot be selected when [480p], [576p], [720p], [1 035i] or [1 080i] is selected.

Off	Disabled
L 1	For an active picture
L 2	For a still picture
Film	For watching a film

Note

- When input video signal to the projector, [Progressive] will become available.

Reset

To reset the adjusted data, all adjustments will return to their previous figures.

- 1) Press ▲▼ to select [Reset].
- 2) Press the <ENTER> button.
 - A confirmation box appears and then select [Yes].

Note

- To reset the adjusted data except [Daylight View].

Store

- 1) Press ▲▼ to select [Store].
- 2) Press ▶ or the <ENTER> button.
- 3) Press ▲▼ to select one from Image 1 to 4 and press the <ENTER> button.
 - A confirmation box appears and then select [Yes].

Note

- To store the adjusted data except [Daylight View].
- Make sure you selected [Store] after adjusting settings. Some settings can not be stored if not registered with [Store] function.

Screen

Select [Screen] from the Main Menu (see “Navigating through the menu” on page 42), then select the item from the sub-menu.

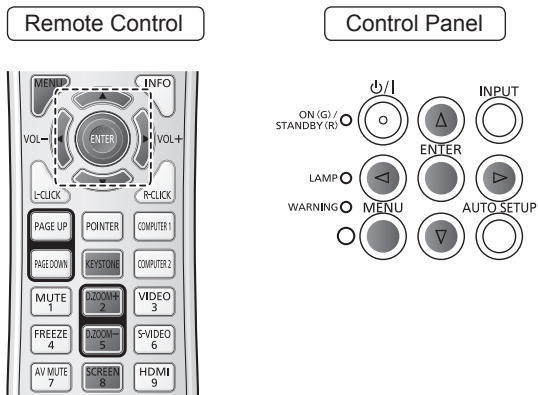

Normal

Provide the image to fit the screen size while maintaining the aspect ratio of the input signal.

Press **▲ ▼** to select [Normal] and then press the **<ENTER>** button.

Full

Provide the full screen image.

Press **▲ ▼** to select [Full] and then press the **<ENTER>** button.

Wide(16:9)

Provide the image at the 16:9 wide screen ratio.

Press **▲ ▼** to select [Wide(16:9)] and then press the **<ENTER>** button.

Zoom

Scale the image proportionally to fit the entire screen. Either side of image may go over the screen.

Press **▲ ▼** to select [Zoom] and then press the **<ENTER>** button.

True

Provide the image in its original size. When the original image size is larger than the panel size*, the projector enters to the panning mode automatically.

1) Press **▲ ▼** to select [True] and then press the **<ENTER>** button.

2) Press **▲ ▼ ◀ ▶** to pan the image.

- When adjusted, the arrows will turn red. When reached to the correction limits, the arrows will disappear.

* Panel size (1 280 x 800) is only for PT-VW435NEA. Panel size (1 024 x 768) is for PT-VX505NEA.

Note

- When input computer signal to the projector, [True] will be available.
- [True] is disabled and cannot be displayed when [480i], [576i], [480p], [576p], [720p], [1 035i] or [1 080i] is selected in the PC System Menu.
- When [True] is selected in the Screen menu, [Digital zoom +/-] can not be selected.

Natural wide (PT-VW435NEA Only)

Modify the 4:3 aspect ratio image to fit the screen size by stretching the image to make it look natural.

Press **▲ ▼** to select [Natural wide] and then press the **<ENTER>** button.

Note

- When input video signal to the projector, [Natural wide] will be available.
- [Natural wide] is not available when [720p], [1 035i] or [1 080i] is selected in the PC System Menu.

Custom

Provide the last stored aspect screen image.

Press **▲ ▼** to select [Custom] and press the **<ENTER>** button.

Custom adj.

Adjust the screen scale and position manually with this function.

- 1) Press ▲▼ to select [Custom adj.].
- 2) Press ► or the <ENTER> button to enter the next submenu.
- 3) Press ▲▼ to choose the item you want to adjust.
 - You can choose one from the items as below:

Scale H/V	Adjust the Horizontal/Vertical screen scale.
H&V	When set to [On], the aspect ratio is fixed.
Position H/V	Adjust the Horizontal/Vertical screen position.
Common	Save the adjusted scale or position to all the inputs.
Reset	Reset the all adjusted values.

Digital zoom +

Zoom in the images.

- 1) Press ▲▼ to select [Digital zoom +] and then press the <ENTER> button.
 - The On-Screen Menu disappears and [D. zoom +] appears.
- 2) Press the <ENTER> button to zoom in the image size and press ▲▼ ◀▶ to move the image to the top/bottom/left/right of the screen.
 - The Panning function can work only when the image is larger than the screen size. A projected image can be also expanded by pressing the <D.ZOOM +> or the <ENTER> button.

Digital zoom –

Zoom out the images.

- 1) Press ▲▼ to select [Digital zoom –] and then press the <ENTER> button.
 - The On-Screen Menu disappears and [D.zoom –] appears.
- 2) Press the <ENTER> button to zoom out image size.
 - The projected image can be also compressed by pressing the <D.ZOOM –> or the <ENTER> button.

To exit the Digital zoom +/- mode, press any button except the <D.ZOOM +/->, <ENTER> and ▲▼◀▶ buttons.

To return to the previous screen size, select a screen size from the Screen Size Adjustment Menu or select an input source from the Input Source Selection Menu (►page 45) again, or adjust the screen size with the <D.ZOOM +/-> buttons.

Note

- When input computer signal to the projector, [D.ZOOM +/-] will be available.
- [Digital zoom +/-] cannot be selected when [True] is selected in the Screen menu.
- [Digital zoom -] cannot be selected when [Custom] is selected in the Screen menu.
- [Digital zoom +/-] are disabled and cannot be displayed when [480i], [576i], [480p], [576p], [720p], [1 035i] or [1 080i] is selected in the PC System Menu (►page 46).
- When [Digital zoom +/-] functions are disabled,  mark will appear.

Keystone

This function is used to adjust keystone distortion of the projected image.

- 1) Press ▲▼ to select [Keystone].
- 2) Press ► or the <ENTER> button.
- 3) Press ▲▼ to choose the item you want to adjust.

Keystone	To correct keystone distortion
Store	To store or reset the keystone correction



The following items are the submenu of [Store].

Store	Keep the keystone correction ever when the AC power cord is plugged out or turned off the projector.
Reset	Release the keystone correction when the AC power cord is plugged out.

Note

- For more details about the keystone correction, refer to "Using the KEYSTONE button" (page 39).

Screen

Ceiling

This function is used to project the image from a ceiling-mounted projector.

- 1) Press ▲ ▼ to select [Ceiling] and then press the <ENTER> button.
- 2) Press ▲ ▼ to change the image.
 - When this function is set to [On], the picture will be top/bottom and left/right reversed.

Rear

This function is used to project the image from rear of the screen.

- 1) Press ▲ ▼ to select [Rear] and then press the <ENTER> button.
- 2) Press ▲ ▼ to change the image.
 - When this function is set to [On], the picture will be left/right reversed.

Screen aspect (PT-VW435NEA Only)

This function is used to project the image to a 4:3 or 16:9 projection screen.

- 1) Press ▲ ▼ to select [Screen aspect] and then press the <ENTER> button.
- 2) Press ▲ ▼ to choose one from the items as below.

Default(16:10)	16:10 is the aspect of the LCD panel.
16:9	Set to a 16:9 projection screen.
4:3	Set to a 4:3 projection screen.

Attention

- When the [4:3] function is selected, [Natural wide] is not available in the AV screen.
- When the [16:9] function is selected, [Wide (16:9)] is not available in the AV screen.

Reset

To reset the adjusted data, all adjustments will return to their previous figures.

Press ▲ ▼ to select [Reset] and then press the <ENTER> button.

- A confirmation box appears and then select [Yes].

Sound

Select [Sound] from the Main Menu (see “Navigating through the menu” on page 42), then select the item from the sub-menu.

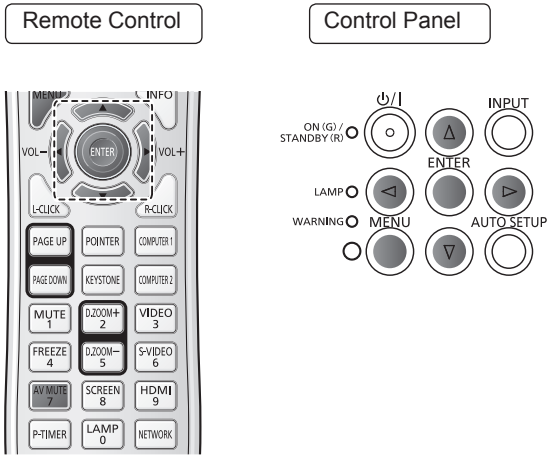

Volume

- 1) Press ▲▼ to select [Volume] and then press the <ENTER> button.
- 2) Press ◀▶ to adjust the volume.
 - Press <ENTER> button to set the volume.

Operation	Adjustment	Adjustment range
Press ▶.	turn up the volume	Maximum value 63
Press ◀.	turn down the volume	Minimum value 0

- You can also press <VOL -/+> buttons on the remote control or control panel to adjust the volume.

Mute

- 1) Press ▲▼ to select [Mute].
- 2) Press the <ENTER> button to switch the mute function On/Off.
 - Press the <MUTE> button on the remote control to temporarily turn off the sound. To turn the sound back on, press the <MUTE> button again or press the <VOL -/+> buttons.

MIC

- 1) Press ▲▼ to select [MIC] and then press the <ENTER> button.
- 2) Press ▲▼ to switch the MIC function [On]/[Off].
 - When [Off] is selected in [MIC] function, the [MIC gain] and [Standby MIC out] functions are not available.
 - Connect the computer 2 audio input signals to COMPUTER AUDIO IN 1 terminal as the MIC function is turned on.
 - If the [MIC] function is turned on when connecting PC audio to the AUDIO IN (a mini jack), loud sound may be output suddenly depending on the setting value of [MIC gain].

MIC gain

- 1) Press ▲▼ to select [MIC gain] and then Press the <ENTER> button.
- 2) Press ◀▶ to adjust the MIC mixing gain.
 - Press <ENTER> button to set the MIC gain.

Operation	Adjustment	Adjustment range
Press ▶.	turn up the MIC mixing gain	Maximum value 63
Press ◀.	turn down the MIC mixing gain	Minimum value 0

Standby MIC out

- 1) Press ▲▼ to select [Standby MIC out] and then press the <ENTER> button.
- 2) Press ▲▼ to switch the [Standby MIC out] function [On]/[Off].
 - When setting the [Standby MIC out] function to [On] and in Standby mode status, only MIC input volume can be output. Press the <VOL -/+> buttons on the control panel or on the remote control to adjust the MIC input volume.
 - Only the Standby mode (➡ page 61) is set to [Network], [Standby MIC out] can be selected.

Setting

Select [Setting] from the Main Menu (see “Navigating through the menu” on page 42), then select the item from the sub-menu.

Remote Control

Control Panel

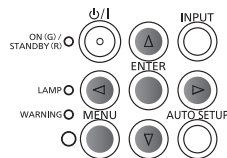

Language

- 1) Press ▲ ▼ to select [Language].
- 2) Press ► or the <ENTER> button.
- 3) Press ▲ ▼ to select the desired language.

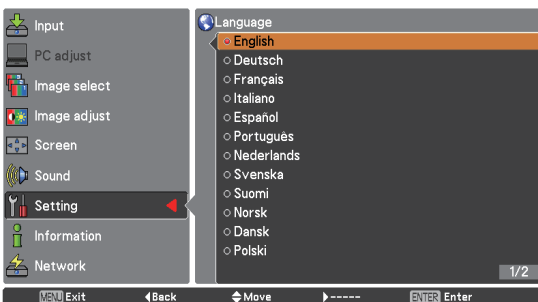
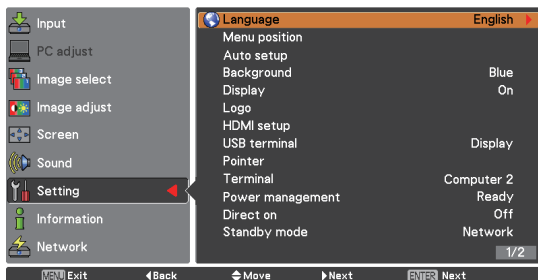

- The language used in the On-Screen Menu is available in English, German, French, Italian, Spanish, Portuguese, Dutch, Swedish, Finnish, Norwegian, Danish, Polish, Hungarian, Romanian, Czech, Russian, Turkish, Arabic, Kazak, Vietnamese, Chinese, Korean, Japanese and Thai.

Menu position

This function is used to change the position of the On-Screen Menu.

- 1) Press ▲ ▼ to select [Menu position].
- 2) Press the <ENTER> button to change the position.
 - The Menu position changes each time you press <ENTER> button as follows:

the center → the bottom left → the bottom right → the top left → the top right → the center.....

Auto setup

- 1) Press ▲ ▼ to select [Auto setup].
- 2) Press ► or the <ENTER> button.
- 3) Press ▲ ▼ to select these functions as follows:

Input search

This function detects the input signal automatically. When a signal is found, the search will stop.

Off	Input search will not work
On 1	Input search works*1
On 2	Input search works*2

*1 : • When pressing the <AUTO SETUP> button on the remote control or the control panel.

*2 : • When turning on the projector by pressing the <P/|> button on the control panel or the <POWER ON> button on the remote control.

• When pressing the <AUTO SETUP> button on the remote control or the control panel.

• When the current input signal is cut off.*

* If the [AV mute] or [Freeze] function is active, cancel it to activate the Input search. It is also unavailable when On-Screen menu is displayed.

Note

- This function detects the input signal automatically except [Network].

Auto PC adj.

On	Enables Auto PC adjustment *1
Off	Disables Auto PC adjustment

*1 : When pressing the <AUTO SETUP> button on the remote control or the control panel.

Auto keystone

Auto	Always works and corrects keystone distortion according to the projector's tilt.
Manual	Works only when pressing the <AUTO SETUP> button on the remote control or the control panel.
Off	Disables Auto Keystone.

Note

- [Input search], [Auto PC adj.] and [Auto Keystone] cannot be set [Off] at the same time.
- The [Auto Keystone] function cannot work when the [Ceiling] feature is set [On] in the [Screen] menu.

Background

Select the background screen for when no input signal is detected.

- 1) Press **▲▼** to select [Background].
- 2) Press the <ENTER> button.
- 3) Press **▲▼** to switch between each option as below.

Blue	Blue colored background.
User	The logo transferred by "Logo Transfer Software *1" is projected.
Black	Black colored background.

*1 : "Logo Transfer Software" is included on the supplied CD-ROM.

Display

This function decides whether to display On-Screen Displays.

- 1) Press **▲▼** to select [Display].
- 2) Press the <ENTER> button.
- 3) Press **▲▼** to switch between each option as below.

On	Show all the On-Screen displays *1
Countdown off	Show the input image instead of the countdown when turning on the projector *2
Off	Hide the On-Screen Displays *3

*1 : Use this function when you want to project images after the lamp becomes bright enough. The factory default setting is in this option.

*2 : Use this function when you want to project the image as early as possible even when the lamp is not bright enough.

- *3 : Hide the On-Screen Displays except;
- On-Screen Menu.
 - [Power off?]
 - [P-timer] display.
 - No signal for [Power management]
 - [Please wait ...]
 - Arrows for the True function in the [Screen] Menu.
 - [Service]

Logo

This function allows you to customize the screen logo with [Logo select], [Logo PIN code lock] and [Logo PIN code change] functions.

- 1) Press **▲▼** to select [Logo].
- 2) Press **▶** or the <ENTER> button.
- 3) Press **▲▼** to choose the desired item.

Logo select

This function decides on the starting-up display from among following options.

Off	Show the countdown display only.
Default	Show the factory-set logo.
User	The logo transferred by "Logo Transfer Software *1" is projected.

*1 : "Logo Transfer Software" is included on the supplied CD-ROM.

Logo PIN code lock

This function prevents an unauthorized person from changing the screen logo.

Off	The screen logo can be changed freely from the Logo Menu.
On	The screen logo cannot be changed without a Logo PIN code.

Note

- If you want to change the Logo PIN code lock setting, press the <ENTER> button and the Logo PIN code dialog box appears. Enter a Logo PIN code by following the steps below. The initial Logo PIN code is set to "4321" at the factory.
- You can enter a Logo PIN code through the control panel or the remote control. For details, please refer to "Enter a PIN code" (➔ page 35).

Setting

Logo PIN code change

Logo PIN code can be changed to your desired four-digit number.

- 1) Press ▲ ▼ to select [Logo PIN code change] and press the <ENTER> button.
 - Current logo PIN code dialog box appears.
- 2) Press ▲ ▼ to enter the current code, press the ► button to fix the number and move the red frame pointer to the next box.
 - The New Logo PIN code input dialog box appears.
- 3) Repeat this step to set the new Logo PIN code.

Attention

- Be sure to note the new Logo PIN code and keep it on hand. If you lost the number, you could no longer change the Logo PIN code setting.

HDMI setup

This function is only used for HDMI input source.

- 1) Press ▲ ▼ to select [HDMI setup].
- 2) Press ► or the <ENTER> button.
 - The names for the output setting of Digital R/G/B vary from equipment to equipment.

Image

Normal	When the output of Digital R/G/B equipment is set to Standard.
Enhanced	When the output of Digital R/G/B equipment is set to Enhanced.

Sound

HDMI	When Digital input source is input, Sound is set to HDMI.
Computer 2	When DVI input source is changed to HDMI input source, Sound is set to Computer 2.

Attention

- For details, refer to the operating instructions of your Digital R/G/B equipment.
- Connect the computer 2 audio input signals to COMPUTER AUDIO IN 1 terminal as Sound function is set to Computer 2 and MIC function is turned on.

USB terminal

- 1) Press ▲ ▼ to select [USB terminal] and then press the <ENTER> button.
- 2) Press ▲ ▼ to choose the desired item.

Display	To display the image when the input source comes from the USB terminal.
Mouse control	To use the remote control as a mouse control.

Pointer

You can emphasize a part of the projected image with this function.

- 1) Press ▲ ▼ to select [Pointer].
- 2) Press ► or the <ENTER> button to access the submenu.
- 3) Press ▲ ▼ to choose one item among the items such as the size of Spotlight (Large/Middle/Small) and the pattern of Pointer (Arrow/Fingertip/Dot).

Note

- When the pointer displays on the screen, you can use the <MOUSE CONTROL> button on the remote control to move the pointer.

Terminal

The COMPUTER 2 IN/MONITOR OUT terminal on the back of the projector is switchable for computer 2 input or monitor output.

- 1) Press ▲ ▼ to select [Terminal] and then press the <ENTER> button.
- 2) Press ▲ ▼ to switch the item.

Computer 2	Computer input
Monitor out	Monitor out

Note

- Terminal function is not available when selecting [Computer 2] to the input source. Change the input source to the others (HDMI, Computer 1, Video, S-Video) so that the Terminal function will be available.

Power management

For reducing power consumption as well as maintaining the lamp life, the Power management function turns off the projection lamp when the projector is not operated for a certain period.

- 1) Press **▲▼** to select [Power management].
- 2) Press **▶** or the **<ENTER>** button to access the submenu.

■ Mode

- 1) Press **▲▼** and then press the **<ENTER>** button to select one mode among the items as below.

Ready	When the lamp has been fully cooled down, the <ON(G)/STANDBY(R)> indicator changes to green blinking. In this condition, the projection lamp will be turned on if the input signal is reconnected or any button on the control panel or remote control is pressed.
Shut down	When the lamp has been fully cooled down, the power will be turned off.
Off	[Power management] function is off.

■ Timer

- 1) Press **▲▼** to select [Timer] and then press the **<ENTER>** button.
- 2) Press **▲▼** to set the Timer(1~30min).

Note

- The [Power management] function is not available when the input signal is [Network].

Direct on

- 1) Press **▲▼** to select [Direct on] and then press the **<ENTER>** button.
- 2) Press **▲▼** to switch between [On] and [Off].

- When this function is set to [On], the projector will be automatically turned on just by connecting the AC power cord to a wall outlet.
- Be sure to turn off the projector properly. If the projector is turned off in the incorrect sequence, the [Direct On] function does not work properly.

Standby mode

This function can set the electric power when the projector is standing by.

- 1) Press **▲▼** to select [Standby mode] and then press the **<ENTER>** button.
- 2) Press **▲▼** to switch between the items as below.

Eco	Restricts some functions in standby mode to reduce power consumption.
Network	Does not restrict functionality even in standby mode.

Note

- When selecting [Network], the cooling fans may be running depending on the temperature inside the projector even if the projector is turned off.
- If Standby mode is set to [Eco], you cannot use network functions when the projector is standing by. Also, you cannot use some RS-232C protocol commands.
- If set to [Network], you can use network functions when the projector is standing by.
- If [Standby mode] is set to [Eco], the signal come from MONITOR OUT and AUDIO OUT terminals are unavailable.

P-timer

This function allows you to change the setting of the P-timer and execute it.

- 1) Press **▲▼** to select [P-timer].
- 2) Press **▶** or **<ENTER>** button to access the submenu.

■ Mode

- 1) Press **▲▼** to select one mode among the items as below.

Count up	The P-timer display 000:00 appears on the screen and the count up starts (000:00-180:00).
Count down	The time set in the Timer setting appears on the screen and the countdown starts.

■ Timer

- 1) Press **▲▼** to select [Timer] and then press the **<ENTER>** button.
- 2) Press **▲▼** to set the [Timer](1-180 Min).
 - Timer is available in [Count down] only. Factory default value is 10 Min.

Setting

Execute

- 1) Press **▲ ▼** to select one among the items as below and then press the **<ENTER>** button.

Start	It executes the count up or count down function.*1
Reset	Reset the P-timer values.*2
Exit	To exit the P-timer operation.

- *1 : Press the **<ENTER>** button at Start and the indication changes into Stop. To stop Count up or Count down, press the **<ENTER>** button at Stop on the screen menu, then the indication changes into Restart. Press the **<ENTER>** button at Restart to resume Count up or Count down.
- *2 : Press the **<ENTER>** button at Reset to return to the following value:

Count up	"000:00"
Count down	Timer that you set

Attention

- To stop the [P-timer] function, press the **<P-TIMER>** button.
- To cancel the [P-timer], press and hold the **<P-TIMER>** button for a few seconds.

Closed caption

[Only for NTSC, 480i input]

- 1) Press **▲ ▼** to select **[Closed caption]**.
- 2) Press **▶** or the **<ENTER>** button to enter the submenu.

Closed caption

- 1) Press **▲ ▼** to select **[Closed caption]** and then press the **<ENTER>** button.
- 2) Press **▲ ▼** to select **[Off]**, **[CC1]**, **[CC2]**, **[CC3]** or **[CC4]**.

Color

- 1) Press **▲ ▼** to select **[Color]** and then press the **<ENTER>** button.
- 2) Press **▲ ▼** to select **[Color]** or **[White]**.

Attention



- The closed caption is mainly used in the north America. This function shows the text information contained in the image signal. Captions may not be displayed on some devices or software.

- You can select **[Closed caption]** when **[NTSC]** or **[480i]** signals are input.
- Part of characters may not displayed when high compensation values are set in **[Keystone]**.
- Closed captions are not displayed while the menu screen appears.

Lamp power

This function allows you to change brightness of the screen.

- 1) Press **▲ ▼** to select **[Lamp power]** and then press the **<ENTER>** button .
- 2) Press **▲ ▼** to select one among the modes as below.
 - You can also press the **<LAMP>** button to display **[Lamp power]**.

 Normal	Normal brightness.
 Eco	Lower brightness reduces the lamp power consumption and extends the lamp life.

Note

- If **[Lamp power]** is set to **[Normal]** and the operating environment temperature exceeds 35°C(95 °F), **[Lamp power]** may be changed to **[Eco]** automatically.

Remote control

This switching function prevents remote control interference when operating several projectors or video equipment at the same time.

- 1) Press **▲ ▼** to select **[Remote control]**.
- 2) Press **▶** or the **<ENTER>** button.
- 3) Press **▲ ▼** to select one among the seven codes.
 - This projector provides 7 different remote control codes: **[ALL]**, **[Code 1]**~**[Code 6]**.

Attention

- When operating the projector under **[ALL]** code, you can operate several projectors at the same time. If you want to operate the projector independently, you must switch to other code.
- When different codes are set on the projector and on the remote control, any operation cannot be made. In that case, switch the code on the remote control to fit the code on the projector.
- If the batteries are removed from the remote control for a long period of time, the remote control code will be reset.

Security



This function allows you to use the Key lock and PIN code lock function to set the security for the projector operation.

- 1) Press ▲▼ to select [Security].
- 2) Press ► or the <ENTER> button to access the submenu.

■ Key lock

This function locks the control panel and remote control buttons to prevent operation by unauthorized persons.

- 1) Press ▲▼ to select the desired items as below.

	Unlocked.
	Lock the operation of the control panel. To unlock, use the remote control.
	Lock the operation of the remote control. To unlock, use the control panel.

■ PIN code lock

This function prevents the projector from being operated by unauthorized persons and provides the following setting options for security.

- 1) Press ▲▼ to select the desired items as below.

Off	Unlocked.
On 1	Enter the PIN code every time turning on the projector.
On 2	Enter the PIN code to operate the projector once the power cord is disconnected; as long as the AC power cord is connected, the projector can be operated without a PIN code.

Attention

- Whenever you change the PIN code lock setting or the PIN code (the four-digit number), you are required to enter the PIN code. The "1234" is set as the initial PIN code at the factory.
- You can enter a PIN code through the control panel or the remote control. For details, please refer to "Enter a PIN code" (➔ page 35).

■ PIN code change

The PIN code can be changed to your desired four-digit number.

- 1) Press ▲▼ to select [PIN code change] and then Press <ENTER> button.
 - Current Pin code dialog box appears.
- 2) Press ▲▼ to enter the current code. Press ► button to fix the number and move the red frame pointer to the next box.
 - The New PIN code input dialog box appears.
- 3) Repeat these steps to set a new PIN code.

Attention

- Be sure to note the new PIN code and keep it on hand. If you lost the number, you could no longer change the PIN code setting.

Fan

- 1) Press ▲▼ to select [Fan] and then Press <ENTER> button.
- 2) Press ▲▼ to select one option .
 - This function provides the following options in the cooling fans' operation when the projector is turned off.

L 1	It takes less time to cool the projector down than L 2 mode.
L 2	Slower and lower-sound than L 1 mode, but it takes more time to cool the projector down.

Fan control

- 1) Press ▲▼ to select [Fan control] and then Press <ENTER> button.
- 2) Press ▲▼ to select one among options as below.
 - Choose the running speed of cooling fans from the following options according to the ground elevation under which you use the projector.

Off	Normal speed.*1
On 1	Faster than [Off] mode.*2
On 2	Faster than [On 1] mode.*3

*1 : Set this function to [Off] when using the projector in non-high altitude environment.

*2 : When using the projector in the elevation of above 1 200 m and below 2 000 m, make sure [Fan control] is set to [On 1].

Setting

*3 : When using the projector in the elevation of above 2 000 m and below 2 700 m, make sure [Fan control] is set to [On 2].

Note

- Failure to set the running speed of cooling fans properly may affect the projector life.
- The fan noise becomes louder in [On 1] and [On 2].

Video delay control

This function allows you to make a digital processing of a projected image faster.

- 1) Press ▲ ▼ to select [Video delay control] and then Press the <ENTER> button.
- 2) Press ▲ ▼ to select one item between [On] and [Off].

Note

- [Noise reduction] and [Progressive] can not be selected when [Video delay control] function is set to [On].

Filter counter

This function is used to set a frequency for the filter replacement.

- 1) Press ▲ ▼ to select [Filter counter].
- 2) Press ► or the <ENTER> button to access the submenu items.

Filter counter

Show the total accumulated time of the filter use timer setting.

Timer

To set a timer. When the projector reaches the selected time the filter warning icon appears on the screen.

- 1) Press ▲ ▼ to select [Timer] and then press the <ENTER> button.
- 2) Press ▲ ▼ to set the Timer.
 - Select from [Off/1000H/2000H/3000H/4000H/5000H/6000H] depending on the use environment.

Filter counter reset

After replacing the filter, be sure to reset the timer.

- 1) Press ▲ ▼ to select [Filter counter reset].

2) Press the <ENTER> button.

- [Filter counter Reset?] appears. Select [Yes] to continue. Another confirmation dialog box appears, select [Yes] to reset the [Filter counter].

Emulate

When using the control commands for one of our projectors that you have previously purchased to control this projector using a computer via its serial input terminal, set up the [Emulate] function as follows. This will allow you to use the control software etc. designed for our existing projectors.

- 1) Press ▲ ▼ to select [Emulate].
- 2) Press the <ENTER> button or the ► button.
 - The [Emulate] screen appears.
- 3) Press ▲ ▼ to select the required item.
- 4) Press the <ENTER> button.

Note

- Refer to "Serial terminal" (➔page 105)

Default	VW430 series, VX500 series, VW435N series, VX505N series
D3500	D3500 series
D4000	D4000 series
D/W5k series	D5500 series, DW5000 series, D5600 series, DW5100 series, D5700 series
D/W/Z6k series	D5000 series, D6000 series, DW6300 series, DZ6700 series, DZ6710 series, DZ570 series, DW530 series, DX500 series
L730	L520 series, L720 series, L730 series
L780	L750 series, L780 series
L735	L735 series

L785	L785 series
LB/W series	LB2 series, LB1 series, LB75 series, LB80 series, LB90 series, ST10 series
F/W series	FX400series, FW430 series, F100 series, FW100 series, F200 series, F300 series, FW300 series
LZ370	LZ370 series

Warning log

This function records anomalous operations while the projector is in operation and use it when diagnosing faults.

- 1) Press ▲ ▼ to select [Warning log].
- 2) Press ► or the <ENTER> button to display the latest warning message.
 - Up to 10 warning logs are displayed with the latest warning message at the top of the list, followed by previous warning messages in chronological order.

Attention

- When the [Factory default] function is executed, all the warning log records will be deleted.

Factory default

This function returns all setting values except for [PIN code lock], [Logo PIN code lock], [Lamp runtime], [Filter counter], the logo transferred by "Logo Transfer Software" and all of the network settings to the factory default settings.

- 1) Press ▲ ▼ to select [Factory default].
- 2) Press the <ENTER> button.
 - [Return to Factory default?] appears. Select [Yes] to continue. Another confirmation dialog box appears, select [Yes] to return to [Factory default].

Information

Select [Information] from the Main Menu (see “Navigating through the menu” on page 42), then select the item from the sub-menu.

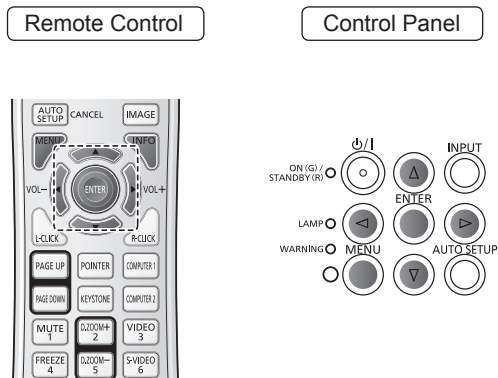

Input Source Information Display

The Information Menu is used for checking the status of the image signal being projected and the operation of the projector.

You can also Press the <INFO> button on the remote control to display the Information menu.

■ Input

The selected input source is displayed.

■ System

The selected system is displayed.

■ H-sync freq.

The selected H-sync freq. is displayed.
The horizontal frequency of the input signal is displayed in kHz, or - - - - kHz when no signal.

■ V-sync freq.

The selected V-sync freq. is displayed.
The vertical frequency of the input signal is displayed in Hz, or - - - - Hz when no signal. Numbers of Hz doubles when during Interlace.

■ Screen

The selected Screen size is displayed.

■ Language

The selected language is displayed.

■ Lamp power

The selected lamp mode is displayed.

■ Lamp runtime

The cumulative lamp operating time is displayed.

■ Power management

[Off], [Ready] or [Shut down], and [Timer] are displayed.

■ Key lock

The selected Key lock icon is displayed.

■ PIN code lock

[Off], [On 1] or [On 2] is displayed.

■ Remote control

The selected remote control code is displayed.

■ Serial number

The serial number of the projector is displayed.
The serial number is used to service the projector.

Network

Select [Setting] from the Main Menu (see “Navigating through the menu” on page 42), then select the item from the sub-menu.

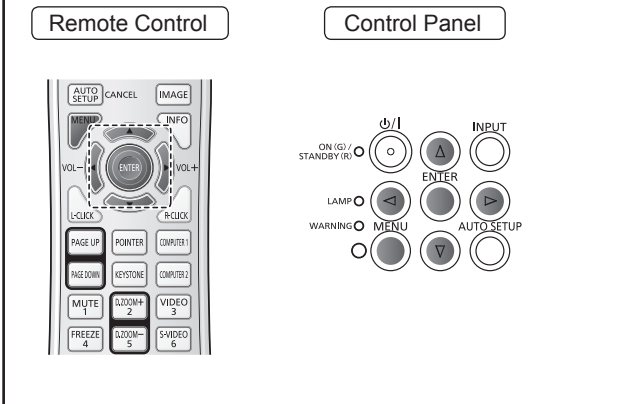

Verifying the network information

When connecting the projector via the dedicated applications of "Wireless Manager mobile edition 6.0" or iPad / iPhone / iPod touch, the network number, the project name and ID of Wireless LAN are required. You can check these information by entering [Input Guide] or [Network Status]. (▶page 72)

Input Guide

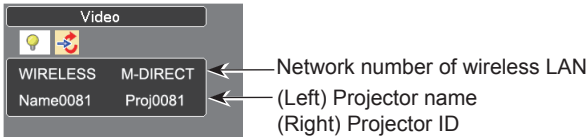

To display the input guide, please press the [INPUT] button on the control panel or any one of the input selection buttons on the remote control.

Wired LAN

You can make detailed wired LAN settings.

- 1) Press ▲▼ to select [Wired LAN], and press <ENTER> button.
- 2) Press ▲▼ to select an item, and change the setting according to the instructions.

DHCP* (DHCP client function)	On: If a DHCP server exists in the network to which the projector is connected, the IP address will automatically be acquired. Off: If a DHCP server does not exist in the network to which the projector is connected, additionally set [IP address], [Subnet mask] and [Default gateway].
IP address* (Display of IP address and setting)	Enter the IP address if DHCP server is not used.
Subnet mask* (Displaying and setting the subnet mask)	If not using a DHCP server, enter the subnet mask.
Default gateway* (Display of gateway address and setting)	Enter the gateway address if DHCP server is not used.
DNS1* (Display of Preferred DNS server address and setting)	Enter the DNS server address if DHCP server is not used.
DNS2* (Display of Alternate DNS server address and setting)	Enter the alternate DNS server address if DHCP server is not used.

* “Glossary” (▶page 117– 118)

- 3) Press ▲▼◀▶ to select [Set], and press <ENTER> button.

- Default wired LAN settings
The following settings are set before the projector leaves the factory.

DHCP	Off
IP address	192.168.10.100
Subnet mask	255.255.255.0
Default gateway	192.168.10.1
DNS 1 / DNS 2	NONE

Network

Note

- Before using the DHCP server, make sure the DHCP server is already functioning.
- For details of IP address, subnet mask, gateway and DNS, ask the network administrator.
- A wired LAN and wireless LAN can not be used in the same segment.

Wireless LAN

You can set the network number.

- 1) Press ▲▼ to select [Wireless LAN], and press <ENTER> or ► button.
- 2) Select the number to be connected with the ▲▼ buttons.
 - Network number [Off], [S-DIRECT], [M-DIRECT], [S-MAP], [1]-[4], [User 1]-[User 3]

Note

- Selecting [Off] disables the wireless LAN.
- Network number: [S-DIRECT], [S-MAP] and [1]-[4] are available only when connecting via wireless LAN with the application software the "Wireless Manager mobile edition 6.0". For details, refer to the operation manual of the "Wireless Manager mobile edition 6.0".
- Network number: [USER 1]-[USER 3] can be changed in [Wireless detailed setup] menu. (►page 68-71)

Wireless detailed setup

You can configure more precise network settings, if you select [M-DIRECT] or [USER1] - [USER3] (user) for [Wireless LAN] in the network menu. For network settings, contact your network administrator.

■ Configuration of Wireless LAN [M-DIRECT]

Even if there is no access point, you can still connect the projector to computer via the infrastructure. In addition, the connection with the iPad / iPhone / iPod touch is much easier. For details, please refer to [Sending image from iPad / iPhone / iPod touch]. (►page 71)

- 1) Press ▲▼ to select [Wireless detailed setup], and press <ENTER> button.
- 2) Press ▲▼ to select an item, and change the setting according to the instructions.

IP Address * (Displaying and setting the IP address)	Enter the IP address.
----------------------------------------------------------------	-----------------------

Subnet Mask * (Displaying and setting the subnet mask)	Enter the subnet mask.
SSID * (Displaying and setting the SSID)	Select M-DIRECT in Wireless LAN, then the SSID can be set.
Channel	Select M-DIRECT in Wireless LAN, then the Channel can be set. Select a channel for the access point (► page 21).
Key	Select M-DIRECT in Wireless LAN, then the KEY can be set. Setting a key for the access point. Input either 8 to 63 alphanumeric or a 64 digit string in the hexadecimal format.

* "Glossary" (►page 117 – 118)

- 3) Press ▲▼◀▶ to select [SET], and press <ENTER> button.

The current setting of network will be saved.

Note

- After the configuration is completed, you must select [SET] and press the <ENTER> button. At this time, if you select [Cancel], You will cancel the setting change.

■ Default settings of [M-DIRECT]

The following settings as [M-DIRECT] in the wireless LAN are set before the projector leaves the factory.

IP Address *	192.168.12.100
Subnet Mask *	255.255.255.0
SSID *	M-DIRECT + The last 4 digits of the projector ID
Channel	1
Key	The same string as the SSID

Note

- The authentication method is WPA2-PSK, and the encryption method is AES. Both methods are fixed.
- When you need to change initial configuration of [M-DIRECT], please contact your network administrator.
- Make sure the initial Key is changed for safety.
- As the DHCP server is already functioning, select [ON] before connecting a computer.

■ Configuration of Wireless LAN [USER1]~[USER3]

- 1) Press ▲▼ to select [Wireless detailed setup], and press <ENTER> button.

2) Press ▲▼ to select an item, and change the setting according to the instructions.

Name change	You can change the user name.
DHCP * (DHCP client function)	ON: If a DHCP server exists in the network to which the projector is connected, the IP address will automatically be acquired. OFF: If a DHCP server does not exist in the network to which the projector is connected, additionally set [IP address *], [Subnet mask *] and [Default gateway *].
IP address * (Display of IP address and setting)	Enter the IP address if DHCP server is not used.
Subnet mask * (Displaying and setting the subnet mask)	If not using a DHCP server, enter the subnet mask.
Default gateway * (Display of gateway address and setting)	Enter the gateway address if DHCP server is not used.
DNS1 (Display of Preferred DNS server address and setting)	Enter the DNS server address if DHCP server is not used.
DNS2 (Display of Alternate DNS server address and setting)	Enter the alternate DNS server address if DHCP server is not used.

* "Glossary" (➡page 117 – 118)

Note

- Before using the DHCP server, make sure the DHCP server is already functioning.
- For details of IP address, subnet mask, gateway and DNS server, ask the network administrator.
- A wired LAN and wireless LAN cannot be used in the same segment.

3) Press ▲▼◀▶ to select [Next], and press <ENTER> button.

[Wired detailed setup] screen (2/3) setting screen is displayed.
Make the settings related to the wireless connection between the projector and the network.
Select [Cancel] instead of [Next] to cancel the configuration change.

● SSID *	If the mode is [AD HOC], enter the same character string as that of SSID set on the computer to be connected. If the mode is [Infrastructure *], enter the SSID registered at the access point *.
-----------------	---------------------------------------------------------------------------------------------------------------------------------------------------------------------------------------------------

* "Glossary" (➡page 117 – 118)

Note

- SSID has to be entered in alphanumeric letters.
- You cannot set "any" or "ANY" for SSID.

● Mode	Select [AD HOC] or [Infrastructure].
AD HOC *	Connect projector and computer directly without access point.
Infrastructure *	Connect through access point.

* "Glossary" (➡page 117 – 118)

● Authentication	Set the user authentication method used by the network to be connected.
OPEN	Select when making a connection using [AD HOC], or when the access point authentication method is OpenSystem *1.
SHARED	Select when making a connection using [AD HOC], or when the access point authentication method is Shared Key *1.
WPA-PSK *2	Select when the access point authentication method is WPA-PSK *1.
WPA2-PSK *2	Select when the access point authentication method is WPA2-PSK *1.
WPA-EAP/ WPA2-EAP *2	Select when the access point authentication method is WPA-EAP *1/ WPA2-EAP *1.
WPA-EAP *2	Select when the access point authentication method is WPA-EAP *1.

WPA2-EAP *2	Select when the access point authentication method is WPA2-EAP *1.
● Encryption	Select the encryption method to be used for communication between the projector and the network.
NONE	Select when transmit without encryption. It is selectable only when [Authentication] is [OPEN] or [SHARED].
WEP *1	Select when Encryption is WEP.
TKIP *1	Select when Encryption is TKIP. Selectable when [Authentication] is either [WPA-PSK], [WPA2-PSK], [WPA-EAP], [WPA2-EAP].
AES *1	Select when Encryption is AES. Selectable when [Authentication] is either [WPA-PSK], [WPA2-PSK], [WPA-EAP], [WPA2-EAP].
Channel *3	Select the channel to use. Refer to page 6 for usable channels.

- * 1: "Glossary" (▶ page 117 – 118)
- * 2: Available when the mode is set to [Infrastructure].
- * 3: Available when the mode is set to [AD HOC].

Note

- Important video/audio data is protected because AES encryption processing takes place in advance for all network numbers, even if [Encryption] is set to [NONE].

4) Press ▲▼◀▶ to select [Next], and press <ENTER> button.

At this point, select [Back] to go back to the previous screen (1/3), or select [Cancel] to cancel the configuration change.

In addition, further perform the following setting depending on [Authentication] and [Encryption] settings.

Note

- The setting menu is different depending on the setting of [Authentication] and [Encryption]. The above menu is an example when [Authentication] is set to [OPEN] or [SHARED] and [Encryption] is set to [WEP].

● When setting [OPEN] or [SHARED] as authentication and setting [WEP] as the encryption method:	
Default key	Set 1 – 4 numerals for the default key.
KEY1 – 4	Set a WEP key to the key number selected with [Default key]. Either the 64-bit or 128-bit WEP key can be set. For the 64-bit key, input five alphanumerics (or a 10-digit string for the hexadecimal format) for the 128-bit key, input 13 alphanumerics (or a 26-digit string for the hexadecimal format).
● When using [WPA-PSK] or [WPA2-PSK] :	
	Set a key. Input either 8 to 63 alphanumerics or a 64 digit string in the hexadecimal format.
● When the authentication method is [WPA-EAP/WPA2-EAP], [WPA-EAP], [WPA2-EAP]:	

Set [EAP], [USER NAME], and [PASSWORD].	
EAP *1:	Select the EAP setup in the RADIUS server *1. Types of EAP that can be selected are as follows. PEAP *1(MS-CHAPv2 *1), PEAP *1(GTC *1), EAP-TTLS *1(MD5 *1), EAP-TTLS *1(MS-CHAPv2 *1), EAP-FAST *1(MS-CHAPv2 *1), EAP-FAST *1(GTC *1)
USER NAME:	Input a user name used for authentication (excluding spaces) (maximum 64 characters).
PASS WORD:	Input a password used for authentication (maximum 64 characters).

* 1: "Glossary" (➔page 117 – 118)

Note

- If you are unable to connect to the wireless LAN through the access point even after performing the steps in "Projector settings (➔page 76)", contact the manufacturer of the access point.
- When using EAP, the projector needs to be set according to the setting of the RADIUS server. Check with the network administrator for the setting of the RADIUS server.
- When using an EAP together with an access point with invalid SSID broadcast, select WAP-EAP or WAP2-EAP for the authentication method even if the authentication method of the access point is WPA-EAP/WPA2-EAP.

■ Default settings of [USER 1]~[USER 3]

The following settings as [USER1]~[USER3] in the wireless LAN are set before the projector leaves the factory.

SSID	Panasonic Projector
DHCP	Off
IP address	192.168.11.100
Subnet mask	255.255.255.0

Default gateway	192.168.11.1
Mode	AD HOC
Authentication	OPEN
Encryption	NONE
Channel	11
DNS 1/DNS 2	NONE

5) Press ▲▼◀▶ to select [Set], and press <ENTER> button.

Save the current network settings

Note

- When configuration is completed, you need to select [Set] and press the <ENTER> button. At this point, select [Back] to go back to the previous screen (2/3), or select [Cancel] to cancel the configuration change.

■ Sending image from iPad / iPhone / iPod touch

By using the dedicated application, you can send the PDF file or the JPEG image which stored on your iPad / iPhone / iPod touch to the projector for projecting. For details, please enter the following URL.

<http://panasonic.net/avc/projector/>

Projector name

You can change the projector name to be displayed on the network.

1) Press ▲▼ to select [Projector name], and press <ENTER> button.

2) Select characters with the ▲▼◀▶ buttons and press the <ENTER> button to enter the projector name. Select [BS] to delete one character selected with the cursor in the input box and press the <ENTER> button.

3) Select [Set] with the ▲▼◀▶ buttons and press the <ENTER> button. Select [Cancel] to undo the changes and then press the <ENTER> button.

4) Select [YES] or [No] with the ▲▼ buttons and press the <ENTER> button.

Note

- [Name □□□□] (□□□□ is four-digit number) is set before the projector leaves the factory.

Network

Password

- By controlling connection with password setting, it is possible to prevent an external device from accidentally connecting and interrupting projection images, etc.
- Set to [On] to perform password check when connecting with the projector using “Wireless Manager mobile edition 6.0”. (Default : [Off])
- When using the deliver image to all function or the delivered image deletion function of the “Multi Projector Monitoring & Control Software”, image cannot be delivered to the projector with password setting set to [On]. To use these image delivery functions, set it to [Off].

1) Press ▲▼ to select [Password]. Press <ENTER> button or the ► button to access to the submenu.

2) Press ▲▼ to select [Password] and press the <ENTER> button. Select [On] or [Off] with ▲▼ buttons.

Press ▲▼ to select [Password change], and press <ENTER> button.

Select characters with the ▲▼◀▶ buttons and press the <ENTER> button to enter the password.

Select [BS] to delete one character selected with the cursor in the input box and press the <ENTER> button.

3) After inputting the password, select [OK] using the ▲▼◀▶ buttons and then press <ENTER> button.

Select [Cancel] to undo the changes and then press the <ENTER> button.

Network control

Set when you want to control the projector from a computer connected to the network.

1) Press ▲▼ to select [Network control].

2) Press <ENTER> button to select [On] or [Off] with the ▲▼ buttons.

Live mode cut in

Set this [On] to allow interrupt of the Live mode by other users, or to allow delivery of images by the “Multi Projector Monitoring & Control Software”, while the Live mode is active (sending image) by the “Wireless Manager mobile edition 6.0”. For details, refer to “Wireless Manager mobile edition 6.0” operating manual.

1) Press ▲▼ to select [Live mode cut in].

2) Press <ENTER> button to select [On] or [Off] with the ▲▼ buttons.

Note

- If you use the “Wireless Manager mobile edition 6.0” and the “Multi Projector Monitoring & Control Software” on the same computer at the same time, the function of delivering image to all may not be available. If you want to use them at the same time, please use another computer with respective software.

Multi-live

Switch to the Multi-live mode when using the “Wireless Manager mobile edition 6.0”. See the “Wireless Manager mobile edition 6.0” operation manual for details.

1) Press ▲▼ to select [Multi-live].

2) Press <ENTER> button.

Network status

Displays the current network status.

1) Press ▲▼ to select [Network status].

2) Press <ENTER> button or the ► button to access to the submenu.

3) Each press of the ► button switches wired LAN and wireless LAN.

Note

- When the network number is set to [Off], [Network status] is not display.

AMX D.D.

This function allows the projector to be detected by AMX Device Discovery. For more details, visit <http://www.amx.com/>.

- 1) Press ▲▼ to select [AMX D.D.].
- 2) Press <ENTER> button or the ► button to select [On] or [Off] to allow the projector to be detected by AMX Device Discovery.

RoomView

This function allows the projector to monitor and control the projector through network with Crestron RoomView®.

- 1) Press ▲▼ to select [RoomView].
- 2) Press <ENTER> button to select [On] or [Off] with the ▲ ▼ buttons.

This projector supports the following application software from Crestron company.

- RoomView® Express
- Fusion RV™
- RoomView® Server Edition

"Crestron RoomView" is a system developed by Crestron Electronics, Inc. which collectively manage and control multiple system devices connected via the network, from a computer. This projector supports "Crestron RoomView".

- For details of "Crestron RoomView", refer to the Crestron Electronics, Inc. website. (Provided only in English.). <http://www.crestron.com/>.
For the download of "RoomView Express", refer to the Crestron Electronics, Inc. website. (Provided only in English.). <http://www.crestron.com/getroomview>.

Memory viewer

- 1) Select [Network] in the main-menu and then press ► or <ENTER> button.
- 2) Select [Memory viewer] with Point ▲▼ buttons and press <ENTER> button.
- 3) Select [Start] and press <ENTER> button.

*The image file stored in the root directory of the USB thumb drive is displayed on the screen.

*If the image file is not available in the root directory of the USB thumb drive, the memory viewer browser window appears.

Note

- The Memory Viewer function is available only when the USB thumb drive is inserted, otherwise, it will grayout.
- For details, see the "Memory Viewer function" of the Network menu. (►page 90-93)

Network factory default

You can reset the network setting to the factory default of the projector.

- 1) Press ▲▼ to select [Network factory default], and press <ENTER> button.
- 2) A confirmation box appears and select [Yes] and then press <ENTER> button. Another confirmation box appears and select [Yes] and then press <ENTER> button.

Network

Network connections

The projector has a network function, and the following operations are available from the computer using the web browser control.

- Setting and adjustment of the projector.
- Display of the projector status.
- Transmission of an E-mail message when there is a problem with the projector.

Note

- A LAN cable is required to use the network function.

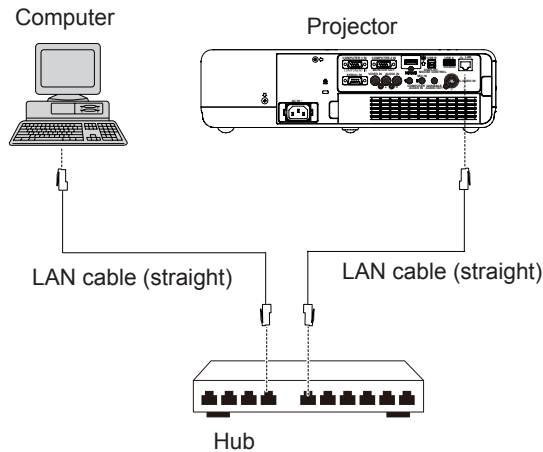

- A Web browser is required to use this function . Confirm that the Web browser can be used beforehand.
Compatible OS : Windows XP/Windows Vista/Windows 7, Mac OS X v10.4/v10.5/v10.6/v10.7
Compatible Web Browser : Internet Explorer 7.0/8.0/9.0, Safari 4.0/5.0 (Mac OS)
- Communication with an E-mail server is required to use the E-mail function. Confirm that the E-mail can be used beforehand.
- Use shielded LAN cable (STP cable) that is compatible with category 5 or above.
- Use a LAN cable with length of 100m or shorter.

■ Name and function of network function parts

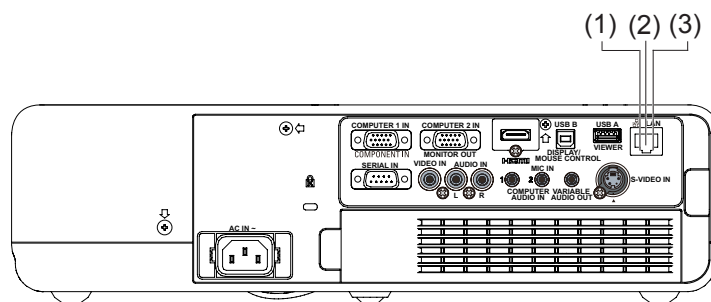

(1) LAN LINK/ACT lamp (yellow)

Lights on when connected.
Flashes when transmitting/receiving data.

(2) LAN terminal (10BASE-T/100BASE-TX)

Used to connect the LAN cable here.

(3) LAN 10/100 lamp (green)

Lights on when connected to the 100BASE-TX.

Attention

- Connect the LAN to the indoor equipment.

Connecting with Wired LAN

Projector settings

- 1) Use the LAN cable (Straight) to connect the projector with computer.
- 2) Turn on the projector and press the <MENU> button on the remote control.
- 3) Press the menu button to open the [Network] menu, and then select [Wired LAN], and press <ENTER> button.
- 4) Set the detailed setup of [Wired LAN].

For details, see “Wired LAN” (➔page 67).

Note

- Please confirm with your network administrator before you connect to an existing network.
- The following settings are set before the projector leaves the factory.

DHCP	OFF
IP Address	192.168.10.100
Subnet Mask	255.255.255.0
Default gateway	192.168.10.1
DNS 1/DNS 2	NONE

Computer operation

Connection can be made with wired LAN. However, confirm to your system administrator on network settings before changing any settings.

- 1) Turn on the computer.
- 2) Make the network setting according to your system administrator.

If the projector settings are the default settings (➔page 67), the computer can be used with the following network settings.

IP address	192.168.10.101
Subnet mask	255.255.255.0
Default gateway	192.168.10.1

Connecting with Wireless LAN

Projector settings

- 1) Turn on the projector and press the <MENU> button on the remote control.
- 2) Press the menu button to open the [Network] menu, and then select [M-DIRECT], or [USER 1] ~ [USER 3] for [WIRELESS LAN] and press <ENTER> button.
- 3) According to the network number selected in step 2, set the detailed setup of [Wireless detailed setup].

For details, see “Wireless detailed setup” (➔page 68-71).

Network

Note

- Wireless LAN and wired LAN cannot be used in the same segment.
- When multiple devices are connected, a unique IP address must be allocated to each device.
- SSID has to be entered in alphanumeric letters.
- You cannot set “any” or “ANY” for SSID.
- The following settings are set before the projector leaves the factory.

[M-DIRECT]

IP Address	192.168.12.100
Subnet Mask	255.255.255.0
SSID	M-DIRECT + The last 4 digits of the projector ID
Channel	1
Key	The same string as the SSID

[USER1] ~ [USER3]

DHCP	OFF
IP address	192.168.11.100
Subnet mask	255.255.255.0
Default gateway	192.168.11.1
SSID	Panasonic Projector
Mode	AD HOC
Authentication	OPEN
Encryption	NONE
Channel	11

Computer operation

1) Make the network setting according to your system administrator.

- If you select [M-DIRECT] for [Wireless LAN] in the network menu, the IP address will automatically be acquired.
- If you select default settings of [USER 1] ~ [USER 3] for [Wireless LAN] in the network menu (▶page 71), then the computer can be used with the following network settings.

IP address	192.168.11.101
Subnet mask	255.255.255.0
Default gateway	192.168.11.1

2) Click [Start]→[Connect To *]→[Wireless Network Connection *], select the wireless network of [SSID] set with the projector, and then click [Connect *].

When you select default settings of [M-DIRECT] for [Wireless LAN] in the network menu, the SSID is [M-DIRECT + The last 4 digits].

When you select default settings of [USER 1] ~[USER 3] for [Wireless LAN] in the network menu, the SSID is [Panasonic Projector].

- * The names are for Windows XP. In Windows Vista/Windows 7, the procedure will be [Start]→[Connect To]. The names may differ depending on the Operation System. Please connect the network according to the displayed names on your computer.

Note

- If you use any wireless utility other than Windows [Wireless Network Connection], follow its operation procedure for connection.
- If you use the access point, configure the computer and each network setting of the projector following the instruction of the network administrator.

Accessing from the Web browser

- 1) Activate the Web browser in the personal computer.
- 2) Enter the IP address set by the projector into the URL input field of the Web browser.
- 3) Enter your “User name” and “Password”.
 - The factory default settings are user1 (user privileges) or admin1 (administrator privileges) for the use name and panasonic (lowercase letters) for the password.
- 4) Click [OK] to display the Projector status page.
 - “Projector status” page is displayed.



Note

- Avoid activating two or more Web browser simultaneously to work out setting or control actions.
- Change the password first of all.
- Administrator privileges enable the use of all functions. User privileges enable the use of only “Projector status”, “Network status”, “Basic control”, “Advanced control”, and “Change password”.
- If you want to control the projector using a Web browser, set [Network control] in the network menu to [On].
- There are some control items used with the JavaScript function in the setting pages. If the web browser is set not to use this JavaScript function, it may not control the projector properly.

Description of each item



- 1 **Page selection tabs**
Click these to switch pages.
- 2 **Monitor information button**
Click this item, and the status of the projector is displayed.
- 3 **Projector control button**
Click this item to display the projector control page.
- 4 **Detailed set up button**
Click this item to display the advanced settings page.
- 5 **Change password button**
Click this button to display the password change page.
- 6 **CRESTRON RoomView button**
Click this button to monitor and control the projector through the CRESTRON RoomView®.
- 7 **Language switch button**
Click this button to switch language between English and Japanese.

Projector status page

Click [Status], then [Projector status] to display the Status information page. This page displays the projector statuses established for the items shown below.

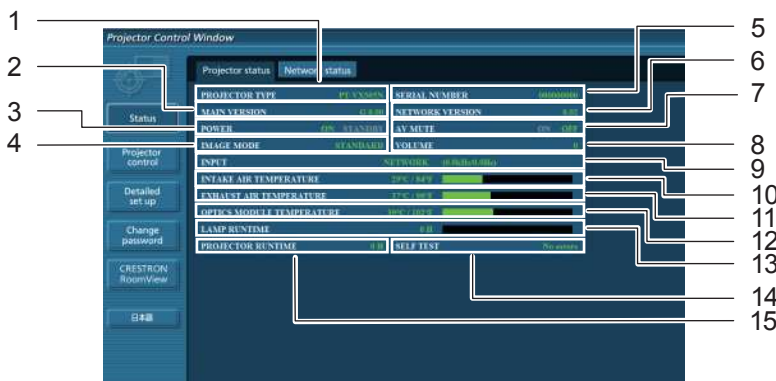

- 1 Displays the type of projector.
- 2 Displays the firmware version of the projector main unit.
- 3 Displays the power source status.
- 4 Displays the video mode status.
- 5 Displays the serial number of the projector.
- 6 Displays the firmware version of the network.
- 7 Displays the AV mute status.
- 8 Displays the volume status.
- 9 Displays the status of input switch.
- 10 Displays the intake temperature status of the projector.
- 11 Displays the exhaust temperature status of the projector.
- 12 Displays the optics module temperature status of the projector.
- 13 Displays the use time of the lamp.
- 14 Displays the self diagnostics information.
(See page 79)
- 15 Displays the runtime of the projector.

■ Error information page

If [Error (Detail)] is displayed in the self-diagnosis information display column on the [Projector status] screen, click the part to display the details of the error.

- Depending on the nature of the error, the projector may be placed in the standby mode for its own protection.

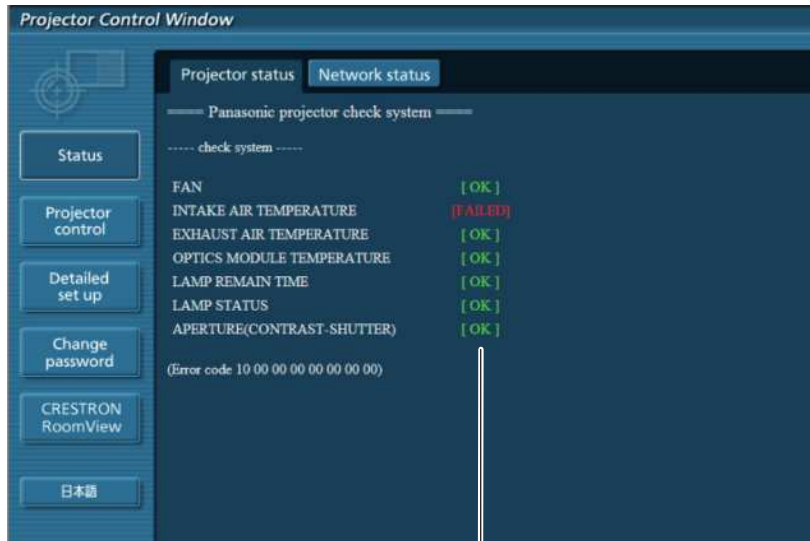

OK: Normal operation
 FAILED: Occurrence of trouble
 WARNING: Abnormal condition

When [FAILED] has appeared for an item

Parameter	Description
FAN	Trouble has occurred in the fan or its drive circuit. Consult your dealer.
INTAKE AIR TEMPERATURE	Intake air temperature is high. It could be because it is used in an environment of high temperature such as close to a heating device, etc., the air intake is blocked, or the air filter is clogged.
EXHAUST AIR TEMPERATURE	Exhaust air temperature is high. Exhaust may be blocked, or [Fan control] mode may be set wrong. (Refer to [Fan control] (➡page 63-64).)
OPTICS MODULE TEMPERATURE	Optics module temperature is high.
LAMP REMAIN TIME	The lamp runtime has exceeded the prescribed cumulative time, and it is now time to replace the lamp.
LAMP STATUS	The lamp has failed to light. Wait a short while for the lamp to cool off, and then turn on the power.
APERTURE (CONTRAST-SHUTTER)	Trouble has occurred in the contrast shutter circuitry. Consult your dealer.

■ Network status page

Displays the current configuration information of the network.



- 1 Displays the configuration details of wireless LAN.
- 2 Displays the configuration details of wired LAN.

Basic control page

To move from another page, click [Projector control], then [Basic control].



- 1 Power standby/on control
- 2 Use these to select the input signals
- 3 Volume adjust
- 4 Switches image mode
- 5 Operation of AV mute

Detail control page

Click [Projector control], then [Advanced control] to display the Detail control page.



- 1 Execute Auto setup function
- 2 Operations on Screen mode
- 3 Operations on Keystone function
- 4 Operations on Rear/Ceiling
- 5 Operations on Image adjust

Network config page

You can change network settings on projector when connecting with the administrator authority.

LAN settings

- 1) Click [Detailed set up] in the menu.
- 2) Click [Change] to change the LAN settings.
 - To return to the previous window, click [Back].
- 3) Complete the detailed settings and click [Next].
 - When [Next] is clicked, the next page appears, enabling you to complete the detailed settings as desired. Settings performed here are the same as the settings performed with the [Network] menu of the projector.
- 4) Click [Submit].
 - The settings will be registered.

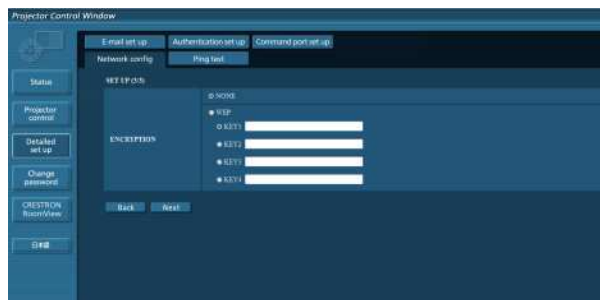
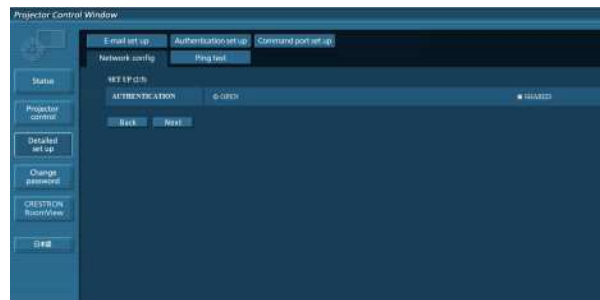
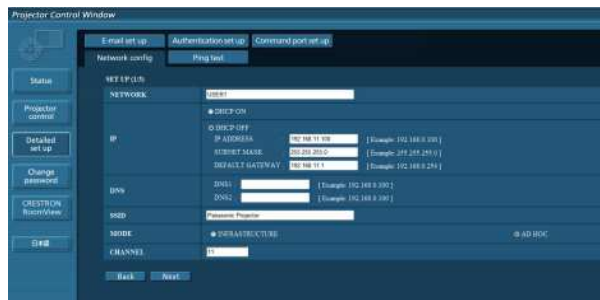

Note

- Changing the setting of LAN while connected with LAN might disconnect the connection.

■ Ping test page

This page makes it possible to check whether the network is connected to the e-mail server, POP server, DNS server, etc.

Click [Detailed set up], then [Ping test] to display the Ping test page.

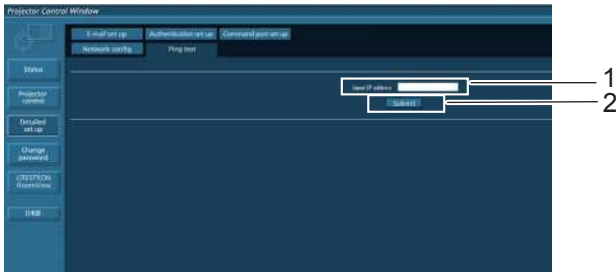

- 1 Enter the IP address of the server to be tested.
- 2 Button for conducting the test.

Display which appears when the connection was successful.

```
PING 198.245.80.20 (198.245.80.20): 56 data bytes
64 bytes from 198.245.80.20: seq=0 ttl=64 time=0.837 ms
64 bytes from 198.245.80.20: seq=1 ttl=64 time=0.483 ms
64 bytes from 198.245.80.20: seq=2 ttl=64 time=0.479 ms
64 bytes from 198.245.80.20: seq=3 ttl=64 time=0.485 ms

--- 198.245.80.20 ping statistics ---
4 packets transmitted, 4 packets received, 0% packet loss
round-trip min/avg/max = 0.478/0.571/0.837 ms
```

Display which appears when the connection failed.

```
PING 198.245.80.15 (198.245.80.15): 56 data bytes
Request timed out
Request timed out
Request timed out
Request timed out

--- 198.245.80.15 ping statistics ---
4 packets transmitted, 0 packets received, 100% packet loss
```

E-mail set up page

With this projector, if a problem occurs or if the lamp usage time reaches a set value, an e-mail message can be sent to one or more preset e-mail addresses (maximum two addresses).

Click [Detailed set up], then [E-mail set up] to display the E-mail setup page.

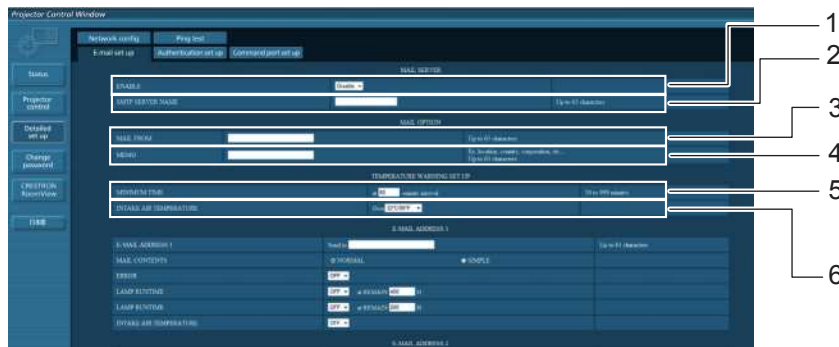

- 1 Select Enable to use the e-mail function.
- 2 Enter the IP address or server name of the e-mail server (SMTP). The DNS server must be set if the server name is entered.
- 3 Enter the e-mail address of the projector. (maximum 63 characters)
- 4 The user can enter the location of, for example, the installed projector so that the recipient may easily identify the originator of the e-mail. (maximum 63 characters)
- 5 The user can modify the minimum time interval of temperature warning mail. The default value is 60 minutes. In this case, the user cannot send another mail for 60 minutes after sending previous temperature warning mail even the set warning temperature is reached again.
- 6 Select the temperature of the intake sensor at which to send a warning message.

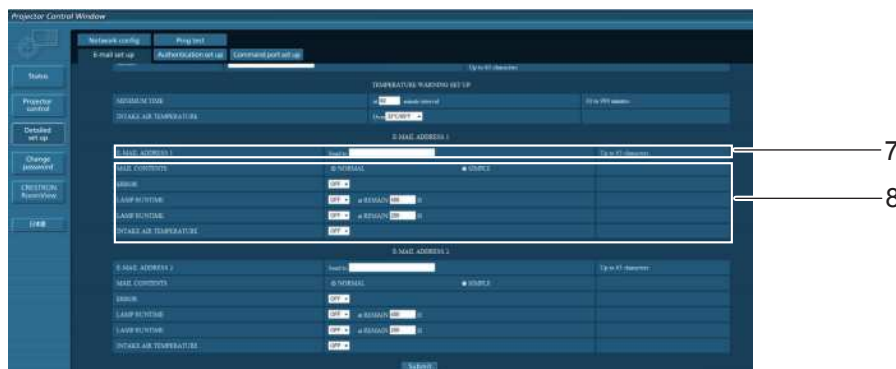

- 7 Enter the E-mail Address1 of your desired recipient.
- 8 Select the conditions for sending e-mail.

MAIL CONTENTS: Select [NORMAL] or [SIMPLE].
 ERROR: An error is detected by self-diagnosis.
 LAMP RUNTIME: Remaining lamp service time has reached the value set in the field.
 INTAKE AIR TEMPERATURE: Intake air temperature has reached the value set in the field.

E-mail set up page (continued)

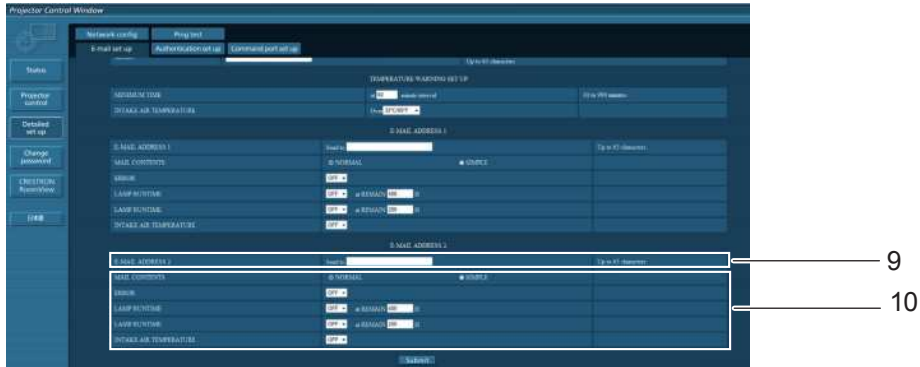

9 Enter the E-mail Address2 of your desired recipient.

10 Select the conditions for sending e-mail.

- | | |
|-------------------------|---------------------------------------------------------------------|
| MAIL CONTENTS: | Select [NORMAL] or [SIMPLE]. |
| ERROR: | An error is detected by self-diagnosis. |
| LAMP RUNTIME: | Remaining lamp service time has reached the value set in the field. |
| INTAKE AIR TEMPERATURE: | Intake air temperature has reached the value set in the field. |

Authentication set up page

The POP/SMTP server is set on this page when POP/SMTP authentication is required for mail transmissions. Click [Detailed set up], then [Authentication set up] to display the Authentication server setup page.



- 1 Select the authentication method specified by your Internet service provider.
- 2 Set this if SMTP authentication has been selected.
- 3 POP server name field
Available input characters:
Alphanumeric characters (A - Z, a - z, 0 - 9),
hyphen (-), period (.)
- 4 POP/SMTP server user name field

- 5 POP/SMTP server password field
- 6 Enter the port number for the SMTP server (normally "25").
- 7 Enter the port number for the POP server (normally "110").
- 8 Button to update settings

Contents of mail sent

- Mail with the contents shown below is sent when the e-mail settings have been established.

```

=== Panasonic projector report(CONFIGURE) ===
Projector Type      : PT-VX505N
Serial No          : 000000000
----- E-mail setup data -----
TEMPERATURE WARNING SETUP
MINIMUM TIME       at [ 60] minutes interval
INTAKE AIR TEMPERATURE Over [ 32degC / 89degF ]

ERROR              [ OFF ]
LAMP RUNTIME       [ OFF ]   at REMAIN [ 400] H
LAMP RUNTIME       [ OFF ]   at REMAIN [ 200] H
INTAKE AIR TEMPERATURE [ OFF ]

----- check system -----
FAN                [ OK   ]
INTAKE AIR TEMPERATURE [ OK   ]
EXHAUST AIR TEMPERATURE [ OK   ]
OPTICS MODULE TEMPERATURE [ OK   ]
LAMP REMAIN TIME     [ OK   ]
LAMP STATUS         [ OK   ]
APERTURE (CONTRAST-SHUTTER) [ OK   ]

(Error code 00 00 00 00 00 00 00 00)

Intake air temperature  :[ 31 degC / 87 degF ]
Exhaust air temperature  :[ 37 degC / 98 degF ]
Optics module temperature :[ 39 degC / 102 degF ]

PROJECTOR RUNTIME      1 H

LAMP ECO               500 H
LAMP NORMAL            300 H
LAMP REMAIN            2400 H

----- Current status -----
MAIN VERSION           1.00
NETWORK VERSION        1.00
LAMP STATUS            LAMP=ON
INPUT                  RGB
SIGNAL NAME            XGA6
SIGNAL FREQUENCY       0.00kHz / 0.00Hz

----- Wired Network configuration -----
DHCP Client            OFF
IP address             192.168.10.100
MAC address            04:20:9A:00:00:00

----- Memo -----

```

- Mail with the contents shown below is sent when an error has occurred.

```

=== Panasonic projector report(ERROR) ===
Projector Type       : PT-VX505N
Serial No           : 000000000
----- check system -----
FAN                 [ OK ]
INTAKE AIR TEMPERATURE [ OK ]
EXHAUST AIR TEMPERATURE [ OK ]
OPTICS MODULE TEMPERATURE [ OK ]
LAMP REMAIN TIME     [ OK ]
LAMP STATUS          [ FAILED ]
APERTURE (CONTRAST-SHUTTER) [ OK ]

(Error code 00 40 00 00 00 00 00 08)

Intake air temperature  :[ 31 degC / 87 degF ]
Exhaust air temperature :[ 37 degC / 98 degF ]
Optics module temperature :[ 39 degC / 102 degF ]

PROJECTOR RUNTIME      1 H

LAMP ECO               500 H
LAMP NORMAL            300 H
LAMP REMAIN            2400 H

----- Current status -----
MAIN VERSION          1.00
NETWORK VERSION       1.00
LAMP STATUS           LAMP=OFF
INPUT                 NETWORK

----- Wired Network configuration -----
DHCP Client          OFF
IP address           192.168.10.100
MAC address          04:20:9A:00:00:00

----- Memo -----

```

■ Command port set up page

Set the port number to be used with command control.
Click [Detailed set up] → [Command port set up].

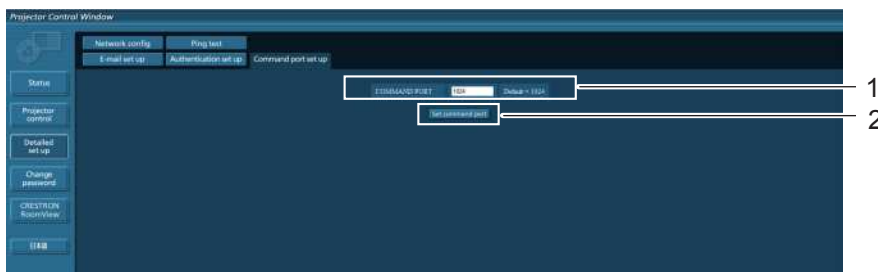

- 1 Input the port number to be used with command control
- 2 Setting update button

Change Password page

Click [Change password].



- 1 Administrator
- 2 User

Administrator mode

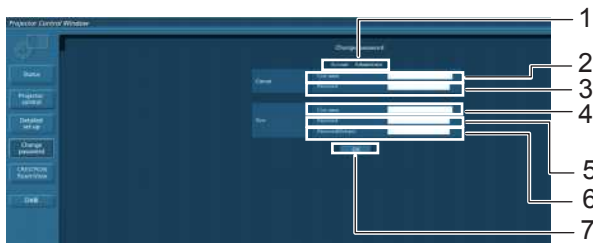

- 1 Account
- 2 Current user name input field
- 3 Current password input field
- 4 New user name input field
- 5 New password input field
- 6 New password input field (re-enter for confirmation)
- 7 Button for executing password change

User account

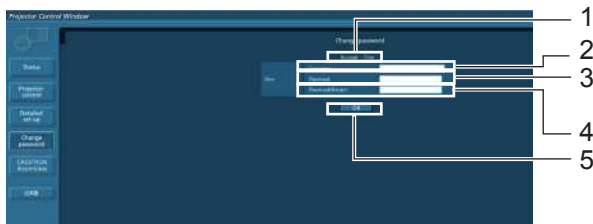

- 1 Account
- 2 New user name input field
- 3 New password input field
- 4 New password input field (re-enter for confirmation)
- 5 Button for executing password change

User mode

A user can change password only.

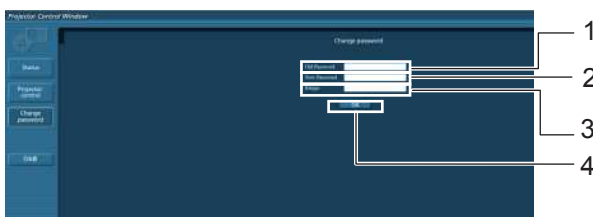

- 1 Current password input field
- 2 New password input field
- 3 New password input field (re-enter for confirmation)
- 4 Button for executing password change

Note

- When changing the administrator account, both “Current user name” and “Current password” are required.
- No account is not available .
- Administrator account and user account should be differed.

■ CRESTRON RoomView page

You can monitor or control the projector using RoomView.

To display the operation page of RoomView from Web Control screen, access with the administrator rights is required. (The [CRESTRON RoomView] button is not displayed on the Web Control screen for user rights.)

When you click [CRESTRON RoomView], the RoomView operation page is displayed.

If Adobe Flash Player is not installed in your computer, or if the browser does not support Flash, this page does not appear. In this case, return to the previous page by clicking [Back] in the operation page.

Operation page



1 Tools, Info, Help

Exit the page when the password has changed and switches the pages for tools, information, help using the tab.

2 POWER

Switches between on and off of the power.

3 VOL DOWN, AV MUTE, VOL UP

Sets the volume, AV mute. When the power of the projector is turned off, VOL DOWN, AV MUTE and VOL UP are not available.

4 Input Select

Sets the input selection. When the power of the projector is turned off, this operation is not available.

5 Operation buttons on the menu screen

Operates on the menu screen.

6 Freeze, image quality adjustment

Sets freeze, image quality details.

7 Back

Returns to the previous page.

Tools page

Click Tools on the operation page.



1 Control system

Sets the information required for the communication with the controller that is connected to the projector.

2 User Password

Sets the password for the user rights in the operation page of RoomView.

3 Admin Password

Sets the password for the administrator rights in the operation page of RoomView.

4 Network status

Displays the setting of wired LAN.

DHCP: Displays the value in the current setting.

IpAddress: Displays the value in the current setting.

SubnetMask: Displays the value in the current setting.

DefaultGateway: Displays the value in the current setting.

DNSServer: Displays the value in the current setting.

5 Exit

Return to the operation page.

Info page

Click Info on the operation page.

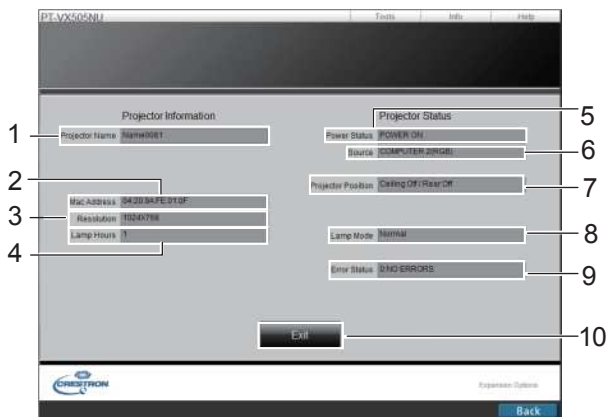

- 1 **Projector name**
Displays the name of the projector.
- 2 **Mac Address**
Displays the MAC address*.
* "Glossary" (➔ page 117 – 118)
- 3 **Resolution**
Displays the resolution of the projector.
- 4 **Lamp Hours**
Displays the lamp usage time (converted value).
- 5 **Power Status**
Displays the status of the power.
- 6 **Source**
Displays the selected video input.
- 7 **Projector Position**
Displays the projection method of the projector.
- 8 **Lamp Mode**
Displays the lamp mode.
- 9 **Error Status**
Displays the error status.
- 10 **Exit**
Return the operation page.

User mode

A user can change password only.



- 1 **Help Desk**
Sends or receive messages to the administrator who uses Crestron RoomView.

Memory Viewer function

The Memory Viewer function is to make a presentation or project an image without using computers or some other external equipment. You do not have to carry a computer or other equipment to project images.

Store images on a dedicated USB (Universal Serial Bus) thumb drive and insert it into the USB port (Series A) of the projector, then you can project those images.

Which images can be projected with the Memory Viewer function?

With the Memory Viewer function, you can project images in these formats below.

- Bitmap data
- JPEG data
- Text data

JPEG data used with Memory Viewer

Memory viewer does not support the resolution of image greater than 8191 x 8191 pixels.

Text data used with Memory Viewer

Memory viewer supports the text file with the ASCII format for single byte. Other text formats cannot be supported.

Back up the data

It is recommended that important data to edit with Network Viewer (See Wireless Manager mobile edition 6.0) and store in USB thumb drive should be stored in other media in advance. We are not responsible for any data losses or damages resulting from use of the Memory Viewer function.

■ USB thumb drive for the Memory Viewer function

Commercially available USB thumb drives can be used for this Memory Viewer function.

The USB port is compatible with USB thumb drive formatted with FAT16 or FAT32.

It is not compatible with other formats. Please note that when you format the USB thumb drive.

■ Inserting the USB thumb drive

Insert the USB thumb drive directly into the USB port on the rear terminal of the projector as shown in the figure below.

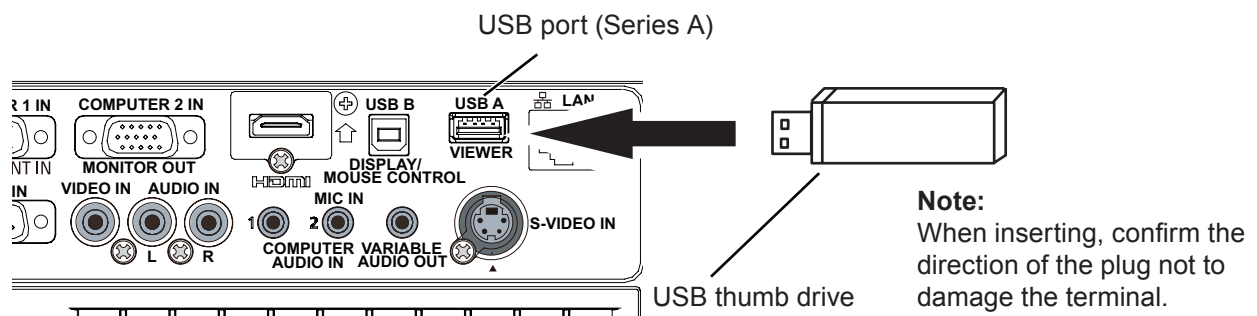

CAUTION on insertion and removal of the USB thumb drive

Please note following points to insert and remove the USB thumb drive.

- The indicator of the USB thumb drive will be blinking when it is inserted to the projector or while the projector is reading out the data. Do not remove the USB thumb drive while it is blinking.
- When using a USB thumb drive without indicator, you cannot recognize when the projector reading out the data. Please remove it from the projector after closing the memory viewer function or turning off the projector.
- Do not install and remove the USB thumb drive frequently. Remove the USB thumb drive at least 5 seconds after installation. And install at least 5 seconds after removal. While installing or removing the USB thumb drive, the projector is in switching period for those operation.



CAUTION on Handling and Storing the USB thumb drive

- Do not put USB thumb drive or its cap within close reach of children. Swallowing them may cause suffocation.
- If the smoke or questionable odor rise, turn off the peripheral equipment and contact your dealer.
- Do not put water, chemical or oil to the USB thumb drive. It may cause short out or fire.
- Do not put foreign objects or put metal objects to the USB terminal. Static electricity may cause data loss or data corruption.
- Do not remove the USB thumb drive from the computer or the projector while the USB thumb drive is reading out or writing the data. It may cause data loss or data corruption.
- Do not store the USB thumb drive where high temperature, humid or dusty place or magnetized items are around.

Direct start-up into the memory viewer mode

“Network”, and then an image stored in the root directory of the USB thumb drive is displayed on the screen.

- * If the image file is not available in the root directory of the USB thumb drive, the memory viewer browser window appears.
- * When the projector is turned off and on while the USB thumb drive is left inside in the memory viewer mode, the projector starts into the memory viewer mode and an image stored in the USB thumb drive is displayed on the screen.

When you press **<AUTO SETUP/CANCEL>** button in the memory viewer mode, the memory viewer browser window as shown on page 92 appears on the screen.

When you remove the USB thumb drive during operating the projector in the memory viewer mode, the input source returns to the previous one selected just before inserting the USB thumb drive.

Remote Control

**AUTO SETUP/CANCEL
button**

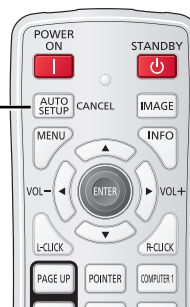

Note

- During accessing to the USB thumb drive, do not turn off the power or eject the USB thumb drive because the data in the USB thumb drive might get damaged. During accessing, the USB thumb drive is blinking.
- The USB thumb drive allows you to insert or remove regardless of the power status of the projector.
- The direct start-up into the memory viewer mode may not operate when the USB thumb drive is inserted immediately after being removed.
- During in [Multi live] mode of “Wireless Manager ME6.0”, the direct start-up into the memory viewer mode is not available. After terminating [Multi live], insert the USB thumb drive, or operate “Memory viewer” (➡ page 73).

■ Displaying the memory viewer browser window

When you press **<AUTO SETUP/CANCEL>** button in the memory viewer mode, following browser window “Thumbnail” or “Filename list” appears on the screen.

Filename list display Displays current directory path

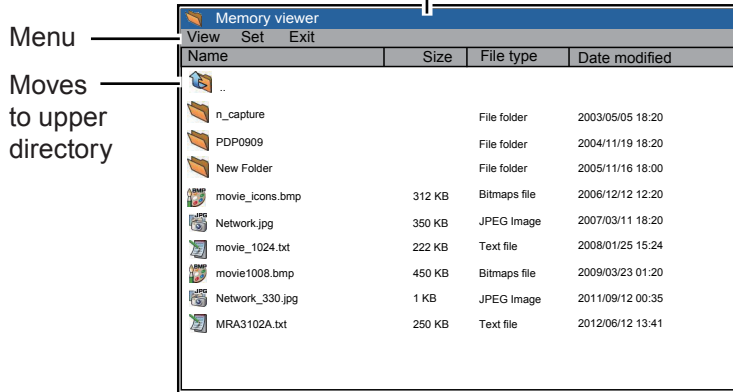



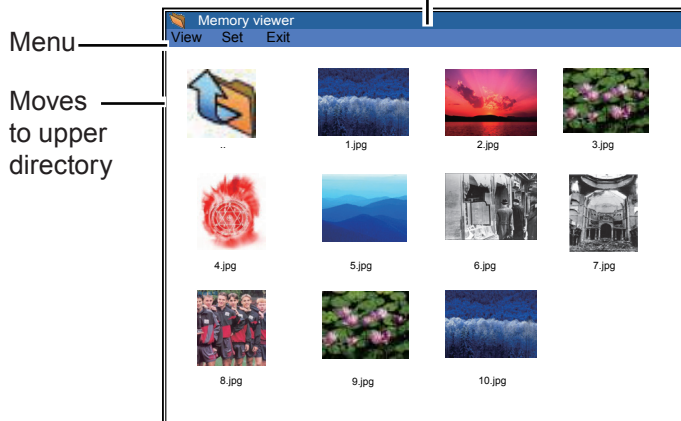

Thumbnail display Displays current directory path



- Even before the completion of thumbnail images drawing, the image selection is available by pressing point ▲▼◀▶ buttons. (Though thumbnail images drawing cannot be interrupted by pressing any of point ▲▼◀▶ buttons, the operation is valid.)
- A file more than 10MB is not displayed as thumbnails. Icons are displayed in substitution for thumbnails.
- Only JPEG, Bitmap and Text icons can be supported in the browser screen.

Icon indication

-  Folder icon. Displays the contents of the selected folder with <ENTER> button
-  Top directory icon. Moves to upper directory with <ENTER> button
-  JPEG file icon
-  Bitmap file icon
-  Text file icon

Termination of memory viewer

To terminate the memory viewer function, take one of methods described below.

- **Terminate with projector's on-screen menu.**

1. Select "Wired" or "Wireless" from the input menu of the projector. Press <ENTER> button.
2. Select "Memory Viewer" with the point ▲▼ buttons and press <ENTER> button. The "Enter/Exit" pallet of the memory viewer appears.
3. Select "Exit" and press <ENTER> button.

- **Terminate with memory viewer mode**

1. During the image displaying, press <AUTO SETUP/CANCEL> button. The browser window appears on the screen.
2. Press <AUTO SETUP/CANCEL> button again. The cursor moves to menu item.
3. Select "Exit" on the browser window with the point ◀▶ buttons and press <ENTER> button.

- **Terminate with plugged out the USB thumb directly.**

Formatting the USB thumb drive

A new USB thumb drive or a USB thumb drive formatted by computer or camera must be formatted by this product. Memory Viewer function may not operate properly with a USB thumb drive formatted by other equipment.

1. In the memory viewer mode, press <AUTO SETUP/CANCEL> button. The browser window appears on the screen.
2. Press <AUTO SETUP/CANCEL> button again. The cursor moves to menu item.
3. Select "Format" from "Set" with the point buttons and press <ENTER> button. The format confirmation window appears.
4. Select "OK" with the ◀▶ buttons and press <ENTER> button to start formatting. It takes about 1-2 seconds to complete the formatting.

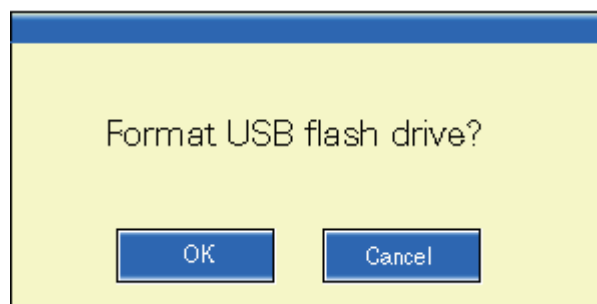

Note

- Formatting the USB thumb drive may delete all the stored data, please backup the data you need before formatting.
- During formatting the USB thumb drive, do not turn off the power or eject the USB thumb drive because the data in the USB thumb drive might get damaged. During formatting, the USB thumb drive is blinking.

LAMP and WARNING Indicators

Managing the indicated problems

If a problem should occur inside the projector, the <ON(G)/STANDBY(R)>, <LAMP> and/or <WARNING> indicators will inform you. Manage the indicated problems as follow.

CAUTION

- Before you take a remedial measure, follow the procedure of switching the power off indicated in “Turning off the projector”. (➔page 36)
- If multiple indicators light or blink, verify the status of the projector by looking at each indicator.

Note

- Confirm the status of the power indicated on the <ON(G)/STANDBY(R)> indicator.

LAMP indicator

Indicator	Lighting in yellow
Status	The projection lamp reaches its end of life.
Check	Is there a Lamp replacement icon appears on the screen?
Remedy	Replace the lamp unit. (➔page 98)

Note

- Contact your dealer for repair services when <LAMP> indicator persists to light after taking these measurements.

WARNING indicator

Indicator	Lights in red.	Blinks in red.
Status	The projector detects an abnormal condition and cannot be turned on.	If the temperature within the projector becomes too high, the <WARNING> indicator will start to flash slowly. If the temperature within the projector becomes even higher, the <WARNING> indicator will flash faster, and the <ON(G)/STANDBY(R)> indicator blinks in orange. When the projector has cooled inside and returned to operating temperature, it will turn off automatically.
Check	Unplug the AC power cord and plug it again to turn on the projector.	- Did you provide appropriate space for the projector to be ventilated? Check the installing condition to see if the air vents of the projector are not blocked. - Has the projector been installed near an Air-Conditioning/ Heating Duct or Vent? - Are the filters clean?
Remedy	If the projector is turned off again, unplug the AC power cord and contact the dealer or the service center for service and checkup.	- Provide good installing condition to your projector. - Move the installation of the projector away from the duct or vent. - Replace filters.

Note

- If <WARNING> indicator persists to light or blink after taking these measurements, please contact your dealer for repair services. Do not leave the projector on. It may cause an electric shock or a fire hazard.
- The projector detects an abnormal condition and cannot be turned on. Unplug the AC power cord and plug it again to turn on the projector. If the projector is turned off again, unplug the AC power cord and contact the dealer or the service center for service and checkup. Do not leave the projector on. It may cause an electric shock or a fire hazard.

Replacement

Before replacing the unit

- When you perform maintenance or replacement of the parts, make sure to turn off the power and disconnect the power plug from the wall outlet. (➔page 32, 36)
- Be sure to observe the procedure “Turning off the projector” (➔page 36) when performing power supply operation.

Maintenance

Outer Case

Wipe off dirt and dust using a soft dry cloth.

- If the dirt is persistent, soak the cloth with water and wring it thoroughly before wiping. Dry off the projector with a dry cloth.
- Do not use benzene, thinner, or rubbing alcohol, other solvents, household cleaners. Using them may cause deterioration of the outer case.
- When using chemical treated dusters, follow its instruction.

Front glass surface of the lens

Wipe off the dirt and dust off the front surface of the lens with soft clean cloth.

- Do not use a cloth that has an abrasive surface or a cloth that is moist, oily, or covered with dust.
- Do not use excessive force when wiping the lens as it is fragile.

Attention

- The lens is made of glass. Impacts or excessive force when wiping may scratch its surface. Please handle with care.

Replacing the unit

The air filter units are provided in side and back of the projector.

Replacement of the air filter unit (side)

1) Remove the air filter cover.

- Open the air filter cover in the direction of the arrow in the figure and remove it.

2) Remove the air filter unit.

- Hold the knob of the air filter unit and pull out in the direction of the arrow, the top of the air filter unit will pop up.
 - Take out the air filter unit upwards.
- After removing the air filter unit, remove large foreign objects and dust from the air filter compartment and the projector's air intake port if there are any.

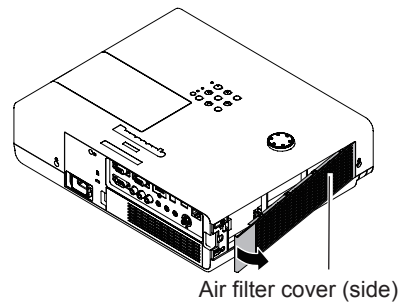

3) Insert the new air filter unit.

- Hold the air filter unit that the knob is outside of the projector, perform Step 2) in the reverse order.
- Do not press the filter part when push into the projector at last.

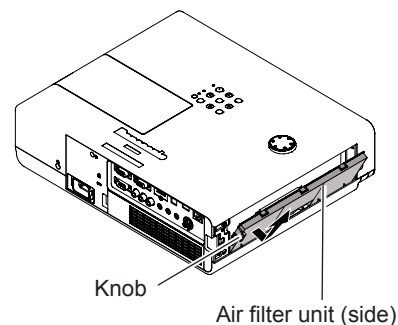

4) Install the air filter cover.

- Make sure that the air filter cover is closed tightly.

Replacement

■ Replacement of the air filter unit (back)

1) Remove the air filter cover.

- Open the air filter cover in the direction of the arrow in the figure and remove it.

2) Remove the air filter unit.

- Hold the knob of the air filter unit and pull out in the direction of the arrow.
- After removing the air filter unit, remove large foreign objects and dust from the air filter compartment and the projector's air intake port if there are any.

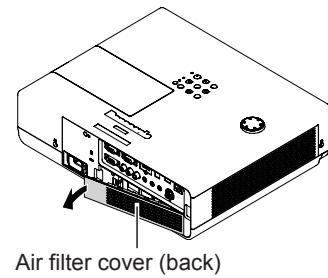

3) Insert the new air filter unit.

- Hold the air filter unit that the knob is outside of the projector, perform Step 2) in the reverse order.
- Do not press the filter part when push into the projector at last.

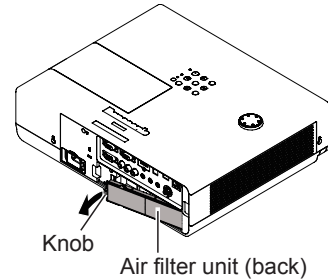

4) Install the air filter cover.

- Make sure that the air filter cover is closed tightly.

■ Resetting the Filter Counter

Be sure to reset the Filter counter after replacing the filter. (➔page 64 "Filter counter reset")

Attention

- Turn off the power before you replace the air filter units.
- When attaching the air filter unit, make sure that the projector is stable, and work in an environment that is safe, even in the event of the air filter unit dropping.
- Do not operate the projector with the air filter units removed. Dust may accumulate on the optical elements degrading picture quality.
- Do not put anything into the air vents. Doing so may result in malfunction of the projector.
- The air filter unit to be replaced should be an unused product.
- After replacing the air filter, reset the filter counter. Otherwise, the power of the projector may be turned off for safety.

Lamp unit

The lamp unit is a consumable component. You can check the total usage time using Lamp runtime in the Information menu (➔page 66).

It is recommended to ask an authorized engineer to replace the lamp unit. Contact your dealer. Consult your dealer to purchase a replacement lamp unit (ET-LAV200).

CAUTION:

- **Do not replace the lamp unit when it is hot. (Wait at least 1 hour after use.)**

The inside of the cover can become very hot, take care to avoid burn injuries.

Notes on the replacement of the lamp unit

- The luminous source of the lamp is made of glass and may burst if you hit it against a hard surface or drop it. Please handle with care.
- A Phillips screwdriver is required for replacement of the lamp unit.
- When replacing the lamp unit, be sure to hold it by the handle.
- When replacing the lamp because it has stopped illuminating, there is a possibility that the lamp may be broken. If replacing the lamp of a projector which has been installed on the ceiling, you should always assume that the lamp is broken, and you should stand to the side of the lamp cover, not underneath it. Remove the lamp cover gently. Small pieces of glass may fall out when the lamp cover is opened. If pieces of glass get into your eyes or mouth, seek medical advice immediately.
- The lamp contains mercury. Consult your local municipality or your dealer about correct disposal of used lamp units.

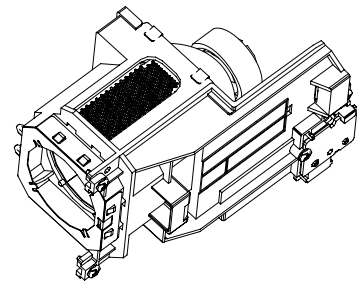



Attention

- Do not use other than designated lamp units.
- The part numbers of accessories and separately sold components are subject to change without notice.

When to replace the lamp unit

The lamp unit is a consumable component. Brightness decreases according to duration of usage, so periodical replacement of the lamp unit is necessary.

When the projection lamp of the projector reaches its end of life, the Lamp replacement icon appears on the screen and <LAMP> indicator lights yellow. Replace the lamp with a new one promptly.

Lamp runtime	On screen Lamp replacement icon 	LAMP indicator 
Over 2 500 hours *	The message is displayed for 4 seconds. If you press any button within the 4 seconds, the message disappears.	Lights in yellow (even in stand-by mode).
Over 2 700 hours *	If the power is turned on without replacing the lamp, the power automatically turns off after approximately ten minutes to prevent the malfunction of the projector.	

*2 700 hours of use is a rough guideline, but is not a guarantee. The lamp runtime differs depending on the setting of "Lamp power" menu.

Note

- The Lamp replacement icon will not appear when the [Display] function is set to [Off] (➔page 59), or during "Freeze" (➔page 40), or "AV mute" (➔page 41).

Replacement

■ Replacing the Lamp unit

CAUTION:

- When the projector is mounted on a ceiling, do not work with your face close to the projector.
- Attach the lamp unit and the lamp cover securely.
- When you experience difficulty in installing the lamp, remove it and try again. If you use force to install the lamp, the connector may be damaged.

1) Turn off the Power by following the procedure in “Turning off the projector” (→page 36). Unplug the AC power cord. Wait at least 1 hour and make sure the lamp unit and surroundings are cool.

2) Use a Phillips screwdriver to loosen the lamp cover fixing screw and remove the lamp cover.

- Remove the lamp cover by pulling it slowly toward the direction of the arrow.

3) Use a Phillips screwdriver to loosen the three lamp unit fixing screws until the screws turn freely. Hold the used lamp unit by its handles, and pull it gently from the projector.

4) Insert the new lamp unit in correct direction. Tighten the three lamp unit fixing screws securely with a Phillips screwdriver

5) Attach the lamp cover, and tighten the lamp cover fixing screw securely with a Phillips screwdriver.

- Attach the lamp cover by pushing it slowly opposite the direction of the arrow.

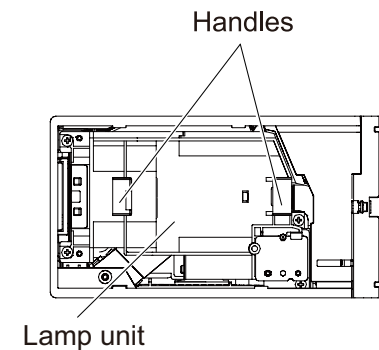
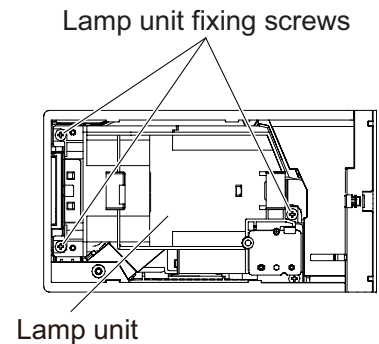
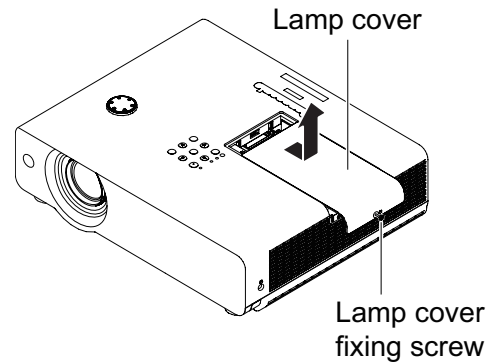

Note

- When you replace the new lamp unit (ET-LAV200), the projector resets the total usage time of the lamp unit automatically.

Attaching the Lens Cap

When moving this projector or while not using it over an extended period of time, attach the lens cap. To prevent loss for the lens cap, please according to the following procedures, attach the lens cap with the string of accessories.

- 1) Thread the thinner end of the string through the hole on the lens cap.

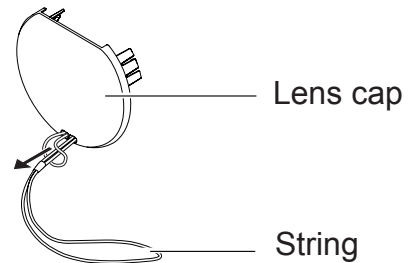

- 2) Thread the other end of the string through the hole on the bottom of the projector.

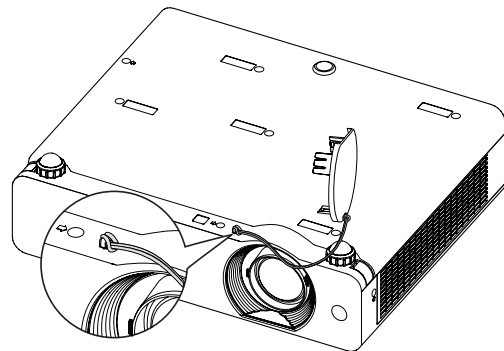

Troubleshooting

Please check following points. For details, see the corresponding pages.

Problem	Cause	Reference page
Power does not turn on.	● The power cord may not be connected.	—
	● No electric supply is at the wall outlet.	—
	● The circuit breakers have tripped.	—
	● Is the <LAMP> indicator, <ON(G)/STANDBY(R)> indicator, or <WARNING > indicator lit or blinking?	33, 94
	● The lamp cover has not been securely installed.	98
No picture appears.	● The video signal input source may not be connected to a terminal properly.	31
	● The input selection setting may not be correct.	40
	● The [Brightness] adjustment setting may be at the minimum setting.	51
	● The input source which is connected to the projector may have a problem.	—
	● The [AV Mute] function may be in use.	41
The picture is fuzzy.	● The lens cap is still attached to the lens.	19
	● The lens focus may not have been set correctly.	37
	● The projector may not be at the correct distance from the screen.	28-29
	● The lens may be dirty.	16
	● The projector may be tilted too much.	—
The color is pale or grayish.	● [Color] or [Tint] adjustment may be incorrect.	51
	● The input source which is connected to the projector may not be adjusted correctly.	—
	● RGB cable is damaged.	—
No sound from the internal speaker	● The input terminals may not have been correctly connected.	31
	● The volume may have been set to the minimum level.	38, 57
	● The [AV Mute] function may have been turned on.	41
	● When the VARIABLE AUDIO OUT is plugged-in, the projector's built-in speaker is not available.	25
	● The [Mute] function may have been turned on.	40, 57
The remote control does not operate.	● The batteries may be weak.	—
	● The batteries may not have been inserted correctly.	26
	● The remote control signal receptor on the projector may be obstructed.	22
	● The remote control unit may be out of the operation range.	22
	● Strong light such as fluorescent shine onto the signal receptor.	22
	● When different codes are set on the projector and on the remote control.	62
The control buttons of the projector do not operate.	● The control panel is not available if the control panel is locked at [Key lock] under [Security] of [Setting] section.	63
The picture does not display correctly.	● There may be a problem with the VCR or other signal source.	—
	● A signal which is not compatible with the projector is being input.	110-113
Picture from a computer does not appear.	● The cable may be longer than the optional cable.	—
	● The external video output from a laptop computer may not be correct.	—

Problem	Cause	Reference page
Picture from a HDMI device does not appear or picture is not stable.	● Is the HDMI cable securely connected?	31
	● Turn off the power of the projector and the connected devices. Then turn the power of the projector and the connected devices back on.	—
	● Isn't unsupported signal cable connected?	110-113
No sound is output from a HDMI device.	● Set the sound channel of the attached device to Linear PCM.	—
	● If no audio signal is output during HDMI cable connection, connect the audio cable to COMPUTER AUDIO IN 2 terminal and set to "Computer 2" in "Sound" of "Setting" menu.	60
The image is distorted or runs off.	● Check [PC adj.] or [Screen] and adjust them.	48, 54
The exclamation mark  appears on the screen.	● Your operation is invalid. Operate correctly.	—

Note

- If the problem persists, after confirming the contents of the table, please consult your dealer.

Technical Information

PJLink protocol

The network function of the projector supports PJLink class 1, and the PJLink protocol can be used to perform projector setting and projector status query operations from a computer.

■ Control commands

The following table lists the PJLink protocol commands that can be used to control the projector.

Command	Control details	Notes
POWR	Power supply control	Parameters 0 = Standby 1 = Power ON
POWR ?	Power supply status query	Parameters 0 = Standby 1 = Power ON 2 = Cool-down in progress 3 = Warm-up in progress
INPT	Input selection	Parameters
INPT ?	Input selection query	11 = RGB 1 12 = RGB 2 13 = SCART 21 = VIDEO 22 = S-VIDEO 23 = COMPONENT 31 = HDMI 51 = Network
AVMT	AV MUTE control	Parameters
AVMT ?	AV MUTE status query	30 = AV MUTE mode off 31 = AV MUTE mode on
ERST ?	Error status query	Parameters 1st byte : Indicates fan errors, range 0 – 2 2nd byte : Indicates lamp errors, range 0 – 2 3rd byte : Indicates temperature errors, range 0 – 2 4th byte : Fixed at 0 5th byte : Indicates filter errors, range 0 – 2 6th byte : Indicates other errors, range 0 – 2 Definitions for each value from 0 to 2 are as follows. 0 = No error known 1 = Warning 2 = Error
LAMP ?	Lamp status query	Parameters 1st digits (1 – 5 digits) : Lamp cumulative operating time 2nd digit : 0 = Lamp off, 1 = Lamp on
INST ?	Input selection list query	The followings are returned as parameters. "11, 12, 13, 21, 22, 23, 31, 51"
NAME ?	Projector name query	The name set for [Projector name] in [Network] is returned.
INF1 ?	Manufacturer name query	"Panasonic" is returned.
INF2 ?	Model name query	Answer the model name with "VX505N" or "VW435N".
INF0 ?	Other information query	Information such as version number is returned.
CLSS ?	Class information query	"1" is returned.

■ PJLink security authorization

When using PJLink with security authorization, either of the password set for administrator privileges and the password set for user privileges with Web browser control can be used as the password for PJLink (➔page 87). When using PJLink without security authorization, set use without the password for administrator privileges and the password for user privileges of Web browser control.

For specifications regarding PJLink, refer to the Japan Business Machine and Information System Industries Association website.

<http://pjlink.jbmia.or.jp/>

Control commands via LAN

■ When WEB Control administrator rights password is set (Protect mode)

● Connection method

- 1) Obtain the IP address and port number (Initial set value = 1 024) of the projector and make a request for connection to the projector.

Acquire the IP address from the menu screen of the projector, and the port number from the WEB control page.

IP address : Obtain from MAIN MENU → [Network] → [Network status]

Port No. : Acquire from the WEB control “Detailed set up” → “Command port set up” page

- 2) There is a response from the projector.

Response data

Data section	Blank	Mode	Blank	Random number section	Termination symbol
“NTCONTROL” (ASCII string)	‘ ’ 0x20	‘1’ 0x31	‘ ’ 0x20	“zzzzzzzz” (ASCII code hexadecimal number)	(CR) 0x0d
9 bytes	1 byte	1 byte	1 byte	8 bytes	1 byte

Mode : 1 = Protect mode

- 3) Generate a 32-byte hash value from the following data using MD5 algorithm.

“xxxxxx:yyyyy:zzzzzzzz”

xxxxxx : Administrator rights user name for WEB CONTROL (Default user name is “admin1”)

yyyyy : Password of above administrator rights user (Default password is “panasonic”)

zzzzzzzz : 8-byte random number obtained in Step 2

● Command transmission method

Transmit using the following command format.

Transmitted data

Header		Data section	Termination symbol
Hash value (See above <Connection method>)	‘0’ 0x30	Control command (ASCII string)	(CR) 0x0d
32 bytes	1 byte	Undefined length	1 byte

Receive data

Header	Data section	Termination symbol
‘0’ 0x30	Control command (ASCII string)	(CR) 0x0d
1 byte	Undefined length	1 byte

Error response

Error message	Termination symbol
“ERR1” “ERR2” “ERR3” “ERR4” “ERR5” “ERRA”	(CR) 0x0d
Undefined control command Out of parameter range Busy state or no-acceptable period Timeout or no-acceptable period Wrong data length Password mismatch	
4 bytes	1 byte

■ When WEB Control administrator rights password is not set (Non-protect mode)

● Connection method

- 1) Obtain the IP address and port number (Initial set value = 1 024) of the projector and make a request for connection to the projector.

Acquire the IP address from the menu screen of the projector, and the port number from the WEB control page.

IP address : Obtain from MAIN MENU → [Network] → [Network status]

Port No. : Acquire from the WEB control “Detailed set up” → “Command port set up” page

- 2) There is a response from the projector.

Response data

Data section	Blank	Mode	Termination symbol
“NTCONTROL” (ASCII string)	‘ ’ 0x20	‘0’ 0x30	(CR) 0x0d
9 bytes	1 byte	1 byte	1 byte

Mode : 0 = Non-protect mode

● Command transmission method

Transmit by the following command format.

Transmitted data

Header		Data section	Termination symbol
‘0’ 0x30	‘0’ 0x30	Control command (ASCII string)	(CR) 0x0d
1 byte	1 byte	Undefined length	1 byte

Receive data

Header		Data section	Termination symbol
‘0’ 0x30	‘0’ 0x30	Control command (ASCII string)	(CR) 0x0d
1 byte	1 byte	Undefined length	1 byte

Receive data

Error message	Termination symbol
“ERR1” “ERR2” “ERR3” “ERR4” “ERR5” “ERRA”	(CR) 0x0d
Undefined control command Out of parameter range Busy state or no-acceptable period Timeout or no-acceptable period Wrong data length Password mismatch	
4 bytes	1 byte

Serial terminal

The serial connector which is on the connector panel of the projector conforms to the RS-232C interface specification, so that the projector can be controlled by a personal computer which is connected to this connector.

■ Connection

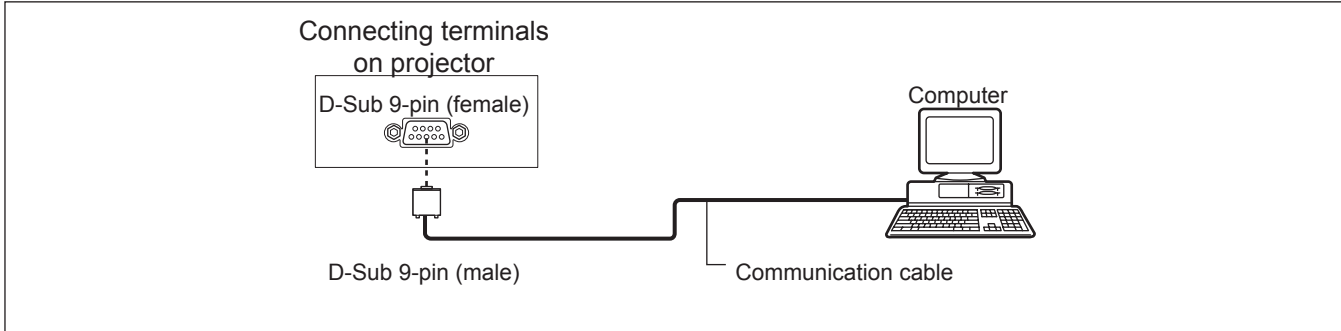

■ Pin assignments and signal names

D-Sub 9-pin (female) Outside view	Pin No.	Signal name	Contents
	①	—	NC
	②	TXD	Transmitted data
	③	RXD	Received data
	④	—	NC
	⑤	GND	Earth
	⑥	—	NC
	⑦	RTS	Connected internally
	⑧	CTS	
	⑨	—	NC

■ Communication conditions

Signal level	RS-232C-compliant
Sync. method	Asynchronous
Baud rate	19 200 bps
Parity	None

Character length	8 bits
Stop bit	1 bit
X parameter	None
S parameter	None

Note

- When [AMX D. D.] function is set to [On] under the [Network] menu, the Baud rate will change to 9 600 bps automatically.

Basic format

Transmission from the computer begins with STX, then the command, parameter, and ETX are sent in this order. Add parameters according to the details of control.

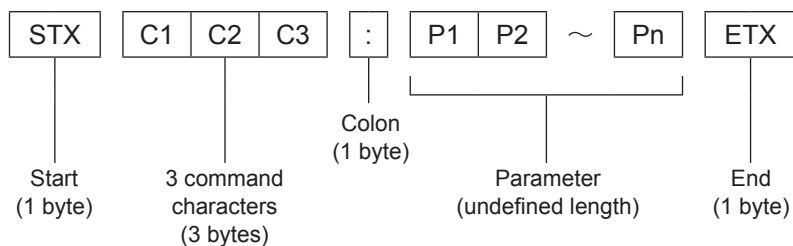

*: When sending commands without parameters, a colon (:) is not necessary.

Basic format (with sub command)

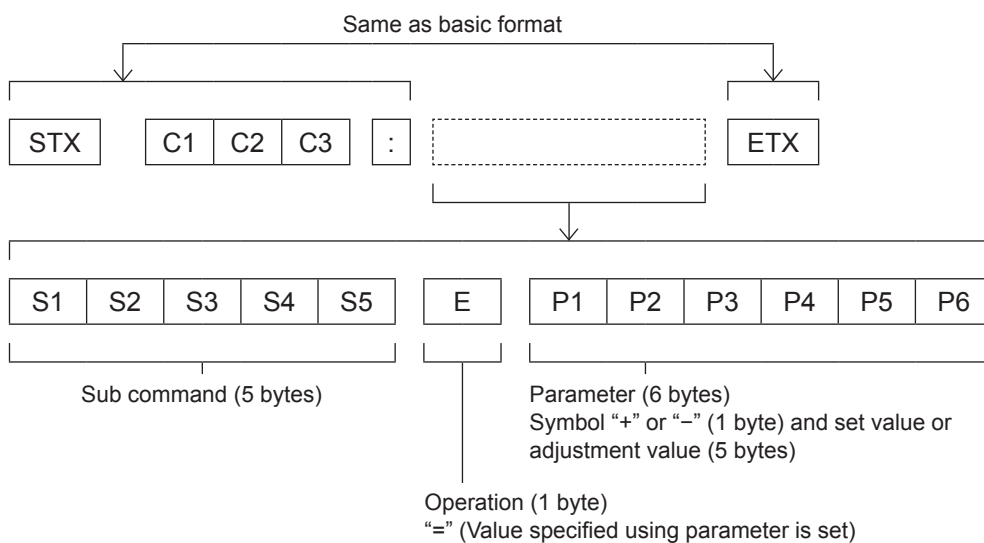

*: When transmitting a command which does not need a parameter, the operation (E) and parameter are not necessary.

■ Cable specifications

[When connected to a computer]

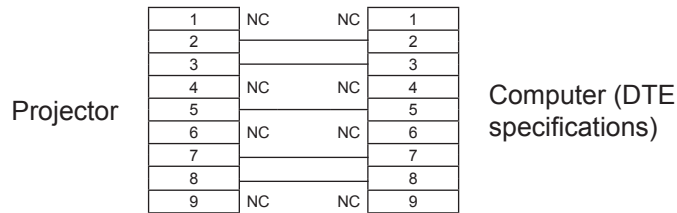

■ Control commands

When controlling the projector from a computer, the following commands are available:

[Projector control command]

Command	Control contents	Remarks
PON	Power [ON]	
POF	Power [OFF]	
IIS	INPUT selection	(Parameter) VID = Video SVD = S-video RG1 = Computer 1(RGB) RG2 = Computer 2(RGB) HD1 = HDMI SCT = Computer 1(Scart) NWP = Network
OSH	AV mute function	Turn off the projection and sound temporarily. Do not send the command consecutively. (Parameter) 0 = AV MUTE mode off 1 = AV MUTE mode on
OFZ	Freeze	(Parameters) 0 = Freeze mode off 1 = Freeze mode on
AUU	Volume up	
AUD	Volume down	
DZU	D. ZOOM up	
DZD	D. ZOOM down	
QPW	Power query	000 = Standby 001 = Power on
Q\$\$	Lamp condition query	(Call back) 0 = Stand-by 1 = Lamp ON control active 2 = Lamp ON 3 = Lamp OFF control active

Other terminals

Pin assignments and signal names of <S-VIDEO IN> terminal

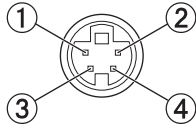
Outside view	Pin No.	Signal names
	①	GND (luminance signal)
	②	GND (color signal)
	③	Luminance signal
	④	Color signal

Pin assignments and signal names of <COMPUTER 1 IN/COMPONENT IN> terminal

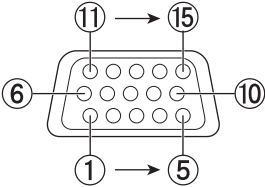
Outside view	Pin No.	Signal names	
	①	R/P _R	
	②	G/G · SYNC/Y	
	③	B/P _B	
	⑨	+ 5 V	
	⑫	DDC data	
	⑬	HD/SYNC	
	⑭	VD	
	⑮	DDC clock	
	④		④ : Not assigned
	⑤ - ⑧, ⑩, ⑪		⑤ - ⑧, ⑩, ⑪ : GND terminals

Pin assignments and signal names of <COMPUTER 2 IN/MONITOR OUT> terminal

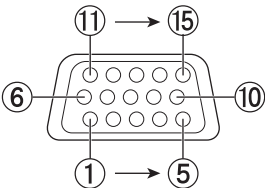
Outside view	Pin No.	Signal names
	①	R/P _R
	②	G/G · SYNC/Y
	③	B/P _B
	⑬	HD/SYNC
	⑭	VD
	④, ⑨, ⑪, ⑫, ⑮	
⑤ - ⑧, ⑩		⑤ - ⑧, ⑩ : GND terminals

Pin assignments and signal names of <HDMI> terminal

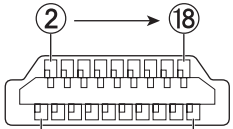
Outside view	Pin No.	Signal names	Pin No.	Signal names
<p>Even-numbered pins ② to ⑮</p>  <p>Odd-numbered pins ① to ⑮</p>	①	T.M.D.S data 2+	⑪	T.M.D.S clock shield
	②	T.M.D.S data 2 shield	⑫	T.M.D.S clock -
	③	T.M.D.S data 2-	⑬	CEC
	④	T.M.D.S data 1+	⑭	—
	⑤	T.M.D.S data 1 shield	⑮	SCL
	⑥	T.M.D.S data 1-	⑯	SDA
	⑦	T.M.D.S data 0+	⑰	DDC/CEC GND
	⑧	T.M.D.S data 0 shield	⑱	+5V
	⑨	T.M.D.S data 0-		Hot plug detection
	⑩	T.M.D.S clock +		

■ USB CONNECTOR (Type A)

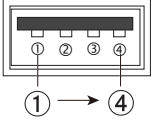
Outside view	Pin No.	Signal names
	①	+5V
	②	- Data
	③	+Data
	④	GND

■ USB CONNECTOR (Type B)

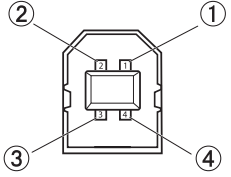
Outside view	Pin No.	Signal names
	①	+5V
	②	- Data
	③	+Data
	④	GND

Technical Information

List of compatible signals

The following table specifies the types of signals compatible with the projectors.

Format : V = VIDEO, S = S-VIDEO, C = COMPUTER, Y = YP_BP_R, H = HDMI

Mode	Display resolution *1 (dots)	Scanning frequency		Dot clock frequency (MHz)	Picture quality *2		PnP *3	Format
		H (kHz)	V (Hz)		PT-VW435NEA	PT-VX505NEA		
NTSC/NTSC 4.43/ PAL-M/PAL 60	720 x 480	15.7	59.9	--	A	A		V/S
PAL/PAL-N/SECAM	720 x 576	15.6	60.0	--	A	A		V/S
480p	640 x 480	31.47	59.88	25.2	A	A		C/Y
480i	640 x 480i	15.734	60.00	12.2727	A	A		
576p	768 x 576	31.25	50.00	29.5	A	A		
576i	768 x 576i	15.625	50.00	14.75	A	A		
720p	1 280 x 720	37.50	50.00	74.25	AA	A		
		45.00	60.00	74.25	AA	A		
1 035i	1 920 x 1 035i	33.75	60.00	74.25	A	A		
1 080i	1 920 x 1 080i	28.125	50.00	74.25	A	A		
		33.75	60.00	74.25	A	A		
VGA	640 x 480	31.47	59.88	25.149	A	A	○	
		37.86	74.38	31.50	A	A		
		37.86	72.81	31.50	A	A	○	
		37.50	75.00	31.50	A	A	○	
		43.269	85.00	36.00	A	A		
	640 x 400	31.47	70.09	25.175	A	A		
720 x 400	31.47	70.09	28.322	A	A			
SVGA	800 x 600	35.156	56.25	36.00	A	A	○	
		37.88	60.32	40.00	A	A	○	
		46.875	75.00	49.50	A	A	○	
		53.674	85.06	56.25	A	A		
		48.08	72.19	50.00	A	A	○	
		37.90	61.03	40.02	A	A		
		34.50	55.38	36.432	A	A		
		38.00	60.51	40.128	A	A		
		38.60	60.31	38.60	A	A		
		32.70	51.09	32.70	A	A		
38.00	60.51	40.128	A	A				
MAC	1 280 x 960	75.00	75.08	126.00	A	A		
	1 280 x 1 024	80.00	75.08	135.20	A	A		
MAC 13	640 x 480	35.00	66.67	30.24	A	A		
MAC LC13		34.97	66.60	31.33	A	A		
MAC 16	832 x 624	49.72	74.55	57.283	A	A		
MAC 19	1 024 x 768	60.24	75.08	80.01	A	A		
MAC 21	1 152 x 870	68.68	75.06	100.00	A	A		

*1 : "i" added to the resolution value indicates an interlaced signal.

*2 : Picture quality is indicated by the following symbols.

AA: Maximum picture quality can be obtained.

A: Signals are converted by the image processing circuit.

Mode	Display resolution *1 (dots)	Scanning frequency		Dot clock frequency (MHz)	Picture quality *2		PnP *3	Format
		H (kHz)	V (Hz)		PT-VW435NEA	PT-VX505NEA		
SXGA+	1 400 x 1 050	63.970	60.190	107.990	A	A		C
		65.350	60.120	122.850	A	A		
		65.120	59.900	122.430	A	A		
XGA	1 024 x 768	48.36	60.00	65.00	A	AA	○	
		68.677	84.977	94.504	A	AA		
		60.023	75.03	78.75	A	AA	○	
		56.476	70.07	75.00	A	AA	○	
		60.31	74.92	79.252	A	AA		
		48.50	60.02	65.179	A	AA		
		44.00	54.58	59.129	A	AA		
		63.48	79.35	83.41	A	AA		
		62.04	77.07	84.375	A	AA		
		61.00	75.70	81.00	A	AA		
	46.90	58.20	63.03	A	AA			
	47.00	58.30	61.664	A	AA			
	58.03	72.00	74.745	A	AA			
	1 024 x 768i	36.00	87.17	47.30	A	AA		
35.522		86.96	44.90	A	AA			
SXGA	1 152 x 864	64.20	70.40	94.560	A	A		
	1 152 x 900	61.20	65.20	92.00	A	A		
		71.40	75.60	105.10	A	A		
		61.85	66.00	94.50	A	A		
	1 280 x 960	60.00	60.00	108.00	A	A		
	1 280 x 1 024	62.50	58.60	108.00	A	A		
		63.90	60.00	107.35	A	A		
		63.34	59.98	108.18	A	A		
		63.74	60.01	109.497	A	A		
		71.69	67.19	117.004	A	A		
		81.13	76.107	135.008	A	A		
		63.98	60.02	108.00	A	A		
		79.976	75.025	135.00	A	A		
		63.37	60.01	111.520	A	A		
		76.97	72.00	130.08	A	A		
	63.79	60.18	108.19	A	A			
	91.146	85.024	157.5	A	A			
1 280 x 1 024i	50.00	86.00	80.00	A	A			
	50.00	94.00	80.00	A	A			
	46.43	86.70	78.745	A	A			
UXGA	1 600 x 1 200	75.00	60.00	162.00	A	A		
		81.25	65.00	175.50	A	A		
		87.5	70.00	189.00	A	A		
		93.75	75.00	202.50	A	A		

*1 : "i" added to the resolution value indicates an interlaced signal.

*2 : Picture quality is indicated by the following symbols.

AA: Maximum picture quality can be obtained.

A: Signals are converted by the image processing circuit.

Technical Information

Mode	Display resolution *1 (dots)	Scanning frequency		Dot clock frequency (MHz)	Picture quality *2		PnP *3	Format
		H (kHz)	V (Hz)		PT-VW435NEA	PT-VX505NEA		
WXGA	1 280 x 768	47.776	59.870	79.500	AA	A		C
		60.289	74.893	102.250	AA	A		
		68.633	84.837	117.500	AA	A		
		55.993	69.991	94.964	AA	A		
		57.675	72.004	97.817	AA	A		
	1 280 x 800	49.600	60.050	79.360	AA	A		
		41.200	50.000	68.557	AA	A		
		49.702	59.810	83.500	AA	A	○	
		63.980	60.020	108.000	AA	A		
		58.289	69.975	98.858	AA	A		
		60.044	71.995	102.795	AA	A		
		62.790	74.928	106.492	AA	A		
	71.553	84.879	122.498	AA	A			
	1 366 x 768	48.36	60.00	86.67	A	A		
	1 360 x 768	47.70	60.00	86.67	A	A		
		56.16	72.00	100.19	A	A		
1 376 x 768	48.36	60.00	86.67	A	A			
WSXGA+	1 680 x 1 050	65.290	59.954	146.250	A	A		
WXGA+	1 440 x 900	55.935	59.887	106.500	A	A		
		74.918	60.000	161.850	A	A		
WUXGA	1 920 x 1 200	74.556	59.885	193.250	A	A		
		74.038	59.950	154.000	A	A		
D-VGA	640 x 480	31.47	59.94	25.175	A	A	○	
D-480p		31.47	59.88	25.2	A	A	○	
D-576p	768 x 576	31.25	50.00	29.5	A	A	○	
D-720p	1 280 x 720	37.50	50.00	74.25	AA	A	○	
		45.00	60.00	74.25	AA	A	○	
D-SVGA	800 x 600	37.879	60.32	40	A	A	○	
D-XGA	1 024 x 768	43.363	60.00	65	A	AA	○	
D-SXGA+	1 400 x 1 050	63.97	60.19	107.99	A	A		
		65.350	60.120	122.850	A	A		
		65.120	59.900	122.430	A	A		

*1 : “i” added to the resolution value indicates an interlaced signal.

*2 : Picture quality is indicated by the following symbols.

AA: Maximum picture quality can be obtained.

A: Signals are converted by the image processing circuit.

Mode	Display resolution *1 (dots)	Scanning frequency		Dot clock frequency (MHz)	Picture quality *2		PnP *3	Format
		H (kHz)	V (Hz)		PT-VW435NEA	PT-VX505NEA		
D-WXGA	1 360 x 768	47.700	60.00	86.670	A	A		H
		56.160	72.000	100.190	A	A		
	1 366 x 768	46.500	50.000	67.400	A	A		
		48.360	60.00	86.670	A	A		
	1 376 x 768	48.360	60.00	86.670	A	A		
	1 280 x 768	47.776	59.870	79.500	AA	A		
		60.289	74.893	102.250	AA	A		
		68.633	84.837	117.500	AA	A		
		55.993	69.991	94.964	AA	A		
	1 280 x 800	57.675	72.004	97.817	AA	A		
		49.572	59.870	83.282	AA	A		
		41.200	50.000	68.557	AA	A		
		49.702	59.810	83.500	AA	A	○	
		63.980	60.020	108.000	AA	A		
		58.289	69.975	98.858	AA	A		
60.044		71.995	102.795	AA	A			
D-SXGA	1 280 x 1 024	62.790	74.928	106.492	AA	A		
		71.553	84.879	122.498	AA	A		
		63.98	60.02	108	A	A		
D-1035i	1 920 x 1 035i	60.276	58.069	93.067	A	A		
		31.65	29.8	53.48	A	A		
D-1080i	1 920 x 1 080i	33.75	60.00	74.25	A	A		
		28.125	50.00	74.25	A	A	○	
D-1080p	1 920 x 1 080	33.75	60.00	74.25	A	A	○	
		67.5	60.00	148.5	A	A		
D-WXGA+	1 440 x 900	56.25	50.00	148.5	A	A		
		55.935	59.887	106.500	A	A		
D-WSXGA+	1 680 x 1 050	65.290	59.954	146.250	A	A		
D-WUXGA	1 920 x 1 200	74.038	59.950	154.000	A	A		

*1 : "i" added to the resolution value indicates an interlaced signal.

*2 : Picture quality is indicated by the following symbols.

AA: Maximum picture quality can be obtained.

A: Signals are converted by the image processing circuit.

*3 : Where marked "○" signals indicates in Plug and Play is compatible with EDID of projector. Unmarked signals in Plug and Play may also be compliant if input terminals are written in the format list. Where Plug and Play is unmarked and nothing is written in the format list, difficulties in projecting image may occur even when computer and projector appear to have same resolution.

Note

- The number of display dots is 1 280 x 800 for the PT-VW435NEA and 1 024 x 768 for the PT-VX505NEA. A signal with a different resolution will be projected after converting the resolution to match the projector display.
- When interlaced signals are connected, flicker may occur on the projected image.

Specifications

Model No.		PT-VW435NEA	PT-VX505NEA
Power supply		AC100 V - 240 V 50 Hz/60 Hz	
Power consumption		100 V - 240 V 4.0 A-1.6 A 365 W	
		When [Standby mode] of [Setting] is set to [ECO]: 0.3W	
		When [Standby mode] of [Setting] is set to [Network]: 12.9W or less	
		When [Standby MIC out] of [Sound] is set to [On]: Max.26 W	
LCD panel	Panel size	1.5 cm(0.59") (aspect ratio 16 : 10)	1.6 cm(0.63") (aspect ratio 4 : 3)
	Display method	3 transparent LCD panels (RGB)	
	Drive method	Active matrix method	
	Pixels	1 024 000 (1 280 x 800) x 3 panels	786 432 (1 024 x 768) x 3 panels
Lens		Manual zoom (1.6x) / Manual focus / Lens shift F 1.6 to 2.12, f 15.28 mm to 24.62 mm	
Luminous lamp		280 W UHM lamp	
Light output *1		4 300 lm	5 000 lm
Applicable scanning frequency *3	for RGB signal	Horizontal 15 kHz to 100 kHz, Vertical 50 Hz to 100 Hz	
		Dot clock frequency: 140 MHz or less	
	for YP _B P _R signal	[525i(480i)] Horizontal 15.75 kHz, Vertical 60 Hz [525p(480p)] Horizontal 31.5 kHz, Vertical 60 Hz [750(720)/60p] Horizontal 45 kHz, Vertical 60 Hz [1125(1080)/60i] Horizontal 33.75 kHz, Vertical 60 Hz [625i(576i)] Horizontal 15.63 kHz, Vertical 50 Hz [625p(576p)] Horizontal 31.25 kHz, Vertical 50 Hz [750(720)/50p] Horizontal 37.5 kHz, Vertical 50 Hz [1125(1080)/50i] Horizontal 28.13 kHz, Vertical 50 Hz ● HD/SYNC and V terminals are not compliant with 3 value composite SYNC	
	for Video signal (including S-video)	Horizontal 15.75 kHz / 15.63 kHz, Vertical 50 Hz / 60 Hz	
	for HDMI signal	525p(480p), 625p(576p), 750(720)/60p, 750(720)/50p, 1 125(1 080)/60p, 1 125(1 080)/50p, 1 125(1 080)/60i, 1 125(1 080)/50i ● Displayable resolution: VGA to WUXGA (non-interlace) ● Dot clock frequency: up to 162 MHz	
Color system		7 (NTSC, NTSC4.43, PAL, PAL-N, PAL-M, SECAM, PAL60)	
Projection size		0.76 m -7.62 m (30"-300")	
Screen aspect ratio		16 : 10	4 : 3
Projection scheme		Front / Rear / Mount on Ceiling / Floor (Menu setting system)	
Speaker		1 (4.0 cm round-type)	
Maximum usable volume output		10W	
Contrast ratio *2		3 500 : 1 (all white / all black)	4 000 : 1 (all white / all black)

*1 : These values of light output are measured under the condition that [Lamp power] is set to [Normal], [Image select] is set to [Dynamic] and [Lens Shift] is adjusted to the lowest level. Measurement, measuring conditions and method of notation all comply with ISO21118 international standards.

*2 : The value of contrast ratio is measured under the condition that [Lamp power] is set to [Normal], [Image select] is set to [Dynamic], [Lens Shift] is adjusted to the lowest level and [Iris] is set to [On]. Measurement, measuring conditions and method of notation all comply with ISO21118 international standards.

*3 : For details of video signals that can be projected using this projector, refer to "List of compatible signals".
(➡page 110-113)

Specifications

Model No.		PT-VW435NEA	PT-VX505NEA
Terminals	COMPUTER 1 IN/ COMPONENT IN	1 (D-sub 15 pin female) [RGB signal] 0.7 V [p-p] 75 Ω (When G-SYNC: 1.0 [p-p] 75 Ω HD/SYNC TTL high impedance, automatic positive/negative polarity compatible VD TTL high impedance, automatic positive/negative polarity compatible [YPbPr signal] Y: 1.0 V [p-p] including synchronization signal, PbPr: 0.7 V [p-p] 75 Ω	
	COMPUTER 2 IN/ MONITOR OUT	[RGB signal] 0.7 V [p-p] 75 Ω (When G-SYNC: 1.0 [p-p] 75 Ω HD/SYNC TTL high impedance, automatic positive/negative polarity compatible VD TTL high impedance, automatic positive/negative polarity compatible	
	VIDEO IN	1 (RCA pin jack 1.0 V [p-p] 75 Ω)	
	S-VIDEO IN	1 (Mini DIN 4 pin, Y 1.0 V [p-p], C 0.286 V [p-p] 75 Ω, S1 signal compatible)	
	HDMI	1 (HDMI 19 pin, HDCP and Deep color compatible)	
	AUDIO IN	2 (M3 stereo mini jack, 0.5 V [rms], input impedance 22 kΩ and more) 1 (RCA pin jack x 2 (L-R), 0.5 V [rms], input impedance 22 kΩ and more)	
	VARIABLE AUDIO OUT	1 (M3 stereo mini jack, stereo monitor output compatible, 0 V [rms] to 2.0 V [rms] valuable, output impedance 2.2 kΩ and less)	
	SERIAL IN	1 (D-sub 9 pin, RS-232C compliant, for computer control use)	
	LAN	1 (for RJ-45 network connection, PLink compatible,)	
Power cable length		2.0 m(78 3/4")	
Cabinet		Molded plastic	
Dimensions		Width: 379mm (14.92") Height: 107 mm (4.21") (when front adjustable feet shortened) Depth: 305 mm (12.01") (excluding protractions)	
Weight		Approx.4.8 kg(10.58 lbs.) *4	
Operating environment		Operating environment temperature*5: 0 °C (32 °F) to 40 °C (104 °F) (Elevation: below 1 200 m; [Fan control]: [Off]) 0 °C (32 °F) to 30 °C (86 °F) (Elevation: 1 200 m ~ 2 000m; [Fan control]: [On 1]) 0 °C (32 °F) to 30 °C (86 °F) (Elevation: 2 000 m ~ 2 700m; [Fan control]: [On 2]) Operating environment humidity: 20 % to 80 % (no condensation)	
Remote control	Power supply	DC 3 V (battery (AAA/R03 or AAA/LR03 Type) x 2)	
	Operating range	Approx. 7 m (275.6") (when operated directly in front of receptor)	
	Weight	102 g (3.60 ozs.) (including batteries)	
	Dimensions	Width : 48 mm (1.89"), Length : 145 mm (5.71"), Height : 27 mm (1.06")	

*4 : This is an average value. It may differ depending on individual product.

*5 : If [Lamp power] is set to [Normal] and the operating environment temperature exceeds 35°C(95 °F), [Lamp power] may be changed to [Eco] automatically.

- The part numbers of accessories and separately sold components are subject to change without notice.

Specifications

Dimensions

<Unit : mm>

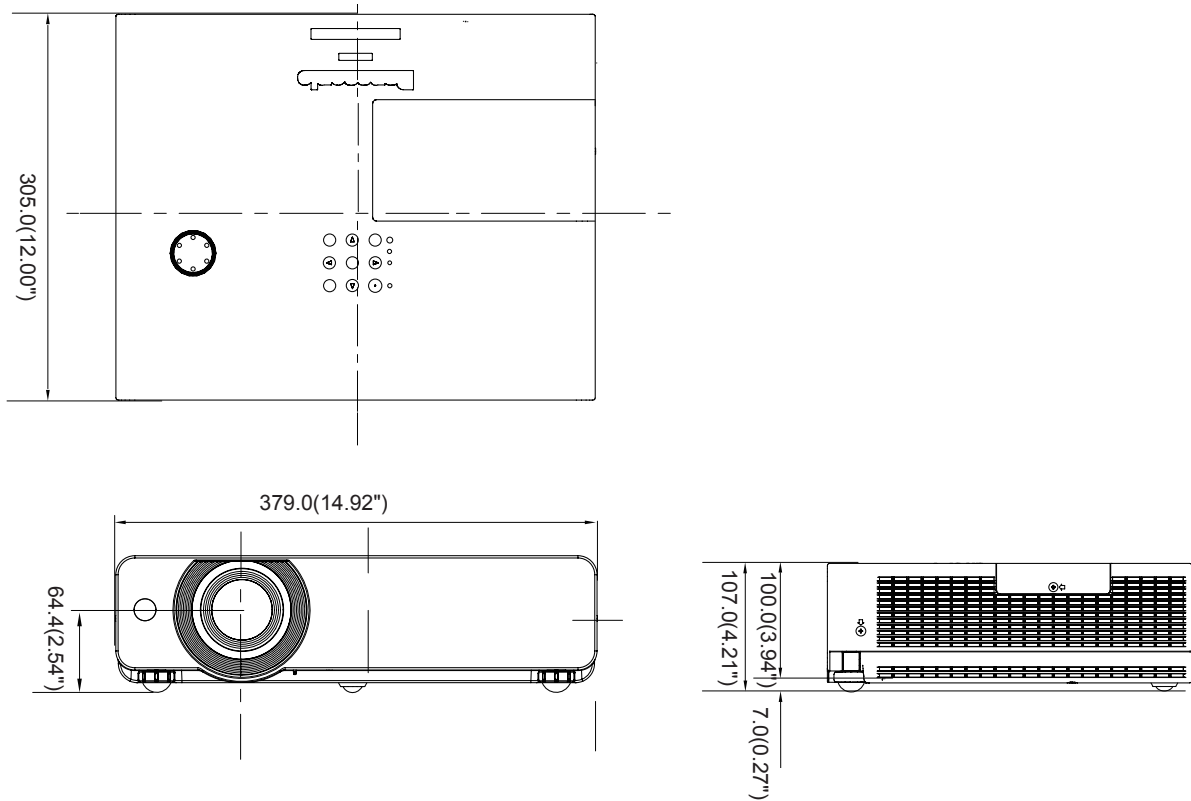

*: Actual dimension may differ by product.

Ceiling mount bracket safeguards

- Installation work of the ceiling mount bracket should only be carried by a qualified technician.
- Even if it is during guaranteed period, the manufacturer is not responsible for any hazard or damage caused by using a ceiling mount bracket which is not purchased from an authorized distributors, or environmental conditions.
- Remove an unused ceiling mount bracket promptly.
- Ensure to use a torque driver and do not use an electrical screwdriver or an impact screwdriver.
- For details, see the work instruction manual packed together with the ceiling mount bracket.
- The model Nos. of the accessories and the parts sold separately are subject to change without notice.
- Make sure the screws on the ceiling mount kit cannot touch the metal parts materials (metallic lath, wire or board) in the ceiling board. Otherwise it may result in fire hazard.

Bottom view

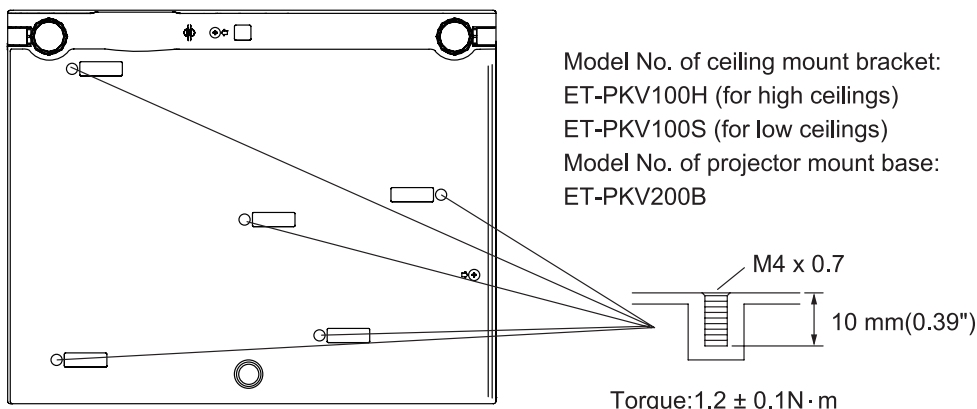

Glossary

Item	Descriptions	See page
Access point	These are stations for relaying electromagnetic signals between computers in a wireless LAN. When a computer is connected to an access point, it can communicate through the network connected to the access point.	69
AD HOC	This is the mode in which computers communicate with each other directly, rather than via access points.	69
AES	Next generation standard cryptography standardized by the National Institute of Standards and Technology (NIST). AES: Advanced Encryption Standard	69
Default Gateway	The devices that are used for different network standards from yours. Default Gateway enables a connection with other network, by adjusting bilateral differences such as communication protocols. If no gateway is specified for the IP address of access destination, data will be sent to the host set as the default gateway.	67 68 75
DHCP	Abbreviation for Dynamic Host Configuration Protocol. This function automatically assigns IP addresses to the connected equipment. If a device with the DHCP server function is present within a LAN, it automatically assigns IP addresses to the connected equipment.	67 68 75
EAP	Abbreviation of PPP Extensible Authentication Protocol. An authentication protocol extended from PPP, which is used for user authentication for remote access. MD5, TLS, S/Key, etc. are supported as authentication methods. This protocol is adopted by the wireless LAN authentication standard IEEE 802.1X, and available methods include EAP-TLS/EAP-TTLS/EAP-LEAP/EAP-PEAP/EAP-MD5.	70
EAP-FAST	Abbreviation of EAP-Flexible Authentication via Secure Tunneling. It is one of the wireless authentication methods compatible with IEEE 802.1X. It does not require digital authentication, but establishes a tunnel for the authentication process using a secret key cryptosystem, and authenticates the tunnel mutually to improve security. Cisco's proprietary method.	70
EAP-TTLS	Abbreviation of EAP-Tunneled Transport Layer Security. It is one of the wireless authentication methods compatible with IEEE 802.1X. It performs mutual authentication with a digital certificate by the authentication server, and ID/password by the client. A tunnel is established for the authentication process. Developed by Func Software in the U.S.	70
GTC (EAP-GTC)	Abbreviation of EAP-Generic Token Card. It is one of the wireless authentication methods compatible with IEEE 802.1X. Authentication is performed with ID and password. Password is acquired from a security token.	70
INFRASTRUCTURE (infrastructure mode)	This is the mode in which communications are performed via the access point.	69
IP address	Internet Protocol (IP) is a protocol for distributing data, and the address corresponding to the data distribution destination is called the IP address. The same IP address cannot be used within the same LAN.	67 68 75
LAN	Abbreviation for Local Area Network. This is a network with a relatively narrow range such as inside a company.	17
MAC address	Each network adapter has its own ID No. A discrete ID No. is assigned to each and every network adapter around the world. These IDs are used to exchange data between adapters. These IDs are a combination of a discrete number managed and assigned by the IEEE to each individual manufacturer and a unique number assigned to each individual adapter by the manufacturer.	89

Glossary

Item	Descriptions	See page
MD5 (EAP-MD5)	Abbreviation of EAP-Message digest algorithm 5. It is one of the wireless authentication methods compatible with IEEE 802.1X. Authentication is performed with ID and password. Password is sent encrypted with challenge & response method.	70
MS-CHAPv2 (EAP-MS-CHAPv2)	Abbreviation of EAP-Microsoft Challenge Handshake Authentication Protocol v2. It is one of the wireless authentication methods compatible with IEEE 802.1X. It performs mutual authentication using a one-way encrypted password.	70
Open System/ OPEN	This is an authentication of wireless signals employing a public key cryptosystem.	69
PEAP	Abbreviation for EAP-Protected EAP. It is one of the wireless authentication methods compatible with IEEE 802.1X. It performs mutual authentication with a digital certificate by the authentication server, and ID/password by the client.	70
RADIUS server	RADIUS is an abbreviation of Remote Access Dial In User authentication Service, and it is a protocol used for authentication in various networks such as wireless LAN. An authentication server compatible with the protocol is called a RADIUS server. The RADIUS server eliminates the need of registering user information separately in each device even when there are multiple network devices, and enables integrated management of multiple network devices and users.	70
Shared Key/ SHARED	This is a secret key cryptosystem for wireless signals in which authentication is performed with a key pre-set in the WEP. Other terms for this method, in which the same key is used for both encryption and decryption, are "shared key cryptosystem" and "common key cryptosystem".	69
SSID	Abbreviation for Service Set ID. The SSID identification code must be set to distinguish equipment included in a wireless LAN that uses access points from equipment not included in that LAN. This may appear as the "ESSID" or the "network name" for wireless LAN adapters made by some manufacturers.	68 69 75
Subnet mask	This limits the range of the IP addresses assigned to computers in order to divide the network into a number of sections during TCP/IP connection. The value used to divide the network at this time is called the subnetmask.	67 68 75
TKIP	Abbreviation for Temporal Key Integrity Protocol. This encryption protocol provides even greater security than WEP because it changes the encryption key at fixed intervals.	69
WEP	Abbreviation for Wired Equivalent Privacy. This is a method for encrypting communication data. The encryption key is created and notified only to the communicating user, so the communication data cannot be decrypted by a third party.	69
WPA-EAP WPA2-EAP	Standard for the encryption method for wireless LAN. This is an encryption method for corporations, and encryption is performed using the external server.	69
WPA-PSK WPA2-PSK	This is a standard covering encryption methods used in wireless LAN. It provides greater security than WEP, and has functions such as a user authentication function and also TKIP (encryption protocol) which automatically changes the encryption key at fixed intervals. And this authentication requires no authentication server.	69

Index

A			
About Your Projector.....	21		
Accessories	19		
Adjusting front adjustable feet	30		
Adjusting the position using the vertical lens shift function.....	30		
Attaching the Lens Cap	99		
AUTO PC adjust	47		
Auto setup	58		
AV MUTE.....	41		
B			
Background	59		
Basic operations by using the remote control	38		
Blackboard(Green)	50		
Brightness.....	51		
C			
Cautions on use.....	16		
Cautions when installing.....	14		
Cautions when transporting.....	9, 14		
CD-ROM.....	20		
Ceiling.....	56		
Cinema	50		
Closed caption.....	62		
Color	51		
Colorboard.....	50		
Color temp.....	52		
Computer System Selection.....	45		
Connecting	31		
Connecting the power cord.....	32		
Control panel	24		
Custom	54		
Custom adj.	55		
D			
Daylight View.....	52		
Digital zoom.....	55		
Direct on	61		
Direct Power Off function.....	36		
Display.....	59		
Disposal.....	15		
Dynamic.....	50		
E			
Emulate	64		
F			
Factory default.....	65		
Fan	63		
Fan control.....	63		
Filter counter.....	64		
FREEZE	40		
Full.....	54		
G			
Gamma.....	53		
Glossary	117		
H			
HDMI setup.....	60		
How to adjust the state of the image	37		
I			
ID numbers	26		
Image adjust.....	51		
Image select.....	50		
Information.....	66		
Input menu.....	45		
Input search.....	58		
Installing and Removing batteries ..	26		
Iris.....	51		
K			
Keystone.....	39, 55		
L			
LAMP indicator	94		
Lamp power.....	62		
Lamp unit.....	97		
Language.....	58		
List of compatible signals	110		
Logo.....	59		
M			
Main menu.....	43		
Maintenance	95		
Managing the indicated problems...94			
Manual PC adjust	48		
Menu Navigation.....	42		
Menu position	58		
MIC	57		
Mute.....	40, 57		
N			
Network	67		
Network connections	74		
Noise reduction.....	53		
Normal	54		
O			
ON(G)/STANDBY(R) indicator.....	33		
Other terminals	108		
P			
PIN code.....	35		
Pointer	60		
Power management	61		
Precautions for Use	14		
Progressive.....	53		
Projecting.....	37		
Projection distance	28, 29		
Projection method.....	27		
Projector body	23		
P-timer	61		
R			
Read this first!.....	2		
Real	50		
Rear	56		
Rear terminals	25		
Remote control	21, 62		
Replacing the Lamp unit.....	98		
Replacing the unit.....	95		
S			
Screen	54		
Screen aspect.....	54, 56		
Screen size and throw distance.....	28		
Security.....	15, 18, 63		
Selecting the image.....	37		
Serial terminal.....	105		
Setting	58		
Setting the ID number.....	26		
Setting up	27		
Sharpness	53		
Sound	57		
Specifications	114		
Standard	50		
Standby mode	61		
Sub menu	43		
Switching the input signal.....	40		
T			
Terminal	60		
Tint.....	51		
Troubleshooting.....	100		
True	54		
Turning Off the Projector	36		
Turning On the Projector	34		
U			
USB terminal	60		
V			
Video delay control	64		
Video System Selection.....	45		
Volume.....	57		
W			
WARNING indicator.....	94		
Warning log	65		
Wide(16:9).....	54		
Wireless mouse	39		
Z			
Zoom	54		

Information for Users on Collection and Disposal of Old Equipment and used Batteries



These symbols on the products, packaging, and/or accompanying documents mean that used electrical and electronic products and batteries should not be mixed with general household waste. For proper treatment, recovery and recycling of old products and used batteries, please take them to applicable collection points, in accordance with your national legislation and the Directives 2002/96/EC and 2006/66/EC.

By disposing of these products and batteries correctly, you will help to save valuable resources and prevent any potential negative effects on human health and the environment which could otherwise arise from inappropriate waste handling.



For more information about collection and recycling of old products and batteries, please contact your local municipality, your waste disposal service or the point of sale where you purchased the items.

Penalties may be applicable for incorrect disposal of this waste, in accordance with national legislation.



For business users in the European Union

If you wish to discard electrical and electronic equipment, please contact your dealer or supplier for further information.

Cd

Information on Disposal in other Countries outside the European Union

These symbols are only valid in the European Union. If you wish to discard these items, please contact your local authorities or dealer and ask for the correct method of disposal.

Note for the battery symbol (bottom two symbol examples):

This symbol might be used in combination with a chemical symbol. In this case it complies with the requirement set by the Directive for the chemical involved.

Panasonic Corporation

Web Site : <http://panasonic.net/avc/projector/>

© Panasonic Corporation 2012

M0612HY0 -ST