

DLP™ PROJECTOR

MODEL

HC7900DW

User Manual

HDMI™
HIGH-DEFINITION MULTIMEDIA INTERFACE

HC7900DW

This User Manual is important to you.
Please read it before using your projector.

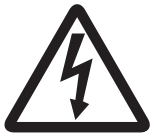
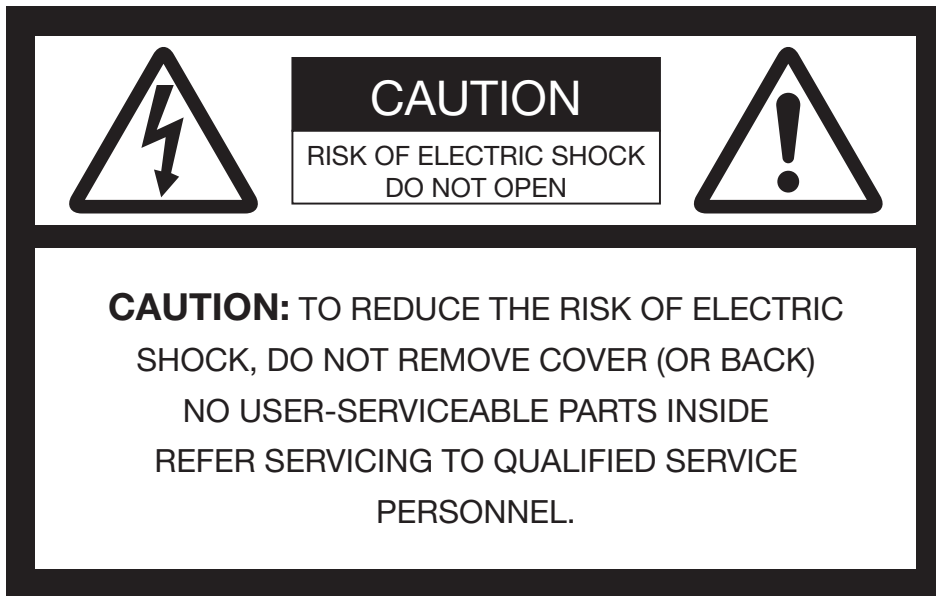

The lightning flash with arrowhead symbol within an equilateral triangle is intended to alert the user to the presence of uninsulated “dangerous voltage” within the product’s enclosure that may be of sufficient magnitude to constitute a risk of electric shock.



The exclamation point within an equilateral triangle is intended to alert the user to the presence of important operating and maintenance (servicing) instructions in the literature accompanying the appliance.

WARNING:

TO PREVENT FIRE OR SHOCK HAZARD, DO NOT EXPOSE THIS APPLIANCE TO RAIN OR MOISTURE.

CAUTION:

TO PREVENT ELECTRIC SHOCK, DO NOT USE THIS (POLARIZED) PLUG WITH AN EXTENSION CORD, RECEPTACLE OR OTHER OUTLET UNLESS THE BLADES CAN BE FULLY INSERTED TO PREVENT BLADE EXPOSURE.

NOTE:

SINCE THIS PROJECTOR IS PLUGGABLE EQUIPMENT, THE SOCKET-OUTLET SHALL BE INSTALLED NEAR THE EQUIPMENT AND SHALL BE EASILY ACCESSIBLE.

WARNING

Use the attached specified power supply cord. If you use another power supply cord, it may cause interference with radio and television reception.

This apparatus must be grounded.

DO NOT LOOK DIRECTLY INTO THE LENS WHEN THE PROJECTOR IS IN THE POWER ON MODE.

CAUTION

The attached power cord is to be used exclusively for this product. Never use it for other products.

Contents

Important safeguards	4
Preparing your projector.....	6
Using the remote control.....	9
Setting up your projector.....	10
Viewing video images.....	15
Viewing computer images	22
Viewing 3D images	25
Menu operation	28
Adjusting projected images.....	36
Advanced features	41
Replacing the lamp	42
Maintenance.....	45
Troubleshooting.....	46
Indicators.....	51
Specifications.....	52

Trademark, Registered trademark

- DLP™, Digital Micromirror Device, DMD, and BrilliantColor™ are all trademarks of Texas Instruments.
- HDMI, the HDMI logo and High-Definition Multimedia Interface are trademarks or registered trademarks of HDMI Licensing LLC.
- Mac is a registered trademark of Apple Inc.
- Other brand or product names are trademarks or registered trademarks of their respective holders.

Important safeguards

Please read all these instructions regarding your projector and retain them for future reference. Follow all warnings and instructions marked on the projector.

1. Read instructions
All the safety and operating instructions should be read before the appliance is operated.
2. Retain instructions
The safety and operating instructions should be retained for future reference.
3. Warnings
All warnings on the appliance and in the operating instructions should be adhered to.
4. Instructions
All operating instructions must be followed.
5. Cleaning
Unplug this projector from the wall outlet before cleaning it. Do not use liquid aerosol cleaners. Use a damp soft cloth for cleaning.
6. Attachments and equipment
Never add any attachments and/or equipment without the approval of the manufacturer as such additions may result in the risk of fire, electric shock or other personal injury.
7. Water and moisture
Do not use this projector near water or in contact with water.
8. Accessories
Do not place this projector on an unstable cart, stand, tripod, bracket or table. Use only with a cart, stand, tripod bracket, or table recommended by the manufacturer or sold with the projector. Any mounting of the appliance should follow the manufacturer's instructions and should use a mounting accessory recommended by the manufacturer.



An appliance and cart combination should be moved with care. Quick stops, excessive force and uneven surfaces may cause the appliance and cart combination to overturn.

9. Ventilation
Slots and openings in the cabinet are provided for ventilation, ensuring reliable operation of the projector and to protect it from overheating. Do not block these openings or allow them to be blocked by placing the projector on a bed, sofa, rug, or bookcase. Ensure that there is adequate ventilation and that the manufacturer's instructions have been adhered to.

10. Power sources
This projector should be operated only from the type of power source indicated on the marking label. If you are not sure of the type of power, please consult your appliance dealer or local power company.
11. Power-cord protection
Power-supply cords should be routed so that they are not likely to be walked on or pinched by items placed upon or against them. Pay particular attention to cords at plugs, convenience receptacles, and points where they exit from the appliance. Do not put the power cord under a carpet.
12. Overloading
Do not overload wall outlets and extension cords as this can result in a fire or electric shock.
13. Objects and liquids
Never push objects of any kind through openings of this projector as they may touch dangerous voltage points or short-out parts that could result in a fire or electric shock. Never spill liquid of any kind on the projector.
14. Servicing
Do not attempt to service this projector by yourself. Refer all servicing to qualified service personnel.
15. Damage requiring service
Unplug this projector from the wall outlet and refer servicing to qualified service personnel under the following conditions:
 - (a) If the power-supply cord or plug is damaged.
 - (b) If liquid has been spilled, or objects have fallen into the projector.
 - (c) If the projector does not operate normally after you follow the operating instructions. Adjust only those controls that are covered by the operating instructions. An improper adjustment of other controls may result in damage and may often require extensive work by a qualified technician to restore the projector to its normal operation.
 - (d) If the projector has been exposed to rain or water.
 - (e) If the projector has been dropped or the cabinet has been damaged.
 - (f) If the projector exhibits a distinct change in performance - this indicates a need for service.
16. Replacement parts
When replacement parts are required, be sure that the service technician has used replacement parts specified by the manufacturer or parts having the same characteristics as the original part. Unauthorized substitutions may result in fire, electric shock or other hazards.
17. Safety check
Upon completion of any service or repair to this projector, ask the service technician to perform safety checks determining that the projector is in a safe operating condition.

Important safeguards (continued)

WARNING:

Unplug immediately if there is something wrong with your projector.

Do not operate if smoke, strange noise or odor comes out of your projector. It might cause fire or electric shock. In this case, unplug immediately and contact your dealer.

Never remove the cabinet.

This projector contains high voltage circuitry. An inadvertent contact may result in an electric shock. Except as specifically explained in the User Manual do not attempt to service this product by yourself. Please contact your dealer when you want to fix, adjust or inspect the projector.

Do not modify this equipment.

It can lead to fire or electric shock.

Do not keep using the damaged projector.

If the projector is dropped and the cabinet is damaged, unplug the projector and contact your dealer for inspection. It may lead to fire if you keep using the damaged projector.

Be sure to unplug the power cord from the wall outlet if the projector is fractured or deformed.

Otherwise, it may result in fire or electric shock. Ask your dealer for repair.

Do not face the projector lens to the sun.

It can lead to fire.

Use correct voltage.

If you use incorrect voltage, it can lead to fire.

Do not place the projector on uneven surface.

Place the projection on a leveled and stable surface only. Please do not place equipment on unstable surfaces.

Do not look into the lens when it is operating.

It may hurt your eyes. Never let children look into the lens when it is on.

Do not put any objects immediately in front of the lens while the lamp is on.

The lens and the objects get hot and can cause fire or breakdown.

Do not unplug the power cord during operation.

It can lead to lamp breakage, fire, electric shock or other trouble. It is best to wait for the fan to turn off before turning the main power off.

Do not touch the exhaust vents and bottom plate, which become hot.

Do not touch them or put other equipment in front of the exhaust vents. The exhaust vents and bottom plate, when heated, may cause injury or damage to other equipment. Also, do not set the projector on the desk which is easily affected by heat.

Do not look into the exhaust vents when projector is operating.

Heat, dust, etc. may blow out of them and hurt your eyes.

Do not block the intake and exhaust vents.

If they are blocked, heat may be generated inside the projector, causing deterioration in the projector quality and fire.

Do not use flammable solvents (benzene, thinner, etc.) and flammable aerosols near the projector.

Flammable substances may ignite causing fire or breakdown because the temperature inside the projector rises very high while the lamp is illuminating.

Do not use the projector with condensation on it.

It can lead to breakdown or other failure.

Place of installation

For safety's sake, refrain from setting the projector at any place subjected to high temperature and high humidity. Please maintain an operating temperature, humidity, and altitude as specified below.

- Operating temperature: between +41°F (+5°C) and +95°F (+35°C)
- Operating humidity: between 30% and 90%
- Never put any heat-producing device under the projector so that the projector does not overheat.
- Do not attach the projector to a place that is unstable or subjected to vibration.
- Do not install the projector near any equipment that produces a strong magnetic field. Also refrain from installing near the projector any cable carrying a large current.
- Place the projector on a solid, vibration free surface; otherwise it may fall, causing serious injury to a child or adult, and serious damage to the product.
- Do not stand the projector; it may fall, causing serious injury and damage to the projector.
- Slanting the projector more than $\pm 10^\circ$ (right and left) or $\pm 15^\circ$ (front and rear) may cause trouble or explosion of the lamp.
- Do not place the projector near air-conditioning unit, heater, or humidifier to avoid hot or moist air to the exhaust and ventilation hole of the projector.
- Do not place the projector in the following places. Otherwise, a short circuit, heat generation, or melting of the power cord coating may occur, causing fire, electric shock, product failure, or deformation.
 - Outdoors or non air-conditioned place
 - Place where a gas such as a hydrogen sulfide is generated (i.e. hot spring)
 - Place where there is too much salt such as near the coast

Do not place a container containing water or other liquid on the projector.

If water spills on or enters the projector, it may result in fire or electric shock.

Do not put any object that is heavy or larger than the outer frame on the projector.

Otherwise, the object may fall losing its balance and cause injury.

Do not subject the projector to strong shocks or vibrations. Do not handle the projector roughly.

The projector may be damaged, resulting in fire or electric shock.

Preparing your projector

What's included in the box

AC power cord*	for the U.S.	J2552-0063-03	Remote control
	for Europe	J2552-0247-00	User Manual/Quick Start up (English only)
	for the U.K.	J2552-0065-02	Safety Manual/Quick Start up
	for Australia	J2552-0053-00	CD-ROM (with User Manual)
	for South Korea	J2552-0247-00	Battery (2)
Computer cable		J2552-0072-05	Lens cap
Mini DIN 5-pin cable		02552-0388-00	Lamp replacement attachment

* One of power cords for the U.S., Europe, U.K., Australia, and South Korea is provided appropriately.

Important:

- The attached power cord is to be used exclusively for this product. Never use it for other products.

Inserting the batteries into the remote control

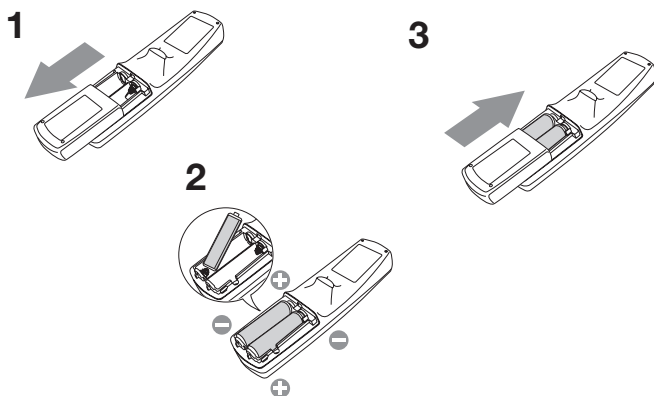

1. Remove the back lid of the remote control.
2. Check the polarity (+), (-) of the batteries, and set them correctly, inserting their (-) side first.
 - If the battery is inserted from the (+) side first, inserting the (-) side is difficult because the coil spring end hits on the battery side. If the battery is forced in this way, the outer label of the battery may get ripped and it may cause a short-circuit and heating.
3. Attach the back lid.

Important:

- Use two size-AA batteries (R6).
- Replace the two batteries with new ones when the remote control is slow to respond.

Removing the batteries from the remote control

Remove the back lid of the remote control and take out the batteries.

Caution:

- Use of a battery of wrong type may cause explosion.
- Only Carbon-Zinc or Alkaline-Manganese Dioxide type batteries should be used.
- Dispose of used batteries according to your local regulations.
- Before you dispose of the batteries, insulate them by placing insulation tape on the positive (+) and negative (-) terminals. If you dispose of the batteries together with other conductive objects such as a metal piece, they may short out, resulting in fire or explosion.
- Batteries may explode if misused. Do not recharge, disassemble, or heat the batteries, or put them into fire or water.
- Be sure to handle the batteries according to the instructions.
- Load the batteries with its positive (+) and negative (-) sides correctly oriented as indicated on the remote control.
- Keep batteries out of reach of children and pets. If children swallow the battery, see a doctor immediately.
- Remove the batteries, if the remote control is not used for a long time.
- Do not combine a new battery with an old one.
- If the solution of batteries comes in contact with your skin or clothes, rinse with water. If the solution comes in contact with your eyes, rinse them with water and then consult your doctor.
- Do not carry or store the batteries together with metallic ballpoint pens, necklaces, coins, or hairpins. Otherwise, they may short out, causing explosion or liquid leakage and resulting in fire or injury.
- Do not store the batteries where they are exposed to direct sunlight or subjected to high temperature and high humidity. High temperature and high humidity may cause corrosion or liquid leakage.

Preparing your projector (continued)

Overview

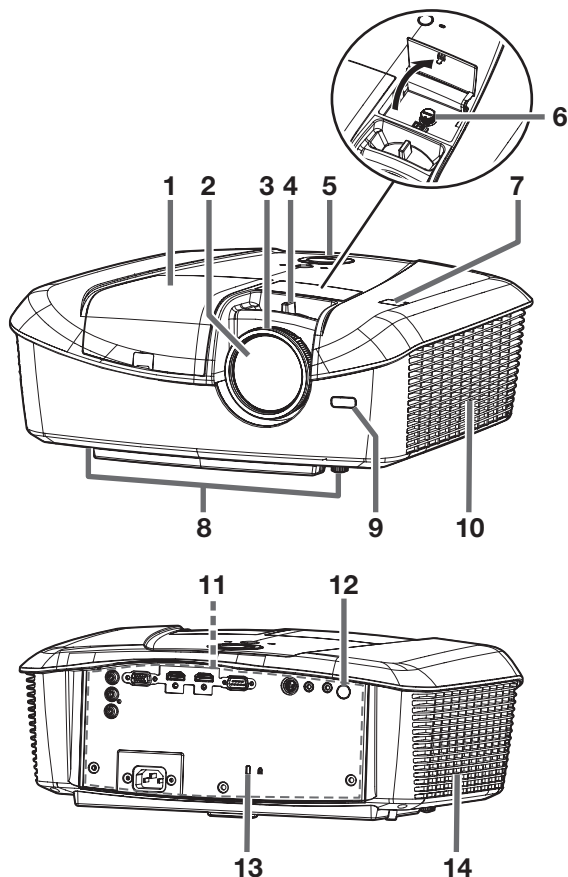

- 1 Lamp cover
- 2 Lens
- 3 FOCUS ring
- 4 ZOOM ring
- 5 Control panel
- 6 LENS SHIFT dial
- 7 Remote control sensor (top)
- 8 Adjustment feet
- 9 Remote control sensor (front)
- 10 Intake vent
- 11 Terminal panel
- 12 Remote control sensor (rear)
- 13 Kensington Security Lock Standard connector
- 14 Exhaust vent

Control panel

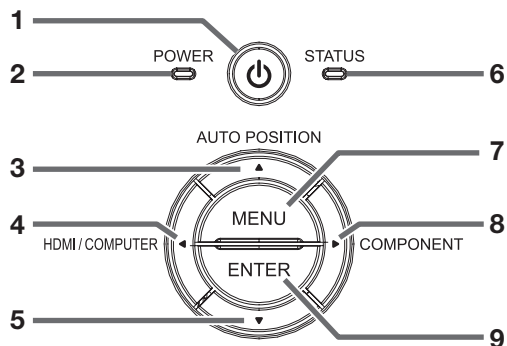

- 1 **POWER button (ON/STANDBY)**
 - The status is changed between ON and STANDBY.
- 2 **POWER indicator**
- 3 **AUTO POSITION/▲ button**
- 4 **HDMI/COMPUTER/◀ button**
- 5 **▼ button**
- 6 **STATUS indicator**
- 7 **MENU button**
- 8 **COMPONENT/▶ button**
- 9 **ENTER button**

Terminal panel

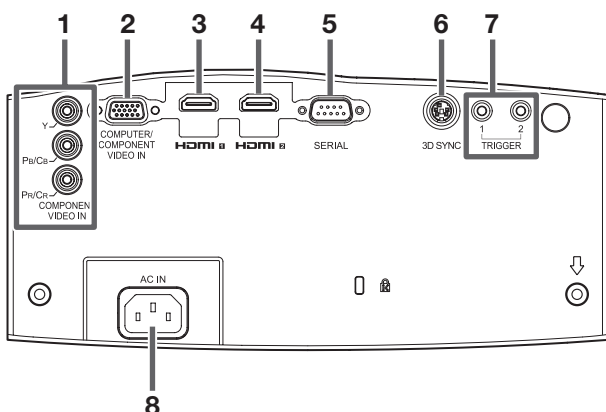

- 1 **COMPONENT VIDEO IN terminals**
- 2 **COMPUTER/COMPONENT VIDEO IN terminal (mini D-SUB 15-pin)**
- 3 **HDMI 1 terminal (HDMI 19-pin)**
- 4 **HDMI 2 terminal (HDMI 19-pin)**
- 5 **SERIAL terminal (D-SUB 9-pin)**
 - Used for projector control by computer. Contact your dealer for details.
- 6 **3D SYNC terminal**
- 7 **TRIGGER terminals**
 - Used for externally connected devices (electric screens) and anamorphic lens.
- 8 **Power jack**

Preparing your projector (continued)

Remote control

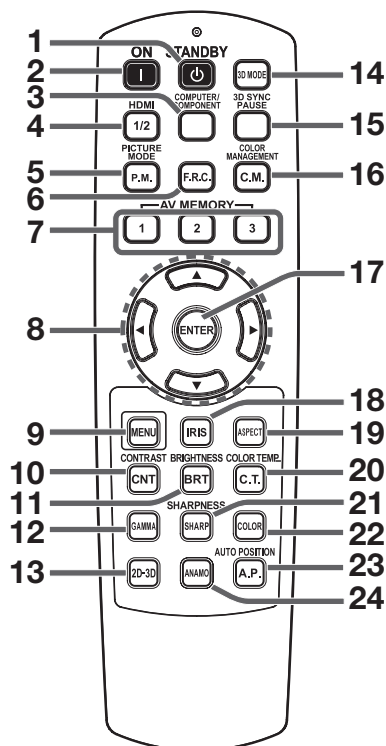

- 1 STANDBY (⏻) button
- 2 ON (I) button
- 3 COMPUTER/COMPONENT button
- 4 HDMI 1/2 button
- 5 PICTURE MODE button
- 6 F.R.C. button
- 7 AV MEMORY buttons
- 8 ▲, ▼, ◀, ▶ buttons
- 9 MENU button
- 10 CONTRAST button
- 11 BRIGHTNESS button
- 12 GAMMA button
- 13 2D-3D button (See page 26.)
- 14 3D MODE button (See page 25.)
- 15 3D SYNC PAUSE button (See page 26.)
- 16 COLOR MANAGEMENT button
- 17 ENTER button
- 18 IRIS button
- 19 ASPECT button
- 20 COLOR TEMP. button
- 21 SHARPNESS button
- 22 COLOR button
- 23 AUTO POSITION button
- 24 ANAMO button

Important:

- When you press any button on the remote control, the buttons on the remote control are lit. Wait approx. 6 seconds after releasing the button to turn them off.

Picture quality selection buttons

Using the following picture quality selection buttons, you can easily select the preset quality setting. Every time you press the button, the setting switches. Alternatively, you can select the picture quality setting using the IMAGE menu. (See page 30.) Items in the menus are shown in parentheses below.

PICTURE MODE (PICTURE MODE) ... Switches the picture mode.

IRIS (IRIS) Switches the IRIS mode.

Picture quality adjusting buttons

When you press any of the following picture quality adjusting buttons, the screen for adjusting the picture quality appears. Adjust the picture quality by pressing the ◀ and ▶ buttons. The picture quality adjustment can be made alternatively in the IMAGE menu. (See page 30.) Items in the menus are shown in parentheses below.

CONTRAST (CONTRAST) Adjusts the contrast of the projected image.

GAMMA (GAMMA MODE)..... Selects one of the preset gamma mode. Adjustment of USER mode is also available. (See page 39.)

BRIGHTNESS (BRIGHTNESS) Adjusts the brightness of the projected image.

COLOR TEMP. (COLOR TEMP.) Selects one of the preset color temperatures. Adjustment of USER mode is also available. (See page 37.)

COLOR (COLOR)..... Adjusts the color thickness of the projected image.

SHARPNESS (SHARPNESS)..... Adjusts the sharpness of the projected image.

F.R.C. (FRAME RATE CONVERSION) / ... For 2D image display:

F.R.C. LEVEL / 3D F.R.C. LEVEL) Selects the setting of FRAME RATE CONVERSION. By pressing the ENTER button with TRUE VIDEO or TRUE FILM selected and then pressing the ◀ or ▶ button, you can adjust the effect level of the motion interpolation by the frame rate conversion (F.R.C. LEVEL). (See page 31.)

For 3D image display (only when 1080p24 frame packing signal is input):
Adjusts the effect level of the motion interpolation by the frame rate conversion to 3D images (3D F.R.C. LEVEL).

Using the remote control

Operational range of the remote control

Reception distance

Operate the remote control within a distance of 10 m (30 feet) from the projector, pointing the IR beam at the remote control photo-sensor (front, rear, or top) of the projector.

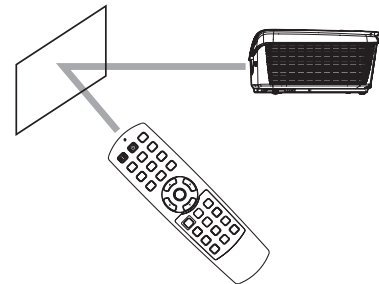
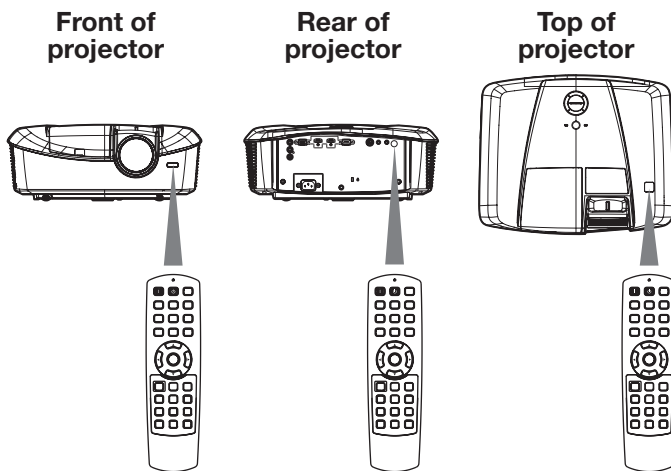

When operating the remote control, keep the distance from the remote control to the projector via the screen within about 5 m (15 feet). The operable range of the remote control, however, depends on the characteristics of the screen.

Important:

- Keep the remote control photo-sensor out of direct sunlight or fluorescent lamp light.
- Keep the remote control photo-sensor at least 2 m (6 feet) away from fluorescent lamps. Otherwise, the remote control may malfunction.
- If there is an inverter-operated fluorescent lamp near the remote control, the remote control operation may become unstable.
- When you use the remote control too close to the remote control sensor, the remote control may not work correctly.
- A remote control may operate improperly while you watch the 3D images. However, it is not a malfunction.
- When a remote control operates improperly while you watch the 3D images, change the setting of REMOTE POSITION in the FEATURE menu. (See page 33.)

Reception angle

Horizontal direction

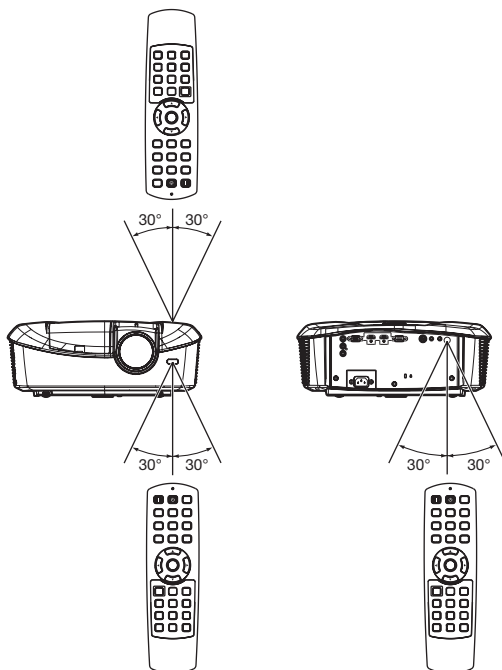

Vertical and front-to-back directions

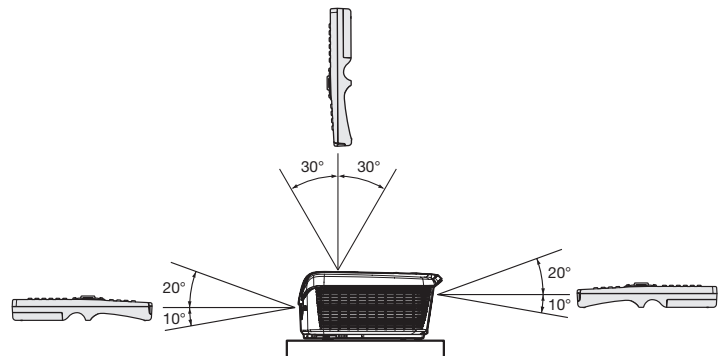

Vertical and front-to-back directions (ceiling mount)

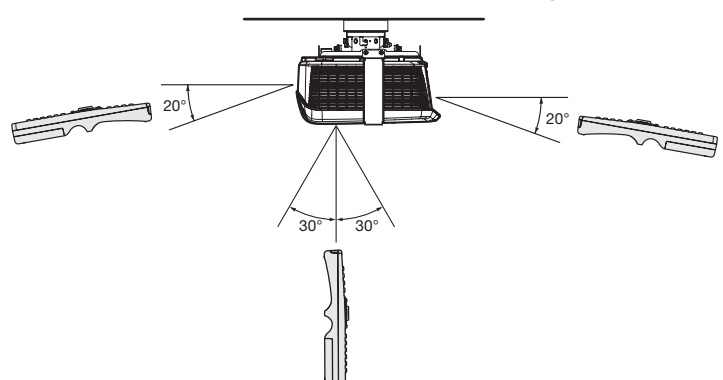

Setting up your projector

Setting up the screen

Install the screen perpendicularly to the projector. If the screen can not be installed in such a way, adjust the projection angle of the projector. (See page 12.)

- Install the screen and projector so that the projector's lens is placed at the same height and horizontal position of the screen center.
- Do not install the screen where it is exposed to direct sunlight or lighting. Light directly reflecting on the screen makes the projected images washed-out and hard to view.

SCREEN SIZE

You can keep the image display area within the screen by setting SCREEN SIZE in the ADVANCED MENU of IMAGE menu according to the aspect ratio of the actual screen. Select 16:9 when the aspect ratio of the screen is 16:9 or 4:3, and select CINEMA SCOPE (2.35:1) when the aspect ratio is 2.35:1 (CinemaScope).

When setting SCREEN SIZE to CINEMA SCOPE (2.35:1):

- CinemaScope size movies are projected in the full screen.
- Set ASPECT in the FEATURE menu to 16:9 when displaying Vista-size images. In this case, they are squeezed horizontally.
- When ASPECT in the FEATURE menu is set to AUTO and 480i/p, 576i/p, 720p, or 1080i/p signal is input, the part for displaying subtitles is not projected. To display subtitles, reset SCREEN SIZE to 16:9 and adjust the image position using VERTICAL LOCATION in the ADVANCED MENU of the IMAGE menu. (To display the menu on the screen, adjust SHUTTER(U) in the SIGNAL - USER menu to position the menu.)

Screen size and projection distance

Refer to the following tables to determine the screen size and projection distance.

- The figures in the tables are approximate and may be slightly different from the actual measurements.
- The lens shift height shows distances from the factory default position.

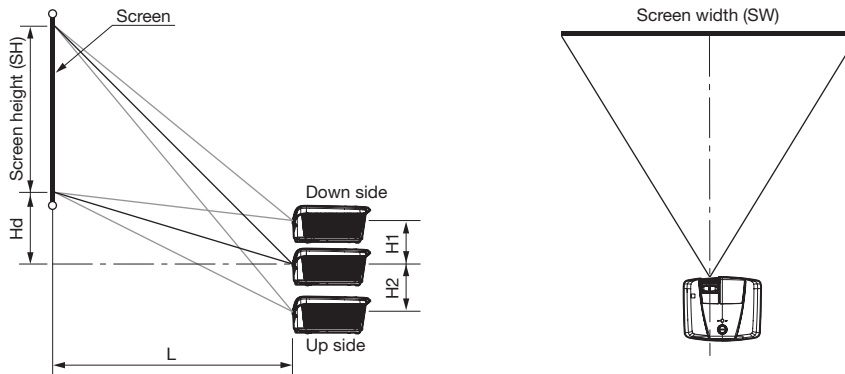

When the aspect ratio of the screen is 16:9

Screen size (16:9)						Projection distance (L)				Hd		Lens shift height			
Diagonal size		Height (SH)		Width (SW)		Shortest (Wide)		Longest (Tele)				H1		H2	
inch	cm	inch	cm	inch	cm	inch	m	inch	m	inch	cm	inch	cm	inch	cm
50	127	25	62	44	111	59	1.5	89	2.3	8	21	4	9	3	8
60	152	29	75	52	133	71	1.8	107	2.7	10	25	4	11	4	9
70	178	34	87	61	155	84	2.1	125	3.2	12	29	5	12	4	11
80	203	39	100	70	177	96	2.4	144	3.6	13	34	6	14	5	12
90	229	44	112	78	199	108	2.7	162	4.1	15	38	6	16	6	14
100	254	49	125	87	221	120	3.1	180	4.6	16	42	7	18	6	16
110	279	54	137	96	244	133	3.4	198	5.0	18	46	8	20	7	17
120	305	59	149	105	266	145	3.7	216	5.5	20	50	8	21	7	19
150	381	74	187	131	332	182	4.6	271	6.9	25	63	11	27	9	23
200	508	98	249	174	443	243	6.2	362	9.2	33	84	14	36	12	31
250	635	123	311	218	553	304	7.7	-	-	41	105	18	45	15	39
300	762	147	374	261	664	365	9.3	-	-	49	126	21	54	18	47

- Projection distance changes according to the setting of SCREEN SIZE in the ADVANCED MENU in the IMAGE menu. The table above is in the case of "16:9."

- Depending on the installation conditions, warm air that is emitted from the exhaust vents may flow into the intake vent, causing the projector to display "TEMPERATURE!!" and then stop projecting images.

Setting up your projector (continued)

Screen size and projection distance (continued)

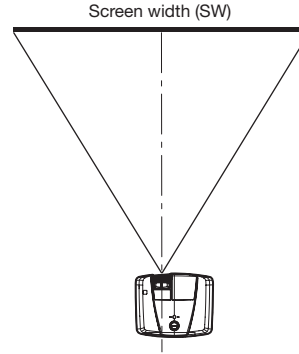
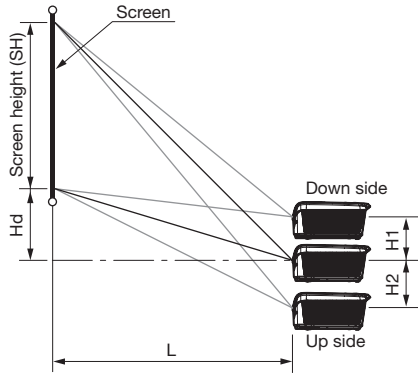

When the aspect ratio of the screen is 4:3

When the aspect ratio of the screen is 4:3, the positional relation between the projected image and the screen is as shown on the right. Refer to the following table for installation.

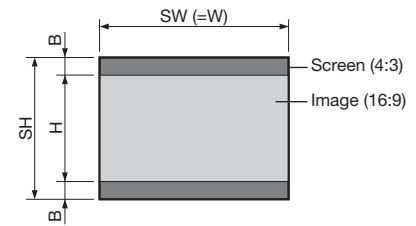

When the aspect ratio of the image is 16:9

Screen size (4:3)						Size of the projected image (16:9)						Black space (B)		Projection distance (L)				Hd		Lens shift height			
Diagonal size		Height (SH)		Width (SW)		Diagonal size		Height (H)		Width (W)				Shortest (Wide)		Longest (Tele)				H1		H2	
inch	cm	inch	cm	inch	cm	inch	cm	inch	cm	inch	cm	inch	cm	inch	m	inch	m	inch	cm	inch	cm	inch	cm
50	-	-	-	-	-	-	-	-	-	-	-	-	-	-	-	-	-	-	-	-	-	-	-
60	152	36	91	48	122	55	140	27	69	48	122	5	11	65	1.7	98	2.5	9	23	4	10	3	9
70	178	42	107	56	142	64	163	32	80	56	142	5	13	77	1.9	115	2.9	11	27	5	11	4	10
80	203	48	122	64	163	73	187	36	91	64	163	6	15	88	2.2	132	3.3	12	31	5	13	4	11
90	229	54	137	72	183	83	210	41	103	72	183	7	17	99	2.5	148	3.8	14	35	6	15	5	13
100	254	60	152	80	203	92	233	45	114	80	203	8	19	110	2.8	165	4.2	15	38	6	16	6	14
110	279	66	168	88	224	101	256	50	126	88	224	8	21	122	3.1	182	4.6	17	42	7	18	6	16
120	305	72	183	96	244	110	280	54	137	96	244	9	23	133	3.4	199	5.0	18	46	8	20	7	17
150	381	90	229	120	305	138	350	68	171	120	305	11	29	166	4.2	249	6.3	23	58	10	25	8	21
200	508	120	305	160	406	184	466	90	229	160	406	15	38	223	5.7	332	8.4	30	77	13	33	11	29
250	635	150	381	200	508	229	583	113	286	200	508	19	48	279	7.1	-	-	38	96	16	41	14	36
300	762	180	457	240	610	275	699	135	343	240	610	23	57	335	8.5	-	-	45	115	19	49	17	43

• Projection distance changes according to the setting of SCREEN SIZE in the ADVANCED MENU in the IMAGE menu. The table above is in the case of "16:9."

When the aspect ratio of the screen is 2.35:1 (CinemaScope)

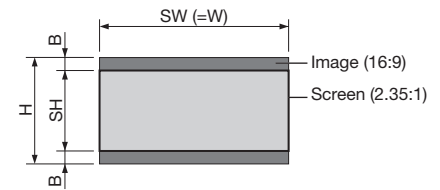

Screen size (2.35:1)						Size of the projected image (16:9)						Black space (B)		Projection distance (L)				Hd		Lens shift height			
Diagonal size		Height (SH)		Width (SW)		Diagonal size		Height (H)		Width (W)				Shortest (Wide)		Longest (Tele)				H1		H2	
inch	cm	inch	cm	inch	cm	inch	cm	inch	cm	inch	cm	inch	cm	inch	m	inch	m	inch	cm	inch	cm	inch	cm
100	254	39	99	92	234	106	268	52	131	92	234	6	16	127	3.2	190	4.8	24	60	7	19	6	16
110	279	43	109	101	257	116	295	57	145	101	257	7	18	140	3.6	209	5.3	26	66	8	21	7	18
120	305	47	119	110	281	127	322	62	158	110	281	8	19	153	3.9	229	5.8	28	72	9	23	8	20
130	330	51	129	120	304	137	349	67	171	120	304	8	21	166	4.2	248	6.3	31	78	10	25	8	21
140	356	55	139	129	327	148	375	72	184	129	327	9	22	179	4.5	267	6.8	33	84	10	26	9	23
150	381	59	149	138	351	158	402	78	197	138	351	9	24	192	4.9	286	7.3	36	90	11	28	10	25
160	406	63	159	147	374	169	429	83	210	147	374	10	26	205	5.2	305	7.8	38	96	12	30	10	26
170	432	66	169	156	397	180	456	88	224	156	397	11	27	218	5.5	325	8.2	40	103	13	32	11	28
180	457	70	179	166	421	190	483	93	237	166	421	11	29	231	5.9	344	8.7	43	109	13	34	12	30
190	483	74	189	175	444	201	510	98	250	175	444	12	31	244	6.2	363	9.2	45	115	14	36	12	31
200	508	78	199	184	468	211	536	104	263	184	468	13	32	256	6.5	382	9.7	47	121	15	38	13	33

• Projection distance changes according to the setting of SCREEN SIZE in the ADVANCED MENU in the IMAGE menu. The table above is in the case of "CINEMA SCOPE (2.35:1)."

Setting up your projector (continued)

Adjusting the position of the projected image

To adjust the position of the projected image on the screen, use the LENS SHIFT dial.

1. Rotate the LENS SHIFT dial inside the top cover of the projector to adjust the image position.
 - Rotating the dial clockwise (or counterclockwise for a ceiling-mount projector) moves the image up.
 - Rotating the dial counterclockwise (or clockwise for a ceiling-mount projector) moves the image down.
- Be careful not to be caught in the opening in the lens while the lens is moving.
- While the lens shift is working, the screen may flicker.
- Projected images may become distorted, have decreased resolution, or have shadows at their corners if they are positioned close to the top (or bottom in the case of a ceiling-mount projector).

Correcting skewed or distorted image

For the best projection, project images on a flat screen installed at 90 degrees to the floor. If necessary, tilt the projector using the two adjustment feet on the bottom of the projector.

1. Tilt up the projector to the appropriate angle.
2. Rotate the adjustment feet for fine adjustment.

Important:

- Don't transport the projector with its adjustment feet extended. Otherwise the adjustment feet may be damaged.

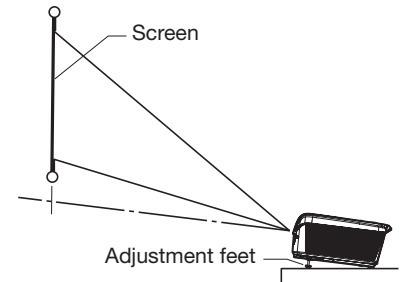

When fine streaks are seen on projected images

This is due to interference with the screen surface and is not a malfunction. Replace the screen or displace the focus a little. (See page 18 or 23 for focus adjustment.)

When projected images are distorted to a trapezoid

When the screen and the projector are not placed perpendicularly to each other, projected images become trapezoidal. If you cannot make the projector and the screen perpendicular to each other by mechanical adjustments, adjust keystone.

With the INSTALLATION menu:

(See page 29 for menu setting.)

1. Display the INSTALLATION menu.
2. Select KEYSTONE by pressing the ▲ or ▼ button.
3. Equalize the widths at the top and bottom of the screen by pressing the ◀ or ▶ button, viewing the screen.

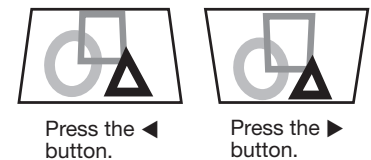

To cancel the menu:

4. Press the MENU button several times.

- In the keystone adjustment, you can obtain an optimum result when the LENS SHIFT dial is at the center position.
- When the keystone adjustment is carried out, the adjustment value is indicated. Note that this value doesn't mean a projection angle.
- When the keystone adjustment takes effect, the resolution decreases. In addition, stripes may appear or straight lines may bend in images with complicated patterns. They are not due to product malfunctions.
- When the keystone adjustment is carried out, the image may not be displayed correctly because of the type of input signal.
- When the keystone adjustment is performed, the displayed image may be distorted.
- Depending on the installation conditions of the projector and the screen, a perfect rectangular image and the proper aspect ratio may not be obtained.
- While a 3D image is displayed, the keystone adjustment is unavailable.

Setting up your projector (continued)

Front projection, ceiling mounting

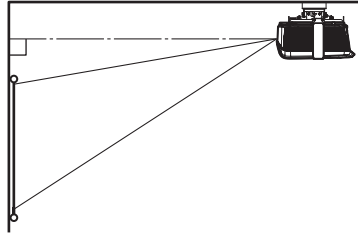

For ceiling mounting, you need the ceiling mount kit designed for this projector. Ask a specialist for installation. For details, consult your dealer.

- The warranty on this projector does not cover any damage caused by use of any non-recommended ceiling mount kit or installation of the ceiling mount kit in an improper location.
- When using the projector mounted on the ceiling, set IMAGE REVERSE in the INSTALLATION menu to MIRROR INVERT. See page 32.
- When the projector is mounted on the ceiling, images may appear darker than those projected in the case of tabletop mounting. This isn't a product malfunction.
- Ask your installation specialist to provide an A/C power switch. When you do not use the projector, be sure to shut down the main power by the switch.
- Do not install the projector where the exhaust vents are exposed to air emitted by an air conditioning. Such installation may cause a breakdown.
- Do not install the projector near a fire alarm because it emits hot air from its exhaust vents.

Caution:

- Installation must be done by a qualified professional.
When the projector is installed on the ceiling using the ceiling mount kit, it is recommended to hold the mount kit and the projector using a metal bar or wire in addition to the mount kit fixing screws to prevent the projector from falling due to an earthquake or other cause. For that purpose, use a metal bar, wire, or screw that bears a load of at least 70 kgf. When using a metal wire, secure one end to a screw hole marked with an arrow on the rear terminal panel and the other end to the mount kit. (Don't use screw holes without arrow marks.) In this case, make sure that the screw is inserted in the projector at least 5 mm. The length of the screw should be 20 mm or shorter. Also make sure that no electrical current is flowing in the mount kit due to current leakage or other cause.

Rear projection

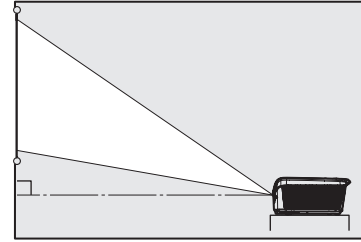

Ask a specialist for installation. For details, consult your dealer.

- For rear projection, set IMAGE REVERSE in the INSTALLATION menu to MIRROR. See page 32.

Caution:

- Placing the projector directly on a carpet impairs ventilation by the fans, causing damage or failure. Put a hard board under the projector to facilitate ventilation.
- Place the projector at least 50 cm (or 20 inch) away from the wall to prevent the intake vents and the exhaust vents that emit hot air from being blocked.
- Do not use the projector in the following locations and manners, which may cause fire or electric shock.
 - In a dusty or humid place.
 - In a sideways position, or with the lens facing down.
 - Near a heater.
 - In an oily, smoky, or damp place such as a kitchen.
 - In direct sunlight.
 - Where the temperature rises high, such as in a closed car.
 - Where the temperature is lower than +41°F (or +5°C) or higher than +95°F (or +35°C).
- Keep foliage plants and pets away from the projector. The temperature around the exhaust vents and that of the cabinet on the top of the exhaust vents become high. Take special care for small children.

Important:

- We don't recommend using the projector at an altitude of 1500 meters or higher. Use at an altitude of 1500 meters or higher may affect the projector's life.

Setting up your projector (continued)

TRIGGER terminal

The TRIGGER terminals on the rear of the projector are terminals that output 12 V signal to control externally connected devices (electric screens) when images are projected.

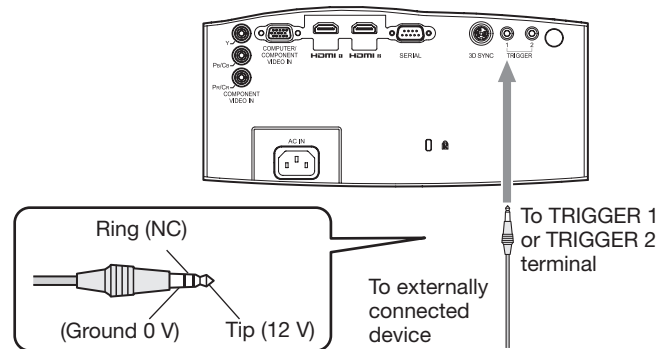

To use the TRIGGER terminals, set TRIGGER 1 (POWER) or TRIGGER 2 (ANAMO) to ON in the INSTALLATION menu. (The factory default is OFF. See page 32 for details.) Use the following steps to change the setting.

With the INSTALLATION menu:

(See page 29 for menu setting.)

1. Display the INSTALLATION menu.
2. Select TRIGGER 1 (POWER) or TRIGGER 2 (ANAMO) by pressing the ▲ or ▼ button.
3. Select ON by pressing the ◀ or ▶ button.

To cancel the menu:

4. Press the MENU button.

Caution:

- Do not use the signal output from the TRIGGER terminals as power for other devices.
- Do not link the TRIGGER terminals with audio terminals of other devices because that devices may be damaged.
- The rated current for the TRIGGER terminals are 200 mA. If you use a current exceeding this rating, a failure may occur.
- For information about electric screens, please contact screen manufacturers.

Viewing video images

A. Connecting the projector to video equipment

- When the projector and the connected devices are located too close to each other, the projected image may be affected by their interference.
- See the owner's guide of each device for details about its connections.

Preparation:

- Make sure that the power of the projector and that of the video equipment are turned off.

Basic home theater system connection

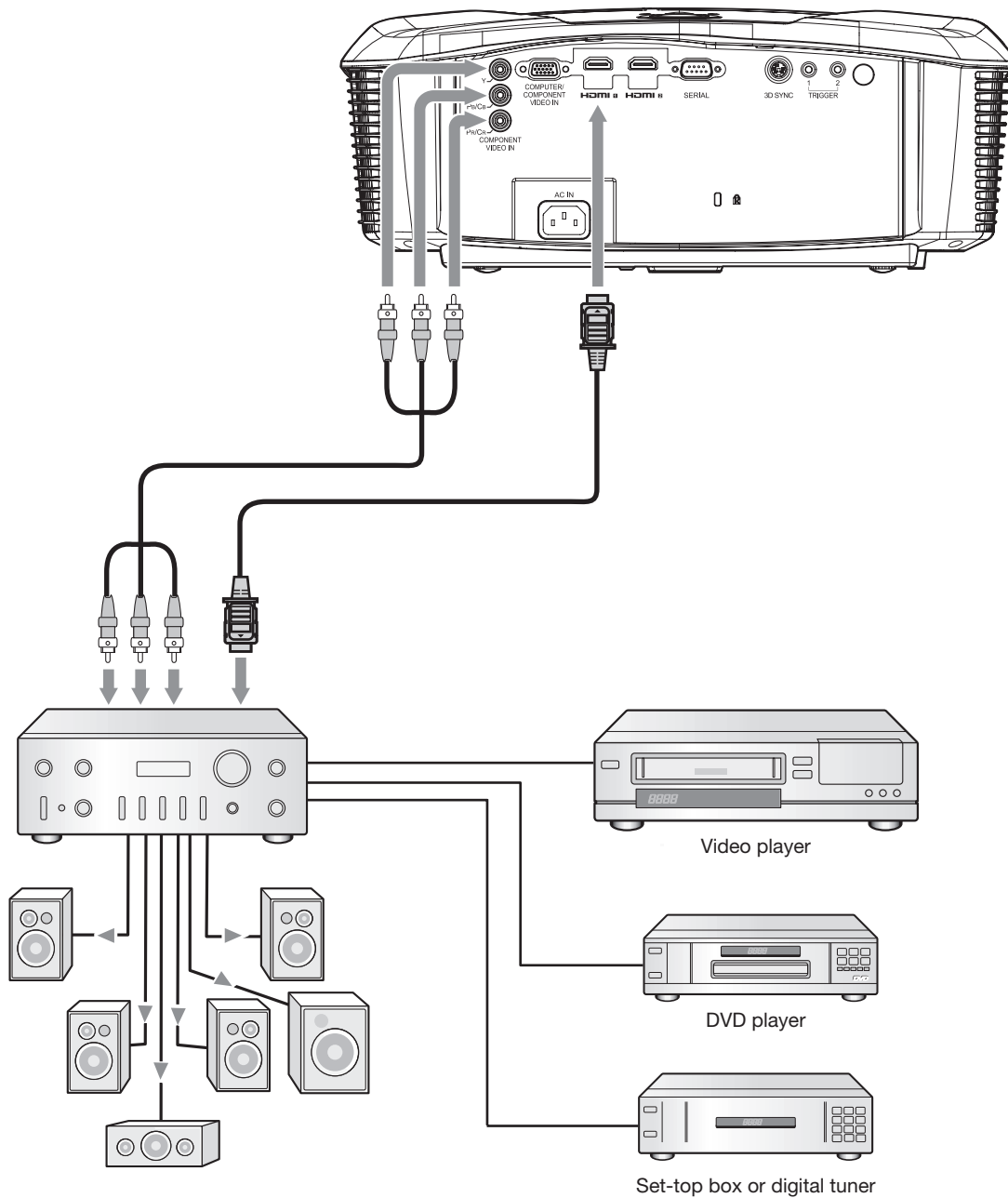

Viewing video images (continued)

Connecting to video equipment having a HDMI terminal

You can project high-quality images by connecting the HDMI 1 or HDMI 2 terminal of this projector to video equipment having a HDMI output terminal. In addition, this projector supports HDCP and is able to receive encrypted digital video data that are output from DVD players.

- Select HDMI1 or HDMI2 as the input source.
- HDCP (High-bandwidth Digital Content Protection), developed by Intel Corporation, is a method to encrypt digital video data for the purpose of copy protection.
- HDMI (High-Definition Multimedia Interface) is fully backward compatible with computers, displays and consumer electronics devices incorporating the DVI standards.
- This projector can be linked with video devices equipped with HDMI output terminal. However, with some of them, this projector may not display any image or not operate correctly.
- If this projector doesn't display any image or not operate correctly, see the operation manual of the video device for its connection.
- When you use the video equipment other than HDMI conformity product, the image may not be projected properly.
- Use of a long cable may decrease the quality of projected images.

Connection (for video equipment having an HDMI terminal)

- Use a commercially available HDMI (with HDMI logo) cable.
- Some cables may not be connected correctly depending on the size and shape of their connectors.
- To connect the projector and video equipment via a distributor, use a Deep Color supported distributor compliant with HDMI1.3 or higher (or a 3D display supported distributor compliant with HDMI1.4 or higher when displaying 3D images.)

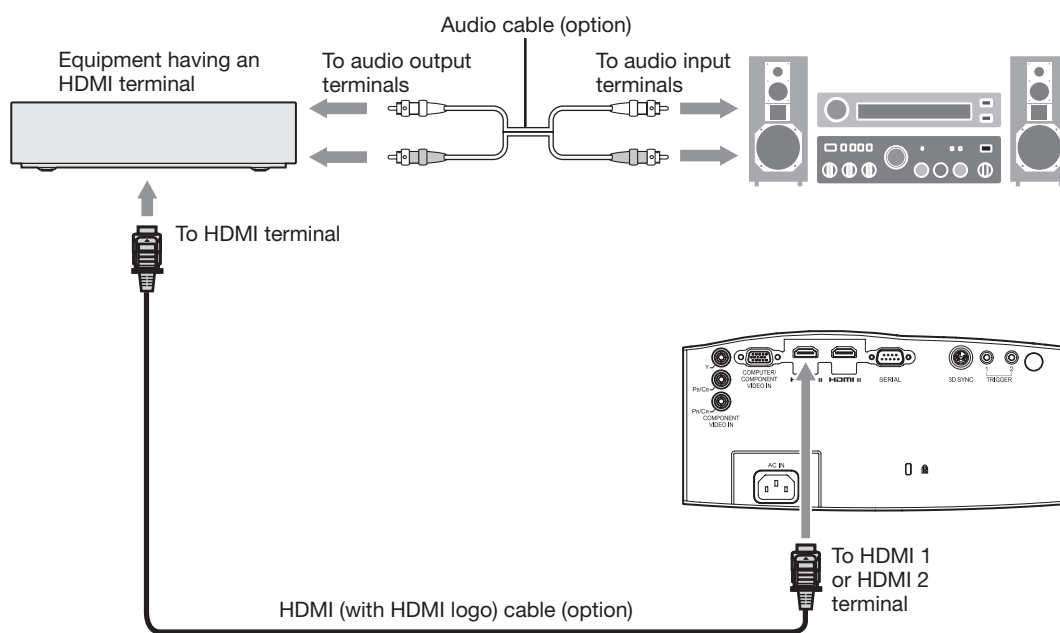

When you connect this projector and a Digital device (such as a DVD player) via the HDMI terminal, black color may appear dark and deep, depending on the type of the connected device.

- This depends on the black level setting of the connected device. There are two kinds of methods to digitally transfer image data, in which different black level settings are employed respectively. Therefore, the specifications of the signals output from DVD players differ, depending on the type of the digital data transfer method they use.
- Some DVD players are provided with a function to switch the methods to output digital signals. When your DVD player is provided with such function, set it as follows.

EXPAND or ENHANCED → NORMAL

- See the users guide of your DVD player for details.
- Set HDMI INPUT of ADVANCED MENU in the IMAGE menu depending on the device to be used.

Viewing video images (continued)

Connecting to a DVD player or HDTV decoder

To connect this projector to video equipment that has component video output terminals, such as a DVD player, use the COMPONENT VIDEO IN terminals.

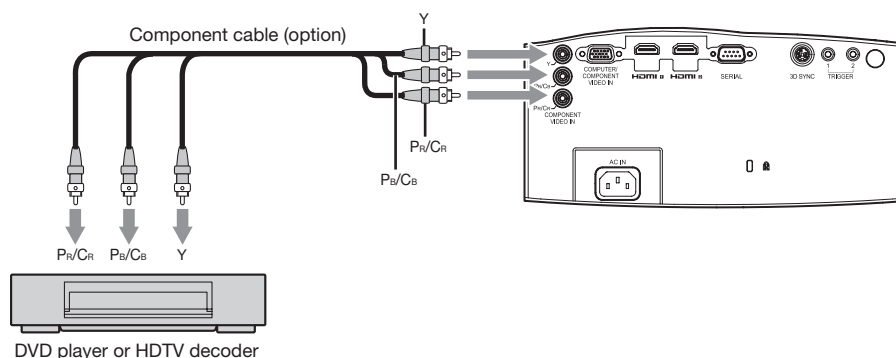

- The terminal's names Y, P_B, and P_R are given as examples of when a HDTV decoder is connected.
- The terminal's names vary depending on the connected devices.
- Images may not be projected correctly depending on the type of the DVD player you use.
- Though it may take some time before an image is displayed on the screen depending on the type of the input signal, such symptom is not a malfunction.
- When connecting a HDTV decoder having RGB output terminals, set COMPUTER INPUT to RGB in the SIGNAL menu.

B. Plugging in the power cord

- In order to ensure the safety in case of trouble with the projector, use an electrical outlet having an earth leakage breaker to supply the power to the projector. If you do not have such outlet, ask your dealer to install it.

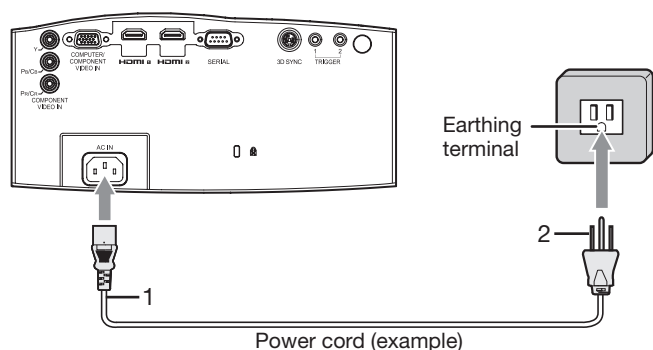

1. Plug the attached power cord into the power cord inlet of this projector.
2. Plug the other end of the power cord into a power outlet.

- One of power cords for the U.S., Europe, U.K., Australia, and South Korea is provided appropriately.
- This projector uses the power plug of three-pin grounding type. Do not take away the grounding pin from the power plug. If the power plug doesn't fit your wall outlet, ask an electrician to change the wall outlet.
- In case that the power cord for the U.S. is provided with this projector, never connect this cord to any outlet or power supply using other voltages or frequencies than rated. If you want to use a power supply using other voltage than rated, prepare an appropriate power cord separately.
- Use 100-240 V AC 50/60 Hz to prevent fire or electric shock.
- Do not place any objects on the power cord or do not place the projector near heat sources to prevent damage to the power cord. If the power cord should be damaged, contact your dealer for replacement because it may cause fire or electric shock.
- Do not modify or alter the power cord. If the power cord is modified or altered, it may cause fire or electric shock.

Caution:

- Plug in the power cord firmly. When unplugging, hold and pull the power plug, not the power cord.
- Do not plug in or out the power cord with your hand wet. It may cause electric shock.
- Do not turn on the power before attaching the lens. The cabinet may be exposed to the light from the lamp directly and heated to a high temperature, resulting in deformation.
- When you move the projector, turn off the power, unplug the power cord from the wall outlet, and then remove the connected cords. Otherwise, the power cord may be damaged, resulting in fire or electric shock.
- If dust or metallic substance is on or around the pins of the power plug, unplug the power cord and clean it using a dry cloth. If you continue to use the projector without cleaning, it may result in fire or electric shock. Clean the power plug periodically at least once a year.
- Be sure to unplug the power cord from the wall outlet if the projector will not be used for a long period of time. Otherwise, it may cause fire.

C. Projecting images

Preparation:

- Remove the lens cap.
- Turn on the power of the connected video equipment.

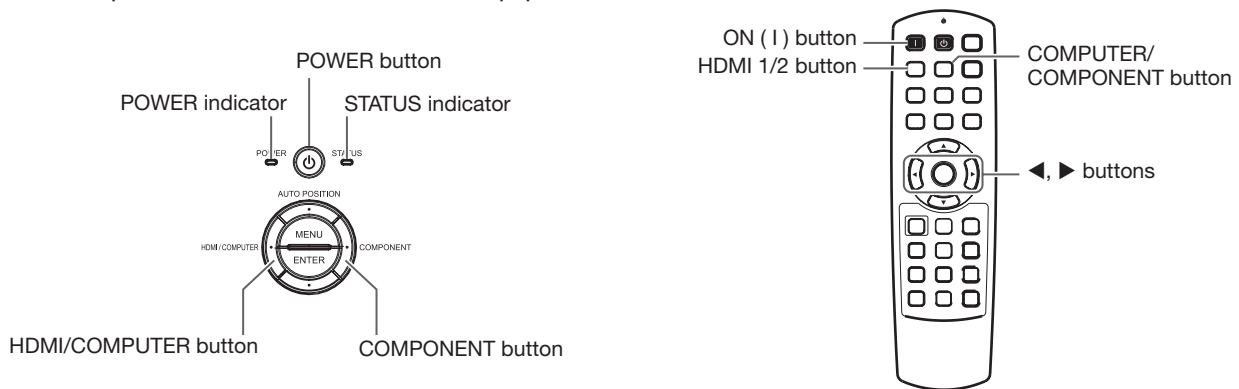

1. Confirm the POWER indicator lights-up red.
 - If the projector was turned off before the lamp had cooled down sufficiently, the fan may start rotating and the POWER button may not work after the power cord is plugged. (The STATUS indicator blinks green.) After the fan stops rotating, press the POWER button to turn back on the POWER indicator.
2. Press the POWER button on the projector or ON (I) button on the remote control.
 - It may take about one minute for the lamp to light up.
 - The lamp fails to light up on rare occasions. In such a case, wait for a few minutes and then try again.
 - Do not cover the lens with the lens cap while the lamp is on.
 - After the POWER button is pressed, the image may flicker before the lamp becomes stable. This is not a product malfunction.
 - The STANDARD lamp mode is activated by default whenever the projector is turned on. When the LOW LAMP MODE has been chosen, the default STANDARD lamp mode is switched to the LOW lamp mode in 1 minute.
 - The projector starts warming up when the POWER button is pressed. During the warm-up process, images may appear dark and no commands are accepted.
 - By blinking red, the STATUS indicator indicates that the lamp should be replaced soon. Replace the lamp when the STATUS indicator blinks red. (See page 51.)
3. Adjust the focus by turning the focus ring.
 - You are recommended to adjust the focus at the screen center.
4. Select an input source.
 - Press the COMPONENT or HDMI/COMPUTER button on the projector or the COMPUTER/COMPONENT or HDMI 1/2 button on the remote control that is corresponding to the terminal in use.
 - The input source is switched between COMPUTER, HDMI1 and HDMI2 every time you press the HDMI/COMPONENT button on the projector.
 - The input source is switched between COMPUTER and COMPONENT every time you press the COMPUTER/COMPONENT button on the remote control.
 - The input source is switched between HDMI1 and HDMI2 every time you press the HDMI 1/2 button on the remote control.
 - The projector automatically selects the appropriate signal format. (The selected signal format is displayed on the INFORMATION menu.)
 - You cannot change the input source while the menu is being displayed.
 - Though it may take some time before an image is displayed on the screen depending on the type of the input signal, such symptom is not a malfunction.
 - Some images become easier to view when the setting of aspect ratio is changed. (See page 20.)
 - When this projector is connected with an HDMI device supporting HDCP, such as a DVD player, image is not displayed correctly at the time of switching the input source on rare occasions. In such cases, switch to other input source and then switch back to the HDMI input source.
 - When COMPONENT is chosen as the source, images supplied from the computer may flicker. Press the ◀ or ▶ button on the remote control to reduce flicker, if it occurs. (Fine adjustment)
5. Adjust the position of the projector to keep an appropriate projection distance with which images are projected in their specified sizes.
6. Adjust the position of the projector so that the projector and the screen are perpendicular to each other. (See page 10.)
 - When the projector cannot be positioned perpendicularly to the screen, adjust the projection angle. (See page 12.)
7. Adjust the image size by turning the zoom ring.
8. Adjust the vertical position of the displayed image by turning the LENS SHIFT dial.

If necessary, adjust the focus and zoom again.

Viewing video images (continued)

To stop projecting:

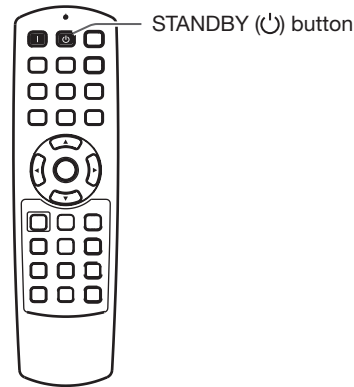
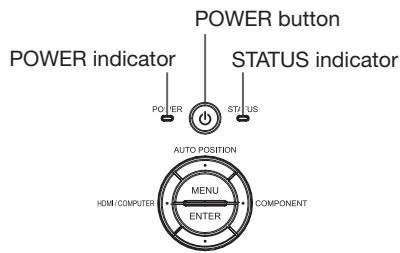

9. Press the POWER button on the projector or the STANDBY (⏻) button on the remote control.
 - A confirmation message is displayed.
 - To cancel the procedure, leave the projector for a while or press the MENU button.
10. Press the POWER button on the projector or the STANDBY (⏻) button on the remote control again.
 - The lamp goes out and the projector goes into a standby mode. In this standby mode, the STATUS indicator blinks green.
11. Wait about 2 minutes.
 - During this period of 2 minutes in the standby mode, the intake fan and exhaust fan rotate to cool the lamp.
 - The lamp can't be lit again for 1 minute after turning off the projector for safety purpose. It will take another 1 minute for the STATUS indicator to go out. If you want to turn on the projector again, wait until the indicator goes out, and then press the POWER button.
 - The air outlet fans rotate faster as the temperature around the projector rises.
 - Do not unplug the power cord while the STATUS indicator is blinking. Unplugging the power cord immediately after use may cause a lamp breakdown.
 - Though the fan makes loud sound during cooling, such symptom is not a malfunction.
12. Unplug the power cord from the outlet.
 - The POWER indicator will go out.
 - If the power cord should be unplugged accidentally while either the air inlet fan or the air outlet fans are operating or the lamp is on, allow the projector to cool down for 10 minutes with the power off. To light the lamp again, press the POWER button. If the lamp doesn't light up immediately, repeat pressing the POWER button two or three times. If it should still fail to light up, replace the lamp.
 - Cover the lens with the lens cap to protect it from dust.

Viewing video images (continued)

Setting the aspect ratio

You can change the aspect ratio of the input video signal (or the ratio of width to height of the image). Change the setting according to the type of the input video signal.

 : Signal size  : Image area

Setting		4:3	16:9	ZOOM1	ZOOM2	STRETCH	ANAMORPHIC1	ANAMORPHIC2
		Aspect ratio changes depending on the input signal.	Squeezed image is expanded to 16:9.	CinemaScope image is enlarged and displayed together with subtitles.	Vista image is enlarged and displayed together with subtitles.	Image is enlarged to 16:9 while the center aspect ratio remains unchanged.	This mode is suitable for viewing 2.35:1-size images using the anamorphic lens.	This mode is suitable for viewing 16:9- or 4:3-size images or images input from personal computers using the anamorphic lens.
Original image size	4:3 image (480i, 576i, 480p, 576p, and PC)							 480i, 576i, 480p, 576p PC signal
	Squeezed 4:3 (480i, 576i, 480p, 576p)							
4:3 CinemaScope (480i, 576i, 480p, 576p)								
4:3 Vista image (480i, 576i, 480p, 576p)								
16:9 image (720p, 1080i, 1080p)								
2.35:1 image								

- Bold frames are recommended modes.
- When ASPECT is set to AUTO, an optimum aspect ratio is automatically selected depending on the input signal.
- When ASPECT is set to ZOOM1, ZOOM2 or ANAMORPHIC1, display position can be changed with ▲ or ▼ button on the remote control.
- OVER SCAN in the SIGNAL menu is not available in the STRETCH mode.
- Display pattern changes according to the setting of SCREEN SIZE in the IMAGE menu. The table above is in the case of "16:9."
- This projector is equipped with a function to change the aspect ratio. If you select an aspect ratio that is inconsistent with that of the input signal, images around the screen edges may be hidden or deformed. When viewing original video works reflecting the authors' intentions, you are recommended to keep their aspect ratios unchanged.
- It may be an infringement of the rights protected by the copyright law to project images compressed or enlarged by changing the aspect ratio in public areas, such as inside and outside shops and hotels, for commercial or public viewing purposes.
- When SCREEN SIZE of ADVANCED MENU is set to CINEMA SCOPE(2.35:1) in the IMAGE menu, STRETCH, ANAMORPHIC1 and ANAMORPHIC2 cannot be selected for ASPECT.

Viewing video images (continued)

How to change the settings:

With the remote control:

1. Press the ASPECT button or ANAMO button.
 - Every time the ASPECT button is pressed, the aspect mode changes from AUTO to 4:3, 16:9, to ZOOM1, to ZOOM2, to STRETCH, and back to AUTO.
 - Every time the ANAMO button is pressed, the aspect mode changes from ANAMORPHIC1 to ANAMORPHIC2 and back to ANAMORPHIC1.
 - Some modes are not available with certain signals.

With the FEATURE menu:

(See page 29 for menu setting.)

1. Display the FEATURE menu.
2. Select ASPECT by pressing the ▲ or ▼ button.
3. Select your desired aspect ratio by pressing the ◀ or ▶ button.



To cancel the menu:

4. Press the MENU button.

Important:

- When a 4:3 or 2.35:1 (CinemaScope) image is kept displayed for a long time before displaying 16:9 image, the afterimages of the black bars may appear on the 16:9 image screen.

Viewing computer images

A. Connecting the projector to a computer

Preparation:

- Make sure that the power of the projector and that of the computer are turned off.
- When connecting the projector to a desktop computer, disconnect the computer cables that are connected to the monitor.

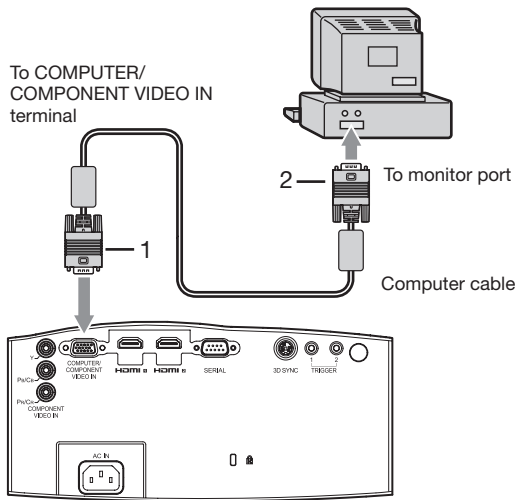

1. Connect one end of the supplied computer cable to the COMPUTER/COMPONENT VIDEO IN terminal of the projector.
 2. Connect the other end of the computer cable to the monitor port of the computer.
- Additional devices, such as a conversion connector and an analog RGB output adapter, are required depending on the type of the computer to be connected.

- Turn on the power of the projector before that of the computer.
- Additional devices, such as a conversion connector and an analog RGB output adapter, are required depending on the type of the computer to be connected.
- Use of a long cable may decrease the quality of projected images.
- Also read the instruction manual of the equipment to be connected.
- Images may not be projected correctly, depending on the type of the computer connected.
- Contact your dealer for details of connection.

About DDC

The COMPUTER/COMPONENT VIDEO IN terminal of this projector complies with the DDC1/2B standard and the HDMI 1 and HDMI 2 terminals comply with the DDC2B standard. When a computer supporting this standard is connected to this terminal, the computer will automatically load the information from this projector and prepare for output of appropriate images.

- After connecting a computer supporting this standard to this terminal, plug the power cord of the projector in the wall outlet first, and then boot up the computer.

B. Plugging the power cord

Plug the power cord in the same way as described in “Viewing video images.” (See page 17.)

C. Projecting images

Preparation:

- Remove the lens cap.
- Turn on the power of the connected computer.

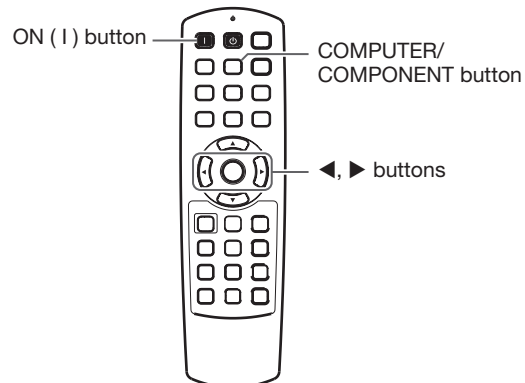
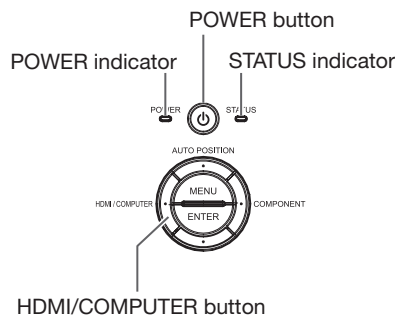

1. Confirm the POWER indicator lights-up red.
 - If the projector was turned off before the lamp had cooled down sufficiently, the fan may start rotating and the POWER button may not work after the power cord is plugged. (The STATUS indicator blinks green.) After the fan stops rotating, press the POWER button to turn back on the POWER indicator.
2. Press the POWER button on the projector or ON (I) button on the remote control.
 - It may take about one minute for the lamp to light up.
 - The lamp fails to light up on rare occasions. In such a case, wait for a few minutes and then try again.
 - Do not cover the lens with the lens cap while the lamp is on.
 - After the POWER button is pressed, the image may flicker before the lamp becomes stable. This is not a product malfunction.
 - The STANDARD lamp mode is activated by default whenever the projector is turned on. When the LOW LAMP MODE has been chosen, the default STANDARD lamp mode is switched to the LOW lamp mode in 1 minute.
 - The projector starts warming up when the POWER button is pressed. During the warm-up process, images may appear dark and no commands are accepted.
 - By blinking red, the STATUS indicator indicates that the lamp should be replaced soon. Replace the lamp when the STATUS indicator blinks red. (See page 51.)
3. Adjust the focus by turning the focus ring.
 - You are recommended to adjust the focus at the screen center.
4. Select an input source.
 - Press the HDMI/COMPUTER button on the projector or the COMPUTER/COMPONENT button on the remote control to select COMPUTER.
 - The input source is switched between COMPUTER, HDMI1 and HDMI2 every time you press the HDMI/COMPUTER button on the projector.
 - The input source is switched between COMPUTER and COMPONENT every time you press the COMPUTER/COMPONENT button on the remote control.
 - Though it may take some time before an image is displayed on the screen depending on the type of the input signal, such symptom is not a malfunction.
 - Images may not be projected in the correct position, depending on the type of the input signal. In such a case, press the AUTO POSITION button. (See page 24.)
 - The projector automatically selects the appropriate signal format. (The selected signal format is displayed on the INFORMATION menu.)
 - You cannot change the input source while the menu is being displayed.
 - When COMPUTER is chosen as the source, images supplied from the computer may flicker. Press the ◀ or ▶ button on the remote control to reduce flicker, if it occurs. (Fine adjustment)
5. Adjust the position of the projector to keep an appropriate projection distance with which images are projected in their specified sizes.
6. Adjust the position of the projector so that the projector and the screen are perpendicular to each other. (See page 10.)
 - When the projector cannot be positioned perpendicularly to the screen, adjust the projection angle. (See page 12.)
7. Adjust the image size by turning the zoom ring.
8. Adjust the vertical position of the displayed image by turning the LENS SHIFT dial.

If necessary, adjust the focus and zoom again.

Viewing computer images (continued)

To stop projecting:

9. Press the POWER button on the projector or the STANDBY (⏻) button on the remote control.
 - A confirmation message is displayed.
 - To cancel the procedure, leave the projector for a while or press the MENU button.
10. Press the POWER button on the projector or the STANDBY (⏻) button on the remote control again.
 - The lamp goes out and the projector goes into a standby mode. In this standby mode, the STATUS indicator blinks green.
11. Wait about 2 minutes.
 - During this period of 2 minutes in the standby mode, the intake fan and exhaust fan rotate to cool the lamp.
 - The lamp can't be lit again for 1 minute after turning off the projector for safety purpose. It will take another 1 minute for the STATUS indicator to go out. If you want to turn on the projector again, wait until the indicator goes out, and then press the POWER button.
 - The air outlet fans rotate faster as the temperature around the projector rises.
 - Do not unplug the power cord while the STATUS indicator is blinking. Unplugging the power cord immediately after use may cause a lamp breakdown.
 - Though the fan makes loud sounds during cooling, such symptom is not a malfunction.
12. Unplug the power cord from the outlet.
 - The POWER indicator will go out.
 - If the power cord should be unplugged accidentally while either the air inlet fan or the air outlet fans are operating or the lamp is on, allow the projector to cool down for 10 minutes with the power off. To light the lamp again, press the POWER button. If the lamp doesn't light up immediately, repeat pressing the POWER button two or three times. If it should still fail to light up, replace the lamp.
 - Cover the lens with the lens cap to protect it from dust.

AUTO POSITION button

When the image supplied from the computer is displaced, carry out the following procedure.

1. Display a bright image (such as a full-screen display of the Recycle Bin window).
2. When the screen saver has been enabled, disable it.
3. Press the AUTO POSITION button.
 - The projector automatically makes optimum positional settings for the input signal.
- If the image is not projected in the correct position even after you press the AUTO POSITION button several times, change the settings in the SIGNAL menu to put the image in the correct position. (See page 34.)
- When you carry out this procedure with a dark image, the image may be displaced.

When connecting to a notebook computer:

When the projector is connected to a notebook computer, images may not be projected in some cases. In such cases, set the computer so that it can output signals externally. The setting procedure varies depending on the type of the computer. See the instruction manual of your computer.

Example of the setting procedure for external output

Press the [Fn] key and any of the keys [F1] to [F12] at the same time. (The key to be pressed depends on the type of the computer you use.)

Setting of the resolution

If the resolution of the computer doesn't match with that of the projector, projected images may be obscured. Ensure that their resolutions are the same (see page 53). For the method to change the output resolution of the computer, contact the manufacturer of the computer.

Viewing 3D images

With the separately sold 3D glasses and 3D emitter, you can enjoy viewing 3D images on this projector.

Usable 3D glasses and 3D emitter

The following table shows the usable 3D glasses and 3D emitter.

3D glasses	3D emitter
General-purpose liquid crystal shutter 3D glasses*1	EY-3D-EMT2H

*1: Some 3D glasses may not work with this projector. Ask the dealer for details. RF 3D glasses are not usable.

Installing the 3D emitter

Connect the 3D emitter to the projector according to the operation manual of the 3D emitter. For connection, use the mini DIN 5-pin cable supplied with this projector.

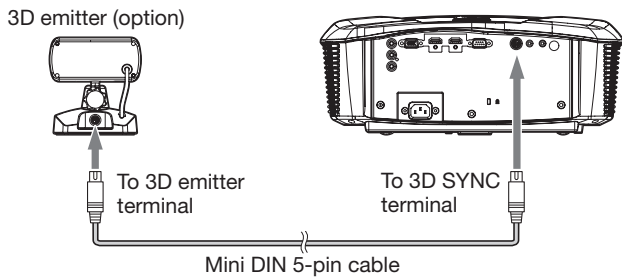

3D images viewing

This projector is able to display the following 3D display supporting broadcasts and signals as stereoscopic images. (As of June, 2012)

- 3D images input from the recorder/player supporting 3D display. (Side by side, top and bottom, and frame packing)
- 3D images by the digital terrestrial broadcasting and BS digital broadcasting. (Side by side) (For viewing 3D images with CATV (cable television), please consult CATV broadcasters or CATV providers.)

(For details about the supported 3D image signal formats, see "3D supported signals" on page 53.)

This projector is also able to display 3D images converted from 2D images.

To view 3D images:

Preparation:

- Please read the user manuals of the 3D glasses and 3D emitter carefully before viewing the 3D images.
- Switching the 3D mode (such as 3D setting system) of the recorder/player may be required when projecting 3D images from the recorder/player supporting 3D display. Read the user manual of the recorder/player for details.

1. Project a 3D image on the screen.
2. Turn the power switch on the 3D glasses to ON.
3. Wear the 3D glasses.
 - Now you are ready to view 3D images.

To change the 3D viewing mode:

When 3D images aren't displayed properly, change the following setting using the menu. (See page 29 for menu setting.)

1. Display the IMAGE menu.
2. Select 3D by pressing the ▲ or ▼ button.



3. Press the ENTER button.
 - The 3D menu will appear.

3D	
3D MODE	AUTO
3D SYNC.	NORMAL
FINE 3D SYNC.	0
24P FRAME RATE	96Hz
3D F.R.C. LEVEL	2
2D-3D CONVERSION	OFF
3D DEPTH	5

4. Press the ▲ or ▼ button to select the desired item and press the ◀ or ▶ button to select the desired option.

3D MODE

If 3D images aren't displayed properly with AUTO selected, select the video format (FRAME PACKING, SIDE BY SIDE, or TOP AND BOTTOM) suitable for the 3D image being displayed. Alternatively, you can select the video format using the 3D MODE button on the remote control. To accept the video format you have selected, press the ENTER button after selection.

3D SYNC.

If you feel uncomfortable while viewing 3D images, the right-left synchronization between the 3D image and the 3D glasses (LCD shutter) may be lost. In such a case, set 3D SYNC. to REVERSE.

Viewing 3D images (continued)

FINE 3D SYNC.

If you feel something wrong with or find ghosts in the 3D image being displayed, the open/close timing of the lens (liquid crystal shutter) of the 3D glasses may be out of sync with the displayed image. In such a case, adjust the setting of FINE 3D SYNC.

24P FRAME RATE

When you are annoyed with flicker in a bright area in the image when a 1080p24 frame packing signal is input, select 120Hz.

- When 24P FRAME RATE is set to 120Hz, the motion interpolation by the frame rate conversion isn't performed while a 3D image is displayed.

3D F.R.C. LEVEL

You can control the effect level of the motion interpolation by the frame rate conversion while a 3D image is displayed.

- The motion interpolation to 3D images works only when a 1080p24 frame packing signal is input.

To stop the signal emitted from the 3D emitter temporarily:

While you are viewing a 3D image, the remote control of your DVD recorder or other apparatus may not work properly. In such a case, stop the signal emitted from the 3D emitter temporarily by pressing the 3D SYNC PAUSE button on the remote control of the projector. Note that while the signal is stopped, a warning message appears and images aren't displayed in the 3D mode.

To convert 2D images to 3D images:

With the remote control:

1. Project a 2D image.
2. Press the 3D MODE button.
3. Press the ◀ or ▶ button to select AUTO  and press the ENTER button.
4. Press the 2D-3D button.
5. Press the ◀ or ▶ button to select ON.
 - Now 2D images are converted into 3D images.
6. Turn the power switch on the 3D glasses to ON and wear the 3D glasses.
7. Press the ENTER button.
 - The screen for adjusting the depth of the converted 3D images will appear.
8. Adjust the depth of the converted 3D images by pressing the ◀ or ▶ button.
 - You can select the depth from 10 levels (1 to 10). As the level increases, the appearance of depth is enhanced.
 - To finish the conversion to 3D images, press the 2D-3D button and then press the ◀ or ▶ button to select OFF.

With the 3D menu:

(See page 29 for menu setting.)

1. Project a 2D image.
2. Display the IMAGE menu.
3. Select 3D by pressing the ▲ or ▼ button and press the ENTER button.
 - The 3D menu will appear.
4. Select 3D MODE by pressing the ▲ or ▼ button.



5. Set 3D MODE to AUTO  by pressing the ◀ or ▶ button and then press the ENTER button.
6. Repeat steps 2-3 to display the 3D menu again.
7. Select 2D-3D CONVERSION by pressing the ▲ or ▼ button.



8. Set 2D-3D CONVERSION to ON by pressing the ◀ or ▶ button.
 - Now 2D images are converted into 3D images.
9. Turn the power switch on the 3D glasses to ON and wear the 3D glasses.
10. Select 3D DEPTH by pressing the ▲ or ▼ button.



11. Adjust the depth of the converted 3D images by pressing the ◀ or ▶ button.
 - To finish the conversion to 3D images, set 2D-3D CONVERSION back to OFF.

Important:

- If the viewing distance is nearer than the recommended distance, it will cause physical discomfort and eye fatigue.
- The 3D glasses may not work properly when it is used too far from the screen.
- Watch the contents in front of the screen, not at big angle. If you are viewing the screen at big angle, you may not be able to view 3D contents correctly.
- There are personal differences in viewing the 3D images. For persons with myopia, hypermetropia, astigmatism or left and right sights, please wear glasses to correct them then wear the 3D glasses.
- The picture seems misplaced at the start of projecting the 3D images, however, this is not a malfunction.
- 3D images converted from 2D images appear blurred due to conversion.
- While side-by-side or top-and-bottom 3D images are displayed, the aspect ratio setting is fixed to 16:9.
- When you display a menu or dialog while viewing side-by-side or top-and-bottom 3D images, they are displayed in the 2D mode temporarily. When the menu or dialog disappears, they are displayed in the 3D mode again.

Viewing 3D images (continued)

- The keystone setting is invalid (restored to the default setting) while you are watching the 3D images. The setting can not be changed.
- When connecting the projector and a player such as BD player through a HDMI signal distributor or AV amplifier via HDMI cable, make sure to use the HDMI signal distributor or AV amplifier supporting HDMI 1.4 (3D).
- This projector controls the open/close timing of the 3D glasses lenses (liquid crystal shutter) by using the infra-red signals received from the 3D emitter. Therefore, in rare cases, a remote control of other devices such as an air conditioner or lighting apparatus which uses the infra-red signals may not operate properly (while you are watching the 3D images). However, it is not a malfunction.
- When viewing contents with movements such as rotation, or horizontal or vertical oscillation, you may feel as if you are actually moving. If such a feeling results in discomfort, look away from the screen.
- When using the 3D glasses, be careful not to strike the screen or other people by mistake. As the images are in 3D, you may mistake the distance from the screen, causing to strike the screen which may result in injury. When using the 3D glasses, do not place breakable objects near the glasses. You may move by mistaking the 3D objects you are viewing as the real objects, causing damages to surrounding objects that may lead to injury.
- When using the 3D glasses, make sure your eyes are on an approximate horizontal level. If you suffer from myopia (short sightedness), hyperopia (far-sightedness), astigmatism, or have eyesight differences between the left and right eyes, please use corrective glasses or other such methods to correct your eyesight before putting on the 3D glasses.
- When you view the 3D images, keep a distance from the screen of about three times the effective height of the screen.

Caution:

Notes on danger to public health during watching 3D image

- Stop viewing the 3D image immediately if you feel tired, discomfort, or any other abnormality. It may cause you to feel unwell if continuing to watch the 3D image in such cases. Please take the necessary rest, do not continue watch the 3D image for a long time. Stop using the 3D glasses if you can clearly see double images when viewing 3D content. Prolonged use may cause eyesight fatigue.
- The following people need to refrain from use as with 2D image.
 - a photosensitive patient
 - a patient with heart disease
 - a person in poor physical condition
 - a sleepy person
 - a very tired person
 - a drunk person
 - children
- When watching 3D movies, take an appropriate break after watching a movie. When watching 3D content on interactive devices such as 3D games or computers, take an appropriate break every 30-60 minutes. Prolonged use may cause eyesight fatigue.
- When you feel uncomfortable, stop viewing 3D images and playing 3D games until you are restored. If necessary, consult a doctor. Also, stop driving a car until you are restored (for about 2 hours). The period to restore varies with the individual.
- As a guide, 3D glasses should not be used by children younger than 5 - 6 years old. As it is difficult to judge younger children's reactions to fatigue or discomfort, their physical condition may deteriorate suddenly. When this product is being used by a child, the parent or guardian should check to ensure that the child's eyes are not becoming tired.
- When viewing the pictures that roll over and shake or many dynamic pictures, if you feel uncomfortable, please look at another place.

Menu operation

You can make various settings using the displayed menus.

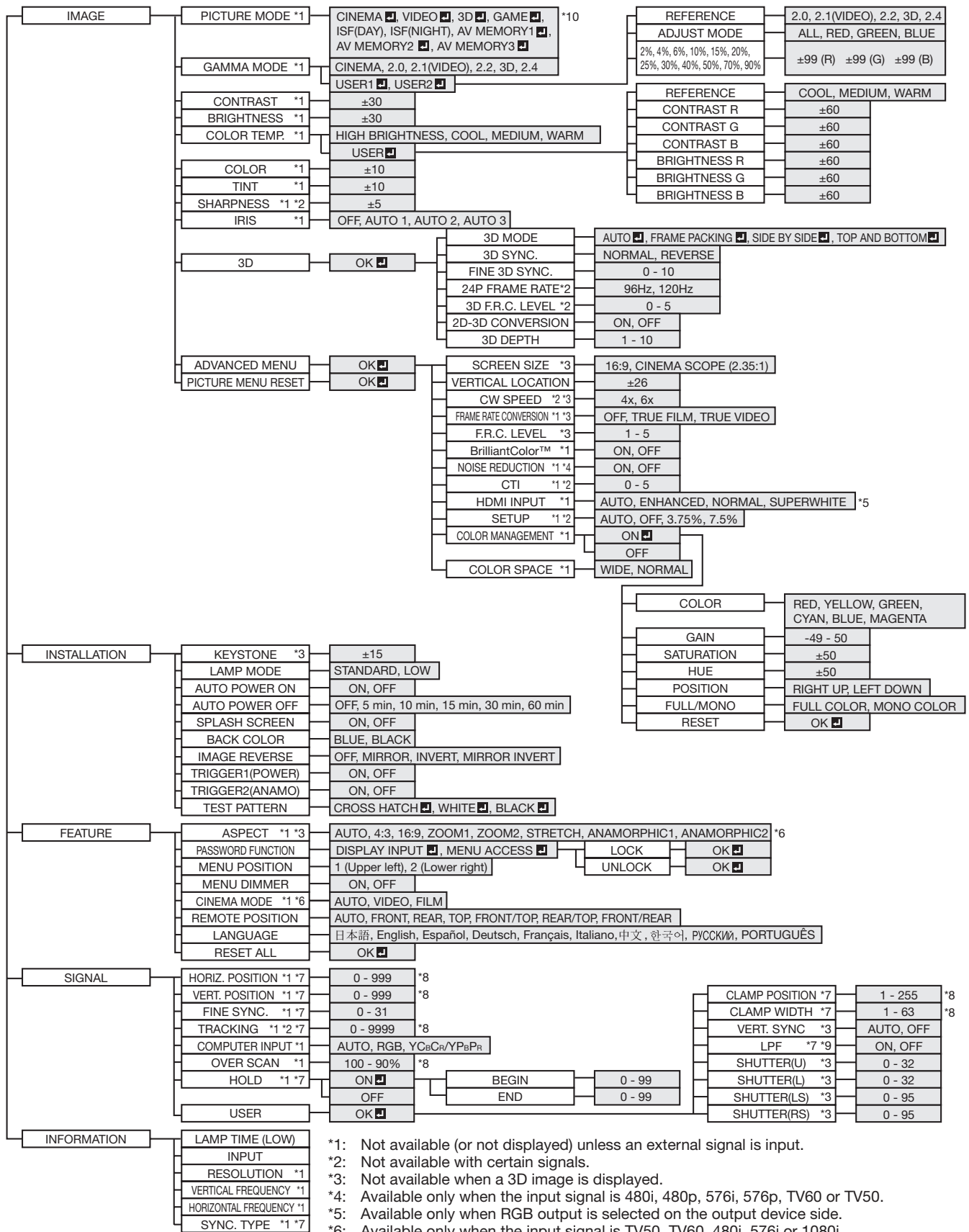

- *1: Not available (or not displayed) unless an external signal is input.
- *2: Not available with certain signals.
- *3: Not available when a 3D image is displayed.
- *4: Available only when the input signal is 480i, 480p, 576i, 576p, TV60 or TV50.
- *5: Available only when RGB output is selected on the output device side.
- *6: Available only when the input signal is TV50, TV60, 480i, 576i or 1080i.
- *7: Not available when the input signal is from the HDMI 1 or HDMI 2 terminal.
- *8: Setting range differs depending on the input signals.
- *9: Available only when the input signal is 480i, 480p, 576i, or 576p.
- *10: The ISF(DAY) and ISF(NIGHT) modes are adjustable by ISF-certified professionals only. Contact your dealer for details of the ISF adjustment.

Menu operation (continued)

How to set the menus

1. Press the MENU button.

- The menu selection bar is displayed.

Selectable menus are displayed by icons. (The menu icon being selected is displayed on a blue background.)

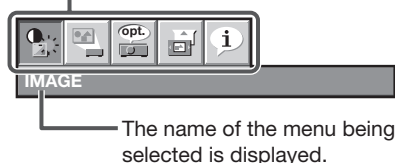

2. Press the ◀ or ▶ button to select a menu to use.

3. Press the ENTER button (or ▼ button).

- The selected menu is displayed.

The item being selected is displayed in red letters.

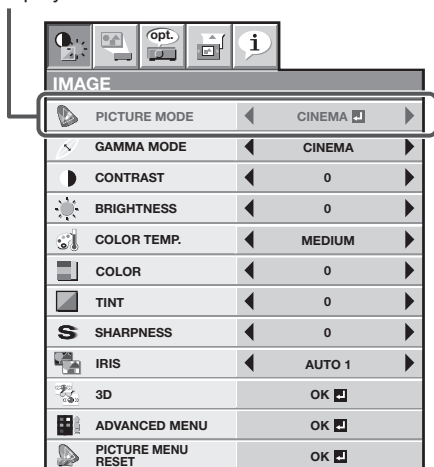

4. Press the ▲ or ▼ button to select an item to adjust.

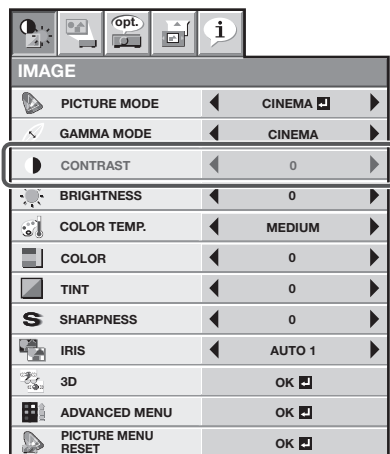

5. Set the selected item by pressing the ◀ or ▶ button.

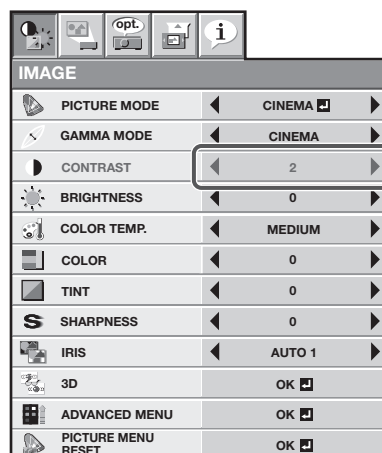

6. To cancel the menu, press the MENU button several times.

Important:

- When an item marked with “” is selected, pressing the ENTER button makes its value effective or displays another screen for further setting.
- When the MENU button doesn't function, unplug the power cord from the wall outlet. Wait about 10 minutes, plug the power cord in, and try again.
- The menus and screens shown in this manual may be different from those of the actual projector.
- You cannot select (or set) grayed-out items. Whether items can be selected or not depends on the presence of an input signal at the time when the menu is displayed, the type of such input signal, and other conditions.

Example:

Grayed-out items cannot be selected.

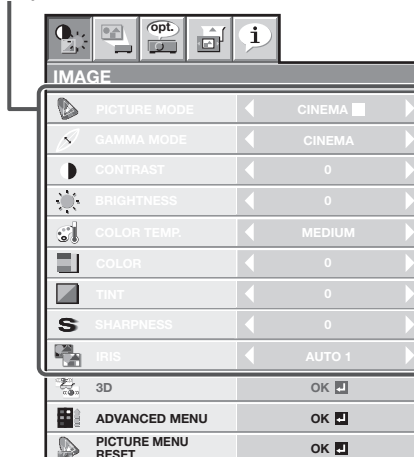

Menu operation (continued)

Menu items

Set the following items provided in the respective menus.

IMAGE menu

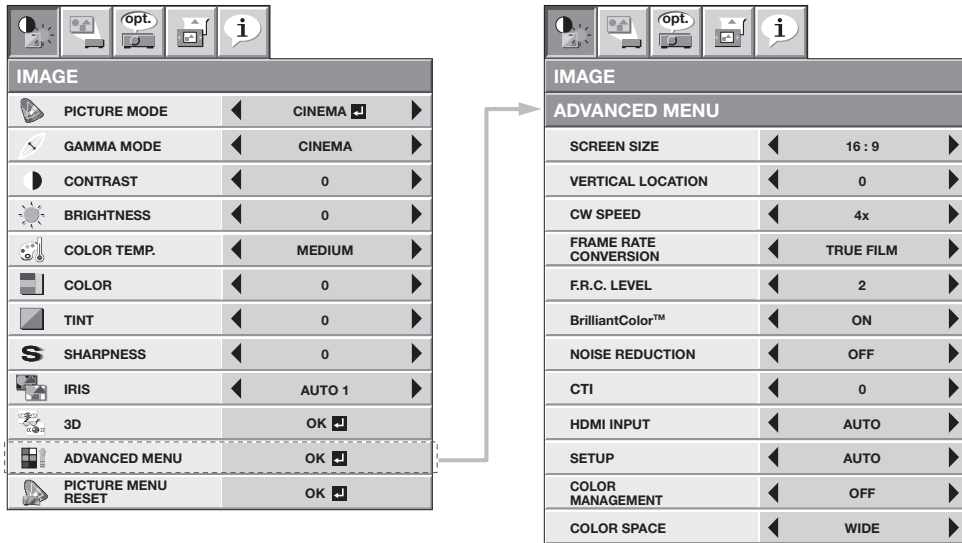

ITEM	SETTING	FUNCTION
PICTURE MODE	CINEMA	Mode for watching movies in dim lighting as in a theater.
	VIDEO	Standard mode suitable for watching video images, etc.
	3D	Mode for watching 3D movies.
	GAME	Mode for watching game screens.
	ISF(DAY) / ISF(NIGHT)	Select this when watching images using the ISF (day) or ISF (night) picture quality settings.
	AV MEMORY1 / AV MEMORY2 / AV MEMORY3	Save the customized picture quality settings in the IMAGE menu to these options.
GAMMA MODE	CINEMA	Mode for displaying even dark areas in the image clearly, suitable for watching movies.
	2.0	Bright mode suitable for watching sports images, etc.
	2.1(VIDEO)	Standard mode suitable for video images, etc.
	2.2	Standard mode suitable for film materials.
	3D	Brightest mode for watching 3D movies.
	2.4 USER1 / USER2	Mode suitable for watching crisp and sharp images. Mode to customize the gamma curve. (See page 39.)
CONTRAST	±30	Use to adjust the contrast of the projected image. (See page 36.)
BRIGHTNESS	±30	Use to adjust the brightness of the projected image. (See page 36.)
COLOR TEMP.	5 options	Use to adjust the color temperature. (See page 37.)
COLOR	±10	Use to adjust the color thickness of the projected image. (See page 36.)
TINT	±10	Use to adjust the color tint of the projected image. (See page 36.)
SHARPNESS	±5	Use to adjust the sharpness of the projected image. (See page 37.)
IRIS	4 options	Select the operation mode of the IRIS. (See page 38.)
3D	OK	Select to configure the settings for 3D display. (See page 25.)

- You can customize and save the picture quality settings of each option of PICTURE MODE, which correspond to the settings of each item in the IMAGE menu. (See page 36.)
- The ISF(DAY) and ISF(NIGHT) modes are adjustable by ISF-certified professionals only. You can select the ISF-related settings only when they are already adjusted. Contact your dealer for adjustment.

Menu operation (continued)

IMAGE menu (continued)

ITEM	SETTING	FUNCTION
ADVANCED MENU	OK	The ADVANCED MENU is displayed for the following settings.
SCREEN SIZE	2 options	Select according to the screen size.
VERTICAL LOCATION	±26	Use to adjust the position (height) of the projected image.
CW SPEED	4x / 6x	Select the color wheel speed. 6x is effective only when a 1080p 24 signal is input.
FRAME RATE CONVERSION	OFF	A 96Hz driver provides four times in the input of 24P, realizing a speed of film. This mode is suitable for playing games as this mode does not cause the image delay due to conversion.
	TRUE FILM	Use to produce the sharp images, leaving frame-by-frame feeling unique to films.
	TRUE VIDEO	Use to reduce blurring of the moving images by interpolating the video images.
F.R.C. LEVEL	1 - 5	Use to adjust the effect level of the motion interpolation for the frame rate conversion.
BrilliantColor™	ON / OFF	Use to select whether or not to enable the BrilliantColor™.
NOISE REDUCTION	ON / OFF	Reduces noise of projected images when the input signal is noisy.
CTI	0 - 5	Use to correct smeared color boundaries.
HDMI INPUT	AUTO	The proper setting is automatically selected for HDMI input signal.
	ENHANCED	Select this when solid black appears with AUTO selected for HDMI input. (See page 16.)
	NORMAL	Select this when grayish black appears with AUTO selected for HDMI input. (See page 16.)
	SUPERWHITE	Select this when solid white appears with AUTO selected for HDMI input. (See page 16.)
SETUP	AUTO	Select AUTO for normal use. When LANGUAGE is not set to 日本語 and 480i, 480p or TV60 signal is input, the SETUP changes to 7.5% automatically.
	OFF	Select to make black lighter.
	3.75% / 7.5%	Select to make black intense. <ul style="list-style-type: none"> When 7.5% is chosen, the brightness is decreased by the set-up cancel function for the U.S. Choose OFF when the image is dark.
COLOR MANAGEMENT	ON / OFF	Select ON to change to any desired color by adjusting each of GAIN, SATURATION and HUE of six different colors. (See page 39.)
COLOR SPACE	WIDE	The color space becomes wider than that of NORMAL and colors appear natural.
	NORMAL	The color space gets close to that of sRGB.
PICTURE MENU RESET	OK	Pressing the ENTER button resets the picture quality settings of the selected picture mode to the factory defaults.

- When FRAME RATE CONVERSION is set to other than OFF, the image may flicker at an instant when the menu is displayed.
- While a 3D image is displayed, you cannot set SCREEN SIZE, CW SPEED, FRAME RATE CONVERSION, and F.R.C. LEVEL.
- While a 2D image is displayed except for 24P, you cannot set CW SPEED.

Menu operation (continued)

INSTALLATION menu

INSTALLATION		
KEYSTONE	◀	0 ▶
LAMP MODE	◀	LOW ▶
AUTO POWER ON	◀	OFF ▶
AUTO POWER OFF	◀	OFF ▶
SPLASH SCREEN	◀	ON ▶
BACK COLOR	◀	BLUE ▶
IMAGE REVERSE	◀	OFF ▶
TRIGGER1(POWER)	◀	OFF ▶
TRIGGER2(ANAMO)	◀	OFF ▶
TEST PATTERN	◀	CROSS HATCH ▶

ITEM	SETTING	FUNCTION
KEYSTONE	±15	Use to correct vertical keystone distortion.
LAMP MODE	STANDARD LOW	Select this option when you want to view images in a well-lit room. Select to moderate the intensity of the lamp. The fan operating sound is reduced and the lamp lifetime becomes longer.
AUTO POWER ON	ON / OFF	When ON is chosen, the lamp is automatically lit when the power cord is plugged in the wall outlet. Choose ON when using the projector mounted on the ceiling. <ul style="list-style-type: none"> The projector is in the stand-by mode when the lamp is off. Use the remote control to turn on the lamp.
AUTO POWER OFF	OFF / 5 - 60min	Use to set the time elapsed before the projector enters the stand-by mode when there is no signal input from the source.
SPLASH SCREEN	ON / OFF	Choose ON to display the splash screen when the power is turned on.
BACK COLOR	BLUE / BLACK	Use to change the color of the screen that appears when no signal is supplied.
IMAGE REVERSE	OFF MIRROR INVERT MIRROR INVERT	Select when viewing images from the front with the projector installed on the floor. Select when viewing images projected from the behind of the screen with the projector installed on the floor. Select when viewing images projected from the behind of the screen with the projector installed on the ceiling. Select when viewing images from the front with the projector installed on the ceiling.
TRIGGER1(POWER)	ON / OFF	The trigger output signal (12 V) is output from the TRIGGER 1 terminal when the lamp illuminates.
TRIGGER2(ANAMO)	ON / OFF	The trigger output signal (12 V) is output from the TRIGGER 2 terminal when the aspect ratio is set to ANAMORPHIC 1 or ANAMORPHIC 2.
TEST PATTERN	CROSS HATCH WHITE BLACK	Select to show the test cross hatch pattern. Select to show the maximum brightness image. Select to show the minimum brightness image.

- When LAMP MODE has been set to LOW, the lamp mode changes from STANDARD to LOW about one minute after turn-on.
- When the lamp mode is switched, the projected image may flicker. This is not a product malfunction.
- Do not change the setting of LAMP MODE frequently.
- To cancel the test pattern, press any button.
- While a 3D image is displayed, you cannot set KEYSTONE.

Menu operation (continued)

FEATURE menu

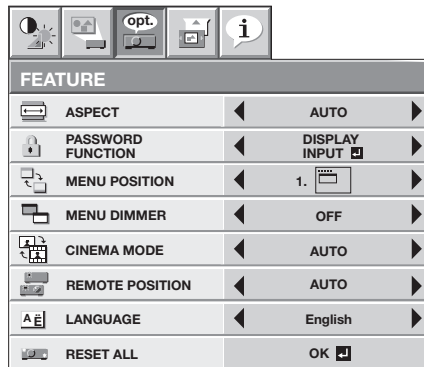

ITEM	SETTING	FUNCTION
ASPECT	AUTO	Select to change the aspect ratio automatically depending on the input signal.
	4:3	Select to project images with an aspect ratio of 4:3.
	16:9	Select to project images with an aspect ratio of 16:9. (Linearly stretched.)
	ZOOM1	Select to enlarge and project images of CinemaScope size.
	ZOOM2	Select to enlarge and project images of Vista size.
	STRETCH	Select to enlarge to 16:9 and project of the images with an aspect ratio of 4:3. (Non-linearly stretched.)
	ANAMORPHIC1	This mode is suitable for viewing 2.35:1-size images using the anamorphic lens. Use the ▲ or ▼ key to adjust the vertical display position.
ANAMORPHIC2		This mode doesn't support input signals from personal computers.
		This mode is suitable for viewing 16:9- or 4:3-size images or images input from personal computers using the anamorphic lens.
		Use to enable or cancel the password lock. See page 41 for details.
PASSWORD FUNCTION	2 options	Use to enable or cancel the password lock. See page 41 for details.
MENU POSITION	2 options	Use to change the position of the menu.
MENU DIMMER	ON / OFF	Use to reduce the brightness of the menu.
CINEMA MODE	AUTO	The film mode will be automatically activated when a film source signal is input. Select AUTO for normal use.
	VIDEO	When flicker occurs on the screen or jaggies on slanting lines are remarkable, select FILM when a film source signal is input or select VIDEO for other signals.
	FILM	The film mode will not be activated. Fixed to the film mode.
REMOTE POSITION	AUTO / FRONT / REAR / TOP / FRONT/TOP / REAR/TOP / FRONT/REAR	Select the remote control sensors (front, rear, or top) to be activated.
LANGUAGE	10 languages	Use to select the language used in the menus.
RESET ALL	OK	Use to reset the settings of the menu (excluding PASSWORD FUNCTION and LANGUAGE) to the factory setting values.

- When SCREEN SIZE of ADVANCED MENU is set to CINEMA SCOPE (2.35:1) in the IMAGE menu, STRETCH, ANAMORPHIC1, and ANAMORPHIC2 cannot be selected for ASPECT.
- It may take a little while to carry out RESET ALL in the FEATURE menu.

Menu operation (continued)

SIGNAL menu

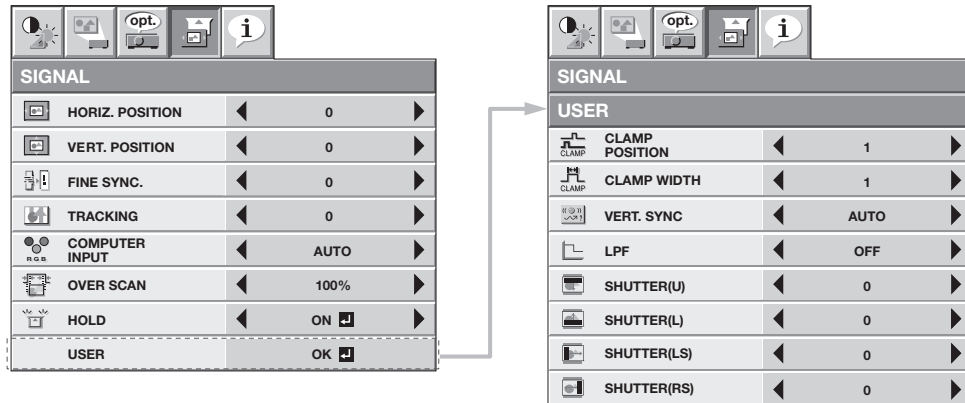

ITEM	SETTING	FUNCTION
HORIZ. POSITION	0 - 999	Use to adjust the horizontal position of the projected image.
VERT. POSITION	0 - 999	Use to adjust the vertical position of the projected image.
FINE SYNC.	0 - 31	Use to eliminate flickering or blur, if it appears, while viewing the projected image.
TRACKING	0 - 9999	Use to eliminate vertical wide stripes, if it appears, while viewing the projected image.
COMPUTER INPUT	AUTO RGB YCbCr/YpBPr	The proper setting is automatically selected. Select this option when connecting the projector to high definition video equipment having R, G, and B output terminals. Select this option when connecting the projector to a DVD player or other device having Y, C _B , and C _R (or Y, P _B , and P _R) component video output terminals.
OVER SCAN	100 - 90%	Use to adjust the display area of the projected image when playing LD and DVD discs.
HOLD	OFF / ON	Use to adjust the image when flagging occurs near the top of the screen.
USER	OK	
CLAMP POSITION	1 - 255	Use to correct solid white or solid black in the projected image.
CLAMP WIDTH	1 - 63	Use to correct solid black in the projected image.
VERT. SYNC	AUTO / OFF	Use to adjust the image when its motion doesn't run smoothly. Select AUTO for normal use.
LPF	ON / OFF	Use to select whether or not to enable the LPF.
SHUTTER(U)	0 - 32	Use to display the black bar on the top part of the image.
SHUTTER(L)	0 - 32	Use to display the black bar on the bottom part of the image.
SHUTTER(LS)	0 - 95	Use to display the black bar on the left half of the image.
SHUTTER(RS)	0 - 95	Use to display the black bar on the right half of the image.

- Though horizontal strips may appear on the enlarged projected image, such symptom is not a malfunction.
- When you change the horizontal or vertical position to a large extent, noise may appear.
- The adjustable range of the vertical position varies depending on the type of the input signal. Though the image may stay in the same position even when the setting value is changed, such symptom is not a malfunction.
- If you increase the OVER SCAN setting when viewing video signals, noise may appear on the screen. In this case, decrease the OVER SCAN setting.
- While a 3D image is displayed, OVER SCAN is fixed to 100%.
- While a 3D image is displayed, you cannot set VERT. SYNC and SHUTTER.
- When CW SPEED of ADVANCED MENU is set to 6x in the IMAGE menu, you cannot set VERT. SYNC.

Menu operation (continued)

INFORMATION menu

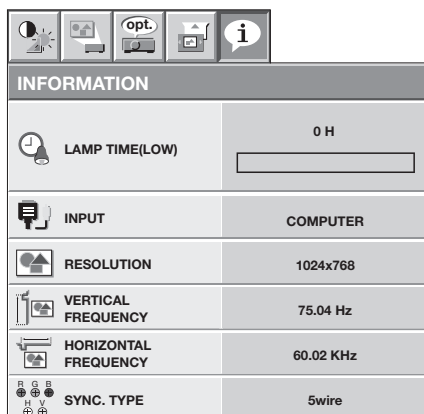

The screenshot shows the 'INFORMATION' menu with a navigation bar at the top containing icons for Home, Back, Opt., Forward, and Info. The menu items and their values are as follows:

ITEM	DESCRIPTION
LAMP TIME(LOW)	0 H
INPUT	COMPUTER
RESOLUTION	1024x768
VERTICAL FREQUENCY	75.04 Hz
HORIZONTAL FREQUENCY	60.02 KHz
SYNC. TYPE	5wire

ITEM	DESCRIPTION
LAMP TIME(LOW)	<p>This item shows a lamp operating time (hour) calculated based on that LAMP MODE is LOW.</p> <ul style="list-style-type: none">• When the LAMP MODE is STANDARD, this item shows a longer lamp operating time than the actual time. (See page 42 for the interval of lamp replacement.)• When the lamp operating time is 0 to 10 hours, "0H" is displayed. The lamp operating time exceeding 10 hours is indicated by the actual hours.• When the lamp operating time reaches 3750 hours, the bar turns to yellow. When it reaches 4750 hours, the bar turns to red.
INPUT	<p>Indicates the name of the terminal to which the currently projected video signal is being input.</p>
RESOLUTION	<p>Indicates the resolution of the currently projected video signal.</p>
VERTICAL FREQUENCY	<p>Indicates the vertical frequency of the currently projected video signal.</p>
HORIZONTAL FREQUENCY	<p>Indicates the horizontal frequency of the currently projected video signal.</p>
SYNC. TYPE	<p>Indicates the type of the sync signal for the currently projected video signal.</p>

Adjusting projected images

To save and call the customized picture quality settings (PICTURE MODE):

This projector has nine picture modes: CINEMA, VIDEO, 3D, GAME, ISF(DAY), and ISF(NIGHT), which provide the optimum preset picture quality settings according to the images to be viewed, and AV MEMORY 1 to 3. You can customize and save the settings of these picture modes and call them when viewing images.

To change and store the picture quality settings of each picture mode:

(See page 29 for menu setting.)

1. Select PICTURE MODE in the IMAGE menu.



2. Press the ◀ or ▶ button to select the picture mode you want to change its picture quality settings.
3. Make the picture quality settings in the IMAGE menu as desired.
4. Select PICTURE MODE again.
5. Press the ENTER button.
 - A dialog box confirming you want to store the settings appears.
6. Press the ENTER button.
 - The settings you made are stored.

To enable the stored picture quality settings:

With the remote control:

1. Press the PICTURE MODE button to select your desired picture mode.
 - Every time the PICTURE MODE button is pressed, the picture mode changes from CINEMA to VIDEO, to 3D, to GAME, to ISF(DAY), to ISF(NIGHT), and back to CINEMA.
 - The AV MEMORY 1-3 buttons can be used to select the picture modes, AV MEMORY1, AV MEMORY2, and AV MEMORY3.

With the IMAGE menu:

1. Perform steps 1-2 in the section “To change and store the picture quality settings of each picture mode.”
 - When you call up the stored settings and make changes to them, the changes remain effective. However, they aren’t saved unless you perform the procedure for saving them.
 - When the input source is changed, the picture mode selected just before is automatically selected.
 - PICTURE MENU RESET in the IMAGE menu resets the IMAGE menu settings configured in the currently selected picture mode to the factory defaults.
 - When RESET ALL in the FEATURE menu is selected, the IMAGE menu settings configured in all the picture modes are reset to the factory defaults.

To adjust the brightness (CONTRAST and BRIGHTNESS):

You can make adjustments for the brightness of the projected image using the menu. (See page 29 for menu setting.)

1. Display the IMAGE menu.
2. Select CONTRAST or BRIGHTNESS by pressing the ▲ or ▼ button.
3. Adjust the selected item by pressing the ◀ or ▶ button.

To cancel the menu:

4. Press the MENU button.

CONTRAST

Select to adjust the contrast of the image. Every time the ▶ button is pressed, the image becomes brighter and more defined. Every time the ◀ button is pressed, the image becomes darker and less defined.

BRIGHTNESS

Every time the ▶ button is pressed, the image becomes brighter. Every time the ◀ button is pressed, the image becomes darker.

To adjust the color (COLOR and TINT):

You can adjust the color of the projected image using the menu.

(See page 29 for menu setting.)

1. Display the IMAGE menu.
2. Select COLOR or TINT by pressing the ▲ or ▼ button.
3. Adjust the selected item by pressing the ◀ or ▶ button.

To cancel the menu:

4. Press the MENU button.

COLOR

Use to adjust the color intensity of the projected image. Every time the ▶ button is pressed, the color intensity increases. Every time the ◀ button is pressed, the color intensity decreases.

TINT

Use to adjust the tint of the projected image. Every time the ▶ button is pressed, the image appears more greenish. Every time the ◀ button is pressed, the image appears more reddish.

Adjusting projected images (continued)

To sharpen or soften the projected image (SHARPNESS):

You can adjust the sharpness of the projected image using the menu.
(See page 29 for menu setting.)

1. Display the IMAGE menu.
2. Select SHARPNESS by pressing the ▲ or ▼ button.
3. Adjust the selected item by pressing the ◀ or ▶ button.

To cancel the menu:

4. Press the MENU button.

To adjust the tone of white (COLOR TEMP.):

You can select a preset color temperature (white tone) using the menu.
(See page 29 for menu setting.)

1. Display the IMAGE menu.
2. Select COLOR TEMP. by pressing the ▲ or ▼ button.
3. Select your desired color temperature by pressing the ◀ or ▶ button.

The color temperature of each option is as follows:

COOL: Approx. 9300K, MEDIUM: Approx. 6500K (D65), WARM: Approx. 5800K.







To cancel the menu:

4. Press the MENU button.

To adjust the tone of white (To customize the color temperature):

To customize (and store) the color temperature to your preference, carry out the following procedure.
(See page 29 for menu setting.)

1. Select COLOR TEMP. in the IMAGE menu.
2. Press the ◀ or ▶ button to select USER .
3. Press the ENTER button.
4. Press the ▲ or ▼ button to select REFERENCE.
5. Press the ◀ or ▶ button to select basic color temperature.
 - Generally, select the most preferable color temperature from the preset color temperature.
6. Press the ▲ or ▼ button to select the desired item.
7. Press the ◀ or ▶ button to adjust the selected item.
8. Repeat steps 6 and 7 for optimum adjustment results.

COLOR TEMP.-USER		
	REFERENCE	◀ MEDIUM ▶
	CONTRAST R	◀ 0 ▶
	CONTRAST G	◀ 0 ▶
	CONTRAST B	◀ 0 ▶
	BRIGHTNESS R	◀ 0 ▶
	BRIGHTNESS G	◀ 0 ▶
	BRIGHTNESS B	◀ 0 ▶

To cancel the menu:

9. Press the MENU button.

To enable the stored color temperature:

1. Select USER  by pressing the COLOR TEMP. button on the remote control.

About color temperature

There are different kinds of white color. Color temperature is a way to show the differences in white. White of which temperature is low appears reddish. When the color temperature rises, white appears bluish. For example, you can change the color temperature using the following procedures.

To rise the color temperature: Increase the CONTRAST B (blue) and decrease the CONTRAST R (red).

To reduce the color temperature: Decrease the CONTRAST B (blue) and increase the CONTRAST R (red).

- If you set all of CONTRAST R, G, and B to negative values, the original brightness of the image can't be obtained even when you maximize CONTRAST in the IMAGE menu.

Adjusting projected images (continued)

To optically brighten or darken projected images (IRIS):

IRIS is a function that controls the lamp light by opening or closing the iris to optically adjust the contrast. This projector is equipped with IRIS which automatically controls the iris according to the images to be projected.

IRIS has four modes as follows.

AUTO 1

When there are white images in an entirely dark scene, black is automatically deepened.

AUTO 2

In comparison with AUTO 1, black is made lighter automatically.

AUTO 3

This mode provides deeper blacks than the other modes.

OFF

The IRIS is kept fully opened.

To change the IRIS mode:

With the remote control:

1. Press the IRIS button.
 - Every time the IRIS button is pressed, the IRIS mode changes from AUTO 1 to AUTO 2, AUTO 3, to OFF, and back to AUTO 1.

With the IMAGE menu:

(See page 29 for menu setting.)

1. Display the IMAGE menu.
2. Select IRIS by pressing the ▲ or ▼ button.



3. Select your desired IRIS mode by pressing the ◀ or ▶ button.

To use BrilliantColor™:

You can enable or disable BrilliantColor™ using the menu.

(See page 29 for menu setting.)

1. Display the ADVANCED MENU from the IMAGE menu.
2. Select BrilliantColor™ by pressing the ▲ or ▼ button.
3. Select ON or OFF by pressing the ◀ or ▶ button.

To cancel the menu:

4. Press the MENU button.

ON

Even in a bright home theater environment, you can view crisp and sharp images. Select ON when you want to view bright images such as when viewing 3D images.

OFF

BrilliantColor™ is disabled and the middle tone is adjusted to natural brightness.

Adjusting projected images (continued)

To adjust the ratio of change in brightness (GAMMA MODE):

You can select a preset gamma mode using the menu.

(See page 29 for menu setting.)

1. Display the IMAGE menu.
2. Select GAMMA MODE by pressing the ▲ or ▼ button.
3. Select your desired gamma mode by pressing the ◀ or ▶ button.



To cancel the menu:

4. Press the MENU button.

To adjust the original ratio of change in brightness (To customize the gamma mode):

To customize (and store) the gamma mode to your preference, carry out the following procedure.

(See page 29 for menu setting.)

1. Select GAMMA MODE in the IMAGE menu.
2. Press the ◀ or ▶ button to select USER1  or USER2 .
3. Press the ENTER button.
4. Press the ▲ or ▼ button to select REFERENCE.
5. Press the ◀ or ▶ button to select basic gamma curve.
 - Generally, select the most preferable gamma curve from the preset gamma curve.
6. Press the ▲ or ▼ button to select ADJUST MODE.
7. Press the ◀ or ▶ button to adjust mode of gamma curve (ALL, RED, GREEN, or BLUE).
 - Select whether to adjust RED, GREEN, and BLUE collectively or separately.
8. Press the ▲ or ▼ button to select the signal level (2%, 4%, 6%, 10%, 15%, 20%, 25%, 30%, 40%, 50%, 70%, or 90%) you want to adjust.
 - For selecting the signal level, by pressing the ▼ button while 20% is selected, levels from 25% to 90% are displayed; by pressing the ▲ button while 25% is selected, levels from 2% to 20% are displayed.
9. Press the ◀ or ▶ button to adjust the selected item.
 - The values displayed correspond to RED, GREEN, and BLUE from the left respectively.
10. Repeat steps 6 - 9 for optimum adjustment results.

GAMMA MODE-USER1		
REFERENCE	◀	2.0 ▶
ADJUST MODE	◀	ALL ▶
2%	◀	0 0 0 ▶
4%	◀	0 0 0 ▶
6%	◀	0 0 0 ▶
10%	◀	0 0 0 ▶
15%	◀	0 0 0 ▶
20%	◀	0 0 0 ▶

To cancel the menu:

11. Press the MENU button.

To enable the stored gamma mode:

1. Select USER1 or USER2 by pressing the GAMMA button on the remote control.
 - Change in the brightness may be hard to recognize in some images.

To use COLOR MANAGEMENT:

This projector can individual adjusts each tone in red, yellow, green, cyan, blue and magenta. You can adjust the tone colors using the COLOR MANAGEMENT menu.

(See page 29 for menu setting.)

1. Display the ADVANCED MENU from the IMAGE menu.
2. Press the ▲ or ▼ button to select COLOR MANAGEMENT.
3. Press the ◀ or ▶ button to select ON .
4. Press the ENTER button.
 - The COLOR MANAGEMENT menu appears.
 - Once the COLOR MANAGEMENT button on the remote control is pressed, this COLOR MANAGEMENT menu will directly open.
 - COLOR is set to RED by default.
5. Using the ◀ or ▶ button, select color RED→YELLOW→GREEN→CYAN→BLUE→MAGENTA→RED.
6. Using the ▼ button, select GAIN→SATURATION→HUE as items to be adjusted.
7. Select COLOR and items to be adjusted in advance and change numeric values using the ◀ or ▶ button while watching the screen.
 - When FULL/MONO is set to MONO COLOR, only the components of the selected color are displayed. After the menu is closed, it is set back to FULL COLOR automatically.
 - Once POSITION has been selected, you can change the display position of the COLOR MANAGEMENT menu.
 - When you select RESET and press the ENTER button, the setting value of the selected color will be reset to the default.

COLOR	◀	RED ▶
GAIN	◀	0 ▶
SATURATION	◀	0 ▶
HUE	◀	0 ▶
POSITION	◀	RIGHT UP ▶
FULL/MONO	◀	FULL COLOR ▶
RESET		OK 

To cancel the menu:

8. Press the MENU button.

Adjusting projected images (continued)

This projector automatically and properly projects video signals supplied from the computer. However, some video signals may not be projected, depending on the type of the computer. In such a case, press the AUTO POSITION button. (See page 24.) When the signal is still not projected properly, adjust the projected image using the SIGNAL menu.

How to adjust the image supplied from the computer using the menu:

Carry out the following procedures according to the symptoms.

Wide strips appear.Adjust TRACKING in the SIGNAL menu.

The projected image flickers.

The projected image is blurred.Adjust FINE SYNC. in the SIGNAL menu.

The projected image is displaced horizontally.Adjust HORIZ.POSITION in the SIGNAL menu. Every time the ◀ button is pressed, the image moves to the right. Every time the ▶ button is pressed, the image moves to the left.

The projected image is displaced vertically.Adjust VERT.POSITION in the SIGNAL menu. Every time the ◀ button is pressed, the image moves down. Every time the ▶ button is pressed, the image moves up.

The top part of the image flags.Change the setting of HOLD in the SIGNAL menu. Select ON , press the ENTER button, and adjust BEGIN or END to minimize the flagging.

A solid black or solid white appears in the image.Adjust CLAMP POSITION or CLAMP WIDTH in the SIGNAL - USER menu.

The motion doesn't run smoothly.Adjust VERT. SYNC in the SIGNAL - USER menu. Select AUTO for normal use.

Noise appears on the right or left half of the image.Adjust SHUTTER(LS) or SHUTTER(RS) in the SIGNAL - USER menu.

Noise appears on the top or bottom part of the image. ...Adjust SHUTTER(U) or SHUTTER(L) in the SIGNAL - USER menu.

1. Display the SIGNAL menu.
2. Press the ▲ or ▼ button to select an item to adjust.
3. Adjust the selected item by pressing the ◀ or ▶ button.

To cancel the menu:

4. Press the MENU button.
- Do not change the settings of the SIGNAL menu in normal use.

Simple method to adjust the image position

To adjust the horizontal position:

1. Align the left edge of the image with the left side of the screen by adjusting HORIZ.POSITION. Then, align the right edge of the image with the right side of the screen by adjusting TRACKING.
2. Repeat step 1 above to complete the adjustment of the horizontal position.

To adjust the vertical position:

3. Align the upper edge of the image with the upper side of the screen by adjusting VERT.POSITION.

LPF (Progressive filter)

You can select whether or not to enable the LPF.

Vertical or horizontal streak noise may appear on the projected image, depending on the type of the DVD player you use. In such a case, you can reduce such streak noise by enabling the LPF. However, projected images become softened slightly.

Advanced features



Password function

This projector is equipped with the password function that is designed for prevention of theft and wrong operation by children and restriction on operation by other than specified users. The password function has two modes as follows.

DISPLAY INPUT When the projector is turned on, the startup screen (or splash screen) will appear and stay on the screen until the password is entered. When the password is entered, the startup screen will switch to the regular operation screen.

MENU ACCESS..... All the buttons except for the POWER button on the projector are disabled. (The buttons on the remote control are enabled.) You can use this mode as a measure of prevention of wrong operation by children and restriction on operation by other than specified users.

To enable the password function:

1. Display the FEATURE menu.
2. Press the ▲ or ▼ button to select PASSWORD FUNCTION.
3. Press the ► button to change the mode among DISPLAY INPUT  and MENU ACCESS .
 - When the password has already been set, the mode won't be changed. In such cases, press the ENTER button to cancel the password function and try again.
4. Press the ENTER button.
 - The screen for setting the password function will appear.

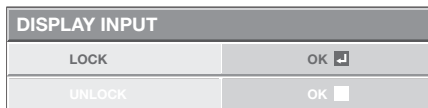

5. Press the ENTER button.
 - The screen for entering a password will appear.

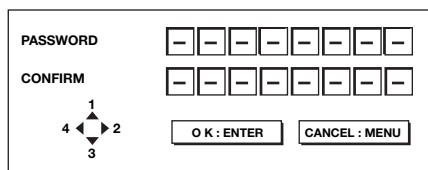

6. Enter a 4 - 8 digit password using the ▲, ►, ▼ or ◀ buttons on the remote control as shown below. (▲=1, ►=2, ▼=3, ◀=4)
7. Press the ENTER button.
 - To cancel the procedure, press the MENU button.
8. Enter the password again for confirmation using the same steps.
9. Press the ENTER button.
 - If the entered passwords don't match, an error message will appear.
 - To cancel the procedure, press the MENU button.

To cancel the password function:

1. Display the FEATURE menu.
2. Press the ▲ or ▼ button to select PASSWORD FUNCTION.
3. Press the ENTER button.
 - The screen for canceling the password function will appear.

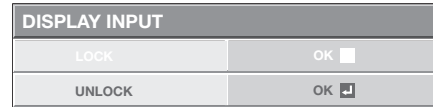

4. Press the ENTER button.
 - The screen for entering the password will appear.

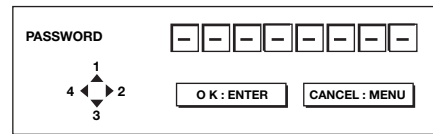

5. Enter a 4 - 8 digit password using the ▲, ►, ▼ or ◀ buttons on the remote control as shown below. (▲=1, ►=2, ▼=3, ◀=4)
6. Press the ENTER button.
 - If you enter a wrong password, an error message will appear.
 - To cancel the procedure, press the MENU button.

Important:

- Disable the password by pressing the MENU and ENTER buttons on the control panel at the same time about three seconds.

Kensington Lock

This projector has a Kensington Security Standard connector for use with Kensington MicroSaver Security System. Refer to the information that came with the Kensington System for instructions on how to use it to secure the projector. Please contact Kensington Technology Group below.

Kensington Technology Group
2855 Campus Drive
San Mateo, CA 94403, U.S.A.
Phone: +1- (650)572-2700
Fax: +1- (650)572-9675

Replacing the lamp

This projector is equipped with a lamp to project images. This lamp is a consumable. It may burn out or its brightness may decrease during use. In such cases, replace the lamp with a new one as soon as possible. Be sure to replace the lamp with a new lamp sold separately that is exclusive to this projector. Contact your dealer for purchase of the lamp.

Spare lamp VLT-HC7800LP

Warning:

- Be careful not to drop the lamp fixing screws inside of the projector. Don't put a metal piece or flammable object into the projector. Using the projector with any foreign object present inside may result in electric shock or fire. When you can't remove the foreign object from the inside, contact your dealer for removal.
- Do not touch the lamp with bare hands or give a shock to the lamp. Attach the lamp properly. Improper handling may cause explosion.
- Be sure to install the lamp securely. When the lamp isn't installed properly, it won't illuminate. Improper installation may also result in fire.
- Don't shake the removed lamp or don't lift it above your face. Your eyes may be injured by flying or falling glass fragments.
- Don't replace the lamp immediately after use because the lamp cover will be very hot. You may get burned. Turn off the power using the POWER button. After the lamp goes out, wait about two minutes until the intake and exhaust fans for cooling the lamp stop rotating. Then unplug the power cord, and wait at least one hour to allow the lamp to cool down enough to the touch.
- Keep small parts such as screws out of the reach of babies and children. If swallowed, those parts can cause suffocation. In case a baby or a child swallows them, see a doctor.

Interval of lamp replacement

The recommended interval of lamp replacement is about 5000 hours^{*1*2} of consecutive use. Such interval differs depending on the operating environment and may be shorter than 5000 hours^{*1*2}. Decrease in luminescence and/or color brightness indicates that the lamp needs to be replaced. When the lamp operation time exceeds 3750 hours^{*1}, the indicator will blink alternately between green and red (while the lamp is lit; when the lamp is not lit, the indicator will be lit red only) and the lamp replacement message will appear on the screen for one minute everytime the lamp is turned on. When the lamp has been used for about 4750 hours^{*1}, the replacement message (LAMP REPLACEMENT) will appear on the screen for one minute every 25 hours^{*1} thereafter. **When the lamp operation time exceeds 5000 hours^{*1*2}, the projector automatically shuts off and can't be used until the lamp is replaced and the lamp operation time is reset.**

*1: Duration when LAMP MODE of the INSTALLATION menu is set to LOW. When it is set to STANDARD, this duration will be shorted.

*2: When LAMP MODE is set to STANDARD, this duration will be shorted to 3000 hours.

Caution:

- Don't remove the lamp for any purpose other than replacement. Unnecessary removal of the lamp may result in a breakdown.
- This projector uses a high-pressure mercury lamp as the light source. The high-pressure mercury lamp may explode or fail to illuminate permanently because of an impact, scratch, or deterioration through use. The period of time until explosion or permanent failure to illuminate varies considerably from lamp to lamp, depending on operation conditions. Therefore, the lamp may explode soon after the start of use.
- The possibility of explosion of the lamp increases if you use it beyond its replacement period. When the instruction of lamp replacement appears, replace it with a new one immediately even if the lamp is still lighting normally.
- When the high-pressure mercury lamp explodes, glass fragments will scatter inside or outside the lamp box and the gas charged inside the lamp will diffuse inside or outside the projector. The gas inside the lamp contains mercury. Be careful not to breathe it or avoid it from entering your eye or mouth. If you should breathe it or if it should enter your eye or mouth, see a doctor immediately.
- In the event that the high-pressure mercury lamp exploded, glass fragments may have been scattered inside the projector. Ask your dealer to replace the lamp and to inspect the inside of the projector. When you clean or replace the lamp by yourself, be sure to hold the handle of the lamp. You may get injured by glass fragments.
- When removing the lamp from the ceiling-mounted projector, use the lamp replacement attachment packed with the projector or option lamp to prevent glass fragments from scattering.
- Be sure to use the lamp exclusive to this projector, VLT-HC7800LP. Use of other lamps may cause a failure of the projector.

Replacing the lamp (continued)

To replace the lamp:

A) When the projector is placed on the table

Make sure that the projector is securely held in place.

1. Remove the cover (a) of the screw fixing the lamp cover with a fingernail. If it is difficult to remove it with a fingernail, use a finetipped tool such as flathead screwdriver.

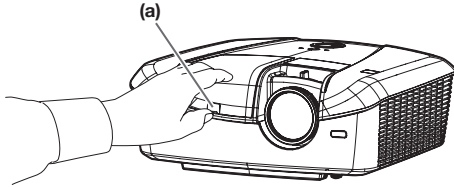

2. Remove the screw (b) and slide the lamp cover (c) for removal.

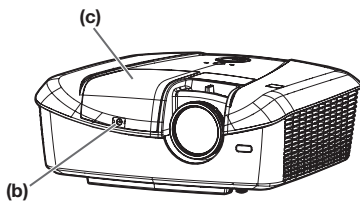

3. Loosen the two screws (d) of the lamp unit, and then pull out the lamp unit (f) by the handle (e).

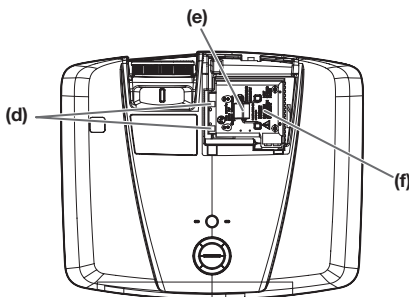

Caution:

- When replacing the lamp, do not loosen the screws other than two screws (d). It may cause the failure of projector.
 - Pull the lamp unit out of the projector slowly. If it is pulled out quickly, the lamp may break, scattering glass fragments.
 - Do not spill liquid on the removed lamp unit or do not place it near any flammable object or where children can reach to prevent injuries or fire.
4. Insert the new lamp unit, and secure it with two screws firmly.
 5. Secure the lamp cover with screw (b) back again, and mount the cover (a).

Caution:

- Make sure that the lamp cover is secured firmly. Otherwise, the POWER indicator flashes red and green, disallowing the projector to be powered on.

B) When the projector is mounted to the ceiling

When removing the lamp unit from the projector mounted to the ceiling, never fail to use the lamp replacement attachment to protect yourself from glass fragments and so on.

- Contact your dealer when replacing the lamp unit with the projector mounted to the ceiling.
1. Remove the lamp cover referring to the procedure 1 and 2 of "A) When the projector is placed on the table".

Caution:

- When opening the lamp cover to replace the lamp of the ceiling-mounted projector, pay careful attention because glass fragments may exist inside the lamp cover.
2. Loosen the two screws (d) of the lamp unit.

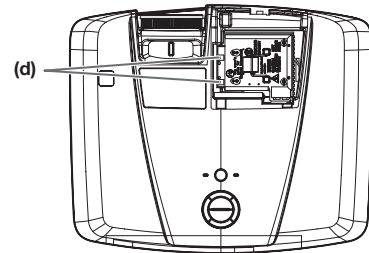

Caution:

- When replacing the lamp, do not loosen the screws other than two screws (d). It may cause the failure of projector.
3. Fold the three taping portions (g) of the lamp replacement attachment along the folding line as shown in the figure.

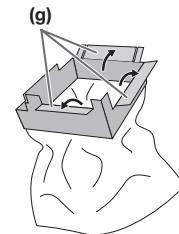

Replacing the lamp (continued)

4. Insert two lugs of the lamp replacement attachment into the slits (h) in the projector and fix the three taping portions (g) with the tape included in the lamp replacement attachment.

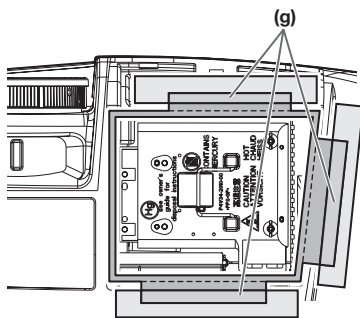
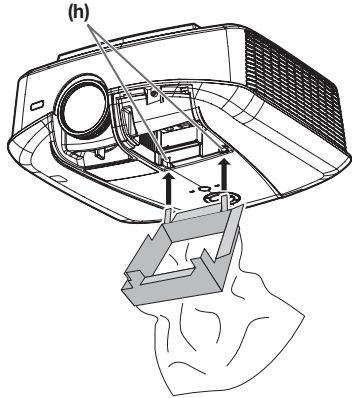

5. Pull out the lamp unit (f) in the bag by the handle (e).

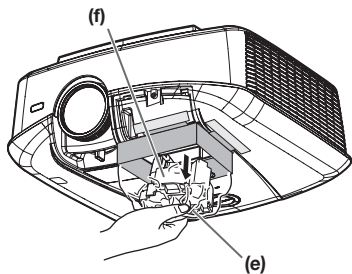

6. Remove the tape fixing the lamp replacement attachment, and remove the lamp replacement attachment with the lamp unit remaining in the bag.

Caution:

- Pull the lamp unit out of the projector slowly. If it is pulled out quickly, the lamp may break, scattering glass fragments.
- Do not spill liquid on the removed lamp unit or do not place it near any flammable object or where children can reach to prevent injuries or fire.

7. Insert the new lamp unit, and secure it with two screws firmly.
8. Secure the lamp cover with screw (b) back again, and mount the cover (a).

Caution:

- Make sure that the lamp cover is secured firmly. Otherwise, the POWER indicator flashes red and green, disallowing the projector to be powered on.

Reset of the lamp operation time

Plug in the power cord, and reset the lamp operation time by keep pressing the ◀, ▶, and POWER buttons on the control panel at the same time.

Important:

- Unless these three buttons are pressed at the same time, the lamp operation time isn't reset.
- Make sure that the STATUS indicator is lit twice and the lamp operation time is reset successfully.
- The projector doesn't turn on if the lamp cover isn't attached securely.
- Be sure to reset the lamp operation time whenever you replace the lamp.
- Do not reset the lamp operation time unless you replace the lamp.
- The lamp is fragile. If it is broken, be careful not to cut yourself with glass fragments.

Caution:

- This projector uses a lamp that contains mercury. Disposal of the lamp or the projector with the lamp may be regulated due to environmental considerations. For disposal or recycling information, please contact your local authorities or the Electronic Industries Alliance: www.eiae.org. (For the U.S. only.)

Maintenance

Warning:

- Do not use flammable solvents (benzene, thinner, etc.) and flammable aerosols when cleaning the projector body and lens. Flammable substances may ignite causing fire or breakdown while the lamp is illuminating.

Caution:

- Be sure to turn off the lamp and unplug the power cord from the wall outlet before you perform any maintenance on the projector.
- Ask your dealer for annual cleaning of the inside of the projector. If you continue to use the projector with dust inside, it may result in fire or malfunction.

Cleaning of the projector and the vents

Use a soft cloth to clean the projector and the vents. When the vents become dirty, wipe them with a soft cloth dampened with diluted mild detergent, and then wipe them with a dry cloth.

To protect the surface of the projector from fading or deteriorating:

- Do not spray insecticide on or inside the projector.
- Do not use benzine or thinner to clean it.
- Do not let rubber or plastic materials contact with projector.































Cleaning of the lens

Use a standard lens-cleaning brush or a piece of lens tissue dampened with lens cleaning fluid. The lens surface is fragile. Use only recommended, nonabrasive lens-cleaning materials. Do not touch the lens with your fingers.

Troubleshooting

Before asking for repair of the projector, check the following. If the symptom persists, stop using the projector, be sure to unplug the power plug, and then contact your dealer.

No image appears on the screen.

Problem	Solution																				
Power can not be turned on.	<ul style="list-style-type: none"> Check whether the indicators are on or off and how they are lightning. 																				
	<table border="1"> <thead> <tr> <th>POWER</th> <th>STATUS</th> <th>Solution</th> </tr> </thead> <tbody> <tr> <td>  Off </td> <td>  Off </td> <td> <ul style="list-style-type: none"> Connect the power cord to the projector. Plug the power cord into a wall outlet. </td> </tr> <tr> <td rowspan="4">  Steady red </td> <td>  Off </td> <td> <ul style="list-style-type: none"> If any objects are blocking the intake or exhaust vents, remove them and carry out the following. <ol style="list-style-type: none"> Unplug the power cord from the wall outlet. Make sure that the projector has cooled off. Plug the power cord into the wall outlet. Press the POWER button. </td> </tr> <tr> <td>  Blinking orange </td> <td> <ul style="list-style-type: none"> If any objects are blocking the intake or exhaust vents, remove them. Don't expose the exhaust vents to hot air emitted from a heating appliance. </td> </tr> <tr> <td>  Blinking green </td> <td> <ul style="list-style-type: none"> After the STATUS indicator stops blinking, press the POWER button. <ul style="list-style-type: none"> If you unplug the power cord while the fan is rotating, the lamp may not turn on about one minute when you plug the power cord next time. The lamp can't turn on again for one minute after it goes out. Press the POWER button several times. </td> </tr> <tr> <td>  Steady red </td> <td> <ul style="list-style-type: none"> Replace the lamp. (The lamp is at the end of its life.) </td> </tr> <tr> <td rowspan="2">  Blinking red/green </td> <td>  Off </td> <td> <ul style="list-style-type: none"> Attach the lamp cover. </td> </tr> <tr> <td>  Steady or Blinking </td> <td> <ul style="list-style-type: none"> Unplug the power cord from the wall outlet and contact your dealer . </td> </tr> </tbody> </table>	POWER	STATUS	Solution	 Off	 Off	<ul style="list-style-type: none"> Connect the power cord to the projector. Plug the power cord into a wall outlet. 	 Steady red	 Off	<ul style="list-style-type: none"> If any objects are blocking the intake or exhaust vents, remove them and carry out the following. <ol style="list-style-type: none"> Unplug the power cord from the wall outlet. Make sure that the projector has cooled off. Plug the power cord into the wall outlet. Press the POWER button. 	 Blinking orange	<ul style="list-style-type: none"> If any objects are blocking the intake or exhaust vents, remove them. Don't expose the exhaust vents to hot air emitted from a heating appliance. 	 Blinking green	<ul style="list-style-type: none"> After the STATUS indicator stops blinking, press the POWER button. <ul style="list-style-type: none"> If you unplug the power cord while the fan is rotating, the lamp may not turn on about one minute when you plug the power cord next time. The lamp can't turn on again for one minute after it goes out. Press the POWER button several times. 	 Steady red	<ul style="list-style-type: none"> Replace the lamp. (The lamp is at the end of its life.) 	 Blinking red/green	 Off	<ul style="list-style-type: none"> Attach the lamp cover. 	 Steady or Blinking	<ul style="list-style-type: none"> Unplug the power cord from the wall outlet and contact your dealer .
	POWER	STATUS	Solution																		
	 Off	 Off	<ul style="list-style-type: none"> Connect the power cord to the projector. Plug the power cord into a wall outlet. 																		
	 Steady red	 Off	<ul style="list-style-type: none"> If any objects are blocking the intake or exhaust vents, remove them and carry out the following. <ol style="list-style-type: none"> Unplug the power cord from the wall outlet. Make sure that the projector has cooled off. Plug the power cord into the wall outlet. Press the POWER button. 																		
		 Blinking orange	<ul style="list-style-type: none"> If any objects are blocking the intake or exhaust vents, remove them. Don't expose the exhaust vents to hot air emitted from a heating appliance. 																		
 Blinking green		<ul style="list-style-type: none"> After the STATUS indicator stops blinking, press the POWER button. <ul style="list-style-type: none"> If you unplug the power cord while the fan is rotating, the lamp may not turn on about one minute when you plug the power cord next time. The lamp can't turn on again for one minute after it goes out. Press the POWER button several times. 																			
 Steady red		<ul style="list-style-type: none"> Replace the lamp. (The lamp is at the end of its life.) 																			
 Blinking red/green	 Off	<ul style="list-style-type: none"> Attach the lamp cover. 																			
	 Steady or Blinking	<ul style="list-style-type: none"> Unplug the power cord from the wall outlet and contact your dealer . 																			
No image appears on the screen.	<ul style="list-style-type: none"> Check that the lens cap is removed. It may take about one minute for the lamp to light up. The lamp fails to light up on rare occasions. In such a case, wait for a few minutes and then try again. If the projector was turned off before the lamp was cooled down sufficiently last time, the fan may start rotating and the POWER button may not work after the power cord is plugged. After the fan stops rotating, press the POWER button to turn back on the POWER indicator. Check that the intake vent is clean. Check that the lamp cover is closed. (See page 44.) Check that the cables connected to the external devices are not broken. When an extension cable is being used, replace it with the supplied cable for check. When images are displayed correctly, add an RGB signal amplifier to the extension cable. Check the operation manual of the video device for its connection. 																				
Power turns off.	<ul style="list-style-type: none"> This problem may occur when the intake vent and/or exhaust vents are blocked. (In such a case, the STATUS indicator brinks orange.) <ul style="list-style-type: none"> → Remove the objects blocking the intake vent and/or exhaust vents and then carry out the following procedure. <ol style="list-style-type: none"> Wait for the intake fan and/or exhaust fan to stop. (Wait until the STATUS indicator goes out.) Unplug the power cord from the wall outlet. Wait at least 10 minutes. Plug the power cord into the wall outlet. Press the POWER button. When the STATUS indicator is steady red, it is indicating that the lamp should be replaced. Replace the lamp in this case. Check that AUTO POWER OFF has been set to OFF. If the lamp has deteriorated, it may go out after a while it illuminates. 																				

Troubleshooting (continued)

No image appears on the screen. (continued)

Problem	Solution
The screen for entering the password appears.	<ul style="list-style-type: none"> PASSWORD FUNCTION in the FEATURE menu has been set to DISPLAY INPUT to enable the password lock. → Enter the password or contact the person in charge of management of the projector. (See page 41.)
“NO SIGNAL” is displayed.	<ul style="list-style-type: none"> Turn on the power of the connected device, or check whether there is something wrong with the connected device. Check whether the external device output signals. (Check this especially when the external device is a notebook computer.) Check that the cable connected to the external device isn't defective. Check that the projector is connected to the external device using the correct terminals. Check that the connected device is correctly selected as the input source. When an extension cord is being used, replace it with the supplied cable and check whether images are projected correctly. If images are projected correctly, use an RGB signal amplifier along with the extension cord.
Images may be jagged when connecting the projector using the HDMI cable. “NO SIGNAL” is displayed when connecting the projector using the HDMI cable.	<ul style="list-style-type: none"> Make sure if the cable is firmly plugged into the connecting terminal. To accept and display 1080p signals on the screen, make sure to use a high-speed HDMI cable that can transmit 1080p signals. When a distributor or an AV amplifier is connected using an HDMI cable, check that the distributor or the AV amplifier complies with HDMI1.3 or higher (Deep Color). When displaying 3D images, check that the distributor or the AV amplifier complies with HDMI1.4 or higher (3D display).

Images are not displayed correctly.

Problem	Solution
Projected images are shaking. Projected images are displaced.	<ul style="list-style-type: none"> Check that the cable connected to the external device isn't intermittent. Connect the cable's plug with the external device's connector firmly. Press the AUTO POSITION button. Some computers output out-of-spec signals on rare occasion. Adjust the SIGNAL menu. (See page 40.)
Projected images are distorted.	<ul style="list-style-type: none"> Adjust the projector and the screen so that they are perpendicular to each other. (See page 10.)
Projected images are dark.	<ul style="list-style-type: none"> Adjust BRIGHTNESS and CONTRAST in the IMAGE menu. (See page 36.) Replace the lamp. (See page 42.)
Projected images are blurred.	<ul style="list-style-type: none"> Adjust the focus. (See pages 18 and 23.) Clean the lens. Press the ◀ or ▶ button on the remote control to eliminate flicker. Adjust TRACKING and FINE SYNC. in the SIGNAL menu. (See page 40.) Set OVER SCAN in the SIGNAL menu to 100%. (See page 34.) Set KEYSTONE in the INSTALLATION menu to 0. (See page 32.) Adjust BRIGHTNESS and CONTRAST in the IMAGE menu. (See page 36.) Adjust the projector and the screen so that they are perpendicular to each other. (See page 10.)
White dots are seen on projected images. Black dots are seen on projected images.	<ul style="list-style-type: none"> This symptom is normal for a DLP™ projector and is not a malfunction. (A very small number of pixels may stay lit or out, but such symptom is not a malfunction. Pixels of 99.99% or more are effective.)
Rainbow effect is seen on projected images.	<ul style="list-style-type: none"> This is due to color breaking noise that occurs in a DLP™ system and is not a malfunction.

Troubleshooting (continued)

Images are not displayed correctly. (continued)

Problem	Solution
Fine streaks are seen on projected images.	<ul style="list-style-type: none"> This is due to interference with the screen surface and is not a malfunction. Replace the screen or displace the focus a little. Vertical or horizontal streak noise may appear on the projected image, depending on the type of the DVD player or game console you use. In such a case, you can reduce such streak noise by enabling the LPF. (See page 40.)
Projected images become wavy.	<ul style="list-style-type: none"> Connect the plugs of the cables to external devices securely. Keep the projector away from devices that emit interfering radio waves.
Hue is not appropriate.	<ul style="list-style-type: none"> Check that the cables connected to the external devices are not broken.
Tint in projected images is incorrect.	<ul style="list-style-type: none"> If the setting of COMPUTER INPUT in the SIGNAL menu is inconsistent with the RGB/YCbCr output setting of the external device even when the input source is other than COMPUTER (for example, when the input source is HDMI), the entire image appears reddish or greenish. → Check that COMPUTER INPUT in the SIGNAL menu is correctly set. (See page 34.) Check that the cable connected to the external device isn't broken.
Different color tint.	<ul style="list-style-type: none"> When comparing images projected by two projectors, tints in the displayed images may be different because of variation between their optical components. This is not a malfunction. When comparing the image projected by this projector with those displayed on the television or PC monitor, tints in the displayed images may be different because of difference in the range of color reproducibility. This is not a malfunction.
Color unevenness appears in images.	<ul style="list-style-type: none"> Since the projector utilizes a high-definition DLP™ chip, color variations (at the center of the screen and along the rims of the active area) that are caused by diffraction of light may occur. This is not a malfunction.
Only the motion areas in the images supplied from the computer aren't displayed.	<ul style="list-style-type: none"> This is caused by the computer being used. Contact the manufacturer of your computer.
Projected images are obscured.	<ul style="list-style-type: none"> Match the output resolution of your computer with the resolution of the projector. For the method to change the output resolution of the computer, contact the manufacturer of your computer. (See page 53.)
Image remains freezing.	<ul style="list-style-type: none"> When image from VCR is projected, it may remain freezing during speed search. This is not a malfunction.
Noise appears around the image.	<ul style="list-style-type: none"> In some images such as DVD, noise may appear around the recorded image. In this case, decrease the setting value of OVER SCAN of the SIGNAL menu or adjust the setting value of SHUTTER of the SIGNAL-USER menu. (See page 34.)
Projected images are flickering.	<ul style="list-style-type: none"> After the POWER button or ON button on the remote has been pressed, or the Lamp mode setting has changed, images may be flickering until the lamp lights stably. This is an expected behavior. When selecting the input signal and Auto Position, the projected image may be flickering temporarily. This is not a product malfunction.

Others

Problem	Solution
No sound comes from the speakers connected to the AV amplifier. (No sound comes from the home theater system speakers.)	<ul style="list-style-type: none"> The projector is not equipped with the speakers. The AV amplifier reads the information that projector is not equipped with the speakers and then passes this information along to the DVD player. Because of this, either the DVD player may be temporarily stopping audio output, or the AV amplifier may be temporarily stopping audio output from the DVD player. → Change the setting on the AV amplifier or the DVD player.
The exhaust vents emit warm air.	<ul style="list-style-type: none"> This air comes out after cooling the inside of the projector. You may feel hot, but this is not a malfunction.

Troubleshooting (continued)

Others (continued)

Problem	Solution
The menu can't be used.	<ul style="list-style-type: none"> The microcomputers inside the projector may be wrongly operating because of noise. <ul style="list-style-type: none"> → Press the POWER button to turn off the lamp and wait about 2 minutes. Then unplug the power cord from the outlet, wait at least 10 minutes, and plug the power cord back into the outlet. When the POWER button doesn't function, unplug the power cord from the outlet, wait at least 10 minutes, and then plug the power cord back into the outlet. You cannot select grayed-out items. (See page 29.)
"TEMPERATURE!!" is displayed.	<ul style="list-style-type: none"> This indication appears when the ambient temperature rises high. When the ambient temperature stays high, the lamp goes out. <ul style="list-style-type: none"> → Eliminate any causes of the rise in the ambient temperature. This indication appears when the intake or exhaust vents are blocked. When they are kept blocked, the lamp goes out. <ul style="list-style-type: none"> → Remove the objects blocking the intake or exhaust vents.
The ☉ mark appears.	<ul style="list-style-type: none"> This mark appears when ineffective operation is carried out. This isn't a product malfunction.
The remote control doesn't function easily or at all.	<ul style="list-style-type: none"> Check that the batteries are loaded in the remote control or the batteries are not weak. (See page 6.) Check that the remote control sensor isn't exposed to direct sunlight or fluorescent light. (See page 9.) Use the remote control within its operation range. (See page 9.) Use the remote control at least 10 cm away from the projector.
The remote control of other device such as DVD recorder doesn't function.	<ul style="list-style-type: none"> When you are viewing a 3D image, stop the signal being output from the 3D emitter temporarily by pressing the 3D SYNC PAUSE button on the remote control. (See page 26.)
The buttons on the control panel (except for the POWER button) don't function.	<ul style="list-style-type: none"> PASSWORD FUNCTION in the FEATURE menu has been set to MENU ACCESS to enable the password lock. <ul style="list-style-type: none"> → Cancel the password lock or contact the person in charge of management of the projector. (See page 41.)
Mechanical operating noise (clicking sound) is heard.	<ul style="list-style-type: none"> The iris produces sound while operating. This is not a malfunction.
Mechanical operation noise is heard after the power-off process.	<ul style="list-style-type: none"> Mechanical operation noise is heard after the power-off process, but this is not a malfunction.
Abnormal sound is heard.	<ul style="list-style-type: none"> Because the color wheel spins at a high speed, metallic sounds may be heard in rare occasions. Such symptom is not a malfunction.
Images are not 3D. *The 3D glasses and 3D emitter are sold separately. They are not supplied with this product.	<ul style="list-style-type: none"> Is the 3D emitter connected to the projector? Is there any block in the communication area between the 3D emitter and the 3D glasses? Or, is there a sticker or other such item on the infra-red reception section on the 3D glasses? <ul style="list-style-type: none"> → The 3D glasses operate by receiving signals from the 3D emitter. Check that there is not any block in the communication area between the 3D emitter and the 3D glasses. Is the distance between the 3D emitter and 3D glasses too far, or too close? <ul style="list-style-type: none"> → Adjust the location of the 3D emitter. Are the direction of the 3D emitter and that of the infra-red reception section on the 3D glasses misaligned? <ul style="list-style-type: none"> → Adjust the direction and location of the 3D emitter. Is the 3D glasses turned off? <ul style="list-style-type: none"> → Turn on the power of the 3D glasses.

Troubleshooting (continued)

Others (continued)

Problem	Solution
<p>Images are not 3D. *The 3D glasses and 3D emitter are sold separately. They are not supplied with this product.</p>	<ul style="list-style-type: none"> • It may need to switch the 3D mode (such as 3D setting system) of the recorder/player when projecting 3D images with the 3D image supporting recorder/player. (For detail, see the User Manual of the recorder/player.) • Is the 3D mode of the projector set properly for the image? → Set the 3D MODE of the projector (FRAME PACKING, SIDE BY SIDE, TOP AND BOTTOM) properly for the image. • The 3D glasses may become out of sync due to fluorescent light. Turn off the fluorescent light. • Is there any other 3D emitter or 3D image supporting television close to the 3D glasses? → The 3D glasses work by receiving signals from the 3D emitter. Check that there is no interference of the signals from other infra-red emission section. • Is the signal output from the 3D emitter being stopped temporarily because you pressed the 3D SYNC PAUSE button on the remote control? (See page 26.)
<p>The power of the 3D glasses turns off automatically. *The 3D glasses and 3D emitter are sold separately. They are not supplied with this product.</p>	<ul style="list-style-type: none"> • Is there any block in the communication area between the 3D emitter and the 3D glasses? Or, is there a sticker or other such item on the infra-red reception section on the 3D glasses? → When the signal from the 3D emitter is interrupted, the power of the 3D glasses automatically turns off 5 minutes after the interruption. Check that there is not any block in the communication area between the 3D emitter and the 3D glasses.
<p>There is something wrong with the 3D images. *The 3D glasses and 3D emitter are sold separately. They are not supplied with this product.</p>	<ul style="list-style-type: none"> • Depending on the 3D image status, you may feel something wrong with the 3D images. → Switch the 3D SYNC. setting of the projector to check whether or not the uncomfortable feeling is disappeared. → When the signal from the 3D emitter is interrupted, the power of the 3D glasses automatically turns off 5 minutes after the interruption. Check that there is not any block in the communication area between the 3D emitter and the 3D glasses. • The 3D glasses may become out of sync due to fluorescent light. Turn off the fluorescent light. • Is there any other 3D emitter or 3D image supporting television close to the 3D glasses? → The 3D glasses work by receiving signals from the 3D emitter. Check that there is no interference of the signals from other infra-red emission section.
<p>The indicator on the 3D glasses does not light up even if the power is turned on. *The 3D glasses and 3D emitter are sold separately. They are not supplied with this product.</p>	<ul style="list-style-type: none"> • Does the battery of the 3D glasses die? → Replace the battery with a new one if the indicator does not light up even when the power is turned on.
<p>Blue shades appear in the 3D image.</p>	<ul style="list-style-type: none"> • Adjust 3D F.R.C. LEVEL of the 3D menu in the IMAGE menu. (See page 25.) • Adjust FINE 3D SYNC. of the 3D menu in the IMAGE menu. (See page 25.)

If the following problem occurs after the lamp is replaced, check the following first.

Problem	Solution
<p>The projector does not turn on.</p>	<ul style="list-style-type: none"> • Fit the lamp cover securely. (See pages 42 - 44.) • Reset the lamp operating time. (See page 44.)
<p>The STATUS indicator blinks.</p>	<ul style="list-style-type: none"> • Reset the lamp operating time. (See page 44.)

Indicators

This projector has two indicators, each of which shows the operation condition of the projector. The following offer solutions to possible problems. If these problem persist, turn the projector off and consult your dealer.

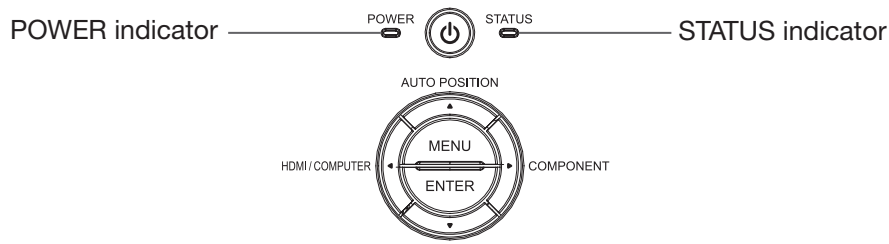

Normal condition

POWER	STATUS	CONDITION	NOTE
Steady red	Off	Stand-by	
	Blinking green	Lamp stand-by for power-off	The power cannot be turned on by pressing the POWER button.
Steady green	Blinking green	Lamp stand-by for power-on	The power cannot be turned off by pressing the POWER button.
	Steady green	The power is on. (Normal condition)	

Abnormal condition

POWER	STATUS	CONDITION	POSSIBLE SOLUTION
Steady green or Steady red	Blinking orange	Abnormal temperature <ul style="list-style-type: none"> The vents are clogged with dust or dirt. The room temperature is high. 	<ul style="list-style-type: none"> Clean the vents. Relocate the projector to a cooler place.
Steady red	Blinking green	The protection circuit is working or the lamp is in an abnormal condition.	<ul style="list-style-type: none"> Wait until the STATUS indicator goes out, then press the POWER button. If the above solution is not effective, replace the lamp.
Steady green	Blinking green/red	The lamp operation time exceeds the time elapsed until the shut-off time notice while the power is on. (See page 42.)	Replace the lamp. Change with a new lamp if this problem recurs.
Steady red	Blinking red	The lamp operation time exceeds the time elapsed until the shut-off time notice while the power is off. (See page 42.)	
Blinking green/red	Steady red	The lamp operation time exceeds the time elapsed until the shut-off time. (See page 42.)	Close the cover correctly.
	Off	The lamp cover isn't closed.	
Blinking green/red	Steady or Blinking	Abnormal.	Contact your dealer.

Specifications

The specifications and outside appearance of the projector are subject to change without prior notice.

Type		DLP™ projector		
Model		HC7900DW		
Display technology		0.65-inch single chip DMD (aspect ratio 16:9) Pixel: 1920 x 1080 = 2073600 pixels		
Projection lens		F 2.4 - 2.8 f= 20.6 - 30.1 mm		
Light-source lamp		240 W		
Image size (projection distance)		50" min. to 300" max. (projection distance 1.5 to 9.3 m (max. Zoom))		
Maximum resolution	Computer signal	Maximum resolution: 1600 x 1200 dots Panel resolution: 1920 x 1080 dots		
	Component signal	480i, 480p, 576i, 576p, 720p, 1080i, 1080p Panel resolution: 1920 x 1080 dots		
Computer input		[Signal type] Analog RGB	[Terminal type] Mini D-SUB 15-pin	[Line] 1
HDMI input		[Signal type] HDMI	[Terminal type] HDMI 19-pin	[Line] 2
Component video input		[Signal type] Component video input	[Terminal type] RCA x3 (Y _C B _C R/YP _B Pr)	[Line] 1
Control terminal/ others	SERIAL	RS-232C (D-SUB 9-pin)		
	TRIGGER 1, 2	DC 12 V, max. 200 mA (stereo mini jack)		
Operating temperatures		+41°F (+5°C) to +95°F (+35°C)		
Rated voltage		AC100 - 240 V, 50/60 Hz		
Power consumption		3.8 A		
Dimensions		396 mm (W) x 142 mm (H) x 328 mm (D) * Not including protrusion.		
Weight		5.7 kg		
Others	Component video input	Y _C B _C R: V _{p-p} =1.0 V 75Ω (Y) (negative sync) V _{p-p} =0.7 V 75 Ω (C _B , C _R)		
	Analog input	RGB: V _{p-p} =0.7 V 75 Ω (negative sync) Y _C B _C R: V _{p-p} =1.0 V (Y) (negative sync) V _{p-p} =0.7 V (C _B , C _R) HD/CS: TTL-level (negative or positive polarity) VD: TTL-level (negative or positive polarity)		
	Digital input (HDMI)	HDMI interface (TMDS single link)		

Dimension drawings (unit: mm)

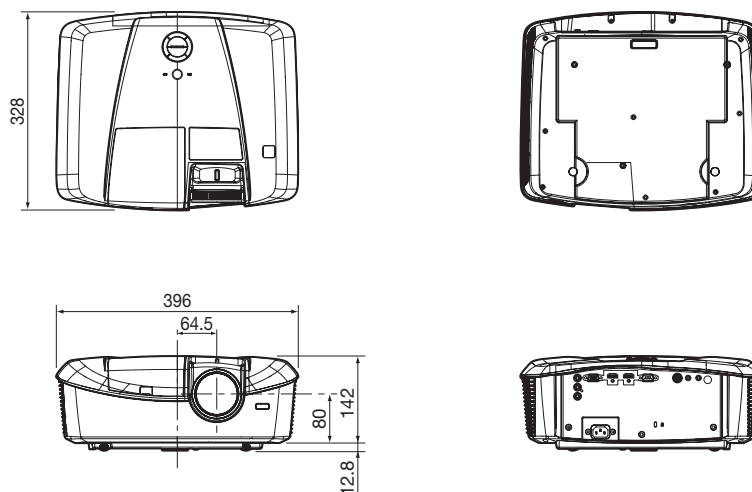

Specifications (continued)

Supported input signals

Signal mode	Resolution (H x V)	Horizontal frequency (kHz)	Vertical frequency (Hz)	Normal mode (H x V) ^{*1}	
TV60, 480i (525i)	–	15.73	59.94	1920 x 1080	
TV50, 576i (625i)	–	15.63	50.00	1920 x 1080	
1080i 60 (1125i 60)	–	33.75	60.00	1920 x 1080	
1080i 50 (1125i 50)	–	28.13	50.00	1920 x 1080	
480p (525p)	–	31.47	59.94	1920 x 1080	
576p (625p)	–	31.25	50.00	1920 x 1080	
720p 60 (750p 60)	–	45.00	60.00	1920 x 1080	
720p 50 (750p 50)	–	37.50	50.00	1920 x 1080	
1080p 60 (1125p 60)	–	67.50	60.00	1920 x 1080	
1080p 50 (1125p 50)	–	56.25	50.00	1920 x 1080	
1080p 24 (1125p 24)	–	27.00	24.00	1920 x 1080	
PC98	640 x 400	24.82	56.42	1728 x 1080	*2
CGA70	640 x 400	31.47	70.09	1728 x 1080	*2
VGA60	640 x 480	31.47	59.94	1440 x 1080	
VGA72	640 x 480	37.86	72.81	1440 x 1080	*2
VGA75	640 x 480	37.50	75.00	1440 x 1080	*2
VGA85	640 x 480	43.27	85.01	1440 x 1080	*2
SVGA56	800 x 600	35.16	56.25	1440 x 1080	*2
SVGA60	800 x 600	37.88	60.32	1440 x 1080	
SVGA72	800 x 600	48.08	72.19	1440 x 1080	*2
SVGA75	800 x 600	46.88	75.00	1440 x 1080	*2
SVGA85	800 x 600	53.67	85.06	1440 x 1080	*2
XGA60	1024 x 768	48.36	60.00	1440 x 1080	
XGA70	1024 x 768	56.48	70.07	1440 x 1080	*2
XGA75	1024 x 768	60.02	75.03	1440 x 1080	*2
XGA85	1024 x 768	68.68	85.00	1440 x 1080	*2
MAC13	640 x 480	35.00	66.67	1440 x 1080	*2
MAC16	832 x 624	49.72	74.55	1440 x 1080	*2
MAC19	1024 x 768	60.24	75.02	1440 x 1080	*2
HP75	1024 x 768	62.94	74.92	1440 x 1080	*2
SXGA60	1280 x 1024	63.98	60.02	1350 x 1080	
UXGA60	1600 x 1200	75.00	60.00	1440 x 1080	*3

*1: When ASPECT in the FEATURE menu is set to AUTO.

*2: Not supported by the HDMI 1 and 2 terminals.

*3: Supported by the HDMI 1 and 2 terminals only.

3D supported signals

Signal mode	Resolution (H x V)	Horizontal frequency (kHz)	Vertical frequency (Hz)	Normal mode (H x V) ^{*1}
FRAME PACKING ^{*2}	720p50	1280 x 720	75.00	1920 x 1080
	720p60	1280 x 720	90.00	1920 x 1080
	1080p24	1920 x 1080	54.00	1920 x 1080
SIDE BY SIDE	1080p24	1920 x 1080	27.00	1920 x 1080
	1080p50	1920 x 1080	56.25	1920 x 1080
	1080p60	1920 x 1080	67.50	1920 x 1080
	1080i50	1920 x 1080	28.13	1920 x 1080
	1080i60	1920 x 1080	33.75	1920 x 1080
	720p50	1280 x 720	37.50	1920 x 1080
	720p60	1280 x 720	45.00	1920 x 1080
TOP AND BOTTOM	720p50	1280 x 720	37.50	1920 x 1080
	720p60	1280 x 720	45.00	1920 x 1080
	1080p24	1920 x 1080	27.00	1920 x 1080
	1080p50	1920 x 1080	56.25	1920 x 1080
	1080p60	1920 x 1080	67.50	1920 x 1080

*1: When ASPECT in the FEATURE menu is set to AUTO.

*2: Supported by the HDMI 1 and 2 terminals only.

Important:

- Some computers aren't compatible with the projector.
- The projector's maximum resolution is 1920 x 1080 pixels. It may not display images of higher resolutions than 1920 x 1080 correctly.
- If the resolution and frequency of your computer aren't shown on the table, find the compatible resolution and frequency by changing the resolution of your computer.
- This projector doesn't support 480p signals from video devices having 4 lines (R, G, B, CS*) or having 5 lines (R, G, B, H, V).

*: Composite Sync

Specifications (continued)

Connectors

SERIAL (D-SUB 9-pin)

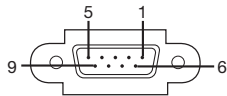

Pin No.	Name	I/O
1	–	–
2	TXD	IN
3	RXD	OUT
4	–	–
5	GND	–
6	–	–
7	–	–
8	–	–
9	–	–

COMPUTER/COMPONENT VIDEO IN (Mini D-SUB 15-pin)

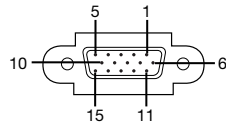

Pin No.	Spec.
1	R(RED)/Pr/Cr
2	G(GREEN)/Y
3	B(BLUE)/Pb/Cb
4	GND
5	GND
6	GND
7	GND
8	GND
9	DDC 5V
10	GND
11	GND
12	DDC Data
13	HD/CS
14	VD
15	DDC Clock

HDMI 1, HDMI 2 (HDMI 19-pin)

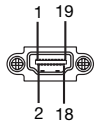

PIN No.	Spec.	PIN No.	Spec.
1	TMDS Data2+	11	TMDS Clock Shield
2	TMDS Data2 Shield	12	TMDS Clock-
3	TMDS Data2-	13	CEC
4	TMDS Data1+	14	–
5	TMDS Data1 Shield	15	SCL
6	TMDS Data1-	16	SDA
7	TMDS Data0+	17	DDC Ground
8	TMDS Data0 Shield	18	+5 V Power
9	TMDS Data0-	19	Hot Plug Detect
10	TMDS Clock+		

Separately sold items

Spare lamp VLT-HC7800LP
3D emitter EY-3D-EMT2H

 **MITSUBISHI ELECTRIC CORPORATION**
1 Zusho Baba, Nagaokakyo-City, Kyoto Japan