

DLPT<sup>™</sup> PROJECTOR

MODEL

**NW30U**

User Manual



*NW30U*

This User Manual is important to you.  
Please read it before using your projector.



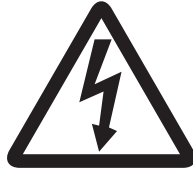

## CAUTION

RISK OF ELECTRIC SHOCK  
DO NOT OPEN



**CAUTION:** TO REDUCE THE RISK OF ELECTRIC SHOCK, DO NOT REMOVE COVER (OR BACK)  
NO USER-SERVICEABLE PARTS INSIDE  
REFER SERVICING TO QUALIFIED SERVICE PERSONNEL.

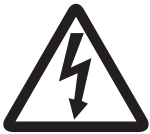

The lightning flash with arrowhead symbol within an equilateral triangle is intended to alert the user to the presence of uninsulated “dangerous voltage” within the product’s enclosure that may be of sufficient magnitude to constitute a risk of electric shock.



The exclamation point within an equilateral triangle is intended to alert the user to the presence of important operating and maintenance (servicing) instructions in the literature accompanying the appliance.

### **WARNING:**

TO PREVENT FIRE OR SHOCK HAZARD, DO NOT EXPOSE THIS APPLIANCE TO RAIN OR MOISTURE.

### **CAUTION:**

TO PREVENT ELECTRIC SHOCK, DO NOT USE THIS (POLARIZED) PLUG WITH AN EXTENSION CORD, RECEPTACLE OR OTHER OUTLET UNLESS THE BLADES CAN BE FULLY INSERTED TO PREVENT BLADE EXPOSURE.

### **NOTE:**

SINCE THIS PROJECTOR IS PLUGGABLE EQUIPMENT, THE SOCKET-OUTLET SHALL BE INSTALLED NEAR THE EQUIPMENT AND SHALL BE EASILY ACCESSIBLE.

### **WARNING**

Use the attached specified power supply cord. If you use another power supply cord, it may cause interference with radio and television reception.

This apparatus must be grounded.

**DO NOT LOOK DIRECTLY INTO THE LENS WHEN THE PROJECTOR IS IN THE POWER ON MODE.**

### **CAUTION**

The attached power cord is to be used exclusively for this product. Never use it for other products.

### **CAUTION**

Not for use in a computer room as defined in the Standard for the Protection of Electronic Computer/ Data Processing Equipment, ANSI/NFPA 75.

# Contents

---

Important safeguards .....	4
Preparing your projector.....	6
Using the remote control.....	9
Setting up your projector.....	10
Basic connections .....	15
Basic operation .....	19
Menu operation .....	25
Adjusting projected images.....	34
Network functions of this projector .....	39
Initial network settings.....	40
Advanced display utilities.....	46
Advanced features .....	61
Maintenance.....	65
Troubleshooting.....	66
Indicators.....	70
Specifications.....	71

## Trademark, Registered trademark

- DLP™, Digital Micromirror Device, DMD, and DLP™ Link™ are all trademarks of Texas Instruments.
- HDMI, the HDMI logo and High-Definition Multimedia Interface are trademarks or registered trademarks of HDMI Licensing LLC.
- Microsoft, Windows, Windows Vista, Windows Server, MultiPoint, Excel, and PowerPoint are either registered trademarks or trademarks of Microsoft Corporation in the United States and/or other countries.
- Mac, Mac OS, OS X, Finder, and Apple Store are trademarks of Apple Inc.
- Intel and Pentium are trademarks of Intel Corporation in the U.S. and/or other countries.
- PowerPC is a trademark of International Business Machines Corporation, registered in many jurisdictions worldwide.
- IOS is a trademark or registered trademark of Cisco in the U.S. and other countries and is used under license.
- Android and Google are trademarks of Google Inc.
- MirrorOp, MirrorOp Receiver, and WiFi-Doc are registered trademarks, trademarks, or trade names of AWIND Inc.
- Wi-Fi is a registered trademark of the Wi-Fi Alliance.
- The trademark of PJLink is trademark applied for registration or registered trademark in Japan, the United States, and other countries and areas.
- Crestron RoomView Connected is a trademark of Crestron Electronics, Inc.
- Other brand or product names are trademarks or registered trademarks of their respective holders.

# Important safeguards

Please read all these instructions regarding your projector and retain them for future reference. Follow all warnings and instructions marked on the projector.

1. Read instructions  
All the safety and operating instructions should be read before the appliance is operated.
2. Retain instructions  
The safety and operating instructions should be retained for future reference.
3. Warnings  
All warnings on the appliance and in the operating instructions should be adhered to.
4. Instructions  
All operating instructions must be followed.
5. Cleaning  
Unplug this projector from the wall outlet before cleaning it. Do not use liquid aerosol cleaners. Use a damp soft cloth for cleaning.
6. Attachments and equipment  
Never add any attachments and/or equipment without the approval of the manufacturer as such additions may result in the risk of fire, electric shock or other personal injury.
7. Water and moisture  
Do not use this projector near water or in contact with water.
8. Accessories  
Do not place this projector on an unstable cart, stand, tripod, bracket or table. Use only with a cart, stand, tripod bracket, or table recommended by the manufacturer or sold with the projector. Any mounting of the appliance should follow the manufacturer's instructions and should use a mounting accessory recommended by the manufacturer.



An appliance and cart combination should be moved with care. Quick stops, excessive force and uneven surfaces may cause the appliance and cart combination to overturn.

9. Ventilation  
Slots and openings in the cabinet are provided for ventilation, ensuring reliable operation of the projector and to protect it from overheating. Do not block these openings or allow them to be blocked by placing the projector on a bed, sofa, rug, or bookcase. Ensure that there is adequate ventilation and that the manufacturer's instructions have been adhered to.

10. Power sources  
This projector should be operated only from the type of power source indicated on the marking label. If you are not sure of the type of power, please consult your appliance dealer or local power company.
11. Power-cord protection  
Power-supply cords should be routed so that they are not likely to be walked on or pinched by items placed upon or against them. Pay particular attention to cords at plugs, convenience receptacles, and points where they exit from the appliance. Do not put the power cord under a carpet.
12. Overloading  
Do not overload wall outlets and extension cords as this can result in a fire or electric shock.
13. Objects and liquids  
Never push objects of any kind through openings of this projector as they may touch dangerous voltage points or short-out parts that could result in a fire or electric shock. Never spill liquid of any kind on the projector.
14. Servicing  
Do not attempt to service this projector by yourself. Refer all servicing to qualified service personnel.
15. Damage requiring service  
Unplug this projector from the wall outlet and refer servicing to qualified service personnel under the following conditions:
  - (a) If the power-supply cord or plug is damaged.
  - (b) If liquid has been spilled, or objects have fallen into the projector.
  - (c) If the projector does not operate normally after you follow the operating instructions. Adjust only those controls that are covered by the operating instructions. An improper adjustment of other controls may result in damage and may often require extensive work by a qualified technician to restore the projector to its normal operation.
  - (d) If the projector has been exposed to rain or water.
  - (e) If the projector has been dropped or the cabinet has been damaged.
  - (f) If the projector exhibits a distinct change in performance - this indicates a need for service.
16. Replacement parts  
When replacement parts are required, be sure that the service technician has used replacement parts specified by the manufacturer or parts having the same characteristics as the original part. Unauthorized substitutions may result in fire, electric shock or other hazards.
17. Safety check  
Upon completion of any service or repair to this projector, ask the service technician to perform safety checks determining that the projector is in a safe operating condition.



## Important safeguards (continued)

### WARNING:

#### Unplug immediately if there is something wrong with your projector.

Do not operate if smoke, strange noise or odor comes out of your projector. It might cause fire or electric shock. In this case, unplug immediately and contact your dealer.

#### Never remove the cabinet.

This projector contains high voltage circuitry. An inadvertent contact may result in an electric shock. Do not attempt to service this product by yourself. Please contact your dealer when you want to fix, adjust or inspect the projector.

- Safety lock:

When you open the cabinet, the projector is locked and cannot be powered on anymore. In such a case, please contact your dealer.

#### Do not modify this equipment.

It can lead to fire or electric shock.

#### Do not keep using the damaged projector.

If the projector is dropped and the cabinet is damaged, unplug the projector and contact your dealer for inspection. It may lead to fire if you keep using the damaged projector.

#### Be sure to unplug the power cord from the wall outlet if the projector is fractured or deformed.

Otherwise, it may result in fire or electric shock. Ask your dealer for repair.

#### Do not face the projector lens to the sun.

It can lead to fire.

#### Use correct voltage.

If you use incorrect voltage, it can lead to fire.

#### Do not connect multiple electrical appliances to a single wall outlet.

It can lead to fire.

#### Do not extend the power cord.

It can lead to fire.

#### Do not place the projector on uneven surface.

Place the projection on a leveled and stable surface only. Please do not place equipment on unstable surfaces.

#### Do not look into the lens when it is operating.

It may hurt your eyes. Never let children look into the lens when it is on.

#### Do not touch the air outlet grille and bottom plate, which become hot.

Do not touch them or put other equipment in front of the air outlet grille. The air outlet grille and bottom plate, when heated, may cause injury or damage to other equipment. Also, do not set the projector on the desk which is easily affected by heat.

#### Do not look into the air outlet grille when projector is operating.

Heat, dust, etc. may blow out of it and hurt your eyes.

#### Do not insert your fingers in the space between the lens and the cabinet.

The lens may shift causing injury or damage to the projector.

#### Do not block the air inlet and outlet grilles.

If they are blocked, heat may be generated inside the projector, causing deterioration in the projector quality and fire.

#### Do not use flammable solvents (benzene, thinner, etc.) and flammable aerosols near the projector.

Flammable substances may ignite causing fire or breakdown because the temperature inside the projector rises very high while the light source is illuminating.

**Do not use the projector with condensation on it.** It can lead to breakdown or other failure.

#### Place of installation

For safety's sake, refrain from setting the projector at any place subjected to high temperature and high humidity. Please maintain an operating temperature, humidity, and altitude as specified below.

- Operating temperature:  
Allowable operating temperature is +41°F (+5°C) to +95°F (+35°C).
- Projection angles:  
For use in the STANDARD mode, which allows all projection angle of a front and rear direction. For use in the HIGH ALTITUDE mode (see page 12), which allows floor installation or ceiling installation only.
- Operating humidity: between 30% and 90%
- Never put any heat-producing device under the projector so that the projector does not overheat.
- Do not attach the projector to a place that is unstable or subjected to vibration.
- Do not install the projector near any equipment that produces a strong magnetic field. Also refrain from installing near the projector any cable carrying a large current.
- Place the projector on a solid, vibration free surface; otherwise it may fall, causing serious injury to a child or adult, and serious damage to the product.
- Do not stand the projector; it may fall, causing serious injury and damage to the projector.
- Do not install the projector at an angle of a right and left direction greater than 30° to the direction of the exhaust vent downward, heat may be generated inside the projector, causing deterioration in the projector quality and life.
- Do not place the projector near air-conditioning unit, heater, or humidifier to avoid hot or moist air to the exhaust and ventilation hole of the projector.
- Do not place the projector in the following places. Otherwise, a short circuit, heat generation, or melting of the power cord coating may occur, causing fire, electric shock, product failure, or deformation.
  - Outdoors or non air-conditioned place
  - Place where a gas such as a hydrogen sulfide is generated (i.e. hot spring)
  - Place where there is too much salt such as near the coast
- We don't recommend using the projector at an altitude of 2700 meters or higher (When using the product at an altitude of 1500 to 2700 meters above the sea level, set the HIGH ALTITUDE MODE to HIGH ALTITUDE.). Use at an altitude of 2700 meters or higher may affect the projector's life.

#### Do not place a container containing water or other liquid on the projector.

If water spills on or enters the projector, it may result in fire or electric shock.

#### Do not put any object that is heavy or larger than the outer frame on the projector.

Otherwise, the object may fall losing its balance and cause injury.

#### Do not subject the projector to strong shocks or vibrations. Do not handle the projector roughly.

The projector may be damaged, resulting in fire or electric shock.

# Preparing your projector

## Checking accessories

The following accessories are provided with this projector. Check to be sure that all of the accessories are packed in the package.

### What's included in the box

AC power cord*	for the U.S.	J2552-0063-03	Remote control	J8947-0355-00
	for Europe	J2552-0247-00	Safety Manual/Quick Start up	
	for the U.K.	J2552-0065-02	CD-ROM	
	for Australia	J2552-0053-00	R6 (size-AA) battery (two)	
	for South Korea	J2552-0247-00	Lens cap (attached to the projector)	
Computer cable		J2552-0072-05	Power cord holder	

\* One of power cords for the U.S., Europe, U.K., Australia, and South Korea is provided appropriately.

### Important:

- The attached power cord is to be used exclusively for this product. Never use it for other products.

## Battery installation

Use two (AA, R6) size batteries.

### Inserting the batteries into the remote control

1. Remove the back cover of the remote control by pushing the battery compartment door in the direction of the arrow.
2. Load the batteries making sure that they are positioned correctly (+ to +, and - to -).
  - Load the batteries from - spring side, and make sure to set them tightly.
3. Replace the back cover.

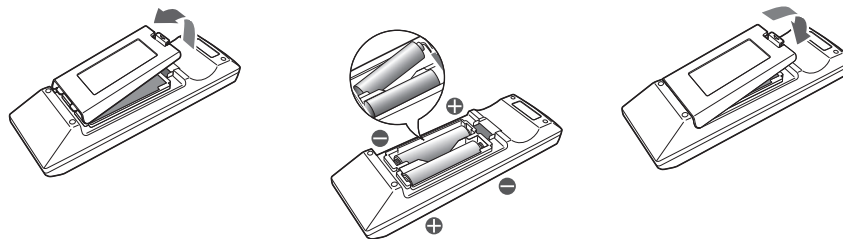

### Removing the batteries from the remote control

Remove the back cover of the remote control and take out the batteries.

#### Caution:

- Use of a battery of wrong type may cause explosion.
- Only Carbon-Zinc or Alkaline-Manganese Dioxide type batteries should be used.
- Dispose of used batteries according to your local regulations.
- Before you dispose of the batteries, insulate them by placing insulation tape on the positive (+) and negative (-) terminals. If you dispose of the batteries together with other conductive objects such as a metal piece, they may short out, resulting in fire or explosion.
- Batteries may explode if misused. Do not recharge, disassemble, or heat the batteries, or put them into fire or water.
- Be sure to handle the batteries according to the instructions.
- Load the batteries with its positive (+) and negative (-) sides correctly oriented as indicated on the remote control.
- Keep batteries out of reach of children and pets. If children swallow the battery, see a doctor immediately.
- Remove the batteries, if the remote control is not used for a long time.
- Do not combine a new battery with an old one.
- If the solution of batteries comes in contact with your skin or clothes, rinse with water. If the solution comes in contact with your eyes, rinse them with water and then consult your doctor.
- Do not carry or store the batteries together with metallic ballpoint pens, necklaces, coins, or hairpins. Otherwise, they may short out, causing explosion or liquid leakage and resulting in fire or injury.
- Do not store the batteries where they are exposed to direct sunlight or subjected to high temperature and high humidity. High temperature and high humidity may cause corrosion or liquid leakage.
- Do not place the batteries or the battery-installed remote control in a place where temperature rises such as an area exposed to direct sunlight, near a heat generating device, and near direct heat.
- The lifetime of the batteries is about 1 year. (It varies depending on the usage.)
- Do not drop, hit, or give impact to the remote control. Do not place a heavy object or step on the remote control. Doing so may cause cracking of the internal board and other failures even if it doesn't damage the remote control in its appearance. Handle it with care.

## Preparing your projector (continued)

### Overview

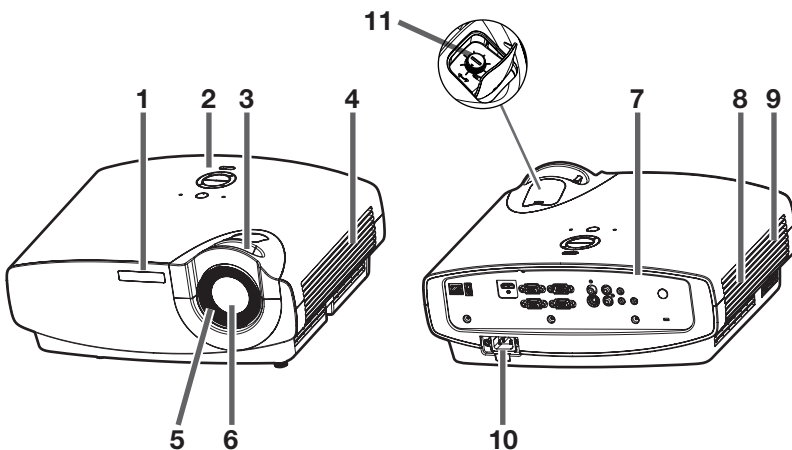

- 1 Remote control sensor (front)/ Intelligent glare sensor
- 2 Control area
- 3 Zoom ring
- 4 Air outlet grille
- 5 Focus ring
- 6 Lens
- 7 Terminal panel
- 8 Speaker
- 9 Air inlet grille
- 10 Power jack
- 11 LENS SHIFT dial

### Control area

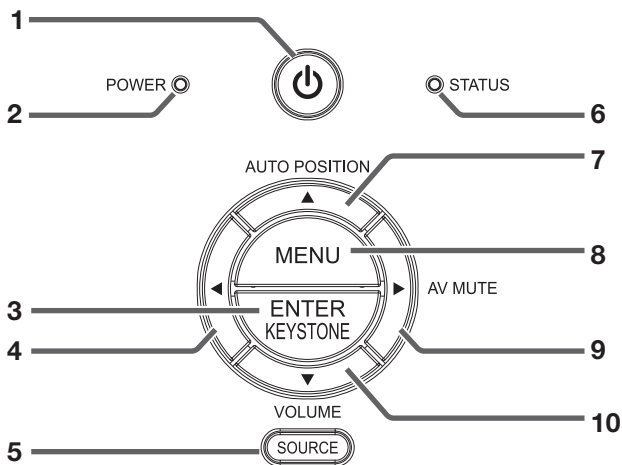

- 1 **POWER button (ON/STANDBY)**  
The status is changed between ON and STANDBY.
- 2 **POWER indicator**
- 3 **ENTER/KEystone** button
- 4 **◀** button
- 5 **SOURCE** button
- 6 **STATUS** indicator
- 7 **AUTO POSITION/▲** button
- 8 **MENU** button
- 9 **AV MUTE/▶** button
- 10 **VOLUME/▼** button

### Terminal panel

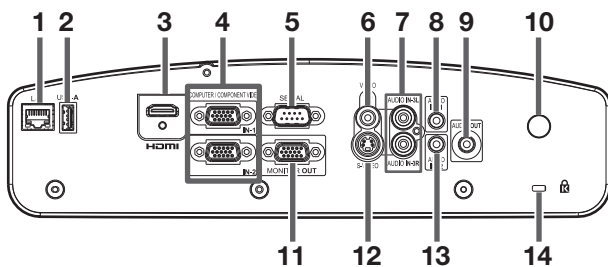

- 1 LAN terminal
- 2 USB-A terminal
- 3 HDMI IN terminal (HDMI 19-pin)
- 4 **COMPUTER/COMPONENT VIDEO IN** terminals (1,2) (mini D-SUB 15-pin)
- 5 SERIAL terminal (D-SUB 9-pin male)
- 6 VIDEO IN terminal
- 7 **AUDIO IN 3** terminals (L,R)
- 8 **AUDIO IN 1** terminal (mini jack)
- 9 **AUDIO OUT** terminal (mini jack)
- 10 Remote control sensor (rear)
- 11 **MONITOR OUT** terminal (mini D-SUB 15-pin)
- 12 S-VIDEO IN terminal
- 13 **AUDIO IN 2** terminal (mini jack)
- 14 Kensington Security Lock Standard connector

## Preparing your projector (continued)

### Bottom side

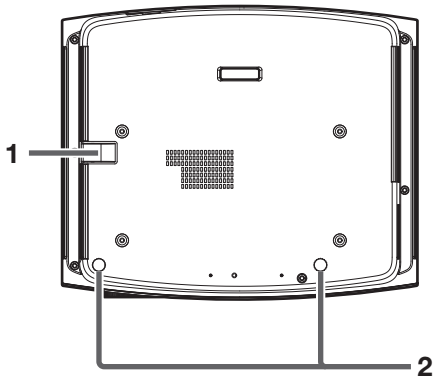

- 1 **Lock bar (SECURITY ANCHOR)**
  - Attach a chain, etc. to this lock bar to anchor the projector.
- 2 **Adjustment feet**

### Remote control

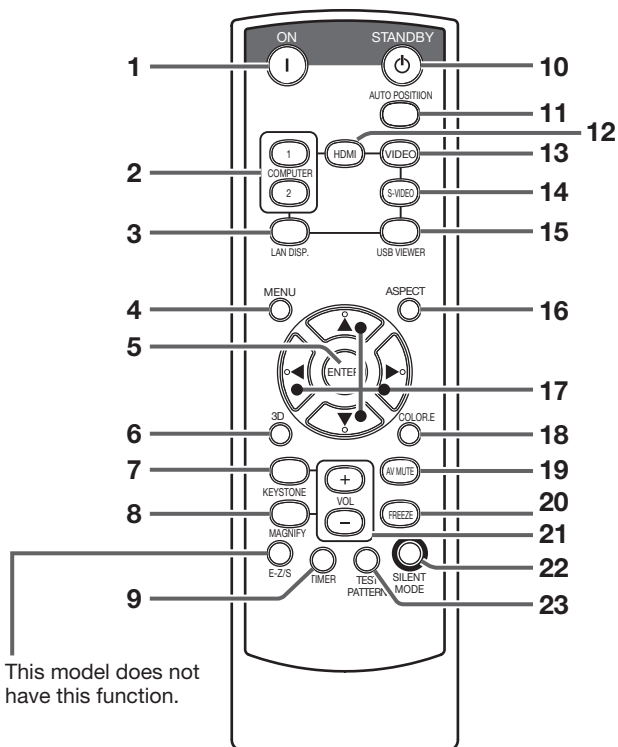

- 1 ON button
- 2 COMPUTER 1, 2 buttons
- 3 LAN DISP. button
- 4 MENU button
- 5 ENTER button
- 6 3D button
- 7 KEYSTONE button
- 8 MAGNIFY button
- 9 TIMER button
- 10 STANDBY button
- 11 AUTO POSITION button
- 12 HDMI button
- 13 VIDEO button
- 14 S-VIDEO button
- 15 USB VIEWER button
- 16 ASPECT button
- 17 ▲, ▼, ◀, ▶ buttons
- 18 COLOR. E (COLOR.ENHANCER) button
- 19 AV (Audio/Video) MUTE button
- 20 FREEZE button
- 21 +, - buttons\*1
- 22 SILENT MODE button
- 23 TEST PATTERN button

\*1: The +, - buttons also function for KEYSTONE and MAGNIFY adjustment.

# Using the remote control

## Operation range (of the remote control)

The maximum operation distance of the remote control is about 10 m (or about 32 feet) when the remote control is pointed at the remote control sensor of the projector. When the remote control is pointed to the screen, the distance from the remote control to the projector via the screen should be 5 m or less. However, the operation distance varies depending on the type of the screen used.

### Reception angle (horizontal)

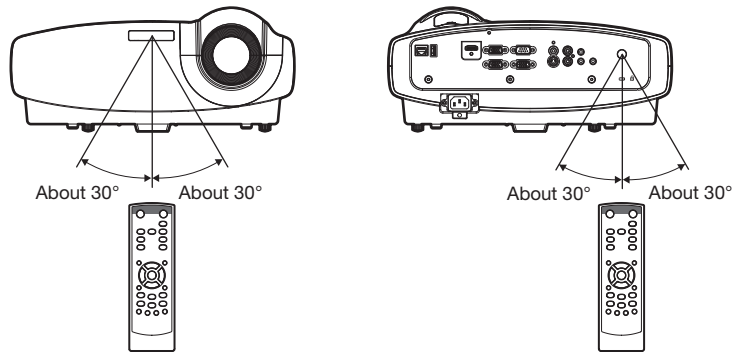

### Reception angle (vertical)

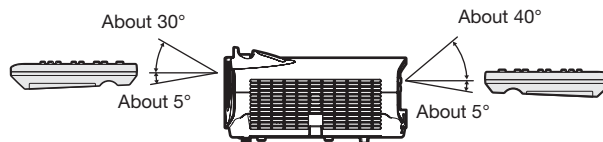

### Reception angle (vertical), ceiling mount

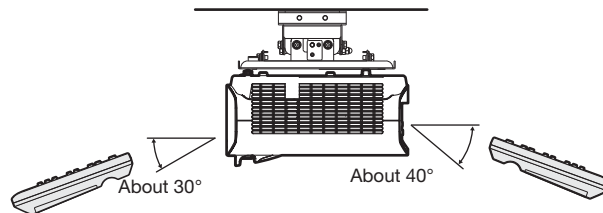

### Important:

- Do not expose the remote control sensor to direct sunlight or fluorescent. Keep a distance at least 2 m (6.5 feet) between the remote control sensor and the fluorescent light to ensure correct operation of the remote control. Inverted fluorescent light, if located near the projector, may interfere the remote control.
- When you use the remote control too close to the remote control sensor, the remote control may not work correctly.

# Setting up your projector

## Before setting up

Before setting up the projector, check the operating environment. If the environmental requirements are not satisfied, the projector may break down or fail.

## Setting up the screen

Install the screen perpendicularly to the projector. If the screen can not be installed in such a way, adjust the projection angle of the projector. (See page 12.)

- Install the screen and projector so that the projector's lens is placed at the same height and horizontal position of the screen center.
- Do not install the screen where it is exposed to direct sunlight or lighting. Light directly reflecting on the screen makes the projected images whitish and hard to view.

## Screen size and projection distance

Refer to the following table to determine the screen size and projection distance.

- For the aspect ratio setting, see page 22.
- The figures in the tables are approximate and may be slightly different from the actual measurements.
- The lens shift height shows distances from the factory default position.

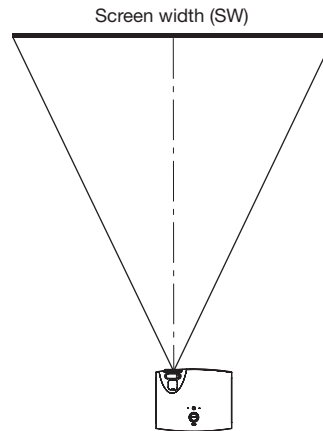
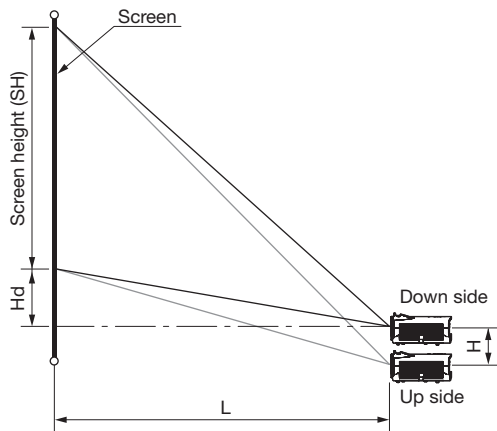

Screen size (16:10)						Hd		Projection distance (L)				Lens shift height (H)	
Diagonal size		Width (SW)		Height (SH)				Shortest (Wide)		Longest (Tele)			
inch	cm	inch	cm	inch	cm	inch	cm	inch	m	inch	m	inch	cm
40	102	34	86	21	54	2.6	7	49	1.2	76	1.9	3	8
60	152	51	129	32	81	4	10	74	1.9	114	2.9	5	12
80	203	68	172	42	108	5	13	99	2.5	153	3.9	6	16
100	254	85	215	53	135	7	17	124	3.2	191	4.9	8	20
120	305	102	258	64	162	8	20	149	3.8	230	5.8	10	24
150	381	127	323	79	202	10	25	187	4.7	288	7.3	12	30
200	508	170	431	106	269	13	33	250	6.3	384	9.8	16	40
250	635	212	538	132	337	16	42	312	7.9	-	-	20	51
300	762	254	646	159	404	20	50	375	9.5	-	-	24	61

# Setting up your projector (continued)

## Screen size and projection distance (continued)

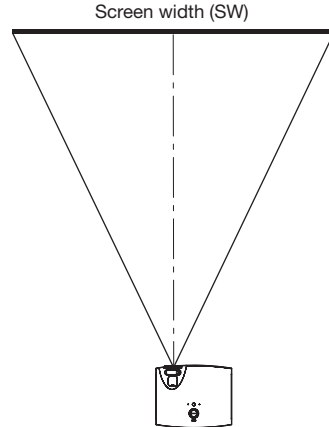
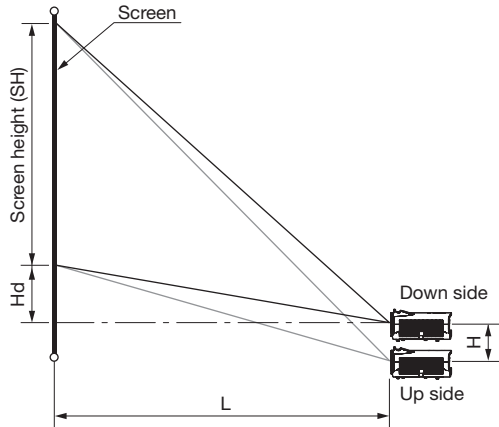

### When the aspect ratio of the screen is 4:3

When the aspect ratio of the screen is 4:3, the positional relation between the projected image and the screen is as shown on the right. Refer to the following table for installation.

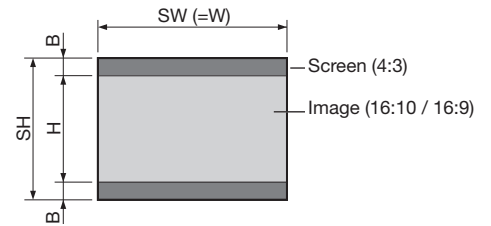

### • When the aspect ratio of the image is 16:10 (WXGA)

Screen size (4:3)						Size of the projected image (16:10)						Black space (B)		Hd		Projection distance (L)				Lens shift height (H)	
Diagonal size		Width (SW)		Height (SH)		Diagonal size		Width (W)		Height (H)						Shortest (Wide)		Longest (Tele)			
inch	cm	inch	cm	inch	cm	inch	cm	inch	cm	inch	cm	inch	cm	inch	cm	inch	m	inch	m	inch	cm
40	102	32	81	24	61	38	96	32	81	20	51	2	5	4	11	46	1.2	71	1.8	3	8
60	152	48	122	36	91	57	144	48	122	30	76	3	8	7	17	70	1.8	108	2.7	5	11
80	203	64	163	48	122	75	192	64	163	40	102	4	10	9	23	93	2.4	144	3.7	6	15
100	254	80	203	60	152	94	240	80	203	50	127	5	13	11	28	117	3.0	180	4.6	8	19
120	305	96	244	72	183	113	288	96	244	60	152	6	15	13	34	141	3.6	217	5.5	9	23
150	381	120	305	90	229	142	359	120	305	75	191	8	19	17	43	176	4.5	271	6.9	11	29
200	508	160	406	120	305	189	479	160	406	100	254	10	25	22	57	235	6.0	362	9.2	15	38
250	635	200	508	150	381	236	599	200	508	125	318	13	32	28	71	295	7.5	-	-	19	48
300	762	240	610	180	457	283	719	240	610	150	381	15	38	34	85	354	9.0	-	-	23	57

### • When the aspect ratio of the image is 16:9

Screen size (4:3)						Size of the projected image (16:9)						Black space (B)		Hd		Projection distance (L)				Lens shift height (H)	
Diagonal size		Width (SW)		Height (SH)		Diagonal size		Width (W)		Height (H)						Shortest (Wide)		Longest (Tele)			
inch	cm	inch	cm	inch	cm	inch	cm	inch	cm	inch	cm	inch	cm	inch	cm	inch	m	inch	m	inch	cm
40	102	32	81	24	61	37	93	32	81	18	46	3	8	5	13	46	1.2	71	1.8	3	8
60	152	48	122	36	91	55	140	48	122	27	69	5	11	8	20	70	1.8	108	2.7	5	11
80	203	64	163	48	122	73	187	64	163	36	91	6	15	10	27	93	2.4	144	3.7	6	15
100	254	80	203	60	152	92	233	80	203	45	114	8	19	13	33	117	3.0	180	4.6	8	19
120	305	96	244	72	183	110	280	96	244	54	137	9	23	16	40	141	3.6	217	5.5	9	23
150	381	120	305	90	229	138	350	120	305	68	171	11	29	20	50	176	4.5	271	6.9	11	29
200	508	160	406	120	305	184	466	160	406	90	229	15	38	26	66	235	6.0	362	9.2	15	38
250	635	200	508	150	381	229	583	200	508	113	286	19	48	33	83	295	7.5	-	-	19	48
300	762	240	610	180	457	275	699	240	610	135	343	23	57	39	100	354	9.0	-	-	23	57



## Setting up your projector (continued)

### Changing the AUTO POWER OFF setting

The AUTO POWER OFF function of this projector is enabled by default.

Change the AUTO POWER OFF setting as necessary. (See page 29.)

#### To change the AUTO POWER OFF setting:

(See page 26 for menu setting.)

1. Display the INSTALLATION menu.
2. Select AUTO POWER OFF by pressing the ▲ or ▼ button.

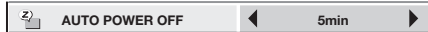

3. Select your desired item by pressing the ◀ or ▶ button.

#### Important:

- This function does not work when the input source is LAN DISPLAY or USB VIEWER.
- The AUTO POWER OFF function does not work during AV MUTE.
- While the intelligent glare sensor is detecting an object, AUTO POWER OFF doesn't work. (When the intelligent glare sensor stops detecting, the projector turns off.)

### Setting HIGH ALTITUDE MODE

- Set HIGH ALTITUDE MODE in the FEATURE menu according to the altitude at which you use the projector. The default setting is STANDARD.
- Select STANDARD when using the projector at an altitude from 0 to 1500 meters.
- Select HIGH ALTITUDE when using the projector at an altitude from 1500 to 2700 meters.

#### Important:

- If you select STANDARD when using the projector at an altitude higher than 1500 meters, the projector may break down or fail.
- When you use the projector in the HIGH ALTITUDE mode, only floor installation and ceiling installation are allowed.

(See page 26 for menu setting.)

1. Display the FEATURE menu.
2. Select HIGH ALTITUDE MODE by pressing the ▲ or ▼ button.



3. Press the ENTER button.



4. Select STANDARD or HIGH ALTITUDE by pressing the ◀ or ▶ button.
5. Press the ENTER button.

### Setting IMAGE REVERSE

Set IMAGE REVERSE in the INSTALLATION menu according to the orientation of the projector. The default setting is OFF.

- Select OFF for the combination of floor installation and front projection.
- Select MIRROR INVERT for the combination of ceiling installation and front projection.
- Select MIRROR for the combination of floor installation and rear projection.
- Select INVERT for the combination of ceiling installation and rear projection.

(See page 26 for menu setting.)

1. Display the INSTALLATION menu.
2. Select IMAGE REVERSE by pressing the ▲ or ▼ button.



3. Select OFF, MIRROR, INVERT or MIRROR INVERT by pressing the ◀ or ▶ button.

### Correcting skewed or distorted image

For the best projection, project images on a flat screen installed at 90 degrees to the floor. If necessary, tilt the projector using the two adjustment feet on the bottom of the projector.

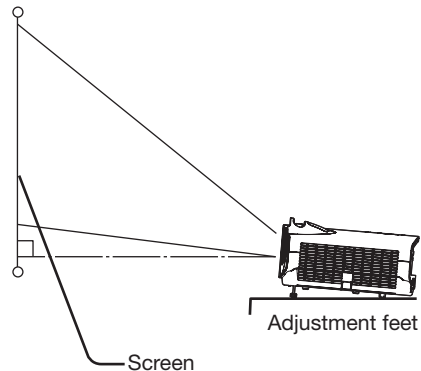

1. Tilt up the projector to the appropriate angle.
2. Rotate the adjustment feet for fine adjustment.

#### Important:

- Don't transport the projector with its adjustment feet extended. Otherwise the adjustment feet may be damaged.

### When fine streaks are seen on projected images

This is due to interference with the screen surface and is not a malfunction. Replace the screen or displace the focus a little.



## Setting up your projector (continued)

### Adjusting the position of the projected image

To adjust the position of the projected image on the screen, use the LENS SHIFT dial.

1. Rotate the LENS SHIFT dial inside the top cover of the projector to adjust the image position.
  - Rotating the dial clockwise (or counterclockwise for a ceiling-mount projector) moves the image up.
  - Rotating the dial counterclockwise (or clockwise for a ceiling-mount projector) moves the image down.
- Be careful not to be caught in the opening in the lens while the lens is moving.
- While the lens shift is working, the screen may flicker.
- Projected images may become distorted, have decreased resolution, or have shadows at their corners if they are positioned close to the top or bottom.

### When projected images are distorted to a trapezoid

When AUTO KEYSTONE in the INSTALLATION menu is set to ON, this projector automatically corrects vertical keystone distortion. For fine adjustment, press the KEYSTONE button on the projector or the remote control to display Keystone, and adjust the image by pressing the ▲, ▼ button (or +, - button on the remote control).

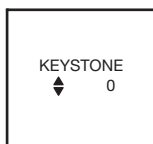

#### KEYSTONE menu

You can correct the distortion vertically focusing on the screen center.

In the following cases:



Press the ▲ or + button.



Press the ▼ or - button.



#### Important:

- The automatic keystone adjustment may not be carried out correctly because of the ambient temperature and the installation conditions of the projector and the screen. In such cases, correct the keystone manually.
- When the projector is projecting images where acceleration is present, such as in a vehicle and aircraft, the automatic keystone adjustment may not function correctly. In such a case, set AUTO KEYSTONE in the INSTALLATION menu to OFF and correct the keystone manually.
- When the KEYSTONE-mode adjustment is carried out, the adjustment value is indicated. Note that this value doesn't mean a projection angle.
- When the KEYSTONE-mode adjustment takes effect, the resolution decreases. In addition, stripes may appear or straight lines may bend in images with complicated patterns. They are not due to product malfunctions.
- When the KEYSTONE-mode adjustment is performed, the displayed image may be distorted.
- Noise may appear on the screen during the KEYSTONE-mode adjustment because of the type of the video signal being projected and the setting values of the KEYSTONE-mode adjustment. In such cases, set the KEYSTONE-mode adjustment values in the range where the image is displayed without noise.
- When the KEYSTONE-mode adjustment is performed, the menu display is distorted. To relieve such symptom, set the MENU POSITION to center.

#### Intelligent glare sensor:

To prevent discomfort feeling to the eyes caused by seeing the illuminating light source through the lens, the intelligent glare sensor detects a person who stands in front of the projector and mutes the projected images automatically.

- The intelligent glare sensor detects an object placed in front of the lens and shuts off the screen. Therefore, do not place any object within 50 cm from the front of the sensor.
- The sensor may detect a transparent board.
- To cancel muting temporarily, press the POWER button on the projector or the ON button on the remote control.

## Setting up your projector (continued)

### Front projection, ceiling mounting

For ceiling mounting, you need the ceiling mount kit designed for this projector. Ask a specialist for installation. For details, consult your dealer.

- The warranty on this projector does not cover any damage caused by use of any non-recommended ceiling mount kit or installation of the ceiling mount kit in an improper location.

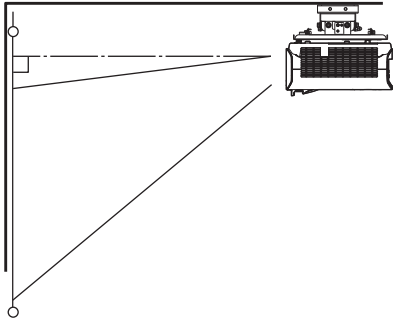

- When using the projector mounted on the ceiling, set IMAGE REVERSE in the INSTALLATION menu to MIRROR INVERT. See page 29.
- When the projector is mounted on the ceiling, images may appear darker than those projected in the case of tabletop mounting. This isn't a product malfunction.
- Ask your installation specialist to provide a breaker. When you do not use the projector, be sure to shut down the main power by the breaker.
- Do not install the projector where the exhaust vents are exposed to air emitted by an air conditioning. Such installation may cause a breakdown.
- Do not install the projector near a fire alarm because it emits hot air from its exhaust vents.

#### Caution:

- Installation must be done by a qualified professional.  
When the projector is installed on the ceiling using the ceiling mount kit, it is recommended to hold the mount kit and the projector using metal bars or wires in addition to the mount kit fixing screws to prevent the projector from falling due to an earthquake or other cause. For that purpose, use metal bars, wires, or screws that bear a load of at least 70 kgf. When using metal wires, secure one end to the adjustment foot of the projector and the other end to the mount kit. In this case, make sure that no electrical current is flowing in the mount kit due to current leakage or other cause.

### Rear projection

Ask a specialist for installation. For details, consult your dealer.

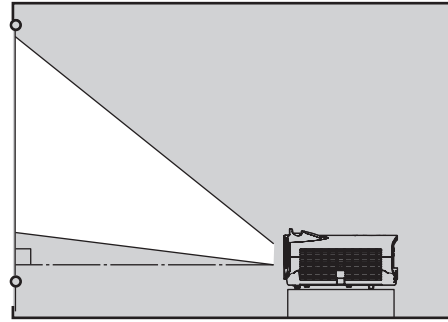

- For rear projection, set IMAGE REVERSE in the INSTALLATION menu to MIRROR. See page 29.

#### Caution:

- Placing the projector directly on a carpet impairs ventilation by the fans, causing damage or failure. Put a hard board under the projector to facilitate ventilation.
- Place the projector at least 50 cm (or 20 inches) away from the wall to prevent the air inlet grille and the air outlet grilles that emit hot air from being blocked.
- Do not use the projector in the following locations and manners, which may cause fire or electric shock.
  - In a dusty or humid place.
  - Near a heater.
  - In an oily, smoky, or damp place such as a kitchen.
  - In direct sunlight.
  - Where the temperature rises high, such as in a closed car.
  - Where the temperature is lower than +41°F (or +5°C) or higher than +95°F (or +35°C).
  - For use in the HIGH ALTITUDE mode
    - In other than floor installation and ceiling installation.
- Keep foliage plants and pets away from the projector. The temperature around the exhaust vents and that of the cabinet on the top of the exhaust vents become high. Take special care for small children.

#### Important:

- We don't recommend using the projector at an altitude of 2700 meters or higher (When using the product at an altitude of 1500 to 2700 meters above the sea level, set the HIGH ALTITUDE MODE to HIGH ALTITUDE.). Use at an altitude of 2700 meters or higher may affect the projector's life.

# Basic connections

This projector can be connected with various devices such as a VCR, video camera, videodisc player, and personal computer that have analog RGB output connectors.

**Important:**

- Make sure that the connected device is turned off before starting connection.
- Plug in the power cords of the projector and the connected devices firmly. When unplugging, hold and pull the plug. Do not pull the cord.
- When the projector and the connected devices are located too close to each other, the projected image may be affected by their interference.
- See the owner's guide of each device for details about its connections.

## Projector + AV device

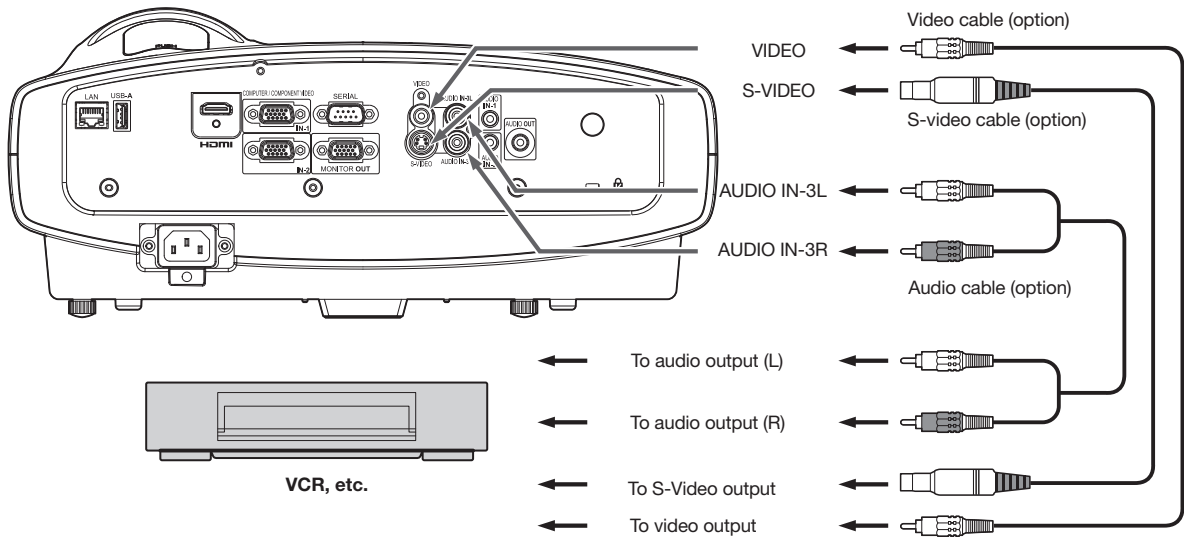

**Important:**

- Match the colors of the video and audio plugs on the Audio cable with those of the terminals.
- Speaker output is mono.

## Projector + DVD player or HDTV decoder

Some DVD players have an output connector for 3-line fitting (Y, C<sub>B</sub>, C<sub>R</sub>). When connecting such DVD player with this projector, use the COMPUTER/COMPONENT VIDEO IN terminal.

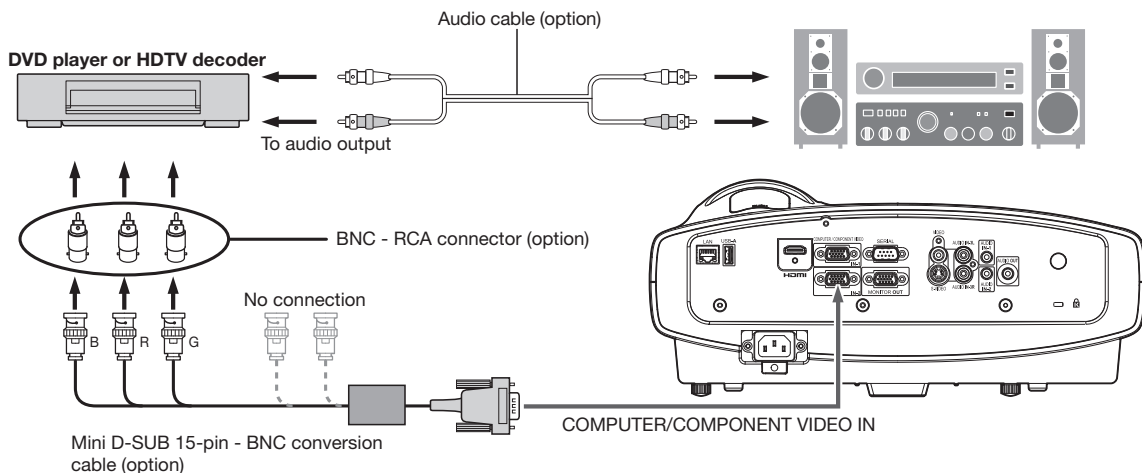

**Important:**

- The terminal's names Y, P<sub>B</sub>, and P<sub>R</sub> are given as examples of when a HDTV decoder is connected.
- The terminal's names vary depending on the connected devices.
- Use a mini D-SUB 15-pin - BNC conversion cable for connection.
- Image may not be projected correctly with some DVD players.
- When connecting a HDTV decoder having RGB output terminals, set COMPUTER INPUT to RGB in the SIGNAL menu.

## Basic connections (continued)

### Connection (for video equipment having an HDMI terminal)

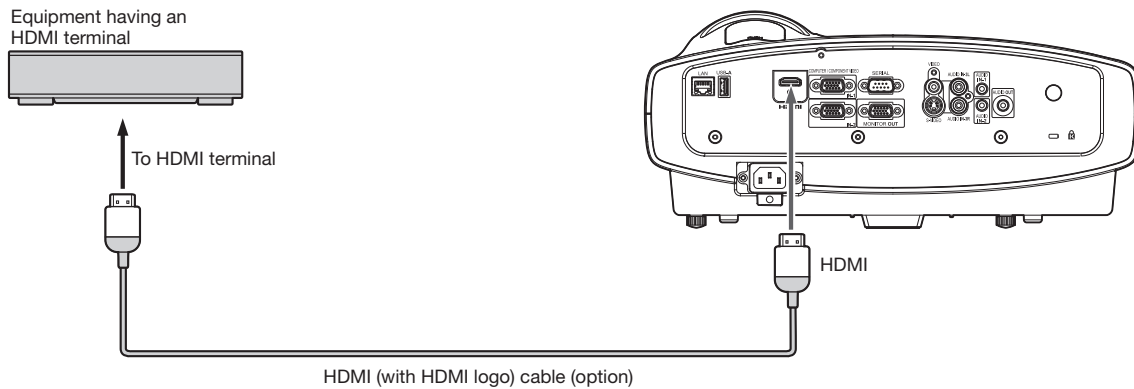

#### Important:

- Use a commercially available HDMI (with HDMI logo) cable.
- You don't have to connect any cable for audio input. You can input video and audio using an HDMI cable only.
- When HDMI audio isn't output, it may be output by turning off the power of the video equipment with the projector and the video equipment connected to each other and then turning back on the power.
- Some cables may not be connected correctly depending on the size and shape of their connectors.

#### When you connect this projector and a Digital device (such as a DVD player) via the HDMI terminal, black color may appear dark and deep, depending on the type of the connected device.

- This depends on the black level setting of the connected device. There are two kinds of methods to digitally transfer image data, in which different black level settings are employed respectively. Therefore, the specifications of the signals output from DVD players differ, depending on the type of the digital data transfer method they use.
- Some DVD players are provided with a function to switch the methods to output digital signals. When your DVD player is provided with such function, set it as follows.  
EXPAND or ENHANCED → NORMAL
  - See the users guide of your DVD player for details.
- When your digital device does not have such function, set INPUT LEVEL to ENHANCED in the ADVANCED MENU of the IMAGE menu of this projector, or adjust the black color by viewing the image.

## Basic connections (continued)

### Projector + Computer

#### For computer with Mini D-SUB

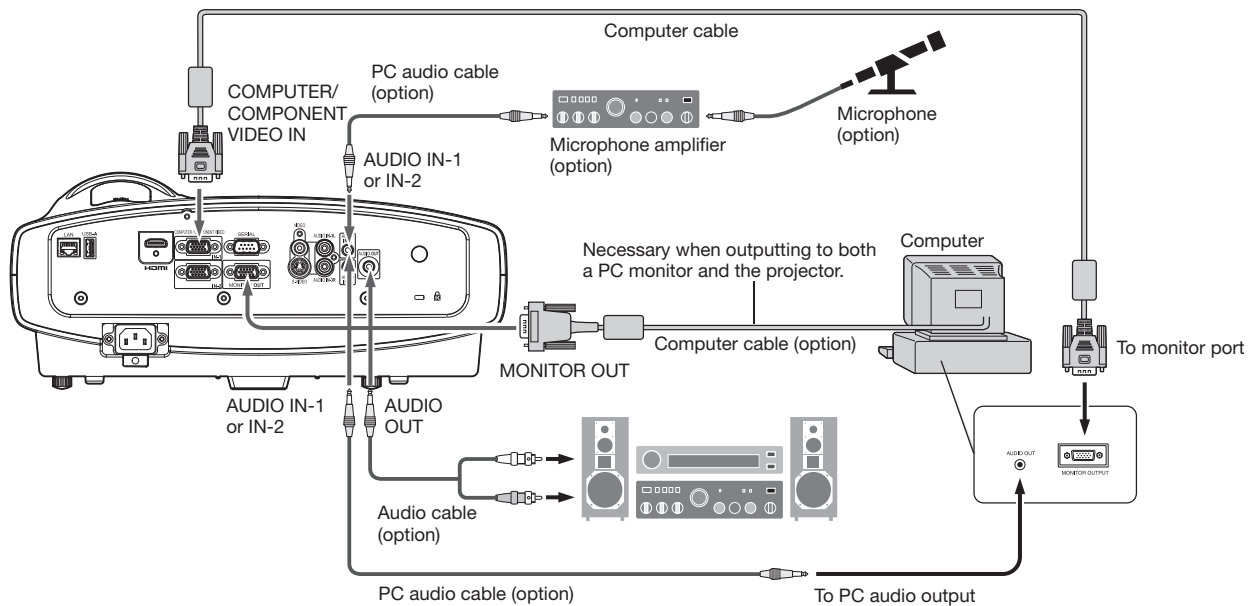

#### For analog connection:

1. Connect one end of the supplied computer cable to the COMPUTER/COMPONENT VIDEO IN terminal (1, 2) of the projector.
2. Connect the other end of the computer cable to the monitor port of the computer.

#### For monitor connection:

Connect the computer cable from the monitor to the MONITOR OUT terminal of the projector.

- Images may not be displayed correctly depending on the type of the input signal. See the instruction manual of the monitor.
- Signals are coming from the COMPUTER/COMPONENT VIDEO IN-1 terminal of the projector.
- When the STANDBY MODE in the Installation menu is set to STANDARD, the MONITOR OUT terminal outputs signals during power standby.

#### Important:

- When you use a longer computer cable instead of the provided cable, the image may not be projected correctly.
- Some computers require additional connectors or analog RGB output adapters to be connected with this projector. Contact your dealer for further information.
- This projector uses stereo mini jack for its audio input. Check the type of the audio output terminal of the connected computer and prepare a proper cable for connection. Some computers don't have the audio output terminal.
- Speaker output is mono.
- When the audio cable is connected to the AUDIO OUT terminal, the speaker output is muted.
- The audio output can be available during power standby according to the setting. (See page 28.)
- The audio signals for AUDIO IN-1 and AUDIO IN-2 can be output simultaneously according to the setting. (See page 28.)

#### For Mac computers

- If your Mac computer has no video port, a monitor output adapter is required. Contact your dealer for further information.
- Some Mac computers require a Mac adapter for the computer cable for connection with this projector. Contact your dealer for further information.

#### About DDC

The COMPUTER/COMPONENT VIDEO IN terminal (1, 2) of this projector complies with the DDC 1/2B standard. When a computer supporting this standard is connected to this terminal, the computer will automatically load the information from this projector and prepare for output of appropriate images.

- After connecting a computer supporting this standard to this terminal, plug the power cord of the projector in the wall outlet first, and then boot up the computer.

## Basic connections (continued)

### Plugging the power cord

- In order to ensure the safety in case of trouble with the projector, use an electrical outlet having an earth leakage breaker to supply the power to the projector. If you do not have such outlet, ask your dealer to install it.

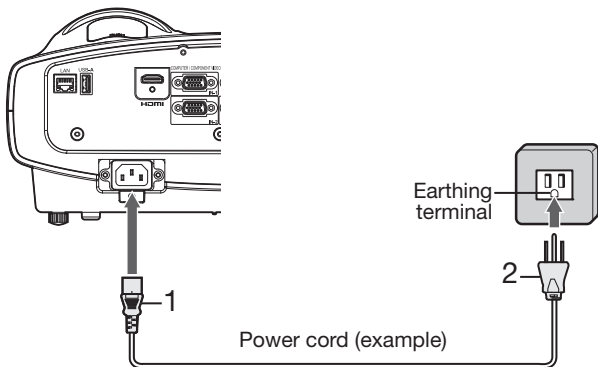

1. Plug the attached power cord into the power cord inlet of this projector.
2. Plug the other end of the power cord into a power outlet.

#### Warning:

- One of power cords for the U.S., Europe, U.K., Australia and South Korea is provided appropriately.
- This projector uses the power plug of 3-pin grounding type. Do not take away the grounding pin from the power plug. If the power plug doesn't fit your wall outlet, ask an electrician to change the wall outlet.
- In case that the power cord for the U.S. is provided with this projector, never connect this cord to any outlet or power supply using other voltages or frequencies than rated. If you want to use a power supply using other voltage than rated, prepare an appropriate power cord separately.
- Use 100-240 V AC 50/60 Hz to prevent fire or electric shock.
- Do not place any objects on the power cord or do not place the projector near heat sources to prevent damage to the power cord. If the power cord should be damaged, contact your dealer for replacement because it may cause fire or electric shock.
- Do not modify or alter the power cord. If the power cord is modified or altered, it may cause fire or electric shock.

#### Caution:

- Plug in the power cord firmly. When unplugging, hold and pull the power plug, not the power cord.
- Do not plug in or out the power cord with your hand wet. It may cause electric shock.
- When you move the projector, turn off the power, unplug the power cord from the wall outlet, and then remove the connected cords. Otherwise, the power cord may be damaged, resulting in fire or electric shock.
- If dust or metallic substance is on or around the pins of the power plug, unplug the power cord and clean it using a dry cloth. If you continue to use the projector without cleaning, it may result in fire or electric shock. Clean the power plug periodically at least once a year.
- Be sure to unplug the power cord from the wall outlet if the projector will not be used for a long period of time. Otherwise, it may cause fire.

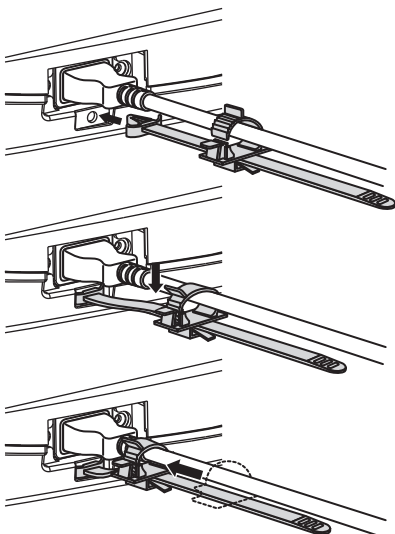

#### Attaching the power cord holder:

To reduce the risk of accidental disconnection of the power cord from the projector, attach the supplied power cord holder to hold it.

#### Important:

- Once the power cord holder is attached to the projector, it cannot be removed.
  - If you apply an excessive force, the power cord holder may be damaged.
1. Insert the tip of the power cord holder into the slot with the clamber facing toward the power cord.
  2. Put the power cord in the clamber, and push the clamber in the direction of the arrow to lock it.
  3. Slide the clamber toward the plug.



# Basic operation

## Projecting images

### Preparation:

- Remove the lens cap.

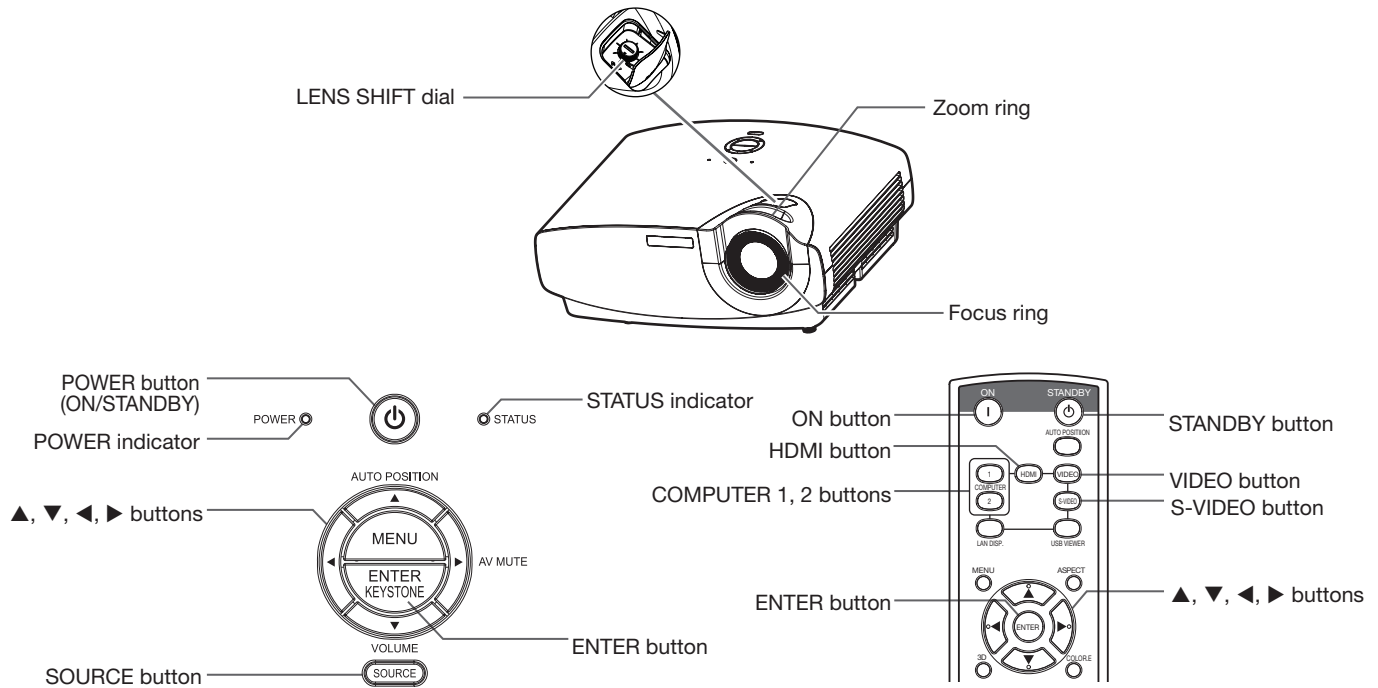

- Confirm the POWER indicator lights up red.
- Turn on the power of the connected devices.
- Press the POWER button.
  - It may take a few seconds for the light source to light up.
  - Do not cover the lens with the lens cap while the light source is on.
  - After the POWER button is pressed, the image may flicker before the light source becomes stable. This is not a product malfunction.
- Adjust the focus by turning the focus ring.
  - You are recommended to adjust the focus at the screen center.
- Select an input source.
  - Press the SOURCE button on the projector or the COMPUTER (1 or 2), HDMI, VIDEO or S-VIDEO button on the remote control that is corresponding to the terminal in use.
  - When the SOURCE button is pressed, the SOURCE dialog shown right appears. Press the ▲ or ▼ button to select an input and press the ENTER button.
  - The projector automatically selects the appropriate signal format. The selected signal format is displayed on the screen.
  - You cannot change the input source while the menu is being displayed.
  - Though it may take some time before an image is displayed on the screen depending on the type of the input signal, such symptom is not a malfunction.
  - Images may not be projected in the correct position, depending on the type of the input signal. In such a case, press the AUTO POSITION button. (The AUTO POSITION only works when the input is COMPUTER (1 or 2).) (See page 21.)
  - When COMPUTER 1 or COMPUTER 2 is chosen as the source, images supplied from the computer may flicker. Press the ◀ or ▶ button on the remote control to reduce flicker, if it occurs. (Fine adjustment)
- Adjust the image size by turning the zoom ring.
- Adjust the vertical position of the displayed image by turning the LENS SHIFT dial.
  - If necessary, adjust the focus and zoom again.
- Adjust the position of the projector so that the projector and the screen are perpendicular to each other. (See page 10.)
  - When the projector cannot be positioned perpendicularly to the screen, adjust the projection angle. (See page 12.)

SOURCE
COMPUTER1
COMPUTER2
HDMI
VIDEO
S-VIDEO
LAN DISPLAY
USB VIEWER

## Basic operation (continued)

---

### To stop projecting:

9. Press the POWER button.
  - A confirmation message is displayed.
  - To cancel the procedure, leave the projector for a while or press any button except the POWER button.
10. Press the POWER button again.
  - The light goes out and the projector goes into a standby mode. In this standby mode, the STATUS indicator may blink green about 1 second and then go out.
11. Unplug the power cord from the outlet.
  - The POWER indicator will go out. It may take about a half minute for the POWER indicator to go out.
  - If necessary, disconnect the cables from the computer after unplugging the power cord.

### Important:

- Before carrying the projector, rotate the focus ring and zoom ring to adjust the lens to the shortest. This prevents the possible damages of the lens.

### Direct Power OFF

You can turn off this projector just by unplugging the power cord without pressing the POWER button.

- Before shutting down the projector, be sure to close the menu screen. If you shut down the projector without closing the menu, the setting data of the menu may not be saved.
- Don't shut down the projector while you are changing the NETWORK menu settings or projector's settings via network connection.

### Volume from the speaker

Press the VOLUME + or - button on the remote control or VOLUME button on the projector. The volume control bar will appear on the screen. Press the VOLUME +, -, ◀ or ▶ button while the volume control bar is displayed to adjust the volume.

- The volume control bar will also appear by pressing the ENTER button while the balance control bar is displayed.

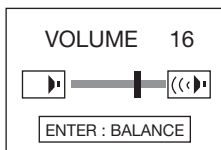

- The volume control bar will disappear about 10 seconds after the VOLUME button is released.
- The VOLUME buttons don't function while the menu selection bar or the menu is being displayed.
- When a high-level audio signal, such as a DVD audio signal, is supplied to the AUDIO IN terminals, the output from the speaker may be distorted.
- When the audio cable is connected to the AUDIO OUT terminal, the speaker output is muted.
- The volume of the audio from the AUDIO OUT terminal is also changed by pressing the VOLUME buttons.
- The VOLUME value varies within the range between 0 and 21, and the same value is applied during projection and power standby.

You can change the volume during power standby by pressing VOLUME + or - button after the following setting is done.

(See page 26 for menu setting.)

1. Display the INSTALLATION menu.
2. Select VOLUME ADJUSTMENT by pressing the ▲ or ▼ button.
3. Select PROJECTION AND STANDBY by pressing the ◀ or ▶ button.
4. Set STANDBY MODE to STANDARD. (See page 28.)



## Basic operation (continued)

### Mix balance

You can change the volume balance between AUDIO1 and AUDIO2. Select MIX  for AUDIO INPUT (PROJECTION) or AUDIO INPUT (STANDBY) in the INSTALLATION menu and press the ENTER button. The balance control bar will appear on the screen. Press the VOLUME +, -, ◀ or ▶ button while the balance control bar is displayed to adjust the volume balance between AUDIO1 and AUDIO2.

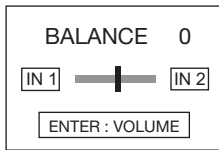

- The balance control bar will disappear about 10 seconds after the ENTER button is released.
- The balance control bar will also appear by pressing the ENTER button while the volume control bar is displayed only when MIX  is selected for AUDIO INPUT (PROJECTION) in the INSTALLATION menu.
- The volume balance between AUDIO1 and AUDIO2 cannot be changed during power standby.
- The BALANCE value varies within the range between -10 and 10, and the same value is applied during projection and power standby.

### Blanking the screen temporarily (AV MUTE)

The video and audio signals are temporarily muted when the AV MUTE button is pressed. You will hear an operating sound inside the projector. To cancel muting, press the AV MUTE button again.

- The audio from the AUDIO OUT terminal is also muted by pressing the AV MUTE button.
- Mute can not be disabled by AV MUTE button while Intelligent glare sensor is working.
- The AUTO POWER OFF function does not work during AV MUTE.

### AUTO POSITION button

When the image supplied from the computer is displaced, carry out the following procedure.

1. Project a bright image containing as many texts and characters as possible.
2. When the screen saver has been enabled, disable it.
3. Press the AUTO POSITION button.

The projector automatically makes optimum positional settings for the input signal.

- If the projected image is still displaced even after pressing the AUTO POSITION button several times, refer to the procedure to adjust computer images. (See pages 37 and 38.)
- When you carry out this procedure with a dark image, the image may be displaced.

### When connecting to a laptop computer:

When the projector is connected to a laptop computer, images may not be projected in some cases. In such cases, set the computer so that it can output signals externally. The setting procedure varies depending on the type of the computer. See the instruction manual of your computer.

### Example of the setting procedure for external output

Press the [Fn] key and any of the keys [F1] to [F12] at the same time. (The key to be pressed depends on the type of the computer you use.)

### Setting of the resolution

If the resolution of the computer doesn't match with that of the projector, projected images may be obscured. Ensure that their resolutions are the same (see pages 72 and 73). For the method to change the output resolution of the computer, contact the manufacturer of the computer.

## Basic operation (continued)

### Setting the aspect ratio







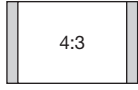

You can change the aspect ratio of the input video signal (or the ratio of width to height of the image). Change the setting according to the type of the screen to be used or your preference.

#### How to change the settings:

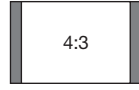
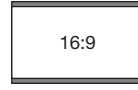
##### With the remote control:

1. Press the ASPECT button.

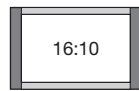
- Every time the ASPECT button is pressed, the aspect mode changes from NORMAL (FULL) to NORMAL (16:9), to NORMAL (4:3), to 16:9, to FULL, and back to NORMAL (FULL).
- The following table shows the image display patterns depending on the settings.

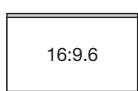
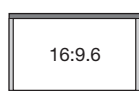
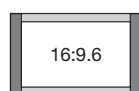
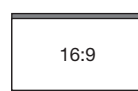
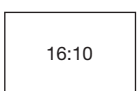
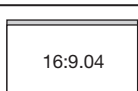
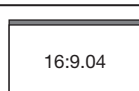
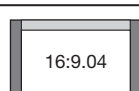
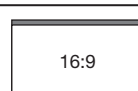
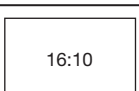
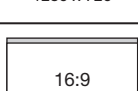
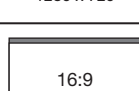
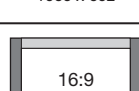
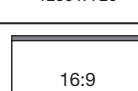
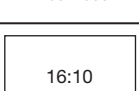
Setting	NORMAL (FULL)	NORMAL (16:9)	NORMAL (4:3)	16:9	FULL
Input signal	Input video signal is displayed at the max height (800 pixels) or max width (1280 pixels) of the panel while its aspect ratio is maintained.	Select this setting when using a 16:9 screen.	Select this setting when using a 4:3 screen.	Regardless of the type of input signal, image is displayed at 16:9 aspect ratio (1280 x 720 pixels). Select to expand squeezed (or horizontally compressed) images such as DVD images to 16:9.	Regardless of the type of input signal, image is displayed at the full panel size (1280 x 800 pixels).
4:3 signal, XGA signal (1024 x 768), etc.	 1066 x 800	 960 x 720	 1066 x 800	 1280 x 720	 1280 x 800
WXGA signal 1280 x 800 (16:10)	 1280 x 800	 1152 x 720	 1066 x 666	 1280 x 720	 1280 x 800
WXGA signal 1280 x 768 (16:9.6)	 1280 x 768	 1200 x 720	 1066 x 640	 1280 x 720	 1280 x 800
WXGA signal 1360 x 768 (16:9.04)	 1280 x 720	 1280 x 720	 1066 x 602	 1280 x 720	 1280 x 800
16:9 signal and WXGA signal 1366 x 768	 1280 x 720	 1280 x 720	 1066 x 600	 1280 x 720	 1280 x 800

#### With the FEATURE menu:

(See page 26 for menu setting.)

1. Display the FEATURE menu.
2. Select ASPECT by pressing the ▲ or ▼ button.
3. Select your desired aspect ratio by pressing the ◀ or ▶ button.

When 16:9  is selected with the FEATURE menu, you can select whether or not to display signals at 16:9 depending on their type using the following procedures.

4. Press the ENTER button.
5. Select a setting for the item MODE by pressing the ◀ or ▶ button.

- ALL SIGNALS:  
All signals are always displayed at 16:9 irrespective of their type.
- VIDEO ONLY:  
Signals supplied from video devices only are displayed at 16:9.

To cancel the menu:

6. Press the MENU button.

#### Important:

- If you change the aspect ratio to 16:9, or FULL while displaying images on a 4:3 screen with the aspect ratio set to NORMAL (4:3), images appear partly off screen.
- When the input video signal is interrupted with NORMAL (16:9) or NORMAL (4:3) selected, the image turns blue and appears partly off screen. In this case, set BACK COLOR in the INSTALLATION menu to BLACK.

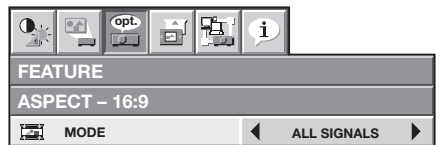
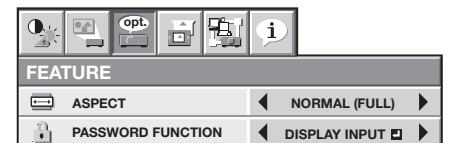

## Basic operation (continued)

### Watching 3D content

You can enjoy 3D content with this projector. In order to watch 3D content, you need to have the following items:

- 3D images inputted from a computer, DVD player, Blu-ray player, etc.
- DLP™ Link™ active 3D glasses

This projector supports the following 3D image formats:

- **Frame packing:**  
The format which transmits the images maintaining the original resolution including the signals for right and left.
- **Side by side:**  
The format which displays the images with the half of the original resolution for the left eye and the right eye side-by-side in one frame.
- **Top and bottom:**  
The format which displays the images with the half of the original resolution for the left eye and the right eye at the top and bottom in one frame.
- **Frame sequential (Field sequential):**  
The format which displays alternately the images for the left eye and the right eye.

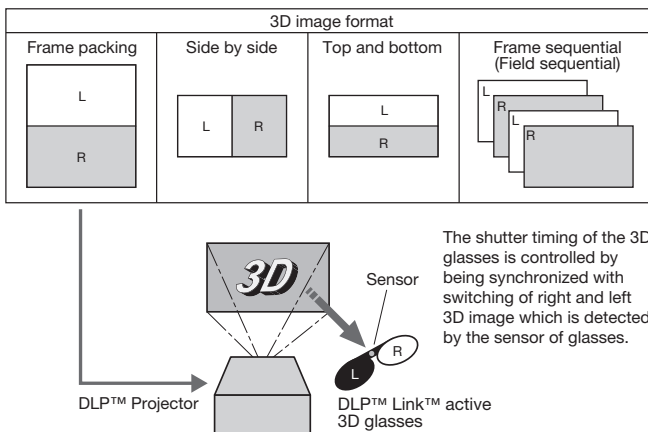

For details about the supported 3D image signal formats, see pages 72 and 73.

### To view 3D images:

#### Preparation:

- Switching the 3D mode (such as 3D setting system) of the player may be required when projecting 3D images from the player supporting 3D display. Read the user manual of the player for details.
1. Project a 3D image on the screen inputted from a computer, DVD player, or Blu-ray player.
  2. Display the IMAGE menu. (See page 26 for menu setting.)
  3. Press the ▲ or ▼ button to select 3D.
  4. Press the ◀ or ▶ button to select ON.
  5. Press the ENTER button.

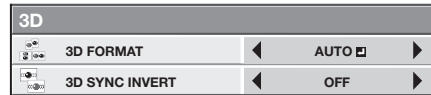

6. Press the ▲ or ▼ button to select 3D FORMAT.



7. Press the ◀ or ▶ button to select the setting appropriate for the input signal and press the ENTER button.
  - **AUTO** : (for HDMI input only)  
Select this setting normally when 3D images are inputted from the HDMI terminal. (3D images are displayed automatically when the input signal includes the 3D identification signal.)
  - **SIDE BY SIDE** : (for HDMI input only)  
Select this setting when 3D images are inputted in the side by side format.
  - **TOP AND BOTTOM** :  
Select this setting when 3D images are inputted in the top and bottom format.
  - **FRAME SEQUENTIAL** :  
Select this setting when 3D images are inputted in the frame sequential format.
8. Turn the power switch on the 3D glasses to ON and wear the 3D glasses.
9. If the contents are not projected correctly, repeat step 1 to 5, press the ▲ or ▼ button to select 3D FORMAT and switch 3D SYNC INVERT to ON.



#### Important:

- You can select the 3D setting also by using the 3D button on the remote control. Press the 3D button to select the setting and press the ENTER button.
- Even when the 3D option is set to AUTO and a 3D image is inputted from the HDMI terminal, the 3D image is not displayed if the input signal does not include the 3D identification signal. In such a case, change the setting to SIDE BY SIDE, TOP AND BOTTOM, or FRAME SEQUENTIAL according to the format of the input signal.
- You cannot project the 3D content from the input source LAN DISPLAY and USB VIEWER.
- If the viewing distance is nearer than the recommended distance, it will cause physical discomfort and eye fatigue.

## ***Basic operation (continued)***

---

### **Caution:**

#### **Notes on danger to public health during watching 3D image**

- Stop viewing the 3D image immediately if you feel tired, discomfort, or any other abnormality. It may cause you to feel unwell if continuing to watch the 3D image in such cases. Please take the necessary rest, do not continue to watch the 3D image for a long time. Stop using the 3D glasses if you can clearly see double images when viewing 3D content. Prolonged use may cause eye strain.
- The following people should not view 3D images.
  - photosensitive patient
  - patient with heart disease
  - epilepsy patient
  - person in poor physical condition
  - person who is deprived of sleep
  - person who is drunk
  - expectant mother
- When watching 3D movies, take an appropriate break after watching a movie. When watching 3D content on interactive devices such as 3D games or computers, take an appropriate break every 30-60 minutes. Prolonged use may cause eye strain.
- When you feel uncomfortable, stop viewing 3D images or playing 3D games until you recover. If necessary, consult a doctor. Also, do not drive a car until you recover (for about 2 hours). The period to recover varies with individuals.
- As a guide, 3D glasses should not be used by children younger than 5 years old. As young children do not show noticeable symptoms of fatigue or discomfort, their physical condition may deteriorate suddenly. When this product is used by a child, the parent or guardian should pay attention to whether the child has eye strain or any change in his/her physical condition.
- If you feel discomfort or any abnormal symptom while viewing rotating, swinging, or fast-moving images, look away from the screen and stop gazing at the displayed images.
- While using the 3D glasses, be careful not to strike the screen or other people by mistake. As the images are in 3D, you may mistake the distance from the screen and strike the screen, resulting in injury. When using the 3D glasses, do not place breakable objects near the glasses. You may try to move by mistaking the 3D objects you are viewing as the real objects, causing damages to surrounding objects that may lead to injury.
- When using the 3D glasses, make sure your eyes are on an approximate horizontal level. If you suffer from myopia (short sightedness), hyperopia (farsightedness), astigmatism, or have eyesight differences between the left and right eyes, please use corrective glasses or other such methods to correct your eyesight before putting on the 3D glasses.
- When you view 3D images, keep a distance from the screen about three times the height of the screen.

# Menu operation

You can make various settings using the displayed menus.  
Following 6 menus are displayed.

## IMAGE menu (pages 27 and 28)

IMAGE		
	COLOR ENHANCER	AUTO
	CONTRAST	0
	BRIGHTNESS	0
	COLOR TEMP.	STANDARD
	COLOR MANAGEMENT	AUTO
	COLOR	0
	TINT	0
	SHARPNESS	0
	3D	ON <input checked="" type="checkbox"/>
	ADVANCED MENU	ENTER <input checked="" type="checkbox"/>

## INSTALLATION menu (pages 28 and 29)

INSTALLATION		
	SILENT MODE	OFF
	STANDBY MODE	LOW
	AUDIO INPUT (STANDBY)	LAST INPUT
	AUDIO INPUT (PROJECTION)	AUTO
	VOLUME ADJUSTMENT	PROJECTION ONLY
	AUTO POWER ON	OFF
	AUTO POWER OFF	5min
	IMAGE REVERSE	OFF
	AUTO KEYSTONE	OFF
	ADVANCED MENU	ENTER <input checked="" type="checkbox"/>

## FEATURE menu (page 30)

FEATURE		
	ASPECT	NORMAL (FULL)
	PASSWORD FUNCTION	DISPLAY INPUT <input checked="" type="checkbox"/>
	MENU POSITION	1.
	CINEMA MODE	AUTO
	VIDEO SIGNAL	AUTO
	SIGNAL DETECT	NORMAL (WXGA)
	SETUP	AUTO
	LANGUAGE	English
	HIGH ALTITUDE MODE	STANDARD <input checked="" type="checkbox"/>
	RESET ALL	OK <input checked="" type="checkbox"/>

## SIGNAL menu (page 31)

SIGNAL		
	MEMORY CALL	AUTO
	RESOLUTION (MEMORIZE)	1024 x 768 <input checked="" type="checkbox"/>
	HORIZ. POSITION	0
	VERT. POSITION	0
	FINE SYNC.	0
	TRACKING	0
	COMPUTER INPUT	AUTO
	OVER SCAN	100%
	HOLD	ON <input checked="" type="checkbox"/>
	USER	ENTER <input checked="" type="checkbox"/>

## NETWORK menu (page 32)

NETWORK		
	PROJECTOR NAME	<input checked="" type="checkbox"/>
	NETWORK CERTIFICATION	ON <input checked="" type="checkbox"/>
	NETWORK PASSWORD	ENTER <input checked="" type="checkbox"/>
	IP CONFIG	ENTER <input checked="" type="checkbox"/>
	WIRELESS SETTING	ENTER <input checked="" type="checkbox"/>
	AMX DEVICE DISCOVERY	OFF <input checked="" type="checkbox"/>
	NETWORK RESET	OK <input checked="" type="checkbox"/>
	NETWORK RESTART	OK <input checked="" type="checkbox"/>

## INFORMATION menu (page 33)

INFORMATION		
	LIGHT SOURCE HOURS	10H
	INPUT	COMPUTER1
	RESOLUTION	1024 x 768
	VERTICAL FREQUENCY	60.00 Hz
	HORIZONTAL FREQUENCY	48.36 kHz
	SYNC. TYPE	5WIRE

## Menu operation (continued)

### How to set the menus

1. Press the MENU button.
  - The menu selection bar is displayed.

Selectable menus are displayed by icons. (The menu icon being selected is displayed on a blue background.)

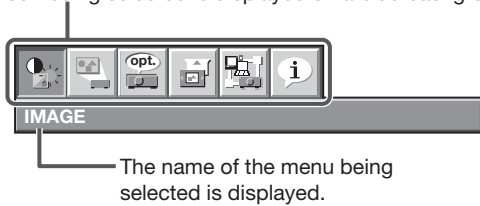

2. Press the ◀ or ▶ button to select a menu to use.
3. Press the ENTER button (or ▼ button).
  - The selected menu is displayed.

The item being selected is displayed in red letters.

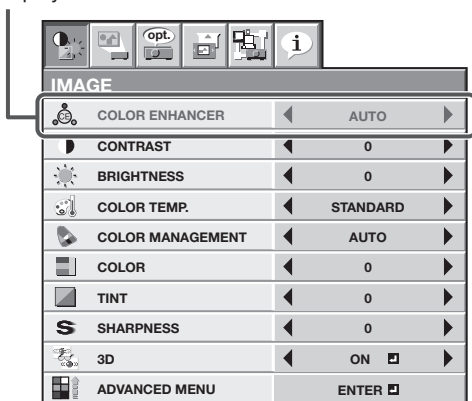

4. Press the ▲ or ▼ button to select an item to adjust.

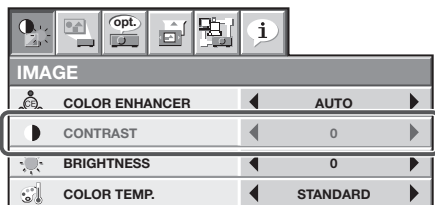

5. Set the selected item by pressing the ◀ or ▶ button.

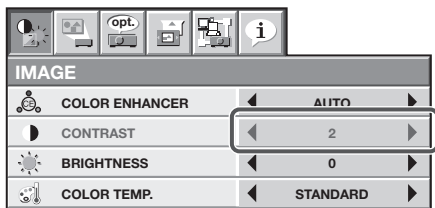

6. To cancel the menu, press the MENU button several times.

#### Important:

- When an item marked with "☑" is selected, pressing the ENTER button makes its value effective or displays another screen for further setting.
- When the MENU button doesn't function, unplug the power cord from the wall outlet. Wait about 10 minutes, plug the power cord in, and try again.
- The menus and screens shown in this manual may be different from those of the actual projector.

## Menu operation (continued)

### IMAGE menu

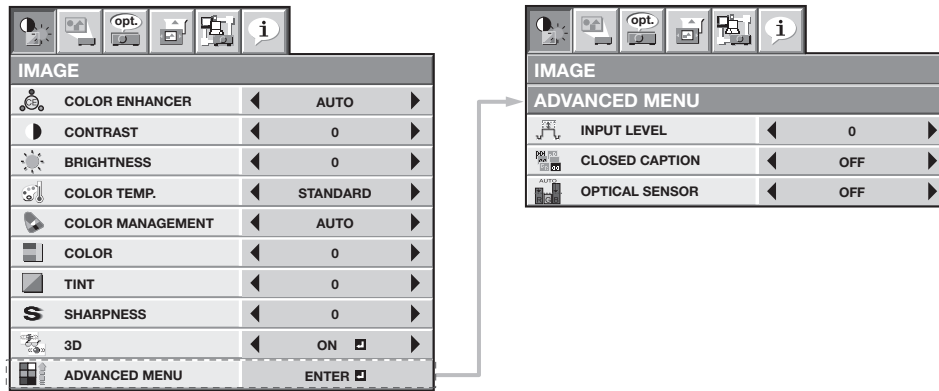

ITEM	SETTING	FUNCTION
COLOR ENHANCER	AUTO	Select to optimize the settings automatically depending on the input signal. (Select this option for normal use.)
	PRESENTATION	Select to make the displayed image look bright and crisp.
	STANDARD	Select to make the displayed image look natural.
	RICH COLOR	This option, suitable for viewing movies, makes the displayed image look soft and smooth.
	sRGB	Select to give priority to the color reproducibility.
	WHITE BOARD	Reproduces natural color tones when images are projected directly onto a white board.
CONTRAST	±30	Use to adjust the contrast of the projected image. (See page 34.)
	±30	Use to adjust the brightness of the projected image. (See page 34.)
BRIGHTNESS	±30	Use to adjust the brightness of the projected image. (See page 34.)
	±30	Use to adjust the brightness of the projected image. (See page 34.)
COLOR TEMP.	STANDARD / LOW / HIGH	Select from the predetermined color temperatures.
	STANDARD / LOW / HIGH	Select from the predetermined color temperatures.
COLOR MANAGEMENT	USER	Use to adjust the color temperature to a desired value. (See page 34.)
	AUTO	Select to use the predetermined tone of each color.
	FLAT	COLOR MANAGEMENT doesn't work.
	USER	Select to emphasize only certain colors or to correct the tonal deviation of only certain colors. (See page 36.)
COLOR	±10	Use to adjust the color thickness of the projected image. (See page 34.)
TINT	±10	Use to adjust the color tint of the projected image. (See page 34.)
SHARPNESS	±5	Use to adjust the sharpness of the projected image. (See page 34.)
3D	ON  / OFF	Set to ON/OFF of 3D display.
	AUTO	Automatically distinguishes the type of the input signal and displays 3D images when 3D image signals are inputted or 2D images (normal images) when 2D image signals are inputted (only when the signal from the HDMI terminal is inputted).
3D FORMAT	SIDE BY SIDE	Select this setting when 3D images are inputted in the side by side format.
	TOP AND BOTTOM	Select this setting when 3D images are inputted in the top and bottom format.
	FRAME SEQUENTIAL	Select this setting when 3D images are inputted in the frame sequential format.
3D SYNC INVERT	ON / OFF	Switches the order of the image for left eye and for right eye.



## Menu operation (continued)

### IMAGE menu (continued)

ITEM	SETTING	FUNCTION
ADVANCED MENU	ENTER	The ADVANCED MENU is displayed for the following settings.
INPUT LEVEL	±5	For analog signal input: The input level of video signal differs among devices to be connected. High input level causes solid white in displayed image and low input level causes displayed image to get dark. Use this menu to adjust the input level of analog video signal.
	AUTO / ENHANCED / NORMAL	For HDMI signal input: AUTO: The proper setting is automatically selected. ENHANCED: Select when solid black occurs. NORMAL: Select when grayish black occurs. (See page 16.)
CLOSED CAPTION	OFF CC1 / CC2 / CC3 / CC4 / T1 / T2	Does not display captions. Displays captions.
OPTICAL SENSOR	ON / OFF	Select whether to enable the automatic white balance adjustment by the internal optical sensor. (Select OFF for normal use.) Select ON  and press the ENTER button for the automatic white balance adjustment.

- When COLOR ENHANCER is sRGB, COLOR TEMP., COLOR, TINT and COLOR MANAGEMENT can't be adjusted.
- When the setting of COLOR ENHANCER is changed, the displayed image may be disturbed.
- When the COMPUTER1, COMPUTER2, HDMI, LAN DISPLAY or USB VIEWER is selected as the input source, COLOR and TINT can't be adjusted.
- TINT is available only when the NTSC signal is input.
- INPUT LEVEL is unavailable when the digital signal is supplied from the YCbCr/YpPr terminal of the connected device.
- Captions are not displayed while information about the menu or input signal selection is being displayed on the screen.
- The closed caption function displays text information included in the NTSC signal, which is mainly used for TV broadcasting in North America.

### INSTALLATION menu

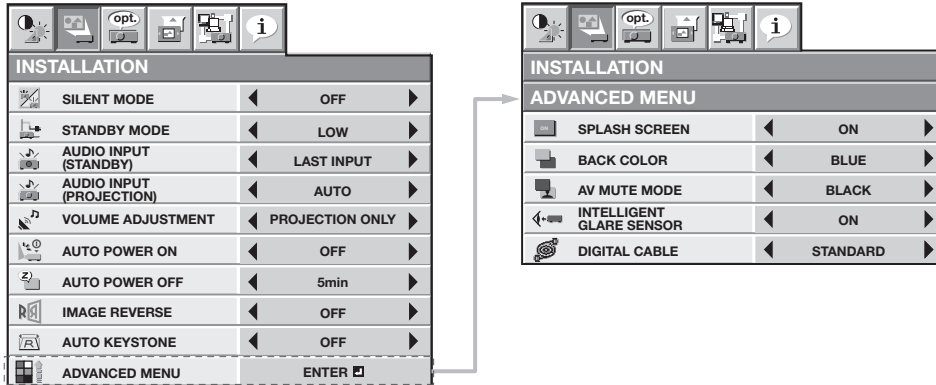

ITEM	SETTING	FUNCTION
SILENT MODE	OFF ON	Select this option when you want to view images in a well-lit room. Select this option to reduce the operating sound. Also, the intensity of the light is moderated.
STANDBY MODE	STANDARD LAN LOW	Select this option when you control the projector via the LAN terminal during power standby. Audio is output from the AUDIO OUT terminal. Video signal is output from the MONITOR OUT terminal. Select this option when you control the projector via the LAN terminal during power standby. Select this option when you don't control the projector via the LAN terminal during power standby. This option disables the LAN terminal and reduces the power consumption during the power standby.
AUDIO INPUT (STANDBY)	OFF LAST INPUT AUDIO1 / AUDIO2 / AUDIO3 MIX	Use this setting to disable audio output during power standby. Use this setting to select the same audio output during power standby as used during projection. (HDMI audio and the audio through LAN are not available during power standby) Selects audio input during power standby. Selects mix signal of AUDIO1 and AUDIO2 during power standby. You can change the balance of AUDIO1/AUDIO2 using MIX .



## Menu operation (continued)

### INSTALLATION menu (continued)

ITEM	SETTING	FUNCTION
AUDIO INPUT (PROJECTION)	AUTO	Selects AUDIO1 when the input source is COMPUTER1, selects AUDIO2 when the input source is COMPUTER2, selects AUDIO3 when the input source is VIDEO/S-VIDEO, and selects HDMI when the input source is HDMI. When the input source is LAN DISPLAY, the audio played on the computer is selected. (See page 39.)
	AUDIO1 / AUDIO2 / AUDIO3	Selects audio input.
	MIX	Selects mix signal of AUDIO1 and AUDIO2. You can change the balance of AUDIO1/AUDIO2 using MIX .
VOLUME ADJUSTMENT	PROJECTION ONLY	Use this setting to adjust the audio volume during projection only.
	PROJECTION AND STANDBY	Use this setting to adjust the audio volume during projection and power standby. (See page 20.)
AUTO POWER ON	OFF / ON	When ON is chosen, the projector turns on automatically when the power cord is plugged in the wall outlet.
AUTO POWER OFF	OFF / 5min-8HOUR	When no video signal is input and no operation is made, the projector automatically turns off after the selected time period. A dialog is displayed 5 minutes before the projector turns off.
IMAGE REVERSE	OFF	Select when viewing images projected from in front of the screen with the projector installed on the floor.
	MIRROR	Select when viewing images projected from behind the screen with the projector installed on the floor.
	INVERT	Select when viewing images projected from behind the screen with the projector installed on the ceiling.
	MIRROR INVERT	Select when viewing images projected from front of the screen with the projector installed on the ceiling.
AUTO KEYSTONE	OFF / ON	Choose ON to automatically correct the distorted image.
ADVANCED MENU	ENTER	The ADVANCED MENU is displayed for the following settings.
SPLASH SCREEN	ON / OFF	Choose ON or OFF to display the splash screen when the power is turned on.
BACK COLOR	BLUE / BLACK / IMAGE	Use to select the background from among BLUE, BLACK and IMAGE, which will be displayed when there is no signal input from the source. When IMAGE is selected, the splash screen will be displayed.
AV MUTE MODE	BLACK / IMAGE	Use to select the background when the MUTE button is pressed.
INTELLIGENT GLARE SENSOR	OFF / ON	Choose OFF when you intend to disable the function.
DIGITAL CABLE	STANDARD	Select STANDARD for normal use.
	FINE ADJ1 / FINE ADJ 2	Use to adjust the amount of transmission signal correction when a long cable is used.

- The setting of SILENT MODE can be changed by pressing the SILENT MODE button on the remote control.
- The audio of AUDIO1, AUDIO2, AUDIO3, and MIX cannot be selected when the input source is HDMI. (HDMI audio is selected.)
- The AUTO POWER OFF function does not work during AV MUTE.

## Menu operation (continued)

### FEATURE menu

FEATURE	
ASPECT	NORMAL (FULL)
PASSWORD FUNCTION	DISPLAY INPUT
MENU POSITION	1.
CINEMA MODE	AUTO
VIDEO SIGNAL	AUTO
SIGNAL DETECT	NORMAL (WXGA)
SETUP	AUTO
LANGUAGE	English
HIGH ALTITUDE MODE	STANDARD
RESET ALL	OK

ITEM	SETTING	FUNCTION
ASPECT	NORMAL (FULL)	Input video signal is displayed at the max height (800 pixels) or max width (1280 pixels) of the panel while its aspect ratio is maintained.
	NORMAL (16:9)	Select this setting when using a 16:9 screen.
	NORMAL (4:3)	Select this setting when using a 4:3 screen.
	16:9	Regardless of the type of input signal, image is displayed at 16:9 aspect ratio (1280 x 720 pixels). Select to expand squeezed (or horizontally compressed) images such as DVD images to 16:9. Press the ENTER button to select whether or not to display signals at 16:9 depending on their type. (See page 22.)
	FULL	Select to project images in full size (1280 x 800 pixels) irrespective of type of input signal.
PASSWORD FUNCTION	DISPLAY INPUT / MENU ACCESS / SPLASH ID SCREEN	Use to enable or cancel the password lock. See page 61 for details.
MENU POSITION	1 (upper left) / 2 (center) / 3 (lower right)	Use to change the position of the menu.
CINEMA MODE	AUTO	The film mode will be automatically activated when a film source signal is input. (Select AUTO for normal use.)
	OFF	The film mode will not be activated.
VIDEO SIGNAL	AUTO / NTSC / PAL / SECAM / 4.43NTSC / PAL-M / PAL-N / PAL-60	When AUTO is selected, the appropriate video format is automatically selected depending on the input signal. If the image isn't displayed correctly, select the desired video format manually.
SIGNAL DETECT	NORMAL (WXGA)	Select this setting for wide picture.
	NORMAL (XGA)	Select this setting for other than wide picture.
	ENHANCED	Select this setting when the NORMAL mode does not display images properly.
SETUP	AUTO	Select to change the SETUP mode automatically.
	OFF	Select to make black lighter.
	3.75% / 7.5%	Select to make black thicker. <ul style="list-style-type: none"> <li>When 7.5% is chosen, the brightness is decreased by the setup cancel function for the U.S. Choose OFF when the image is dark.</li> </ul>
LANGUAGE	日本語 / English / Español / Deutsch / Français / Italiano / 中文 / 한국어 / РУССКИЙ / PORTUGUÊS / SVENSKA / POLSKI / MAGYAR / اللغة العربية / Türkçe / ภาษาไทย / Bahasa Indonesia / Melayu	Use to select the language used in the menus.
HIGH ALTITUDE MODE	STANDARD	Select this option for normal use.
	HIGH ALTITUDE	Select this option for use at an altitude of 1500 to 2700 meters above the sea level.
RESET ALL	OK	The menu settings are reset to the factory defaults (except the LANGUAGE, PASSWORD FUNCTION and NETWORK settings).

- CINEMA MODE can be adjusted only when a TV60, TV50, 480i, 576i or 1080i signal is being displayed.
- The RESET ALL process may take some time to complete.

# Menu operation (continued)

## SIGNAL menu

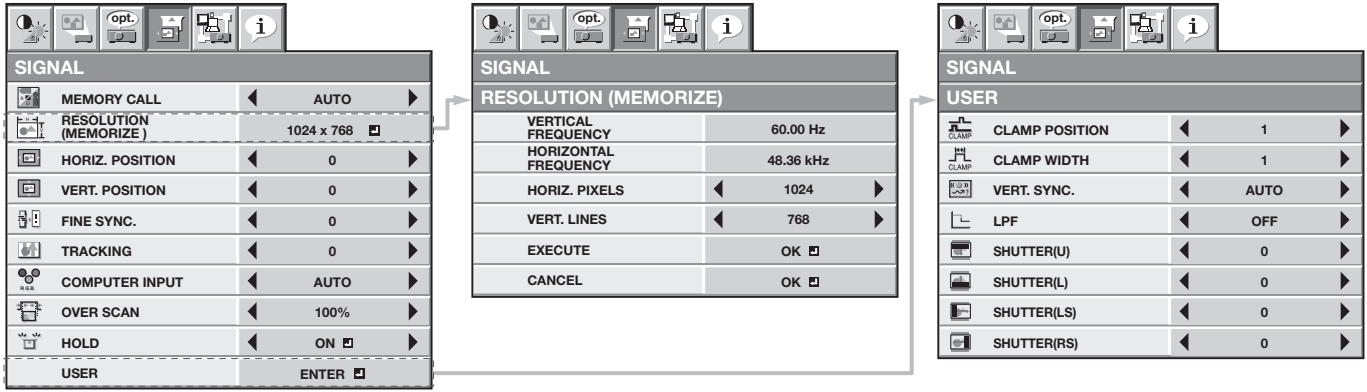

ITEM	SETTING	FUNCTION
MEMORY CALL	AUTO / MEMORY 1  - MEMORY 8	Use to select the setting of RESOLUTION (MEMORIZE) already saved. Impossible to select if no setting has been saved. AUTO is selected by default. It optimizes the signal format automatically depending on the type of video signal supplied from the computer. Press the ENTER button to clear the setting already saved.
RESOLUTION (MEMORIZE)	1024 x 768	The current resolution is displayed. To change the current setting, press the ENTER button to display the RESOLUTION (MEMORIZE) menu. The new setting can be saved to MEMORY 1 - MEMORY 8.
VERTICAL FREQUENCY	-	The vertical frequency of the currently projected video signal is displayed.
HORIZONTAL FREQUENCY	-	The horizontal frequency of the currently projected video signal is displayed.
HORIZ. PIXELS	640-1920	The number of horizontal pixels of the currently projected video signal is displayed. When you change the current setting, select EXECUTE, and then press the ENTER button, the image is automatically adjusted according to the resolution you set. The adjustment result can be saved to MEMORY 1 - MEMORY 8.
VERT. LINES	360-1200	The number of vertical lines of the currently projected video signal is displayed. When you change the current setting, select EXECUTE, and then press the ENTER button, the image is automatically adjusted according to the resolution you set. The adjustment result can be saved to MEMORY 1 - MEMORY 8.
EXECUTE	OK	Press the ENTER button to start the automatic adjustment. At the completion of the automatic adjustment, a message is displayed and you can save the adjustment result to MEMORY 1 - MEMORY 8.
CANCEL	OK	The process to change the current resolution is canceled and the SIGNAL menu is displayed.
HORIZ. POSITION	0-999	Use to adjust the horizontal position of the projected image.
VERT. POSITION	0-999	Use to adjust the vertical position of the projected image.
FINE SYNC.	0-31	Use to eliminate flickering or blur, if appears, viewing the projected image.
TRACKING	0-2800	Use to eliminate vertical wide stripes, if appears, viewing the projected image.
COMPUTER INPUT	AUTO / RGB / YC <sub>B</sub> C <sub>R</sub> /YP <sub>B</sub> P <sub>R</sub>	The proper setting is automatically selected. Select this option when connecting the projector to high definition video equipment having R, G, and B output terminals. Select this option when connecting the projector to a DVD player or other device having Y, C <sub>B</sub> , and C <sub>R</sub> (or Y, P <sub>B</sub> , and P <sub>R</sub> ) component video output terminals.
OVER SCAN	100%-90%	Use to adjust the display area of projected image.
HOLD	OFF / ON	Use to adjust the image when flagging occurs near the top of the screen.
USER	ENTER	The USER menu is displayed for the following adjustments.
CLAMP POSITION	1-255	Use to correct solid white or solid black in the projected image.
CLAMP WIDTH	1-63	Use to correct solid black in the projected image.
VERT. SYNC.	AUTO / OFF	Use to adjust the image when its motion doesn't run smoothly. Select AUTO for normal use.
LPF	ON / OFF	Use to select whether or not to enable the LPF. (See page 38.)
SHUTTER(U)	0-20	Use to adjust the image when noise appears on the top part of the image.
SHUTTER(L)	0-20	Use to adjust the image when noise appears on the bottom part of the image.
SHUTTER(LS)	0-20	Use to adjust the image when noise appears on the left half of the image.
SHUTTER(RS)	0-20	Use to adjust the image when noise appears on the right half of the image.

- Though horizontal strips may appear on the enlarged projected image, such symptom is not a malfunction.
- When you change the horizontal or vertical position to a large extent, noise may appear.
- The adjustable range of the vertical position varies depending on the type of the input signal. Though the image may stay in the same position even when the setting value is changed, such symptom is not a malfunction.
- SHUTTER will not work correctly during keystone adjustment.
- When you increase the setting value of OVER SCAN, noise may appear on the screen.
- Menus may not be displayed partially depending on the settings of HORIZ. PIXELS and VERT. LINES in the RESOLUTION (MEMORIZE) menu. In this case, execute AUTO POSITION. (See page 21.)

**Important:**

- You can set the IMAGE menu and the SIGNAL menu only when the signal is supplied.

## Menu operation (continued)

### NETWORK menu

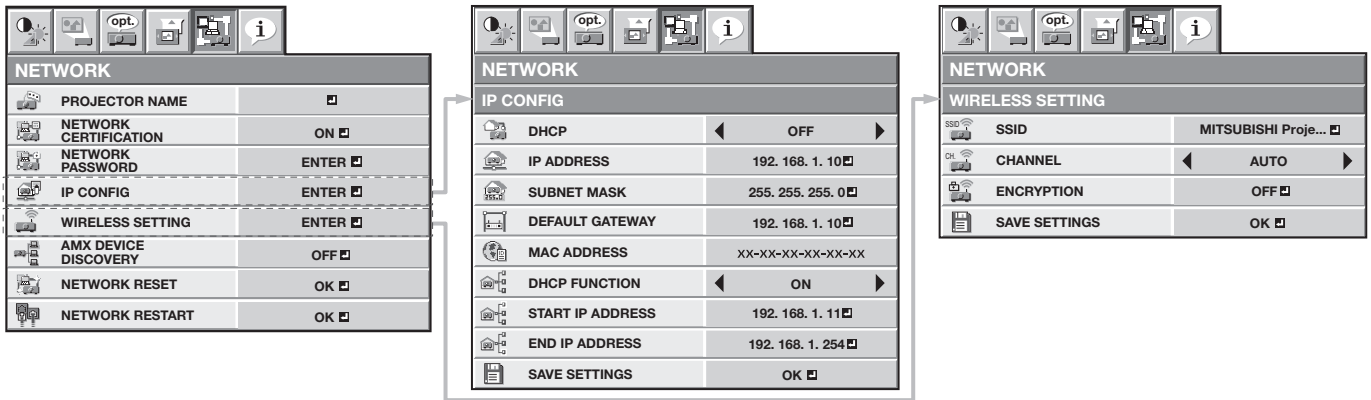

ITEM	SETTING	FUNCTION
PROJECTOR NAME	**** ...	Set the name to identify the projector. Enter up to 15 characters (alphabets or numeric characters). (See page 40.)
NETWORK CERTIFICATION	ON / OFF	Select whether to enable the network certification or not. Select ON for normal use. (See page 40.)
NETWORK PASSWORD	ENTER	Set the password for the certification of PLink™, ProjectorView Global+ and remote control via LAN. (See page 40.)
IP CONFIG	ENTER	Select this setting for IP Configuration. (See page 41.)
DHCP	ON	Select this setting when you obtain IP CONFIG automatically by DHCP server.
IP ADDRESS	OFF	Select this setting when you set IP CONFIG manually.
SUBNET MASK	***.***.***.***	Press the ENTER button to set IP ADDRESS. When DHCP is set to ON, you cannot change this setting.
DEFAULT GATEWAY	***.***.***.***	Press the ENTER button to set SUBNET MASK. When DHCP is set to ON, you cannot change this setting.
MAC ADDRESS	XX-XX-XX-XX-XX-XX	Press the ENTER button to set DEFAULT GATEWAY. When DHCP is set to ON, you cannot change this setting.
DHCP FUNCTION	ON / OFF	Displays MAC ADDRESS.
START IP ADDRESS	***.***.***.***	Use this setting when using the projector as a DHCP server.
END IP ADDRESS	***.***.***.***	Press the ENTER button to set START IP ADDRESS. When DHCP is set to ON or DHCP FUNCTION is set to OFF, you cannot change this setting.
SAVE SETTINGS	OK	Press the ENTER button to set END IP ADDRESS. When DHCP is set to ON or DHCP FUNCTION is set to OFF, you cannot change this setting.
WIRELESS SETTING	ENTER	Saves the IP CONFIG settings. When the IP CONFIG is not changed, you cannot select SAVE SETTINGS.
SSID	*****...	Select this setting for wireless configuration. (See page 44.)
CHANNEL	AUTO / 1 / 2 / 3 / 4 / 5 / 6 / 7 / 8 / 9 / 10 / 11	Set SSID. Enter up to 32 character alphabets (capital/small), numeric characters, or marks.
ENCRYPTION	OFF / WEP 128bit(ASCII) / WEP 64bit(ASCII) / WEP 128bit(HEX) / WEP 64bit(HEX) / WPA-PSK(ASCII) / WPA-PSK(ASCII) / WPA-PSK(HEX) / WPA-PSK(HEX) / WPA2-PSK(HEX)	Select the wireless channel.
SAVE SETTINGS	OK	Select the wireless encrypted communication.
AMX DEVICE DISCOVERY	OFF / ON	Saves the WIRELESS SETTING settings. When the WIRELESS SETTING is not changed, you cannot select SAVE SETTINGS.
NETWORK RESET	OK	Use this setting when using an AMX controller.
NETWORK RESTART	OK	Resets the Network Setting. (See page 45.)
		Press the ENTER button to restart the network function.

## Menu operation (continued)

### INFORMATION menu



INFORMATION	
LIGHT SOURCE HOURS	10H
INPUT	COMPUTER1
RESOLUTION	1024 x 768
VERTICAL FREQUENCY	60.00 Hz
HORIZONTAL FREQUENCY	48.36 kHz
SYNC. TYPE	5WIRE

ITEM	DESCRIPTION
LIGHT SOURCE HOURS	This item shows the light source operation time.
INPUT	Indicates the name of the terminal to which the currently projected video signal is being input.
RESOLUTION	Indicates the resolution of the currently projected video signal.
VERTICAL FREQUENCY	Indicates the vertical frequency of the currently projected video signal.
HORIZONTAL FREQUENCY	Indicates the horizontal frequency of the currently projected video signal.
SYNC. TYPE	Indicates the type of the sync signal for the currently projected video signal.

# Adjusting projected images

## To adjust the brightness (CONTRAST and BRIGHTNESS):

You can make adjustments for the brightness of the projected image using the menu.  
(See page 26 for menu setting.)

1. Display the IMAGE menu.
2. Select CONTRAST or BRIGHTNESS by pressing the ▲ or ▼ button.
3. Adjust the selected item by pressing the ◀ or ▶ button.

### To cancel the menu:

4. Press the MENU button.

### CONTRAST

Select to adjust the contrast of the image. Every time the ▶ button is pressed, the image becomes brighter and more defined. Every time the ◀ button is pressed, the image becomes darker and less defined.

### BRIGHTNESS

Every time the ▶ button is pressed, the image becomes brighter. Every time the ◀ button is pressed, the image becomes darker.

## To adjust the color (COLOR and TINT):

You can adjust the color of the projected image using the menu.  
(See page 26 for menu setting.)

1. Display the IMAGE menu.
2. Select COLOR or TINT by pressing the ▲ or ▼ button.
  - COLOR or TINT is unavailable when COMPUTER1, COMPUTER2, HDMI, LAN DISPLAY or USB VIEWER is selected as the input source.
  - TINT is available only when the NTSC signal is input.
3. Adjust the selected item by pressing the ◀ or ▶ button.

### To cancel the menu:

4. Press the MENU button.

### COLOR

Use to adjust the color thickness of the projected image. Every time the ▶ button is pressed, the color becomes thicker. Every time the ◀ button is pressed, the color becomes lighter.

### TINT

Use to adjust the tint of the projected image. Every time the ▶ button is pressed, the image appears more greenish. Every time the ◀ button is pressed, the image appears more reddish.

## To sharpen or soften the projected image (SHARPNESS):

You can adjust the sharpness of the projected image using the menu.  
(See page 26 for menu setting.)

1. Display the IMAGE menu.
2. Select SHARPNESS by pressing the ▲ or ▼ button.
3. Adjust the selected item by pressing the ◀ or ▶ button.

### To cancel the menu:

4. Press the MENU button.

## To adjust the tone of white (COLOR TEMP.):

You can select a preset color temperature (white tone) using the menu.  
(See page 26 for menu setting.)

1. Display the IMAGE menu.
2. Select COLOR TEMP. by pressing the ▲ or ▼ button.
3. Select your desired color temperature by pressing the ◀ or ▶ button.



### To cancel the menu:

4. Press the MENU button.

### To adjust the tone of white (To customize the color temperature):

To customize (and store) the color temperature to your preference, carry out the following procedure.  
(See page 26 for menu setting.)

1. Select COLOR TEMP. in the IMAGE menu.
2. Press the ◀ or ▶ button to select USER .
3. Press the ENTER button.
4. Press the ▲ or ▼ button to select the desired item.
5. Press the ◀ or ▶ button to adjust the selected item.
6. Repeat steps 4 and 5 for optimum adjustment results.

COLOR TEMP.-USER		
▶	CONTRAST R	◀ 0 ▶
▶	CONTRAST G	◀ 0 ▶
▶	CONTRAST B	◀ 0 ▶
	BRIGHTNESS R	◀ 0 ▶
	BRIGHTNESS G	◀ 0 ▶
	BRIGHTNESS B	◀ 0 ▶

## Adjusting projected images (continued)

### To cancel the menu:

- Press the MENU button.

### To enable the stored color temperature:

- Set COLOR TEMP. to USER  in the IMAGE menu.

### About color temperature

Color temperature is a way to show the differences in white. White of which temperature is low appears reddish. When the color temperature rises, white appears bluish. For example, you can change the color temperature using the following procedures.

To raise the color temperature: Increase the CONTRAST B (blue) and decrease the CONTRAST R (red).

To reduce the color temperature: Decrease the CONTRAST B (blue) and increase the CONTRAST R (red).

- If you set all of CONTRAST R, G, and B to negative values, the original brightness of the image can't be obtained even when you maximize CONTRAST in the IMAGE menu.

## COLOR ENHANCER

You can set the user-defined balance between the brightness and hue using the menu.

(See page 26 for menu setting.)

### With the IMAGE menu:

- Display the IMAGE menu.
- Select COLOR ENHANCER by pressing the ▲ or ▼ button.
- Select USER  by pressing the ◀ or ▶ button.
- Press the ENTER button.
  - The detailed menu for the color enhancer is displayed.
- Press the ▲ or ▼ button to select COLOR SYSTEM or GAMMA MODE.
- Press the ◀ or ▶ button to adjust the selected item.



When USER is selected:

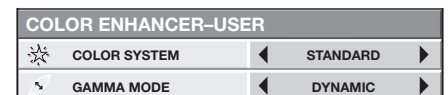

### COLOR SYSTEM

Use this item to change the balance between the brightness and hue.

STANDARD ..... Select when viewing images supplied from the computer.

RICH COLOR ... Select when viewing images of which brightness should be kept relatively low, such as movies and music performance.

DYNAMIC ..... Select when viewing images supplied from the video device.

### GAMMA MODE

Use this item to set the gamma optimally.

DYNAMIC ..... Select when viewing images supplied from the computer.

NATURAL ..... Select when viewing images supplied from the video device.

DETAIL ..... Select when viewing images of which brightness should be kept relatively low, such as movies and music performance.

### Important:

- You can adjust COLOR ENHANCER also by pressing the COLOR.E button on the remote control.

With the remote control:

- Press the COLOR.E button on the remote control.
  - A window for color enhancer adjustment appears on the upper right of the screen.
- Press the ◀ or ▶ button to select USER .
- Press the ENTER button.
- Press the ▲ or ▼ button to select COLOR SYSTEM or GAMMA MODE.
- Press the ◀ or ▶ button to adjust the selected item.



## Adjusting projected images (continued)



### Adjusting the tone of each color (COLOR MANAGEMENT):



You can individually adjust the tone of red, green, blue, cyan, yellow, magenta and white using the menu.

1. Display the IMAGE menu.
2. Press the ▲ or ▼ button to select COLOR MANAGEMENT.
3. Select USER  by pressing the ◀ or ▶ button.
4. Press the ENTER button.
5. Press the ◀ or ▶ button to select a color to be adjusted: RED, GREEN, BLUE, CYAN, YELLOW, MAGENTA or WHITE.
6. Press the ▲ or ▼ button to select an item to be adjusted: GAIN, SATURATION or HUE. (RED, GREEN or BLUE when WHITE is selected in step 5.)
7. Press the ◀ or ▶ button to adjust the item.

#### To cancel the menu:

8. Press the MENU button.

COLOR MANAGEMENT-USER		
COLOR ADJ.	◀	RED ▶
 GAIN	◀	0 ▶
 SATURATION	◀	0 ▶
 HUE	◀	0 ▶

COLOR MANAGEMENT-USER		
COLOR ADJ.	◀	WHITE ▶
 RED	◀	0 ▶
 GREEN	◀	0 ▶
 BLUE	◀	0 ▶



## Adjusting projected images (continued)

### How to adjust the computer image

This projector automatically selects a proper signal format according to the type of video signal supplied from the computer. However, video signals from the computer may not be projected correctly depending on the types of the computer and images to be projected. In such a case, make adjustment according to the flowchart below.

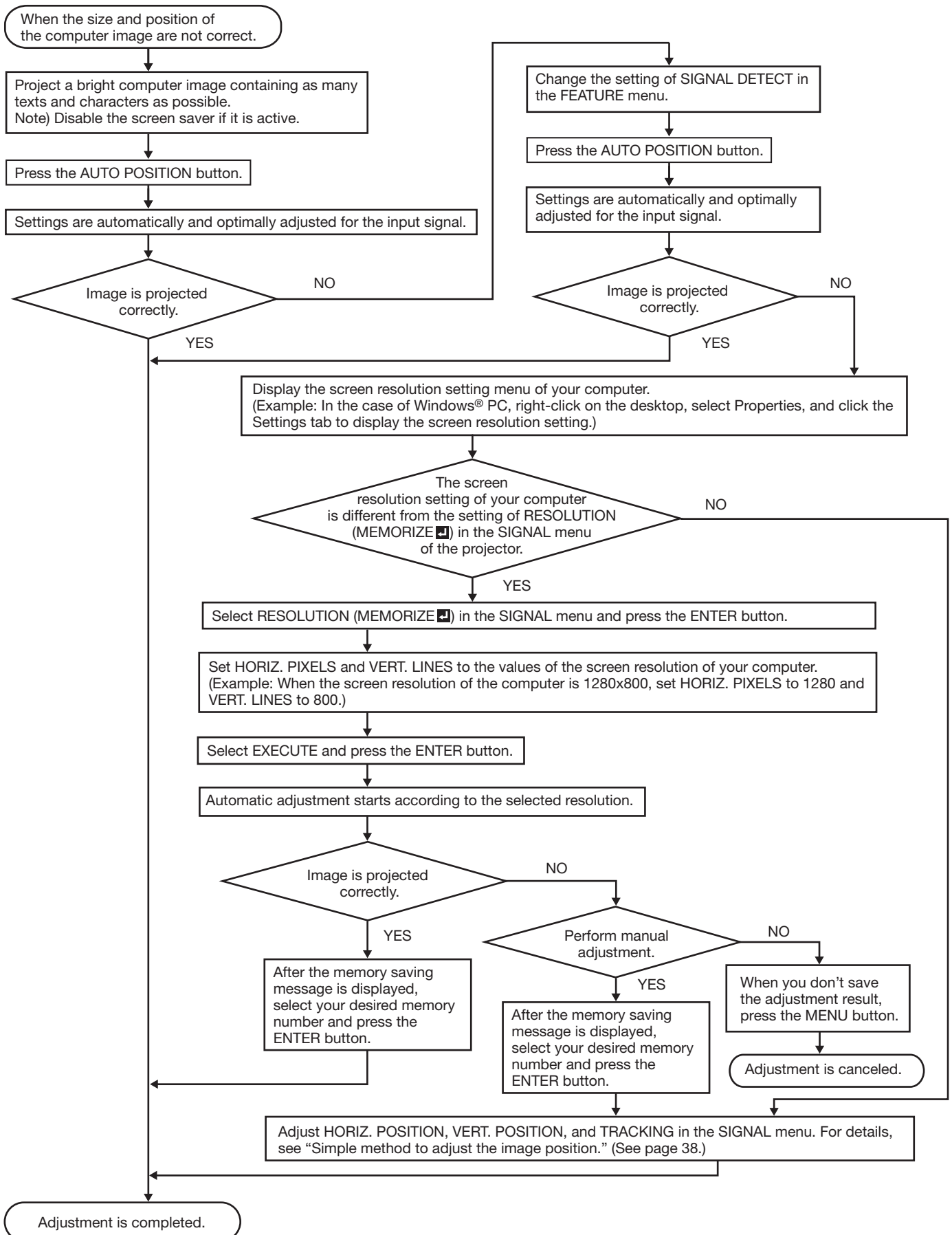

## Adjusting projected images (continued)

### How to adjust the image supplied from the computer using the menu:

Carry out the following procedures according to the symptoms.

- Wide strips appear. .... Adjust TRACKING in the SIGNAL menu.  
The projected image flickers.  
The projected image is blurred.....Adjust FINE SYNC. in the SIGNAL menu.  
The projected image is displaced horizontally. ....Adjust HORIZ. POSITION in the SIGNAL menu. Every time the ◀ button is pressed, the image moves to the right. Every time the ▶ button is pressed, the image moves to the left.  
The projected image is displaced vertically.....Adjust VERT. POSITION in the SIGNAL menu. Every time the ◀ button is pressed, the image moves down. Every time the ▶ button is pressed, the image moves up.  
The top part of the image flags. .... Change the setting of HOLD in the SIGNAL menu. Select ON , press the ENTER button, and adjust BEGIN or END to minimize the flagging.  
A solid black or solid white appears in the image. .... Adjust CLAMP POSITION or CLAMP WIDTH in the SIGNAL - USER menu.  
The motion doesn't run smoothly.....Adjust VERT. SYNC. in the SIGNAL - USER menu. Select AUTO for normal use.  
Noise appears on the right or left half of the image. ....Adjust SHUTTER(LS) or SHUTTER(RS) in the SIGNAL - USER menu.  
Noise appears on the top or bottom part of the image.....Adjust SHUTTER(U) or SHUTTER(L) in the SIGNAL - USER menu.

1. Display the SIGNAL menu.
2. Press the ▲ or ▼ button to select an item to adjust.
3. Adjust the selected item by pressing the ◀ or ▶ button.

#### To cancel the menu:

4. Press the MENU button.
- Do not change the settings of the SIGNAL menu in normal use.

### Simple method to adjust the image position

#### To adjust the horizontal position:

1. Align the left edge of the image with the left side of the screen by adjusting HORIZ.POSITION. Then, align the right edge of the image with the right side of the screen by adjusting TRACKING.
2. Repeat step 1 above to complete the adjustment of the horizontal position.

#### To adjust the vertical position:

3. Align the upper edge of the image with the upper side of the screen by adjusting VERT.POSITION.

### LPF (Progressive filter)

You can select whether or not to enable the LPF.

Vertical or horizontal streak noise may appear on the projected image, depending on the type of the DVD player or game console you use. In such a case, you can reduce such streak noise by enabling the LPF. However, projected images become softened slightly.

# Network Functions of this projector

## Setting and connections

To use the network functions of this projector, change the settings properly if necessary. To change the network settings, refer to the "Initial network settings". For details of the connection, see "LAN control UTILITY operation manual" in the CD-ROM.

When STANDBY MODE of the INSTALLATION menu of the projector is set to LOW, the network function is disabled while the projector is in standby. To enable the network function, set STANDBY MODE to LAN or to STANDARD.

## What you can do with the projector

### Controlling projector via LAN

#### Image projection via LAN

## Controlling projector via LAN

### Controlling by computers

This projector can be controlled by application software such as ProjectorView Global+, which is included in the CD-ROM, or Crestron RoomView, the Web UI, RS-232C commands via LAN, or PJLink™ commands.

- For the details about ProjectorView Global+ and the Web UI, see "LAN control UTILITY operation manual" in the CD-ROM.
- For the details about RS-232C commands via LAN, see the Downloads page of our web site.  
URL: <http://www.mitsubishielectric.com/bu/projectors/downloads/>

### Controlling by network controllers

This projector can be controlled by network controllers supporting PJLink™ or AMX Device Discovery, or network controllers made by Crestron.

For the detail about the control functions, see "Supervising and controlling by computer".

## Image projection via LAN

To use this function, change the input to LAN DISPLAY.

### Image projection from tablet computers or smartphones (WiFi-Doc)

By connecting commercially available USB wireless LAN adapter or by connecting to wireless router, you can project images of the Microsoft PowerPoint, Word, Excel, PDF or TXT format files stored in tablet computers or smartphones.

- In some cases, you can connect tablet computers or smartphones to the projector without changing the initial network settings if you use the projector with a USB wireless LAN adapter. In this case, the projector's initial IP address and SSID is as follows;  
IP address : 192.168.1.10  
SSID : MITSUBISHI Projector
- IP address, subnet mask, default gateway values are the same for both wired LAN and wireless LAN.
- Data are not filtered between wired LAN and wireless LAN interface.
- Some USB wireless LAN adapters cannot be used depending on the specifications.
- By default, no wireless security is enabled. Change the setting of ENCRYPTION in the WIRELESS SETTING menu if needed.

### Projection of computer desktop

You can project computer images by connecting a computer to the projector with LAN Display System, the application software in the CD-ROM. The LAN Display System also enables you to transfer the images to a device with iOS or Android OS.

Also, you can log on to a computer from the projector in case the computer is installed with the Thin Client, the application software in the CD-ROM. With the Thin Client, you can project computer images, listen to the audio played on the computer and control the computer.

- You can listen to the audio played on the computer using the LAN Display System. (For Windows XP, installation of the Virtual Audio Driver is needed to use this function.)

For the detail about the WiFi-Doc, Thin Client and LAN Display System, see "Advanced display utilities" section.

### Important:

- Do not execute LAN Display System on the computer which is connected and controlled by Thin Client. It may cause malfunction.

# Initial network settings

You can set the network of the projector using the menu.

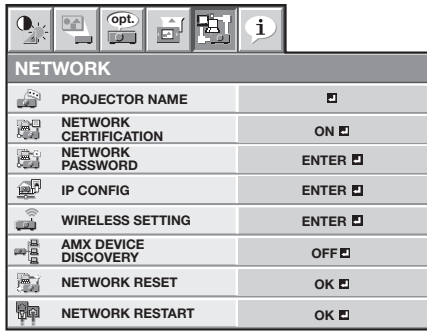

## Setting Projector Name

(See page 26 for menu setting.)

1. Display the NETWORK menu.
2. Press the ▲ or ▼ button to select PROJECTOR NAME.

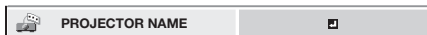

3. Press the ENTER button.
  - PROJECTOR NAME screen appears.

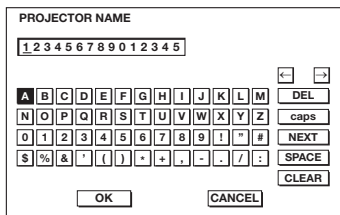

4. Press the direction buttons to move the key cursor, select the characters or marks to enter, and press the ENTER button.

- Projector Name can be set using up to 15 characters including alphabets (capital/small), numeric characters, or marks.
- ← key: ..... Shifting the position of enter cursor to the left for each character.
- key: ..... Shifting the position of enter cursor to the right for each character.
- DEL key: ..... Deleting the character in the position of enter cursor for each character.
- caps/CAPS key: Switching an alphabet character to CAPITAL or small.
- NEXT/PREV key: Switching the marks.
- SPACE key: ..... Inserting a space in the position of enter cursor.
- CLEAR key: ..... Deleting all the entered characters.

5. When selecting OK, the setting is completed as the name stored. However, when selecting CANCEL, the setting is completed without storing.
  - The display returns the NETWORK menu after selecting OK or CANCEL.
  - It may take some time to reflect the settings.

## Enabling or disabling the network certification

You can select whether or not to certify the network communication using the network password.

- For details, contact your dealer.

(See page 26 for menu setting.)

1. Display the NETWORK menu.
2. Press the ▲ or ▼ button to select NETWORK CERTIFICATION.

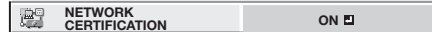

3. Press the ENTER button.
  - NETWORK CERTIFICATION dialog appears.

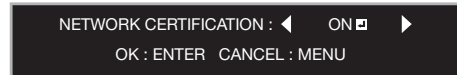

4. Press the ◀ or ▶ button to select ON or OFF.
5. Press the ENTER button.
  - To cancel the setting, press the MENU button.
  - It may take some time to reflect the settings.

## Network Password Settings

(See page 26 for menu setting.)

1. Display the NETWORK menu.
2. Press the ▲ or ▼ button to select NETWORK PASSWORD.



3. Press the ENTER button.
  - CURRENT NETWORK PASSWORD screen appears.

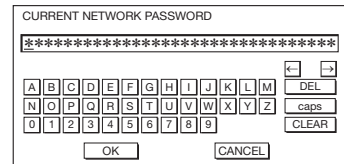

4. Press the direction buttons to move the key cursor, select the characters or marks to enter, and press the ENTER button.

- Password can be set using up to 32 characters including alphabets (capital/small) or numeric characters.
- ← key: ..... Shifting the position of enter cursor to the left for each character.
- key: ..... Shifting the position of enter cursor to the right for each character.
- DEL key: ..... Deleting the character in the position of enter cursor for each character.
- caps/CAPS key: Switching an alphabet character to CAPITAL or small.
- CLEAR key: ..... Deleting all the entered characters.
- The default password is “admin”.

## Initial network settings (continued)

- Select OK, and NEW NETWORK PASSWORD screen appears if the entered password is correct.
  - If the entered password is not correct, CURRENT NETWORK PASSWORD screen appears again.

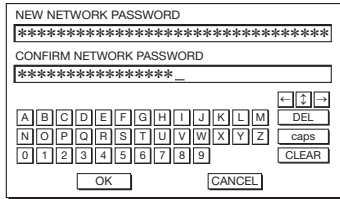

- Enter the NEW NETWORK PASSWORD and CONFIRM NETWORK PASSWORD.
  - Password can be set using up to 32 characters including alphabets (capital/small) or numeric characters.
    - ← key: ..... Shifting the position of enter cursor to the left for each character.
    - key: ..... Shifting the position of enter cursor to the right for each character.
    - ↑ key: ..... Shifting the position of enter cursor between NEW NETWORK PASSWORD and CONFIRM NETWORK PASSWORD.
    - DEL key: ..... Deleting the character in the position of enter cursor for each character.
    - caps/CAPS key: Switching an alphabet character to CAPITAL or small.
    - CLEAR key: ..... Deleting all the entered characters.

- When NEW NETWORK PASSWORD and CONFIRM NETWORK PASSWORD are matched, the setting is completed after changing the NETWORK PASSWORD.
  - When you select CANCEL, the NETWORK menu is displayed without changing the password.
  - If the entered content is not matched, NEW NETWORK PASSWORD screen appears again after an error dialog is displayed.
  - It may take some time to reflect the settings.

## IP Settings

(See page 26 for menu setting.)

- Display the NETWORK menu.
- Press the ▲ or ▼ button to select IP CONFIG.



- Press the ENTER button.
  - IP CONFIG menu appears.

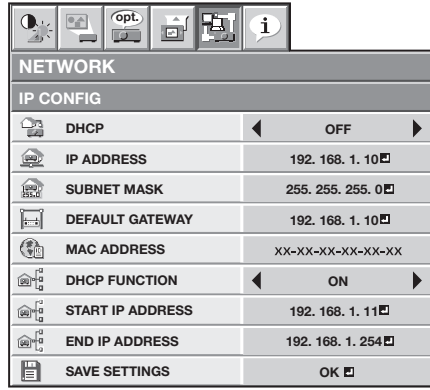

- The default setting of each item is as follows:

DHCP	OFF
IP ADDRESS	192.168.1.10
SUBNET MASK	255.255.255.0
DEFAULT GATEWAY	192.168.1.10
DHCP FUNCTION	ON
START IP ADDRESS	192.168.1.11
END IP ADDRESS	192.168.1.254

### Setting or Clearing DHCP

- Display the IP CONFIG menu.
- Press the ▲ or ▼ button to select DHCP.

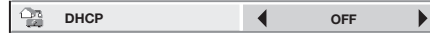

- Press the ◀ or ▶ button to select ON or OFF.
  - When setting DHCP to ON, IP ADDRESS, SUBNET MASK, DEFAULT GATEWAY, and DHCP FUNCTION cannot be set. If you set those settings, set DHCP to OFF and perform the IP settings as the following procedures.
  - Until the execution of SAVE SETTING, the change is not saved.

## Initial network settings (continued)

### IP Address Settings

1. Display the IP CONFIG menu.
2. Press the ▲ or ▼ button to select IP ADDRESS.



3. Press the ENTER button.
  - IP ADDRESS screen appears.

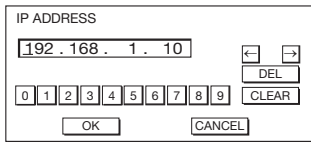

4. Press the direction buttons to move the key cursor, select the numbers to enter, and press the ENTER button.
  - Set the numeric value within the range from 0 to 255. However, set the numeric value for the final octet within the range from 1 to 254.
    - ← key: Shifting the position of enter cursor to the left.
    - key: Shifting the position of enter cursor to the right.
    - DEL key: Deleting the character in the position of enter cursor for each character.
    - CLEAR key: Deleting all the entered characters.
5. When selecting OK, the setting is completed as the IP ADDRESS stored temporarily. However, when selecting CANCEL, the setting is completed without storing.
  - When the setting you entered is correct, the IP CONFIG menu is displayed. If the entered content is not correct, the IP CONFIG menu is displayed after an error dialog is displayed.
  - Until the execution of SAVE SETTING, the change is not saved.

### Subnet Mask Settings

1. Display the IP CONFIG menu.
2. Press the ▲ or ▼ button to select SUBNET MASK.

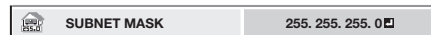

3. Press the ENTER button.
  - SUBNET MASK screen appears.

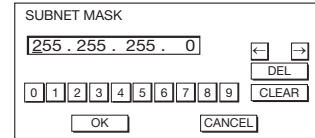

4. Enter the Subnet Mask.
  - Refer to IP Address Settings for the detail of entering.
5. When selecting OK, the setting is completed as the Subnet Mask stored temporarily. However, when selecting CANCEL, the setting is completed without storing.
  - When the setting you entered is correct, the IP CONFIG menu is displayed. If the entered content is not correct, the IP CONFIG menu is displayed after an error dialog is displayed.
  - Until the execution of SAVE SETTING, the change is not saved.

### Default Gateway Settings

1. Display the IP CONFIG menu.
2. Press the ▲ or ▼ button to select DEFAULT GATEWAY.

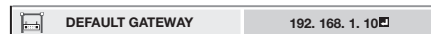

3. Press the ENTER button.
  - DEFAULT GATEWAY screen appears.

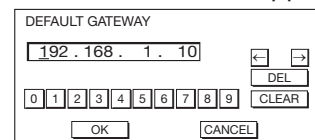

4. Enter the Default Gateway.
  - Refer to IP Address Settings for the detail of entering.
5. When selecting OK, the setting is completed as the Default Gateway stored temporarily. However, when selecting CANCEL, the setting is completed without storing.
  - When the setting you entered is correct, the IP CONFIG menu is displayed. If the entered content is not correct, the IP CONFIG menu is displayed after an error dialog is displayed.
  - Until the execution of SAVE SETTING, the change is not saved.



## Initial network settings (continued)

### Setting or clearing DHCP Function

1. Display the IP CONFIG menu.
2. Press the ▲ or ▼ button to select DHCP FUNCTION.

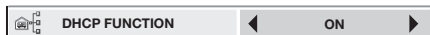

3. Press the ◀ or ▶ button select ON or OFF.
  - When DHCP FUNCTION is set to OFF, START IP ADDRESS and END IP ADDRESS cannot be set. If you want to set these settings, set DHCP FUNCTION to ON and perform the IP settings as follows.

### Start IP Address setting

1. Display the IP CONFIG menu.
2. Press the ▲ or ▼ button to select START IP ADDRESS.



3. Press the ENTER button.
  - START IP ADDRESS screen appears.

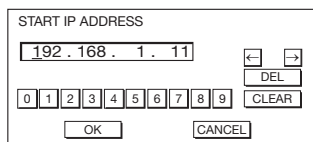

4. Enter the Start IP address.
  - Refer to IP Address Settings for the detail of entering.
5. When selecting OK, the setting is completed as the Start IP address stored temporarily. However, when selecting CANCEL, the setting is completed without storing.
  - Set the numeric value within the range from 0 to 255. However, set the numeric value for the final octet within the range from 2 to 254. Moreover, set the numeric value larger than IP address in the same subnet class.
  - When the setting you entered is correct, the IP CONFIG menu is displayed. If the entered content is not correct, the IP CONFIG menu is displayed after an error dialog is displayed.
  - Until the execution of SAVE SETTING, the change is not saved.

### End IP Address setting

1. Display the IP CONFIG menu.
2. Press the ▲ or ▼ button to select END IP ADDRESS.

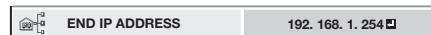

3. Press the ENTER button.
  - END IP ADDRESS screen appears.

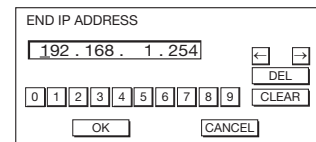

4. Enter the End IP address.
  - Refer to IP Address Settings for the detail of entering.
5. When selecting OK, the setting is completed as the End IP address stored temporarily. However, when selecting CANCEL, the setting is completed without storing.
  - Set the numeric value within the range from 0 to 255. However, set the numeric value for the final octet within the range from 3 to 254. Moreover, set the numeric value larger than Start IP address in the same subnet class.
  - When the setting you entered is correct, the IP CONFIG menu is displayed. If the entered content is not correct, the IP CONFIG menu is displayed after an error dialog is displayed.
  - Until the execution of SAVE SETTING, the change is not saved.

### Saving IP CONFIG Settings

1. Display the IP CONFIG menu.
2. Press the ▼ button to select SAVE SETTING.



3. Press the ENTER button.
  - The setting change dialog is displayed. After the dialog disappears, the NETWORK menu is displayed.
  - It may take some time to reflect the settings.



# Initial network settings (continued)

## Wireless Setting

(See page 26 for menu setting.)

1. Display the NETWORK menu.
2. Press the ▲ or ▼ button to select WIRELESS SETTING.



3. Press the ENTER button.
  - The WIRELESS SETTING menu appears.

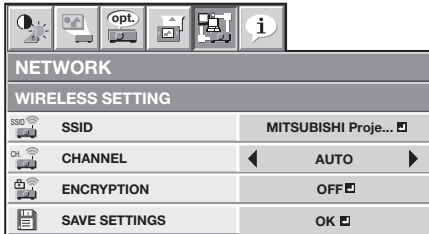

## SSID setting

1. Display the WIRELESS SETTING menu.
2. Press the ▲ or ▼ button to select SSID.

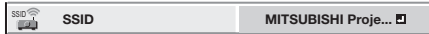

3. Press the ENTER button.
  - The SSID screen appears.

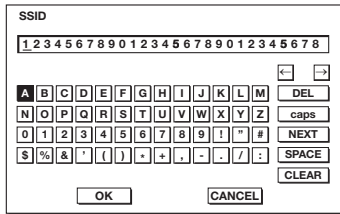

4. Press the ▲, ▼, ◀, and ▶ buttons to move the key cursor to select the characters or marks to enter, and press the ENTER button.

- SSID can be set using up to 32 characters including alphabets (capital/small) or numeric characters.
  - ← key: Shifting the position of enter cursor to the left for each character.
  - key: Shifting the position of enter cursor to the right for each character.
  - DEL key: Deleting the character in the position of enter cursor for each character.
  - caps/CAPS key: Switching an alphabet character to CAPITAL or small.
  - NEXT/PREV key: Switching the marks.
  - SPACE key: Inserting a space in the position of enter cursor.
  - CLEAR key: Deleting all the entered characters.

- The default SSID is "MITSUBISHI Projector".
5. Select OK to complete the setting with the SSID stored. Select CANCEL to complete the setting without storing.

- The display returns to the WIRELESS SETTING menu after selecting CANCEL.

## Channel setting

1. Display the WIRELESS SETTING menu.
2. Press the ▲ or ▼ button to select CHANNEL.



3. Press the ◀ or ▶ button to select AUTO or 1 to 11.
  - To cancel the setting, press the MENU button.

## Encryption setting

1. Display the WIRELESS SETTING menu.
2. Press the ▲ or ▼ button to select ENCRYPTION.

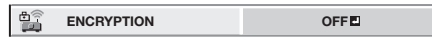

3. Press the ENTER button.
  - ENCRYPTION dialog appears.



4. Press the ◀ or ▶ button to select OFF or the other encryption.

5. Press the ENTER button.

- The KEY screen appears.
- The keypad on the KEY screen varies depending on the selected Encryption setting.
- To cancel the setting, press the MENU button.

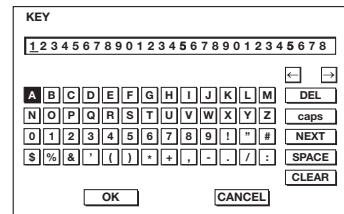

6. Press the ▲, ▼, ◀, and ▶ buttons to move the key cursor to select the characters or marks to enter, and press the ENTER button.

- KEY can be set using up to 64 characters including alphabets (capital/small) or numeric characters.
  - ← key: Shifting the position of enter cursor to the left for each character.
  - key: Shifting the position of enter cursor to the right for each character.
  - DEL key: Deleting the character in the position of enter cursor for each character.
  - caps/CAPS key: Switching an alphabet character to CAPITAL or small.
  - NEXT/PREV key: Switching the marks.
  - SPACE key: Inserting a space in the position of enter cursor.
  - CLEAR key: Deleting all the entered characters.

## Initial network settings (continued)

- Select OK to complete the setting with the Encryption and KEY stored. Select CANCEL to complete the setting without storing.
  - The display returns to the Wireless Setting menu after selecting CANCEL.
  - The number of characters of KEY varies depending on the Encryption setting.
    - WEP 128bit(ASCII): 13 chars
    - WEP 64bit(ASCII): 5 chars
    - WEP 128bit(HEX): 26 digits
    - WEP 64bit(HEX): 10 digits
    - WPA-PSK(ASCII): 8-63 chars
    - WPA2-PSK(ASCII): 8-63 chars
    - WPA-PSK(HEX): 64 digits
    - WPA2-PSK(HEX): 64 digits
  - If the entered content is outside character number range, the KEY screen appears again after an error dialog is displayed.

### Saving Wireless Settings

- Display the WIRELESS SETTING menu.
- Press the ▲ or ▼ button to select SAVE SETTING.

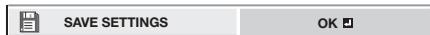

- Press the ENTER button.
  - Confirmation dialog appears.
- If the ENTER button is pressed again, the Wireless Setting will be reflected.
  - It may take some time to reflect the setting.

### Enabling or disabling the AMX Device Discovery

Select this setting when using the AMX controller.  
(See page 26 for menu setting.)

- Display the NETWORK menu.
- Press the ▲ or ▼ button to select AMX DEVICE DISCOVERY.



- Press the ENTER button.
    - AMX dialog appears.
- 
- Press the ◀ or ▶ button to select ON  or OFF .
  - Select the item to set, and press the ENTER button.
    - To cancel the setting, press the MENU button.
    - It may take some time to reflect the setting.

### Initialization of network settings

(See page 26 for menu setting.)

- Display the NETWORK menu.
- Press the ▲ or ▼ button to select NETWORK RESET.



- Press the ENTER button.

- Network Initialization dialog appears.
- If the ENTER button is pressed again, the network settings will be initialized.
    - It may take some time to initialize the settings.

### Restart of network function

(See page 26 for menu setting.)

- Display the NETWORK menu.
- Press the ▲ or ▼ button to select NETWORK RESTART.

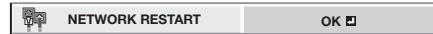

- Press the ENTER button.
  - Network Restart dialog appears.
- If the ENTER button is pressed again, the network function will be restarted.
  - It may take some time to restart the function.

### How to use network function

- When connecting a computer and projector with LAN, configure the both IP Addresses in the same network group.  
If connecting in different network group, be sure to use a router. As for the settings of a router, ask the network administrator.
- Configure the IP CONFIG correctly. If the settings are not correct, the communication may be unavailable. For the detail, consult the network administrator.
- Depending on the settings of STANDBY MODE of the projector, LAN function may be unavailable. See page 28 for the detail of STANDBY MODE.

### Glossary

For more detail of the glossary below, refer to the technical book that is commercially available.

Term	Description
DHCP	Abbreviation for Dynamic Host Configuration Protocol. This protocol automatically assigns IP Address to networked devices.
IP Address	Numerical address to identify networked computers.
Subnet Mask	A numeric value to define the number of bits used for a network address of a divided network (or subnet) in an IP Address.
Default Gateway	A server (or router) to communicate across networks (subnets) that are divided by Subnet Mask.
MAC Address	Abbreviation for Media Access Control Address. MAC Address is a unique ID number assigned to each network adapter. And this is based on which data are sent and received between network adapters.

# Advanced display utilities

## WiFi-Doc

Via a wireless LAN, you can transfer the images of the Microsoft PowerPoint, Word, Excel, PDF or TXT format stored in the tablet computer to the projector and project them controlling with the tablet computer.

To use WiFi-Doc, you need to install the free software "WiFi-Doc (Bundle Version)" to the tablet computer.

Supported OS's of WiFi-Doc (Bundle Version) are as follows:

- iOS 4.2 or later
- Android 2.1 or later

### Installation of software

1. Download the WiFi-Doc (Bundle Version) from the Internet to the tablet computer.
  - Connect to Apple Store to download the software for iOS.
  - Connect to Google Play to download the software for Android .
  - The communication fee to connect to Apple Store or Google Play will be borne by the customer.

### Connection

Connect the projector and the tablet computer using a commercially available USB wireless LAN adapter.

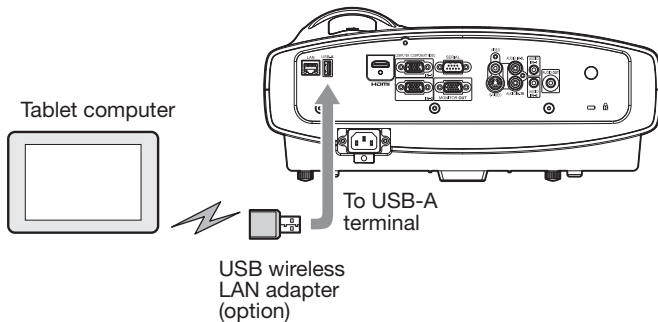

### Important:

- Some USB wireless LAN adapters cannot be used depending on the specifications.

### Wireless network setting on the tablet computer

1. Turn on the tablet computer and tap the [Settings] icon.



2. Turn on Wi-Fi.
  - Access points will be listed on the screen.
3. Tap the projector's SSID.



## Projection

### Selecting a LAN DISPLAY input

1. Press the LAN DISP. button on the remote control or the SOURCE button on the projector, and select LAN DISPLAY.
  - When the LAN DISPLAY input is selected, the splash screen for LAN DISPLAY appears on the screen.

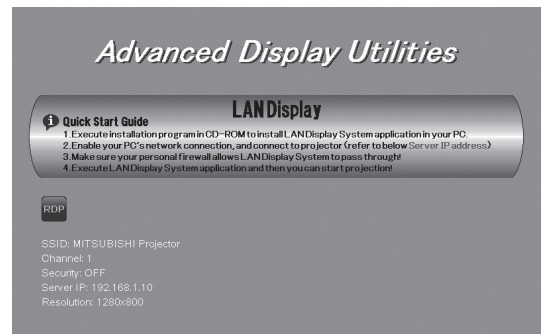

### Starting WiFi-Doc

#### ■ When using iOS

2. On the tablet computer, tap the WiFi-Doc icon  to turn on WiFi-Doc.
  - The program starts to search for projectors. When projectors are found, their SSID's are displayed.
3. Select a projector for projection by tapping its SSID.

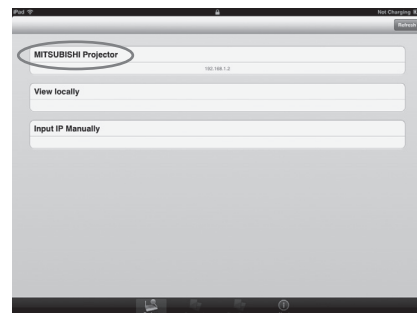

4. Select a file to be projected by tapping its name.
  - The image of the selected file is displayed.

## Advanced display utilities (continued)

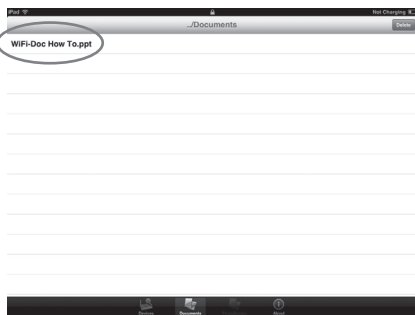

- Operate the image by touching the tablet screen.



- Flick the screen to move to the previous or next page.
- Pinch the screen for zooming in or out.
- Tap the screen to display the status bar and the thumbnails of the pages. (See below.)

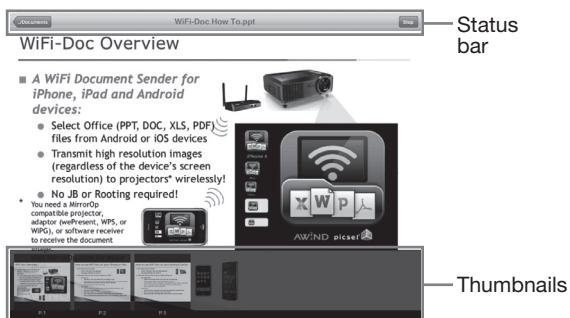

- Tap [../Documents] to return to the file selection screen.
- Tap [Play] or [Stop] to start or stop the projection.
- Tap a thumbnail to select the page to be projected.

### ■ When using Android

- On the tablet computer, tap the WiFi-Doc icon “” to turn on WiFi-Doc.
  - The program starts to search for projectors. When projectors are found, their SSID’s are displayed.
- Select a projector for projection by tapping its SSID.

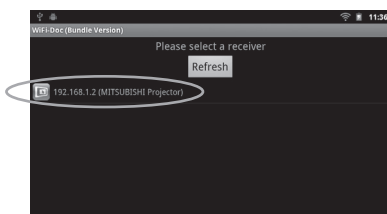

- Select a file to be projected by tapping its name.
  - The image of the selected file is displayed.

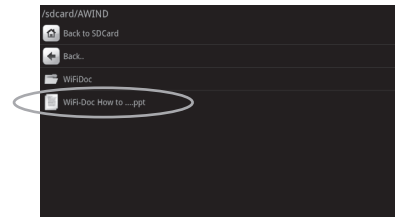

- Operate the image by touching the tablet screen.



- Flick the screen to move to the previous or next page.
- Pinch the screen for zooming in or out.
- Tap the screen to display the status bar and the thumbnails of the pages. (See below.)



- Tap [Back] to return to the file selection screen.
- Tap [Play] or [Stop] to start or stop the projection.
- Tap a thumbnail to select the page to be projected.

### Important:

- Starting projection from another tablet computer stops the projection from the current tablet computer and the “▶” mark will appear in the middle of the screen. Tapping the “▶” mark will start projection from the tablet computer again.

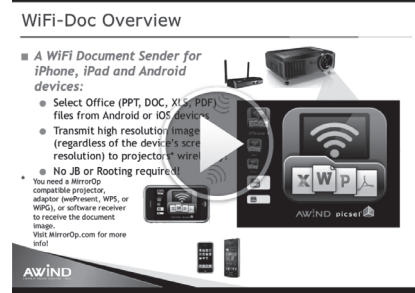

### Ending WiFi-Doc

- Turn off WiFi-Doc on the tablet computer.



## Advanced display utilities (continued)

### Thin client

Projecting the desktop screen of a remote computer connected via a network onto the projector, you can remotely control the remote computer through the projector.

To use the thin client function, you need to install the software “ThinClient\_v200.exe” contained in the attached CD-ROM.

Supported OS's are as follows:

- Windows XP Service Pack 3 (except Home Edition)
- Windows Vista (except Home Basic and Home Premium)
- Windows 7 (except Starter and Home Premium)
- Windows Server 2008 R2
- Windows MultiPoint Server

#### Important:

- License terms for Windows XP, Windows Vista and Windows 7 do not permit simultaneous operation by multiple users.
- To use the thin client function with Windows Server 2008 R2 or Windows MultiPoint Server, a Client Access License (CAL) is required. For details, see “Client Access License (CAL)” on page 52.

### Preparation for using Remote Desktop

The thin client function utilizes the standard Microsoft Remote Desktop function. To use the Remote Desktop function, perform the following preparations on the computer.

#### Important:

- For the following preparations, log on to the computer using the administrator account.

#### 1. Creating a user account

##### Important:

- You must configure a password for the user account. Do not use double-byte characters for the user account name and password.

#### 2. Configuring Remote Desktop users

Configure the Remote Desktop users as follows.

##### ■ In Windows Vista, Windows 7, Windows Server 2008 R2 or Windows MultiPoint Server

1. Select [Start]-[Control Panel].
2. In Windows Vista, select [System and Maintenance]. Otherwise, select [System and Security].
  - When using Classic View in Windows Vista, double-click the System icon and go to step 4.
3. Select [System].

4. Click [Remote settings].

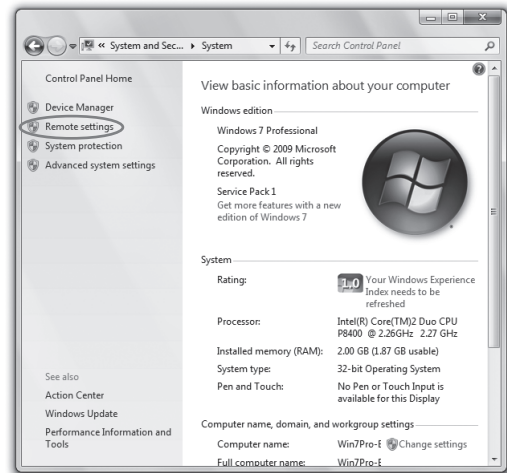

5. Select [Allow connections from computers running any version of Remote Desktop (less secure)].

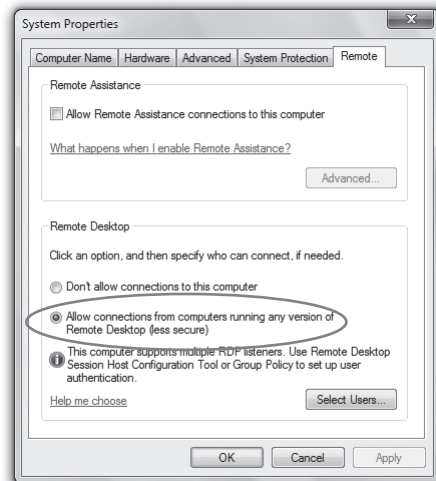

6. Click [Select Users...].

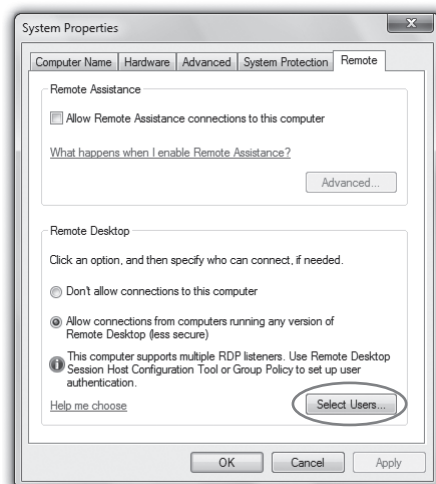

- The “Remote Desktop Users” window is displayed.

## Advanced display utilities (continued)

7. Click [Add...].

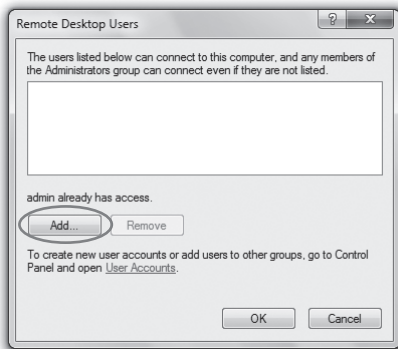

- The “Select Users” window is displayed.

8. Enter the user account name configured in the “1. Creating a user account” (see page 48) in the textbox and click [OK].

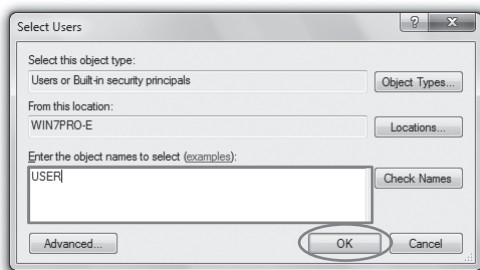

- The “Remote Desktop Users” window is displayed.

9. Click [OK].

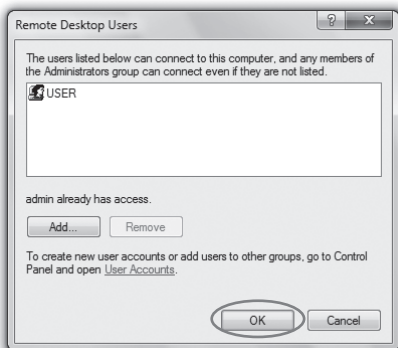

- The “System Properties” window is displayed.

10. Click [OK].

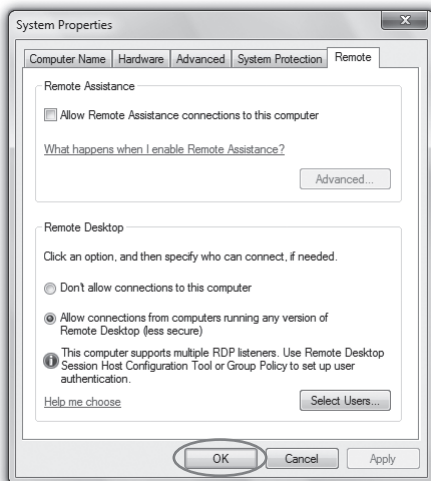

### ■ In Windows XP

1. Select [Start]-[Control Panel].
2. Click [Performance and Maintenance].
  - When using Classic View, double-click the System icon and go to step 4.
3. Click [System].
  - The “System Properties” window is displayed.
4. Click the [Remote] tab and check the [Allow users to connect remotely to this computer] checkbox.
5. Click [Select Remote Users...].
  - The “Remote Desktop Users” window is displayed.
6. Perform steps 7-10 in the section “■ In Windows Vista, Windows 7, Windows Server 2008 R2 or Windows MultiPoint Server.”

### 3. Configuration of Windows Firewall

Configure Windows Firewall as follows.

#### ■ In Windows 7, Windows Server 2008 R2 or Windows MultiPoint Server

1. Select [Start]-[Control Panel].
2. Select [System and Security].
3. Select [Allow a program through Windows Firewall].
  - The “Allowed Programs” window is displayed.
4. Check the [Remote Desktop] checkbox and the [Home/Work (Private)] and [Public] checkboxes on the same line, and click [OK].

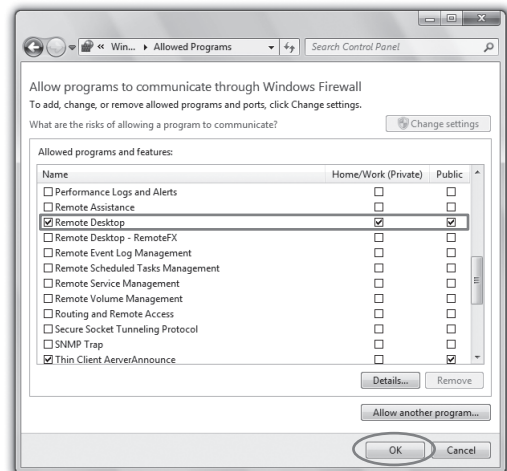

#### ■ In Windows Vista

1. Select [Start]-[Control Panel].
2. Select [Allow a program through Windows Firewall].
  - When using Classic View, double-click the Windows Firewall icon and select [Allow a program through Windows Firewall] on the upper left of the window.
  - The “Windows Firewall Settings” window is displayed.

## Advanced display utilities (continued)

- Click the [Exceptions] tab, check the [Remote Desktop] checkbox and click [OK].

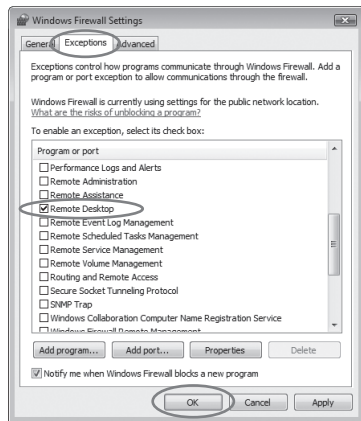

### ■ In Windows XP

- Select [Start]-[Control Panel].
- Click [Network and Internet Connections].
  - When using Classic View, double-click the Windows Firewall icon and go to step 4.
- Select [Windows Firewall].
  - The “Windows Firewall” window is displayed.
- Click the [Exceptions] tab, check the [Remote Desktop] checkbox and click [OK].

## Installation of software

### Installing Thin Client

Before starting installation, be sure to read “ReadMe.txt” contained in the CD-ROM.

- Copy “ThinClient\_v200.exe” contained in the TOOLS folder of CD-ROM to the hard disk of your computer.
- Double-click “ThinClient\_v200.exe” on the hard disk, and start up the installer of the Thin Client.
  - Follow the on-screen instructions to install the software.
  - When the “Windows Security Alert” window is displayed during installation, proceed as follows:
    - In Windows XP or Windows Vista, click [Unblock].
    - In Windows 7, click [Allow access].
- When the installation has been completed, restart the computer.

### When deleting ThinClient (Uninstallation)

- Select [Start]-[All Programs]-[Thin Client]-[Uninstall Thin Client].
  - Follow the on-screen instructions to uninstall the software.

## Connection

Connect the projector and the computer using a commercially available LAN cable. Connect a USB mouse and USB keyboard to the USB-A terminal on the projector.

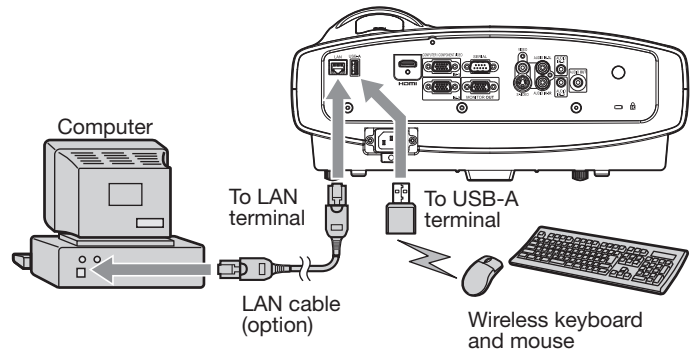

### Important:

- On Thin Client, use both a keyboard and mouse. We recommend a commercially available wireless keyboard and wireless mouse intended for a computer with a wireless receiver.
- For wired LAN connection, use a category-5 LAN cable. Both straight-through and crossover cables can be used.
- The USB-A terminal on this projector is compatible with USB 2.0.
- Supported USB devices are standard USB HID devices with power consumption less than 5V/500mA or wireless LAN modules.
- When using a USB hub, you are recommended to use the one with external power supply.
- Some USB hubs cannot be used depending on the specifications.

## Operation

### Selecting a LAN DISPLAY input

- Press the LAN DISP. button on the remote control or the SOURCE button on the projector, and select LAN DISPLAY.
  - When the LAN DISPLAY input is selected, the splash screen for LAN DISPLAY appears on the screen.

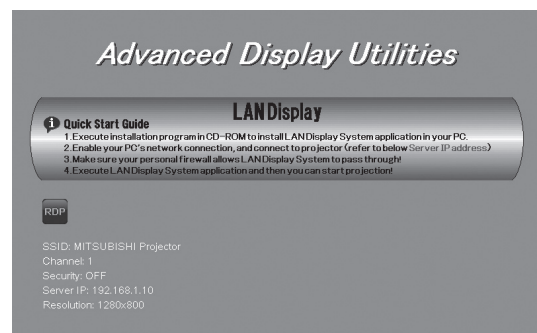

### Connecting the projector to the computer

For the following operation, use the USB device such as a mouse or keyboard connected to the projector.



## Advanced display utilities (continued)

### Important:

- The following key assignment is applied to any keyboard connected to the projector.

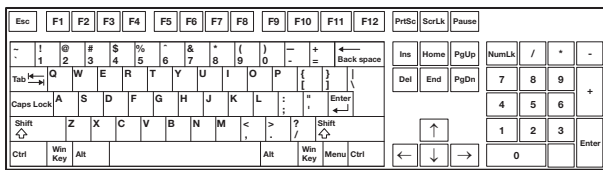

- Click the RDP icon “”.

- “Waiting to search Thin Client server ...” is displayed. Then the logon window appears.

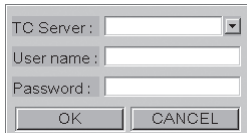

### Important:

- In [TC Server], the name of the computer where ThinClient.exe has been installed will be displayed.
  - If the subnet of the computer is different, the computer name will not be displayed in [TC Server].
  - To close the logon window, click [CANCEL] or press the ESC key on the keyboard.
  - The computer name may not be displayed just after startup of the computer. In that case, click [CANCEL] or press the ESC key on the keyboard to close the logon window, wait for a while and then click the RDP icon again.
- Enter the following in the textboxes and click [OK].
    - [TC Server]: Enter the computer name (or IP address).
    - [User name]: Enter the user account name.
    - [Password]: Enter the password.

### Important:

- Double-byte characters cannot be used.
- “Waiting to connect ...” is displayed and the connection process will start. It may take some time to display the desktop screen depending on the network congestion. Wait for a while until the desktop screen appears.
- When connecting to a computer with different subnet, enter the IP address in [TC Server].
- If the message saying “This computer is not allow to remote desktop.” is displayed, the Remote Desktop users setting may not have been enabled yet. Make the setting again, following the procedure of “Preparation for using Remote Desktop” (page 48).
- If you enter a wrong User name or Password, “The projector could not log on. Make sure your User name and Password are correct.” will be displayed.
- If you connect to a computer installed with Windows XP, Windows Vista or Windows 7 that any other user has already logged on, “Another

user is currently logged on to this computer.” will be displayed.

- If you connect to a computer with Windows Server 2008 R2 or Windows MultiPoint Server and try logging on to a user account where any other user has already logged on, “Another user is currently logged on to this computer.” will be displayed.
- When the projector logs on to the computer, the desktop screen of the user account is displayed.
    - You can operate the computer using the USB device such as a mouse or keyboard connected to the projector.

### Disconnecting the projector from the computer

For the following operation, use the USB device such as a mouse or keyboard connected to the projector.

### Important:

- When you disconnect the connection without ending the session, the programs running on the computer are kept active. Therefore, when you establish the connection next time, you can resume the programs from where you disconnected the session.

#### ■ When using Windows XP

##### To disconnect without ending the session:

- Select [Start]-[Disconnect].
- Click [Disconnect].

##### To disconnect with ending the session:

- Select [Start]-[Log Off].
- Click [Log Off].

#### ■ When using Windows Vista

##### To disconnect without ending the session:

- Select [Start]-[X].

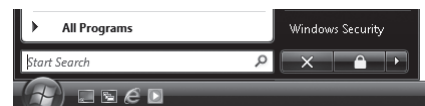

- Lock function of Remote Desktop cannot be used with this projector. When [Lock] is selected, the remote session is disconnected without ending the session.

##### To disconnect with ending the session:

- Click [Start], select the ► button and click [Log Off].

#### ■ When using Windows 7, Windows Server 2008 R2 or Windows MultiPoint Server

##### To disconnect without ending the session:

- Click [Start], select the ► button and click [Disconnect].

- Lock function of Remote Desktop cannot be used with this projector. When [Lock] is selected, the remote session is disconnected without ending the session.

##### To disconnect with ending the session:

- Select [Start]-[Log Off].

## Advanced display utilities (continued)

### Client Access License (CAL)

An application allowing multiple users to share a single operation system requires the standard Microsoft Windows server licenses. In addition to Windows Server Client Access License, Remote Desktop Services Client Access License (RDS CAL) is necessary for each end user or each device to access Windows server. When using Windows Multipoint Server, Windows MultiPoint Server 2011 CAL is also necessary. For details of Microsoft multiple user licenses, see the Microsoft website.

#### 1. When the host computer OS is Windows XP, Windows Vista or Windows 7

For Windows XP, Windows Vista and Windows 7, only a single projector can run the thin client function. While using the desktop of host computer, you cannot use the thin client function on the projector.

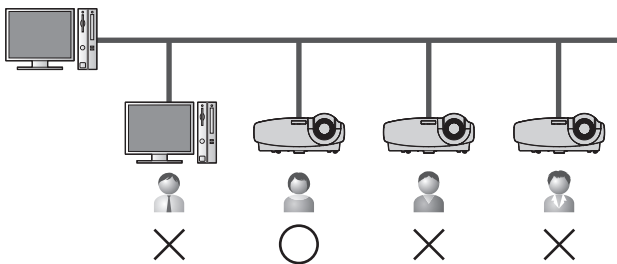

#### 2. When the host computer OS is Windows Server 2008 R2

Windows Server requests Client Access License (CAL). To access the host computer from a thin client computer or projector, two types of CAL are necessary: "Windows Server CAL" and "Windows Remote Desktop Service (RDS) CAL". "Windows Server CAL" offers two types of license system.

##### User CAL

With User CAL, you purchase CALs according to the number of users regardless of the number of thin client computers or projectors. User CAL is, therefore, recommended in the case that the number of system administrators or operators who operate thin client computers or projectors at multiple sites is smaller than that of the thin client computers or projectors.

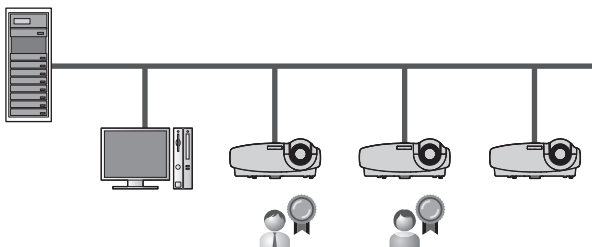

E.g., when two users operate four devices

In the example above, the following licenses are necessary.

- Windows Server CAL (User CAL) x 2
- Windows RDS CAL x 2

##### Device CAL

With Device CAL, you purchase CALs according to the number of devices accessing to the host, regardless of the number of users who access the host via thin client computer or projector. Therefore Device CAL is recommended for the case that multiple operators share a thin client computer or projector.

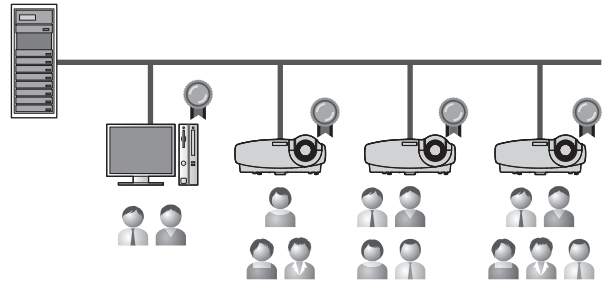

E.g., when six users operate four devices

In the example above, the following licenses are necessary.

- Windows Server CAL (Device CAL) x 4
- Windows RDS CAL x 4

#### 3. When the host computer OS is Windows MultiPoint Server

The concept of Windows MultiPoint Server is basically the same as that of Windows Server 2008 R2. It requires Windows MultiPoint Server CAL instead of Windows RDS CAL. Therefore, Windows Server CAL and Windows MultiPoint Server CAL are necessary for each user or device. When you use the desktop of host computer as one of computer terminals, Windows MultiPoint Server will also request a Windows Server CAL and Windows MultiPoint Server CAL for the desktop of host computer.

##### (Example 1)

When two users operate four computers or projectors as well as the desktop of host computer

- Windows Server CAL (User CAL) x 2
- Windows MultiPoint Server CAL x 2

##### (Example 2)

When six users operate four computers or projectors as well as the desktop of host computer

- Windows Server CAL (Device CAL) x 4
- Windows MultiPoint Server CAL x 4

## Advanced display utilities (continued)

### LAN Display

You can project the computer images inputted via a wired or wireless LAN.

You can also perform the following during the LAN Display projection:

- 4-to-1 split screen projection  
Images from up to 4 computers can be projected split on 1 projector screen.
- Remote desktop  
Connecting an input device such as a mouse or keyboard to the USB-A terminal on the projector enables the following computer operations from the projector.
  - Showing local files of the computer
  - Operating the application software
  - Showing server files on the network
  - Browsing of the internet
- SidePad  
Computer images are transferred to the tablet computer and you can operate the computer from the tablet computer.

To use the LAN Display function, you need to install the software “LAN Display System” contained in the attached CD-ROM.

Supported OS's are as follows:

- Windows XP Service Pack 3
- Windows Vista
- Windows 7
- Mac OS X 10.5 or later

#### Important:

- Mac computers based on the PowerPC processors are not supported.
- Remote desktop cannot be performed during 4-to-1 split screen projection.

### Installation of software

#### Installing LAN Display System

Before starting installation, be sure to read “ReadMe.txt” contained in the CD-ROM.

#### ■ When using Windows XP, Windows Vista or Windows 7

1. Copy “LAN Display System\_v300.exe” contained in the TOOLS folder of CD-ROM to the hard disk of your computer.
2. Double-click “LAN Display System\_v300.exe” on the hard disk, and start up the installer of the LAN Display System.
3. Follow the on-screen instructions to install the software.
  - When the installation has been completed, LAN Display System is automatically executed.

#### ■ When using Mac OS X

1. Copy “LAN Display System\_v300.dmg” contained in the TOOLS folder of CD-ROM to the hard disk of your computer.
2. Double-click “LAN Display System\_v300.dmg” on the hard disk.
  - The volume is mounted.
3. Drag and drop “LAN Display System” and “SidePadLite” into the [Applications] folder.

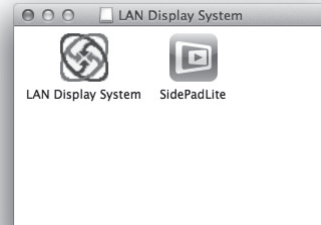

#### When deleting LAN Display System (Uninstallation)

##### Important:

- When uninstalling LAN Display System, it should be ended in advance. If the application continues operating, uninstallation cannot be performed normally.

#### ■ When using Windows XP, Windows Vista or Windows 7

1. Select [Start]-[All Programs]-[LAN Display System]-[Uninstall].
2. Follow the on-screen instructions to uninstall the software.

#### ■ When using Mac OS X

1. Open the [Applications] folder.
2. Drag and drop “LAN Display System” and “SidePadLite” to the trash.

# Advanced display utilities (continued)

## Connection

Connect the projector and the computer either by using a commercially available LAN cable or USB wireless LAN adapter.

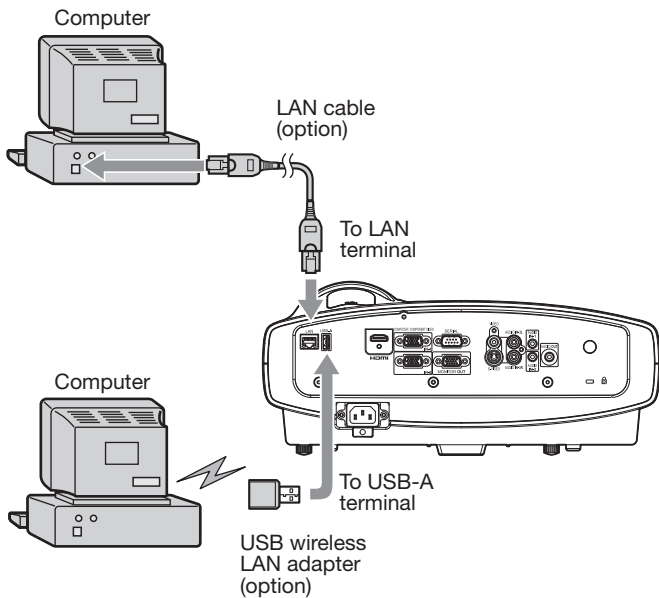

### Important:

- For wired LAN connection, use a category-5 LAN cable. Both straight-through and crossover cables can be used.
- The USB-A terminal on this projector is compatible with USB 2.0.
- When using a USB hub, you are recommended to use the one with external power supply.
- Some USB hubs cannot be used depending on the specifications.
- Some USB wireless LAN adapters cannot be used depending on the specifications.
- When connecting a USB wireless LAN adapter, do not use a USB hub.
- IP address, subnet mask, default gateway values are the same for both wired LAN and wireless LAN.
- Data are not filtered between wired LAN and wireless LAN interface.

## Projection

### Selecting a LAN DISPLAY input

1. Press the LAN DISP. button on the remote control or the SOURCE button on the projector, and select LAN DISPLAY.
  - When the LAN DISPLAY input is selected, the splash screen for LAN DISPLAY appears on the screen.

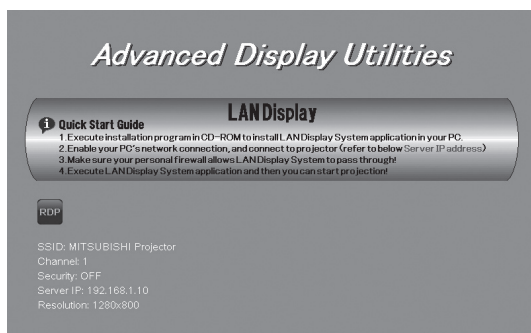

## Starting the LAN Display System

2. Click the LAN Display System icon “

- When a projector is found, the computer logs in to the projector automatically and the computer image is projected. The main user interface appears on the computer screen.
- When multiple projectors are found, the following window appears on the computer screen.

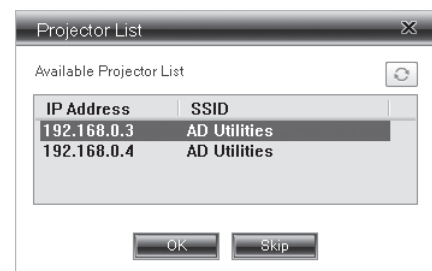

Select a projector and click [OK]. The computer logs in to the projector and the computer image is projected.

### Important:

- If the computer resolution is higher than 1280 x 800, a confirmation dialog for changing the computer resolution is displayed. When [OK] is selected, the computer resolution will be changed according to the projected image. When [Cancel] is selected, the computer resolution will not be changed and the projected image size will be smaller than the screen size. The computer resolution will be automatically recovered after the LAN Display System is ended.

## Operating the LAN Display System

3. Click the buttons on the main user interface to operate the projection.

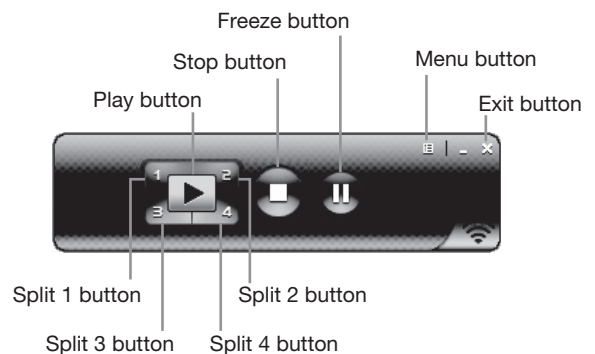

- **Play button:** Projects the image in full screen.
- **Split 1-4 buttons:** Click either of the buttons to project the image on relevant split screen.

## Advanced display utilities (continued)

- **Stop button:**  
Stops the projection.
- **Freeze button:**  
Freezes the projected image.
- **Menu button:**  
Displays the menu window. (See the next step for details.)
- **Exit button:**  
Exits the LAN Display System.

4. Click the Menu button on the main user interface to display the menu window and select functions.

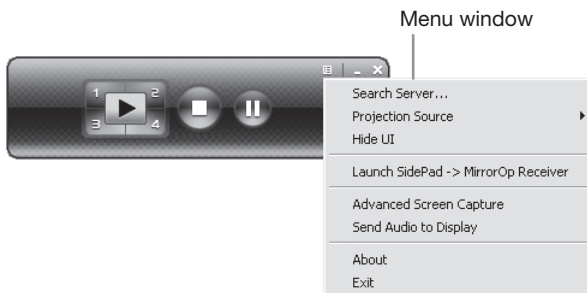

- **Search Server**  
Searches for the projectors on the network. If this function is selected, the LAN Display projection will quit automatically.
- **Projection Source\***  
Chooses the computer screen to be projected, main screen or virtual extended screen which is activated by computer's virtual display function.

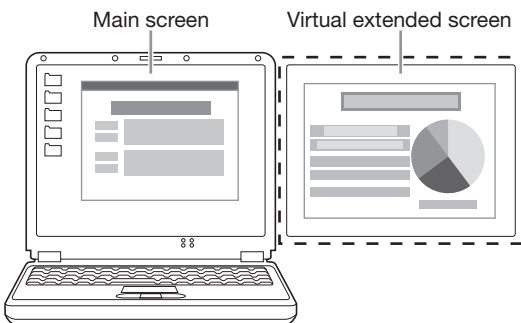

### Important:

- To project a virtual extended screen, the attached Virtual display driver must be installed.
- **Hide UI\***  
Hides or displays the main user interface on the projected image.
- **Launch SidePad (or Stop SidePad) - > MirrorOp Receiver**  
Launches (or stops) SidePad.
- **Advanced Screen Capture\***  
Enables or disables balloon tips and pop-up windows.
- **Send Audio to Display**  
Enable or disable the transfer of computer sound.

- **About**  
Displays the version information of the LAN Display System.
- **Exit**  
Exits the LAN Display System.

### Important:

- The items marked with "\*" are not available for Mac OS X.
- When "Advanced Screen Capture" is enabled, the computer mouse cursor may blink.
- To send Audio to Display, the Virtual Audio driver must be installed in case the operating system is Windows XP or Mac OS X.

### Ending the LAN Display projection

5. Click the Exit button on the main user interface or the menu window to exit the LAN Display System.
6. In case of the wireless LAN communication, unplug the USB wireless LAN adapter from the projector.

### Important:

- Do not switch the input source to USB VIEWER while the computer images are projected. If switched, the projection will be terminated.
- During wireless LAN communication, the projector cannot communicate with the access point.
- Only infrastructure mode is available to wireless LAN communication. Adhoc mode is not available.

### Installing the virtual display driver

To project a virtual extended screen, install the Virtual display driver as follows.

1. Double-click "Virtual display driver.exe" contained in "C:\Program Files\LAN Display System", and start up the installer of the Virtual display driver.
2. The Setup window is displayed. Click [Next] and operate according to the instructions on the window.

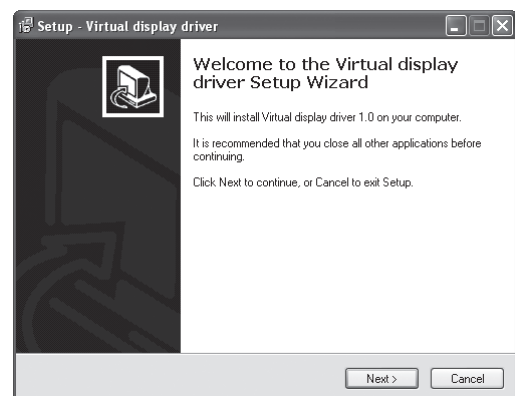

3. When the installation has been completed, restart the computer.



## Advanced display utilities (continued)

### Installing the Virtual Audio driver

#### ■ When using Windows XP

Before starting installation, be sure to read “ReadMe.txt” contained in the CD-ROM.

1. Copy “Virtual Audio driver.exe” contained in the TOOLS folder of CD-ROM to the hard disk of your computer.
2. Double-click “Virtual Audio driver.exe” on the hard disk, and start up the installer of the Virtual Audio driver.
3. Follow the on-screen instructions to install the software.

#### ■ When using Mac OS X

1. Download Soundflower from the download site. (<http://code.google.com/p/soundflower/downloads/list>). (When this file URL is not a valid location, search for "Soundflower" using a search engine and access the download site.)
2. Double-click “Soundflower.dmg” on the hard disk.
  - The volume is mounted.
3. Double-click “Soundflower.pkg”.
4. Follow the on-screen instructions to install the driver.

#### Important:

- Soundflower is also included in the CD-ROM.

### Using remote desktop

Connect an USB device such as a mouse or keyboard to the USB-A terminal on the projector. While the computer images are projected with the LAN Display, the computer can be operated with the device.

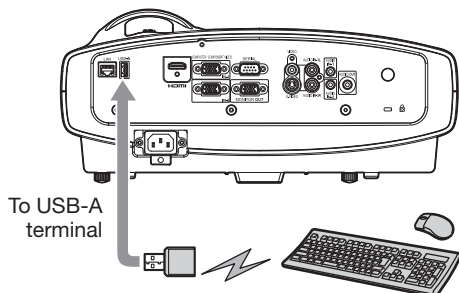

#### Important:

- The USB-A terminal on this projector is compatible with USB 2.0.
- Supported USB device is standard USB HID device with power consumption less than 5V/500mA.
- When using a keyboard and mouse together, we recommend a commercially available wireless keyboard and wireless mouse intended for a computer with wireless receiver.
- When using a USB hub, you are recommended to use the one with external power supply.
- Some USB hubs cannot be used depending on the specifications.

### Using SidePad function

While computer images are projected with the LAN Display, you can operate the computer from the tablet computer.

To use the SidePad function, you need to install the free software “MirrorOp Receiver” to the tablet computer.

You can use "SidePad Receiver" instead of MirrorOp Receiver.

Supported OS's of MirrorOp Receiver are as follows:

- iOS 3.2 or later
- Android 2.1 or later

#### Installation of software

1. Download the MirrorOp Receiver from the Internet to the tablet computer.
  - Connect to Apple Store to download the software for iOS.
  - Connect to Google Play to download the software for Android .
  - The communication fee to connect to Apple Store or Google Play will be borne by the customer.

#### Connection

Connect the projector, computer and tablet computer to the same network using a commercially available USB wireless LAN adapter, etc.

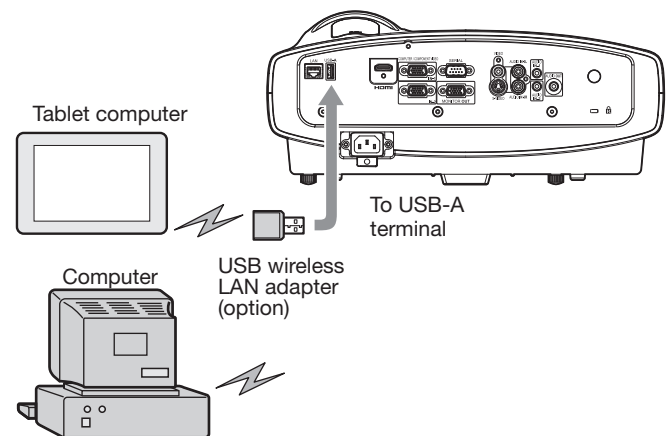

#### Important:

- Some USB wireless LAN adapters cannot be used depending on the specifications.

#### Starting SidePad

## Advanced display utilities (continued)

1. On the tablet computer, tap the MirrorOp Receiver icon “” to turn on MirrorOp Receiver.
  - The MirrorOp Receiver startup screen is displayed.



2. On the computer, click the Menu button on the main user interface to display the menu window and select [Launch SidePad -> MirrorOp Receiver].
  - Computer images are transferred to the tablet computer and you can operate the computer from the tablet computer.

### Important:

- If more than one tablet computer running MirrorOp Receiver exist in the same network, the device selection screen appears. Select the tablet computer where to transfer the computer images.
- You can use "SidePad Receiver" instead of MirrorOp Receiver.

### Ending SidePad

3. On the computer, click the Menu button on the main user interface to display the menu window and select [Stop SidePad -> MirrorOp Receiver].
  - Pressing the Home button on the tablet computer also turns off the SidePad.

## USB VIEWER

You can project JPEG images and the PtG contents stored in the USB device such as a USB flash drive without using a computer.

Also, you can perform effective presentation of them using the AutoRun function and the slideshow function.

To create PtG contents, you need to install the software “PtG Converter-Lite” contained in the attached CD-ROM.

### Important:

- Supported USB Flash drive format is FAT32.
- Only one logical partition in USB Flash drive is supported.
- Supported USB device is standard USB mass storage device with power consumption less than 5V/500mA.
- JPG file preview limitation:
  - File size: 10 MB or less
  - Pixel: 40 megapixel (24 bits) or less
  - Dimension: 8192x6144 or less
  - File Name: ASCII characters are supported.
  - Thumbnail: file thumbnail (obtained from EXIF) is supported.
- PtG file preview limitation:
  - File Name: ASCII characters are supported.
  - Thumbnail: file thumbnail is supported.
- USB VIEWER does not support the following image:
  - Extended DCT-based process
  - Lossless process
  - Hierarchical process
  - Progressive scan
  - Input format of YUV4:1:1, gray level with 16x16 pixels MCU
  - Decoded image width less than 64 pixels for YUV4:2:0/4:2:2 and 32 pixels for YUV4:4:4
  - Decoded height less than 32 pixels
  - Source images of 12-bits per sample

## Installation of PtG Converter-Lite

### About PtG Converter-Lite

PtG Converter-Lite is a software which converts PPT files created by Microsoft Office PowerPoint into PtG files that can be projected by USB VIEWER. Pause/page marks and animations contained in the PPT files are also converted.

### Features

- Converting up to 20 pages of PPT
- Converting into 800 x 600 / 1024 x 768 / 1280 x 800 \*16bpp PtG



## Advanced display utilities (continued)

### System requirement

- CPU:  
Intel® Pentium® M processor 1.5 GHz or above
- Memory:  
256 MB or more (recommended)
- OS:  
Windows XP Service Pack 3, Windows Vista and Windows 7
- Microsoft Office:  
Microsoft Office 2003, Microsoft Office 2007 and Microsoft Office 2010

### Installing PtG Converter-Lite

Before starting installation, be sure to read “ReadMe.txt” contained in the CD-ROM. Copy “PtG Converter-Lite\_v200.exe” contained in the TOOLS folder of CD-ROM to the hard disk of your computer.

1. Double-click “PtG Converter-Lite\_v200.exe”, and start up the installer of the PtG Converter-Lite.
2. Follow the on-screen instructions to install the software.

### When deleting PtG Converter-Lite (Uninstallation)

#### Important:

- When uninstalling PtG Converter-Lite, it should be ended in advance. If the application continues operating, uninstallation cannot be performed normally.
1. Select [Start]-[All Programs]-[PtG Converter]-[Uninstall].
  2. Follow the on-screen instructions to uninstall the software.
    - Logs and setting files are automatically deleted.

### Conversion of a PPT file to PtG file using the PtG Converter-Lite

1. Click the PtG Converter-Lite icon “

The image shows a dark application bar for PtG Converter-Lite. On the left is a 'Menu bar' with a right-pointing arrow. In the center is a 'PPT conversion button' with a circular arrow icon and the text 'PPT'. On the right is a close button with an 'X' icon.

- Menu bar  
Right-click to open the menu.
    - Output Resolution:  
Selects the resolution of the PtG file after the conversion.
    - Max Circle Animation:  
Selects the max time of animation.
    - About:  
Displays the software version information.
    - Exit:  
Exits the PtG Converter-Lite.
  - PPT conversion button:  
Starts the conversion from the PPT file to the PtG file.
2. Click the PPT conversion button.
    - The file selection screen appears.

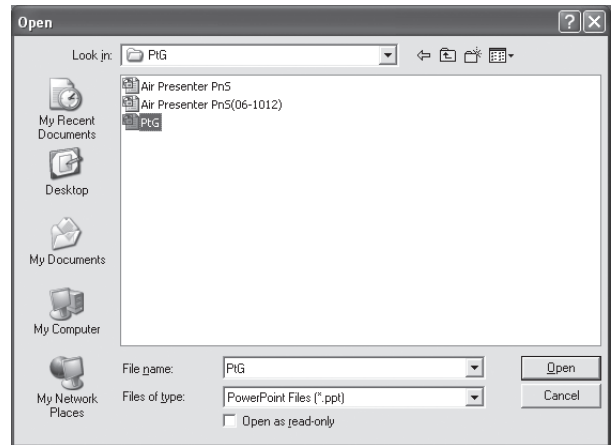

3. Select the PPT file you want to convert, and click [Open].
  - The screen for specifying the file destination and name appears.

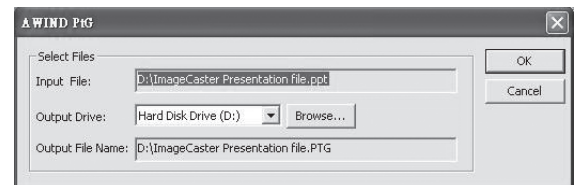

4. Set the file destination and the name.
  - The converted file is stored in the same folder as original file by default.
  - The name of the converted file is the same as original file's by default.
5. Click [OK] to start conversion.
6. When the conversion has been completed, click [OK].



#### Important:

- All the animation effects available on a computer display can be converted. However, the followings are not supported.
  - Animation effects with the timer setting or the repeat setting
  - Animation effects taking 60 seconds or more in a single movement
  - Pages having more than 3 second downtime setting
  - VBA object embedded files
  - OLE object embedded files

## Advanced display utilities (continued)

### Connection

Connect a USB device to the USB-A terminal on the projector.

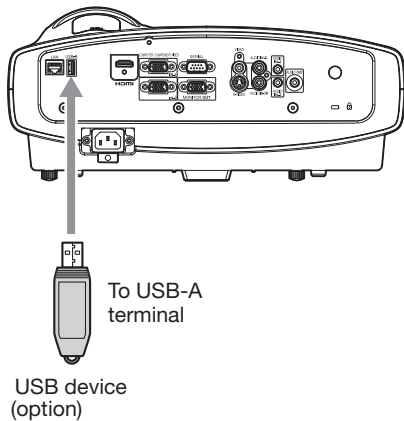

### Important:

- The USB-A terminal on this projector is compatible with USB 2.0.

### Performing the USB VIEWER

#### Selecting a USB VIEWER input

- Press the USB VIEWER button on the remote control or the SOURCE button on the projector, and select USB VIEWER.
  - When the USB VIEWER input is selected, the USB VIEWER screen appears.

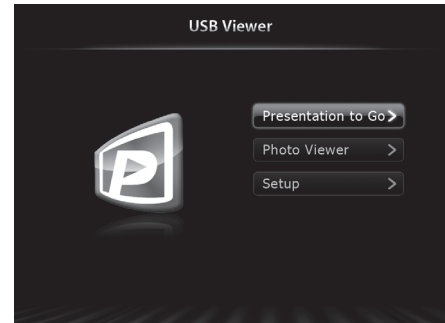

#### Setting up

- Press the ▲ or ▼ button on the projector or the remote control to select Setup and press the ENTER button.
  - The Setup screen appears.



- Press the ▲ or ▼ button to select a setting item and press the ◀ or ▶ button to change the setting.

- AutoRun:

Enables or disables the AutoRun and slideshow function.

	AutoRun	Slideshow
OFF	Disables.	Disables.
PtG	Enables for PtG files.	Enables for all files.
Photo	Enables for JPEG files.	Enables for all files.

- Interval:

Sets the interval for PtG pause mark or photo slideshow to 5/10/30/60/300 seconds.

- Repeat:

Enables or disables the repeat execution of AutoRun and slideshow function for photo files and PtG file.

- Sorting:

Sets the file sorting rule to File Name (Ascending), File Name (Descending), Time (New to Old) or Time (Old to New).

- To return to the USB VIEWER screen, press the ENTER button.

## Advanced display utilities (continued)

### Displaying PtG file

5. Press the ▲ or ▼ button on the projector or the remote control to select Presentation to Go and press the ENTER button.
  - The file selection screen appears.

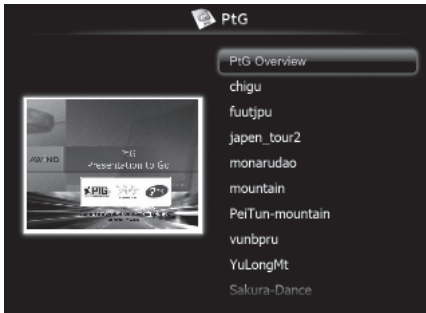

6. Press the ▲ or ▼ button to select a file or folder you want to display and press the ENTER button.
  - If you select a folder, the underlying file names are displayed. Then, select a file.
  - An image on page 1 is displayed on the screen.
7. Change the page by pressing the ▲, ▼ or ► button.
  - ▲ button: to previous page
  - ▼ button: to next page
  - ► button: to next phase
8. Press the ◀ button to quit the display.
  - The screen goes back to the file selection screen.

### Displaying JPEG file

5. Press the ▲ or ▼ button on the projector or the remote control to select Photo Viewer and press the ENTER button.
  - The file selection screen appears.

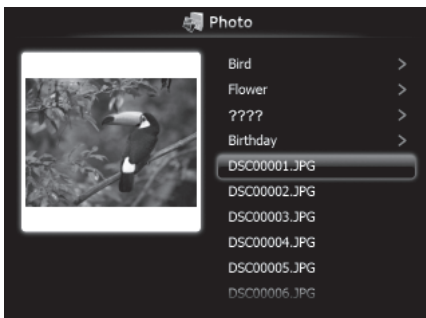

6. Press the ▲ or ▼ button to select a file or folder you want to display and press the ENTER button.
  - If you select a folder, the underlying file names are displayed. Then, select a file.
  - The image of the selected file is displayed on the screen.
7. Change the file by pressing the ▲, ▼ or ► button.
  - ▲ button: to previous file
  - ▼ button: to next file
  - ► button: to next file
8. Press the ◀ button to quit the display.
  - The screen goes back to the file selection screen.

### Displaying with AutoRun function

5. Create an "AUTORUN" folder in the root directory of the USB device using a computer or other.
6. Save a PtG file or JPEG files in the AUTORUN folder.

#### Important:

- The AutoRun function supports single PtG file only. The PtG file located on the top by sorting is played if multiple PtG files exists in AUTORUN folder.
7. Connect the USB device to the USB-A terminal.
    - The files specified by the AutoRun setting (PtG or Photo) are played back automatically.
  8. Press the ENTER button to start or pause the playback.
  9. Press the ▲, ▼ or ► button to change the file to be played back.
    - ▲ button: to previous page/previous file
    - ▼ button: to next page/next file
    - ► button: to next phase/next file
  10. Press the ◀ button to quit the AutoRun display.
    - The screen goes back to the file selection screen.

### Displaying with slideshow function

5. Press the ▲ or ▼ button on the projector or the remote control to select Presentation to Go or Photo Viewer and press the ENTER button.
  - The file selection screen appears.
6. Press the ▲ or ▼ button to select a file or folder you want to display and press the ENTER button.
  - If you select a folder, the underlying file names are displayed. Then, select a file.
  - When a PtG file is selected, the file is displayed with the slideshow.
  - When a JPEG file is selected, all the files in the same folder as the JPEG file exists are displayed with the slideshow.
7. Press the ENTER button to start or pause the playback.
8. Press the ▲, ▼ or ► button to change the file to be played back.
  - ▲ button: to previous page/previous file
  - ▼ button: to next page/next file
  - ► button: to next phase/next file
9. Press the ◀ button to quit the slideshow.
  - The screen goes back to the file selection screen.

### Ending the USB VIEWER

Unplug the USB device from the projector.

# Advanced features

## Password function



This projector is equipped with the password function that is designed for prevention of wrong operation by children and restriction on operation by other than specified users. The password function has 3 modes as follows.

**DISPLAY INPUT** ..... When the projector is turned on, the startup screen (or splash screen) will appear and stay on the screen until the password is entered. When the password is entered, the startup screen will switch to the regular operation screen.

**MENU ACCESS**..... All the buttons except for the POWER button on the projector are disabled. (The buttons on the remote control are enabled.) You can use this mode as a measure of prevention of wrong operation by children and restriction on operation by other than specified users.

**SPLASH ID SCREEN**... SPLASH SCREEN in the INSTALLATION menu become unavailable. SPLASH SCREEN will be set to ON automatically.

### To enable the password function:

1. Display the FEATURE menu.
2. Press the ▲ or ▼ button to select PASSWORD FUNCTION.
3. Press the ◀ or ▶ button to change the mode among DISPLAY INPUT , MENU ACCESS  and SPLASH ID SCREEN .
  - When the password has already been set, the mode won't be changed. In such cases, press the ENTER button to cancel the password function and try again.
4. Press the ENTER button.
  - The screen for setting the password function will appear.

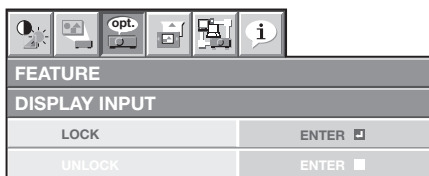

5. Press the ENTER button.
  - The screen for entering a password will appear.

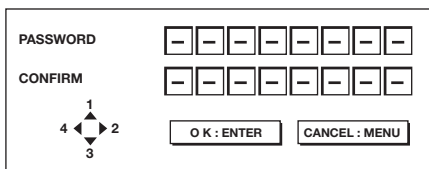

6. Enter a 4 - 8 digit password using the ▲, ▶, ▼ and ◀ buttons.  
(▲=1, ▶=2, ▼=3, ◀=4)
7. Press the ENTER button.
  - To cancel the procedure, press the MENU button.
8. Enter the password again for confirmation using the same steps.

9. Press the ENTER button.
  - If the entered passwords don't match, an error message will appear.
  - To cancel the procedure, press the MENU button.

### To cancel the password function:

1. Display the FEATURE menu.
2. Press the ▲ or ▼ button to select PASSWORD FUNCTION.
3. Press the ENTER button.
  - The screen for canceling the password function will appear.

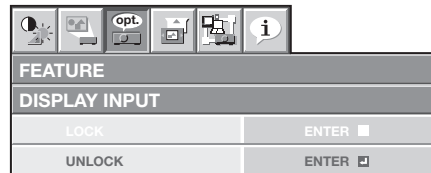

4. Press the ENTER button.
  - The screen for entering the password will appear.

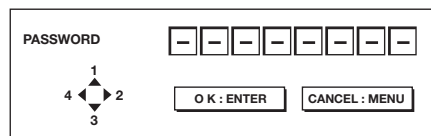

5. Enter a 4 - 8 digit password using the ▲, ▶, ▼ and ◀ buttons.  
(▲=1, ▶=2, ▼=3, ◀=4)
6. Press the ENTER button.
  - If you enter a wrong password, an error message will appear.
  - To cancel the procedure, press the MENU button.

### Important:

- You can disable the password by pressing the MENU and ENTER buttons on the projector at the same time for about 3 seconds.

## Advanced features (continued)

### Magnifying the displayed image

By pressing the MAGNIFY button on the remote control, you can magnify the image to view the details.

- While viewing the image from the COMPUTER1, COMPUTER2, HDMI, LAN DISPLAY, or USB VIEWER input source, you can magnify the image.

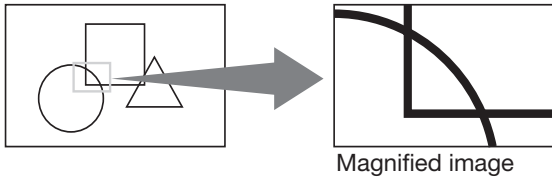

#### To use the MAGNIFY mode:

1. Press the MAGNIFY button on the remote control.
  - You can select the area to be magnified by pressing the ▲, ▼, ◀ or ▶ button on the remote control.
  - You can change the magnification of the selected area by pressing the + or - button.
2. Press the MAGNIFY button again to exit the MAGNIFY mode.
  - The regular operation screen will appear.

#### Important:

- The MAGNIFY mode doesn't function with some input signals. For details, see pages 72 and 73.
- In the MAGNIFY mode, you can't adjust the volume.

### Freeze

#### To stop the motion in the image temporarily (or to display a still image):

Press the FREEZE button on the remote control.

- The image will freeze temporarily.

#### To resume the motion in the image:

Press the FREEZE button on the remote control again.

#### Important:

- Do not display a still picture for a long time because the afterimages may persist on the screen. (See page 67.)

### Presentation timer

By pressing the TIMER button on the remote control, you can set up and display presentation timer on the screen.

- Presentation timer is available while viewing the image from the COMPUTER1, COMPUTER2, HDMI, LAN DISPLAY, or USB VIEWER input source.

#### To display the TIMER:

1. Press the TIMER button on the remote control.
  - The TIMER menu appears at the center of the screen.

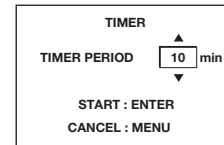

2. Press the ▲ or ▼ button to adjust the timer period.
  - The timer period can be set between 1 to 60 minutes.
  - The default timer period is 10 minutes.
  - The timer period changes 1-minute per step during the period is 1 to 20 minutes and 5-minute per step during the period is 20 to 60 minutes.
3. Press the ENTER button to start the countdown.
  - The countdown timer appears on top right corner of the screen.
  - When other OSD appears, the TIMER dialog disappears temporarily. The TIMER dialog reappears after the other OSD disappeared.
  - When the countdown is finished, it continues to count until the time reaches -10 minutes. Then the dialog disappears.
  - To stop the timer, press TIMER button and when a confirmation dialog appears, press the ENTER button.
  - If the input source is changed while the timer is working, the timer stops.

#### Important:

- In the following conditions, the countdown is cancelled:
  - When the power is turned off.
  - When the input source is changed.
  - When the input signal is lost.
  - When the test pattern is displayed.
- When the TIMER button is pressed while the countdown timer is displayed, countdown stop dialog appears. If ENTER button is pressed, the countdown stops.

## Advanced features (continued)

### Supervising and controlling by computer

You can supervise and control the projector's operation using a personal computer via a LAN.

#### Major functions

##### ProjectorView Global+

Batch projector controlling / supervising application software

- Batch operation of stand-alone projector / multiple projectors
- Scheduling function to turn ON/OFF for each day of the week
- Checking each condition of the projector and detecting a theft
- Setting of the projector's IP CONFIG
- Startup of the controlling / supervising tool (ProjectorView) using the Web browser
- Activating Visual PA2 to display the specified characters on the projector's screen
- Projector's Text Speech function to read aloud messages displayed on the Visual PA2 window

##### AMX Device Discovery

The projector is monitored and controlled by the control system of AMX.

##### Crestron RoomView Connected™

The projector is monitored and controlled by the control system and software of Crestron Electronics, Inc.

##### PJLink™

This projector supports standard protocol PJLink™ for projector control and you can control and monitor projector's operations using the same application among projectors of different models and different manufacturers.

##### About ProjectorView Global+

- For details, see "LAN control UTILITY operation manual" in the CD-ROM.

##### About AMX Device Discovery

- This is a technology suggested by AMX to facilitate configuration of the control system of AMX and its target devices.  
For details, see the website of AMX.  
URL <http://www.amx.com/>

##### About Crestron RoomView Connected™

- This is a technology suggested by Crestron Electronics, Inc. to facilitate configuration of the control system of Crestron and its target devices.  
For details, see the website of Crestron Electronics, Inc.  
URL <http://www.crestron.com>  
URL <http://www.crestron.com/getroomview/>

##### About PJLink™

- To use PJLink™ function, the PJLink™ application software is required.
- To use this function, set the network certification properly according to the setting of the network application to be used. (See page 40.)
- For the specifications of PJLink™, access to the Web site of Japan Business Machine and Information System Industries Association (JBMIA). (<http://pjlink.jbmia.or.jp/english>)
- This projector is fully compliant to the specifications of JBMIA PJLink™ Class 1. It supports all the commands defined by PJLink™ Class 1, and the compliance has been verified with the PJLink™ standard specifications Version 1.0.

##### Important:

- For the commands for PJLink™, see the table on the next page.
- The control may not be performed correctly or the monitoring data may not be obtained correctly in the following conditions:
  - During standby
  - During input source switching
  - During auto position execution
  - During AV mute
  - During command processing
  - Before the splash screen disappears after the power is turned on.
- During AV mute, etc., it may take approx. 5 seconds to receive a response to a command.
- Use 1 controller to control/monitor 1 projector.
- For how to control/monitor using PJLink™, see the operation manual of the PJLink™ application you use.
- When you monitor the projector's operating state using this function by issuing inquiry commands successively, issue an inquiry command after receiving the response to the previous inquiry command from the projector.



## Advanced features (continued)

### Connection

For details of the connection, see “LAN control UTILITY operation manual” in the CD-ROM.

**When STANDBY MODE of the INSTALLATION menu of the projector is set to LOW, the network function is disabled. To enable the network function, set STANDBY MODE to STANDARD or LAN. (See page 28.)**

Configure the initial network settings first.

You can configure the initial settings using the projector menu (see pages 40 to 45) or ProjectorView Global+ or ProjectorView. For details of ProjectorView Global+ and ProjectorView, see “LAN control UTILITY operation manual” in the CD-ROM.

### Using the User Manual

The User Manual for LAN Control Utility is prepared in the Portable Document Format (PDF) in the CD-ROM.

Opening the User Manual:

1. Load the CD-ROM into the CD-ROM drive.
2. Open CD-ROM “PROJECTOR.”
3. Double-click on “MANUAL\_LAN.HTML” within the CD-ROM. A language selection list for the User Manual will be displayed.
4. Move the mouse pointer to the desired language and click.

### PJLink™ supported commands

The table below shows commands to control the projector using the PJLink™ protocol.

Command	Description	Remark (Parameter)
POWR	Power control	0 = Standby 1 = Power on
POWR ?	Inquiry about the power state	0 = Standby 1 = Power on 2 = Cooling down 3 = Warming up
INPT	Input switching	11 = COMPUTER1    12 = COMPUTER2
INPT ?	Inquiry about input switching	21 = VIDEO        22 = S-VIDEO 31 = HDMI         41 = USB VIEWER        51 = LAN DISPLAY
AVMT	Mute control	30 = Video and audio mute disable
AVMT ?	Inquiry about the mute state	31 = Video and audio mute enable
ERST ?	Inquiry about the error state	1st byte: Fan error, 0 or 2 2nd byte: Light source error, 0 or 2 3rd byte: Temperature error, 0 or 2 4th byte: Cover open error, 0 or 2 5th byte: Always 0 6th byte: Other error, 0 or 2 0 to 2 mean as follows: 0 = No error detected, 1 = Warning, 2 = Error
LAMP ?	Inquiry about the lamp state	1st value (1 to 5 digits): Cumulative light source operating time (This item shows total light source operating hours.) 2nd value: 0 = Light source off, 1 = Light source on
INST ?	Inquiry about the available inputs	The following value is returned. “11 12 21 22 31 41 51”
NAME ?	Inquiry about the projector name	The projector name set on the NETWORK menu or the Crestron RoomView is returned.
INF1 ?	Inquiry about the manufacturer name	“MITSUBISHI” is returned.
INF2 ?	Inquiry about the model name	“NW30U” is returned.
INF0 ?	Inquiry about other information	No other information is available. No parameter is returned.
CLSS ?	Inquiry about the class information	“1” is returned.

- This projector is fully compliant to the specifications of JBMA PJLink™ Class 1. It supports all the commands defined by PJLink™ Class 1, and the compliance has been verified with the PJLink™ standard specifications Version 1.0.



# **Maintenance**

---

## **Warning:**

- Do not use flammable solvents (benzene, thinner, etc.) and flammable aerosols when cleaning the projector body and lens. Flammable substances may ignite causing fire or breakdown while the light source is illuminating.

## **Caution:**

- Be sure to turn off the light source and unplug the power cord from the wall outlet before you perform any maintenance on the projector.
- Ask your dealer for annual cleaning of the inside of the projector. If you continue to use the projector with dust inside, it may result in fire or malfunction.

## **Cleaning of the projector and the ventilation slots**

Use a soft cloth to clean the projector and the ventilation grilles. When the grilles become dirty, wipe them with a soft cloth dampened with diluted mild detergent, and then wipe them with a dry cloth.

To protect the surface of the projector from fading or deteriorating:

- Do not spray insecticide on or inside the projector.
- Do not use benzine or thinner to clean it.
- Do not let rubber or plastic materials contact with projector.

## **Cleaning of the lens**

Remove dust or dirt using the commercially available lens care products (such as cleaning paper or cloth for lens and blower brush).

- Since the lens surface is sensitive, do not scrub it with a solid object or tap on it.
- Do not wipe the lens with lens cleaner or solvent containing alcohol. Doing so may cause wipe marks or peel off the lens coating and the focus performance may be affected.
- Make sure to clean the lens after the light source is turned off and the lens is cooled sufficiently.

## **About the light source**

This light source is a consumable and its brightness decreases with the usage time. When the projected images become too dim, you can ask for a light source replacement. If you want to replace the light source, contact your dealer.























## **About the disposal of projector**

When you discard the projector, contact your dealer.

# Troubleshooting







Before asking for repair of the projector, check the following. If the symptom persists, stop using the projector, be sure to unplug the power plug, and then contact your dealer.

## No image appears on the screen.

Problem	Solution															
Power can not be turned on.	<ul style="list-style-type: none"> <li>Check whether the indicators are on or off and how they are lightning. <table border="1"> <thead> <tr> <th>POWER</th> <th>STATUS</th> <th>Solution</th> </tr> </thead> <tbody> <tr> <td>  Off </td> <td>  Off </td> <td> <ul style="list-style-type: none"> <li>Connect the power cord to the projector.</li> <li>Plug the power cord into a wall outlet.</li> </ul> </td> </tr> <tr> <td>  Steady red </td> <td>  Off </td> <td> <ul style="list-style-type: none"> <li>If any objects are blocking the intake or exhaust vents, remove them and carry out the following. <ol style="list-style-type: none"> <li>Unplug the power cord from the wall outlet.</li> <li>Make sure that the projector has cooled off.</li> <li>Plug the power cord into the wall outlet.</li> <li>Press the POWER button.</li> </ol> </li> </ul> </td> </tr> <tr> <td>  Blinking orange </td> <td>  Blinking orange </td> <td> <ul style="list-style-type: none"> <li>If any objects are blocking the air inlet or outlet grille, remove them.</li> <li>Don't expose the air outlet grilles to hot air emitted from a heating appliance.</li> </ul> </td> </tr> <tr> <td>  Blinking red/green </td> <td>-</td> <td> <ul style="list-style-type: none"> <li>Unplug the power cord from the wall outlet and contact your dealer.</li> </ul> </td> </tr> </tbody> </table> </li> </ul>	POWER	STATUS	Solution	 Off	 Off	<ul style="list-style-type: none"> <li>Connect the power cord to the projector.</li> <li>Plug the power cord into a wall outlet.</li> </ul>	 Steady red	 Off	<ul style="list-style-type: none"> <li>If any objects are blocking the intake or exhaust vents, remove them and carry out the following. <ol style="list-style-type: none"> <li>Unplug the power cord from the wall outlet.</li> <li>Make sure that the projector has cooled off.</li> <li>Plug the power cord into the wall outlet.</li> <li>Press the POWER button.</li> </ol> </li> </ul>	 Blinking orange	 Blinking orange	<ul style="list-style-type: none"> <li>If any objects are blocking the air inlet or outlet grille, remove them.</li> <li>Don't expose the air outlet grilles to hot air emitted from a heating appliance.</li> </ul>	 Blinking red/green	-	<ul style="list-style-type: none"> <li>Unplug the power cord from the wall outlet and contact your dealer.</li> </ul>
POWER	STATUS	Solution														
 Off	 Off	<ul style="list-style-type: none"> <li>Connect the power cord to the projector.</li> <li>Plug the power cord into a wall outlet.</li> </ul>														
 Steady red	 Off	<ul style="list-style-type: none"> <li>If any objects are blocking the intake or exhaust vents, remove them and carry out the following. <ol style="list-style-type: none"> <li>Unplug the power cord from the wall outlet.</li> <li>Make sure that the projector has cooled off.</li> <li>Plug the power cord into the wall outlet.</li> <li>Press the POWER button.</li> </ol> </li> </ul>														
 Blinking orange	 Blinking orange	<ul style="list-style-type: none"> <li>If any objects are blocking the air inlet or outlet grille, remove them.</li> <li>Don't expose the air outlet grilles to hot air emitted from a heating appliance.</li> </ul>														
 Blinking red/green	-	<ul style="list-style-type: none"> <li>Unplug the power cord from the wall outlet and contact your dealer.</li> </ul>														
No image appears on the screen.	<ul style="list-style-type: none"> <li>Press the AV MUTE button to cancel AV MUTE.</li> <li>Check that the lens cap is removed.</li> <li>Check that the intake vent is clean.</li> <li>Check that the cables connected to the external devices are not broken.</li> <li>When an extension cable is being used, replace it with the supplied cable for check. When images are displayed correctly, add an RGB signal amplifier to the extension cable.</li> <li>Check any object is not placed in front of Intelligent glare sensor. (See page 13.)</li> </ul>															
Power turns off.	<ul style="list-style-type: none"> <li>This problem may occur when the intake vent and/or exhaust vents are blocked. (In such a case, the STATUS indicator brinks orange.) <ul style="list-style-type: none"> <li>Remove the objects blocking the intake vent and/or exhaust vents and then carry out the following procedure. <ol style="list-style-type: none"> <li>Wait for the intake fan and/or exhaust fan to stop. (Wait until the STATUS indicator goes out.)</li> <li>Unplug the power cord from the wall outlet.</li> <li>Wait about 10 minutes.</li> <li>Plug the power cord into a wall outlet.</li> <li>Press the POWER button.</li> </ol> </li> </ul> </li> <li>Check that AUTO POWER OFF has been set to OFF.</li> </ul>															
The screen for entering the password appears.	<ul style="list-style-type: none"> <li>PASSWORD FUNCTION in the FEATURE menu has been set to DISPLAY INPUT  to enable the password lock. <ul style="list-style-type: none"> <li>Enter the password or contact the person in charge of management of the projector. (See page 61.)</li> </ul> </li> </ul>															
"NO SIGNAL" is displayed.	<ul style="list-style-type: none"> <li>Turn on the power of the connected device, or check whether there is something wrong with the connected device.</li> <li>Check whether the external device output signals. (Check this especially when the external device is a laptop computer.)</li> <li>Check that the cable connected to the external device isn't defective.</li> <li>Check that the projector is connected to the external device using the correct terminals.</li> <li>Check that the connected device is correctly selected as the input source.</li> <li>When an extension cord is being used, replace it with the supplied cable and check whether images are projected correctly. If images are projected correctly, use an RGB signal amplifier along with the extension cord.</li> </ul>															

## Troubleshooting (continued)

### Images are not displayed correctly.

Problem	Solution						
Projected images are shaking. Projected images are displaced.	<ul style="list-style-type: none"> <li>• Check that the cable connected to the external device isn't intermittent.</li> <li>• Connect the cable's plug with the external device's connector firmly.</li> <li>• Project an image containing many characters such as a help menu and press the AUTO POSITION button.</li> <li>• Some computers output out-of-spec signals on rare occasion. Adjust the SIGNAL menu. (See page 31.)</li> <li>• Check whether there is a wind that blows the exhausted air from the projector to the direction of the projection lens.</li> </ul>						
Projected images are distorted.	<ul style="list-style-type: none"> <li>• Adjust the projector and the screen so that they are perpendicular to each other. (See page 12.)</li> </ul>						
Projected images are dark.	<ul style="list-style-type: none"> <li>• Adjust BRIGHTNESS and CONTRAST in the IMAGE menu. (See page 27.)</li> <li>• Decrease the temperature when the ambient temperature is high and the warning is displayed.</li> </ul>						
Projected images are blurred.	<ul style="list-style-type: none"> <li>• Adjust the focus. (See page 19.)</li> <li>• Clean the lens. (See page 65.)</li> <li>• Press the ◀ or ▶ button on the remote control to eliminate flicker.</li> <li>• Adjust TRACKING and FINE SYNC. in the SIGNAL menu. (See page 31.)</li> <li>• Adjust BRIGHTNESS and CONTRAST in the IMAGE menu. (See page 27.)</li> <li>• Adjust the projector and the screen so that they are perpendicular to each other. (See page 13.)</li> <li>• Set OVERSCAN in the SIGNAL menu to 100%. (See page 31.)</li> <li>• Set KEYSTONE in the KEYSTONE function to 0. (See page 13.)</li> </ul>						
Afterimages persist on the screen.	<ul style="list-style-type: none"> <li>• This phenomenon is improved by keeping projecting an evenly bright image. (Such "image burn-in" phenomenon where afterimages persist on the screen may occur if a stationary image is kept displayed on the screen for a long time.)</li> </ul>						
White dots are seen on projected images. Black dots are seen on projected images.	<ul style="list-style-type: none"> <li>• This symptom is normal for a DLP™ projector and is not a malfunction. (A very small number of pixels may stay lit or out, but such symptom is not a malfunction. Pixels of 99.99% or more are effective.)</li> </ul>						
Fine streaks are seen on projected images.	<ul style="list-style-type: none"> <li>• This is due to interference with the screen surface and is not a malfunction. Replace the screen or displace the focus a little.</li> <li>• Vertical or horizontal streak noise may appear on the projected image, depending on the type of the DVD player or game console you use. In such a case, you can reduce such streak noise by enabling the LPF.</li> </ul>						
Projected images become wavy.	<ul style="list-style-type: none"> <li>• Connect the plugs of the cables to external devices securely.</li> <li>• Keep the projector away from devices that emit interfering radio waves.</li> <li>• When the keystone adjustment is carried out, the image may not be displayed correctly depending on the type of input signal. This isn't a product malfunction. In this case, readjust the keystone so that the amount of keystone correction is as small as possible.</li> </ul>						
Hue is not appropriate.	<ul style="list-style-type: none"> <li>• Check that the cables connected to the external devices are not broken.</li> <li>• Check whether the indicators are on or off and how they are lighting. <table border="1" data-bbox="453 1592 1485 1727"> <thead> <tr> <th>POWER</th> <th>STATUS</th> <th>Solution</th> </tr> </thead> <tbody> <tr> <td style="text-align: center;">  Steady green </td> <td style="text-align: center;">  Blinking green/orange </td> <td> <ul style="list-style-type: none"> <li>• Press the POWER button to turn off the light and unplug the power cord from the wall outlet. Wait about 10 minutes, plug the power cord in, and try again. If the condition is not improved, contact your dealer.</li> </ul> </td> </tr> </tbody> </table> </li> <li>• If RGB/YC<sub>b</sub>C<sub>r</sub> output setting of the external device does not match with the COMPUTER INPUT setting in the SIGNAL menu on the projector, the entire screen may become reddish or greenish.</li> <li>• If the setting of COMPUTER INPUT in the SIGNAL menu is inconsistent with the RGB/YC<sub>b</sub>C<sub>r</sub> output setting of the external device even when the input source is other than COMPUTER (for example, when the input source is HDMI), the entire image appears reddish or greenish. → Check that COMPUTER INPUT in the SIGNAL menu is set correctly.</li> </ul>	POWER	STATUS	Solution	 Steady green	 Blinking green/orange	<ul style="list-style-type: none"> <li>• Press the POWER button to turn off the light and unplug the power cord from the wall outlet. Wait about 10 minutes, plug the power cord in, and try again. If the condition is not improved, contact your dealer.</li> </ul>
POWER	STATUS	Solution					
 Steady green	 Blinking green/orange	<ul style="list-style-type: none"> <li>• Press the POWER button to turn off the light and unplug the power cord from the wall outlet. Wait about 10 minutes, plug the power cord in, and try again. If the condition is not improved, contact your dealer.</li> </ul>					

## Troubleshooting (continued)

### Images are not displayed correctly. (continued)

Problem	Solution
Tint in projected images is incorrect.	<ul style="list-style-type: none"> <li>• Check that COMPUTER INPUT in the SIGNAL menu is correctly set. (See page 31.)</li> <li>• Check that the cables connected to the external devices are not broken.</li> </ul>
Different color tint.	<ul style="list-style-type: none"> <li>• When comparing images projected by two projectors, tints in the displayed images may be different because of variation between their optical components. This is not a malfunction.</li> <li>• When comparing the image projected by this projector with those displayed on the television or PC monitor, tints in the displayed images may be different because of difference in the range of color reproducibility. This is not a malfunction.</li> </ul>
Only the motion areas in the images supplied from the computer aren't displayed.	<ul style="list-style-type: none"> <li>• This is caused by the computer being used. Contact the manufacturer of your computer.</li> </ul>
Projected images are obscured.	<ul style="list-style-type: none"> <li>• Match the output resolution of your computer with the resolution of the projector. For the method to change the output resolution of the computer, contact the manufacturer of your computer. (See pages 72 and 73.)</li> <li>• Some images and texts appear obscured during the keystone adjustment. In such cases, use the projector without applying the keystone adjustment. (See page 13.)</li> </ul>
Noise appears around the image.	<ul style="list-style-type: none"> <li>• In some images such as DVD, noise may appear around the recorded image. In this case, decrease the setting value of OVER SCAN of the SIGNAL menu. (See page 31.)</li> </ul>
Images of WXGA signal are not displayed correctly.	<ul style="list-style-type: none"> <li>• Make adjustment according to "How to adjust the computer image" on page 37.</li> </ul>

### Others

Problem	Solution
The exhaust vents emit warm air.	<ul style="list-style-type: none"> <li>• This air comes out after cooling the inside of the projector. You may feel hot, but this is not a malfunction.</li> </ul>
No audio is output.	<ul style="list-style-type: none"> <li>• Check that the volume isn't set to low.</li> <li>• Check the setting of AUDIO INPUT (PROJECTION) in the INSTALLATION menu.</li> <li>• When the external device is connected with an HDMI cable, set the audio output of the device to PCM output.</li> <li>• In case you are using LAN Display System on Windows XP or Mac OS X, you have to install an audio driver to enable audio. For the details, see "Installing the virtual audio driver" in the "Advanced display utilities".</li> </ul>
The menu can't be used.	<ul style="list-style-type: none"> <li>• The microcomputers inside the projector may be wrongly operating because of noise. <ul style="list-style-type: none"> <li>→ Press the POWER button to turn off the light and unplug the power cord from the wall outlet. Wait about 10 minutes, plug the power cord in, and try again.</li> </ul> </li> <li>• You cannot select (or set) grayed-out items. Whether items can be selected or not depends on the presence of an input signal at the time when the menu is displayed, the type of such input signal, and other conditions.</li> </ul>
"TEMPERATURE!!" is displayed.	<ul style="list-style-type: none"> <li>• This indication appears when the ambient temperature rises high. When the ambient temperature stays high, the light goes out. <ul style="list-style-type: none"> <li>→ Eliminate any causes of the rise in the ambient temperature.</li> </ul> </li> <li>• This indication appears when the air inlet or outlet grille is blocked. When they are kept blocked, the light goes out. <ul style="list-style-type: none"> <li>→ Remove the objects blocking the air inlet or outlet grille.</li> </ul> </li> </ul>
The ☉ mark appears.	<ul style="list-style-type: none"> <li>• This mark appears when ineffective operation is carried out. This isn't a product malfunction.</li> </ul>
The remote control doesn't function easily or at all.	<ul style="list-style-type: none"> <li>• Check that the batteries are loaded in the remote control or the batteries are not weak. (See page 6.)</li> <li>• Check that the remote control sensor isn't exposed to direct sunlight or fluorescent light. (See page 9.)</li> <li>• Use the remote control within its operation range. (See page 9.)</li> <li>• Use the remote control at least 10 cm away from the projector.</li> </ul>

## Troubleshooting (continued)

### Others (continued)

Problem	Solution
The buttons on the projector (except for the POWER button) don't function.	<ul style="list-style-type: none"> <li>PASSWORD FUNCTION in the FEATURE menu has been set to MENU ACCESS <input checked="" type="checkbox"/> to enable the password lock. → Cancel the password lock or contact the person in charge of management of the projector. (See page 61.)</li> </ul>
The fans sound during standby.	<ul style="list-style-type: none"> <li>When STANDBY MODE in the INSTALLATION menu is set to STANDARD, the fans rotate at very low speed during standby after plugging the power cord (with 5 second high speed rotation at the beginning) and after turning off the light source. This is to cool down the projector operating various functions during standby and is not a malfunction.</li> </ul>
Abnormal sound is heard.	<ul style="list-style-type: none"> <li>Because the motor spins at a high speed, metallic sounds may be heard in rare occasions. Such symptom is not a malfunction.</li> </ul>
Images are not 3D. * Use commercially available 3D glasses supporting the DLP™ Link™ system. No 3D glasses are supplied with the projector.	<ul style="list-style-type: none"> <li>Is the 3D mode of the projector set properly for the image? → Set 3D FORMAT in the IMAGE-3D menu of the projector properly for the image (SIDE BY SIDE <input checked="" type="checkbox"/>, TOP AND BOTTOM <input checked="" type="checkbox"/> or FRAME SEQUENTIAL <input checked="" type="checkbox"/>.</li> <li>View 3D images from the front of the screen. At an angle to the screen, you may not be able to view proper 3D images.</li> <li>Is there any obstacle between the 3D glasses and the screen? Or, is there any sticker or label over the sensor of the 3D glasses? → The 3D glasses work by receiving signals of the images being viewed. Check that there is no obstacle between the 3D glasses and the screen.</li> <li>Are you viewing images from a very close distance? → Viewing images from a very close distance may not obtain the 3D effect. View images from a proper distance.</li> <li>The 3D glasses may become out of sync due to fluorescent light. Turn off the fluorescent light.</li> <li>Are the 3D glasses turned off? → Turn on the 3D glasses.</li> <li>The signals listed in the table on pages 72 and 73 can be displayed in 3D format. You cannot view other signals in 3D format even when you set 3D FORMAT in the IMAGE-3D menu to AUTO <input checked="" type="checkbox"/>, SIDE BY SIDE <input checked="" type="checkbox"/>, TOP AND BOTTOM <input checked="" type="checkbox"/>, or FRAME SEQUENTIAL <input checked="" type="checkbox"/>.</li> <li>You may not obtain the 3D effect depending on the capabilities of your computer (including the graphic board, memory, and CPU).</li> <li>You cannot view 3D images when the LAN DISPLAY or USB VIEWER is selected.</li> </ul>
There is something wrong with the 3D images. * Use commercially available 3D glasses supporting the DLP™ Link™ system. No 3D glasses are supplied with the projector.	<ul style="list-style-type: none"> <li>Depending on the 3D image status, you may feel something wrong with the 3D images. → Switch the 3D Sync. Invert setting of the projector to check whether or not such feeling is eliminated.</li> <li>The 3D glasses may become out of sync due to fluorescent light. Turn off the fluorescent light.</li> <li>View 3D images from the front of the screen. At an angle to the screen, you may not be able to view proper 3D images.</li> </ul>
The 3D glasses don't turn on. * Use commercially available 3D glasses supporting the DLP™ Link™ system. No 3D glasses are supplied with the projector.	<ul style="list-style-type: none"> <li>Are the batteries of the 3D glasses still working? → If the 3D glasses don't activate even when you turn on the power switch, replace or charge the batteries of the 3D glasses. For details, see the user manual of the 3D glasses.</li> </ul>

# Indicators

This projector has two indicators, each of which shows the operation condition of the projector. The following offer solutions to possible problems. If these problem persist, turn the projector off and consult your dealer.

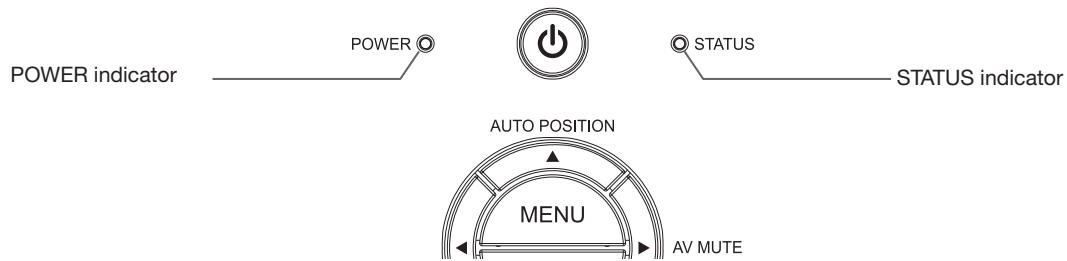

## Normal condition

POWER	STATUS	CONDITION	NOTE
 Steady red	 Off	Power standby	
	 Blinking green	System shutting down	The power cannot be turned on by pressing the POWER button.
 Steady green	 Blinking green	System starting up	The power cannot be turned off by pressing the POWER button.
	 Steady green	The power is on. (Normal condition)	

## Abnormal condition

POWER	STATUS	CONDITION	POSSIBLE SOLUTION
 Blinking green/red	 Off	Safety lock	Unplug the power cord from the wall outlet and contact your dealer.
	 Steady or Blinking	Abnormal.	Unplug the power cord from the wall outlet and contact your dealer.
 Steady green or Steady red	 Blinking orange	Abnormal temperature <ul style="list-style-type: none"> <li>The ventilation grilles are clogged with dust or dirt.</li> <li>The projector is exposed to hot air emitted from a heating appliance.</li> </ul>	<ul style="list-style-type: none"> <li>Clean the ventilation grilles.</li> <li>Relocate the projector to a cooler place.</li> </ul>
 Steady red	 Blinking green	The light source is in an abnormal condition.	Unplug the power cord from the wall outlet and contact your dealer.
 Steady green or Steady red	 Blinking green/orange		

# Specifications

The specifications and outside appearance of the projector are subject to change without prior notice.

Type	DLP™ projector		
Model	NW30U		
Display technology	0.65-inch single chip Digital Micromirror Device (DMD) Pixels: 1280 x 800 = 1024000 pixels		
Projection lens	F 2.4 - 2.9 f= 20.7 - 31.0 mm		
Light-source	LED and laser		
Image size	40 - 300 inch (Wide) (aspect ratio 16:10)		
Maximum resolution	Computer signal	Maximum resolution: 1920 x 1200 dots (compressed) Panel resolution: 1280 x 800 dots	
	Video signal	NTSC/PAL/SECAM/4.43NTSC/PAL-M/PAL-N/PAL-60	
	Component signal	480i, 480p, 576i, 576p, 720p, 1080i, 1080p Panel resolution: 1280 x 800 dots	
Computer/component video input	[Signal type] Analog RGB	[Terminal type] Mini D-SUB 15-pin	[Line] 2
Video input	[Signal type] Video input	[Terminal type] RCA	[Line] 1
	[Signal type] S-video input	[Terminal type] S	[Line] 1
Audio input	[Signal type] RGB/Component	[Terminal type] Stereo mini jack (ø3.5)	[Line] 2
	[Signal type] Video/S-video	[Terminal type] RCA (L, R)	[Line] 1
HDMI input	[Signal type] HDMI	[Terminal type] HDMI 19-pin	[Line] 1
Monitor output	[Signal type] Analog RGB	[Terminal type] Mini D-SUB 15-pin	[Line] 1
Audio output		[Terminal type] Stereo mini jack (ø3.5)	[Line] 1
Speaker	10 W Mono Round type x 1		
Control terminal/others	RS-232C (D-SUB 9-pin), LAN (RJ-45), USB Type-A		
Operating temperatures	+41°F (+5°C) to +95°F (+35°C)		
Projection angles	Standard altitude mode: All projection angle of front and rear direction High altitude mode: Floor installation/ceiling installation		
Rated voltage	AC 100 - 240 V, 50/60 Hz		
Power consumption	3.4 A, 300 W During standby: AC 100 - 120 V: 0.2 W (when STANDBY MODE is LOW) AC 220 - 240 V: 0.3 W (when STANDBY MODE is LOW)		
Dimensions	376 mm (W) x 139 mm (H) x 311 mm (D) (not including protrusion)		
Weight	4.9 kg		
Others	S-video input	Luminance signal: Vp-p=1.0 V 75 Ω (negative sync) Chrominance signals: Vp-p=0.286 V 75 Ω (burst signal)	
	Video input	Vp-p=1.0 V 75 Ω (negative sync)	
	Component video input	YCbCr: Vp-p=1.0 V 75 Ω (Y) (negative sync) Vp-p=0.7 V 75 Ω (Cb, Cr)	
	Analog input	RGB: Vp-p=0.7 V 75 Ω (negative sync) YCbCr: Vp-p=1.0 V (Y) (negative sync) Vp-p=0.7 V (Cb, Cr) HD/GS: TTL-level (negative or positive polarity) VD: TTL-level (negative or positive polarity)	
	Digital input (HDMI)	HDMI interface (TMDS single link) (Only PCM audio is supported.)	
Audio input	350 mVrms, 10 kΩ or more		



# Specifications (continued)

## Specification of RGB signals in each computer mode of the projector

Signal mode	Resolution (H x V)	Horizontal frequency (kHz)	Vertical frequency (Hz)	Normal mode (H x V)	Plug and Play *5		3D supported mode				
					COMPUTER / COMPONENT VIDEO IN terminal	HDMI IN terminal	FS *1	FP *2	SS *3	TB *4	
TV60, 480i (525i)	-	15.730	59.940	1066 x 800	○		○				*6
TV50, 576i (625i)	-	15.630	50.000	1066 x 800	○						*6
1080i60 (1125i60)	-	33.750	60.000	1280 x 720		○	○		○		*6
1080i50 (1125i50)	-	28.130	50.000	1280 x 720		○			○		*6
480p (525p)	-	31.470	59.940	1066 x 800		○	○				*6
576p (625p)	-	31.250	50.000	1066 x 800		○					*6
720p60 (750p60)	-	45.000	60.000	1280 x 720		○	○	○	○	○	*6
720p50 (750p50)	-	37.500	50.000	1280 x 720		○		○	○	○	*6
1080p60 (1125p60)	-	67.500	60.000	1280 x 720		○			○	○	*6
1080p50 (1125p50)	-	56.250	50.000	1280 x 720		○			○	○	*6
1080p24 (1125p24)	-	27.000	24.000	1280 x 720		○		○	○	○	*6
PC98	640 x 400	24.820	56.420	1280 x 800							
CGA70	640 x 400	31.470	70.090	1280 x 800							
CGA84	640 x 400	37.860	84.130	1280 x 800							
CGA85	640 x 400	37.860	85.080	1280 x 800							
VGA60	640 x 480	31.470	59.940	1066 x 800	○	○	○				
VGA72	640 x 480	37.860	72.810	1066 x 800	○						
VGA75	640 x 480	37.500	75.000	1066 x 800	○						
VGA85	640 x 480	43.270	85.010	1066 x 800							
MAC13	640 x 480	35.000	66.670	1066 x 800	○						
VGA120	640 x 480	61.800	120.000	1066 x 800	○						
SVGA56	800 x 600	35.160	56.250	1066 x 800	○						
SVGA60	800 x 600	37.880	60.320	1066 x 800	○	○	○				
SVGA72	800 x 600	48.080	72.190	1066 x 800	○						
SVGA75	800 x 600	46.880	75.000	1066 x 800	○						
MAC16	832 x 624	49.720	74.550	1066 x 800	○						
SVGA85	800 x 600	53.670	85.060	1066 x 800	○						
SVGA95	800 x 600	59.970	94.890	1066 x 800	○						
SVGA120RB	800 x 600	76.302	119.972	1066 x 800	○						
XGA60	1024 x 768	48.360	60.000	1066 x 800	○	○	○				
XGA70	1024 x 768	56.480	60.000	1066 x 800	○						
XGA75	1024 x 768	60.020	70.070	1066 x 800	○						
MAC19	1024 x 768	60.240	75.020	1066 x 800	○						
HP75	1024 x 768	62.940	74.920	1066 x 800							
XGA85	1024 x 768	68.680	85.000	1066 x 800							
XGA120RB	1024 x 768	97.551	119.989	1066 x 800	○	○	○				
SXGA70a	1152 x 864	63.850	70.010	1066 x 800							
SXGA75a	1152 x 864	67.500	75.000	1066 x 800							
SXGA85a	1152 x 864	77.490	85.060	1066 x 800	○						
SUN66a	1152 x 900	61.850	66.000	1066 x 800							
SUN76a	1152 x 900	71.810	76.640	1066 x 800							
WXGA60RB	1280 x 768	47.396	59.995	1280 x 768							
WXGA60	1280 x 768	47.780	59.870	1280 x 768		○	○				
WXGA75	1280 x 768	60.289	74.893	1280 x 768							
WXGA85	1280 x 768	68.633	84.837	1280 x 768							
WXGA120	1280 x 768	97.396	119.798	1280 x 768	○	○	○				
SXGA60b	1280 x 960	60.000	60.000	1066 x 800	○	○					
SXGA75b	1280 x 960	75.000	75.000	1066 x 800	○						
WXGA60a	1280 x 800	49.702	59.810	1280 x 800	○	○	○				
WXGA60b	1366 x 768	47.710	60.020	1280 x 723							
WXGA60c	1366 x 768	47.710	59.790	1280 x 720	○						
WXGA60aR	1280 x 800	49.306	59.910	1280 x 800							
WXGA60cRB	1366 x 768	47.500	59.750	1280 x 723							
WXGA75a	1280 x 800	62.795	74.934	1280 x 800							
WXGA85a	1280 x 800	71.554	84.880	1280 x 800							
WXGA120aRB	1280 x 800	101.563	119.909	1280 x 800	○	○	○				
SXGA85b	1280 x 960	85.940	85.000	1066 x 800							
SXGA120RB	1280 x 960	121.875	119.838	1066 x 800							
SXGA60	1280 x 1024	63.981	60.020	1000 x 800		○					
SXGA75	1280 x 1024	79.976	75.025	1000 x 800	○						
SUN66	1280 x 1024	71.680	66.680	1000 x 800							
SUN76	1280 x 1024	81.130	76.110	1000 x 800							
SIG72	1280 x 1024	76.920	72.300	1000 x 800							
SIG76	1280 x 1024	82.010	76.000	1000 x 800							

## Specifications (continued)

### Specification of RGB signals in each computer mode of the projector (continued)

Signal mode	Resolution (H x V)	Horizontal frequency (kHz)	Vertical frequency (Hz)	Normal mode (H x V)	Plug and Play *5		3D supported mode			
					COMPUTER/COMPONENT VIDEO IN terminal	HDMI IN terminal	FS *1	FP *2	SS *3	TB *4
SXGA85	1280 x 1024	91.146	85.024	1000 x 800	○					
SXGA120RB	1280 x 1024	130.035	119.958	1000 x 800						
SXGA--60	1360 x 768	47.712	60.015	1280 x 723						
SXGA-120RB	1360 x 768	97.533	119.967	1280 x 723						
SXGA-60	1366 x 768	47.712	59.790	1280 x 723		○				
SXGA-60RB	1366 x 768	48.000	60.000	1280 x 723						
SXGA+60RB	1400 x 1050	63.980	60.020	1066 x 800						
SXGA+60	1400 x 1050	65.320	59.950	1066 x 800	○	○				
SXGA+75	1400 x 1050	82.280	74.870	1066 x 800						
SXGA+85	1400 x 1050	93.881	84.960	1066 x 800						
WXGA+60RB	1440 x 900	55.469	59.901	1280 x 800						
WXGA+60	1440 x 900	55.940	59.890	1280 x 800	○	○				
WXGA+75	1440 x 900	70.635	74.984	1280 x 800						
WXGA+85	1440 x 900	80.430	84.842	1280 x 800						
WXGA+120RB	1440 x 900	114.219	119.852	1280 x 800						
WXGA++60	1600 x 900	60.000	60.000	1280 x 800						
UXGA60	1600 x 1200	75.000	60.000	1066 x 800	○	○				
UXGA65	1600 x 1200	81.250	65.000	1066 x 800						
UXGA70	1600 x 1200	87.500	70.000	1066 x 800						
UXGA75	1600 x 1200	93.750	75.000	1066 x 800						
UXGA85	1600 x 1200	106.250	85.000	1066 x 800						
WSXGA+60RB	1680 x 1050	64.674	59.883	1280 x 800						
WSXGA+60	1680 x 1050	65.290	59.954	1280 x 800	○					
WSXGA+75	1680 x 1050	82.306	74.892	1280 x 800						
WSXGA+85	1680 x 1050	93.900	85.000	1280 x 800						
WUXGA60RB	1920 x 1200	74.038	59.950	1280 x 800	○	○	○			
WUXGA60	1920 x 1200	74.556	59.885	1280 x 800						

\*1 FS: Field Sequential

\*2 FP: Frame Packing

\*3 SS: Side by Side

\*4 TB: Top and Bottom

\*5 Signals marked with ○ in the Plug and Play column are described in EDID (extended display identification data) of the projector. Signals described in the Signal mode column can be input regardless of the ○ mark in the Plug and Play column. For signals not marked with ○ in the Plug and Play column, the resolution may not be supported even when it is supported on the computer.

\*6 The MAGNIFY mode don't function with these signals.

#### Important:

- Some computers aren't compatible with the projector.
- The projector's maximum resolution is 1280 x 800 pixels. It may not display images of higher resolutions than 1280 x 800 correctly.
- Images with SYNC on G (Green) signal may jitter.
- Images with SYNC on G (Green) signal may be tinged with green.
- If the resolution and frequency of your computer aren't shown on the table, find the compatible resolution and frequency by changing the resolution of your computer.
- TV60 and TV50 are equivalent to 480i and 576i respectively. When these signals are supplied to the VIDEO IN or S-VIDEO IN terminal, the signal mode is indicated as TV60 or TV50. When they are supplied to the COMPUTER/COMPONENT/VIDEO IN terminals, the signal mode is indicated as 480i or 576i.
- This projector doesn't support 480p signals from video devices having 4 lines (R, G, B, CS\*) or having 5 lines (R, G, B, H, V).

\* : Composite Sync

# Specifications (continued)

## Connectors

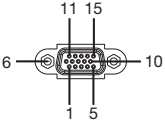
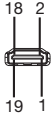
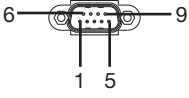
COMPUTER/COMPONENT VIDEO IN, MONITOR OUT (Mini D-SUB 15-pin)		HDMI (HDMI 19-pin)	SERIAL (D-SUB 9-pin)																																																																																																																																						
																																																																																																																																									
COMPUTER/COMPONENT VIDEO IN	MONITOR OUT																																																																																																																																								
<table border="1"> <thead> <tr> <th>Pin No.</th> <th>Spec.</th> </tr> </thead> <tbody> <tr><td>1</td><td>R (RED)/C<sub>R</sub></td></tr> <tr><td>2</td><td>G (GREEN)/Y</td></tr> <tr><td>3</td><td>B (BLUE)/C<sub>B</sub></td></tr> <tr><td>4</td><td>GND</td></tr> <tr><td>5</td><td>GND</td></tr> <tr><td>6</td><td>GND</td></tr> <tr><td>7</td><td>GND</td></tr> <tr><td>8</td><td>GND</td></tr> <tr><td>9</td><td>DDC 5V</td></tr> <tr><td>10</td><td>GND</td></tr> <tr><td>11</td><td>GND</td></tr> <tr><td>12</td><td>DDC Data</td></tr> <tr><td>13</td><td>HD/CS</td></tr> <tr><td>14</td><td>VD</td></tr> <tr><td>15</td><td>DDC Clock</td></tr> </tbody> </table>	Pin No.	Spec.	1	R (RED)/C <sub>R</sub>	2	G (GREEN)/Y	3	B (BLUE)/C <sub>B</sub>	4	GND	5	GND	6	GND	7	GND	8	GND	9	DDC 5V	10	GND	11	GND	12	DDC Data	13	HD/CS	14	VD	15	DDC Clock	<table border="1"> <thead> <tr> <th>Pin No.</th> <th>Spec.</th> </tr> </thead> <tbody> <tr><td>1</td><td>R (RED)/C<sub>R</sub></td></tr> <tr><td>2</td><td>G (GREEN)/Y</td></tr> <tr><td>3</td><td>B (BLUE)/C<sub>B</sub></td></tr> <tr><td>4</td><td>-</td></tr> <tr><td>5</td><td>GND</td></tr> <tr><td>6</td><td>GND</td></tr> <tr><td>7</td><td>GND</td></tr> <tr><td>8</td><td>GND</td></tr> <tr><td>9</td><td>-</td></tr> <tr><td>10</td><td>GND</td></tr> <tr><td>11</td><td>-</td></tr> <tr><td>12</td><td>-</td></tr> <tr><td>13</td><td>HD/CS</td></tr> <tr><td>14</td><td>VD</td></tr> <tr><td>15</td><td>-</td></tr> </tbody> </table>	Pin No.	Spec.	1	R (RED)/C <sub>R</sub>	2	G (GREEN)/Y	3	B (BLUE)/C <sub>B</sub>	4	-	5	GND	6	GND	7	GND	8	GND	9	-	10	GND	11	-	12	-	13	HD/CS	14	VD	15	-	<table border="1"> <thead> <tr> <th>Pin No.</th> <th>Spec.</th> </tr> </thead> <tbody> <tr><td>1</td><td>TMDS Data 2 +</td></tr> <tr><td>2</td><td>TMDS Data 2 Shield</td></tr> <tr><td>3</td><td>TMDS Data 2 -</td></tr> <tr><td>4</td><td>TMDS Data 1 +</td></tr> <tr><td>5</td><td>TMDS Data1 Shield</td></tr> <tr><td>6</td><td>TMDS Data 1 -</td></tr> <tr><td>7</td><td>TMDS Data 0 +</td></tr> <tr><td>8</td><td>TMDS Data 0 Shield</td></tr> <tr><td>9</td><td>TMDS Data 0 -</td></tr> <tr><td>10</td><td>TMDS Clock +</td></tr> <tr><td>11</td><td>TMDS Clock Shield</td></tr> <tr><td>12</td><td>TMDS Clock -</td></tr> <tr><td>13</td><td>CEC</td></tr> <tr><td>14</td><td>-</td></tr> <tr><td>15</td><td>SCL</td></tr> <tr><td>16</td><td>SDA</td></tr> <tr><td>17</td><td>DDC Ground</td></tr> <tr><td>18</td><td>+5 V Power</td></tr> <tr><td>19</td><td>Hot Plug Detect</td></tr> </tbody> </table>	Pin No.	Spec.	1	TMDS Data 2 +	2	TMDS Data 2 Shield	3	TMDS Data 2 -	4	TMDS Data 1 +	5	TMDS Data1 Shield	6	TMDS Data 1 -	7	TMDS Data 0 +	8	TMDS Data 0 Shield	9	TMDS Data 0 -	10	TMDS Clock +	11	TMDS Clock Shield	12	TMDS Clock -	13	CEC	14	-	15	SCL	16	SDA	17	DDC Ground	18	+5 V Power	19	Hot Plug Detect	<table border="1"> <thead> <tr> <th>Pin No.</th> <th>Name</th> <th>I/O</th> </tr> </thead> <tbody> <tr><td>1</td><td>-</td><td>-</td></tr> <tr><td>2</td><td>TXD</td><td>IN</td></tr> <tr><td>3</td><td>RXD</td><td>OUT</td></tr> <tr><td>4</td><td>-</td><td>-</td></tr> <tr><td>5</td><td>GND</td><td>-</td></tr> <tr><td>6</td><td>-</td><td>-</td></tr> <tr><td>7</td><td>-</td><td>-</td></tr> <tr><td>8</td><td>-</td><td>-</td></tr> <tr><td>9</td><td>-</td><td>-</td></tr> </tbody> </table>	Pin No.	Name	I/O	1	-	-	2	TXD	IN	3	RXD	OUT	4	-	-	5	GND	-	6	-	-	7	-	-	8	-	-	9	-	-
Pin No.	Spec.																																																																																																																																								
1	R (RED)/C <sub>R</sub>																																																																																																																																								
2	G (GREEN)/Y																																																																																																																																								
3	B (BLUE)/C <sub>B</sub>																																																																																																																																								
4	GND																																																																																																																																								
5	GND																																																																																																																																								
6	GND																																																																																																																																								
7	GND																																																																																																																																								
8	GND																																																																																																																																								
9	DDC 5V																																																																																																																																								
10	GND																																																																																																																																								
11	GND																																																																																																																																								
12	DDC Data																																																																																																																																								
13	HD/CS																																																																																																																																								
14	VD																																																																																																																																								
15	DDC Clock																																																																																																																																								
Pin No.	Spec.																																																																																																																																								
1	R (RED)/C <sub>R</sub>																																																																																																																																								
2	G (GREEN)/Y																																																																																																																																								
3	B (BLUE)/C <sub>B</sub>																																																																																																																																								
4	-																																																																																																																																								
5	GND																																																																																																																																								
6	GND																																																																																																																																								
7	GND																																																																																																																																								
8	GND																																																																																																																																								
9	-																																																																																																																																								
10	GND																																																																																																																																								
11	-																																																																																																																																								
12	-																																																																																																																																								
13	HD/CS																																																																																																																																								
14	VD																																																																																																																																								
15	-																																																																																																																																								
Pin No.	Spec.																																																																																																																																								
1	TMDS Data 2 +																																																																																																																																								
2	TMDS Data 2 Shield																																																																																																																																								
3	TMDS Data 2 -																																																																																																																																								
4	TMDS Data 1 +																																																																																																																																								
5	TMDS Data1 Shield																																																																																																																																								
6	TMDS Data 1 -																																																																																																																																								
7	TMDS Data 0 +																																																																																																																																								
8	TMDS Data 0 Shield																																																																																																																																								
9	TMDS Data 0 -																																																																																																																																								
10	TMDS Clock +																																																																																																																																								
11	TMDS Clock Shield																																																																																																																																								
12	TMDS Clock -																																																																																																																																								
13	CEC																																																																																																																																								
14	-																																																																																																																																								
15	SCL																																																																																																																																								
16	SDA																																																																																																																																								
17	DDC Ground																																																																																																																																								
18	+5 V Power																																																																																																																																								
19	Hot Plug Detect																																																																																																																																								
Pin No.	Name	I/O																																																																																																																																							
1	-	-																																																																																																																																							
2	TXD	IN																																																																																																																																							
3	RXD	OUT																																																																																																																																							
4	-	-																																																																																																																																							
5	GND	-																																																																																																																																							
6	-	-																																																																																																																																							
7	-	-																																																																																																																																							
8	-	-																																																																																																																																							
9	-	-																																																																																																																																							

## Dimension drawings (unit: mm)

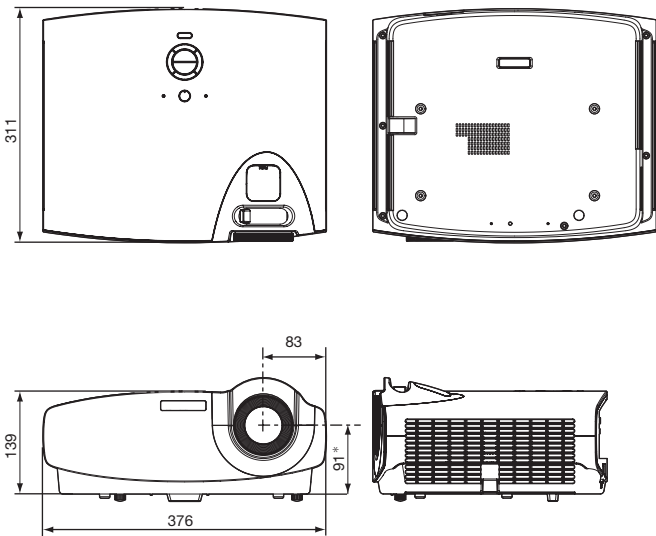

\*: Factory-defaults

## Kensington Lock

This projector has a Kensington Security Standard connector for use with Kensington MicroSaver Security System. Refer to the information that came with the Kensington System for instructions on how to use it to secure the projector. Please contact Kensington Technology Group below.

Kensington Technology Group  
 2855 Campus Drive  
 San Mateo, CA 94403, U.S.A.

Phone: +1- (650)572-2700      Fax: +1- (650)572-9675

 **MITSUBISHI ELECTRIC CORPORATION**  
1 Zusho Baba, Nagaokakyo-City, Kyoto Japan