

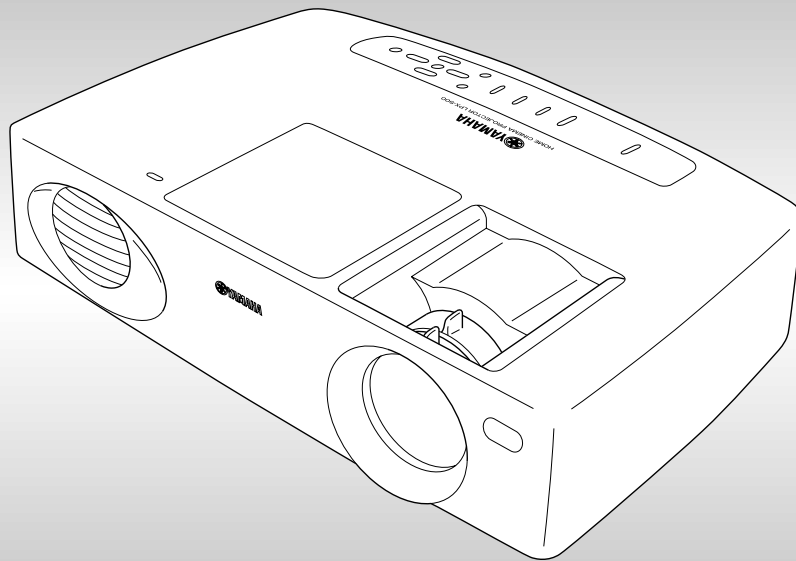

LPX-500

Home Cinema Projector

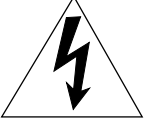

IMPORTANT SAFETY INSTRUCTIONS

	CAUTION RISK OF ELECTRIC SHOCK DO NOT OPEN	
<p>CAUTION: TO REDUCE THE RISK OF ELECTRIC SHOCK, DO NOT REMOVE COVER (OR BACK). NO USER-SERVICEABLE PARTS INSIDE. REFER SERVICING TO QUALIFIED SERVICE PERSONNEL.</p>		

• Explanation of Graphical Symbols

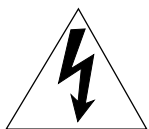

The lightning flash with arrowhead symbol, within an equilateral triangle, is intended to alert you to the presence of uninsulated “dangerous voltage” within the product’s enclosure that may be of sufficient magnitude to constitute a risk of electric shock to persons.



The exclamation point within an equilateral triangle is intended to alert you to the presence of important operating and maintenance (servicing) instructions in the literature accompanying the appliance.

<p>WARNING TO REDUCE THE RISK OF FIRE OR ELECTRIC SHOCK, DO NOT EXPOSE THIS UNIT TO RAIN OR MOISTURE.</p>
--

<p>IMPORTANT! Please record the serial number of this unit in the space below. Model: Serial No.: The serial number is located on the bottom of the unit. Retain this Owner’s Manual in a safe place for future reference.</p>

- 1 Read these instructions.
- 2 Keep these instructions.
- 3 Heed all warnings.
- 4 Follow all instructions.
- 5 Do not use this apparatus near water.
- 6 Clean only with dry cloth.
- 7 Do not block any ventilation openings. Install in accordance with the manufacturer’s instructions.
- 8 Do not install near any heat sources such as radiators, heat registers, stoves, or other apparatus (including amplifiers) that produce heat.
- 9 Do not defeat the safety purpose of the polarized or grounding-type plug. A polarized plug has two blades with one wider than the other. A grounding type plug has two blades and a third grounding prong. The wide blade or the third prong are provided for your safety. If the provided plug does not fit into your outlet, consult an electrician for replacement of the obsolete outlet.
- 10 Protect the power cord from being walked on or pinched particularly at plugs, convenience receptacles, and the point where they exit from the apparatus.
- 11 Only use attachments/accessories specified by the manufacturer.
- 12 Use only with the cart, stand, tripod, bracket, or table specified by the manufacturer, or sold with the apparatus. When a cart is used, use caution when moving the cart/apparatus combination to avoid injury from tip-over.
- 13 Unplug this apparatus during lightning storms or when unused for long periods of time.
- 14 Refer all servicing to qualified service personnel. Servicing is required when the apparatus has been damaged in any way, such as power-supply cord or plug is damaged, liquid has been spilled or objects have fallen into the apparatus, the apparatus has been exposed to rain or moisture, does not operate normally, or has been dropped.



COMPLIANCE INFORMATION STATEMENT

(DECLARATION OF CONFORMITY PROCEDURE)

Responsible Party: Yamaha Electronics Corporation
Address: 6660 Orangethorpe Avenue
Buena Park, CA90620
Telephone: 714-522-9105
Fax: 714-670-0108
Type of Equipment: Projector
Model Name: LPX-500

This device complies with Part 15 of the FCC Rules.

Operation is subject to the following conditions:

- 1) this device may not cause harmful interference, and
- 2) this device must accept any interference received including interference that may cause undesired operation.

See the user manual instructions if interference to radio reception is suspected.

FCC INFORMATION (for US customers)

1. IMPORTANT NOTICE: DO NOT MODIFY THIS UNIT!

This product, when installed as indicated in the instructions contained in this manual, meets FCC requirements. Modifications not expressly approved by Yamaha may void your authority, granted by the FCC, to use the product.

2. IMPORTANT: When connecting this product to accessories and/or another product use only high quality shielded cables. Cable/s supplied with this product **MUST** be used. Follow all installation instructions. Failure to follow instructions could void your FCC authorization to use this product in the USA.

3. NOTE: This product has been tested and found to comply with the requirements listed in FCC Regulations, Part 15 for Class “B” digital devices. Compliance with these requirements provides a reasonable level of assurance that your use of this product in a residential environment will not result in harmful interference with other electronic devices.

This equipment generates/uses radio frequencies and, if not installed and used according to the instructions found in the users manual, may cause interference harmful to the operation of other electronic devices.

Compliance with FCC regulations does not guarantee that interference will not occur in all installations. If this product is found to be the source of interference, which can be determined by turning the unit “OFF” and “ON”, please try to eliminate the problem by using one of the following measures:

Relocate either this product or the device that is being affected by the interference.

Utilize power outlets that are on different branch (circuit breaker or fuse) circuits or install AC line filter/s.

In the case of radio or TV interference, relocate/reorient the antenna. If the antenna lead-in is 300 ohm ribbon lead, change the lead-in to coaxial type cable.

If these corrective measures do not produce satisfactory results, please contact the local retailer authorized to distribute this type of product. If you can not locate the appropriate retailer, please contact Yamaha Electronics Corp., U.S.A. 6660 Orangethorpe Ave, Buena Park, CA 90620.

The above statements apply **ONLY** to those products distributed by Yamaha Corporation of America or its subsidiaries.

We Want You Listening For A Lifetime

YAMAHA and the Electronic Industries Association’s Consumer Electronics Group want you to get the most out of your equipment by playing it at a safe level. One that lets the sound come through loud and clear without annoying blaring or distortion — and, most importantly, without affecting your sensitive hearing. Since hearing damage from loud sounds is often undetectable until it is too late, YAMAHA and the Electronic Industries Association’s Consumer Electronics Group recommend you to avoid prolonged exposure from excessive volume levels.



Caution: Read this before operating this unit.

- To assure the finest performance, please read this manual carefully. Keep it in a safe place for future reference.

Installation

- Install this unit in a well-ventilated, cool, dry, clean place with at least 10 cm clearance on the top, right and left, and at the back of this unit — away from direct sunlight, heat sources, vibration, dust, moisture, and/or cold.
- Locate this unit away from other electrical appliances, motors, or transformers to avoid humming sounds. To prevent fire or electrical shock, do not place this unit where it may get exposed to rain, water, and/or any type of liquid.
- Do not expose this unit to sudden temperature changes from cold to hot, and do not locate this unit in an environment with high humidity (i.e. a room with a humidifier) to prevent condensation inside this unit, which may cause an electrical shock, fire, damage to this unit, and/or personal injury.
- On the top of this unit, do not place:
 - Other components, as they may cause damage and/or discoloration on the surface of this unit.
 - Burning objects (i.e. candles), as they may cause fire, damage to this unit, and/or personal injury.
 - Containers with liquid in them, as they may cause electrical shock to the user and/or damage to this unit.
- Do not cover this unit with a newspaper, tablecloth, curtain, etc. in order not to restrict heat dissipation. If the temperature inside this unit rises too much, it may cause fire, damage to this unit, and/or personal injury.
- When installing this unit on the ceiling, make sure the ceiling has sufficient strength to support this unit and the ceiling mounts for an extended period of time. Installation must be performed only by qualified service personnel.

Operation

- Remove the lens cap before starting any operation of this unit to prevent the heat from staying around the lens. Operation with the cap on may cause damage to this unit.
- Do not plug in this unit to a wall outlet until all connections are complete.
- Only the voltage specified on this unit must be used. Using this unit with a higher voltage than specified is dangerous and may cause fire, damage to this unit, and/or personal injury. YAMAHA will not be held responsible for any damage resulting from use of this unit with a voltage other than that specified.
- Do not use force on switches, knobs and/or cords.
- Take care of this unit so that no foreign objects and/or liquid drop inside this unit.
- To prevent damage by lightning, disconnect the power cord from the wall outlet during an electrical storm.
- Do not look into the lens while this unit is turned on. It may cause serious damage to your eyesight.
- Before moving this unit, press **STANDBY/ON** to set this unit in the standby mode, and disconnect the AC power plug from the wall outlet.
- Do not attempt to modify or fix this unit. Contact qualified YAMAHA service personnel when any service is needed. The cabinet should never be opened for any reason.

- When not planning to use this unit for a long period of time (i.e. vacation), disconnect the AC power plug from the wall outlet.
- When disconnecting the power cord from the wall outlet, grasp the plug; do not pull the cord.
- Be sure to read the “TROUBLESHOOTING” section on common operating errors before concluding that this unit is faulty.

Others

- Clean the lens carefully so as not to create any scratches by using a blower or lens paper.
- Replace the lamp when the LAMP/COVER indicator flashes in red after the lamp usage has exceeded 1000 hours. Follow the lamp replacement procedure described in this manual.

This unit is not disconnected from the AC power source as long as it is connected to the wall outlet, even if this unit itself is turned off. This state is called the standby mode. In this state, this unit is designed to consume a very small quantity of power.

IMPORTANT

THE WIRES IN THIS MAINS LEAD ARE COLOURED IN ACCORDANCE WITH THE FOLLOWING CODE:

GREEN-AND-YELLOW:	EARTH
BLUE:	NEUTRAL
BROWN:	LIVE

As the colours of the wires in the mains lead of this apparatus may not correspond with the coloured markings identifying the terminals in your plug, proceed as follows: The wire which is coloured GREEN-AND-YELLOW must be connected to the terminal in the plug which is marked by the letter E or by the safety earth symbol or coloured GREEN or GREEN-and-YELLOW.

The wire which is coloured BLUE must be connected to the terminal which is marked with the letter N or coloured BLACK.

The wire which is coloured BROWN must be connected to the terminal which is marked with the letter L or coloured RED.

For U.K. customers

- If the socket outlets in the home are not suitable for the plug supplied with this appliance, it should be cut off and an appropriate 3 pin plug fitted. For details, refer to the instructions described below.

Note

- The plug severed from the mains lead must be destroyed, as a plug with bared flexible cord is hazardous if engaged in a live socket outlet.



For Canadian Customers

To prevent electric shock, match wide blade of plug to wide slot and fully insert.

This Class B digital apparatus complies with Canadian ICES-003.

Notations used in this Owner's Manual

Indications

	Indicates procedures where personal injury or damage to the projector may occur if the procedures are not followed correctly.
	Indicates additional information and points which may be useful to know regarding a topic.
	Indicates that an explanation of the underlined word or words in front of this symbol appears in the glossary of terms. Refer to the "Glossary" in the "Appendix". (p.61)
Procedure	Indicates operating methods and the order of operations. The procedure indicated should be carried out in the order of the numbers.

Contents

Notes on Handling and Storage	2
Accessories	3
Features of the Projector	4
Basic Operations	
Turning On the Projector	6
Connecting the Power Cord	6
Turning On the Power and Projecting Images	7
Turning Off the Projector	9
Adjusting the Screen Image	11
Adjusting the Image Size	11
Adjusting the Image Angle	11
Correcting Keystone Distortion	12
Displaying a Test Pattern	13
Adjusting the Image Quality.....	14
Focusing the Screen Image	14
Selecting the picture mode	14
Selecting the Image Aspect Ratio	15
Automatic Adjustment of Computer Images	17
Advanced Operations	
Functions for Enhancing Projection.....	20
Using the Menus.....	20
Description of Functions	23
Saving and Retrieving Image Quality Settings (Memory Save).....	24
Using the Menu Functions.....	26
Image Menu.....	26
Signal Menu	30
Setup Menu	31
Info Menu.....	33
Troubleshooting	
When Having Some Trouble	36
When the Indicators Provide No Help	38
Appendices	
Maintenance	46
Cleaning	46
Replacing Consumables	47
Optional Accessories	51
List of Supported Signal Resolutions.....	52
Component Video Input	52
Composite Video/S-Video Input	52
RGB Input	53
Specifications	54
Appearance	56
Part Names and Functions	57
Front/Top.....	57
Control Panel.....	58
Rear	59
Base	59
Remote Control	60
Glossary	61
Index.....	63

Basic Operations

Advanced Operations

Troubleshooting

Appendices

Notes on Handling and Storage

Be sure to observe the following precautions to avoid malfunctions, operating errors or damage to the projector.

Notes on Handling and Storage

- Do not set up the projector near high-voltage electrical wires or sources of magnetic fields. These may interfere with correct operation.
- Do not touch the lens with bare hands. If fingerprints or grease get onto the lens, it can interfere with the quality of the projected images. Attach the lens cover to the lens when the projector is not in use.
- During projection, some points (dots) may appear lit at all times, or they may be dark at all times. This is caused by the characteristics of the LCD panel, and is not a sign of a malfunction. The LCD panel is manufactured using extremely high-precision technology. However, black dots may appear on the panel, or some red, blue or green dots may light extremely brightly at times. Furthermore, sometimes stripe-shaped color irregularities or brightness irregularities may also appear.
- Remove the batteries from the remote control before storage. If the batteries are left in the remote control for long periods, they may leak.
- Always attach the lens cap to the lens when not using the projector, to prevent the lens from becoming dirty or damaged.
- The mercury lamp that is used as the projector's light source deteriorates as a result of normal use and as a result of impacts or other damage, and may also break with a loud noise, stop working or reach the end of its service life more quickly. At such times, the amount of time remaining before the lamp breaks or stops working may vary greatly depending on the individual lamp characteristics and the operating environment. These are normal characteristics of mercury lamps. You should always have a spare lamp ready in case it is needed.
- YAMAHA takes no responsibility for loss or damage caused by damage to the projector or operating failures outside normal service warranty conditions.

Lamp Operating Errors

The mercury lamp that is used as the light source for this projector may stop operating on occasions. This is a normal characteristic of mercury lamps. If the lamp does not turn on when the projector's power is turned on, remove the lamp and check if it is broken. If the lamp is not broken, reinstall it. Refer to "Replacing the Lamp" on page 48 of this manual for instruction on removing and reinstalling the lamp.

If the lamp is broken, replace it with a new lamp. It is recommended that you have a spare lamp ready at all times in case it is needed.

Notes on Carrying the Projector

- Turn off the projector power and then disconnect the power cord from the electrical outlet. Furthermore, check that all other cables have been disconnected.
- Attach the lens cap to the lens.
- Retract the adjustable foot.
- If your model of projector has a handle, hold the projector by the handle when carrying it.

Accessories

Check the included accessories

Remote control

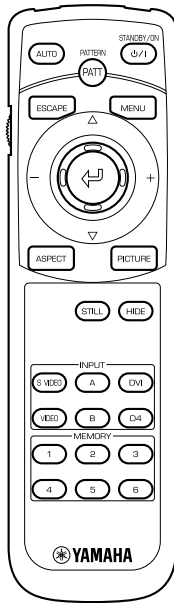

Setup guide

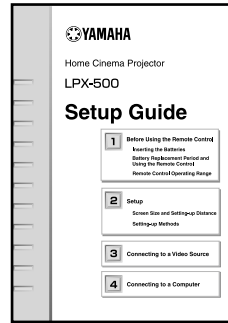

Battery LR6 (AA) x 2

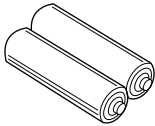

Power cord

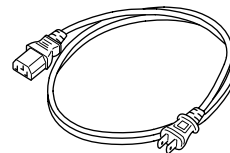

Features of the Projector

Adoption of a wide 1280 x 720 dot panel

This panel allows high-definition images to be reproduced accurately.

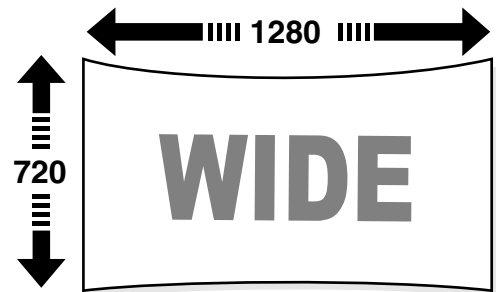

Adoption of a special high-resolution DCDi[™] video circuit developed by Faroudja.

This circuit greatly reduces the jagged edges that resulted from conventional progressive conversion, to produce much smoother and natural movement. (p.30)

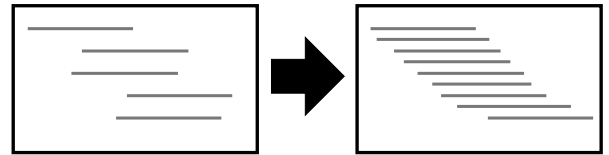

Adoption of a short focal-length lens that can project onto 80-inch screens at distances of 2.5m (8.2 ft.)

This lens is ideal for projecting onto large indoor screens. The projector can also project onto 80-inch screens in rooms with an area of about 10 m². (Refer to the *Setup Guide*.)

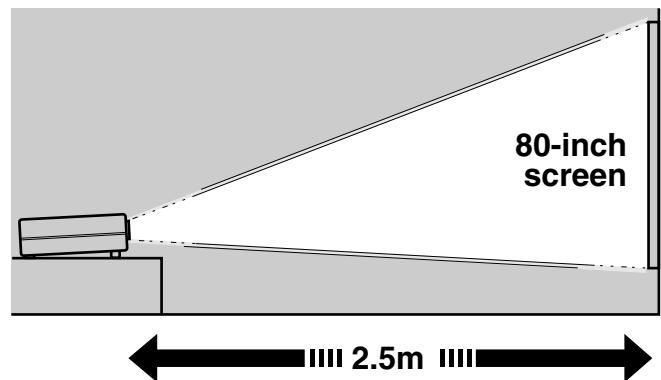

Includes 5 picture modes

You can select the desired color mode to match the images being projected from five preset modes in order to obtain the optimum image quality. (p.14)

Includes a variety of color adjustment modes

Various color settings can be adjusted to suit your preferences, from individual RGB balance adjustment to setting the color temperature of your choice. The adjusted settings can then be stored in memory and recalled at a touch of a button on the remote control. (p.24, 25)

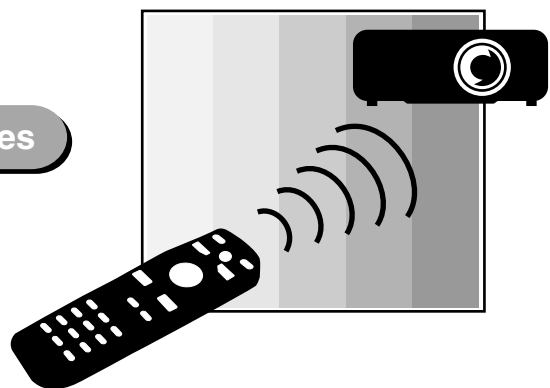

Basic Operations

This chapter describes basic operations such as turning the projector on and off and adjusting the projected images.

Turning On the Projector	6
• Connecting the Power Cord	6
• Turning On the Power and Projecting Images.....	7
Turning Off the Projector	9
Adjusting the Screen Image	11
• Adjusting the Image Size	11
• Adjusting the Image Angle	11
• Correcting Keystone Distortion	12
• Displaying a Test Pattern.....	13
Adjusting the Image Quality	14
• Focusing the Screen Image	14
• Selecting the picture mode.....	14
• Selecting the Image Aspect Ratio.....	15
• Normal mode.....	15
• Squeeze mode.....	16
• Zoom mode	16
• Zoom -Subtitle- mode	16
• Through mode	17
• Squeeze Through mode.....	17
• Automatic Adjustment of Computer Images.....	17

Turning On the Projector

This section describes the procedure from turning on the power to projecting images.



Be sure to read the *Safety Instructions* in this manual for details on safe handling when using the projector.

Connecting the Power Cord

Procedure

1

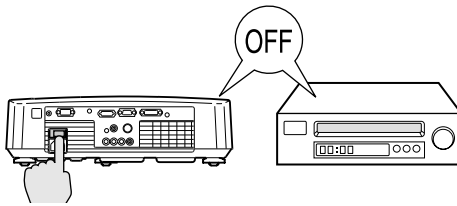

Check that the power is turned off for the projector and all components connected to the projector.

2

Connect the computer or other video source to the projector.

Refer to the *Setup Guide*.

3

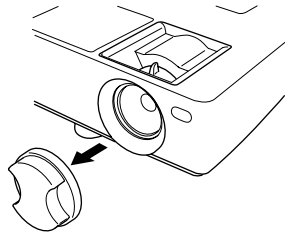

Remove the lens cap.

4

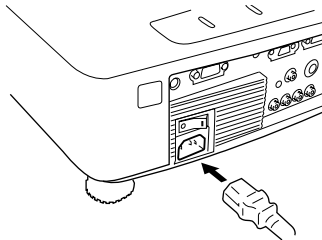

Connect the accessory power cord to the projector.

Check that the power cord connector is facing the same way as the power inlet on the projector, and then insert the power cord connector securely into the projector.

5

Connect the other end of the power cord to a grounded electrical outlet.

6

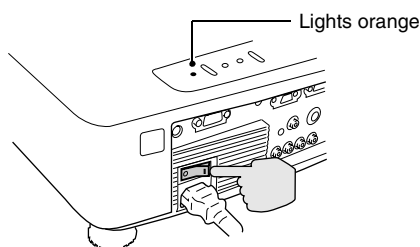

Turn on the main power switch at the rear of the projector.

Wait until the  / | indicator lights orange and the projector goes to the standby condition.

Turning On the Power and Projecting Images

Procedure

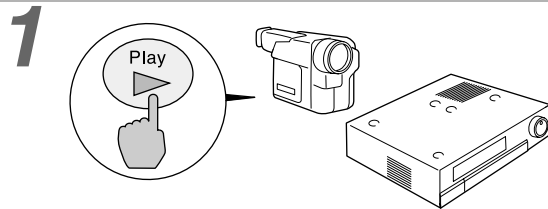

Turn on the power for all equipment connected to the projector.

For a video source, press the [Play] button at the video source to start playback if necessary. Check that the $\odot / |$ indicator on the projector has stopped flashing and lights orange.

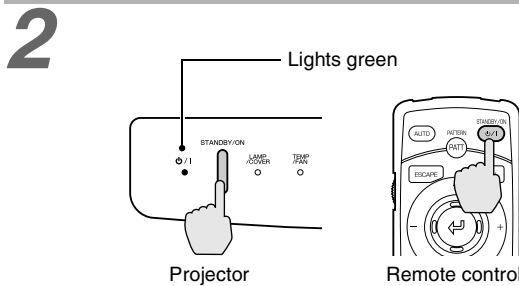

Press the [STANDBY/ON] button on either the remote control or the projector's control panel to turn on the power.

The $\odot / |$ indicator flashes green, and after a short period projection starts. Check that the $\odot / |$ indicator has stopped flashing and lights green. (This takes approximately 15 seconds.)



The buttons on the remote control and the projector's control panel cannot be operated while the $\odot / |$ indicator is flashing green. Wait until it lights steadily. The message "No Signal" may appear depending on the projector's menu settings. (p.31)

3 If more than one signal source has been connected, use the remote control or control panel buttons to select the port which the signal source that you would like to use is connected to, while referring to the following table.

Port	Button to press		Display at top-right of screen *
	Projector	Remote control	
INPUT A	[INPUT]	[A]	INPUT A (component) or INPUT A (RGB)
INPUT B		[B]	INPUT B (component) or INPUT B (RGB)
S VIDEO		[S VIDEO]	S Video
VIDEO		[VIDEO]	Video
D4 VIDEO		[D4]	D4 Video
DVI		[DVI]	DVI

*The display disappears approximately 1 second after the signal is output.



- If only one signal source has been connected, the signals from that source will be projected without needing to press one of the above buttons.
- If video signals are being input to several input ports simultaneously, interference between the various signals may occur, and this may cause interference in the projected images. If this happens, turn off the power supply or disconnect the video equipment which is not currently being used.
- If the "No Signal" message does not disappear, check the connections again. No images will be projected during the time that it takes for signals to be input from the video source.
- If a laptop computer or a computer with an LCD screen has been connected to the projector, the images may not be projected straight away. After making the connections, check that the computer has been set up to output signals.

The following table shows examples of how to toggle output settings. For details, refer to the section of the documentation provided with your computer under a heading such as "External output", "Connecting an external monitor" or similar.

NEC	Panasonic	Toshiba	IBM	Sony	Fujitsu	Macintosh
[Fn]+[F3]	[Fn]+[F3]	[Fn]+[F5]	[Fn]+[F7]	[Fn]+[F7]	[Fn]+[F10]	After startup, change the Control Panel adjustments so that Mirroring is active.

Turning Off the Projector

Follow the procedure below to turn off the power of the projector.

Procedure

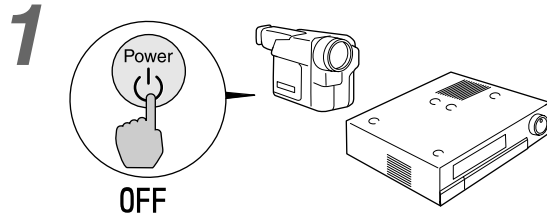

Turn off the power for the signal sources that are connected to the projector.

Check that the power for all connected components has been tuned off.

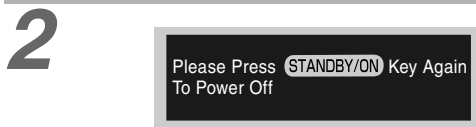

Press the [STANDBY/ON] button on either the remote control or the projector's control panel.

The confirmation message shown at left will appear.

If you do not want to turn off the power, press any button except the [STANDBY/ON] button.

If you do not carry out any operation, the message will disappear after seven seconds. (The power will not turn off at this time.)

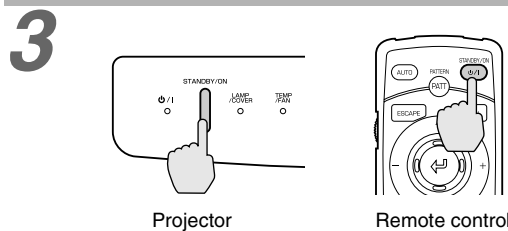

Press the [STANDBY/ON] button on the projector's control panel or remote control once more.

The lamp will switch off. The $\phi / |$ indicator will flash red and cool-down will start.

After about 90 seconds, the $\phi / |$ indicator will change to flashing orange.

 The buttons on the control panel and remote control cannot be operated while the $\phi / |$ indicator is flashing red. Wait until the indicator flashes orange (takes approximately 90 seconds).

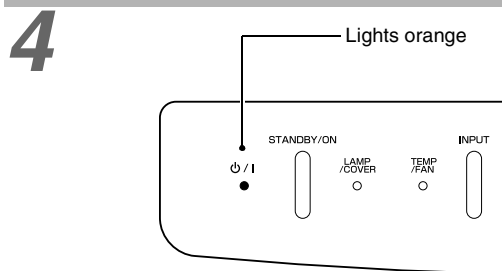

Check that the $\phi / |$ indicator has changed to light orange.

When the $\phi / |$ indicator lights orange, cool-down is complete.

The cool-down period lasts for approximately 5 minutes. (This varies depending on factors such as the ambient air temperature.)

The cool-down period is a 5 minutes long in order to allow the heat inside the projector to dissipate sufficiently.

5

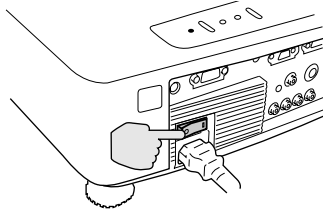

If not using the projector for long periods of time, turn off the main power switch at the rear of the projector.



Do not turn off the main power switch at the rear of the projector while the cool-down is in progress. If the main power switch is turned off before cool-down is complete, wait for the lamp to cool down (normally about one hour is required) before turning the power back on again. If the power is turned off and on before the lamp has cooled down, it may result in lamp operating errors. Refer to "Lamp operating error" on page 36.

6

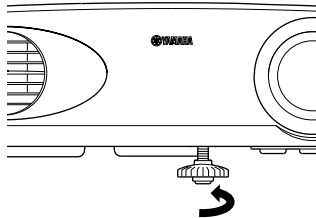

Retract the front adjustable foot if it is extended.

Turn the front adjustable foot to retract it.

7

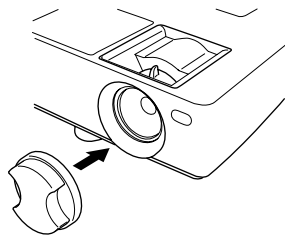

Attach the lens cap.

Attach the lens cap to the lens when not using the projector, in order to stop the lens from getting dusty or dirty.

Adjusting the Screen Image

You can adjust the screen image in order to obtain the best possible picture.

Adjusting the Image Size

The size of the projected image is basically determined by the distance from the projector to the screen. (Refer to the *Setup Guide*.)

The following procedures explain how to adjust the screen image once the projector itself has been set up.

Procedure

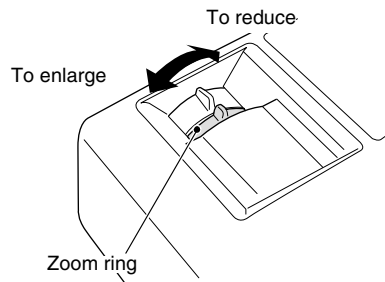

Turn the zoom ring on the projector to adjust the image.

The image can be enlarged in this way to 1.35 times the normal size.

If you would like to enlarge the image further, move the projector further away from the screen. (Refer to the *Setup Guide*.)

Adjusting the Image Angle

The projector should be as perpendicular to the screen as possible.

If the projector cannot be set up so that it is exactly perpendicular to the screen, it can be set up so that it is tilting slightly horizontally or vertically. To tilt the projector upward, adjust the front adjustable foot to tilt the projector at an angle of up to a maximum 12.9°.

Seen from the side

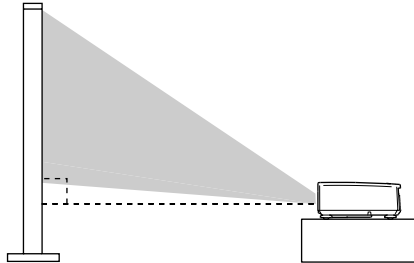

Seen from above

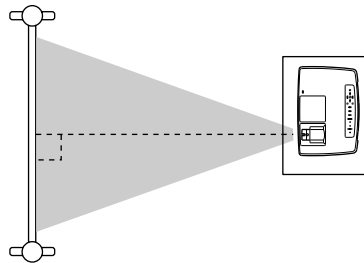

Procedure

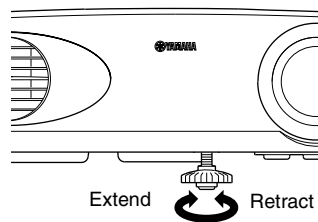

Turn the front adjustable foot underneath the projector to adjust the projector angle.

Turn the front adjustable foot until the desired projection angle is obtained.



- When the foot is adjusted, it may cause the projected images to become distorted. Use the keystone correction function to adjust this distortion. (p.12)
- If the projector is tilted horizontally, turn the rear adjustable feet at left and right to adjust the horizontal angle.

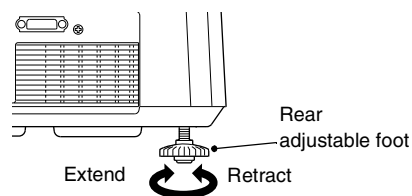
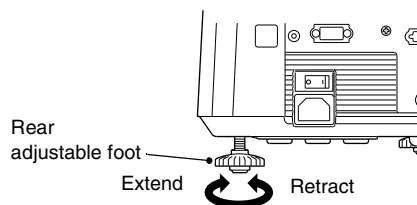

Correcting Keystone Distortion

If the projector is set up so that it is at an angle to the screen, a type of distortion known as "keystone distortion" may occur.

Keystone correction can be carried out if the angle of the projector is within a range of approximately 15° vertically from the perpendicular.

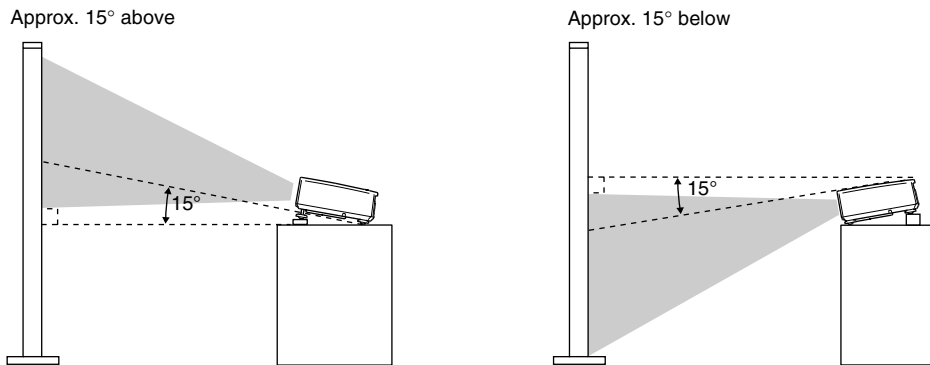

Procedure

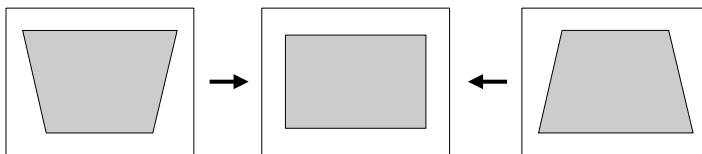

While holding down the [SHIFT] button on the projector's control panel, press the Δ or ∇ button.

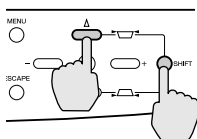

Projector

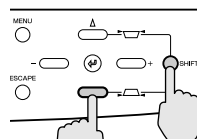

Projector



- When keystone correction is carried out, the projected image will become smaller.
- The keystone correction settings are memorized, so that if you change the position or angle of the projector, you may need to readjust the keystone correction settings.
- If the images become uneven in appearance after keystone correction is carried out, decrease the "Sharpness" setting. (p.27, 29)
- Keystone correction can also be carried out using the projector menu. (p.31)
- If the value displayed in the gauge on the screen stops changing when horizontal or vertical keystone correction is being carried out, it indicates that the limit for horizontal or vertical keystone correction has been exceeded. Check that the projector has not been set up at an angle which exceeds the proper limit.

Displaying a Test Pattern

When setting up the projector, you can project a test pattern onto the screen and use this test pattern to adjust the projected images before a video source has been connected. The following two types of test pattern are available.

- Crosshatch

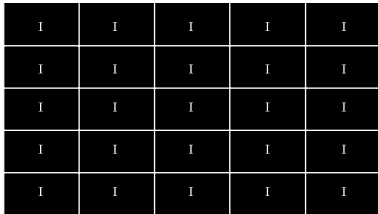

This can be used to adjust the focus and correct keystone distortion.

- Grayscale pattern

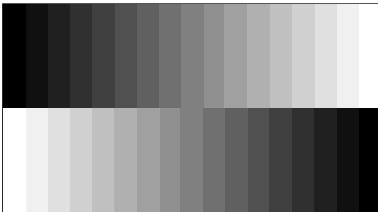

This can be used to adjust dark and light shades to the desired shade. Use the "**Color Temp.**", "Flesh Tone" and "Color Balance" commands in the "Image" menu to adjust the settings.

The test pattern changes as shown below each time the [PATTERN] button on either the remote control or the projector's control panel is pressed.

Crosshatch → Grayscale pattern → No pattern



The full menu cannot be displayed while a test pattern is being projected. If you need to change a setting, press the  button on either the projector's control panel or the remote control to display the line menu, and then change the setting. To correct keystone distortion while a test pattern is being displayed, press and hold the [SHIFT] button and then use the Δ and ∇ buttons on the projector's control panel to make the adjustment. This setting cannot be made using the remote control.

Adjusting the Image Quality

The quality of the screen images can be adjusted as follows.

Focusing the Screen Image

Procedure

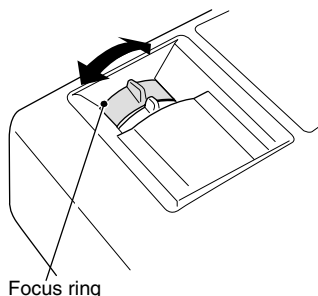

Turn the focus ring to adjust the image focus.

- If the surface of the lens is dirty or misted over as a result of condensation, it may not be possible to adjust the focus correctly. If this happens, clean or de-mist the lens. (p.46)
- If the projector is positioned outside the normal projecting range of 0.9 - 13 m (2.9 - 42.6 ft.), it may not be possible to obtain the correct focus. If you have trouble obtaining the correct focus, check the projection distance.

Selecting the picture mode

The following five color modes have been preset for use with images with varying characteristics. You can use these color modes to obtain the optimum image quality easily, just by selecting whichever color mode best suits the images. The brightness of the projected images will vary depending on the mode.

Mode name	Gamma▶▶	Color Temp▶▶	Priority element	Use
A	Original 1	6700 K (adjustable)	Color	Ideal for enjoying presentations in a natural atmosphere.
B	Original 2	6700 K (adjustable)	Color	Ideal for enjoying presentations such as movies which have large numbers of dark scenes.
C	Original 3	6700 K (adjustable)	Color	Ideal for projecting images with greater modulation and intensity.
PC	2.2 (Basic)	7500 K (adjustable)	Brightness	Ideal for use in making images as bright as possible when projecting computer images.
sRGB	2.2 (Basic)	6500 K (fixed)	Color	Images conform to the sRGB▶▶ standard. If the connected video source has an sRGB mode, set both the projector and the video source to sRGB.

Procedure

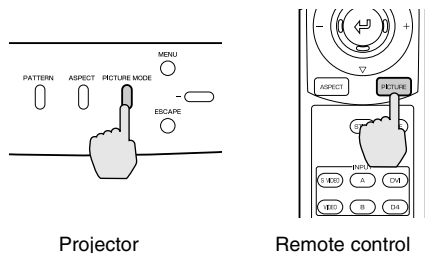

The picture mode changes as shown below each time the [PICTURE MODE] button on the projector's control panel or the [PICTURE] button on the remote control is pressed.

A → B → C → PC → sRGB

The current setting appears on the screen each time the color mode changes.

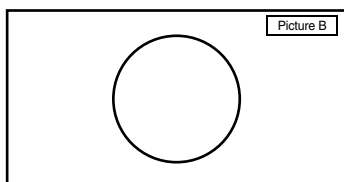

- The color mode setting can also be changed using the "Picture Mode" item of the projector's "Image" menu. (p.27, 28)

Selecting the Image Aspect Ratio

The aspect ratio for projected images can be selected from the following five types of setting. However, the aspect ratio settings that can be selected will vary depending on the input signal.

Input signal	Normal	Squeeze	Zoom	Zoom -Subtitle-	Through	Squeeze Through
Video (SDTV)	○	○	○	○	○	○
Video (HDTV)	○	-	-	-	○ (720p only)	-
Computer (SVGA or lower)	○	-	○	-	○	-
Computer (XGA or higher)	○	-	○	-	-	-



Do not use the aspect mode function to elongate or compress image that are being projected for commercial purposes or in public places such as hotel lobbies or stores, as doing so may infringe the rights of the original copyright owner for the images under copyright protection laws.

Procedure

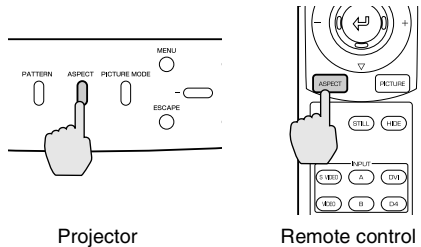

Projector

Remote control

For Video (SDTV) signals, the aspect mode changes in the following order each time the [ASPECT] button on either the projector's control panel or the remote control is pressed.

Normal → Squeeze → Zoom → Zoom -Subtitle- → Through → Squeeze Through

The current setting appears on the screen each time the aspect ratio changes.

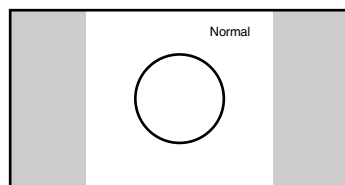

Details of each aspect ratio are as follows.

Normal mode

4:3 image

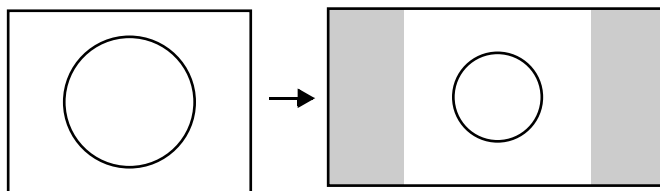

The aspect ratio of the images being input is maintained, and the images are projected into a 16:9 screen area. When 4:3 images are being projected, black bands will appear at the left and right of the image as shown in the illustration at left.

Squeeze mode

When images in squeeze mode are displayed on a 4:3 TV screen

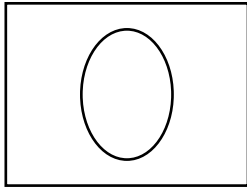

Viewed using the projector

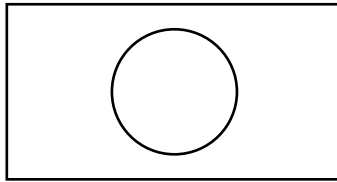

Use this setting if the connected video source has a 16:9 output mode (Squeeze mode).

If images in squeeze mode are viewed on a 4:3 TV screen, the images are compressed horizontally and elongated vertically. If Squeeze mode is selected on the projector, the images are projected correctly in their native wide-screen (16:9) format.

Images output in 4:3 format

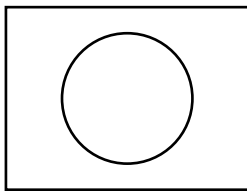

When the projector's squeeze mode is applied

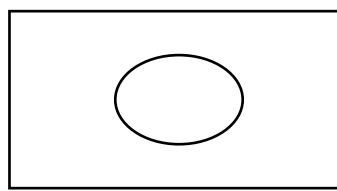

When images output in 4:3 format are projected using the projector's squeeze mode, the images will be extended horizontally and the image will appear elongated.

Zoom mode

4:3 image cut at top and bottom

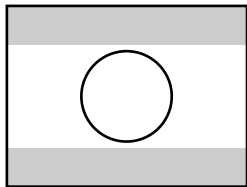

Resized to 16:9

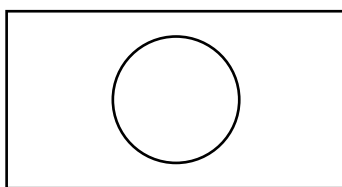

Images output in 4:3 format are truncated at top and bottom by a set amount and then projected in a 16:9 format.

Zoom -Subtitle- mode

Images output in 4:3 format

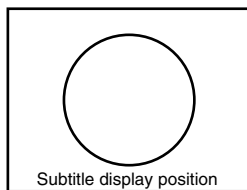

Viewed using the projector

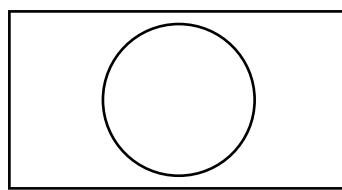

When 4:3 images with subtitles included are projected using the projector's Zoom Subtitle mode, the images are enlarged in the vertical and horizontal directions to resize them to 16:9 size.

Because the images are enlarged vertically, the subtitles may sometimes be displayed outside the actual projection area. If this happens, you can adjust the display position by choosing the "Signal" - "Zoom Subtitle" - "V Size", "V Position" menu command (p.31)

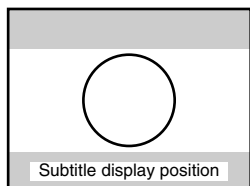

When adjusted using "Zoom Subtitle"

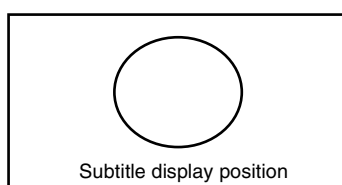

- V Size
This adjusts the vertical enlargement ratio without changing the size in the horizontal direction.

- V Position
This moves the display position up.

Through mode

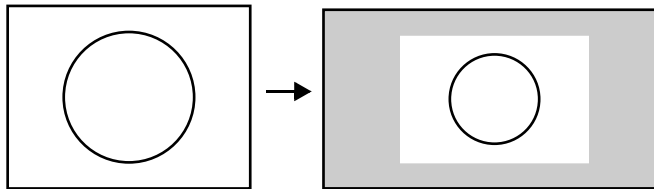

If the input signal resolution is 1280 x 720 dots or less, the images are projected onto the screen with the input signal resolution unchanged. Because of this, the size of the displayed images will change depending on the input resolution.

The picture quality will be the clearest for portions of the image that have not been resized horizontally or vertically.

Squeeze Through mode

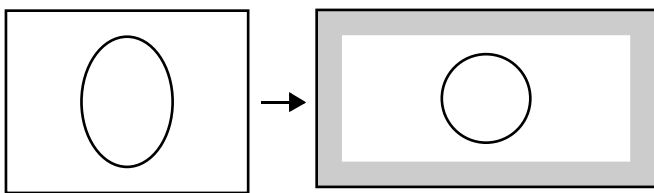

If the input signal resolution is 1280 x 720 dots or less, the input signal resolution is elongated horizontally and the images are projected at an aspect ratio of 16:9.

Because of this, the size of the displayed images will change depending on the input resolution.

The portions that are not vertically resized will appear with higher image quality.

Automatic Adjustment of Computer Images

This adjusts computer images (INPUT A [RGB] and INPUT B [RGB] only) to the optimum condition. Automatic adjustment involves adjustment of **tracking**▶▶, display position and **synchronization (Sync)**▶▶ for RGB signals.

Procedure

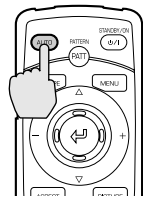

Remote control

While an image is being projected from the computer, press the [AUTO] button on the remote control.

The screen will appear black while the adjustment is being made.



Automatic adjustment may not work properly with some types of signals which are output by computers. In such cases, you may need to adjust the tracking and synchronization manually using the projector menu. (p.28)

Advanced Operations

This chapter describes functions for enhancing the projection of images, and how to use the menus.

Functions for Enhancing Projection	20
• Using the Menus	20
• Displaying and Operating Full Menus	20
• Displaying and Operating Line Menus	22
• Description of Functions	23
• Black Level Adjustment.....	23
• White Level Adjustment	23
• Color temperature, flesh tone and color balance adjustment	24
• Saving and Retrieving Image Quality Settings (Memory Save).....	24
• Saving Settings.....	24
• Retrieving Saved Image Quality Settings	25
Using the Menu Functions	26
• Image Menu	26
• Video	26
• Computer.....	28
• Signal Menu	30
• Setup Menu	31
• Info Menu.....	33
• Video	33
• Computer	33

Functions for Enhancing Projection

This section describes the various useful functions that can be used to enhance projection.

Function	Summary	Reference page
Black level adjustment	Adjusts the brightness of dark shades.	p.23
White level adjustment	Adjusts the brightness of light shades.	p.23
Color Temp., Flesh Tone and Color Balance	Adjusts the hues of light shades to the desired level.	p.24

Using the Menus

The functions described here are used to set the adjustment values using the projector menus. There are two types of projector menus used:

- Full menus : These menus can be used to set all items in the menu.
- Line menus : These menus can be used to change the “Image” settings while viewing the images being projected. The “Image” menu is the most commonly used of the menus. (p.22)

Displaying and Operating Full Menus

Menus can be operated using the projector's control panel and also by using the remote control.

Procedure

1

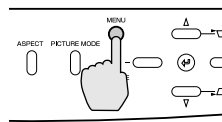

Projector

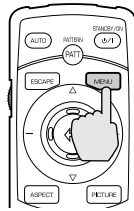

Remote control

Press the [MENU] button on either the remote control or the projector's control panel.

The menu appears.

Full menus consist of a main menu and sub-menus. The sub-menu that corresponds to the currently-selected item in the main menu (displayed in white) appears.

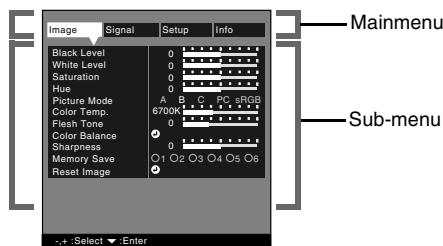

Mainmenu

Sub-menu

2

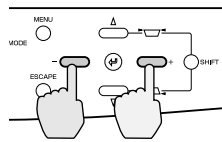

Projector

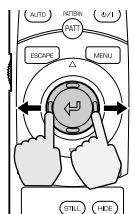

Remote control

Select the items to be changed in the main menu.

If using the projector's control panel, press the – or + button.

If using the remote control, tilt the ⌂ button to the left or right.

3

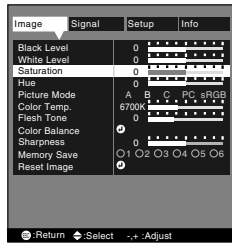

Select a setting item in the sub-menu.

If using the projector's control panel, press the Δ and ∇ buttons.

If using the remote control, tilt the \odot button up and down.

The items appearing in the "Image" menu and "Info" menu will vary depending on the input signal that is being projected.

4

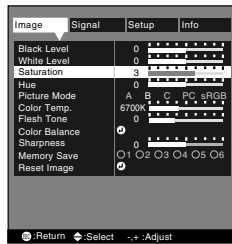

Confirm the selection.

If using the projector's control panel, press the $-$ and $+$ buttons.

If using the remote control, tilt the \odot button to the left and right.



- If a setting is executed or a sub-menu item continues to another level, " \odot " appears after the item name. In such cases, press the \odot button on either the projector's control panel or the remote control to select a setting value in the displayed menu.
- Refer to using the menu functions for details of each setting item. (p.26)

5

Set other items in the same way.

Repeat steps 2 to 4. To return to a previous menu level while a sub-menu is selected, press the [ESCAPE] button on the projector's control panel or the remote control.

6

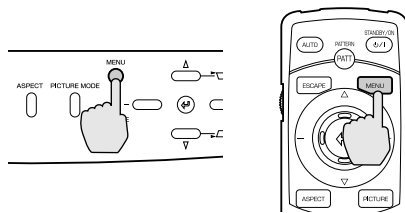

Projector

Remote control

Exit the menu display.

Press the [MENU] button on either the projector's control panel or the remote control.

The main menu can be exited by pressing the [ESCAPE] button on the projector's control panel or the remote control.

Displaying and Operating Line Menu

Procedure

1

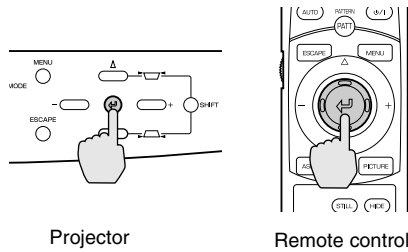

Projector

Remote control

Press the  button on either the projector's control panel or the remote control while the full menu is being displayed.

The line menu appears.

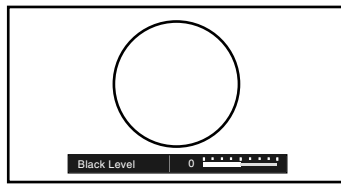

2

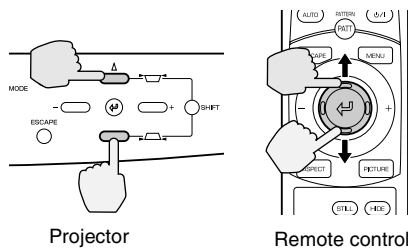

Projector

Remote control

Select an item to be set.

If using the projector's control panel, press the Δ and ∇ buttons.

If using the remote control, press the  button up and down.

The line menu item changes when a button is pressed.

3

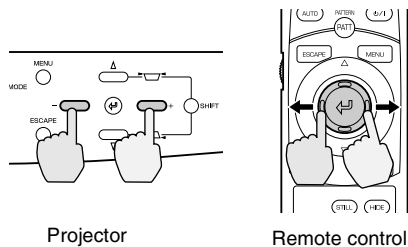

Projector



Remote control

Select the setting value.

If using the projector's control panel, press the $-$ and $+$ buttons.

If using the remote control, press the  button to the left and right.



- If a setting is executed or a sub-menu item continues to another level, " " appears after the item name. In such cases, press the  button on either the projector's control panel or the remote control to select a setting value in the displayed menu.
- Refer to using the menu functions for details of each setting item. (p.26)

4

Set other items in the same way.

Repeat steps 2 and 3. To return to a previous menu level after pressing the  button on the projector's control panel or the remote control so that a sub-menu is selected, press the [ESCAPE] button on the projector's control panel or the remote control.

5

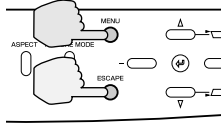

Projector

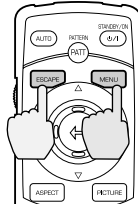

Remote control

Exit the menu display.

Press the [MENU] or [ESCAPE] button on either the projector's control panel or the remote control.



If you do not press a button for 5 seconds while a line menu is displayed, the line menu disappears automatically.

Description of Functions

This section describes commonly-used functions.

This adjusts the "Black Level" and "White Level" settings in accordance with the signals being input, so that the images do not become distorted. To adjust the colours, use the "Color Temp.", "Flesh Tone" and "Color Balance" commands.

Black Level Adjustment

This adjusts the brightness of dark shades. It lets you adjust dark shades without affecting the brightness of light shades.

Use the "Black Level" item in the "Image" menu to change the setting. (p.26, 28)

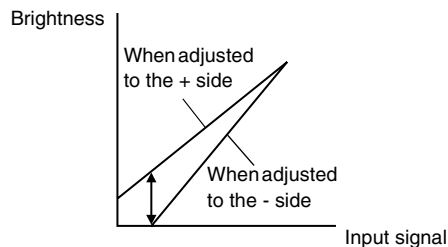

If adjusted to the + side, the luminosity of dark scenes increases and different tones become clearer, but contrast is reduced.

If adjusted to the - side, the brightness of dark shades is reduced and images with greater contrast are obtained, but differences in dark areas become less distinct.

White Level Adjustment

This adjusts the brightness of light shades. It lets you adjust light shades without affecting the brightness of dark shades.

Use the "White Level" item in the "Image" menu to change the setting. (p.26, 28)

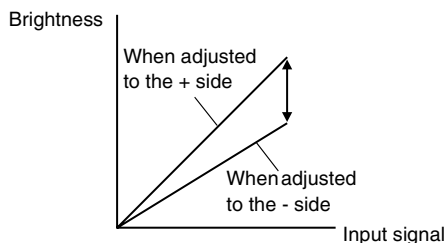

If adjusted to the + side, the luminosity of light scenes increases and contrast become clearer, but differences in light tones are reduced.

If adjusted to the - side, differences in light areas become more distinct, but contrast is reduced.

Color temperature, flesh tone and color balance adjustment

This adjusts the hues of light shades to the desired hues.

Three modes are available, for adjusting **Color Temperature**, flesh tones and each individual RGB color. These adjustments are cumulative, so first carry out the basic "Color Temp." and "Flesh Tone" adjustments while referring to the graph below, and then make fine adjustments using the "Color Balance" command. Use the "Color Temp.", "Flesh Tone" and "Color Balance" commands in the "Image" menu to adjust. (p.27, 29)

Color temperature and flesh tone adjustment modes

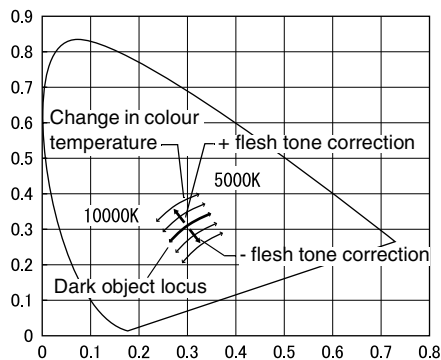

- The "Color Temp." setting allows lighter colors to be adjusted so that they range from having a red tinge to having a blue tinge. When the color temperature is lower, the red content is greater and color tones appear softer. When the color temperature is higher, the blue content is greater and color tones appear fresher.
- The "Flesh Tone" setting adjusts the green component of image signals. If adjusted to the - side, the green component is reduced and colors appear purplish. If adjusted to the + side, the green component is increased. Adjust until the desired flesh tones are obtained.

Saving and Retrieving Image Quality Settings (Memory Save)

Up to a maximum of six adjustment values in the "Image" and "Signal" menus can be memorize per input source, and settings for six different sources can be recorded, for a total of 36 possible settings. You can save the adjustment values for particular video scenes, and then use the memory button on the remote control to retrieve these settings at a single touch. (p.27, 29)

The following adjustment values can be stored in memory.

- Image menu:
Black Level, White Level, Saturation, Hue, Picture Mode, Color Temp., Flesh Tone, Color Balance, Sharpness
- Signal menu:
Progressive, Noise Reduction, Setup Level
- Aspect ratio setting
This is the aspect ratio that is selected using the [ASPECT] button on the projector's control panel or the remote control.

Saving Settings

Procedure

1

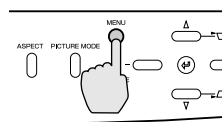

Projector

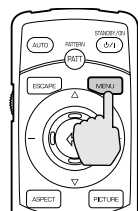

Remote control

Press the [MENU] button on either the projector's control panel or the remote control.

The menu will be displayed, with the adjustment values appearing as are currently set.

2

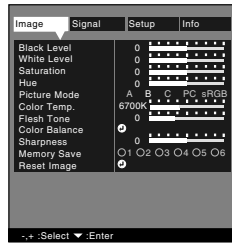

Select "Memory Save" from the sub-menu of the "Image" menu.

If using the projector's control panel, press the Δ and ∇ buttons.

If using the remote control, tilt the \odot button up and down.

3

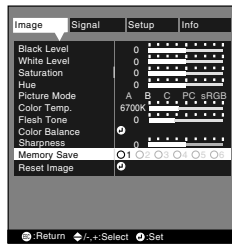

Select the memory number (1 - 6) for saving the settings.

If using the projector's control panel, press the $-$ and $+$ buttons.

If using the remote control, tilt the \odot button to the left and right.

4

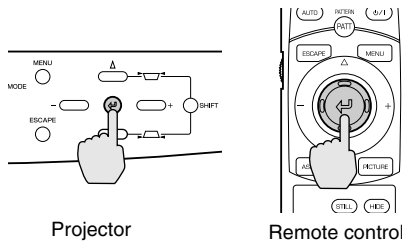

Confirm the memory setting.

Press the \odot button on either the projector's control panel or the remote control.

The number icon for the button number being memorised will change from \bigcirc to \checkmark .

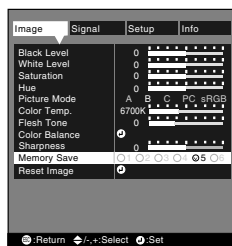

Retrieving Saved Image Quality Settings

Procedure

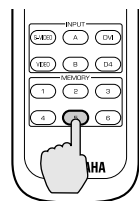

Remote control

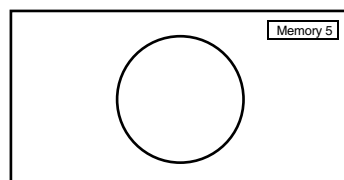

Press one of the remote control memory buttons [1] to [6] corresponding to the image quality settings to be retrieved.

The selected memory number will appear in the top-right of the screen, and the setting values will be applied to the images that are being projected.



If you press one of the remote control memory buttons [1] to [6] that has no stored memory settings, the images being projected will not change.

Using the Menu Functions

The menus are used to make various adjustments and settings. There are two types of projector's menus used: full menus and line menus. The following pages explain how to change the settings for the various menu commands, using full menus as illustrations.

Full menus consist of a main menu and sub-menus in a hierarchical structure.

Refer to "Using the menus" (p.20) for details on carrying out the various menu operations.

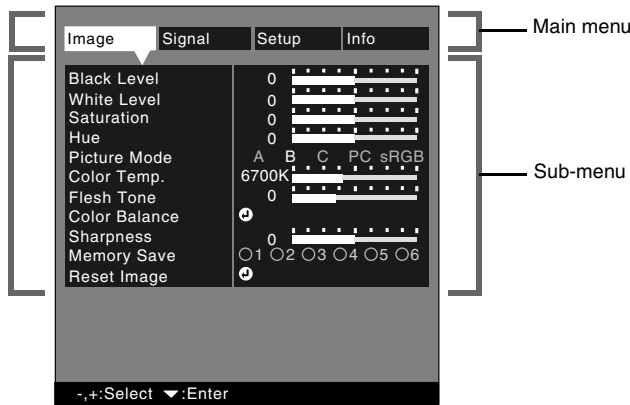
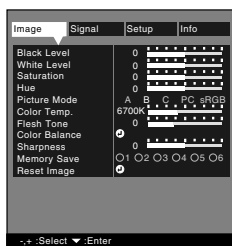

Image Menu

- If no signals are being input, settings other than “Color Temp.”, “Flesh Tone” and “Color Balance” in the “Image” menu cannot be adjusted.
- The items appearing in the “Image” menu will vary depending on the input signal that is being projected. Items in menus other than the menu for the signal currently being input cannot be adjusted.

Video (INPUT A (Component), INPUT B (Component), D4 VIDEO, S VIDEO, VIDEO)

Video (INPUT A (Component), INPUT B (Component), D4 VIDEO, S VIDEO, VIDEO)



Main menu	Sub-menu	Function	Default setting
Image	Black Level	This lets you adjust dark shades without affecting the white level setting. (p.23)	0
	White Level	This lets you adjust light shades without affecting the black level setting. (p.23) Depending on the combination of the model of VCR and the type of video tape you are using, the VCR output signal level may be too high and the white level may become clipped. When playing back SECAM signals, clipped images will change and appear purplish. If this happens, reduce the white level slightly to cancel the clipping in order to remove the purplish tinge.	0
	Saturation	Adjusts the color intensity for the images.	0
	Hue	(Adjustment is only possible for NTSC, 480i/p, 576i/p, 720p and 1080i signals.) Adjust the image tint.	0



Main menu	Sub-menu	Function	Default setting
Image	Picture Mode	<p>Corrects the vividness of the image color. You can select from five different quality settings depending on the surroundings.</p> <ul style="list-style-type: none"> •A :Ideal for enjoying presentations in a natural atmosphere. •B :Ideal for enjoying presentations such as movies which have large numbers of dark scenes. •C :Ideal for projecting images with greater modulation and intensity. •PC :Ideal for use in making images as bright as possible when projecting computer images. •sRGB :Images conform to the sRGB standard. 	B
	Color Temp. ▶▶	<p>Allows lighter colors to be adjusted so that they range from having a red tinge to having a blue tinge. (p.24)</p> <p>When the color temperature is lower, the red content is greater and color tones appear softer. When the color temperature is higher, the blue content is greater and color tones appear fresher.</p>	6700K
	Flesh Tone	<p>The "Flesh Tone" setting adjusts the green component of image signals. (p.24)</p> <p>If adjusted to the - side, the colors appear purplish. If adjusted to the + side, the green component is increased. Adjust until the desired flesh tones are obtained.</p>	0
	Color Balance	<p>The <u>Offset</u>▶▶, <u>Gain</u>▶▶ and <u>Gamma</u>▶▶ can be adjusted separately for each RGB component. (p.24)</p> <p>Offset adjusts coloration for darker shades, Gamma adjusts intermediate shades, and Gain adjusts brighter shades. The working of each adjustment is shown below.</p> <div style="display: flex; justify-content: space-around;"> <div style="text-align: center;"> <p>Offset adjustment Brightness</p> <p>Input signal</p> </div> <div style="text-align: center;"> <p>Gain adjustment Brightness</p> <p>Input signal</p> </div> <div style="text-align: center;"> <p>Gamma adjustment Brightness</p> <p>Input signal</p> </div> </div> <p>Each RGB component can be adjusted to give the desired level of coloration to dark, intermediate and light ranges.</p>	<p>Offset R : 0 G : 0 B : 0</p> <p>Gain R : 0 G : 0 B : 0</p> <p>Gamma R : 0 G : 0 B : 0</p>
	Sharpness	Adjusts the image sharpness.	0
	Memory Save	<p>This lets you save image adjustment settings and to retrieve them by pressing the corresponding remote control memory buttons.</p> <p>The images being projected will be adjusted according to the settings that are retrieved. (p.24)</p> <ul style="list-style-type: none"> •The current settings are saved to a particular recording area number when that number is selected. •The setting values that are saved to memory can be cleared by selecting "Reset All". 	-
	Reset Image	<p>Resets all adjustment values for the "Image" menu functions to their default settings. However, all settings that are stored in memory are retained.</p> <ul style="list-style-type: none"> •Press the (Ⓜ) on either the projector's control panel or the remote control to display the confirmation screen, and select Yes. •Select "Reset All" to return all menu settings to their default settings. (p.32) 	-

Computer (DVI, INPUT A (RGB), INPUT B (RGB))

RGB

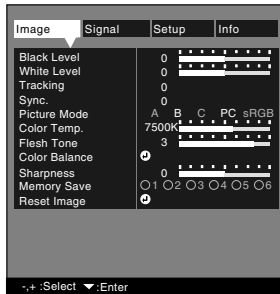

DVI

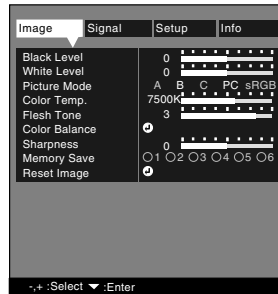

Main menu	Sub-menu	Function	Default setting
Image	Black Level	This lets you adjust dark shades without affecting the white level setting. (p.23)	0
	White Level	This lets you adjust light shades without affecting the black level setting. (p.23)	0
	<u>Tracking</u> ▶	(INPUT A (RGB) and INPUT B (RGB) only) Adjusts computer images when vertical stripes appear in the images.	0
	<u>Sync.</u> ▶	(INPUT A (RGB) and INPUT B (RGB) only) Adjusts computer images when flickering, fuzziness or interference appear in the images.	0
	Picture Mode	Corrects the vividness of the image color. You can select from five different quality settings depending on the surroundings. <ul style="list-style-type: none"> ●A :Ideal for enjoying presentations in a natural atmosphere. ●B :Ideal for enjoying presentations such as movies which have large numbers of dark scenes. ●C :Ideal for projecting images with greater modulation and intensity. ●PC :Ideal for use in making images as bright as possible when projecting computer images. ●sRGB :Images conform to the sRGB standard. 	B

Main menu	Sub-menu	Function	Default setting
Image	<u>Color Temp.</u> ▶▶	Allows lighter colors to be adjusted so that they range from having a red tinge to having a blue tinge. (p.24) When the color temperature is lower, the red content is greater and color tones appear softer. When the color temperature is higher, the blue content is greater and color tones appear fresher.	7500K
	Flesh Tone	The "Flesh Tone" setting adjusts the green component of image signals. (p.24) If adjusted to the - side, the colors appear purplish. If adjusted to the + side, the green component is increased. Adjust until the desired flesh tones are obtained.	3
	Color Balance	The <u>Offset</u> ▶▶, <u>Gain</u> ▶▶ and <u>Gamma</u> ▶▶ can be adjusted separately for each RGB component. (p.24) Offset adjusts coloration for darker shades, Gamma adjusts intermediate shades, and Gain adjusts brighter shades. The working of each adjustment is shown below. <div style="display: flex; justify-content: space-around;"> <div style="text-align: center;"> <p>Offset adjustment Brightness</p> <p>Input signal</p> </div> <div style="text-align: center;"> <p>Gain adjustment Brightness</p> <p>Input signal</p> </div> <div style="text-align: center;"> <p>Gamma adjustment Brightness</p> <p>Input signal</p> </div> </div> <p>Each RGB component can be adjusted to give the desired level of coloration to dark, intermediate and light ranges.</p>	Offset R : 0 G : 0 B : 0 Gain R : 0 G : 0 B : 0 Gamma R : 0 G : 0 B : 0
	Sharpness	Adjusts the image sharpness.	0
	Memory Save	This lets you save image adjustment settings and to retrieve them by pressing the corresponding remote control memory buttons. The images being projected will be adjusted according to the settings that are retrieved. (p.24) <ul style="list-style-type: none"> • The current settings are saved to a particular recording area number when that number is selected. • The setting values that are saved to memory can be cleared by selecting "Reset All". 	-
	Reset Image	Resets all adjustment values for the "Image" menu functions to their default settings. However, all settings that are stored in memory are retained. <ul style="list-style-type: none"> • Press the (Ⓢ) on either the projector's control panel or the remote control to display the confirmation screen, and select "Yes". • Select "Reset All" to return all menu settings to their default settings. (p.32) 	-

Signal Menu

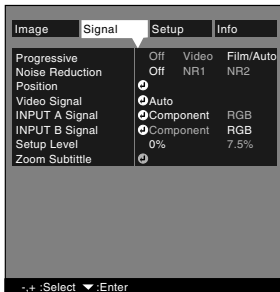



Main menu	Sub-menu	Function	Default setting
Signal	Progressive	<p>(Adjustment is only possible when composite, S-Video, 480i and 576i signals are being input.) Depending on the combination of the model of VCR and the type of video tape you are using, the colour in the images being projected may flicker and the colours may not be projected correctly. If this happens, change the “Progressive” setting in the “Signal” menu to “OFF”. Changes signals from Faroudja’s <u>interlaced</u> mode to progressive (IP) conversion mode.</p> <ul style="list-style-type: none"> •Off :Progressive (IP) conversion is carried out for the screens in each field. It is designed for use when viewing images with large amounts of movement. The <u>DCDi function</u> does not operate. •Video :Turns off the <u>Film judgment function</u>. The DCDi function operates. •Film/Auto :This setting should normally be used. The projector automatically determines whether the signal source is a film source or not. If the source is a film source, the <u>3-2 pull-down function</u> operates so that film images which match the original are reproduced. The DCDi function operates. 	Film/Auto
	Noise Reduction	<p>(Adjustment is only possible when composite, S-Video, 480i and 576i signals are being input.) Reduces image interference and makes the image quality softer. Two modes are available. Use the setting that best suits the images being viewed. It is recommended that you set this function to Off when viewing images sources such as DVDs which are relatively free from interference.</p>	Off
	Position	<p>(Adjustment is not possible when DVI signals are being input.) Moves the image display position vertically and horizontally.</p> <ul style="list-style-type: none"> •Press the button on either the projector's control panel or the remote control to display the display position sub-menu, and then use the Δ, ∇, $-$ and $+$ buttons to make the adjustment using the display position adjustment screen that appears. 	Depends on connection
	Video Signal	<p>(Adjustment is only possible when composite or S-Video signals are being input.) Depending on the combination of the model of VCR and the type of video tape you are using, the “Auto” function may not recognise the signal correctly, and this may result in the images being truncated or colours not being displayed correctly. If this happens, change the setting from “Auto” to the signal format for the signals being played back. Sets the video signal format.</p> <ul style="list-style-type: none"> •Press the on either the projector's control panel or the remote control, and select the setting using the menu that appears. •When set to “Auto”, the video signal format is set automatically, but if projecting signals in PAL-N format, the setting needs to be made manually. 	Auto
	INPUT A Signal	Selects the type of signal being input to the INPUT A port.	Component
	INPUT B Signal	Selects the type of signal being input to the INPUT B port.	RGB

Main menu	Sub-menu	Function	Default setting
Signal	Setup Level	(Adjustment is only possible when NTSC, 480i/p, 576i/p, 720p and 1080i signals are being input.) This setting does not normally need to be changed when connecting the projector to video equipment that is designed for use within Japan. If connecting the projector to video equipment outside Japan that has different black level settings, or if connecting to equipment in Japan that lets you vary the black level setting, you may need to use this command to adjust the projected images so that they display correctly. Check the specifications of the video equipment being connected before changing this setting.	0%
	Zoom Subtitle	Sets the display position and vertical enlargement ratio for "Zoom -Subtitle-" images according to the selected aspect ratio. <ul style="list-style-type: none"> •V size :This adjusts the vertical enlargement ratio without changing the size in the horizontal direction. •V position :This moves the display position up. 	V Size : 2 V Position : 10

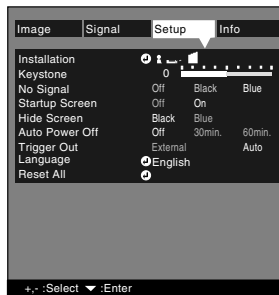
Setup Menu



Main menu	Sub-menu	Function	Default setting
Setup	Installation	Selects the projection method in accordance with the projector and screen setting-up method. <ul style="list-style-type: none"> • :Projection from the front of the screen • :Projection from the front of the screen with the projector installed to the ceiling (upside down) • :Projection from the rear of the screen • :Projection from the rear of the screen with the projector installed to the ceiling (upside down) 	
	Keystone	<ul style="list-style-type: none"> • Corrects keystone distortion in images. (p.12) • When keystone correction is carried out, the projected image will become smaller. • The keystone correction settings are memorized, so that if you change the position or angle of the projector, you may need to readjust the keystone correction setting. • If the images become uneven in appearance after keystone correction is carried out, decrease the "Sharpness" setting. 	0
	No Signal	Sets the screen status when no video signal is being input. <ul style="list-style-type: none"> • Off :Screen is completely black. • Black :Screen is completely black and a no signal message appears. • Blue :Screen is completely blue and a no signal message appears. 	Blue
	Startup Screen	This sets whether a starting-up screen (YAMAHA logo) is used or not.	On
	Hide Screen	Sets the screen status when the [HIDE] button on the remote control is pressed. The screen status can be selected from either "Blue" or "Black".	Black

Main menu	Sub-menu	Function	Default setting
Setup	Auto Power Off	<p>This sets whether the projector's power turns off automatically or not when the signal from the input source that was selected using the [INPUT] button stops being input.</p> <p>Setting value range : Off, 30 min., 60 min.</p> <ul style="list-style-type: none"> • If a time is set, and if the connected source is equipped with a timer Off function, the projector's power will be turned off once the set time has elapsed after the input signal has switched off. • This can be used to ensure the projector turns off even if the viewer falls asleep while viewing. • When Auto Power Off has been activated so that the projector is in standby mode, the power will not turn back on again even if an image signal is input once more. Press the [STANDBY/ON] button on either the projector's control panel or the remote control to turn the power back on. 	Off
	Trigger Out	<p>This is an output signal for controlling external equipment.</p> <ul style="list-style-type: none"> • While projection is in progress, a voltage of +12 V is output. • When "Auto" is selected, the trigger out signal turns ON and OFF in accordance with the illumination of the projector's lamp. When "External" is selected, the trigger out signal turns ON and OFF in accordance with control signals received via the RS-232C port. 	Auto
	Language	<p>Sets the display language for messages and menus.</p> <ul style="list-style-type: none"> • Press the  on either the projector's control panel or the remote control, and select the language from the selection menu that appears. 	English
	Reset All	<p>Resets all items in all menus to their default settings.</p> <ul style="list-style-type: none"> • Press the  on either the projector's control panel or the remote control to display the confirmation screen, and select "Yes". • To reset the "Image" menu settings to their default values, select "Reset" from the sub-menu. <p>The "Lamp" and "Language" settings will not be reset.</p>	-

Info Menu

- The “Info” menu displays the settings for the input source for the images being projected, and also shows the lamp status.
- The "Lamp" shows times between 0 and 10 hours as 0H. Times greater than 10 hours appear in units of one hour.

Video (INPUT A (Component), INPUT B (Component), D4 VIDEO, S VIDEO, VIDEO)

Video (INPUT A (Component), INPUT B (Component), D4 VIDEO, S VIDEO, VIDEO)

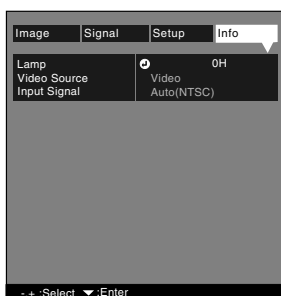

Main menu	Sub-menu	Function	Default setting
Info	Lamp	Displays the cumulative lamp operating time. When the lamp warning period is reached, the display characters appear in red. <ul style="list-style-type: none"> • Press the button on either the projector's control panel or the remote control to display the “Reset Lamp Timer” menu. • You should reset the lamp operating time when the lamp is replaced. When this is done, the cumulative lamp operating time will be cleared and reset to the default value. 	0H
	Video Source	Displays the image source which is currently being projected.	Depends on connection
	Input Signal	Displays the video signal format.	Auto

Computer (DVI, INPUT A (RGB), INPUT B (RGB))

Computer

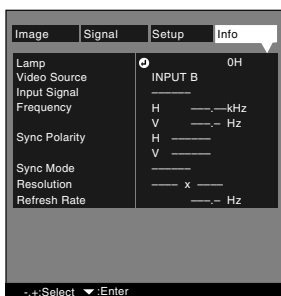

Main menu	Sub-menu	Function	Default setting
Info	Lamp	Displays the cumulative lamp operating time. When the lamp warning period is reached, the display characters appear in red. <ul style="list-style-type: none"> • Press the button on either the projector's control panel or the remote control to display the “Reset Lamp Timer” menu. • You should reset the lamp operating time when the lamp is replaced. When this is done, the cumulative lamp operating time will be cleared and reset to the default value. 	0H
	Video Source	Displays the image source which is currently being projected.	Depends on connection

Main menu	Sub-menu	Function	Default setting
Info	Input Signal	Displays the input signal settings.	-
	Frequency	Displays the horizontal and vertical scanning frequencies.	-
	Sync Polarity	Displays the <u>synchronization</u> polarity.	-
	Sync Mode	Displays the synchronization attributes.	-
	Resolution	Displays the input resolution.	-
	<u>Refresh Rate</u>	Displays the refresh rate.	-

Troubleshooting

This chapter describes troubleshooting procedures for the projector.

When Having Some Trouble.....	36
When the Indicators Provide No Help	38

When Having Some Trouble

If you are having a problem with the projector, first check the projector's indicators. The projector is provided with the following three indicators. These indicators alert you to problems with projector operation.

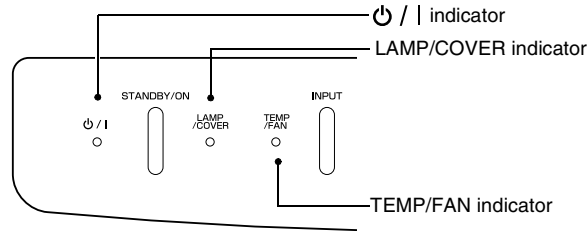

The following tables show what the indicators mean and how to remedy problems that they indicate.

● : lit ✨ : flashing ○ : off

Indicator status	Projector status	Problem and remedy	Reference page
Red Red Red φ / I LAMP / COVER TEMP / FAN ● ✨ ✨	Internal problem	Stop using the projector, disconnect the power cord from the electrical outlet, and contact your dealer.	
Red Red φ / I LAMP / COVER TEMP / FAN ● ○ ✨	Fan problem/Sensor problem	Stop using the projector, disconnect the power cord from the electrical outlet, and contact your dealer.	
Red Red φ / I LAMP / COVER TEMP / FAN ● ● ○	Lamp problem/Lamp cover problem	Replace the lamp with a new one. When replacing the lamp, check that the lamp and the lamp cover are securely installed. If the lamp or lamp cover is not securely installed, the projector power will not turn on.	p.48
Red Red φ / I LAMP / COVER TEMP / FAN ● ✨ ○	Lamp operating error	This can happen when the main power switch at the rear of the projector was turned off before the cool-down period had finished the last time the projector was turned off, and it was then turned back on again before one hour had passed. When turning off the projector, wait 2 minutes. After about 2 minutes, the cooling fan will stop. When the cooling fan stops, turn off the main power switch and then turn it back on again. When the main power switch is turned back on, the projector will return to its previous state, so press the [STANDBY/ON] button on either the remote control or the projector's control panel to turn it back on. If the lamp operating error happens again when the power is turned back on, remove the lamp and check if the lamp is broken. If it is not broken, reinstall it. If it is broken, replace it. Then turn on the main power switch at the rear of the projector and press the [STANDBY/ON] button on either the remote control or the projector's control panel. If the indicators still show a problem, stop using the projector, turn off the main power switch, disconnect the power cord from the electrical outlet, and contact your dealer.	p.48

Indicator status	Projector status	Problem and remedy	Reference page
<p>Red Red</p> <p>⏻ / I LAMP / COVER TEMP / FAN</p> <p>● ○ ●</p>	High temperature inside projector (overheating)	<p>The lamp will turn off automatically and projection will stop. Wait for about 5 minutes without operating the projector. After 5 minutes have elapsed, the projector's cooling fan will stop. When the cooling fan stops, turn off the main power switch and then turn it back on again.</p> <p>If the projector overheats, check the following two points.</p> <ul style="list-style-type: none"> ● Is the setting-up location well ventilated? Check that the air inlet and air outlet are clear, and that the projector is not positioned against a wall. ● Is the air filter blocked with dust? If the air filter is dirty, it should be cleaned. <p>When the main power switch is turned back on, the projector will return to its previous state, so press the [STANDBY/ON] button on either the remote control or the projector's control panel to turn it back on. If the projector continues to overheat even after the above points have been checked, or if the indicators show a problem when the power is turned back on, stop using the projector, turn off the main power switch, disconnect the power cord from the electrical outlet, and contact your dealer.</p>	"Setup Guide" p.46
<p>Orange</p> <p>LAMP / COVER TEMP / FAN</p> <p>○ ●</p>	High-speed cooling in progress	<p>(This is not an abnormality, but if the temperature rises too high again, projection will stop automatically.)</p> <ul style="list-style-type: none"> ● Set the projector up in a place which is well-ventilated, and so that the air inlet and exhaust vents are clear. ● Clean the air filter. <p>* The appearance of the ⏻ / I indicator at this time will vary depending on the status of the projector.</p>	"Setup Guide" p.46
<p>Orange</p> <p>LAMP / COVER TEMP / FAN</p> <p>● ○</p>	Lamp will soon need to be replaced.	<p>(No abnormality) Have a new replacement lamp ready. The lamp service life can become shorter than normal as a result of the usage conditions, and so the lamp should be replaced as soon as possible.</p> <p>* The appearance of the ⏻ / I indicator at this time will vary depending on the status of the projector.</p>	p.47
<p>Orange</p> <p>⏻ / I LAMP / COVER TEMP / FAN</p> <p>● ○ ○</p>	Standby condition	<p>(No abnormality) Projection starts when the [STANDBY/ON] button on either the remote control or the projector's control panel is pressed.</p>	p.6
<p>Green</p> <p>⏻ / I LAMP / COVER TEMP / FAN</p> <p>● ● ○</p>	Warm-up in progress	<p>(No abnormality) Wait for a short while. The indicator will stop flashing and light with a green color.</p>	p.7
<p>Green</p> <p>⏻ / I LAMP / COVER TEMP / FAN</p> <p>● ○ ○</p>	Projecting in progress	<p>(No abnormality)</p>	p.7
<p>Red/ Orange</p> <p>⏻ / I LAMP / COVER TEMP / FAN</p> <p>● ● ○</p>	Cool-down in progress	<p>(No abnormality)</p> <ul style="list-style-type: none"> ● Wait for a short while. The cool-down (lamp cooling operation) period lasts for about 5 minutes. The actual time will vary depending on factors such as the ambient air temperature. ● The [STANDBY/ON] buttons on both the projector's control panel and the remote control will not operate while the ⏻ / I indicator is flashing red. When the indicator changes to flashing orange (after approximately 90 seconds), the [STANDBY/ON] buttons on the projector's control panel and the remote control will then work. ● If the main power switch at the rear of the projector is turned off before cool-down is complete, wait for the lamp to cool down (normally about one hour is required) before turning the power back on again. 	p.9







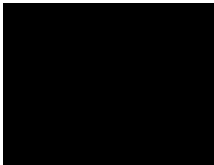

- If the projector is not operating properly even though the indicators are all showing normal, refer to "When the Indicators Provide No Help" on the following page.
- If an indicator is showing a status which does not appear in the previous tables, contact your dealer.

When the Indicators Provide No Help

If any of the following problems occur and the indicators do not offer a solution, refer to the pages given for each problem.

No images appear	p.38, p.39	Images appear dark	p.42
Poor image quality	p.40	Images appear green	p.42
Only part of the image is displayed (Large/small)	p.41	The remote control does not work	p.42
The image colors are not right	p.41	The power does not turn off	p.43

	Condition No images appear (Nothing at all appears)
---	--

Probable cause	Remedy
Is the lens cap still attached?	→ Remove the lens cap. (p.6)
Is the power cord disconnected?	→ Check the power cable connection at the power inlet of the projector and at the wall outlet. (p.6)
Is the main power switch turned off?	→ Turn on the main power switch at the rear of the projector. (p.6)
Was the power turned off and then straight back on again? The [STANDBY/ON] buttons on both the projector's control panel and the remote control will not operate while the  /  indicator is flashing red (during <u>cool-down</u> ).	→ When the indicator changes to flashing orange, the [STANDBY/ON] buttons on the projector's control panel and the remote control will then operate. (p.9)
Have you pressed the [STANDBY/ON] button on either the remote control or the projector's control panel?	→ Press the [STANDBY/ON] button on either the remote control or the projector's control panel. (p.7)
Is automatic power off activated? If an automatic power off time has been set, the lamp turns off automatically if no video signal is input and no operations are carried out for the length of time set. The  /  indicator flashes orange at this time.	→ Turn the projector's power off and then back on again. To cancel the automatic power off setting, set "Auto Power Off" in the "Setting" menu to "Off". "Setup" - "Auto Power Off" (p.32)
Is the hide screen activated?	→ Press the [HIDE] button on the remote control to cancel the Hide function. "Setup" - "Hide Screen" (p.31)
Is the projected image completely black? Some input images, such as screen savers, may be completely black.	→ Cancel the screen saver, or re-check the images being input.
Is a image signal being input? If "No Signal" in the "Setup" menu is set to "Off", no message will be displayed.	→ Change the "No Signal" setting to "Black" or "Blue" for messages to be displayed. "Setup" - "No Signal" (p.31) If a message is displayed, refer to the item indicated.
Try resetting all of the current settings.	→ "Reset All" (p.32)

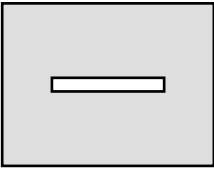

	<p>Condition</p> <p>No images appear (Messages do appear) “Not Supported” message appears on the screen. “No Signal” message appear on the screen.</p>
Probable cause	Remedy
<p>Does the input signal setting match the connected source?</p>	<p>→ Use the “Video Signal”, “INPUT A Signal” or “INPUT B Signal” commands in the “Signal” menu to set the signal format that matches the signal from the connected equipment. “Signal” - “Video Signal”, “INPUT A Signal”, “INPUT B Signal” (p.30)</p>
<p>Has the correct image input port been selected?</p>	<p>→ Press the [INPUT] button on the projector's control panel (or the [DVI], [A], [B], [VIDEO] or [S VIDEO] button on the remote control) to change the image source. (p.7)</p>
<p>Is the power for the computer or video source turned on?</p>	<p>→ Turn on the power. (p.7)</p>
<p>Check the mode which corresponds to the frequency of the image signals being output from the computer.</p>	<p>→ Refer to the documentation provided with your computer for details on changing the resolution and frequency of the image signals being output from the computer. (p.52)</p>
<p>If a laptop computer or a computer with a LCD screen has been connected to the projector, it is necessary to output the image signals to the projector rather than to the screen.</p>	<p>→ Normally image signals are output to only the computer's LCD screen, so you need to change the output to an external destination. For some computer models, when the image signals are output externally, they no longer appear on the LCD screen. For details, refer to the section of the documentation provided with your computer under a heading such as "External output", "Connecting an external monitor" or similar. (p.7)</p>

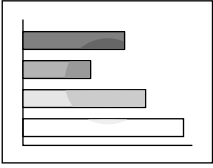
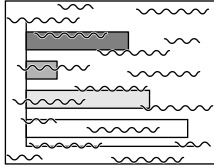

		<p>Condition</p> <p>Poor image quality</p> <ul style="list-style-type: none"> • The image is fuzzy • Part of the image is out of focus • The whole image is out of focus • The image is distorted • The image contains interference
---	---	--

Probable cause	Remedy
Has the focus been adjusted correctly?	→ Adjust the focus. (p.14)
Has the front adjustable foot been adjusted so that the projection angle is too big? If the projection angle is too big, the image will be out of focus vertically.	→ Adjust the projection angle. (p.11)
Is the projector at the correct distance?	→ The recommended distance from the projector to the screen is within 0.9 - 13 m (2.9 - 42.6 ft). Set up the projector so that the projection distance is within this range. (<i>Setup Guide</i>)
Is the projector beam perpendicular to the screen?	→ Adjust the projection angle so that the projector beam is perpendicular to the screen. (p.11)
Is the lens dirty?	→ Clean the lens. (p.46)
Has condensation formed on the lens? If the projector is suddenly taken from a cold environment to a warm environment, condensation may form on the lens, and this may cause the images to appear fuzzy.	→ Turn off the power and wait for the condensation to disappear.
Does the input signal setting match the connected source?	→ Use the “Video Signal”, “INPUT A Signal” or “INPUT B Signal” commands in the “Signal” menu to select the signal format that matches the connected source. “Signal” - “Video Signal”, “INPUT A Signal”, “INPUT B Signal” (p.30)
Are the cables connected correctly?	→ Check that all cables that are required for projection are connected correctly. (<i>Setup Guide</i>)
Is an extension cable being used? If an extension cable is used, electrical interference may increase.	→ Use the accessory cables provided, or connect a signal amplifier and see if this helps.
Have the synchronization , tracking and display position been adjusted correctly? (When connected to a computer)	→ Press the [AUTO] button on either the remote control or the projector's control panel to adjust these settings. You can also use the menus to make the adjustment. (p.17, “Image” - “Tracking”, “Sync.” p.28)
Has the correct resolution been selected? (When connected to a computer)	→ Set the computer so that the signals that are output are compatible with this projector. Refer to the documentation provided with your computer for details on changing the settings. (p.52)

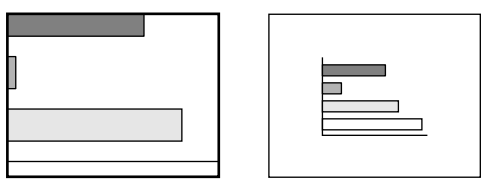

	<p>Condition</p> <ul style="list-style-type: none"> • Image is too large (Only part of the image is displayed) • Image is too small
---	--

Probable cause	Remedy
The display mode (<u>aspect ratio</u>) setting may not be selected correctly.	→ Press the [ASPECT] button on either the remote control or the projector's control panel. (p.15)
Has the "Position" setting been adjusted correctly?	→ Use the "Position" command in the "Signal" menu to adjust. (p.30)
Has the correct resolution been selected?	→ Set the computer so that the signals that are output are compatible with this projector. Refer to the documentation provided with your computer for details on changing the settings. (p.52)
Change the resolution for the laptop computer or computer with a LCD screen.	→ Change the resolution so that the image is displayed in the whole of the projection area, or set the image signal to external output only. (p.7)
Has the computer been set for dual display?	→ If dual display has been activated in the "Display Properties" of the computer's "Control Panel", the projector will only project about half of the image on the computer screen. To display the whole of the image on the computer screen, turn off the dual display setting. Refer to the video driver manual for the computer's monitor for further details.

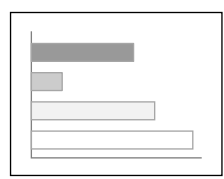
	<p>Condition</p> <p>The image colors are not right</p>
---	---

Probable cause	Remedy
Are the cables connected correctly?	→ Check that all cables that are required for projection are connected correctly. (<i>Setup Guide</i>)
Has the image <u>contrast</u> been adjusted correctly?	→ Use the "White Level" command in the "Video" menu to adjust the contrast. "Image" - "White Level" (p.26, 28)
Have the color temperature, flesh tone and color balance been set correctly?	→ Use the "Image" menu to adjust the contrast. "Image" - "Color Temp.", "Flesh Tone", "Color Balance" (p.27, 29)
Have the color intensity and tint been adjusted correctly? (The colors may not exactly match the colors in the image on the computer screen or LCD screen, but this is normal and is not the sign of a problem.)	→ Use the "Image" menu to adjust the "Saturation" and "Hue" settings "Image" - "Saturation", "Hue" (p.26)
Is the lamp due for replacement? If the LAMP/COVER indicator is flashing orange, it means that the lamp will soon be due for replacement. When the lamp is nearly due for replacement, the image will become darker and the tint will become poorer.	→ Replace the lamp with a new one. (p.48, 49)
Does the input signal setting match the connected source?	→ Use the "Video Signal", "INPUT A Signal" or "INPUT B Signal" commands in the "Signal" menu to select the signal format that matches the connected source. "Signal" - "Video Signal", "INPUT A Signal", "INPUT B Signal" (p.30)

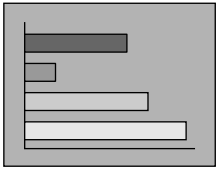

	<p>Condition</p> <p>Images appear dark</p>
---	--

Probable cause	Remedy
<p>Is the lamp due for replacement?</p> <p>If the LAMP/COVER indicator is flashing orange, it means that the lamp will soon be due for replacement. When the lamp is nearly due for replacement, the image will become darker and the tint will become poorer.</p>	<p>➔ Replace the lamp with a new one. (p.48, 49)</p>

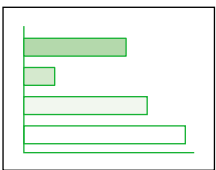
	<p>Condition</p> <p>Images appear green</p>
---	---

Probable cause	Remedy
<p>Do the settings for component video input signals match the signals from the connected device?</p> <p>If the “Component” or “RGB” settings are incorrect, the images may appear greenish.</p>	<p>➔ Use the “INPUT A Signal” or “INPUT B Signal” commands in the “Signal” menu to select the signal format that matches the connected source. “Signal” - “INPUT A Signal” , “INPUT B Signal” (p.30)</p>

	<p>Condition</p> <p>The remote control does not work</p>
---	--

Probable cause	Remedy
<p>Is the remote control being pointed at the right angle?</p>	<p>➔ The operating angle for the remote control is approximately 30° horizontally and approximately 30° vertically. Use the remote control within these ranges. (<i>Setup Guide</i>)</p>
<p>Is the remote control too far from the projector?</p>	<p>➔ The operating distance for the remote control is approximately 7 m (23 ft.). Use the remote control within this distance. (<i>Setup Guide</i>)</p>
<p>Is direct sunlight or strong light from fluorescent lamps shining onto the remote control light-receiving area?</p>	<p>➔ Avoid using projector in places where the remote control light-receiving area is exposed to strong light.</p>
<p>Are there batteries in the remote control?</p>	<p>➔ Insert batteries into the remote control. (<i>Setup Guide</i>)</p>
<p>Are the batteries dead?</p>	<p>➔ Replace the batteries with new ones. (<i>Setup Guide</i>)</p>
<p>Have the batteries been inserted correctly?</p>	<p>➔ Insert the batteries so that they face in the correct direction. (<i>Setup Guide</i>)</p>

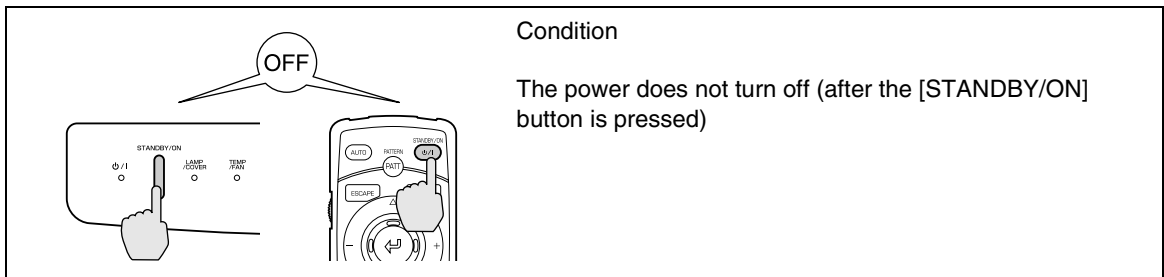

Condition

The power does not turn off (after the [STANDBY/ON] button is pressed)

Probable cause	Remedy
<p>Is the ϕ / indicator still orange? This projector is designed so that the ϕ / indicator remains lit even when after the power has been turned off.</p>	<p>➔ When the main power switch at the rear of the projector is turned off, the ϕ / indicator switches off.</p>
<p>Is the fan operating? After the [STANDBY/ON] button on either the remote control or the projector's control panel is pressed to turn off the power, the <u>cool-down</u>▶▶ period starts.</p>	<p>➔ After the cool-down period is complete, the ϕ / indicator lights orange, and you can then turn off the main power switch. * The cool-down period is approximately 5 minutes. The actual time will vary depending on the external air temperature.</p>

Appendices

This chapter provides information on maintenance procedures to ensure the best level of performance for the projector for a long time.

Maintenance.....	46
• Cleaning.....	46
• Cleaning the Projector Case	46
• Cleaning the Lens.....	46
• Cleaning the Air Filter.....	46
• Replacing Consumables	47
• Lamp Replacement Period	47
• Replacing the Lamp	48
• Resetting the Lamp Operating Time	49
• Replacing the Air Filter.....	50
Optional Accessories.....	51
List of Supported Signal Resolutions	52
• Component Video Input	52
• Composite Video/S-Video Input.....	52
• RGB Input.....	53
Specifications	54
Appearance.....	56
Part Names and Functions.....	57
• Front/Top	57
• Control Panel	58
• Rear.....	59
• Base.....	59
• Remote Control.....	60
Glossary	61
Index.....	63

Maintenance

This section describes maintenance tasks such as cleaning the projector and replacing consumable parts.

Cleaning

You should clean the projector if it becomes dirty or if the quality of projected images starts to deteriorate.



Be sure to read the *Safety Instructions* in this manual for details on safe handling of the projector during cleaning.

Cleaning the Projector Case

Clean the projector case by wiping it gently with a soft cloth.

If the projector is particularly dirty, moisten the cloth with water containing a small amount of neutral detergent, and then firmly wring the cloth dry before using it to wipe the projector case. Then wipe the case again with a soft, dry cloth.



Do not use volatile substances such as wax, alcohol or thinner to clean the projector case. These can cause the case to warp and make the coating finish peel off.

Cleaning the Lens

Use a commercially-available air blower, or use a lens cleaning paper to gently wipe the lens.



Do not rub the lens with harsh materials or subject the lens to shocks, as it can easily become damaged.

Cleaning the Air Filter

If the air filter becomes clogged with dust, it can cause overheating and damage the projector.

Stand up the projector in order to prevent dust getting inside the projector, and then use a vacuum cleaner to clean away the dust from the air filter.

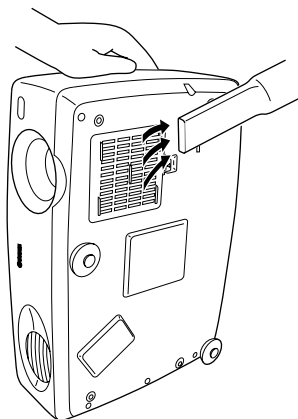

- If the air filter is difficult to clean or if it is broken, it should be replaced. Contact your dealer for a spare air filter.
- Replacement lamps are provided with a spare air filter. The air filter should also be replaced when the lamp is replaced.

Replacing Consumables

This section describes how to replace the lamp and the air filter.

Lamp Replacement Period

It is time to replace the lamp when:

- The message "Lamp Replace" appears on the screen when projection starts.

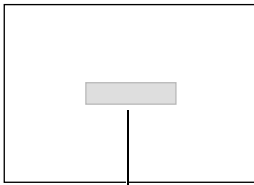

A message will be displayed.

The message appears for 30 seconds, and disappears again after 30 seconds have passed.

- The LAMP/COVER indicator flashes orange or lights red.

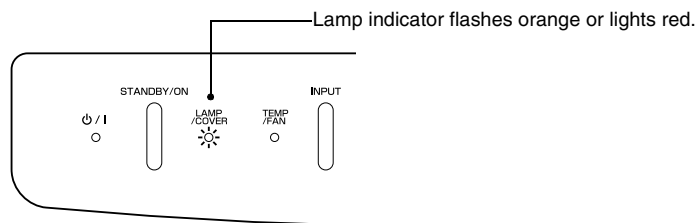

Lamp indicator flashes orange or lights red.

- The projected image gets darker or starts to deteriorate.



- In order to maintain the brightness and quality of the projected images, replace the lamp as soon as possible after the warning message appears.
- The replacement warning message is set to appear after 2900 hours of lamp use in order to maintain the brightness and quality of the projected images. If you continue to use the lamp after this period, the possibility of the lamp breaking becomes greater. When the lamp replacement message appears, replace the lamp with a new one as soon as possible, even if it is still working.
- The warning message appears after 2900 hours of use, but the actual life of each individual lamp will vary depending on the characteristics of the lamp and on the way it has been used. Some lamps may stop operating before 2900 hours of use, so you should always have a spare lamp ready in case.
- When the lamp replacement warning message appears, the user's logo will not appear even if the "Startup Screen" setting is "ON".
- Contact your dealer for a spare lamp.

Replacing the Lamp



- If the lamp stops working and needs to be replaced, there is the danger that the lamp may break when handled. If replacing the lamp of a projector which has been installed to the ceiling, you should remove the projector from the ceiling before replacing the lamp. If the projector cannot be removed from the ceiling, you should always assume that the lamp is broken and handle it with extreme care during removal. Furthermore, you should stand to the side of the projector, not underneath it.
- Wait until the lamp has cooled down sufficiently before opening the lamp cover. After the **cool-down** period has finished, it takes approximately a further 30 minutes for the lamp to be cool enough.

Procedure

1

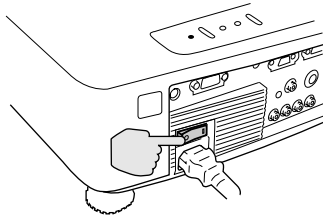

Turn off the main power switch at the rear of the projector. (p.9)

2

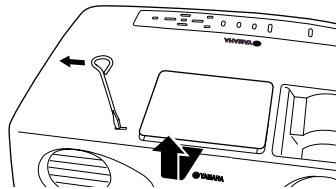

After the lamp has cooled down sufficiently, open the lamp cover.

After the cool-down period has finished, it takes approximately a further 30 minutes for the lamp to be cool enough.

Use the screwdriver that is provided with the replacement lamp to slide the lamp cover opening switch so that the lamp cover lifts up. Clasp the lifted-up portion of the lamp cover with your fingers and slide the cover toward the front of the projector to open it.

3

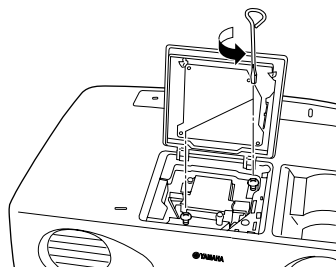

Loosen the two lamp fixing screws.

Use the screwdriver that is supplied with the replacement lamp to loosen the two lamp fixing screws that are securing the lamp to the projector.

4

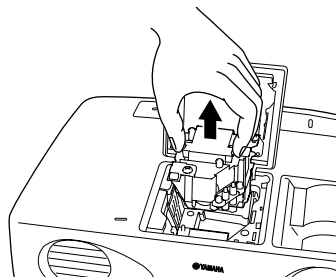

Take out the lamp.

Hold the lamp so that it faces the correct way to fit into the projector, and then push it in securely and tighten the two fixing screws.

5

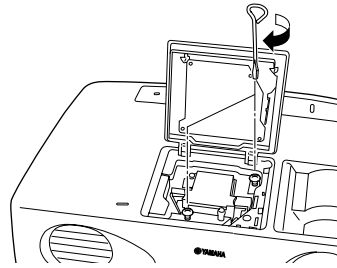

Install the new lamp.

Hold the lamp so that it faces the correct way to fit into the projector, and then insert the lamp until it clicks into place and tighten the two fixing screws.

6

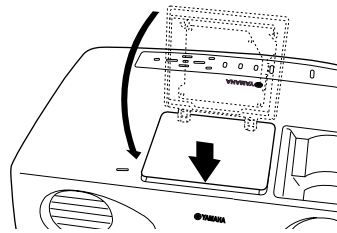

Install the lamp cover.

Close the lamp cover, slide it toward the rear of the projector, and then push the front part downward until it clicks into place.



- Install the lamp securely. For safety, the lamp will turn off automatically when the lamp cover is opened. Moreover, the lamp will not turn on if the lamp or the lamp cover is not installed correctly.
- Replacement lamps are provided with a spare air filter. The air filter should also be replaced when the lamp is replaced.
- Dispose of used lamps properly in accordance with your local regulations.

Resetting the Lamp Operating Time

The projector has a built-in counter which keeps track of the lamp operating time. When the cumulative operating time reaches a certain point, it causes the replacement warning message to be displayed. Therefore, the counter needs to be reset after the lamp has been replaced with a new one. You can do this using the projector menu.



Do not reset the lamp operating time except after the lamp has been replaced, otherwise the lamp replacement period will not be indicated correctly.

Procedure

1

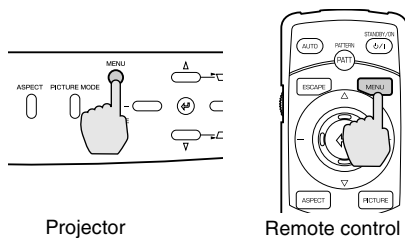

Press the [MENU] button on either the remote control or the projector's control panel.

The menu will be displayed.

2



Select "Lamp" from the "Info" menu.

Press the on either the projector's control panel or the remote control.

3

Reset Lamp Timer

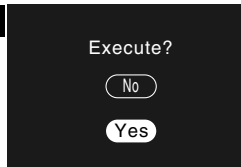

Reset the lamp operating time.

Select “Yes”, and then press the  on either the projector's control panel or the remote control.

Replacing the Air Filter

Procedure

1

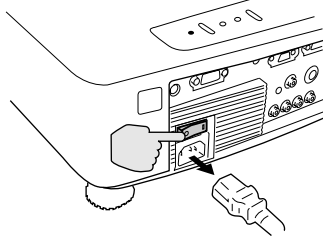

Turn off the power switch at the rear of the projector, and then disconnect the power cord. (p.9)

2

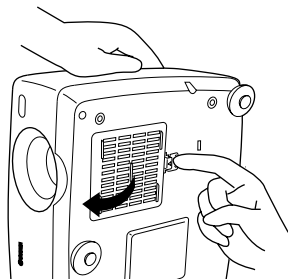

Put your finger into the recess in the air filter hook, and lift up the air filter to remove it.

Be sure to keep the projector standing up while working in order to stop foreign particles from the air filter getting inside the projector.

3

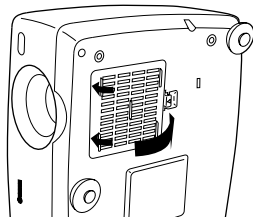

Install the new air filter.

First insert the tabs, and then press down on the opposite side until it clicks into place.



Dispose of used air filters properly in accordance with your local regulations.

Optional Accessories

The following optional accessories are available for purchase if required. This list of optional accessories is current as of July 2002. Details of optional accessories are subject to change without notice.

Spare lamp	PJL-5015
Use as a replacement for spent lamps.	
Ceiling mount (for low ceilings) *	PMT-L21
Use when installing the projector to a low ceiling.	
Ceiling mount (for high ceilings) *	PMT-H25
Use when installing the projector to a high ceiling.	

*A special method of installation is required in order to suspend the projector from the ceiling. Please contact the place of purchase if you would like to use this installation method.

List of Supported Signal Resolutions

Component Video Input

Units: dots

Signal	Resolution	Aspect					
		Normal (Default)	Squeeze	Zoom	Zoom -Subtitle-	Through	Squeeze Through
<u>SDTV</u> ▶▶ (480i, 60Hz)	640 × 480 640 × 360 (When zoomed)	960 × 720 (4:3 aspect)	1280 × 720 (16:9 aspect)	1280 × 720 (16:9 aspect)	1280 × *** (Variable)	590 × 442 (4:3 aspect)	786 × 442 (16:9 aspect)
SDTV (576i, 50Hz)	768 × 576 768 × 432 (When zoomed)	960 × 720 (4:3 aspect)	1280 × 720 (16:9 aspect)	1280 × 720 (16:9 aspect)	1280 × *** (Variable)	700 × 525 (4:3 aspect)	934 × 525 (16:9 aspect)
SDTV (480p)	640 × 480 640 × 360 (When zoomed)	960 × 720 (4:3 aspect)	1280 × 720 (16:9 aspect)	1280 × 720 (16:9 aspect)	1280 × *** (Variable)	590 × 442 (4:3 aspect)	786 × 442 (16:9 aspect)
SDTV (576p)	768 × 576 768 × 432 (When zoomed)	960 × 720 (4:3 aspect)	1280 × 720 (16:9 aspect)	1280 × 720 (16:9 aspect)	1280 × *** (Variable)	700 × 525 (4:3 aspect)	934 × 525 (16:9 aspect)
<u>HDTV</u> ▶▶ (720p) 16:9	1280 × 720	1280 × 720 (16:9 aspect)	–	–	–	1178 × 664 (16:9 aspect)	–
HDTV (1080p) 16:9	1920 × 1080	1280 × 720 (16:9 aspect)	–	–	–	–	–

Composite Video/S-Video Input

Units: dots

Signal	Resolution	Aspect					
		Normal (Default)	Squeeze	Zoom	Zoom -Subtitle-	Through	Squeeze Through
TV (NTSC)	640 × 480 640 × 360 (When zoomed)	960 × 720 (4:3 aspect)	1280 × 720 (16:9 aspect)	1280 × 720 (16:9 aspect)	1280 × *** (Variable)	590 × 442 (4:3 aspect)	786 × 442 (16:9 aspect)
TV (PAL, SECAM)	768 × 576 768 × 432 (When zoomed)	960 × 720 (4:3 aspect)	1280 × 720 (16:9 aspect)	1280 × 720 (16:9 aspect)	1280 × *** (Variable)	700 × 525 (4:3 aspect)	934 × 525 (16:9 aspect)

RGB Input

Units: dots

Signal	Resolution (When zoomed)	Aspect					
		Normal (Default)	Squeeze	Zoom	Zoom -Subtitle-	Through	Squeeze Through
PC98	640 × 480 (640 × 360)	1152 × 720		1280 × 720		640 × 400	
640 × 350 70	640 × 350 (640 × 350)	1280 × 700		1280 × 700		640 × 350	
VGA▶▶ 60 *, SDTV (480p)	640 × 480 (640 × 360)	960 × 720 (4:3 aspect)	1280 × 720 (16:9 aspect)	1280 × 720 (16:9 aspect)	1280 × *** (Variable)	640 × 480 (4:3 aspect)	854 × 480 (16:9 aspect)
VGA 72/75/85, iMac_VGA	640 × 480 (640 × 360)	960 × 720		1280 × 720		640 × 480	
SVGA▶▶ 56/ 60*/72/75/85, iMac_SVGA	800 × 600 (800 × 450)	960 × 720		1280 × 720		800 × 600	
XGA▶▶ 43i/60*/70/75/ 85	1024 × 768 (1024 × 576)	960 × 720		1280 × 720		–	
1152 × 864 75	1152 × 864 (1152 × 648)	960 × 720		1280 × 720		–	
QVGA 60*/85	1280 × 960 (1280 × 720)	960 × 720		1280 × 720		–	
SXGA▶▶ 60*/75/85	1280 × 1024 (1280 × 720)	900 × 720		1280 × 720		–	
MAC13"	640 × 480 (640 × 360)	960 × 720		1280 × 720		640 × 480	
MAC16"	832 × 624 (832 × 468)	960 × 720		1280 × 720		832 × 624	
MAC19"	1024 × 768 (1024 × 576)	960 × 720		1280 × 720		–	
MAC21"	1152 × 870 (1152 × 648)	954 × 720		1280 × 720		–	
SDTV▶▶ (480i, 60Hz)	640 × 480 (640 × 360)	960 × 720 (4:3 aspect)	1280 × 720 (16:9 aspect)	1280 × 720 (16:9 aspect)	1280 × *** (Variable)	590 × 442 (4:3 aspect)	786 × 442 (16:9 aspect)
SDTV (576i, 50Hz)	768 × 576 (768 × 432)	960 × 720 (4:3 aspect)	1280 × 720 (16:9 aspect)	1280 × 720 (16:9 aspect)	1280 × *** (Variable)	700 × 525 (4:3 aspect)	934 × 525 (16:9 aspect)
SDTV (576p)	768 × 576 (768 × 432)	960 × 720 (4:3 aspect)	1280 × 720 (16:9 aspect)	1280 × 720 (16:9 aspect)	1280 × *** (Variable)	700 × 525 (4:3 aspect)	934 × 525 (16:9 aspect)
HDTV▶▶ (720p)	1280 × 720	1280 × 720 (16:9 aspect)		–		1280 × 720 (16:9 aspect)	
HDTV (1080i, 1080p)	1920 × 1080	1280 × 720 (16:9 aspect)		–			

* indicates resolutions that are compatible with both analog and digital formats.

Specifications

Product name	LPX-500 Home cinema projector		
Dimensions	409 (W) x 111 (H) x 281 (D) mm (16.1 (W) x 4.37 (H) x 11.06 (D) inches) (not including protruding parts)		
Panel size	2.2mm (0.87 inches)		
Display method	Polysilicon TFT active matrix		
Drive method	Full-line 12-phase block sequential writing		
Resolution	921,600 pixels (1280 (W) x 720 (H) dots) x 3		
Focus adjustment	Manual		
Zoom adjustment	Manual (approx. 1:1.35)		
Lamp (light source)	UHP lamp, 150 W, Model No.: PJL-5015		
Power supply	100 – 120 VAC, 2.7A 200 – 240 VAC, 1.3A 50/60 Hz		
Operating temperature	+5°C – +35°C (41°F - 95°F) (No condensation)		
Storage temperature	-10°C – +60°C (14°F - 140°F) (No condensation)		
Weight	Approx. 4.8 kg (10.6 lbs)		
Connectors	DVI	1	DVI-D
	INPUT A	1	4RCA pin jack
	INPUT B	1	Mini D-Sub 15-pin (female)
	VIDEO	1	RCA pin jack
	S VIDEO	1	Mini DIN 4-pin
	D4 VIDEO	1	D4 terminal
	RS-232C	1	D-Sub 9-pin (male)
	TRIGGER OUT	1	3.5 mm mini jack

Safety

USA

UL1950 3rd Edition

Canada

CSA C22.2 No.950 -95 (cUL)

European Community

The Low Voltage Directive (73/23/EEC)

IEC60950 2nd Edition, +Amd.1, +Amd.2, +Amd.3, +Amd.4

EMC

USA

FCC 47CFR Part15B Class B (DoC)

Canada

ICES-003 Class B

European Community

The EMC Directive (89/336/EEC)

EN55022, 1998 Class B

EN55024, 1998

IEC61000-4-2, IEC61000-4-3, IEC61000-4-4, IEC61000-4-5,

IEC61000-4-6, IEC61000-4-8, IEC61000-4-11,

IEC61000-3-2, IEC61000-3-3

Australia/New Zealand

AS/NZS 3548:1995, A1:1997, A2:1997 Class B

CISPR Pub.22:1993, A1:1995, A2:1996, Class B

Appearance

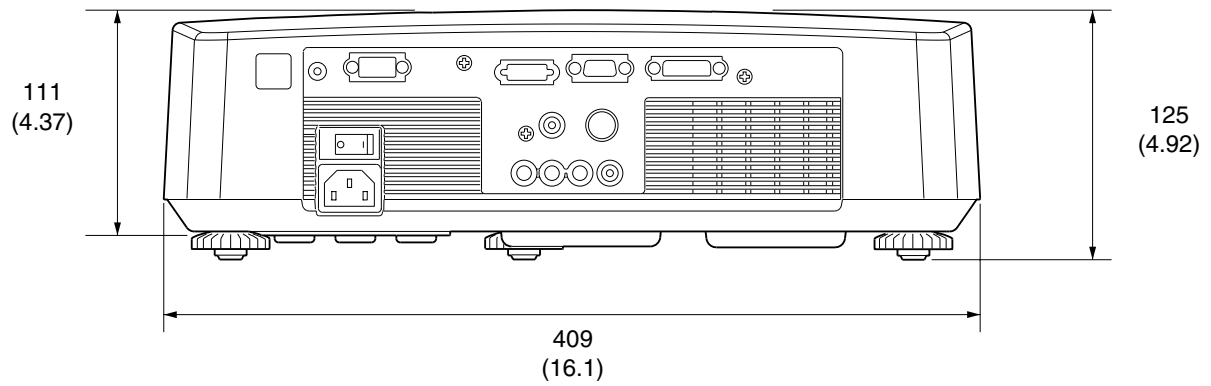
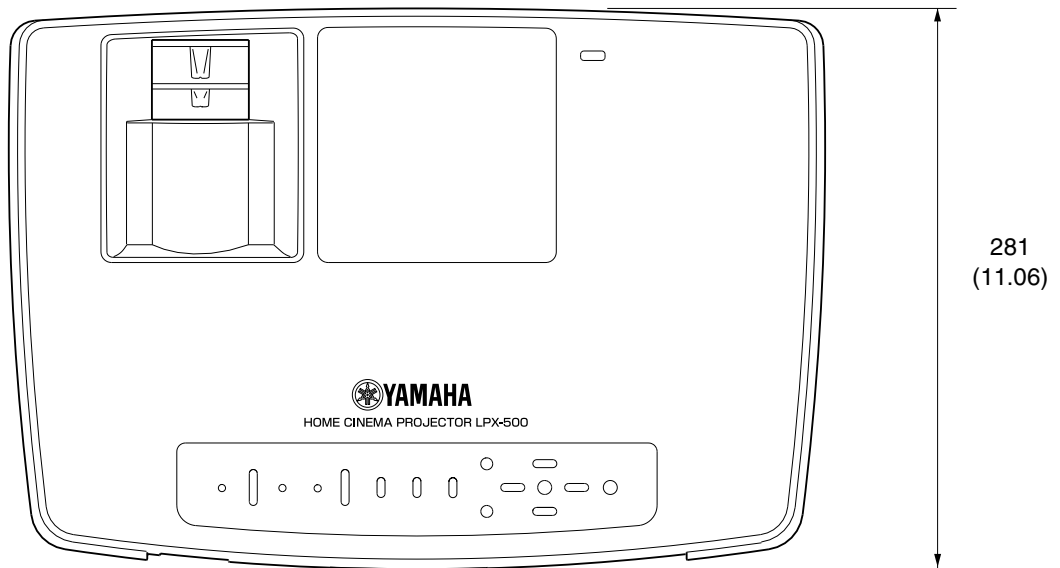
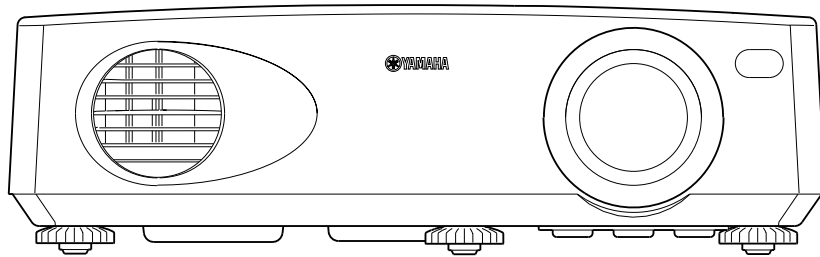

Units: mm (inch)

Part Names and Functions

Front/Top Rear Remote control
Control panel Base



Front/Top

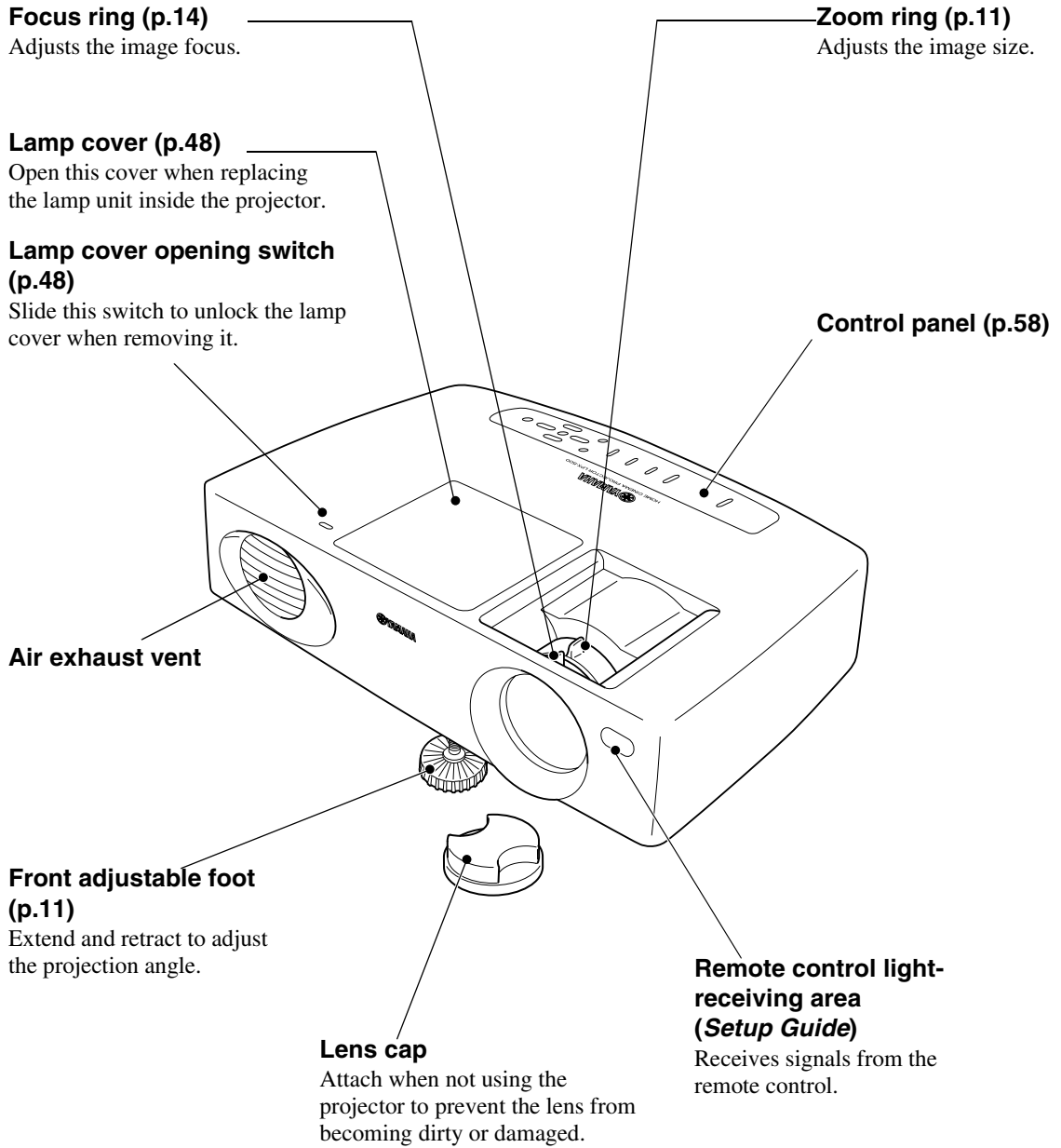

Control Panel

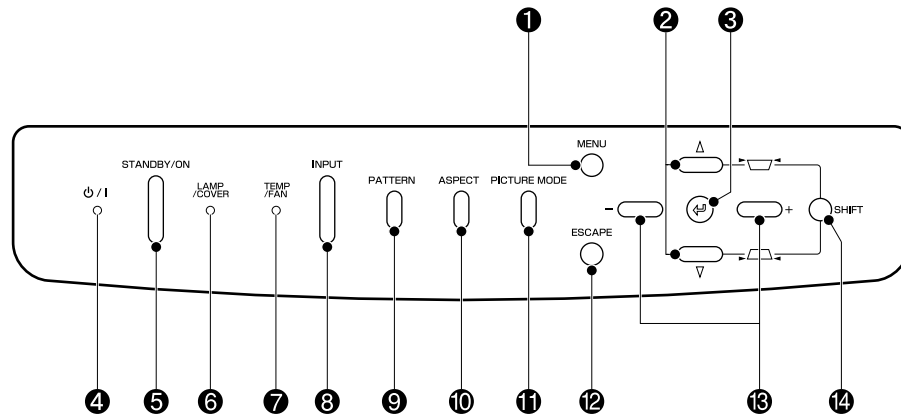

1 [MENU] button (p.20)

The menus turn on and off each time the [MENU] button is pressed.

2 Δ and ∇ buttons (p.12, 21, 22, 25)

Press to select an item in the menu or help menu.

Press and hold the [SHIFT] button while pressing these buttons to correct keystone distortion of images.

3 ⊕ button (p.21, 22, 25)

Displays the line menu.

Pressing the ⊕ button while viewing the menu or the online help selects the menu item and proceeds to the next display.

4 ⏻ / ⏷ indicator (p.36)

Flashes or lights to indicate the operating status of the projector.

5 [STANDBY/ON] button (p.7, 9)

Press to turn the projector power on and off.

6 LAMP/COVER indicator (p.36)

Indicates a problem with the projection lamp or that the lamp needs to be replaced.

7 TEMP/FAN indicator (p.36)

Indicates abnormalities in the internal projector temperature.

8 [INPUT] button (p.7)

Switches the input source between INPUT A → INPUT B → D4 VIDEO → S VIDEO → VIDEO → DVI each time the button is pressed.

9 [PATTERN] button (p.13)

Projects a test pattern for image adjustment. The test pattern switches between Crosshatch → Grayscale Pattern → Off each time the button is pressed.

10 [ASPECT] button (p.15)

Selects the aspect ratio for projected images from one of five settings.

The aspect ratio switches between Normal → Squeeze → Zoom → Zoom -Subtitle- → Through → Squeeze Through each time the button is pressed.

11 [PICTURE MODE] button (p.14)

This selects the picture mode. The picture mode changes in the order A → B → C → PC → sRGB each time the button is pressed.

12 [ESCAPE] button (p.21, 22)

Pressing [ESCAPE] while viewing the menu or the online help displays the previous screen or menu.

13 - and + buttons (p.20, 21, 22, 25)

These buttons select adjustment values in the menus and the online help.

14 [SHIFT] button (p.12)

This button does not function by itself. Press and hold this button while pressing the Δ button or the ∇ button to correct keystone distortion of images.



Rear

TRIGGER OUT port

When the projector power is turned on, 12 V DC is output from this port. When the projector's power is turned off, the output becomes 0 V to communicate the projector's power ON/OFF status to an external device.

Remote control light-receiving area (Setup Guide)

Receives signals from the remote control.

Main power switch (p.6)

Press to turn the main projector's power on and off. When the power is off, the power consumption is 0 W.

Rear adjustable foot

Extend and retract to adjust the horizontal projection angle.

Power inlet (p.6)

Connects the power cord.

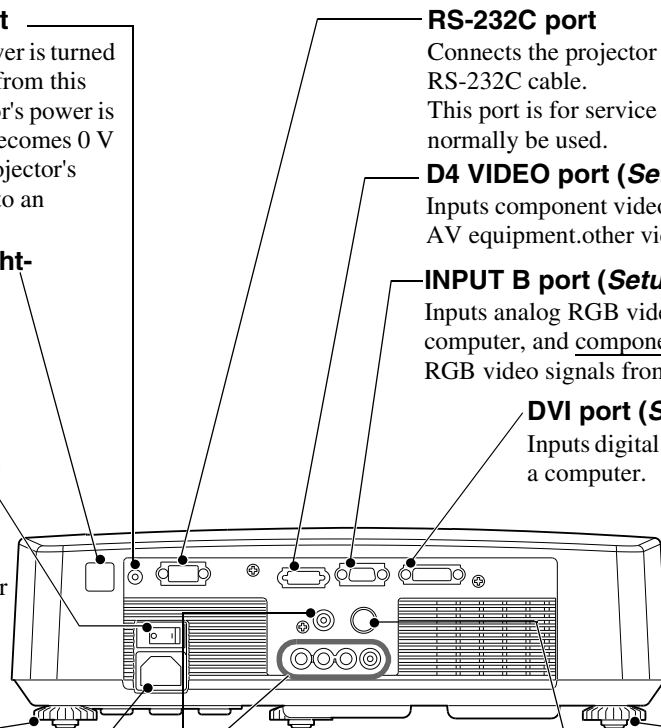

RS-232C port

Connects the projector to a computer using an RS-232C cable. This port is for service use, and should not normally be used.

D4 VIDEO port (Setup Guide)

Inputs component video signals from D ports of AV equipment, other video sources.

INPUT B port (Setup Guide)

Inputs analog RGB video signals from a computer, and component video signals and RGB video signals from other video sources.

DVI port (Setup Guide)

Inputs digital RGB video signals from a computer.

INPUT A port (Setup Guide)

Inputs component video signals and RGB video signals from other video sources.

Rear adjustable foot

Extend and retract to adjust the horizontal projection angle.

VIDEO port (Setup Guide)

Inputs composite video signals to the projector from other video sources.

S VIDEO port (Setup Guide)

Inputs an S-Video signal to the projector from other video sources.

Base

Front adjustable foot

Air filter (air inlet) (p.46, 50)

Prevents dust and other foreign particles from being drawn into the projector. When replacing the lamp, replace the air filter also.

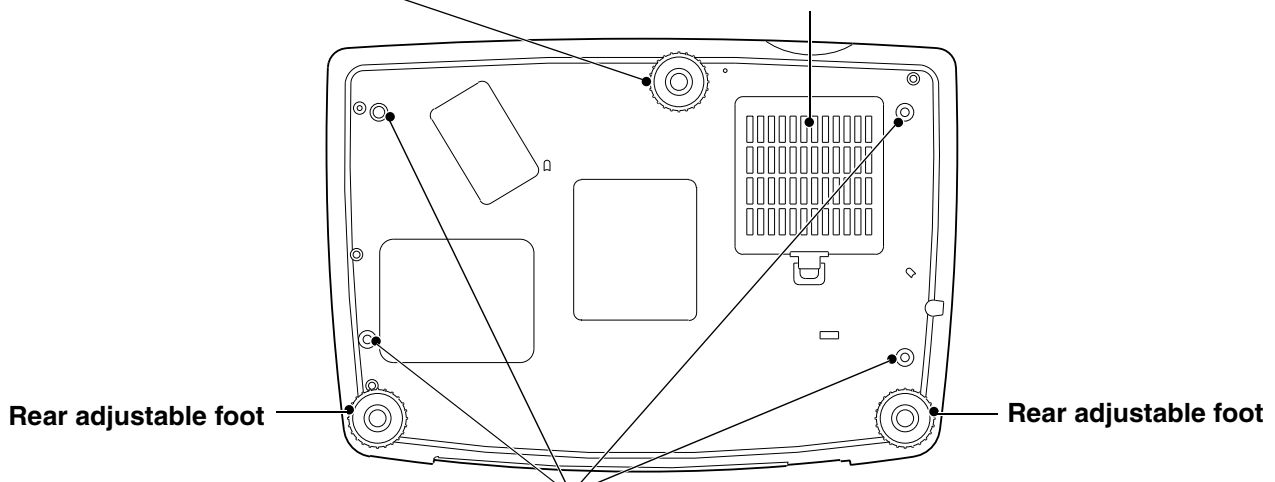

Rear adjustable foot

Rear adjustable foot

Suspension bracket fixing points (4 points) (p.51, Setup Guide)

Install the optional ceiling mount here when suspending the projector from the ceiling.

Remote Control

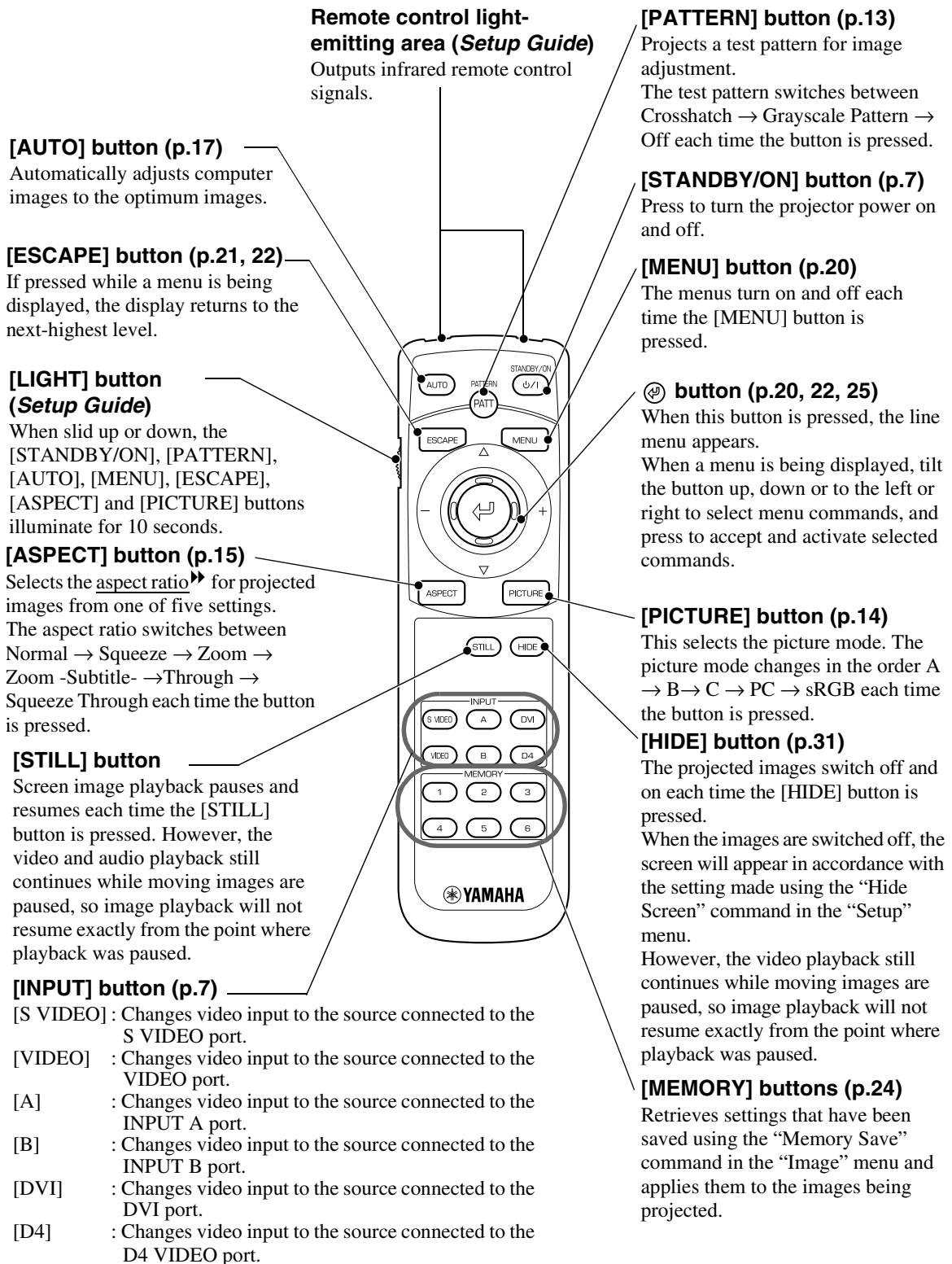

Glossary

Following is an explanation of some of the terms used in this guide which may be unfamiliar or which were not explained in the manual itself. Further information can be obtained by referring to other commercially-available publications.

3-2 pull-down detection-type IP conversion	This function directly converts image sources that have been recorded in the same 24-frame format used for movies into 60-frame progressive signals. This allows data such as DVD software that has been recorded in 24-frame format to be played back on large screens with more natural and accurate reproduction, without any loss of image quality from the original movie.
Aspect ratio	The ratio between an image's length and its height. HDTV images have an aspect ratio of 16:9 and appear elongated. The aspect ratio for standard images is 4:3.
Color difference signal (component)	A type of video signal output by video equipment which actually consists of three separate signals: a red + luminance signal (R-Y), a luminance signal (Y) and a blue + luminance signal (B-Y). Each signal is transmitted along a separate cable. Color difference signals generally result in a better image than composite signals (in which the red, green and blue signals and the luminance signal are all transmitted along a single cable).
Color temperature	The temperature of an object which is emitting light. If the color temperature is high, the colors tend to take on a bluish tinge. If the color temperature is lower, the colors tend to take on a reddish tinge.
Component video	Video signals which have the video brightness signals and color signals separated, in order to provide better image quality. In high-definition TV (HDTV), it refers to images which consist of three independent signals: Y (luminance signal), and Pb and Pr (color difference signals).
Composite video	Video signals which have the video brightness signals and color signals mixed together. The type of signals commonly used by household video equipment (NTSC format). The signals consist of the carrier signal Y (luminance signal) and the chroma (color) signal which are contained in the color signal.
Contrast	The relative brightness of the light and dark areas of an image can be increased or decreased in order to make text and graphics stand out more clearly, or to make them appear softer.
Cool-down	The cooling process for the projector lamp continues even after the [STANDBY/ON] button on either the remote control or the projector's control panel has been pressed to turn off the projector. All button operations for the remote control and the projector's control panel are disabled while the cooling fan is operating at this time. The length of time that this is happening is called the "cool-down period". The cool-down period lasts for about 5 minutes. The actual time will vary depending on the external air temperature.
DCDi function	An abbreviation for Directional Correlational Deinterlacing. Refers to a high-resolution image circuit function developed by Faroudja. It incorporates the latest in edge cutting technology to smooth the jaggedness from the edges of images that have been converted from interlaced to progressive video, in order to provide more natural images.
DVI	Abbreviation for Digital Visual Interface. Refers to a standard method for digital transmission of video signals. DVI is a standard that is also targeted towards digital household appliances other than computers.
Film judgment function	This function determines whether or not the video source is a 24 Hz progressive film source.
Gain	The adjustment of minute changes in color that occur as result of factors such as differences in the equipment used to display images. It adjusts the coloration in brighter ranges separately for R, G and B components.
Gamma	The adjustment of minute changes in color that occur as result of factors such as differences in the equipment used to display images. It adjusts the coloration in intermediate ranges separately for R, G and B components.
HDTV	An abbreviation for High-Definition Television. It refers to high-definition systems which satisfy the following conditions. <ul style="list-style-type: none"> • It may also include vertical resolutions of 720p or 1080i or above (p = progressive scanning; i = interlaced scanning) or 480p. • Screen aspect ratio of 16:9 • Dolby Digital audio reception and playback (or output)

Interlaced	A method of image scanning whereby the lines in a single image are divided into two sections or "fields". The signal bandwidth used for interlaced scanning is approximately half that required for progressive scanning when images with the same still picture resolution are broadcast.
Offset	The adjustment of minute changes in color that occur as result of factors such as differences in the equipment used to display images. It adjusts the coloration in darker ranges separately for R, G and B components.
Refresh Rate	The light-emitting element of a display maintains the same luminosity and color for an extremely short time. Because of this, the image must be scanned many times per second in order to refresh the light emitting element. The number of refresh operations per second is called the "refresh rate", and is expressed in hertz (Hz).
S-Video images	A video signal which has the luminance component and color component separated in order to provide better image quality. It refers to images which consist of two independent signals: Y (luminance signal), and C (color signal).
SDTV	An abbreviation for Standard Definition Television. It refers to standard television systems which do not satisfy the conditions for High-Definition Television.
sRGB	An international standard for color intervals that was formulated so that colors which are reproduced by video equipment can be handled easily by computer operating systems (OS) and the Internet.
SVGA	A type of image signal with a resolution of 800 (horizontal) x 600 (vertical) dots which is used by IBM PC/AT-compatible computers (DOS/V computers).
SXGA	A type of image signal with a resolution of 1280 (horizontal) x 1024 (vertical) dots which is used by IBM PC/AT-compatible computers (DOS/V computers).
Synchronization (Sync.)	The signals output from computers have a specific frequency. If the projector frequency does not match this frequency, the resulting images will not be of a good quality. The process of matching the phases of these signals (the relative position of the crests and troughs in the signal) is called "synchronization". If the signals are not synchronized, problems such as flickering, blurriness and horizontal interference can occur.
Tracking	The signals output from computers have a specific frequency. If the projector frequency does not match this frequency, the resulting images will not be of a good quality. The process of matching the frequency of these signals (the number of crests in the signal) is called "tracking". If tracking is not carried out correctly, wide vertical stripes will appear in the projected images.
UXGA	A type of image signal with a resolution of 1600 (horizontal) x 1200 (vertical) dots which is used by IBM PC/AT-compatible computers (DOS/V computers).
VGA	A type of image signal with a resolution of 640 (horizontal) x 480 (vertical) dots which is used by IBM PC/AT-compatible computers (DOS/V computers).
XGA	A type of image signal with a resolution of 1,024 (horizontal) x 768 (vertical) dots which is used by IBM PC/AT-compatible computers (DOS/V computers).

Index

General Terms

⏻ / | indicator 36, 58

A

Adjustment Foot 11
Appearance 56
Aspect ratio 15
Automatic Adjustment of Computer
Images 17, 60
Auto power off 32

B

Battery compartment cover (Remote
control) Setup Guide
Battery replacement period (Remote
control) Setup Guide
Black level 23, 24, 26, 28

C

Ceiling 31, 51, 59
Cleaning 46
Cleaning the air filter 46
Color 14, 24
Color Balance 24, 27, 29
Color Temp. 24, 27, 29
Component video
..... 52, 59, Setup Guide
Composite video
..... 52, 59, Setup Guide
Computer connections Setup Guide
Connectors 54, 59
Contrast 23, 41
Control panel 58
Cool-down 9, 38
Crosshatch 13

D

D4 VIDEO port 7, 59, Setup Guide
DVI port 7, 59, Setup Guide

F

Flesh Tone 24, 27, 29
Focus 14
Focus ring 14, 57
Frequency 34
Front adjustable foot 11, 57
Full menus 20, 26

G

Gain 27, 29
Gamma 27, 29
Glossary 61
Grayscale 13

H

HDTV 15, 52, 53
Hue 24, 26

I

Image menu 24, 26

Image size 11
Indicators 36, 58
Info menu 33
Input signal 33, 34
INPUT A port 7, 59
INPUT B port 7, 59
Inserting batteries (Remote control)
..... Setup Guide
Installation Setup Guide

K

Keystone correction 12, 31

L

Lamp 33, 49
Lamp cover 48, 57
LAMP/COVER indicator 36, 58
Lamp replacement 47
Lamp replacement period 47
Language 32
Lens cleaning 46
Lens cap 57

M

Main menu 20, 26
Main Power switch 6, 10, 59
Memory Save 24, 27, 29
Menus 20, 26

N

Noise reduction 24, 30
No Signal 31

O

Offset adjustment 27, 29
Operating temperature 54
Optional accessories 51
Overheating 37

P

Part Names and Functions 57
Picture mode 14, 24, 27, 28
Position 16, 17, 30
Power cord 6
Power inlet 6, 59
Progressive 24, 30
Projection angle 11

R

Rear adjustable foot 11, 59
Refresh Rate 34
Remote control 60, Setup Guide
Remote control light-receiving area
..... 57, 59, Setup Guide
Remote control light-emitting area
..... 60, Setup Guide
Replacing the air filter 50
Reset All menu 32
Reset Lamp Timer 33
Resolution 34
RGB setting 27, 29

RGB video Setup Guide

S

Saturation 24, 26
Screen size Setup Guide
SDTV 15, 52, 53
Setup Level 24, 31
Setup menu 31
Sharpness 24, 27, 29
Signal menu 24, 30
Specifications 54
Squeeze Through mode ... 15, 17, 52, 53
sRGB 14, 27, 28
Startup screen 31, 47
Storage temperature 54
Sub-menu 20, 26
Supported signal resolutions 52
S-Video 52, Setup Guide
S VIDEO port 7, 59, Setup Guide
Sync Mode 34
Sync Polarity 34
Sync. 17, 28
Synchronization 17, 28

T

TEMP/FAN indicator 36, 58
Test pattern 13
Through 15, 17, 52, 53
Tracking 17, 28
TRIGGER OUT port 59
Turning off 9

U

Using the menus 20
Using the menu functions 26

V

VIDEO port 7, 59, Setup Guide
Video Signal 30
Video Source 33
Video source connection
..... Setup Guide
V Size 16, 31
V Position 16, 31

W

White level 23, 24, 26, 28

Z

Zoom mode 15, 16, 52, 53
Zoom ring 11, 57
Zoom -Subtitle- 15, 16, 52, 53

All rights reserved. No part of this publication may be reproduced, stored in a retrieval system, or transmitted in any form or by any means, electronic, mechanical, photocopying, recording, or otherwise, without the prior written permission of YAMAHA CORPORATION. No patent liability is assumed with respect to the use of the information contained herein. Neither is any liability assumed for damages resulting from the use of the information contained herein.

Neither YAMAHA CORPORATION nor its affiliates shall be liable to the purchaser of this product or third parties for damages, losses, costs, or expenses incurred by purchaser or third parties as a result of: accident, misuse, or abuse of this product or unauthorized modifications, repairs, or alterations to this product, or (excluding the U.S.) failure to strictly comply with YAMAHA CORPORATION's operating and maintenance instructions.

YAMAHA CORPORATION shall not be liable against any damages or problems arising from the use of any options or any consumable products other than those designated as Original YAMAHA Products or YAMAHA Approved Products by YAMAHA CORPORATION.

General Notice: The following trademarks and registered trademarks are the property of their respective owners and are used in this publication for identification purposes only.

- Macintosh, PowerBook/Apple Computer Inc.
- IBM/International Business Machine Corp.
- Windows/Microsoft Corp.
- © 2001 Sage Inc. All rights reserved. DCDi is a registered trademark of the Faroudja business division of Sage Inc.

Other product names used herein are also for identification purposes only and may be trademarks of their respective owners. YAMAHA disclaims any and all rights in those marks.



YAMAHA ELECTRONICS CORPORATION, USA 6660 ORANGETHORPE AVE., BUENA PARK, CALIF. 90620, U.S.A.
YAMAHA CANADA MUSIC LTD. 135 MILNER AVE., SCARBOROUGH, ONTARIO M1S 3R1, CANADA
YAMAHA ELECTRONIK EUROPA G.m.b.H. SIEMENSSTR. 22-34, 25462 RELLINGEN BEI HAMBURG, FR. OF GERMANY
YAMAHA ELECTRONIQUE FRANCE S.A. RUE AMBROISE CROIZAT BP70 CROISSY-BEAUBOURG 77312 MARNE-LA-VALLÉE CEDEX02, FRANCE
YAMAHA ELECTRONICS (UK) LTD. YAMAHA HOUSE, 200 RICKMANSWORTH ROAD WATFORD, HERTS WD1 7JS, ENGLAND
YAMAHA SCANDINAVIA A.B. J. A WETTERGRENS GATA 1, BOX 30053, 400 43 VÄSTRA FRÖLUNDA, SWEDEN
YAMAHA MUSIC AUSTRALIA PTY, LTD. 17-33 MARKET ST., SOUTH MELBOURNE, 3205 VIC., AUSTRALIA



YAMAHA CORPORATION
Printed in Japan (English)
403256900



Home Cinema Projector

LPX-500

Setup Guide

1

Before Using the Remote Control

Inserting the Batteries

**Battery Replacement Period and
Using the Remote Control**

Remote Control Operating Range

2

Setup

Screen Size and Setting-up Distance

Setting-up Methods

3

Connecting to a Video Source

4

Connecting to a Computer

Inserting the Batteries

The batteries are not inserted into the remote control at the time of purchase, so you need to insert them before the remote control can be used.

1

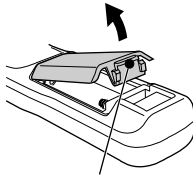

Remove the battery compartment cover.

While pressing the cover here, lift the cover up.

2

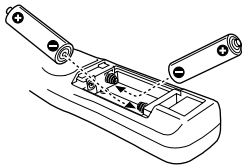

Insert the batteries.

Make sure the polarities of the batteries are correct.

3

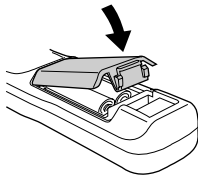

Replace the battery compartment cover.

After inserting the tab of the battery cover, push the cover down until it clicks into place.

Battery Replacement Period and Using the Remote Control

Battery Replacement Period

If the remote control becomes slow in responding or if it stops working, the batteries may be spent. If this happens, replace the batteries with fresh ones.

Guide for battery replacement: Approximately 3 months if used for 30 minutes per day

* The replacement period given above may vary depending on the amount of usage and the ambient conditions.

Use the following type of batteries as replacements.

Battery LR6 (AA) x 2

Using the Remote Control

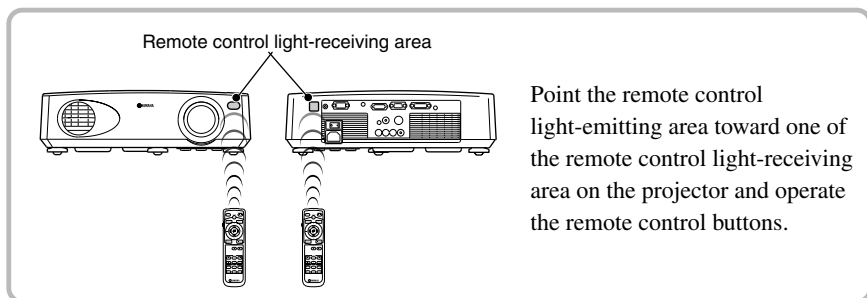

Do not allow sunlight or light from fluorescent lamps to shine directly onto the projector's remote control light-receiving area, otherwise it may interfere with the reception of signals from the remote control.

[LIGHT] (illumination) button

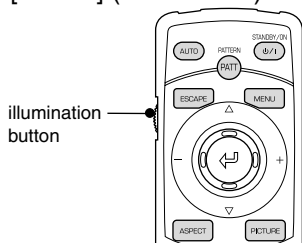

When the [LIGHT] button is pressed, the buttons shown in colour in the illustration at left are illuminated for 10 seconds. If you press the [LIGHT] button again during this 10-second period, the illumination continues for another 10 seconds.

Remote Control Operating Range

Use the remote control within the ranges indicated below. If the distance or angle between the remote control and the remote control light-receiving area is outside the normal operating range, the remote control may not work.

Operating distance	Operating angle
Approx. 7 m (23 ft)	Approx. 30° vertically and horizontally

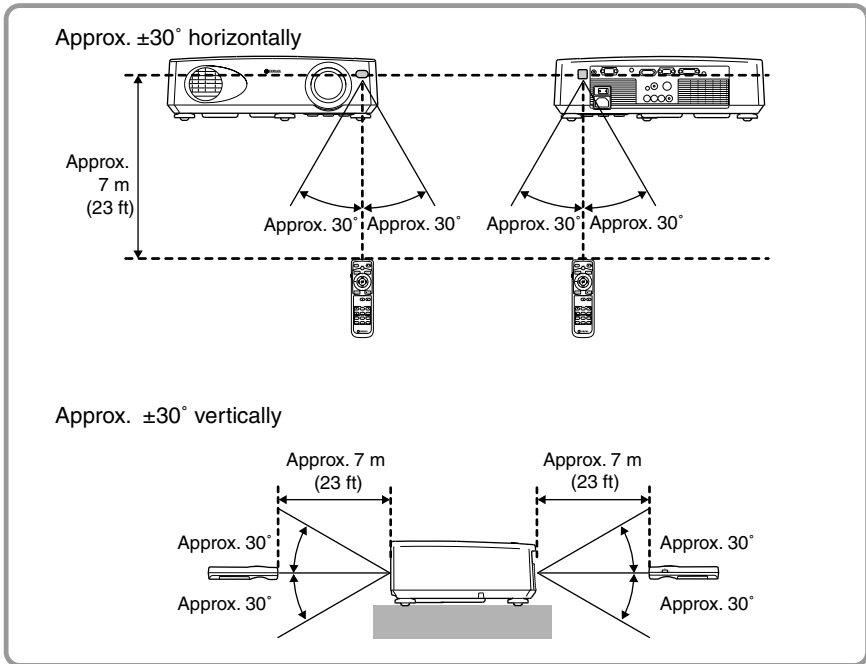

Screen Size and Setting-up Distance

The distance between the projector and the screen (16:9) determines the actual image size.

Recommended distance : 0.9m - 13.0m (2.9 - 42.6 feet)

While referring to the table below, position the projector so that the image size is smaller than the screen size.

Screen size (cm (feet))	Approximate projection distance* (m (feet))	Distance in Fig. A below (cm (feet))
80" (177 × 100 (5.8 × 3.2))	2.5 – 3.4 (8.2 – 11.1)	13.6 – 13.7 (0.44 – 0.45)
90" (200 × 112 (6.5 × 3.6))	2.8 – 3.9 (9.1 – 12.7)	15.3 – 15.4 (0.50 – 0.51)
100" (220 × 125 (7.2 × 4.1))	3.1 – 4.3 (10.1 – 14.1)	17.0 – 17.2 (0.55 – 0.56)
110" (243 × 137 (7.9 × 4.4))	3.5 – 4.7 (11.4 – 15.4)	18.7 – 18.9 (0.61 – 0.62)
120" (266 × 150 (8.7 × 4.9))	3.8 – 5.1 (12.4 – 16.7)	20.4 – 20.6 (0.67 – 0.68)
150" (332 × 187 (10.8 × 6.1))	4.8 – 6.5 (15.7 – 21.3)	25.5 – 25.7 (0.83 – 0.84)
200" (442 × 250 (14.4 × 8.2))	6.4 – 8.7 (20.9 – 28.5)	34.0 – 34.3 (1.11 – 1.12)

* Distance and dimensions should be used as a guide for installation. The actual distance will vary depending on projection conditions.

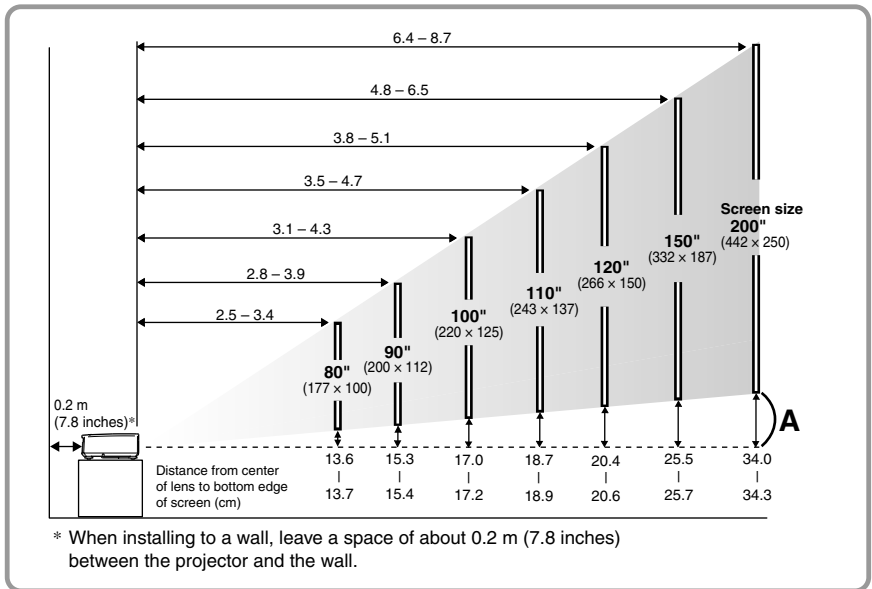

- The projector's lens allows a zoom ratio of up to about 1.35. The image size at the maximum zoom setting is about 1.35 times bigger than the image size at the minimum zoom setting.
- The image size will be reduced when keystone correction is carried out.

Setting-up Methods

The projector supports the following 4 projection methods, allowing you to choose the best method for displaying your images.

After setting up the projector, refer to the *OWNER'S MANUAL* for details on turning on the power and adjusting settings such as the screen size. ("Basic Operations" in *OWNER'S MANUAL*)



Be sure to read "Caution" in *OWNER'S MANUAL* for details on safe handling when setting up the projector.

Front projection

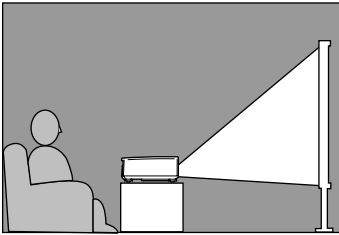

Front/ceiling projection

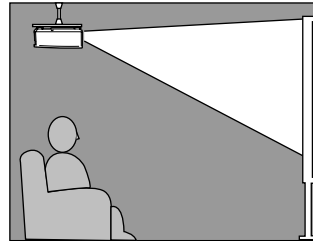

Rear projection using a translucent screen

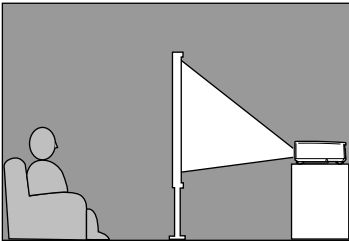

Rear projection onto a translucent screen with the projector installed to the ceiling

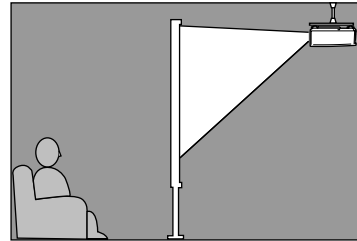

* When installing to the ceiling or projecting from behind the screen, set the "Installation" command in the "Setup" menu to match the method of projection being used. ("Setup" menu in *OWNER'S MANUAL*)



A special method of installation is required in order to suspend the projector from the ceiling. Please contact the place of purchase if you would like to use this installation method.



- Turn off the power for both the projector and the video source before connecting them. If the power for either device is on at the time of connection, damage may result.
- Check the shapes of the cable connectors and the device ports before making the connections. If you try to force a connector to fit a device port with a different shape or number of terminals, a malfunction or damage to the connector or port may result.

Projecting Component Video Images

If connecting to the INPUT A port

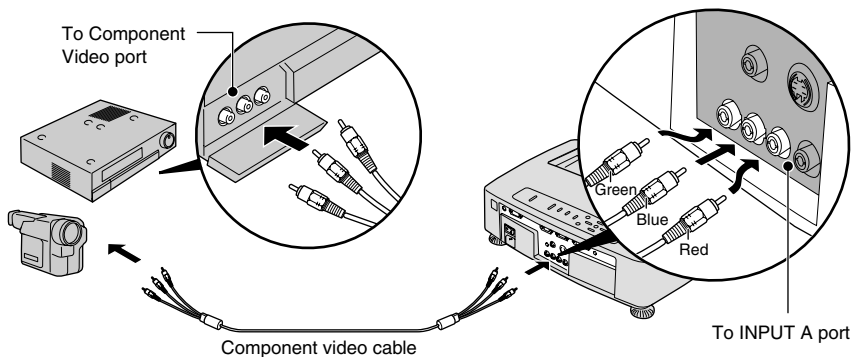

If connecting to the INPUT B port

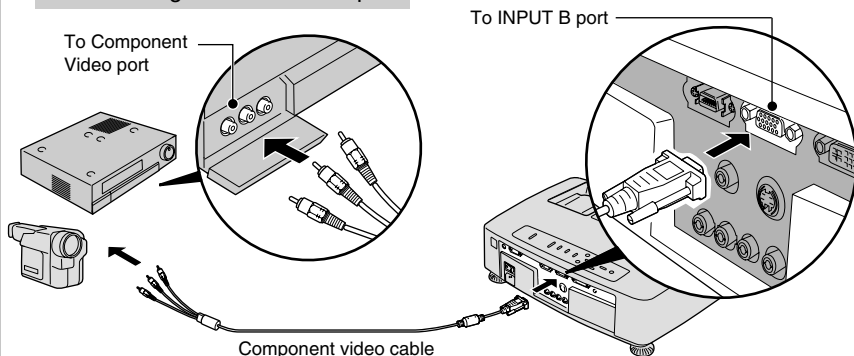

- If more than one peripheral device is being connected to the projector, make the connections and then change the "INPUT A Signal" or "INPUT B Signal" commands in the "Signal" menu to "Component" to match the signals from these devices. ("Signal" menu in *OWNER'S MANUAL*)
- If video signals are being input to several input ports simultaneously, interference between the various signals may occur, and this may cause interference in the projected images. If this happens, turn off the power supply or disconnect the video equipment which is not currently being used.

Projecting Composite Video Images

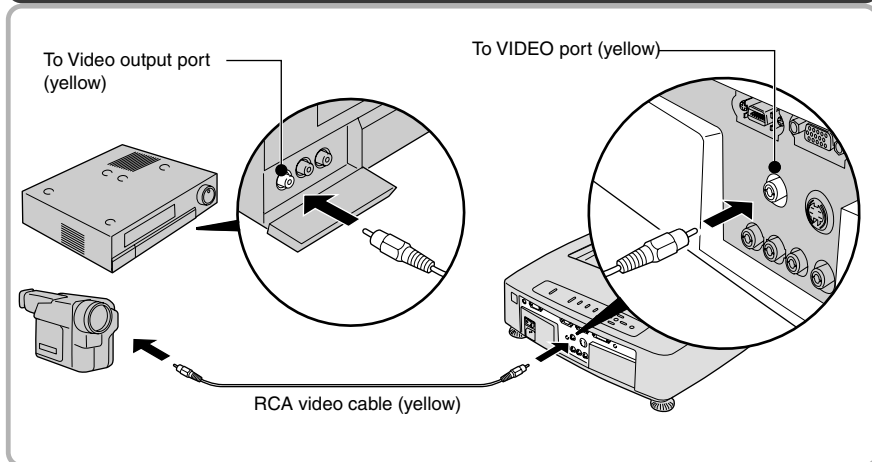

Projecting S-Video Images

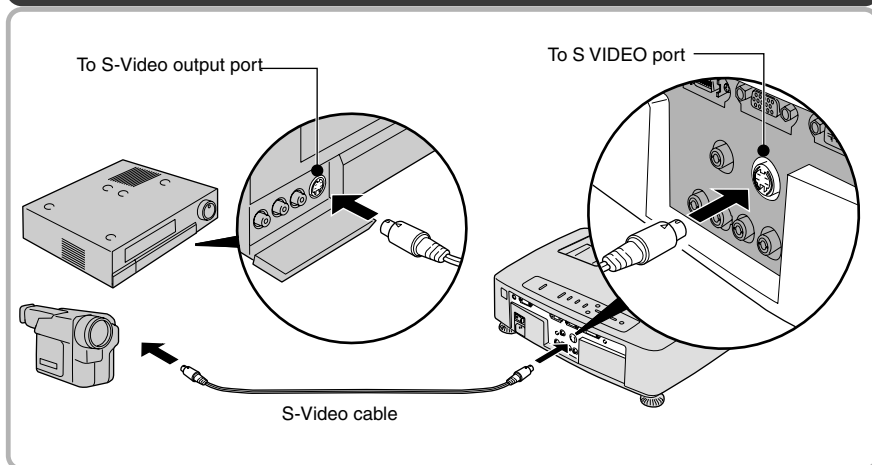

Depending on the combination of the VCR and the video cassette used for the playback, the color of the projected images may flicker or the correct color may not be displayed. In this case, select "Signal" and set "Progressive" to OFF for improving the playback quality. ("Signal" menu in *OWNER'S MANUAL*)

Projecting RGB Video Images

If connecting to the INPUT A port

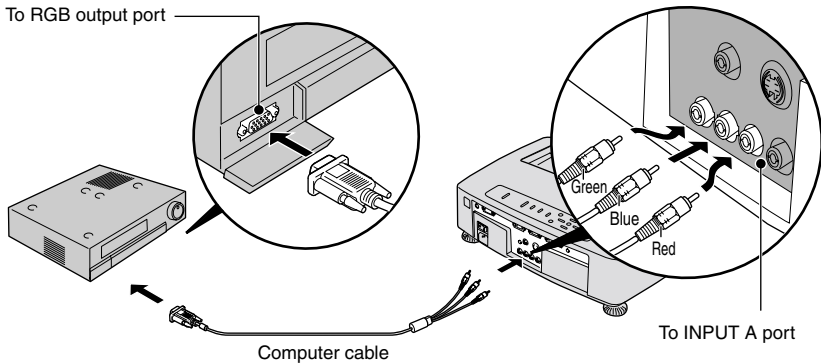

If connecting to the INPUT B port

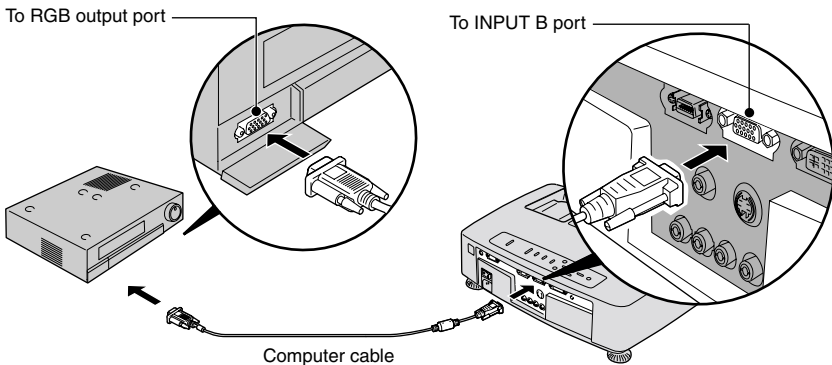

If more than one peripheral device is being connected to the projector, make the connections and then change the "INPUT A Signal" or "INPUT B Signal" commands in the "Signal" menu to "RGB" to match the signals from these devices.

("Signal" menu in *OWNER'S MANUAL*)



- Turn off the power for both the projector and the computer before connecting them. If the power for either device is on at the time of connection, damage may result.
- Check the shapes of the cable connectors and the device ports before making the connections. If you try to force a connector to fit a device port with a different shape or number of terminals, damage to the connector or port may result.

The projector cannot be connected to some types of computer, or projection of images may not be possible even if actual connection is possible. Make sure that the computer you intend to use satisfies the conditions given below.

Condition 1: The computer must have a image signal output port.

Check that the computer has a port such as an RGB port, monitor port or video port which can output image signals. If the computer has a built-in monitor, or if using a laptop computer, it may not be possible to connect the computer to the projector, or alternatively you may need to purchase a separate external output port. Refer to the *OWNER'S MANUAL* for your computer under a heading such as "Connecting an external monitor" or similar for further details.

Condition 2: The display resolution and frequency of the computer must be listed in the "List of Supported Signal Resolutions".

Some computers may have functions for changing the output resolution. Refer to the *OWNER'S MANUAL* for the computer and change the setting to within a range given in the list of supported resolutions.



- You may need to purchase a separate adapter to connect the computer to the projector, depending on the shape of the computer's monitor port. Refer to the *OWNER'S MANUAL* for the computer for details.
- The optional Mac Adapter Set is required in order to connect the projector to a Macintosh computer.

If connecting using a computer cable

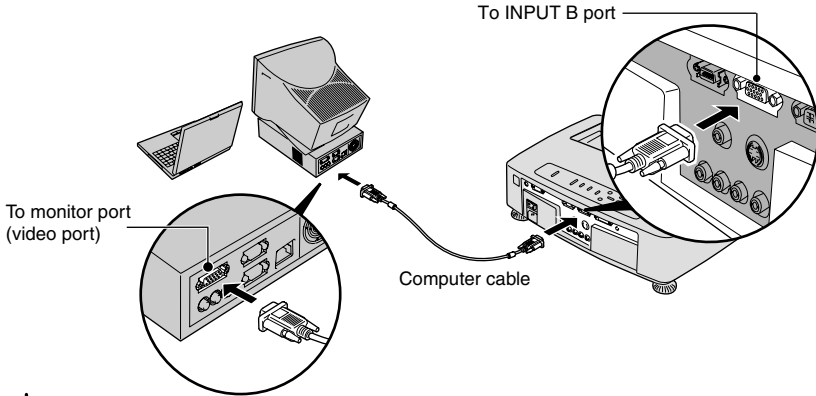

- If connecting more than one projector together, make the connection and then use the menus to change the "INPUT B Signal" setting in the "Signal" menu to "RGB". ("Signal" menu in *OWNER'S MANUAL*)
- If video signals are being input to several input ports simultaneously, interference between the various signals may occur, and this may cause interference in the projected images. If this happens, turn off the power supply or disconnect the video equipment which is not currently being used.

If the computer is equipped with a DVI-D output port

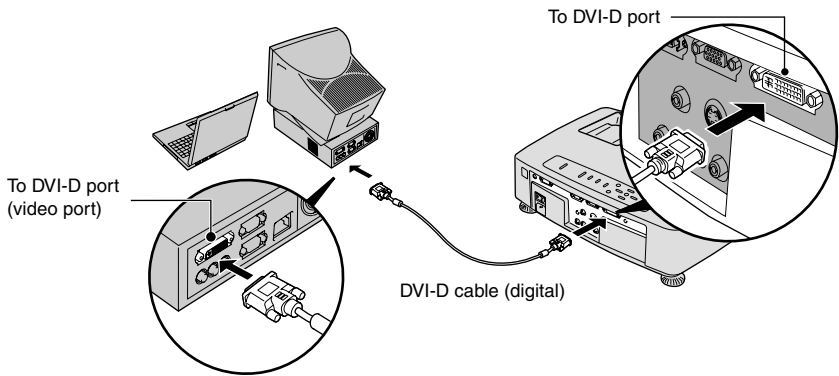

- Do not bind the power cord together with the computer cable or DVI-D cable (digital), otherwise it may cause interference in the projected images or operating errors.
- Two kinds of DVI cable are available. Use a DVI-D cable to connect to this projector.