



**LG**

Life's Good

OWNER'S MANUAL

# Laser Display

Please read the safety information carefully before using the product.

HECTO

**ProSelecta**

View :: Compare :: Select - [www.ProSelecta.com](http://www.ProSelecta.com)

# LICENSE



Manufactured under license from Dolby Laboratories. "Dolby" and the double-D symbol are trademarks of Dolby Laboratories.



ABOUT DIVX VIDEO: DivX® is a digital video format created by DivX, LLC, a subsidiary of Rovi Corporation. This is an official DivX Certified® device that plays DivX video. Visit [divx.com](http://divx.com) for more information and software tools to convert your files into DivX videos.

ABOUT DIVX VIDEO-ON-DEMAND: This DivX Certified® device must be registered in order to play purchased DivX Video-on-Demand (VOD) movies. To obtain your registration code, locate the DivX VOD section in your device setup menu. Go to [vod.divx.com](http://vod.divx.com) for more information on how to complete your registration.

DivX Certified® to play DivX® video up to HD 1080p, including premium content.

DivX®, DivX Certified® and associated logos are trademarks of Rovi Corporation or its subsidiaries and are used under license. Covered by one or more of the following U.S. patents: 7,295,673; 7,460,668; 7,515,710; 7,519,274



The terms HDMI and HDMI High-Definition Multimedia Interface, and the HDMI logo are trademarks or registered trademarks of HDMI Licensing LLC in the United States and other countries.



Manufactured under license under U.S. Patent Nos: 5,956,674; 5,974,380; 6,487,535 & other U.S. and worldwide patents issued & pending. DTS, the Symbol, & DTS and the Symbol together are registered trademarks & DTS 2.0 Channel is a trademark of DTS, Inc. Product includes software. © DTS, Inc. All Rights Reserved.

This device meets the EMC requirements for home appliances (Class B) and is intended for home usage. This device can be used in all regions.

## NOTE

- The product images and On-Screen Display (OSD) in this manual are examples to help you understand how to operate the product, so they may be different from the actual Laser Display.

# SAFETY INSTRUCTIONS

Please take note of the safety instructions to prevent any potential accident or misuse of the Laser Display.

Safety precautions are given in two forms, i.e. Warning and Caution as detailed below.

**⚠ WARNING:** Failure to follow the instructions may cause serious injury and even death.

**⚠ CAUTION:** Failure to follow the instructions may cause injury to persons or damage to the product.

Read the owner's manual carefully and keep it to hand.





**WARNING/CAUTION**

**RISK OF ELECTRIC SHOCK  
DO NOT OPEN**



TO REDUCE THE RISK OF ELECTRIC SHOCK DO NOT REMOVE COVER (OR BACK). NO USER SERVICEABLE PARTS INSIDE. REFER TO QUALIFIED SERVICE PERSONNEL.

 The lightning flash with arrowhead symbol, within an equilateral triangle, is intended to alert the user to the presence of uninsulated “dangerous voltage” within the product’s enclosure that may be of sufficient magnitude to constitute a risk of electric shock to persons.

 The exclamation point within an equilateral triangle is intended to alert the user to the presence of important operating and maintenance (servicing) instructions in the literature accompanying the appliance.

## WARNING/CAUTION

- TO REDUCE THE RISK OF FIRE AND ELECTRIC SHOCK, DO NOT EXPOSE THIS PRODUCT TO RAIN OR MOISTURE.

Read these instructions.

Keep these instructions.

Heed all warnings.

Follow all instructions.

## **Indoor Installation**

### **⚠ WARNING**

- Do not place the product in direct sunlight or near heat sources such as radiators, fires, stoves, etc.
  - This may cause fire.
- Do not place inflammables such as flammable spray near the product.
  - This may cause fire.
- Do not allow children to cling to or climb up to the product.
  - This may cause the product to fall, causing injury or death.
- Do not place the product directly on a carpet, rug or place where ventilation is restricted such as a book shelf or closet.
  - This may cause the product's internal temperature to rise and cause fire.
- Do not place the product close to sources of steam or oil such as a humidifier or kitchen counter.
  - This may cause fire or electric shock.
- Do not place the product where it might be exposed to dust.
  - This may cause fire.
- Do not use the product in a damp place, such as a bathroom or a place exposed to the wind and rain, where it is likely to get wet.
  - This may cause fire or electric shock.
- Do not allow a tablecloth or curtain to block the vents.
  - This may cause the internal temperature of the product to rise and cause fire.
- The distance between the air vent of the product and the wall should be more than 30 cm for ventilation purposes.
  - Otherwise, this may cause the internal temperature of the product to rise and cause fire.
- When installing the product on a ceiling, a professional technician should install it using the authorized tools. If installed improperly, the product may fall.
  - This may cause personal injury or property damage. For installation of the product, please contact the customer support center.
- If you use a ceiling mounting device, use adhesive to prevent loosening of screws, or apply oil or lubricant to the product, this may cause the case to crack and the product to fall.
- This may also cause serious personal injury to the person below the device (if any) and damage to the product as well.

**⚠ CAUTION**

- When installing the product on a table or shelf, be careful not to place it near the edge.
  - This may fall causing injury to persons or the product malfunction. Make sure that you use the cabinet or stand that fits the product.
- Turn off the product, disconnect it from the power supply and all connected apparatus before moving it.
  - Otherwise, the power cord may be damaged causing fire or electric shock.
- Do not place the product on an unstable or vibrating surface such as a wobbly shelf or a slope.
  - It may fall or flip and cause injury.
- Be careful not to tip or drop the product over when connecting external devices to the product.
  - This may cause injury to persons or damage to the product.

**Power****⚠ WARNING**

- The grounding wire should be connected.
  - Be sure to connect the grounding wire to avoid damage to the product or an electric shock when there is a short circuit.
- If it is not possible to ground the unit, purchase a circuit breaker and connect the product to its wall outlet.
- Do not try to ground the product to the gas pipe, water pipe, lightning rod, or telephone line, etc.
- The power plug should be inserted fully into the power outlet.
  - An unstable connection may cause fire.
- Do not place heavy objects on the power cord.
  - This may cause fire or electric shock.
- Never touch the power plug with a wet hand.
  - This may cause electric shock.
- Do not plug too many devices into one multi-power outlet.
  - This may cause fire due to the power outlet overheating.
- Remove dust or contaminants around power plug pins or wall outlets.
  - Failure to do so may cause fire.
- To turn off the main power, remove the power plug, which should be positioned so it is easy to access for operation.

**⚠ CAUTION**

- Hold the plug firmly when unplugging.
  - A broken wire in the cord may cause fire.
- Ensure the power cord and plug are not damaged, modified, severely bent, twisted, pulled, sandwiched or hot. Do not use the product if the power outlet is loose.
  - This may cause fire or electric shock.
- Keep the power cord away from any heating devices.
  - The cord coating may melt and cause fire or electric shock.
- Place the product where people will not trip over or tread on the power cord to protect the power cord and plug from any damage.
  - This may cause fire or electric shock.
- Do not turn the product on or off by plugging in the power plug or unplugging it from the wall outlet. (Do not use the power plug as a switch.)
  - This may cause electric shock or product malfunction.
- Do not insert a conductor into the other side of the wall outlet while the power plug is inserted into the wall outlet.
- In addition, do not touch the power plug immediately after it is disconnected from the wall outlet.
  - This may cause electric shock.
- Only use the official power cord provided by LG Electronics. Do not use other power cords.
  - This may cause fire or electric shock.

**When in Use****⚠ WARNING**

- Do not place anything containing liquid on top of the product, such as a vase, flower pot, cup, cosmetics, or medicine; or ornaments, candles, etc.
  - This may cause fire or electric shock, or injury due to falling.
- In the event that there is a heavy impact on the product or the cabinet is damaged, switch it off, unplug it from the power outlet and contact an authorized service center.
  - Failure to do so may cause fire or electric shock.
- Do not insert pieces of metal, such as coins, hairpins or metal debris, or flammable materials, such as paper or matches, into the product.
  - This may cause fire or electric shock.
- In the event that liquid or a foreign object falls into the product, switch it off and unplug it from the power outlet and contact our service center.
  - Failure to do so may cause fire or electric shock.
- Make sure that a child does not swallow the batteries when you replace the old remote control batteries with new ones. Keep batteries out of reach of children.
  - If a child swallows a battery, consult a doctor immediately.
- Do not look directly into the lens when the product is in use. The strong light may damage your eyes.
- When the product is on or has just been turned off, avoid touching the air vent because it will be very hot.
- If there is a gas leak, do not touch the wall outlet. Open the window for ventilation.
  - A spark may cause a fire or burn.

- Never touch the product or power cord during thunder or lightning.
  - This may cause electric shock.
- Do not use the product near electronic devices that generate a strong magnetic field.
- Do not wear the plastic package used to pack the product around your head.
  - This may cause suffocation.
- Do not touch the product with your hand for a long time when it is running.
- When you play a game by connecting a game console to a product, it is recommended that you maintain a distance of more than 1.5 times the diagonal length of the screen.
- Make sure that the length of connecting cable is long enough.
  - Otherwise, the product may fall causing personal injury or damage to the product.

**⚠ CAUTION**

- Do not place a heavy object on the product.
  - It may fall down and cause physical injury.
- Be careful to protect the lens from heavy impact during transportation.
- Do not touch the cover glass of the product.
- Otherwise, the cover glass may be damaged.
- Do not use any sharp tools on the product, such as a knife or hammer, because this may damage the casing.
- In the event that no image appears on the screen or no sound is heard, stop using the product. Switch off the product, unplug it from the power outlet and contact our service center. Failure to do so may cause fire or electric shock.
- Do not drop anything onto the product or apply heavy pressure to it.
  - This may cause injury to persons or the product malfunction.
- It is recommended that you maintain a distance of more than 1.5 - 3 times the diagonal length of the screen between your eyes and the screen.
  - If you watch the screen at a close distance for a long time, your eyesight may become worse.
- When closing the door of the product, be careful not to jam your finger.
  - This may cause injury to persons or the product malfunction.

- Do not block the light emitted from the product's lens with a book or a cover. Long exposure to the light may melt or burn the object, possibly causing fire. In addition, the lens may be overheated and the product may be damaged by the reflected light. Stop projecting temporarily or turn off the power.
- Do not start the product with volume high.
  - High volume may damage hearing. Be sure to lower the volume before turning off the product. Raise the volume gradually after turning on the product.
- When you go out, place the product out of reach of pets or other animals, and unplug it from the wall outlet.
  - Otherwise, it may cause short circuit and fire.

## **Cleaning**

### **⚠ WARNING**

- Do not spray water directly to the product when cleaning. Do not allow water to get into the product or do not allow it to get wet.
  - This may cause fire or electric shock.
- In the event that smoke or a strange smell comes out from the product or a foreign object falls into the product, stop using it. Switch off the product, unplug it from the power outlet and contact our service center.
  - Otherwise, this may cause fire or electric shock.
- To remove dust or stains on the cover glass, use an air spray or use a swab or soft cloth to wipe the glass gently.

### **⚠ CAUTION**

- Contact your seller or our service center once a year to clean the internal parts of the product.
  - If you do not clean the Laser Display for a long period of time, dust will accumulate, which may cause fire or damage to the product.
- When cleaning plastic parts, such as the product case, unplug the power first and wipe with a soft cloth. Do not spray with water or wipe with a wet cloth. When cleaning the plastic parts, such as the product case, do not use cleanser, automobile or industrial shiner, abrasive or wax, benzene, alcohol, etc., which can damage the product.
  - This can cause fire, electric shock or product damage (deformation, corrosion and damage).



## Others

### WARNING

- Only a qualified technician can disassemble or modify the product. For inspection, adjustment, or repair, contact your seller or our service center.
  - Otherwise, this may cause fire or electric shock.

### CAUTION

- Make sure you use the same type of new battery for replacement.
- Do not mix new batteries with old ones.
  - Burst or leaking batteries may cause fire or electric shock.
- Unplug the power cord if the product is not used for a long period.
  - Accumulated dust may cause electric shock due to overheating, ignition, or poor insulation, or fire due to a short circuit.
- Do not charge the battery using any devices other than the one provided with the product.
  - This may cause damage to the battery or fire.
- Dispose of the used battery properly.
  - Failure to do so may cause explosion or fire. The correct method of disposal may vary depending on your country or region. Dispose of the battery pack according to the appropriate instructions.
- Do not throw or disassemble the battery.
  - This may cause fire or explosion due to damage to the battery.
- Always use batteries approved and certified by LG Electronics. Failure to do so may cause fire or explosion.
- Store the battery away from metallic objects, such as keys and paper clips.
  - Excess current may cause a rapid increase in temperature, resulting in damage to battery, fire or burns.
- Do not store the battery near any heat source, such as a heater. This may cause fire or product malfunction.
- Do not store it at temperatures higher than 60°C or in high humidity.
  - This may cause explosion or fire.
- Keep the battery out of reach of children.
  - Failure to do so may cause personal injury or product malfunction.
- Make sure that the battery is installed correctly. Failure to do so may cause explosion or fire.
- The battery contains lithium-ion, so it must be handled with care.
  - Failure to do so may cause explosion or fire.

## **Eye Care Sensor**

### **⚠ WARNING**

- Do not poke the sensor with a sharp object.
  - This can damage the sensor and cause it to malfunction.

## **Laser**

### **⚠ WARNING**

- This product contains a laser module. Do not disassemble or modify the product as this could be dangerous.
- You risk being exposed to laser radiation if you manipulate or alter the product in a way not specified in the user manual.
- To protect your eyes avoid looking directly into the bright light from the unit.
- Please kindly take a 5W 440 - 460nm Laser protective goggles when you need direct access the Light, and do not use sun glasses for the eye protection.

### **⚠ CAUTION**

- Use of controls or adjustments or performance of procedures other than those specified herein may result in hazardous radiation exposure.
- This product is a class 2 laser device that meets IEC 60825-1.

**Laser Display standard: class 2 laser product**

**Wavelength: 446 nm**

**Wave source : Approximately 0.2 mW**

**Light output: < 24.5 mW**

**Radiation angle: 66 °**

**Built-in laser standard:**

**Class 4 laser module**

**Wavelength: 435 nm - 455 nm**

**Light output: approx. 1.6 W x 36**

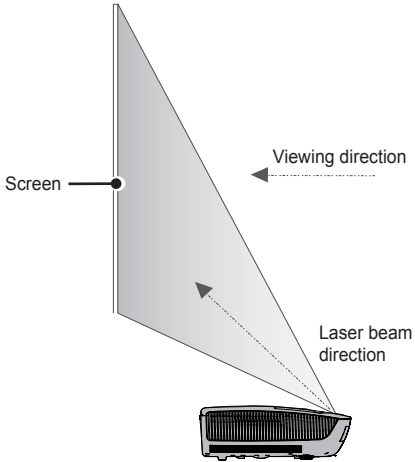

### LASER RADIATION

DO NOT STARE INTO BEAM  
CLASS 2 LASER PRODUCT

- This Laser Display is a Risk Group 2 device that meets safety standard IEC 62471 standard.

Risk Group 2

**CAUTION. Possibly hazardous optical radiation emitted from this product. Do not stare at operating lamp. May be harmful to the eye.**

The label of Laser Display is attached to the top of the product.

### Laser Display Label

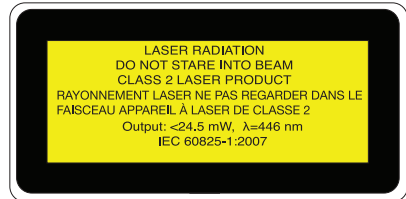

Laser warning symbol and danger symbol

**FCC NOTICE****Federal Communications Commission (FCC) Statement**

You are cautioned that changes or modifications not expressly approved by the part responsible for compliance could void the user's authority to operate the equipment.

This equipment has been tested and found to comply with the limits for a Class B digital device, pursuant to part 15 of the FCC rules. These limits are designed to provide reasonable protection against harmful interference in a residential installation. This equipment generates, uses and can radiate radio frequency energy and, if not installed and used in accordance with the instructions, may cause harmful interference to radio communications. However, there is no guarantee that interference will not occur in a particular installation. If this equipment does cause harmful interference to radio or television reception, which can be determined by turning the equipment off and on, the user is encouraged to try to correct the interference by one or more of the following measures:

- Reorient or relocate the receiving antenna.
- Increase the separation between the equipment and receiver.
- Connect the equipment into an outlet on a circuit different from that to which the receiver is connected.
- Consult the dealer or an experienced radio/TV technician for help.

1) this device may not cause harmful interference, and 2) this device must accept any interference received, including interference that may cause undesired operation of the device of the device.

**FCC Caution**

Any changes or modifications not expressly approved by the party responsible for compliance could void the user's authority to operate this equipment and For indoor use only, use outdoors or in other modes not covered by this manual may violate the FCC regulation and violate the user authority to use the product. Specially, within the 5.15-5.25 GHz band, U-NII device is restricted to indoor operations to reduce any potential for harmful interference to co-channel MSS operations.

**FCC RF Radiation Exposure Statement:**

This equipment complies with FCC radiation exposure limits set forth for an uncontrolled environment. End users must follow the specific operating instructions for satisfying RF exposure compliance.

**Disposal of your old appliance**

1. When this crossed-out wheeled bin symbol is attached to a product it means the product is covered by the European Directive 2002/96/EC.
2. All electrical and electronic products should be disposed of separately from the municipal waste stream through designated collection facilities appointed by your government or your local authorities.
3. The correct disposal of your old appliance will help prevent potential negative consequences for the environment and human health.
4. For more detailed information about disposal of your old appliance, please contact your city office, waste disposal service or the shop where you purchased the product.

**Disposal of waste****batteries/accumulators**

1. When this crossed-out wheeled bin symbol is attached to batteries/accumulators of Your product it means they are covered by European Directive 2006/66/EC.
2. This symbol may be combined with chemical symbols for mercury(Hg), cadmium(Cd) or lead(Pb) if the battery Contains more that 0.0005 % of mercury, 0.002 % of cadmium or 0.004 % of lead.
3. All batteries/accumulators should be disposed separately from the municipal waste stream via designated collection facilities appointed by the government or the local authorities.
4. The correct disposal of Your old batteries/accumulators will help to prevent potential negative consequences for the environment, animal and human health.
5. For more detailed information about disposal of Your old batteries/accumulators, please contact Your city office, waste disposal service or the shop where You purchased the product.

# Table of contents

<b>LICENSE</b>	<b>2</b>	<b>SETTING UP THE LASER DISPLAY</b>	<b>28</b>
<b>SAFETY INSTRUCTIONS</b>	<b>3</b>	<b>Setting Up the Laser Display</b>	<b>28</b>
- Indoor Installation	4	- Initial Setup	28
- Power	5	- Watching Laser Display	30
- When in Use	6	<b>Additional Options</b>	<b>31</b>
- Cleaning	8	- Adjusting the Aspect Ratio	31
- Others	9	- Using the Edge Adj Function	32
- Eye Care Sensor	10	- Using the Input List	32
- Laser	10	<b>To use SIMPLINK</b>	<b>33</b>
<b>PREPARATION</b>	<b>16</b>	<b>Explanation on SIMPLINK features</b>	<b>34</b>
<b>Accessories</b>	<b>16</b>	<b>Using the Quick Menu</b>	<b>34</b>
<b>Optional Accessories</b>	<b>17</b>	<b>NETWORK FEATURES</b>	<b>35</b>
<b>Accessories Shipped with Product</b>	<b>17</b>	<b>NETWORK Settings</b>	<b>35</b>
<b>Parts and Components</b>	<b>18</b>	- One-Click Network Connection	35
- Front	18	- Expert Settings for Network Connection	35
- Back	19	- Wireless Network Connection	36
<b>Status Indicator</b>	<b>20</b>	- Wireless Network Setup	36
<b>Installation</b>	<b>21</b>	- Tips for Network Setup	37
- Installation Precautions	21	<b>Using the Wi-Fi Screen Share Function</b>	<b>38</b>
- Projection Distance per Screen Size	22	- Connecting the Wi-Fi Direct	38
- Kensington Security System	23	<b>Using WiDi</b>	<b>38</b>
<b>REMOTE CONTROL</b>	<b>24</b>	- WiDi Setup (Wireless Display)	38
<b>MAGIC REMOTE CONTROL</b>	<b>26</b>	<b>SMARTSHARE™</b>	<b>39</b>
- Pairing the Magic Remote Control	27	<b>Before Using</b>	<b>39</b>
- Re-pairing the Magic Remote Control	27	- Connecting a USB Device	39
- Using the Magic Remote Control	27	- Removing a USB Device	39
		- Connecting DLNA	41
		<b>Using SmartShare™</b>	<b>43</b>
		- Watching the Videos	44
		- Viewing the Photos	47
		- Listening to Music	48
		<b>Using the Magical Mirroring Function</b>	<b>49</b>
		<b>Running Magical Mirroring</b>	<b>49</b>
		- MirrorOp Sender	52

---

**CUSTOMIZING SETTINGS 55**

<b>Settings</b>	<b>55</b>
<b>PICTURE Settings</b>	<b>56</b>
<b>SOUND Settings</b>	<b>60</b>
<b>TIME Settings</b>	<b>62</b>
<b>OPTION Settings</b>	<b>63</b>
<b>NETWORK Settings</b>	<b>66</b>

**CONNECTING EXTERNAL DEVICES 68**

<b>Connecting an HD Receiver, DVD Player, or VCR</b>	<b>69</b>
- HDMI connection	69
- HDMI to DVI Connection	70
<b>Connecting a PC</b>	<b>70</b>
- RGB Connection	70
- HDMI to DVI Connection	71
- RGB to DVI Connection	71
<b>Connecting External Devices</b>	<b>72</b>
- AV Connection	72
<b>Component Connection</b>	<b>72</b>
<b>Connecting Headphones</b>	<b>73</b>
- Headphone Connection	73
<b>Connecting a Laptop</b>	<b>73</b>
- RGB Connection	73
- HDMI connection	74
<b>Using the TRIGGER Port</b>	<b>75</b>
- Motor screen connection	75

**SERIAL COMMUNICATION FUNCTION 76**

<b>Using Serial Communication</b>	<b>76</b>
<b>Establishing Serial Communication</b>	<b>76</b>
<b>Communication Protocol</b>	<b>77</b>

**MAINTENANCE 85**

<b>Cleaning</b>	<b>85</b>
- Cleaning Cover Glass	85
- Cleaning the Laser Display Case	85
<b>Updating the Software</b>	<b>86</b>

**SPECIFICATIONS 87**

---

# PREPARATION

## Accessories

Check the accessories provided with the product.

The picture may be different from the actual product.

Accessories are subject to change without prior notice in order to improve the performance of the product. New accessories may be added or old ones may be removed.

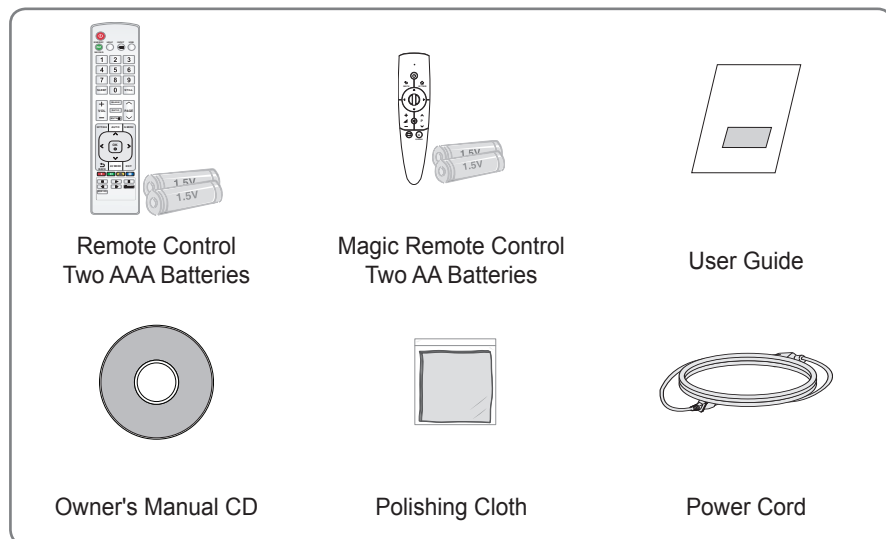

- When connecting a cable to the HDMI or USB port, make sure the bezel of the cable is not too large and will not block other ports.

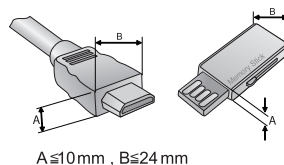



## Optional Accessories

To purchase optional accessories, visit an electronics store or an online shopping site. Optional extras are subject to change without prior notice in order to improve the product quality, and new optional accessories may be added.



Video Cable



Audio Cable



HDMI Cable



Optical Cable



PC Audio Port  
Connection Cable



Cables for Connecting  
External Devices

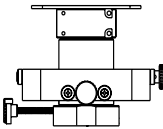

Ceiling Bracket  
(AJ-CB100)

## Accessories Shipped with Product

These accessories are shipped with the product when you purchase it.



Hecto Laser Display  
Projection Screen  
(SC100)

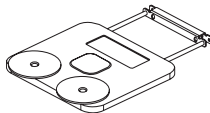

Ez Bracket  
(AJ-BB100)

## Parts and Components

### Front

- \* This Laser Display is manufactured using high-precision technology. You may, however, see tiny black dots and/or bright spots that continuously appear on the screen. This is a normal result of the manufacturing process and does not indicate a malfunction.
- \* Ceiling light glare depends on the light levels in a room and the distance between the product and the ceiling. It is not a product defect.

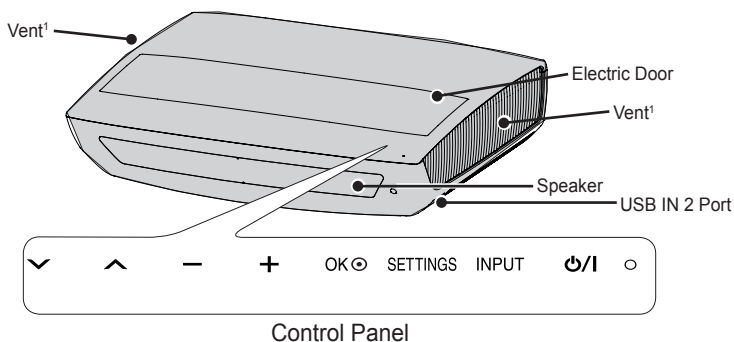

Button	Description
∧, ∨	Moves between menus and changes the settings.
-, +	Adjusts the volume level, or enters a sub menu and changes the settings.
OK ●	Shows the current mode and saves changes to the settings.
SETTINGS	Displays or closes the Settings menu.
INPUT	Changes the input source.
●/I (Power)	Turns the the Laser Display on or off.

- 1 Due to the high temperature of the vent area, do not get close to the vent area.

### ! NOTE

- Press the "USB IN 2" label shown in the figure above to make the USB IN 2 port visible.

**Back**

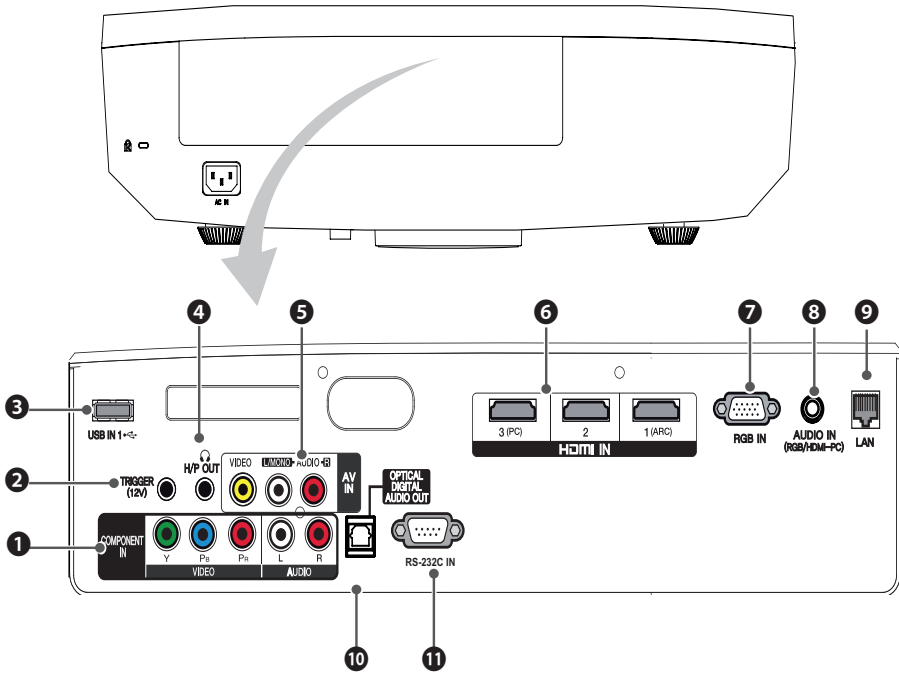

1	Component IN Port
2	TRIGGER(12 V) Port Connect an external device (e.g., roll screen) to this port.
3	USB IN1 Port
4	H/P OUT Port
5	AV IN Port
6	HDMI IN 1(ARC), 2, 3(PC) Port
7	RGB IN Port
8	AUDIO IN (RGB/HDMI-PC) Port
9	LAN Port
10	OPTICAL DIGITAL AUDIO OUT Port In standby mode, digital audio is not output.
11	RS-232C IN Port

# Status Indicator

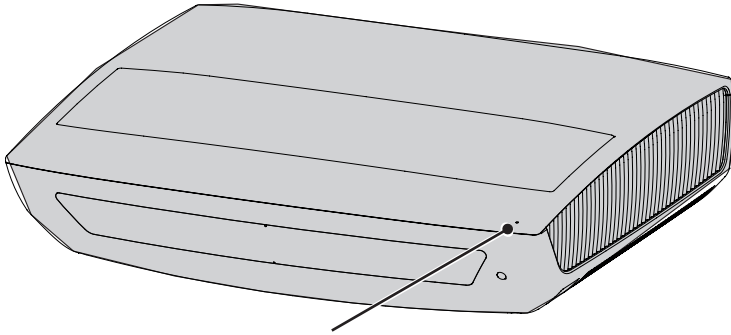

Operation/Status Indicator

Operation/ Status Indicator	Off	Power standby state (Power is off.)
	Red	Power standby state
	White	Warm stand-by (Power standby state)
	White (Brightness changes slowly.)	The Laser Display is in the process of turning on or off.
	Off	In operation
	Red (blinking)	High temperature warning
	Red (blinking) + Purple once (blinking)	The Laser Display has turned off due to the high temperature.
	Red (blinking) + Purple twice (blinking)	There may be a problem inside the product, so contact a local service center.
	Red (blinking) + Purple three times (blinking)	
	White (blinking) + Purple once (blinking)	
	White (blinking) + Purple twice (blinking)	
	White (blinking) + Purple three times (blinking)	



**NOTE**

- If you turn off the power, the Laser Display may not complete the operation in progress depending on conditions and the operation/status indicator may turn red (standby mode).

# Installation

## Installation Precautions

- Place the product in a well-ventilated environment.
  - To prevent the internal heat from building up, install the Laser Display in a well-ventilated place. Do not place anything near the Laser Display. That may block its air vents. If the air vents are blocked, the internal temperature will increase.

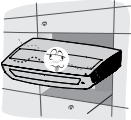

- Do not place the Laser Display on a carpet or rug. If a product has its inlet vent on its bottom, do not block the vent and use the product on a leveled solid surface.



- Be sure to prevent foreign objects, such as scraps of paper, from entering the inlet vent.



- Leave enough distance (30 cm or more) around the vent of the Laser Display.



- Do not place the product in a hot or humid environment.
  - Do not place the product in a hot, cold, or humid environment. (See the details about the operating temperature and humidity.)
- Do not place the product in a dusty place.
  - This may cause fire.
- Never open any cover on the product. There is a high risk of electric shock.
- The Laser Display is manufactured using high-precision technology. You may, however, see tiny black dots and/or bright spots that continuously appear on the screen. This is a normal result of the manufacturing process and does not indicate a malfunction.
- The remote control may not work in an environment where a lamp equipped with electronic ballasts or a three-wavelength fluorescent lamp is installed. Replace the lamp with an international standard lamp for the remote control to work normally.
- Do not open or press the electric door or by force.
  - This may cause product malfunction.

### **Projection Distance per Screen Size**

- 1** Place the Laser Display on a sturdy level surface, together with the computer or audio/video source.
- 2** Place the Laser Display at an appropriate distance away from the screen. The distance between the Laser Display and the screen determines the actual size of the image.
- 3** Position the Laser Display so that the lens is perpendicular to the screen. If the lens is not perpendicular to the screen, the image displayed on the screen may be distorted. To correct the distortion, use the Edge Adj function.
- 4** Connect the power cords of the Laser Display and the connected devices to the wall outlet.

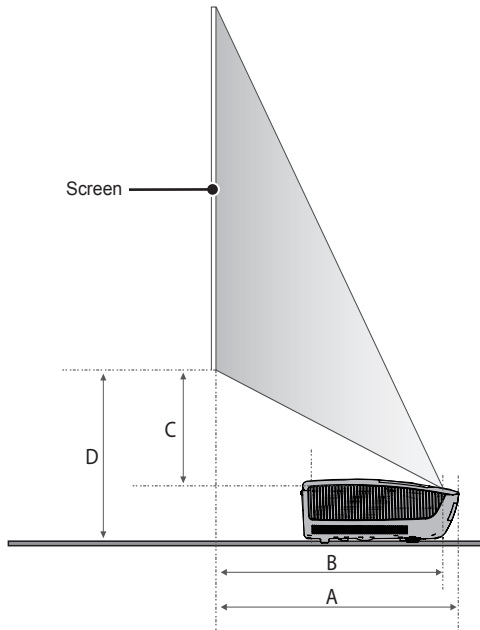

16:9 Aspect Ratio (Unit: mm)	
ARC	2540 (2213 x 1245)
A	550
B	530
C	262.5
D	370

## **Kensington Security System**

- This the Laser Display has a Kensington Security Standard connector to prevent theft. Connect a Kensington Security System cable as shown below.
- For more information on installation and use of the Kensington Security System, refer to the user guide provided with the Kensington Security System.
- The Kensington Security System is an optional accessory.
- What is Kensington?

Kensington is a company that provides safety systems for laptops and other electronic devices.

Website: <http://www.kensington.com>

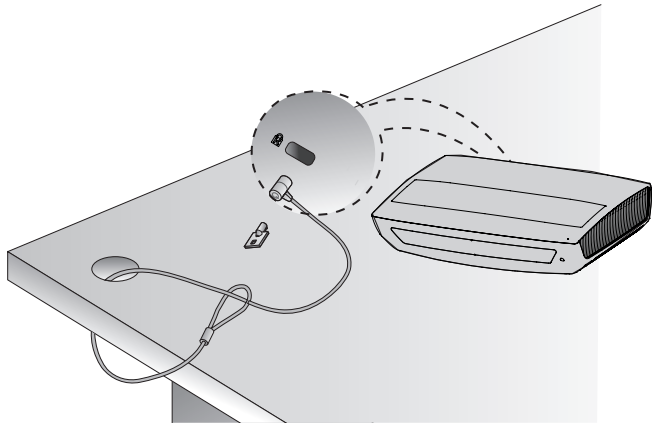

# REMOTE CONTROL

Open the battery cover on the back of the remote control and insert the batteries which is specified in the battery room with  $\oplus$   $\ominus$  poles pointing in the correct direction. The new and same type of batteries (1.5 V AAA) must be used.

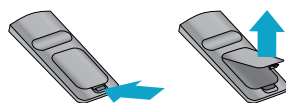

## CAUTION

- Do not mix new batteries with old ones.



### POWER

Turns the Laser Display on or off.

### ENERGY SAVING

Changes the energy saving mode.

### HELP

Enables the self-diagnosis.

### INPUT

Changes the input source.

### USB

Accesses USB mode.

### Number buttons

Enters a number.

### SLEEP

Sets the length of time until the Laser Display turns off.

### STILL

Freezes the moving image.

(Available in any mode other than DivX)

### VOL +, -

Adjusts the volume level.

### BLANK

Displays the empty screen for a while.

### RATIO

Resizes the picture.

### MUTE

Mutes the sound of the Laser Display.

### PAGE ,

Moves to the previous/next page.



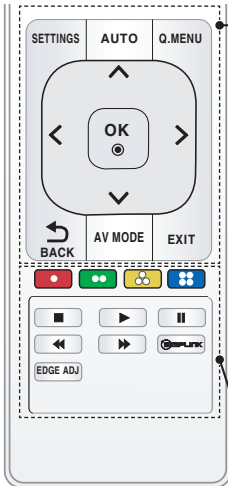

**SETTINGS**

Displays or closes the Settings menu.

**AUTO**

Automatically adjusts the PC input image.

**Q.MENU**

Changes the settings easily.

**Up/Down/Left/Right buttons**

Switches between menu functions.

**OK**

Shows the current mode and saves changes to the settings.

**BACK**

Returns to the previous screen.

**AV MODE**

Sets the genre for the Laser Display program.

**EXIT**

Closes a menu.

**Color buttons**

Sets detailed settings or gesture for each menu.

**Playback control buttons**

Controls the playback of SmartShare.

**Simplink**

Allows you to use the Simplink function.

**EDGE ADJ**

Adjusts the image to fit the screen.



**NOTE**

- For seamless operation, do not block the IR receiver.

# MAGIC REMOTE CONTROL

If the battery low message appears while using the Laser Display, replace the batteries.

As shown in the figure, press the top of the battery cover and slide it down the cover. Insert two new and identical alkaline batteries (1.5V, AA type) with + and - poles pointing in the correct direction in the remote control.

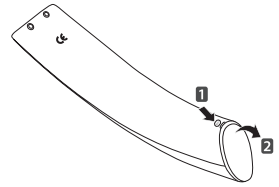

**CAUTION**

- Do not mix new batteries with old ones.

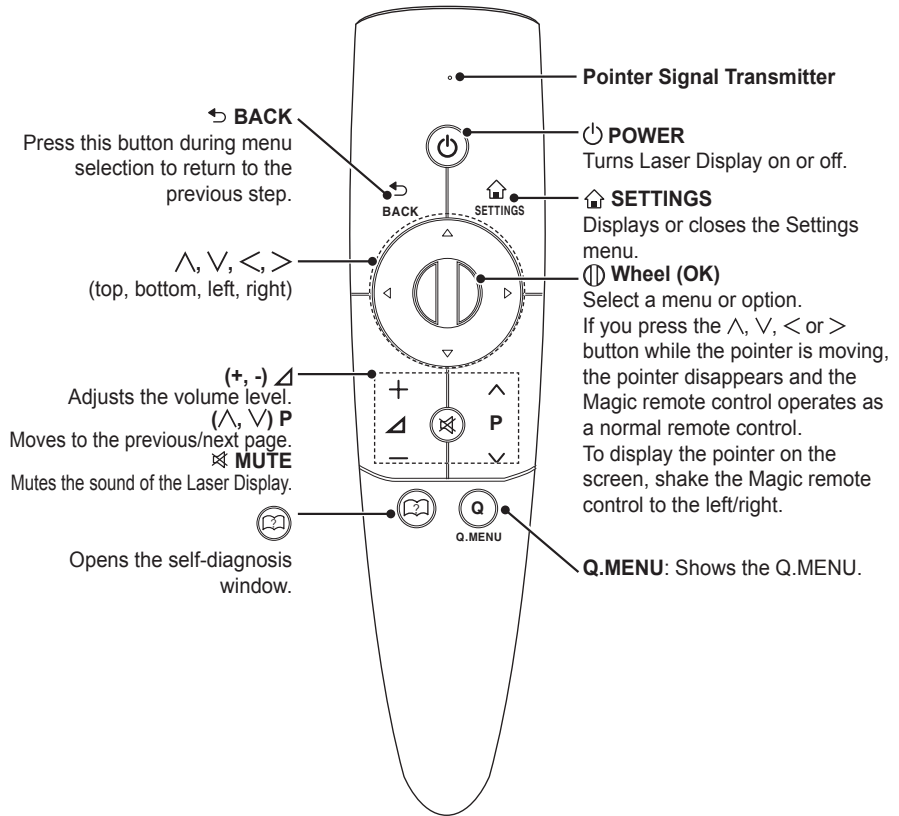

## Pairing the Magic Remote Control

You must pair the Magic remote control with the Laser Display to use it.

Pair the Magic remote control prior to use as follows:

- 1 Turn on the Laser Display and press the **Wheel (OK)** button towards the Laser Display. When the pairing is complete, the pairing completion message is displayed on the Laser Display screen.
- 2 If the remote failed to pair, turn the Laser Display off and on and try pairing again by pressing the **Wheel (OK)** button.

## Re-pairing the Magic Remote Control

- 1 Press the **SETTINGS** button and **BACK** button at the same time for about 5 seconds.  
The Magic remote control will pair again when you press the **Wheel (OK)** button.
- 2 Press the **BACK** button while pointing the remote control at the Laser Display for about 5 seconds to reset and pair the remote control. When the pairing is complete, the pairing completion message is displayed on the Laser Display screen.

## Using the Magic Remote Control

- 1 Shake the Magic remote control lightly when there is no pointer displayed on the screen. A pointer will be displayed on the screen.  
→ The pointer disappears if the remote control is not used for a certain period of time.
- 2 When you move the pointer signal transmitter up/down/left/right while pointing it toward the Laser Display, the pointer moves.  
→ If the pointer is not working properly, do not move the Magic remote control for about 10 seconds, and then try again.



### **NOTE**

- Use the remote control within the specified range (10 meters). You may experience communication failures when using the device outside the coverage area or if there are obstacles within the coverage area.
- You may experience communication failures depending on nearby devices. Devices, such as a microwave oven and wireless LAN, operate in the same frequency band (2.4 GHz) as the Magic remote control. This may cause communication failures.
- The Magic remote control may become damaged or may malfunction if it is dropped or receives a heavy impact.
- Take care not to bump into nearby furniture, electronics or other people when using the Magic remote control.

# Setting Up the Laser Display

## Setting Up the Laser Display

### Initial Setup

- 1 Connect the power cord correctly.
- 2 After waiting for a moment, press the **POWER** button on the remote control or the control panel.
- 3 When you turn on the Laser Display for the first time, a setting screen appears as shown below.  
Here, you can specify the items required for watching the Laser Display more easily.

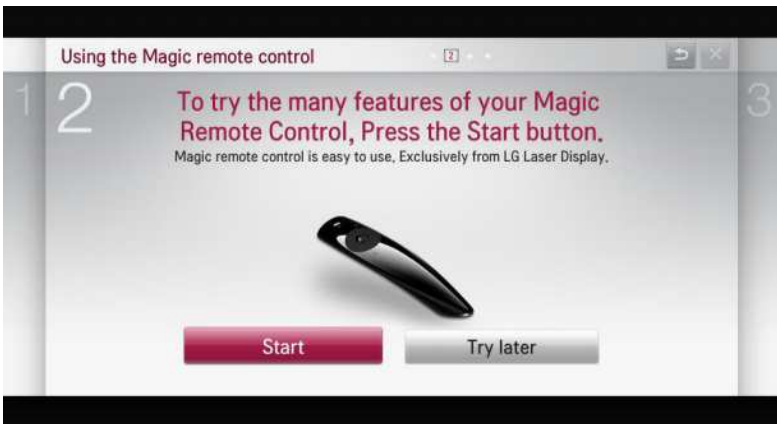
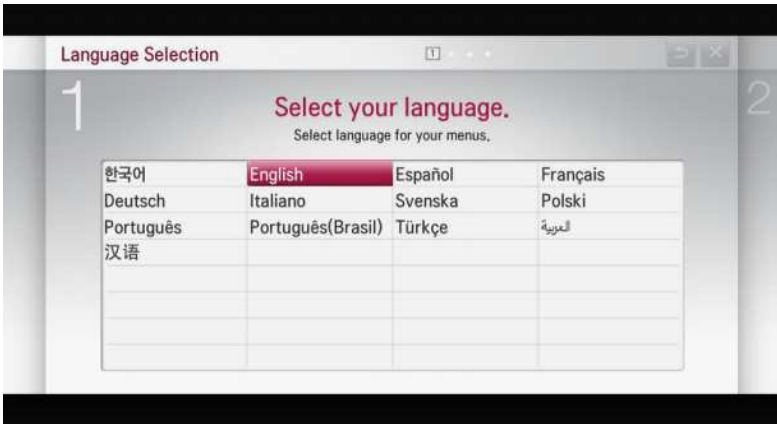



## **Watching Laser Display**

- 1** When in Standby mode, press the **POWER** button to turn the Laser Display on.
- 2** Press the **INPUT** button and select the input signal you want.
- 3** Control the Laser Display using the following buttons while watching the screen.

<b>Button</b>	<b>Description</b>
<b>VOL -, +</b>	Adjusts the volume level.
<b>MUTE</b>	Mutes the sound from the Laser Display.
<b>Q.MENU</b>	Enters the quick menu.
<b>Edge Adj</b>	Adjusts the image to fit the screen.

- 4** To turn off the Laser Display, press the **POWER** button.

## Additional Options

### Adjusting the Aspect Ratio

You can adjust the aspect ratio of the picture by pressing **RATIO** while watching Laser Display.

#### ! NOTE

- Available options may vary depending on the input signal.
- You can also use the **Q.MENU** or **SETTINGS** button.

- **16:9:** Resizes images to fit the screen width.



- **Just Scan:** Displays video images in the original size without cutting off the edges.

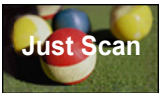

#### ! NOTE

- For Just Scan, you may see image noises at the edges of the screen.

- **Set By Program:** Displays images in the same aspect ratio as the original image.



- **4:3:** Resizes images to the aspect ratio.



- **Zoom:** Enlarges an image to fit the screen width. The top and bottom of the image may be truncated.
  - Press the < or > button to zoom in or out of the image.
  - Press the ^ or v button to move the image.



- **Cinema Zoom 1:** Formats an image to the cinemascope ratio, 2.35:1. It ranges from 1 to 16.
  - Press the < or > button to zoom in or out of the image.
  - Press the ^ or v button to move the image.



#### ! NOTE

- If you enlarge or reduce the picture, it may be distorted.

## Using the Edge Adj Function

To prevent the screen image from becoming trapezoidal, Edge Adj adjusts the top and bottom width of the image if the Laser Display is not set up at a right angle to the screen.

Because the Edge Adj function may cause inferior screen image quality, use this function only when it is not possible to set up the Laser Display at an optimal angle.

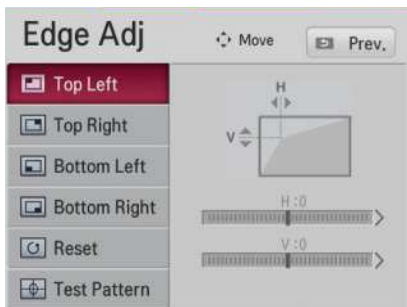

- Adjust the screen using the **EDGE ADJ** button.
  - The value range of Edge Adj is as follows.
    - Left top (H: 0 ~ 100, V: 0 ~ 100)
    - Right top (H: -100 ~ 0, V: 0 ~ 100)
    - Left bottom (H: 0 ~ 100, V: -100 ~ 0)
    - Right bottom (H: -100 ~ 0, V: -100 ~ 0)
- Press the **OK** button after adjustment.

### NOTE

- While you use the Test Pattern option, the keys on the control panel do not work.

## Using the Input List

### Using the Input List

- Press the **INPUT** button to display the input selection screen.



- Select an input signal using the **INPUT** button to switch the Laser Display to the desired input mode. You can use the **<** or **>** button to switch between all the input modes.

### Selecting an Input Label

You can select an input label to display which devices are connected to which input ports.

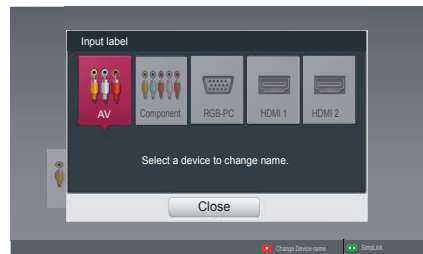

- Press the **INPUT** button to display the input selection screen.
- Press the **red** button.
- Press the **<** or **>** button to select an input and press **OK** button.
- Use the **^**, **v**, **<** or **>** button to select a device name.



## To use SIMPLINK

SIMPLINK allows users to control and manage multiple multimedia devices using the convenient Laser Display remote control and SIMPLINK menu.

- 1** Connect the Laser Display's HDMI IN terminal with SIMPLINK device's HDMI output terminal using HDMI cable. For home theater units with SIMPLINK function, connect HDMI terminals as above and use an optical cable to connect Optical Digital Audio Out from the Laser Display to Optical Digital Audio In of the SIMPLINK device.
- 2** Press the **SIMPLINK** button. SIMPLINK menu window appears.
- 3** Select **Set SIMPLINK** on SIMPLINK menu window. SIMPLINK setup window appears.
- 4** Set SIMPLINK to On in SIMPLINK setup window.
- 5** Close SIMPLINK setup window.
- 6** Select the device to control from SIMPLINK.

### NOTE

- This function works only on devices with the SIMPLINK logo ()
- Make sure that the external device has a SIMPLINK logo.
- To use SIMPLINK function, use a high-speed HDMI® cable (with CEC, or Consumer Electronics Control feature added) and No. 13 pin connected for information exchange between devices.
- Turn on or select the media of a device with home theater features to see the speaker switch to HT Speaker.
- Connect with an Optical cable (sold separately) to use HT Speaker.
- Switching to external input causes devices operating with SIMPLINK to stop.
- Use of a third-party device with HDMI-CEC features may cause malfunctions.

## Explanation on SIMPLINK features

Menu	Description
<b>Direct Play</b>	Play the multimedia device on the Laser Display instantly without extra steps.
<b>Select multimedia device.</b>	Select the desired device through the SIMPLINK menu and instantly control it from the Laser Display screen.
<b>Disc playback</b>	Manage the multimedia device with the Laser Display remote control.
<b>Power off all devices</b>	Turning the Laser Display off with Auto Power function On in SIMPLINK setting will turn the power off on all SIMPLINK-connected devices.
<b>Sync Power on</b>	If the Auto Power function is set to On in the SIMPLINK settings, turning on a SIMPLINK device will turn the Laser Display on.
<b>Speaker</b>	Selects speaker on the home theater unit or Laser Display.

## Using the Quick Menu

You can customize frequently used menus.

- 1** Press **Q.MENU** to access the quick menus.
- 2** Press the **<** or **>** button to select a menu and press **OK**.

Menu	Description
<b>Aspect Ratio</b>	Resizes the picture.
<b>Picture Mode</b>	Changes the picture mode.
<b>Sound Mode</b>	Sets the sound mode.
<b>Sleep Timer</b>	Sets the Laser Display to be turned off at the specified time.
<b>ENERGY SAVING</b>	Adjusts the brightness.
<b>AV MODE</b>	Sets the genre.
<b>Caption</b>	Sets whether to display captions.
<b>USB Device</b>	Allows you to remove a connected USB device in a safe manner.(Displayed only when a USB device is connected.)

- 3** Press the **^**, **v**, **<** or **>** button to scroll through the following menus.

# Network Features

## NETWORK Settings

To use the smart functions, the wired or wireless Internet must be connected. Once the Internet is connected, you can use DLNA functions, etc.

### One-Click Network Connection

You can make a wireless network connection easily.

- 1** Press the **SETTINGS** button.
- 2** Press the  $\wedge$  or  $\vee$  button to select **NETWORK** and press the **OK** button.
- 3** Use the  $\wedge$ ,  $\vee$ ,  $<$  or  $>$  button to set Network Connection and press the **OK** button.
- 4** It is automatically connected to the network.  
See the Help provided by the Laser Display.

### Expert Settings for Network Connection

It is used in a specific environment such as office (where fixed IP, etc. is used).

- 1** Press the **SETTINGS** button.
- 2** Press the  $\wedge$  or  $\vee$  button to select **NETWORK** and press the **OK** button.
- 3** Use the  $\wedge$ ,  $\vee$ ,  $<$  or  $>$  button to set Network Connection and press the **OK** button.
- 4** Select **Set Expert** in the network connection list.
- 5** Select one of the following network connection methods.

Item	Description
<b>AP List</b>	Select a network from a router list.
<b>Enter the SSID</b>	Directly enter the name of the wireless router to connect.
<b>WPS-PBC</b>	Press the WPS button on the wireless router supporting the PBC to connect to the router in a simple manner.
<b>WPS-PIN</b>	Enter the PIN number in the web page of the PIN-supporting wireless router to connect to the router in a simple manner.
<b>Ad-hoc</b>	Use the PC, mobile phone, etc. which is connected to Wi-Fi.

## Wireless Network Connection

You can use a wireless network by using the built-in wireless network module as shown below.

A wireless router must be installed and operating at this time. Refer to the wireless router's user manual to see how to install it.

The network settings and connection may be different depending on the network environment. Set up the router as instructed in its user manual.

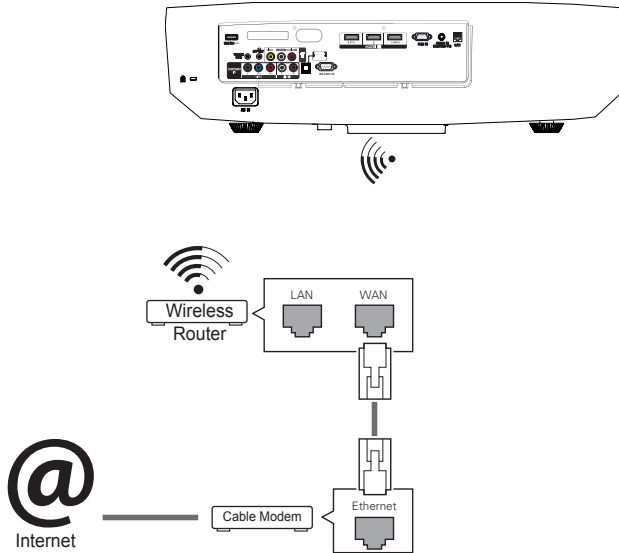

## Wireless Network Setup

This function allows you to use the wireless connection e.g., Wi-Fi Direct and WiDi. You can share the screen of the device connected by the Wi-Fi Screen Share on the SmartShare.

Turn on the Wi-Fi Screen Share. A list of devices available for connection is displayed. Select a device to connect. A connection request message is displayed. Select Yes. The Wi-Fi Screen Share is then connected.

- 1** Press the **SETTINGS** button.
- 2** Use the **^**, **v**, **<** or **>** button to select **NETWORK** and press the **OK** button.
- 3** Press the **^**, **v**, **<** or **>** button to select **Wi-Fi Screen Share** and then press the **OK** button.

## **Tips for Network Setup**

- Modem reconfiguration may cause network connection problems. If it does, turn off the modem and disconnect it from the product; then turn on the modem again. It will be working normally.
- LG Electronics is not responsible for any Internet connection problems, or any failure, error or malfunction due to your Internet connection.
- The network connection may not be working properly because of the Internet Service Provider (ISP).
- DSL service requires a DSL modem, and cable service requires a cable modem. Internet connections may be limited due to an agreement with an Internet service provider (ISP) and the Laser Display may not be connected to a network. (When only one device is allowed per line and a PC is already connected, other devices are not available for use.)
- The wireless network may be affected by interference from a device that uses 2.4 GHz frequency, such as a wireless telephone, Bluetooth device or microwave. Interference may also be caused by a device that uses 5 GHz frequency such as Wi-Fi devices.
- The wireless network service may run slowly depending on surrounding wireless environment.
- Some devices may have network traffic jam if any of local home networks is turned on.
- To connect to a wireless router, a router that supports wireless connection is necessary; the wireless connection function of the corresponding router must also be activated. Ask the router manufacturer whether the router supports wireless connection.
- To connect to a wireless router, verify the SSID and security settings of the wireless router. Please refer to the user guide of the corresponding router regarding SSID and security settings of the wireless router.
- The Laser Display may not slow down or malfunction if network devices (wire/wireless router or hub, etc.) are incorrectly set up. Be sure to install the devices correctly by referring to their user guides before configuring the network connection.
- When Ad-hoc is used, it may not be able to connect depending on the device (for example, laptop) that is connected.
- The connection method may vary according to the manufacturer of the wireless router.

## Using the Wi-Fi Screen Share Function

With this function, you can use a wireless connection such as Wi-Fi Direct or WiDi, etc.

Using SmartShare, you can share a device's screen through Wi-Fi Screen Share.

### Connecting the Wi-Fi Direct

- 1 Press the **SETTINGS** button.
- 2 Press the  $\wedge$  or  $\vee$  button to select **NETWORK** and press the **OK** button.
- 3 Press the  $\wedge$ ,  $\vee$ ,  $\lt$  or  $\gt$  button to select **Wi-Fi Screen Share** and then press the **OK** button.
- 4 Set Wi-Fi Screen Share to On. (If you don't want to use this function, set to Off.)
- 5 Enable Wi-Fi Direct on the device that you want to connect to.
- 6 The list of devices that can connect to the Laser Display is displayed.
- 7 Select a device to connect.
- 8 Select Yes when the connection request message appears.
- 9 If the device that you want to connect to accepts the request, Wi-Fi Screen Share will be connected.

## Using WiDi

WiDi represents Wireless Display. It is a system that sends video and sound files a notebook PC that supports Intel WiDi.

### WiDi Setup (Wireless Display)

- 1 Press the **SETTINGS** button.
- 2 Use the  $\wedge$ ,  $\vee$ ,  $\lt$  or  $\gt$  button to select **NETWORK** and press the **OK** button.
- 3 Press the  $\wedge$ ,  $\vee$ ,  $\lt$  or  $\gt$  button to select **Wi-Fi Screen Share** and then press the **OK** button.
- 4 Set Wi-Fi Screen Share to On. (If you don't want to use this function, set to Off.)
- 5 Your laptop runs the Intel WiDi program ().
- 6 The nearby LG Laser Displays supporting WiDi are searched. In the list, select the Laser Display you want and click Connect.
- 7 Enter the 4-digit MY PIN number displayed on the Laser Display in the Intel WiDi program input field on a laptop and press Continue.
- 8 In a moment, the laptop screen is displayed on the Laser Display screen. The wireless environment may affect the screen display. If the connection is poor, the Intel WiDi connection may be lost.

\* For more information on how to use the Intel WiDi, visit <http://intel.com/go/widi>.

# SmartShare™

## Before Using

### Connecting a USB Device

Connect a USB device (external HDD, USB memory) to the USB port of Laser Display to enjoy the content files stored in the USB device with your Laser Display.

You cannot write or delete data in the USB device.

Connect a USB memory stick as shown below.

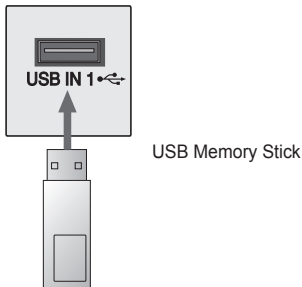

### Removing a USB Device

- 1** Press **Q.MENU** to access the quick menus.
- 2** Use the **<** or **>** button to move to **USB Device** and press the **OK** button.
- 3** Remove the USB device.

#### **!** **NOTE**

- After the USB device is disconnected, it cannot be read. Remove the USB device and connect it again.

### Tips for Using a USB Device

- A USB device which has a built-in automatic recognition program or uses its own driver might not be recognizable.
- Some USB devices may not be supported or will not work properly.
- Please use only a USB device formatted as a FAT32 or NTFS file system provided by Windows.
- It is recommended to use an external USB hard disk with rated voltage of 5V or less and rated current of 500mA or less.
- It is recommended to use a USB hub or hard disk drive with power supplied. (If the power supplied is not enough, the USB device may not be detected properly.)
- It is recommended to use a USB memory stick which is 32 GB or less and a USB hard drive which is 2 TB or less.
- If a USB external hard drive with the power saving function does not work, turn the hard drive off and on again to make it work properly. See the owner's manual of the USB hard drive for more information.
- The data of a USB device may be damaged, so it is recommended to back up any important files. Users are responsible for data management. The manufacturer bears no responsibility.

### Supported Files for SmartShare™

- Maximum data transmission rate: 20 Mbps (Megabit per second)
- Supported external subtitle formats: \*.smi, \*.srt, \*.sub (MicroDVD, SubViewer 1.0/2.0), \*.ass, \*.ssa, \*.txt (TMPlayer), \*.psb (PowerDivX)
- Supported internal subtitle formats: XSUB (subtitles from DivX6 are supported)

### Subtitle Language

Subtitle Language	Language
Latin1	English, Spanish, French, German, Italian, Swedish, Finnish, Dutch, Portuguese, Danish, Romanian, Norwegian, Albanian, Gaelic, Welsh, Irish, Catalan, Valencian
Latin2	Bosnian, Polish, Croatian, Czech, Slovak, Slovenian, Serbian, Hungarian
Latin4	Estonian, Latvian, Lithuanian
Cyrillic	Bulgarian, Macedonian, Russian, Ukrainian, Kazakh
Greek	Greek
Turkish	Turkish
Hebrew	Modern Hebrew
Chinese	Simplified Chinese
Korean	Korean
Arabic	Arabic



## Connecting DLNA

Digital Living Network Alliance (DLNA) allows you to enjoy videos, music and photos saved on your PC or server using the Laser Display through a home network.

### Connecting the DLNA-Certified

#### Mobile Device

Laser Display and smartphone should be connected to the same network.

- 1** Enable Wi-Fi on the smartphone.
- 2** Install/run the app to share content on the smartphone.
- 3** Run “Share my mobile phone Content”.
- 4** Select the kind of Content (video/music/photo) to play.
- 5** Select the video, music, or photo file to play on Laser Display.
- 6** Select Add to Playlist.
- 7** On the device that you want to play the file, select the Laser Display model. (You can find the Laser Display model name on the product label.)
- 8** Play ▶ Enjoy the selected file on Laser Display.

### Connecting DLNA DMR (Digital

#### Media Renderer)

With the Windows 7 or Window 8 PC operating system or DLNA-certified device (e.g. mobile phone), music/videos/photos may be played on the Laser Display without installing a separate program.

- 1** Configure the Laser Display and PC on the same network. Configure Windows 7 or Window 8-installed PC on the network.
- 2** To replay a music/video/photo file, right-click on the file and use the “Remote Playback” Windows 7 or Window 8 feature. To play on your mobile device, refer to its user manual.
- 3** Content will be played in only one device even though more than one Laser Display or device is connected. Play speed can vary depending on network speed.

## Connecting DLNA DMP (Digital

### Media Player)

With a PC having SmartShare PC Software, music/video/photo files may be replayed on the Laser Display by linking them via home networking.

- 1 Configure the Laser Display and the PC on the same network. Laser Display and each device should be connected through a single access point to enable DLNA service.
- 2 Install SmartShare PC Software on PC from the web site. Before installation, close all running programs including firewall and Anti-Virus programs.
- 3 The sever should be running in order to watch the shared file on your Laser Display.

### NOTE

- For how to use the SmartShare PC software, refer to the software help.

## When DLNA is Malfunctioning

- Check your network settings when the DLNA option does not work properly.
- To watch the 1080p video through DLNA, a router that uses 5 GHz frequency is required. If a 2.4 GHz router is used, the video does not play properly.
- When playing a video in DLNA mode, the Multi Audio and Closed Caption features are not supported.
- If multiple Laser Displays are connected to one server in the DLNA mode, the content may not be played properly depending on server performance.
- Subtitles are only supported on some DMC devices.
- The DLNA function may not work properly depending on the network environment.
- The DLNA function may not be supported for a router that does not support multi-cast. For more information, refer to the user guide that came with your router or contact to the manufacturer.
- Even for the file format supported by the Laser Display, the supported file format may differ depending on the DLNA server environment.
- If there are too many folders or files in a folder, it may not work properly.
- The information on the file imported from the DLNA server may not be displayed correctly.
- When viewing video subtitles on a DLNA server, we recommend that you use SmartShare PC Software.
- When a subtitle file is added later, disable the shared folder and then enable it again.
- The DRM file and document file in the DLNA server are not played.

# Using SmartShare™

- 1 Press the **USB** button on the remote control.

You can watch the photo, music and video on the Laser Display by connecting a USB or home network (DLNA). It shows all the photos, music and videos in the device connected to the Laser Display.



## **Watching the Videos**

In the Movie List, you can watch movies stored on the connected USB device.

### **Tips for Playing Videos**

- Some subtitles created by a user may not work.
- A video file and its subtitle file must be located in the same folder. A video file name and its subtitle file name must be identical in order to display the subtitle properly.
- Streaming of files encoded by GMC (Global Motion Compensation) or Qpel (Quarterpel Motion Estimation) is not supported.
- H.264/AVC profile level 4.1 or below is supported.
- The file sizes that can be played may be different depending on the encoding environment.
- Video files created by some encoders may not be played back.
- Video files in formats other than the ones specified here may not be played back.
- Videos stored on a USB device that does not support high-speed playback may not play properly.
- The DTS is supported only for playback of USB video files.

**Video Codec**

Maximum supported resolution: 1920 x 1080 @ 30p

Extension	Codec	
.asf .wmv	Video	VC-1 Advanced Profile, VC-1 Simple and Main Profile
	Audio	WMA Standard, WMA 9 Professional
.divx .avi	Video	DivX3.11, DivX4, DivX5, DivX6, XViD, H.264/AVC, Motion Jpeg
	Audio	MPEG-1 Layer I, II, MPEG-1 Layer III (MP3), Dolby Digital, Dolby Digital Plus, LPCM, ADPCM, DTS
.mp4 .m4v .mov	Video	H.264/AVC, MPEG-4 Part 2
	Audio	AAC
.mkv	Video	H.264/AVC
	Audio	HE-AAC, Dolby Digital
.ts .trp .tp	Video	H.264/AVC, MPEG-2, VC-1
	Audio	MPEG-1 Layer I, II, MPEG-1 Layer III (MP3) Dolby Digital, Dolby Digital Plus, AAC
.vob	Video	MPEG-1, MPEG-2
	Audio	Dolby Digital, MPEG-1 Layer I, II, DVD-LPCM
.mpg .mpeg	Video	MPEG-1
	Audio	MPEG-1 Layer I, II

**Controlling the Video Playback**

You can control playback using the following buttons.

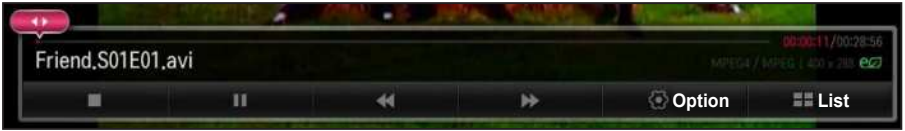

Item	Description
◀▶	Shows the current playing position. You can use the < or > button to move forward or backward.
■	Stops playing and returns to Movie List.
▶	Resumes normal playback.
	Pauses the media player.
▶▶	Displays in slow motion.
◀▶	Whenever this button is pressed, the playback speed is increased or decreased by one unit.
Option	Sets the option.
List	Stops the playback and returns to the list.

## Viewing the Photos

You can view photos stored on a connected device.

### Photo File

File Format	Item	Information	
2D (jpeg, jpg, jpe)	Supported format	SOF0: baseline SOF1: Extend Sequential SOF2: Progressive	
	Size	Min.	64 x 64
		Max.	Normal Type: 15360 (W) x 8640 (H) Progressive Type: 1920 (W) x 1440 (H)

### Controlling the Photo Playback

You can control playback using the following buttons.

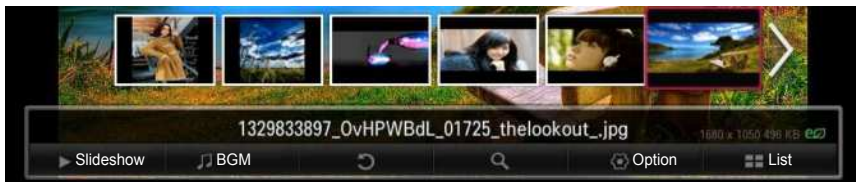

Item	Description
<, >	Selects the previous or next photo.
Slideshow	If no picture is selected, all photos in the current folder are displayed in a slide show. If one or photos are selected, those photos are displayed in a slide show. Set Slide Speed in the Option → Set Photo View menu.
BGM	You can listen to music while viewing full-size photos. Set BGM in the Option → Set Photo View menu.
↻	Rotates photos. Rotates a photo 90°, 180°, 270°, 360° clockwise. Photos cannot be rotated if their width is greater than the height of the maximum supported resolution.
🔍	Enlarges or reduces the photo. Use the Up/Down/Left/Right buttons to select a page and press the OK button.
Option	A setting popup window will appear.
List	Stops the playback and returns to the list.

## Listening to Music

You can play audio files stored on the connected device.

### Audio File

File Format	Item	Information
MP3	Bit rate	32 Kbps - 320 Kbps
	Sample freq.	16 kHz - 48 kHz
	Support	MPEG1, MPEG2, Layer2, Layer3

### Controlling Music Playback

You can control playback using the following buttons.



Item	Description
◀▶	Changes the playing position.
■	Stops playing.
▶	Resumes normal playback.
◀▶	Plays the previous/next file.
↺	Sets the repeat playback.
✂	Sets the random playback.
Option	Sets Option for the music list.
List	Returns to a list.



## Using the Magical Mirroring Function

The Magical Mirroring feature is used to wirelessly transmit and project the screen of a network-connected laptop (PC) to the Laser Display. To use this function, MirrorOp Sender, an application for PC, should be installed in the user's laptop (PC). You can download this PC program from [www.mirrorop.com/products\\_support/LG/](http://www.mirrorop.com/products_support/LG/). (To obtain a full-featured MirrorOp Sender program, a user should purchase one.)

### System Requirements

<b>CPU</b>	Dual core 1.8 GHz or higher (excluding Atom processor)
<b>Display Adaptor</b>	nVIDIA or ATI graphic card with 64MB VRAM or above
<b>Operating System</b>	Windows Vista, Windows 7
<b>Wi-Fi</b>	802.11 n

## Running Magical Mirroring

- 1 Select Magical Mirroring from the Settings.



### CAUTION

- Magical Mirroring is available only when a network is connected.
- When Magical Mirroring is running, only the following buttons are available on the remote control and control panel: Power, Volume, Previous and Exit.

- 2** After running Magical Mirroring, execute the MirrorOp Sender program in the PC on a standby screen as follows.



- 3** In the Remote Device IP field of the MirrorOp Sender, enter the IP which is the same as the host IP of the Magical Mirroring and press Connect.

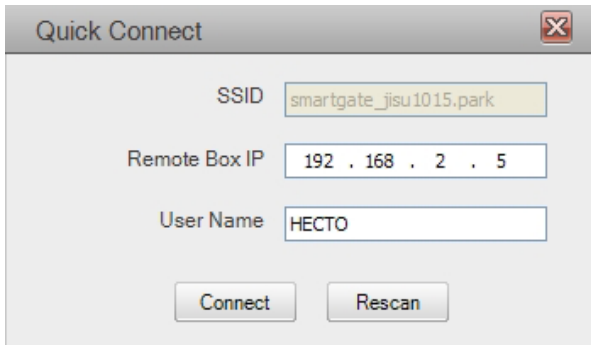

<PC Screen>

- 4 If MirrorOp Sender is connected normally, the connected PCs are displayed in Device List of Magical Mirroring as shown below. (All connected PCs are displayed.)



If MirrorOp Sender does not run, Device List of Magical Mirroring is shown as follows. Check the network connection.



- 5 In the Device List, select a desired PC by pressing the Up/Down key and press the OK button.

**CAUTION**

- While running Magical Mirroring, the video or audio transmitted from the PC may be interrupted due to PC performance or wireless network status.

## MirrorOp Sender

### Changing MirrorOp Mode



Move the button to this position to change the transfer mode to application mode.



Move the button to this position to change the transfer mode to movie mode.

Mode	Description
<b>Application Mode</b>	When MirrorOp is set to this mode, the software will transfer images with greater quality. When you run applications such as games, you can set to this mode. This mode requires broadband, so we suggest you use the wired network when using this mode.
<b>Movie Mode</b>	This mode is only for movies. When you play a movie on your PC, you can change to this mode. In this mode, the mouse and other applications do not work in real time.

## Configuring MirrorOp

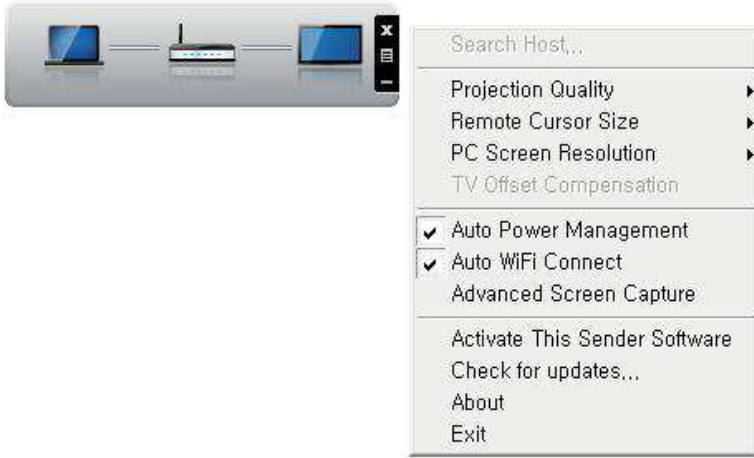

- **Search Host**
  - Searches the devices available for connection on the local network.
- **Projection Quality**
  - Changes the quality of the projected image. If the network speed is high, select 'Best'; if not, select 'Normal'.
- **Remote Cursor Size**
  - Controls the size of mouse cursor (1x, 2x, 3x).

### ! NOTE

- Using this option, you can select "Normal" or "Best" for the projection quality. If the network connection is good, select "Best"; if not, "Normal".

**- TV Offset Compensation**

- Adjusts the size of screen projected to the Laser Display. Adjust the horizontal and vertical offset, and click the Apply button.

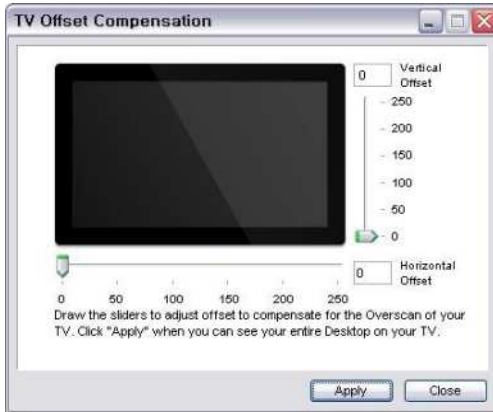
**- Auto Power Management**

- Choose this option when you run the MirrorOp application on your laptop. This option enables your Wi-Fi network to always work at an optimum level.

**- Auto Wi-Fi Connect**

- When you choose this option, your MirrorOp will automatically connect to the server and log in.

**- Advanced Screen Capture**

- Different PCs have different video output formats. When this option is not selected, some video images might not be displayed normally, for example, when you play a movie using a certain media player. When you play a movie on your PC and cannot see it with Laser Display, you should choose this option.

**- Activate This Sender Software**

- If you purchased or already have a license, please enter the license information.

**- Check for Updates...**

- Check the newest version on the network.

# CUSTOMIZING SETTINGS

## SETTINGS

- 1 Press the **SETTINGS** button.
- 2 Use the **^**, **v**, **<** or **>** button to select a desired item and press the **OK** button.
- 3 Use the **^**, **v**, **<** or **>** button to set the desired item and press the **OK** button.
- 4 Press the **EXIT** button when completed.

Menu	Description
<b>PICTURE</b>	Adjusts the image quality for optimal viewing.
<b>SOUND</b>	Adjusts the sound quality and volume level.
<b>TIME</b>	Time-related features.
<b>OPTION</b>	Customizes the general settings.
<b>NETWORK</b>	Sets the network.
<b>SUPPORT</b>	Shows the Laser Display information.

## PICTURE Settings

- 1 Press the **SETTINGS** button.
  - 2 Use the  $\wedge$  or  $\vee$  button to select **PICTURE** and press the **OK** button.
  - 3 Use the  $\wedge$ ,  $\vee$ ,  $\lt$  or  $\gt$  button to set up the desired item and press the **OK** button.
- To return to the previous menu, press the  $\curvearrowright$  button.

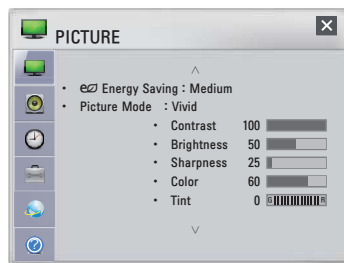

The available picture settings are described as follows.

Item	Description
<b>ENERGY SAVING</b>	Adjusts the brightness.
<b>PICTURE Mode</b>	Selects one of the preset images or customizes options in each mode for the best screen performance. You can also customize advanced options for each mode.
<b>Mode</b>	
<b>Vivid</b>	Maximizes the visual effect of video. Displays a crystal clear picture by enhancing contrast, brightness, and sharpness.
<b>Standard</b>	Displays the picture with normal contrast, brightness and sharpness.
<b>Cinema</b>	Optimizes the image for a movie.
<b>Game</b>	Optimizes the image for playing games on fast-moving screens.
<b>Expert1/2</b>	Adjusts the detailed image settings.
<b>Contrast</b>	Increases or decreases the gradient of the video signal.
<b>Brightness</b>	Adjusts the base level of the video signal to make the image brighter or darker.
<b>Sharpness</b>	Adjusts the level of edge sharpness between the light and dark areas of the picture. The lower the level is, the softer the image looks. Horizontal and Vertical Sharpness are available only in Expert1/2.
<b>Color</b>	Adjusts the intensity of all colors.
<b>Tint</b>	Adjusts the balance between red and green levels.
<b>Advanced Control</b>	Customizes the advanced settings.
<b>Picture Option</b>	Sets optional settings.



Item	Description	
<b>Picture Reset</b>	Restores each mode's options to the factory default.	
<b>Aspect Ratio</b>	Resizes the picture.	
<b>Picture Wizard II</b>	By following the instructions, you can easily adjust the picture quality to technical standards using the remote control without needing an expensive pattern device or a picture quality expert.	
<b>Screen (RGB-PC)</b>	Adjusts the picture quality in RGB-PC input.	
	Item	
	<b>Resolution</b>	Available resolution is 768 (1024x768/1280x768/1360x768, 60 Hz).
	<b>Auto Config.</b>	Provides optimized picture quality by automatically calibrating mismatched horizontal width and a shaky picture caused by conflicts between the internal settings of the Laser Display and various PC graphic signals. You can also use the <b>AUTO</b> button on the remote control.
	<b>Position</b>	Moves the image up/down/left/right.
	<b>Size</b>	Changes the screen size.
	<b>Phase</b>	Makes the picture look clear by removing horizontal noise.
<b>Reset</b>	Restores all the settings to the factory default.	

### Advanced Control

Item	Description	
<b>Dynamic Contrast</b>	Adjusts the contrast to keep it at the best level for the brightness of the screen.	
<b>Dynamic Color</b>	Adjusts screen colors so that they look natural.	
<b>Clear White</b>	Makes the white area of the screen look brighter and whiter.	
<b>Preferred Color</b>	<b>Skin Color</b>	Adjusts the skin color in the picture to your preference.
	<b>Grass Color</b>	Adjusts only the natural color area of e.g., field and mountain.
	<b>Sky Color</b>	Adjusts only the color of the sky.
<b>Super Resolution</b>	Improves blurry and unclear parts in the picture to make the picture more vivid.	
<b>Color Temperature</b>	Adjusts the overall color of the screen to suit your preference. You can select Warm, Cool, Medium or Natural.	
<b>Gamma</b>	Sets a gradation curve between video input and output signal.	

Item	Description
<b>Color Gamut</b>	Selects the range of colors to display. <b>Standard:</b> Displays the original colors of an input signal regardless of the display features. <b>Wide:</b> Sets to use the rich colors of the display.

Available options may differ depending on the input signal or video mode, etc.

### Expert Control

Item	Description
<b>Dynamic Contrast</b>	Adjusts the contrast to keep it at the best level for the brightness of the screen.
<b>Super Resolution</b>	Improves blurry and unclear parts in the picture to make the picture more vivid.
<b>Color Gamut</b>	Selects the range of colors to display. <b>Standard:</b> Displays the original colors of an input signal regardless of the display features. <b>Wide:</b> Sets to use the rich colors of the display.
<b>Edge Enhancer</b>	Provides much sharper and clearer edges to the picture.
<b>xvYCC</b>	Displays much richer colors.
<b>Color Filter</b>	Accurately adjusts color and tint by filtering a specific color area of RGB space.
<b>Gamma</b>	Sets a gradation curve between video input and output signal.
<b>Expert Pattern</b>	Patterns used for expert adjustment.
<b>White Balance</b>	Adjusts white balance. Detailed adjustment is possible as shown below. <b>Color Temperature: Select Warm, Cool, Medium or Natural.</b> a. Method: 2 points Pattern: Inner, Outer Contrast Red/Green/Blue, Brightness Red/Green/Blue: Adjustable range -50 - +50. b. Method: 20 point IRE Pattern: Inner, Outer Institute of Radio Engineers (IRE) is the unit indicating the size of a video signal and can be set to 5, 10, 15, ... 100. You can fine-tune for each setting as shown below. Luminance: If you set up luminance for 100 IRE, a luminance value satisfying each gamma is automatically calculated for each step from 10 IRE to 90 IRE. Red/Green/Blue: The adjustment range is -50 - +50.

Item	Description
<b>Color Management system</b>	Adjusts Red/Green/Blue/Cyan/Magenta/Yellow colors. Allows an expert to adjust the tint using a test pattern. Six colors (Red/Green/Blue/Cyan/Magenta/Yellow) can be selectively adjusted without affecting other colors. You may not see colors change on a normal picture even after adjustment. Chroma Red/Green/Blue/Yellow/Cyan/Magenta, Tone Red/Green/Blue/Yellow/Cyan, Magenta: The adjustment range is -30 - +30 each.

Available options may differ depending on the input signal or video mode, etc.

**Picture Option**

Item	Description
<b>Noise Reduction</b>	Removes noises in the picture.
<b>MPEG Noise Reduction</b>	Reduces the noise produced while creating digital video signals.
<b>Black Level</b>	Compensates the brightness and contrast of a screen to balance with the black level of the video input.
<b>Real Cinema</b>	Provides optimal picture quality for watching a movie.
<b>TruMotion</b>	Makes the picture look smooth by compensating it.
	<b>Mode</b>
	<b>Smooth</b> The De-Judder value is set to 3.
	<b>Clear</b> The De-Judder value is set to 7.
<b>User</b> You can set this function manually. <b>De-Judder:</b> Adjusts the juddering on a screen.	

\* If the video signal is 60 Hz, TruMotion may not work.

## SOUND Settings

- 1 Press the **SETTINGS** button.
  - 2 Use the  $\wedge$  or  $\vee$  button to select **SOUND** and press the **OK** button.
  - 3 Use the  $\wedge$ ,  $\vee$ ,  $\lt$  or  $\gt$  button to set up the desired item and press the **OK** button.
- To return to the previous menu, press the  $\rightarrow$  button.

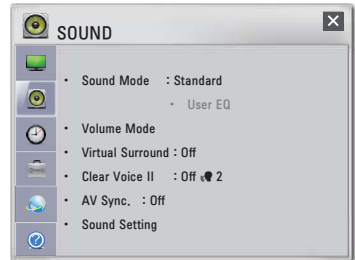

The available sound settings are described as follows.

Item	Description	
<b>Sound Mode</b>	Optimizes Laser Display audio to the selected sound mode.	
	<b>Mode</b>	
	<b>Standard</b>	Suitable for all types of video.
	<b>Music / Cinema / Sport / Game</b>	Sets audio optimized for a specific genre.
	<b>Vivid</b>	Delivers distinct voices with rich bass and clear, high-pitched sounds.
<b>User Setting</b>	Adjusts the volume to a level of your choice using the User EQ.	
<b>User EQ</b>	Allows you to adjust the treble and bass sound. Sets Sound Mode at User Setting first.	
	<b>Mode</b>	
	<b>100 Hz / 300 Hz / 1 kHz / 3 kHz / 10 kHz</b>	Sets EQ by manual adjustment of sound bands.
	<b>Reset</b>	Resets the equalizer value changed by the user.
<b>Volume Mode</b>	Sets the Laser Display volume.	
<b>Virtual Surround</b>	Provides realistic stereo sound.	
<b>Clear Voice II</b>	Makes the voice from the Laser Display crisp and clear.	

Item	Description	
<b>AV Sync.</b>	Allows you to manually adjust picture and audio when they are not synced.	
<b>Sound Setting</b>	Balances the sound.	
	<b>Mode</b>	
	<b>ARC Mode</b>	<p>External audio devices can be connected via High-Speed HDMI® cable without an extra optical audio cable to output SPDIF. It interfaces with SIMPLINK.</p> <p>For an external device that supports ARC (Audio Return Channel), connect it to the HDMI(ARC) port.</p>
	<b>Balance</b>	Adjusts left/right audio balance.
	<b>Laser Display Speaker</b>	When listening via speakers on external audio devices connected to the Laser display, such as home theatre equipment, the Laser display speaker may be turned off. If there is a home theatre device connected to SIMPLINK, setting the Laser display Speaker to Off will turn the home theatre equipment on automatically.
<b>Digital Sound Out</b>	Sets up Digital Sound Output.	

## TIME Settings

- 1 Press the **SETTINGS** button.
  - 2 Use the  $\wedge$  or  $\vee$  button to select **TIME** and press the **OK** button.
  - 3 Use the  $\wedge$ ,  $\vee$ ,  $\lt$  or  $\gt$  button to set up the desired item and press the **OK** button.
- To return to the previous menu, press the  $\curvearrowright$  button.

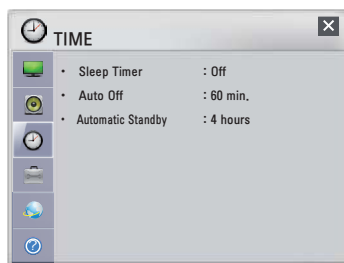

The available time settings are described as follows.

Item	Description
<b>Sleep Timer</b>	Sets the Laser Display to be turned off at the specified time.
<b>Auto Off</b>	If there is no signal, the Laser Display automatically turns off after the preset time has elapsed.
<b>Automatic Standby</b>	Turn off the Laser Display at the preset time if there is no input within the given period of time.

# OPTION Settings

- 1 Press the **SETTINGS** button.
  - 2 Use the  $\wedge$  or  $\vee$  button to select **OPTION** and press the **OK** button.
  - 3 Use the  $\wedge$ ,  $\vee$ ,  $\lt$  or  $\gt$  button to set up the desired item and press the **OK** button.
- To return to the previous menu, press the  $\curvearrowright$  button.



The available option settings are described as follows.

Item	Description	
<b>Language</b>	Selects the desired language.	
<b>Caption</b>	If the language for the AV input is set to Korean, captions can be turned on or off.	
<b>Pointer</b>	Customizes the pointer settings.	
	<b>Speed</b>	Sets the move speed of a pointer.
	<b>Shape</b>	Selects the pointer shape.
	<b>Size</b>	Selects the pointer size.
	<b>Alignment</b>	Turn on this option. While using the Magic remote control, if the pointing position of the remote control and the actual pointer position do not match, shake the Magic remote control to the left and right. The pointer automatically moves to the center of screen to match the movement.
<b>Set ID</b>	The range of the set ID is 1 - 99. Only the saved set ID takes effect.	
<b>PJT Mode</b>	Turns the projected image upside down or flips it horizontally.	
<b>Edge Adj</b>	Compensates for the trapezoidal image shape created when projecting an image from an angle not perpendicular to the screen.	
<b>Blank Image</b>	Selects the background for blank image.	
<b>Auto Power</b>	Makes the Laser Display turn on automatically when the power cord is connected.	
	<b>Item</b>	
	<b>On</b>	When the power cord is connected to the Laser Display, it turns on automatically.
	<b>Off</b>	When the power cord is connected to the Laser Display, it goes into standby mode.
<b>Power Sound</b>	The alert sound plays upon turning on/off the power.	

Item	Description
<b>High Altitude</b>	<p>If the Laser Display is used at an altitude higher than 1200 meters, turn this option on.</p> <p>When High Altitude is not enabled, the Laser Display may overheat or its protection function may be activated. If this happens, turn the Laser Display off and then on again after waiting for several minutes.</p>
<b>Test Pattern</b>	<p>You can run this option when installing the Laser Display to adjust the screen size and focus.</p> <div data-bbox="303 427 1005 536" style="border: 1px solid black; border-radius: 10px; padding: 10px;"><p> <b>NOTE</b></p><ul style="list-style-type: none"><li>• While you use the Test Pattern option, the keys on the control panel do not work.</li></ul></div>
<b>Auto Input Search</b>	<p>Automatically searches for and displays the input signal type when it is received. It is available only with external inputs (RGB, HDMI, AV and Component).</p>



Item	Description
<b>Eye Care Sensor</b>	<p data-bbox="262 204 639 229">Change the eye care sensor settings.</p> <div data-bbox="262 256 967 1342" style="border: 1px solid black; border-radius: 10px; padding: 10px;"> <p data-bbox="295 261 415 300"><b>!</b> <b>NOTE</b></p> <ul data-bbox="295 316 956 1326" style="list-style-type: none"> <li data-bbox="295 316 956 395">• If a user gets closer to the product while the eye care sensor is turned on, the sensor detects it and reduces the light intensity automatically to protect the user's eyes.</li> <li data-bbox="295 395 956 443">• The eye care sensor does not work when the test pattern or the Edge Adj function is used.</li> <li data-bbox="295 443 956 523">• The eye care sensor may not work properly if the sensor is blocked by an object or placed in an area where direct sunlight or wind comes in contact with it.</li> <li data-bbox="295 523 956 571">• The eye care sensor is more sensitive to horizontal movement than vertical movement.</li> <li data-bbox="295 571 956 619">• The detection range may vary depending on the installation environment, temperature, or brightness.</li> <li data-bbox="295 619 956 667">• The eye care sensor detects heat sources, so it may respond to animals moving or heaters placed close by.</li> <li data-bbox="295 667 956 746">• The eye care sensor detects heat sources, so it may not be able to detect the user if there is no exposed skin or if an obstacle is placed between the sensor and the user.</li> <li data-bbox="295 746 956 794">• It may not be able to detect the user if there is no movement for a long time.</li> <li data-bbox="295 794 956 842">• The eye care sensor may also detect a small animal (e.g. cat or dog) or rotating heater.</li> <li data-bbox="295 842 956 922">• The eye care sensor may not be able to detect when room temperature rises to skin temperature (30 °C or more in summer) or when a user is wearing thick clothes or standing with their back to the sensor.</li> <li data-bbox="295 922 956 970">• The detection area may change if curtains or plants move in the wind. Detection also depends on variable conditions such as clothing and temperature.</li> <li data-bbox="295 970 956 1018">• The eye care sensor works normally even if the product is wobbling.</li> <li data-bbox="295 1018 956 1066">• A wired/wireless communication device may cause the sensor to malfunction.</li> <li data-bbox="295 1066 956 1114">• The eye care sensor may not work for a maximum of one minute after it is turned on.</li> <li data-bbox="295 1114 956 1161">• When a user moves away from the unit, the light intensity is recovered within three seconds.</li> <li data-bbox="295 1161 956 1209">• The eye care sensor may be disabled when energy saving is turned on.</li> </ul> </div>

Item	Description	
<b>Eye Care Sensor</b>	<b>Item</b>	
	<b>Sensor</b>	Turn the eye care sensor on/off.
	<b>Sensitivity</b>	Set the sensitivity of the eye care sensor. The default is medium, but set it higher for better sensitivity or lower for less sensitivity.
<b>Balloon Help</b>	Enables/disables the balloon help.	
<b>Initial Setting</b>	Resets all the Laser Display settings to the factory settings.	

## NETWORK Settings

- 1 Press the **SETTINGS** button.
  - 2 Use the  $\wedge$  or  $\vee$  button to select **NETWORK** and press the **OK** button.
  - 3 Use the  $\wedge$ ,  $\vee$ ,  $\lt$  or  $\gt$  button to set up the desired item and press the **OK** button.
- To return to the previous menu, press the  $\curvearrowright$  button.

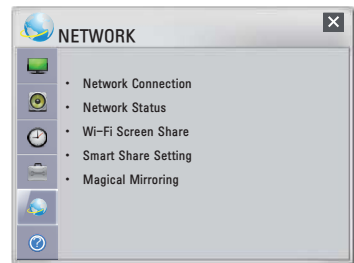

The available network settings are described as follows.

Item	Description
<b>Network Connection</b>	Connects the network.
<b>Network status</b>	Checks the network status.
<b>Wi-Fi Screen Share</b>	Wi-Fi Screen Share supports the wired/wireless connection technology, such as Wi-Fi Direct and WiDi. You can share the file and screen of the devices connected by the Wi-Fi Screen Share on the SmartShare.

Item	Description	
<b>Smart Share Setting</b>	Changes the settings for SmartShare.	
	<b>Item</b>	
	<b>Laser Display Name</b>	Changes the name that appears when searching for the Laser Display from other devices.
	<b>Share My Laser Display</b>	Allows / prevents connection to the Laser Display from other devices. Turns DMR (Digital Media Renderer) connection on/off.
	<b>Auto Play on Recieve</b>	Accepts / rejects content transferred from other devices.
<b>DivX(R) VOD</b>	Registers or releases DivX. Checks DivX Registration Code for playing DivX-protected videos. Register at <a href="http://vod.divx.com">http://vod.divx.com</a> . Uses Registration Code to rent or purchase movies at <a href="http://www.divx.com/vod">www.divx.com/vod</a> . <ul style="list-style-type: none"> <li>• Rented/purchased DivX files cannot be played if the DivX Registration Code of a different device is used. Use only the DivX Registration Code granted to this device.</li> <li>• Converted files not conforming to the DivX Codec Standard may not play or may produce abnormal images and sound.</li> </ul>	
<b>Magical Mirroring</b>	Transmits wirelessly and projects the screen of a network-connected laptop (PC) to a Laser Display.	

# CONNECTING EXTERNAL DEVICES

You can connect various external devices to Laser Display.

**Computer/Laptop**



**DVD**



**Video**



**Digital Device**

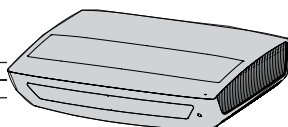

**USB**



HDMI - Page 69  
Component - Page 72  
Input(AV) - Page 72  
RGB - Page 70  
USB Devices - Page 39  
Headphones - Page 73

**Headphones**



**Game Console**



## Connecting an HD Receiver, DVD Player, or VCR

Connect an HD receiver, DVD, or VCR player to Laser Display and select an appropriate input mode.

### ! NOTE

- Audio Return Channel (ARC)
- An external audio device that supports SIMPLINK and ARC must be connected using HDMI input 1 (ARC) port.
- When connected with a high-speed HDMI® cable, the external audio device supporting ARC outputs optical SPDIF works with the SimpLink function without additional optical audio cable.

### HDMI connection

With an HDMI cable, you can enjoy high quality picture and sound. Connect the HDMI input port of Laser Display to the HDMI output port.

Press the INPUT button on the remote control to select HDMI. You can use any HDMI input port for connection.

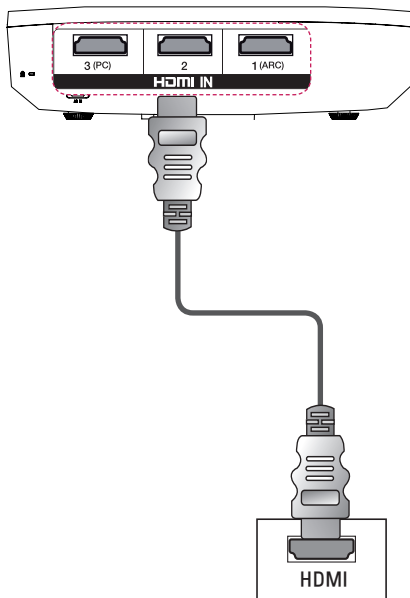

## HDMI to DVI Connection

Use the HDMI to DVI cable to connect the HDMI input port of the Laser Display to the DVI output port.

Press the INPUT button on the remote control to select HDMI. You can select any HDMI input port for connection.

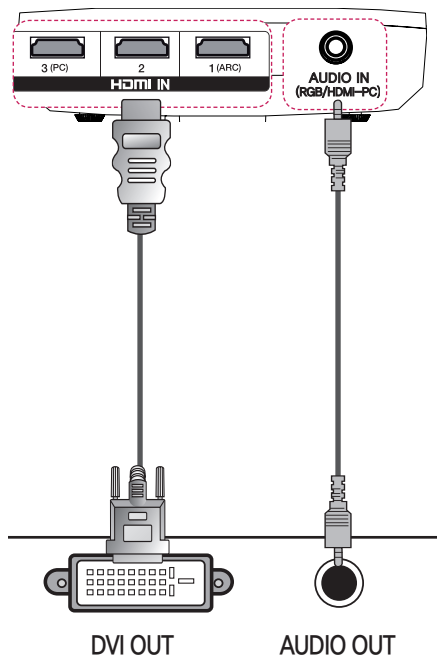

## Connecting a PC

This Laser Display supports the Plug & Play function. Your PC will automatically detect the Laser Display and requires no driver installation.

### RGB Connection

Connect the PC output and the PC video input port of the Laser Display with an RGB cable.

Connect the Laser Display's video (PC) input port to the RGB output port.

To output the audio, connect the PC to the Laser Display using an optional audio cable.

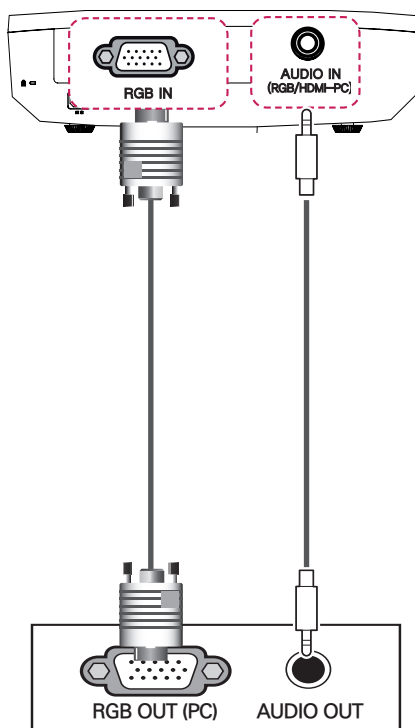

## HDMI to DVI Connection

Use the HDMI to DVI cable to connect the HDMI input port of the Laser Display to the DVI output port.

Press the INPUT button on the remote control to select HDMI. You can use any HDMI input port for connection.

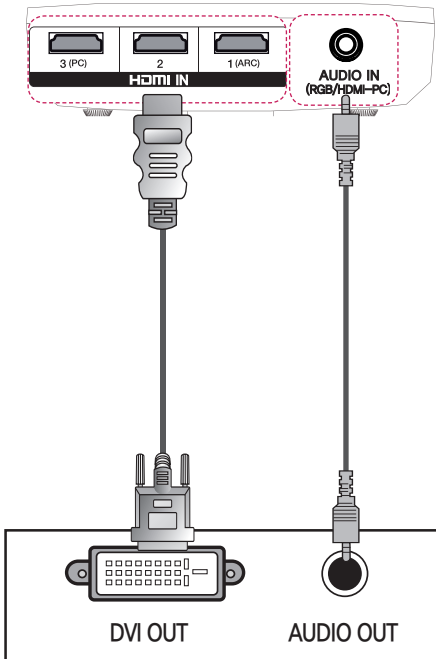

## RGB to DVI Connection

Connect the Laser Display's video (PC) input port to the DVI output port.

To output the audio, connect the PC to the Laser Display using an optional audio cable.



## Connecting External Devices

### AV Connection

Connect the output ports of an external device and the AV input ports of the Laser Display using AV connection cables. Press the INPUT button on the remote control to select AV.

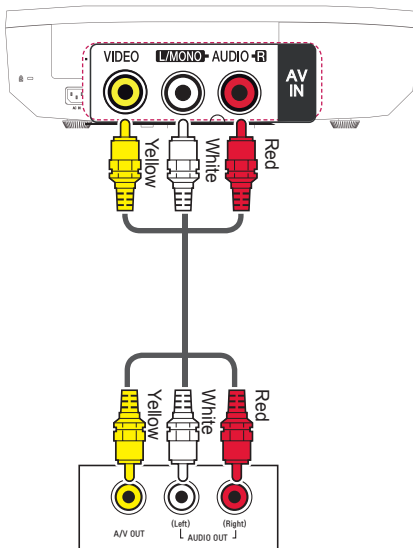

## Component Connection

You can enjoy more vivid images when you connect an external device with a component port to the component input port of the Laser Display. Press the INPUT button on the remote control to select Component.

The output jack Y, PB or PR of the DVD player may be marked as Y, B-Y, R-Y/Y, Cb, Cr/Y, Pb or Pr depending on the model.

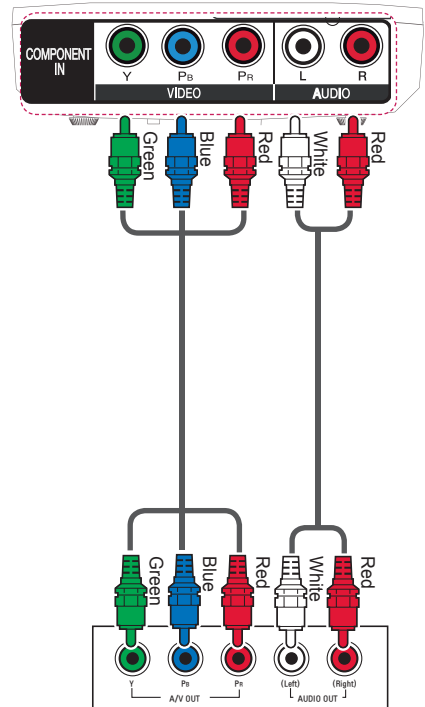



## Connecting Headphones

### Headphone Connection

You can listen to the sound from Laser Display using headphones.

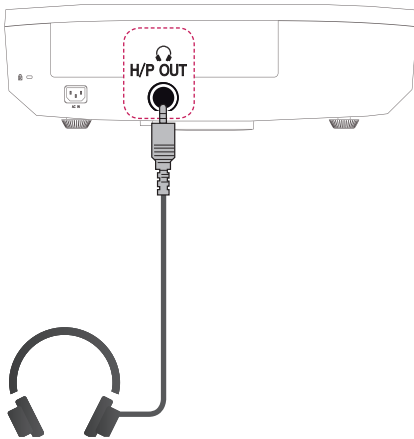

## Connecting a Laptop

You can connect the Laser Display to a laptop to use various functions.

### RGB Connection

You can connect it to the video (PC) input port of the Laser Display.

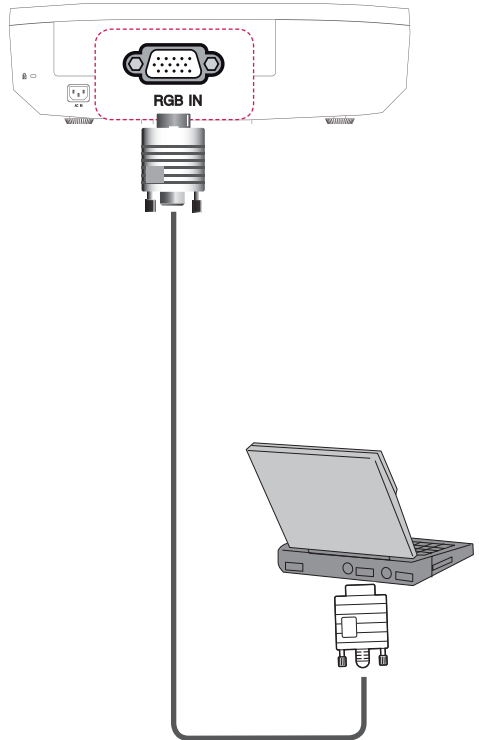

## **HDMI connection**

Connect the HDMI input port of Laser Display to the HDMI output port.

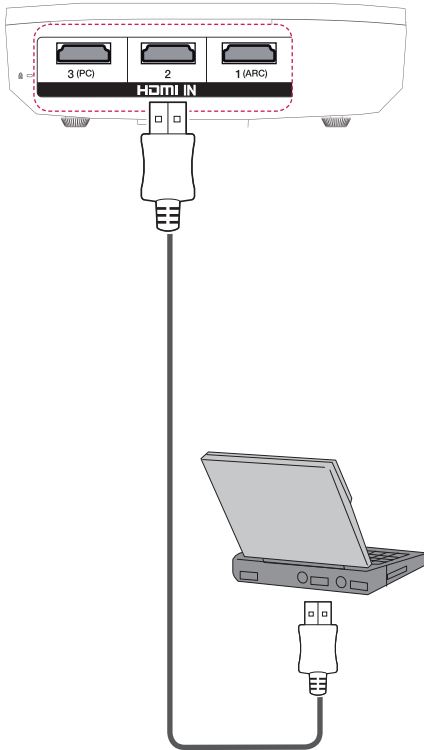

The table below shows examples of switching the output. For more information, refer to the "External Output", "Connecting to an External Monitor", or similar sections of the owner's manual of your computer.

Brand	Switching Output
NEC	[Fn]+[F3]
Panasonic	[Fn]+[F3]
Toshiba	[Fn]+[F5]
IBM	[Fn]+[F7]
Sony	[Fn]+[F7]
Fujitsu	[Fn]+[F10]
LG	[Fn]+[F7]
Samsung	[Fn]+[F4]
Macintosh	Adjust the control panel to enable mirroring after start-up.

## Using the TRIGGER Port

### Motor screen connection

Connect an external device (e.g., roll screen) to the TRIGGER (12V) port using a mini jack cable (3.5 mm).

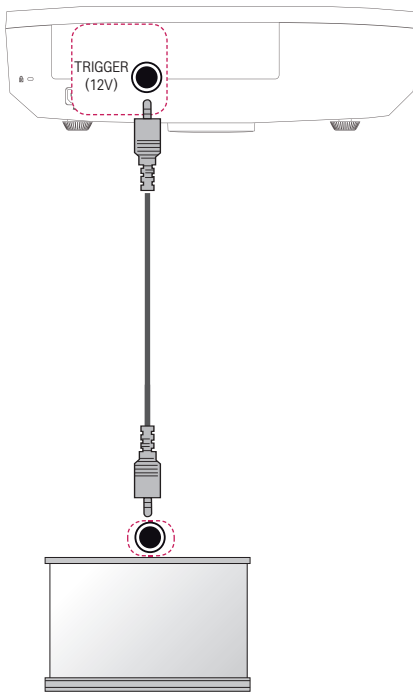

### **!** NOTE

- Do not plug an earphone jack into the TRIGGER (12V) port. This may cause damage to the earphones.
- When a device is connected to the TRIGGER port, turning the power on outputs voltage from the port; turning the power off stops outputting.



Communication Parameter Setup  
 Baud Rate: 9600 bps(UART)  
 Data Length: 8 bit  
 Parity: none  
 Stop bit: 1 bit  
 Flow Control: none  
 Communication code: ASCII code

# Communication Protocol

## 1. Transmission

[Command1] [Command2] [ ] [Set ID] [ ]  
 [Data] [Cr]

[Command1]: The first command to control the Laser Display (k, j, x, m, n, ASCII code, 1 Character)

[Command2]: The second command to control the Laser Display (ASCII code, 1 character)

[Set ID]: You can adjust the set ID to choose desired monitor ID number in option menu. Adjustment range is 1 to 99. When selecting Set ID '0', every connected set is controlled. Set ID is indicated as decimal (1 to 99) on menu and as Hexa decimal (0x0 to 0x63) on transmission/receiving protocol.

[Data]: To transmit command data (hexadecimal).  
 Transmit 'FF' data to read status of command.

[Cr]: Carriage Return  
 It corresponds to ASCII code '0x0D'.

[ ] : ASCII code 'space (0x20)

## 2. OK Acknowledgement

[Command2] [ ] [Set ID] [ ] [OK] [Data] [x]

\* The set transmits ACK (acknowledgement) based on this format when receiving normal data. At this time, if the data is data read mode, it indicates present status data. If the data is data write mode, it returns the data of the PC computer.

## 3. Error Acknowledgement

[Command2] [ ] [Set ID] [ ] [NG] [Data] [x]

If a set receives an abnormal piece of data such as a non-supported function or there is a communication error, it returns ACK in the above format.

Data [00]: illegal code  
 (This command is not supported.)

## Data Structure

10	16	10	16	10	16	10	16	10	16	10	16	10	16	10	16	10	16		
0	00																		
1	01	11	0B	21	15	31	1F	41	29	51	33	61	3D	71	47	81	51	91	5B
2	02	12	0C	22	16	32	20	42	2A	52	34	62	3E	72	48	82	52	92	5C
3	03	13	0D	23	17	33	21	43	2B	53	35	63	3F	73	49	83	53	93	5D
4	04	14	0E	24	18	34	22	44	2C	54	36	64	40	74	4A	84	54	94	5E
5	05	15	0F	25	19	35	23	45	2D	55	37	65	41	75	4B	85	55	95	5F
6	06	16	10	26	1A	36	24	46	2E	56	38	66	42	76	4C	86	56	96	60
7	07	17	11	27	1B	37	25	47	2F	57	39	67	43	77	4D	87	57	97	61
8	08	18	12	28	1C	38	26	48	30	58	3A	68	44	78	4E	88	58	98	62
9	09	19	13	29	1D	39	27	49	31	59	3B	69	45	79	4F	89	59	99	63
10	0A	20	14	30	1E	40	28	50	32	60	3C	70	46	80	50	90	5A	100	64

**Command Reference List**

	<b>Command 1</b>	<b>Command 2</b>	<b>Data (Hexadecimal)</b>
<b>01. POWER</b>	k	a	00 - 01
<b>02. Aspect Ratio</b>	k	c	*
<b>03. Blank Image</b>	k	d	00 - 01
<b>04. Contrast</b>	k	g	00 - 64
<b>05. Brightness</b>	k	h	00 - 64
<b>06. Color</b>	k	i	00 - 64
<b>07. Tint</b>	k	j	00 - 64
<b>08. Sharpness</b>	k	k	00 - 32
<b>09. OSD Control</b>	k	l	00 - 01
<b>10. Key Lock</b>	k	m	00 - 01
<b>11. Color Temperature</b>	k	u	00 - 04 (excluding 03)
<b>12. Black Level</b>	n	m	00 - 01
<b>13. Energy Saving</b>	n	p	00 - 02
<b>14. Auto configuration</b>	j	u	01
<b>15. Input</b>	x	b	*
<b>16. Key</b>	m	c	Key Code
<b>17. Picture Mode</b>	n	s	00 - 05
<b>18. Mute</b>	k	e	00 - 01
<b>19. Volume</b>	k	f	00 - 64

\* For more information about the data(\*), refer to next page.

\* When playing a video or photo file stored on a storage media (USB memory stick or HDD, etc.) that is connected through USB, all commands are disabled, other than Power (ka), Key (mc) and Blank Image. If a command cannot be used in a specific menu or input state, it is processed as NG.

### 01. Power (Command: ka)

⇒ Powers the set on/off.

#### Transmission

```
[k][a][Set ID][Data][Cr]
```

Data 00: Power Off  
01: Power On

#### Ack

```
[a][Set ID][OK][Data][x]
```

Data 00: Power Off  
01: Power On

⇒ To Show Power On (Only working when the Laser display is turned on)

#### Transmission

```
[k][a][Set ID][FF][Cr]
```

#### Ack

```
[a][Set ID][OK][Data][x]
```

Data 01: Power On

⇒ As with other functions, if data is transmitted as '0xFF' in the above format, the current status of each function is returned as a feedback in Ack data.

### 02. Aspect Ratio (Command: kc)

⇒ Adjusts the aspect ratio.

#### Transmission

```
[k][c][Set ID][Data][Cr]
```

Data 01: 4:3  
02: 16:9  
04: Zoom  
06: Set By Program  
09: Just scan  
10 - 1f: Cinema Zoom 1 - 16

#### Ack

```
[c][Set ID][OK][Data][x]
```

Data 01: 4:3  
02: 16:9  
04: Zoom  
06: Set By Program  
09: Just scan  
10 - 1f: Cinema Zoom 1 - 16

### 03. Blank Image (Command: kd)

⇒ Enables/disables the blank image.

#### Transmission

```
[k][d][Set ID][Data][Cr]
```

Data 00: Screen Mute Off (picture on)  
01: Screen Mute On (picture off)

#### Ack

```
[d][Set ID][OK][Data][x]
```

Data 00: Screen Mute Off (picture on)  
01: Screen Mute On (picture off)

#### 04. Contrast (Command: kg)

⇒ Adjusts the screen contrast.

Transmission

```
[k][g][Set ID][Data][Cr]
```

Data Min: 0H - Max: 64H  
(\* Transmitted in hexadecimal code)  
\* See the data structure.

Ack

```
[g][Set ID][OK][Data][x]
```

Data Min: 0H - Max: 64H

#### 05. Brightness (Command: kh)

⇒ Adjusts the screen brightness.

Transmission

```
[k][h][Set ID][Data][Cr]
```

Data Min: 0H - Max: 64H  
(\* Transmitted in hexadecimal code)  
\* See the data structure.

Ack

```
[h][Set ID][OK][Data][x]
```

Data Min: 0H - Max: 64H

#### 06. Color (Command: ki)

⇒ Adjusts the screen color.

Transmission

```
[k][i][Set ID][Data][Cr]
```

Data Min: 0H - Max: 64H  
(\* Transmitted in hexadecimal code)  
\* See the data structure.

Ack

```
[i][Set ID][OK][Data][x]
```

Data Min: 0H - Max: 64H

#### 07. Tint (Command: kj)

⇒ Adjusts the screen tint.

Transmission

```
[k][j][Set ID][Data][Cr]
```

Data Red: 0H - Green: 64H  
(\* Transmitted in hexadecimal code)  
\* See the data structure.

Ack

```
[j][Set ID][OK][Data][x]
```

Data Red: 0H - Green: 64H



**08. Sharpness (Command: kk)**

⇒ Adjusts screen sharpness.

Transmission

```
[k][k][Set ID][Data][Cr]
```

Data Min: 0H - Max: 32H  
(\* Transmitted in hexadecimal code)

\* See the data structure.

Ack

```
[k][Set ID][OK][Data][x]
```

Data Min: 0H - Max: 32H

**09. OSD Control (Command: kl)**

⇒ Selects OSD On/Off.

Transmission

```
[k][l][Set ID][Data][Cr]
```

Data 00: OSD selection mode off  
01: OSD selection mode on

Ack

```
[l][Set ID][OK][Data][x]
```

Data 00: OSD selection mode off  
01: OSD selection mode on

**10. Key Lock (Command: km)**

⇒ To Set the function of locking the remote control and front panel control on the Laser Display.

Transmission

```
[k][m][Set ID][Data][Cr]
```

Data 00: Disables the key lock.  
01: Enables the key lock.

Ack

```
[m][Set ID][OK][Data][x]
```

Data 00: Disables the key lock.  
01: Enables the key lock.

- ▶ This function is configured when the keys on the remote control or control panel are not used. If the unit is fully discharged after its power plug is pulled out of a wall outlet, the LOCK function is cleared.
- ▶ If the unit is in the key lock standby mode, the Laser Display will not respond to the power button on the remote control or control panel.

**11. Color Temperature (Command: ku)**

⇒ Adjusts the value of color temperature.

Transmission

```
[k][u][Set ID][Data][Cr]
```

Data 00: Medium 01: Cool  
02: Warm 04: Medium  
(\* Transmitted in hexadecimal code)  
\*Data 03 is not used.

Ack

```
[u][Set ID][OK][Data][x]
```

Data 00: Medium 01: Cool  
02: Warm 04: Medium

**12. Black Level (Command: nm)**

⇒ Adjusts the value of black level.

Transmission

```
[n][m][Set ID][Data][Cr]
```

Data 00: Low      01: High  
 (\* Transmitted in hexadecimal code)

Ack

```
[m][Set ID][OK][Data][x]
```

Data 00: Low      01: High

**13. Energy Saving (Command: np)**

⇒ Sets the energy saving mode.

Transmission

```
[n][p][Set ID][Data][Cr]
```

Data 00: Minimum  
 Data 01: Medium  
 Data 02: Maximum  
 (\* Transmitted in hexadecimal code)

Ack

```
[p][Set ID][OK][Data][x]
```

Data 00: Minimum  
 Data 01: Medium  
 Data 02: Maximum

**14. Auto Configure (Command: ju)**

⇒ Optimizes the screen automatically in PC input mode.

Transmission

```
[j][u][Set ID][Data][Cr]
```

Data 01: To set  
 (\* Transmitted in hexadecimal code)

Ack

```
[u][Set ID][OK][Data][x]
```

Data 01: To set

**15. Input Select (Command: xb)**

⇒ Selects the input signal.

Transmission

```
[x][b][Set ID][Data][Cr]
```

Data 20: AV                      40: Component  
 60: RGB-PC                    90: HDMI 1  
 91: HDMI 2                    92: HDMI 3  
 (\* Transmitted in hexadecimal code)

Ack

```
[b][Set ID][OK][Data][x]
```

Data 20: AV                      40: Component  
 60: RGB-PC                    90: HDMI 1  
 91: HDMI 2                    92: HDMI 3

## 16. Key (Command: mc)

⇒ Sends a key code of the IR remote control.

### Transmission

```
[m][c][Set ID][Data][Cr]
```

Data Key Code See Page 84  
(\* Transmitted in hexadecimal code)

### Ack

```
[c] [Set ID][OK][Data][x]
```

Data Key Code

## 17. Picture Mode (Command: ns)

⇒ Sets the picture mode.

### Transmission

```
[n][s][Set ID][Data][Cr]
```

Data	00: Vivid	01: Standard
	02: Cinema	03: Game
	04: Expert1	
	05: Expert2	

(\* Transmitted in hexadecimal code)

### Ack

```
[b] [Set ID][OK][Data][x]
```

Data	00: Vivid	01: Standard
	02: Cinema	03: Game
	04: Expert1	
	05: Expert2	

(\* Transmitted in hexadecimal code)

## 18. Mute (Command: ke)

⇒ Enables/disables the mute function.

### Transmission

```
[k][e][Set ID][Data][Cr]
```

Data 00: Mute On (volume off)  
01: Mute Off (volume on)

### Ack

```
[e] [Set ID][OK][Data][x]
```

Data 00: Mute On (volume off)  
01: Mute Off (volume on)

## 19. Volume (Command: kf)

⇒ Controls the volume.

### Transmission

```
[k][f][Set ID][Data][Cr]
```

Data Min: 0H (Vol 0) - Max: 64H (Vol 100)  
(\* Transmitted in hexadecimal code)  
\* See the data structure.

### Ack

```
[f] [Set ID][OK][Data][x]
```

Data Min: 0H (Vol 0) - Max: 64H (Vol 100)

**<Key Code>**

Key Name	Key Code	Key Name	Key Code
^	0x40	USB	0x7C
v	0x41	MUTE	0x09
>	0x06	PAGE ^	0x00
<	0x07	PAGE v	0x01
POWER	0x08	STILL	0xBC
INPUT	0x0B	EXIT	0x5B
SETTINGS	0x43	0	0x10
↶ (BACK)	0x28	1	0x11
OK ●	0x44	2	0x12
ENERGY SAVING	0x95	3	0x13
RATIO	0x79	4	0x14
BLANK	0x84	5	0x15
AUTO	0x92	6	0x16
AV MODE	0x30	7	0x17
VOL+	0x02	8	0x18
VOL -	0x03	9	0x19
RED	0x72	▶▶	0x8E
GREEN	0x71	◀◀	0x8F
YELLOW	0x63	▶	0xB0
BLUE	0x61	■	0xB1
SIMPLINK	0x7E		0xBA
EDGE ADJ	0xA4	SLEEP	0x0E
Q.MENU	0x45	HELP	0x81

# MAINTENANCE

Clean your Laser Display to keep it in optimal condition.

## Cleaning

### Cleaning Cover Glass

To remove dust or stains on the cover glass, use an air spray or use a swab or soft cloth to wipe the glass gently.

### Cleaning the Laser Display Case

To clean the case of Laser Display, first unplug the power cord.

To remove dust or stains, use only a dry, lint-free, soft cloth to polish the lens.

Do not use alcohol, benzene, thinners or other chemicals, which may damage the case.

## Updating the Software

When a software update is required, run the software update to obtain the latest software version.

You can manually check for and download any software updates.

- 1** Press the **SETTINGS** button.
- 2** Select **SUPPORT** and go to **Software Update**.

Item	Description
<b>Software Update</b>	Turn on this option. When an update file is found, it is downloaded automatically. When the update file is completely downloaded, a software update window appears.
<b>Check Update Version</b>	If an update file of a higher version exists after checking the latest update version, you can proceed with the update manually.
<b>Product/Service Info</b>	Shows the product related information.
<b>Self Diagnosis</b>	Performs the self-diagnosis function. This function suggests corrective actions for the problems that might occur while using this product.

- The update service to get the latest version is provided through an Internet connection.
- If the software is not updated, some functions may not work well.

# SPECIFICATIONS

MODELS	HECTO (HECTO-GL)	
Resolution (Pixel)	1920 (Horizontal) × 1080 (Vertical)	
Aspect ratio	16:9 (Horizontal:Vertical)	
Panel size (mm)	14.515 (Horizontal), 8.1648 (Vertical)	
Projection distance (Video size)	0.53 m (2.54 m)	
Ratio of upward projection	123 %	
POWER	AC 100 - 240 V, 50/60 Hz	
Audio output	10 W + 10 W	
Video input	NTSC M / PAL-B, D, G, H, I / PAL M / PAL N / PAL 60 / SECAM	
Height (mm)	145 (excluding foot), 156.1 (including foot)	
Width (mm)	546.3	
Depth (mm)	406.6	
Weight (kg)	14	
USB Device	5 V, 0.5 A (Max.)	
Operation environment	Temperature	
	Operation	0 °C - 40 °C
	Storage	-20 °C - 60 °C
	Relative humidity	
	Operation	0 % - 80 %
	Storage	0 % - 85 %

**Supported Monitor Display**

Resolution	Horizontal Frequency (kHz)	Vertical Frequency (Hz)
720 x 400	31.469	70.08
640 x 480	31.469	59.94
800 x 600	37.879	60.31
1024 x 768	48.363	60.00
1152 x 864	54.348	60.053
1360 x 768	47.712	60.015
1280 x 1024	63.981	60.02
1920 x 1080	67.5	60

- If an invalid signal is input into the product, it will not be displayed properly on the screen or a message such as “No Signal” or “Invalid Mode” will be displayed.
- The product supports the DDC1/2B type as the Plug & Play function (Auto-recognition of PC monitor).
- PC synchronization signal types supported: Separate type synchronization.
- 1920 x 1080 is recommended as the best picture quality in the PC mode.

**Supported HDMI/DVI-DTV Mode**

Resolution	Horizontal Frequency (kHz)	Vertical Frequency (Hz)
480p	31.5	60
	31.469	59.94
576p	31.25	50
720p	37.5	50
	44.96	59.94
	45	60
1080i	28.125	50
	33.716	59.94
	33.75	60
1080p	56.25	50
	67.432	59.94
	67.5	60
	67.432	59.939
	27	24
	26.97	23.976
	28.125	25
	33.75	30
	33.71	29.97



**Component Port Connection**

Signal	Component
480i / 576i	o
480p / 576p	o
720p/1080i	o
1080p	o

**Open Source software Information**

To obtain the source code under GPL, LGPL, MPL and other open source licenses, that is contained in this product, please visit <http://opensource.lge.com> . In addition to the source code, all referred license terms, warranty disclaimers and copyright notices are available for download.

LG Electronics will also provide open source code to you on CD-ROM for a charge covering the cost of performing such distribution (such as the cost of media, shipping and handling) upon email request to [opensource@lge.com](mailto:opensource@lge.com). This offer is valid for three (3) years from the date on which you purchased the product.



The model and serial number of the Laser Display are located on the back or on the side of the Laser Display. Record them below should you ever need service.

MODEL \_\_\_\_\_

SERIAL \_\_\_\_\_