

Projector

V311X/V311W/V281W

User's Manual

- DLP and BrilliantColor are trademarks of Texas Instruments.
- IBM is a trademark or registered trademark of International Business Machines Corporation.
- Apple, Mac, Mac OS, and MacBook are trademarks of Apple Inc., registered in the U.S. and other countries.
- Microsoft, Windows, Windows Vista, Internet Explorer, .NET Framework and PowerPoint are either a registered trademark or trademark of Microsoft Corporation in the United States and/or other countries.
- MicroSaver is a registered trademark of Kensington Computer Products Group, a division of ACCO Brands.
- Virtual Remote Tool uses WinI2C/DDC library, © Nicomsoft Ltd.
- HDMI, the HDMI Logo and High-Definition Multimedia Interface are trademarks or registered trademarks of HDMI Licensing LLC.



- NVIDIA is a trademark or registered trademark of NVIDIA Corporation in the United States and/or other countries.
- Blu-ray is a trademark of Blu-ray Disc Association.
- CRESTRON and ROOMVIEW are registered trademarks of Crestron Electronics, Inc. in the United States and other countries.
- Other product and company names mentioned in this user's manual may be the trademarks or registered trademarks of their respective holders.
- TOPPERS Software Licenses

The product includes software licensed under TOPPERS License.

For more information on each software, see "readme.pdf" inside the "about TOPPERS" folder on the supplied CD-ROM.

NOTES

- (1) The contents of this user's manual may not be reprinted in part or whole without permission.
- (2) The contents of this user's manual are subject to change without notice.
- (3) Great care has been taken in the preparation of this user's manual; however, should you notice any questionable points, errors or omissions, please contact us.
- (4) Notwithstanding article (3), NEC will not be responsible for any claims on loss of profit or other matters deemed to result from using the Projector.

Important Information

Safety Cautions

Precautions

Please read this manual carefully before using your NEC projector and keep the manual handy for future reference.

CAUTION



To turn off main power, be sure to remove the plug from power outlet. The power outlet socket should be installed as near to the equipment as possible, and should be easily accessible.

CAUTION



TO PREVENT SHOCK, DO NOT OPEN THE CABINET. THERE ARE HIGH-VOLTAGE COMPONENTS INSIDE. REFER SERVICING TO QUALIFIED SERVICE PERSONNEL.



This symbol warns the user that uninsulated voltage within the unit may be sufficient to cause electrical shock. Therefore, it is dangerous to make any kind of contact with any part inside of the unit.



This symbol alerts the user that important information concerning the operation and maintenance of this unit has been provided. The information should be read carefully to avoid problems.

WARNING: TO PREVENT FIRE OR SHOCK, DO NOT EXPOSE THIS UNIT TO RAIN OR MOISTURE. DO NOT USE THIS UNIT'S PLUG WITH AN EXTENSION CORD OR IN AN OUTLET UNLESS ALL THE PRONGS CAN BE FULLY INSERTED.

DOC Compliance Notice (for Canada only)

This Class B digital apparatus complies with Canadian ICES-003.

Machine Noise Information Regulation - 3. GPSGV,

The highest sound pressure level is less than 70 dB (A) in accordance with EN ISO 7779.

Disposing of your used product



EU-wide legislation as implemented in each Member State requires that used electrical and electronic products carrying the mark (left) must be disposed of separately from normal household waste. This includes projectors and their electrical accessories or lamps. When you dispose of such products, please follow the guidance of your local authority and/or ask the shop where you purchased the product.

After collecting the used products, they are reused and recycled in a proper way. This effort will help us reduce the wastes as well as the negative impact such as mercury contained in a lamp to the human health and the environment at the minimum level.

The mark on the electrical and electronic products only applies to the current European Union Member States.

WARNING TO CALIFORNIA RESIDENTS:

Handling the cables supplied with this product will expose you to lead, a chemical known to the State of California to cause birth defects or other reproductive harm. **WASH HANDS AFTER HANDLING.**

RF Interference (for USA only)

WARNING

The Federal Communications Commission does not allow any modifications or changes to the unit EXCEPT those specified by NEC Display Solutions of America, Inc. in this manual. Failure to comply with this government regulation could void your right to operate this equipment. This equipment has been tested and found to comply with the limits for a Class B digital device, pursuant to Part 15 of the FCC Rules. These limits are designed to provide reasonable protection against harmful interference in a residential installation. This equipment generates, uses, and can radiate radio frequency energy and, if not installed and used in accordance with the instructions, may cause harmful interference to radio communications. However, there is no guarantee that interference will not occur in a particular installation.

If this equipment does cause harmful interference to radio or television reception, which can be determined by turning the equipment off and on, the user is encouraged to try to correct the interference by one or more of the following measures:

- Reorient or relocate the receiving antenna.
- Increase the separation between the equipment and receiver.
- Connect the equipment into an outlet on a circuit different from that to which the receiver is connected.
- Consult the dealer or an experienced radio / TV technician for help.

For UK only: In UK, a BS approved power cord with moulded plug has a Black (five Amps) fuse installed for use with this equipment. If a power cord is not supplied with this equipment please contact your supplier.

Important Safeguards

These safety instructions are to ensure the long life of your projector and to prevent fire and shock. Please read them carefully and heed all warnings.

Installation

- Do not place the projector in the following conditions:
 - on an unstable cart, stand, or table.
 - near water, baths, or damp rooms.
 - in direct sunlight, near heaters, or heat radiating appliances.
 - in a dusty, smoky or steamy environment.
 - on a sheet of paper or cloth, rugs or carpets.
- If you wish to have the projector installed on the ceiling:
 - Do not attempt to install the projector yourself.
 - The projector must be installed by qualified technicians in order to ensure proper operation and reduce the risk of bodily injury.
 - In addition, the ceiling must be strong enough to support the projector and the installation must be in accordance with any local building codes.
 - Please consult your dealer for more information.

WARNING

- Do not cover the lens with the lens cap or equivalent while the projector is on. Doing so can lead to melting of the cap due to the heat emitted from the light output.
- Do not place any objects, which are easily affected by heat, in front of the projector lens. Doing so could lead to the object melting from the heat that is emitted from the light output.



Place the projector in a horizontal position

The tilt angle of the projector should not exceed 10 degrees, nor should the projector be installed in any way other than the desktop and ceiling mount, otherwise lamp life could decrease dramatically.

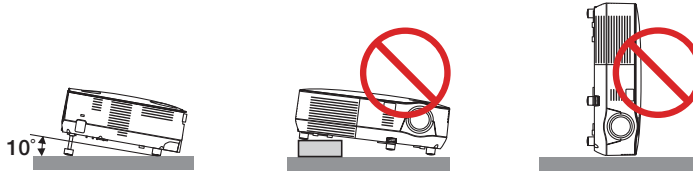

⚠ Fire and Shock Precautions ⚡

- Ensure that there is sufficient ventilation and that vents are unobstructed to prevent the build-up of heat inside your projector. Allow at least 4 inches (10cm) of space between your projector and a wall.
- Do not try to touch the ventilation outlet on the front side as it can become heated while the projector is turned on and immediately after the projector is turned off.



- Prevent foreign objects such as paper clips and bits of paper from falling into your projector. Do not attempt to retrieve any objects that might fall into your projector. Do not insert any metal objects such as a wire or screwdriver into your projector. If something should fall into your projector, disconnect it immediately and have the object removed by a qualified service personnel.
- Do not place any objects on top of the projector.
- Do not touch the power plug during a thunderstorm. Doing so can cause electrical shock or fire.
- The projector is designed to operate on a power supply of 100-240V AC 50/60 Hz. Ensure that your power supply fits this requirement before attempting to use your projector.
- Do not look into the lens while the projector is on. Serious damage to your eyes could result.

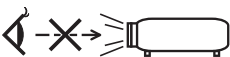

- Keep any items such as magnifying glass out of the light path of the projector. The light being projected from the lens is extensive, therefore any kind of abnormal objects that can redirect light coming out of the lens, can cause unpredictable outcome such as fire or injury to the eyes.
- Do not place any objects, which are easily affected by heat, in front of a projector exhaust vent. Doing so could lead to the object melting or getting your hands burned from the heat that is emitted from the exhaust.
- Handle the power cord carefully. A damaged or frayed power cord can cause electric shock or fire.
 - Do not use any power cords than the supplied one.
 - Do not bend or tug the power cord excessively.
 - Do not place the power cord under the projector, or any heavy object.
 - Do not cover the power cord with other soft materials such as rugs.
 - Do not heat the power cord.
 - Do not handle the power plug with wet hands.
- Turn off the projector, unplug the power cord and have the projector serviced by a qualified service personnel under the following conditions:

- When the power cord or plug is damaged or frayed.
- If liquid has been spilled into the projector, or if it has been exposed to rain or water.
- If the projector does not operate normally when you follow the instructions described in this user's manual.
- If the projector has been dropped or the cabinet has been damaged.
- If the projector exhibits a distinct change in performance, indicating a need for service.
- Disconnect the power cord and any other cables before carrying the projector.
- Turn off the projector and unplug the power cord before cleaning the cabinet or replacing the lamp.
- Turn off the projector and unplug the power cord if the projector is not to be used for an extended period of time.
- When using a LAN cable:
For safety, do not connect to the connector for peripheral device wiring that might have excessive voltage.

CAUTION

- Do not use the tilt-foot for purposes other than originally intended. Misuses such as using the tilt foot to carry or hang (from the wall or ceiling) the projector can cause damage to the projector.
- Do not send the projector in the soft case by parcel delivery service or cargo shipment. The projector inside the soft case could be damaged.
- Select [HIGH] in Fan mode if you continue to use the projector for consecutive days. (From the menu, select [SETUP] → [OPTIONS(1)] → [FAN MODE] → [HIGH].)
- Do not turn off the AC power for 60 seconds after the lamp is turned on and while the POWER indicator is blinking green.
Doing so could cause premature lamp failure.
- Parts of the projector may become temporarily heated if the projector is turned off with the POWER button or if the AC power supply is disconnected during normal projector operation.
Use caution when picking up the projector.

Remote Control Precautions

- Handle the remote control carefully.
- If the remote control gets wet, wipe it dry immediately.
- Avoid excessive heat and humidity.
- Do not heat, take apart, or throw batteries into fire.
- If you will not be using the remote control for a long time, remove the batteries.
- Ensure that you have the batteries' polarity (+/-) aligned correctly.
- Do not use new and old batteries together, or use different types of batteries together.
- Dispose of used batteries according to your local regulations.

Lamp Replacement

- Use the specified lamp for safety and performance.
- To replace the lamp, follow all instructions provided on page 81.
- Be sure to replace the lamp when the message **[THE LAMP HAS REACHED THE END OF ITS USABLE LIFE. PLEASE REPLACE THE LAMP. USE THE SPECIFIED LAMP FOR SAFETY AND PERFORMANCE]** appears. If you continue to use the lamp after the lamp has reached the end of its usable life, the lamp bulb may shatter, and pieces of glass may be scattered in the lamp case. Do not touch them as the pieces of glass may cause injury.
If this happens, contact your dealer for lamp replacement.

A Lamp Characteristic

The projector has a high-pressure mercury lamp as a light source.

A lamp has a characteristic that its brightness gradually decreases with age. Also repeatedly turning the lamp on and off will increase the possibility of its lower brightness.

CAUTION:

- DO NOT TOUCH THE LAMP immediately after it has been used. It will be extremely hot. Turn the projector off and then disconnect the power cord. Allow at least one hour for the lamp to cool before handling.
- When removing the lamp from a ceiling-mounted projector, make sure that no one is under the projector. Glass fragments could fall if the lamp has been burned out.

Note for US Residents

The lamps in this product contain mercury. Please dispose according to Local, State or Federal Laws.

Health precautions to users viewing 3D images

Before viewing, be sure to read health care precautions that may be found in the user's manual included with your LCD shutter eyeglasses or your 3D compatible content such as DVDs, video games, computer's video files and the like. To avoid any adverse symptoms, heed the following:

- Do not use LCD shutter eyeglasses for viewing any material other than 3D images.
- Allow a distance of 2 m/7 feet or greater between the screen and a user. Viewing 3D images from too close a distance can strain your eyes.
- Avoid viewing 3D images for a prolonged period of time. Take a break of 15 minutes or longer after every hour of viewing.
- If you or any member of your family has a history of light-sensitive seizures, consult a doctor before viewing 3D images.
- While viewing 3D images, if you get sick such as nausea, dizziness, queasiness, headache, eyestrain, blurry vision, convulsions, and numbness, stop viewing them. If symptoms still persist, consult a doctor.
- View 3D images from the front of the screen. Viewing from an angle may cause fatigue or eyestrain.

About High Altitude mode

- If you use the projector at altitudes approximately 3000 feet/900 meters or higher, you are recommended to set [FAN MODE] to [HIGH ALTITUDE]. Failure to do so may cause the projector to overheat , resulting in malfunction. (→ page 70)
- Using the projector at high altitudes or in low air pressure can shorten the life of components.

About Copyright of original projected pictures:

Please note that using this projector for the purpose of commercial gain or the attraction of public attention in a venue such as a coffee shop or hotel and employing compression or expansion of the screen image with the following functions may raise concern about the infringement of copyrights which are protected by copyright law. [ASPECT RATIO], [KEYSTONE], Magnifying feature and other similar features.

This device is not intended for use in the direct field of view at visual display workplaces. To avoid incommoding reflections at visual display workplaces this device must not be placed in the direct field of view.

Power management function

The projector has power management functions. To reduce power consumption, the power management functions (1 and 2) are factory preset as shown below. To control the projector from an external device via a LAN or serial cable connection, use the on-screen menu to change the settings for 1 and 2.

1. STANDBY MODE (Factory preset: POWER-SAVING)

To control the projector from an external device, select [NORMAL] for [STANDBY MODE].

NOTE:

- When [POWER-SAVING] is selected for [STANDBY MODE], the following connectors and functions will not work:
PC CONTROL port, MONITOR OUT connector, AUDIO OUT connector, LAN functions, Mail Alert function, DDC/CI (Virtual Remote Tool)

2. AUTO POWER OFF (Factory preset: 30 minutes)

To control the projector from an external device, select [OFF] for [AUTO POWER OFF].

NOTE:

- When [0:30] is selected for [AUTO POWER OFF], you can enable the projector to automatically turn off in 30 minutes if there is no signal received by any input or if no operation is performed.

Table of Contents

Important Information	i
1. Introduction	1
1 What's in the Box?.....	1
2 Introduction to the Projector.....	2
Congratulations on Your Purchase of the Projector.....	2
Features you'll enjoy:.....	2
About this user's manual.....	3
3 Part Names of the Projector.....	4
Front/Top.....	4
Rear.....	4
Top Features.....	5
Terminal Panel Features.....	6
4 Part Names of the Remote Control.....	7
Battery Installation.....	8
Remote Control Precautions.....	8
Operating Range for Wireless Remote Control.....	8
2. Installation and Connections	9
1 Setting Up the Screen and the Projector.....	9
Selecting a Location [V311X].....	9
Selecting a Location [V311W/V281W].....	10
Throw Distance and Screen Size.....	11
2 Making Connections.....	13
Connecting Your Computer.....	13
Connecting an External Monitor.....	14
Connecting Your DVD Player with Component Output.....	15
Connecting Your VCR.....	16
Connecting HDMI Input.....	17
Connecting to a Network.....	18
Connecting the Supplied Power Cord.....	19
3. Projecting an Image (Basic Operation)	20
1 Turning on the Projector.....	20
Note on Startup screen (Menu Language Select screen).....	21
2 Selecting a Source.....	22
Selecting the computer or video source.....	22
3 Adjusting the Picture Size and Position.....	23
Adjust the Tilt Foot.....	24
Zoom.....	25
Focus.....	25
4 Correcting Keystone Distortion.....	26
Correcting Keystone Distortion.....	26
Adjusting with buttons on the cabinet.....	26
Adjusting with the remote control.....	27
5 Optimizing Computer Signal Automatically.....	28
Adjusting the Image Using Auto Adjust.....	28
6 Turning Up or Down Volume.....	28

7	Turning off the Projector	29
8	After Use.....	30
4.	Convenient Features	31
1	Turning off the Image and Sound	31
2	Freezing a Picture	31
3	Enlarging a Picture	31
4	Changing Eco Mode	32
5	Checking Energy-Saving Effect [CARBON METER]	33
6	Preventing the Unauthorized Use of the Projector [SECURITY]	34
7	Using the Optional Remote Mouse Receiver (NP01MR)	37
8	Using the Computer Cable (VGA) to Operate the Projector (Virtual Remote Tool)	39
9	Network Setting by Using an HTTP Browser.....	45
10	Viewing 3D Images.....	48
5.	Using On-Screen Menu	52
1	Using the Menus.....	52
2	Menu Elements.....	53
3	List of Menu Items	54
4	Menu Descriptions & Functions [SOURCE]	56
5	Menu Descriptions & Functions [ADJUST].....	57
6	Menu Descriptions & Functions [SETUP].....	64
7	Menu Descriptions & Functions [INFO.]	77
8	Menu Descriptions & Functions [RESET].....	79
6.	Maintenance	80
1	Cleaning the Cabinet and the Lens	80
2	Replacing the Lamp.....	81
7.	Appendix.....	84
1	Troubleshooting	84
	Indicator Messages.....	84
2	Specifications	87
3	Cabinet Dimensions	89
4	Pin Assignments of D-Sub COMPUTER Input Connector	90
	Mini D-Sub 15 Pin Connector	90
5	Compatible Input Signal List.....	91
6	PC Control Codes and Cable Connection	92
	PC Control Codes.....	92
	Cable Connection	92
	PC Control Connector (D-SUB 9P).....	92
7	Troubleshooting Check List.....	93
8	REGISTER YOUR PROJECTOR! (for residents in the United States, Canada, and Mexico)	95

1. Introduction

① What's in the Box?

Make sure your box contains everything listed. If any pieces are missing, contact your dealer. Please save the original box and packing materials if you ever need to ship your projector.

Projector

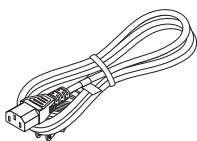
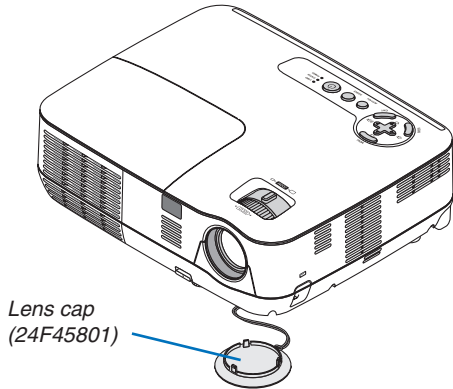

Power cord
(US: 7N080236)
(EU: 7N080022)
(Brazil: 7N080520)

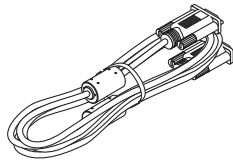

Computer cable (VGA)
(7N520087/7N520073)

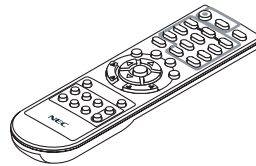

Remote control
(7N900926)

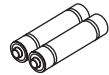

Batteries (AAA x 2)

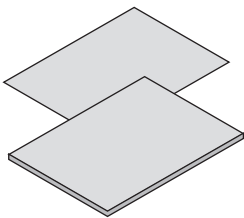

For North America
Quick Setup Guide (7N8N4041)
Important Information (7N8N4021)

For other countries than North America
Quick Setup Guide (7N8N4041) and
(7N8N4051)
Important Information (7N8N4021)
and (7N8N4031)

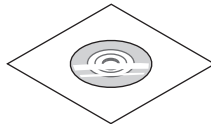

NEC Projector CD-ROM
User's manual
(7N951961)

For North America only
Limited warranty

For customers in Europe:
You will find our current valid Guarantee Policy on our
Web Site: www.nec-display-solutions.com

② Introduction to the Projector

This section introduces you to your new projector and describes the features and controls.

Congratulations on Your Purchase of the Projector

This DLP® projector is one of the very best projectors available today. The projector enables you to project precise images up to 300 inches (measured diagonally) from your PC or Mac computer (desktop or notebook), VCR, DVD player or document camera.

You can use the projector on a tabletop or cart, you can use the projector to project images from behind the screen, and the projector can be permanently mounted on a ceiling*¹. The remote control can be used wirelessly.

*1 Do not attempt to mount the projector on a ceiling yourself.

The projector must be installed by qualified technicians in order to ensure proper operation and reduce the risk of bodily injury.

In addition, the ceiling must be strong enough to support the projector and the installation must be in accordance with any local building codes. Please consult your dealer for more information.

Features you'll enjoy:

- **Quick start & Quick Power Off**

7 seconds after turning on the power, the projector is ready to display PC or video images.

The projector can be put away immediately after the projector is powered down. No cool down period is required after the projector is turned off from the remote control or cabinet control panel.

- **Direct Power Off**

The projector has a feature called "Direct Power Off". This feature allows the projector to be turned off (even when projecting an image) by disconnecting the AC power supply.

To turn off the AC power supply when the projector is powered on, use a power strip equipped with a switch and a breaker.

- **0.5 W or less in standby condition with energy saving technology**

Selecting [POWER-SAVING] for [STANDBY MODE] from the menu can put the projector in power-saving mode that consumes only 0.4 W (100-130 V AC)/0.5 W (200-240 V AC).

- **Carbon Meter**

This feature will show energy-saving effect in terms of CO₂ emission reduction (kg) and electricity cost when the projector's [ECO MODE] is set to [ON].

The amount of CO₂ emission reduction will be displayed in the confirmation message at the time of power-off and in the INFO of the on-screen menu.

- **7W built-in speaker for an integrated audio solution**

Powerful 7 watt speaker provides volume need for large rooms.

- **HDMI input port provides digital signal**

The HDMI input provides HDCP compatible digital signals. The HDMI input also supports audio signal.

- **Two computer inputs provided**

The projector comes with two computer input ports (Mini D-Sub15P) with audio inputs (two stereo mini jacks) as well as composite and S-video inputs with audio inputs (a pair of L/R RCA jacks).

- **DLP® projector with high resolution and high brightness**

High resolution display - up to UXGA compatible, XGA (V311X)/WXGA (V311W/V281W) native resolution.

- **AUTO POWER ON and AUTO POWER OFF features**

The DIRECT POWER ON, AUTO POWER ON(COMP1), AUTO POWER OFF, and OFF TIMER features eliminate the need to always use the POWER button on the remote control or projector cabinet.

- **Preventing unauthorized use of the projector**

Enhanced smart security settings for keyword protection, cabinet control panel lock, security slot, chain opening to help prevent unauthorized access, adjustments and theft deterrence.

- **The supplied remote control allows you to assign a CONTROL ID to the projector**

Multiple projectors can be operated separately and independently with the same single remote control by assigning an ID number to each projector.

- **Integrated RJ-45 connector for wired networking capacity**

An RJ-45 connector is equipped as standard feature.

- **3D images supported**

The projector provides 3D images to a user wearing an optional DLP® Link compatible LCD shutter eyeglasses (NP02GL).

- **NVIDIA® 3D Vision supported (V311X/V311W only)**

The projector is certified as a display device for NVIDIA® 3D Vision™, which allows you to view 3D images by using with supported graphics board or software.

- **CRESTRON ROOMVIEW supported**

The projector supports CRESTRON ROOMVIEW which allows you to control and manage equipment connected to your network from your computer.

About this user's manual

The fastest way to get started is to take your time and do everything right the first time. Take a few minutes now to review the user's manual. This may save you time later on. At the beginning of each section of the manual you'll find an overview. If the section doesn't apply, you can skip it.

3 Part Names of the Projector

Front/Top

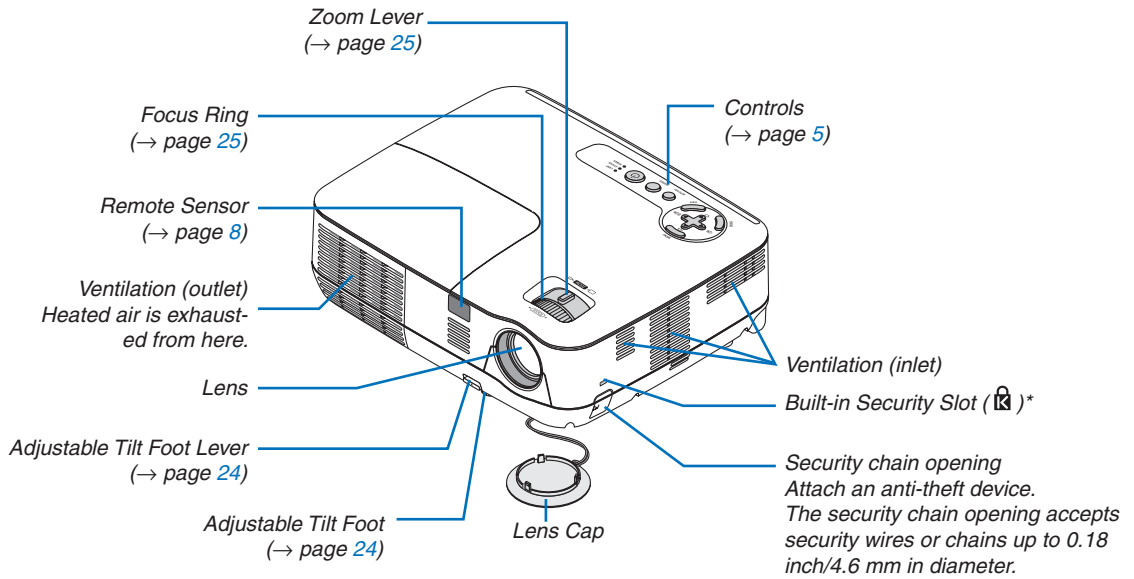

* This security slot supports the MicroSaver® Security System.

Rear

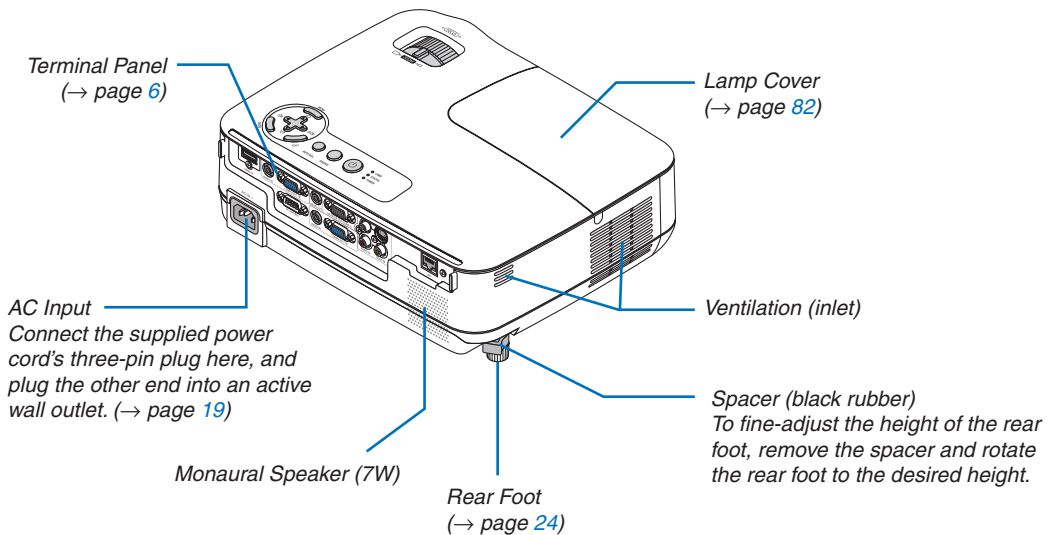

Top Features

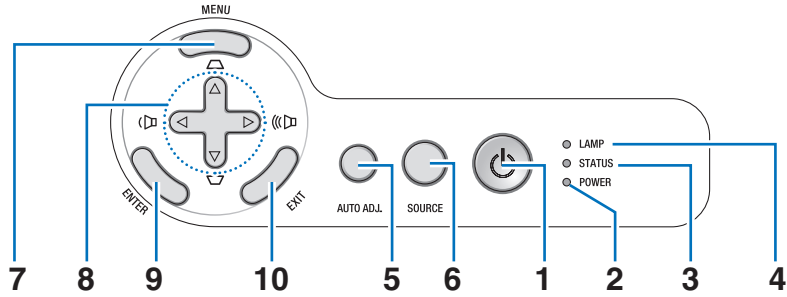

1. POWER Button (ON / STAND BY) (⏻)

(→ page 20, 29)

2. POWER Indicator

(→ page 19, 20, 29, 84)

3. STATUS Indicator

(→ page 84)

4. LAMP Indicator

(→ page 81, 84)

5. AUTO ADJ. Button

(→ page 28)

6. SOURCE Button

(→ page 22)

7. MENU Button

(→ page 52)

8. $\Delta \nabla \langle \rangle$ / Keystone $\Delta \nabla$ / Volume $\langle \rangle$ Buttons

(→ page 26, 28, 31)

9. ENTER Button

10. EXIT Button

Terminal Panel Features

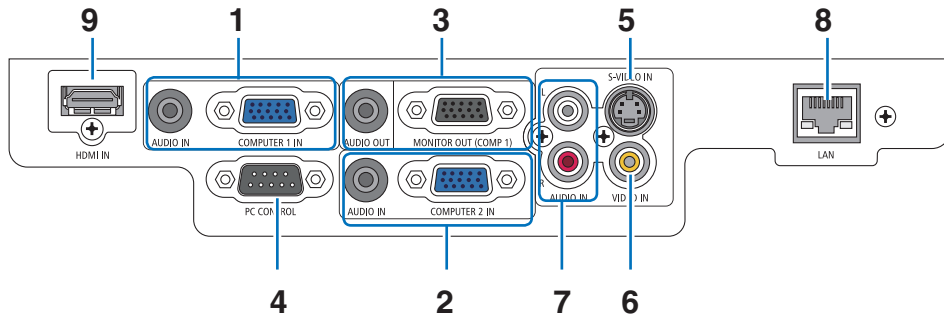

1. COMPUTER 1 IN/ Component Input Connector (Mini D-Sub 15 Pin)

(→ page 13, 14, 15)

AUDIO IN Mini Jack (Stereo Mini)

(→ page 13, 14, 15)

2. COMPUTER 2 IN/ Component Input Connector (Mini D-Sub 15 Pin)

(→ page 13, 14, 15)

AUDIO IN Mini Jack (Stereo Mini)

(→ page 13, 14, 15)

3. MONITOR OUT (COMP 1) Connector (Mini D-Sub 15 Pin)

(→ page 14)

AUDIO OUT Mini Jack (Stereo Mini)

(→ page 14)

4. PC CONTROL Port (D-Sub 9 Pin)

(→ page 92)

Use this port to connect a PC or control system. This enables you to control the projector using serial communication protocol. If you are writing your own program, typical PC control codes are on page 92.

5. S-VIDEO IN Connector (Mini DIN 4 Pin)

(→ page 16)

6. VIDEO IN Connector (RCA)

(→ page 16)

7. VIDEO/S-VIDEO AUDIO Input Jacks L/R (RCA)

(→ page 16)

8. LAN Port (RJ-45)

(→ page 18)

9. HDMI Connector

(→ page 13, 17)

4 Part Names of the Remote Control

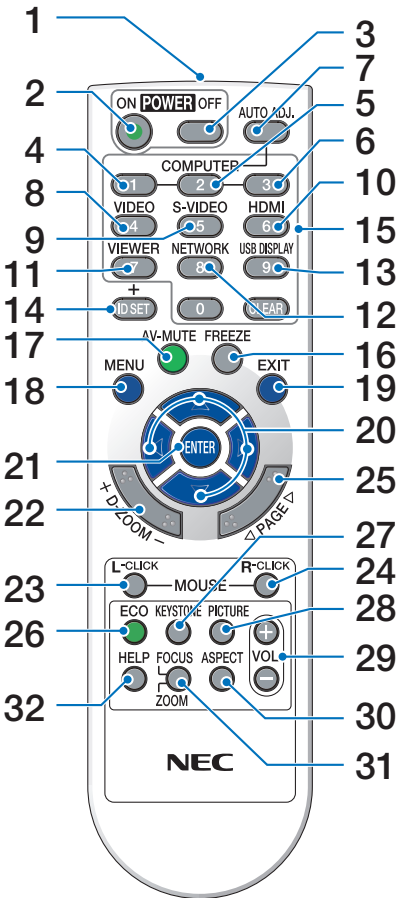

1. **Infrared Transmitter**
(→ page 8)
2. **POWER ON Button**
(→ page 20)
3. **POWER OFF Button**
(→ page 29)
- 4, 5, 6. **COMPUTER 1/2/3 Button**
(→ page 22)
(COMPUTER 3 is not available on all the projector models.)
7. **AUTO ADJ. Button**
(→ page 28)
8. **VIDEO Button**
(→ page 22)
9. **S-VIDEO Button**
(→ page 22)
10. **HDMI Button**
(→ page 22)
11. **VIEWER Button**
(not available on this series of projectors)
12. **NETWORK Button**
(not available on this series of projectors)
13. **USB DISPLAY Button**
(not available on this series of projectors)
14. **ID SET Button**
(→ page 69)
15. **Numeric Keypad Button/ CLEAR Button**
(→ page 69)
16. **FREEZE Button**
(→ page 31)
17. **AV-MUTE Button**
(→ page 31)
18. **MENU Button**
(→ page 52)
19. **EXIT Button**
(→ page 52)
20. **▲▼◀▶ Button**
(→ page 38, 52)
21. **ENTER Button**
(→ page 52)
22. **D-ZOOM (+)(-) Button**
(→ page 31)
23. **MOUSE L-CLICK Button***
(→ page 38)
24. **MOUSE R-CLICK Button***
(→ page 38)
25. **PAGE ▲/▼ Button***
(→ page 37, 38)
26. **ECO Button**
(→ page 32)
27. **KEYSTONE Button**
(→ page 27)
28. **PICTURE Button**
(→ page 57, 58)
29. **VOL. (+)(-) Button**
(→ page 28)
30. **ASPECT Button**
(→ page 61)
31. **FOCUS/ZOOM Button**
(not available on this series of projectors)
32. **HELP Button**
(→ page 77)

* The PAGE ▲/▼, MOUSE L-CLICK and MOUSE R-CLICK buttons work only when the optional remote mouse receiver (NP01MR) is connected with your computer.

Battery Installation

- 1** Press firmly and slide the battery cover off.
- 2** Install new batteries (AAA). Ensure that you have the batteries' polarity (+/-) aligned correctly.
- 3** Slip the cover back over the batteries until it snaps into place. Do not mix different types of batteries or new and old batteries.

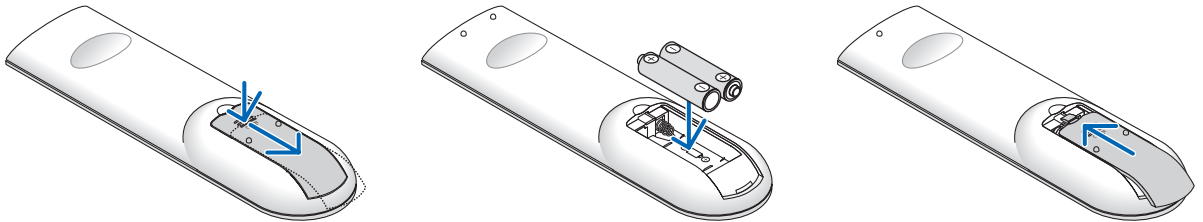

Remote Control Precautions

- Handle the remote control carefully.
- If the remote control gets wet, wipe it dry immediately.
- Avoid excessive heat and humidity.
- Do not heat, take apart, or throw batteries into fire.
- If you will not be using the remote control for a long time, remove the batteries.
- Ensure that you have the batteries' polarity (+/-) aligned correctly.
- Do not use new and old batteries together, or use different types of batteries together.
- Dispose of used batteries according to your local regulations.

Operating Range for Wireless Remote Control

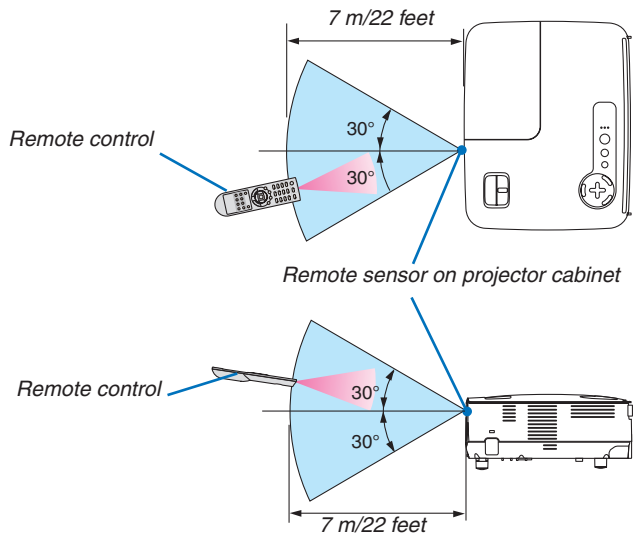

- The infrared signal operates by line-of-sight up to a distance of about 22 feet/7 m and within a 60-degree angle of the remote sensor on the projector cabinet.
- The projector will not respond if there are objects between the remote control and the sensor, or if strong light falls on the sensor. Weak batteries will also prevent the remote control from properly operating the projector.

2. Installation and Connections

This section describes how to set up your projector and how to connect video and audio sources. Your projector is simple to set up and use. But before you get started, you must first:

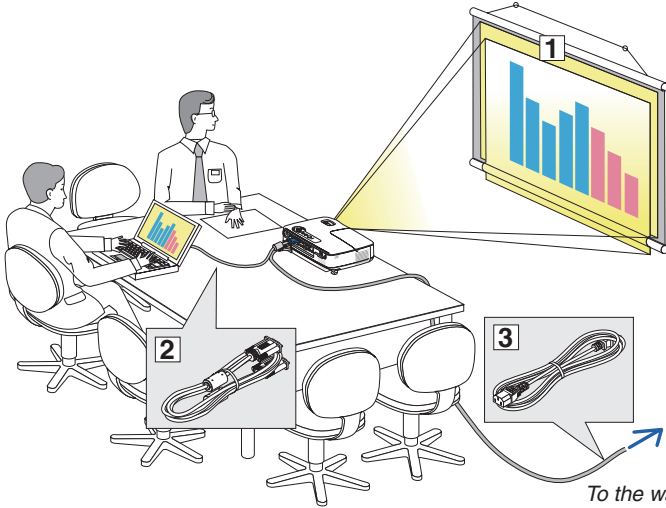

- ① Set up a screen and the projector.
- ② Connect your computer or video equipment to the projector. See pages 13, 14, 15, 16, 17, 18.
- ③ Connect the supplied power cord. See page 19.

NOTE: Ensure that the power cord and any other cables are disconnected before moving the projector. When moving the projector or when it is not in use, cover the lens with the lens cap.

① Setting Up the Screen and the Projector

Selecting a Location [V311X]

The further your projector is from the screen or wall, the larger the image. The minimum size the image can be is 30" (0.76 m) measured diagonally when the projector is roughly 49 inches (1.3 m) from the wall or screen. The largest the image can be is 300" (7.6 m) when the projector is about 493 inches (12.5 m) from the wall or screen. Use the chart below as a rough guide.

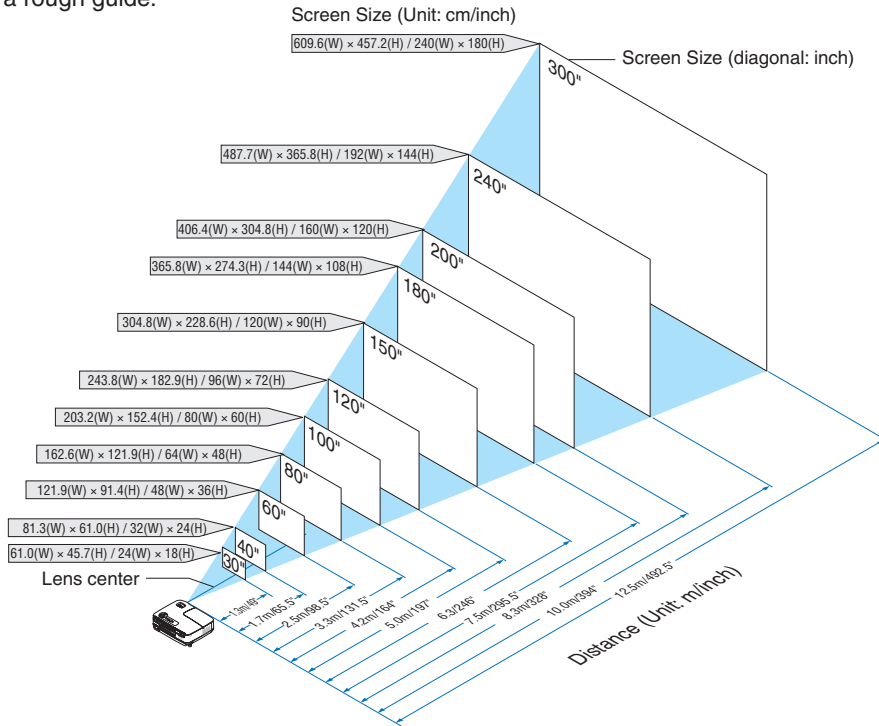

NOTE:

- The distances are indicated by intermediate values between tele and wide. Use as a rule of thumb.
- The Zoom lever adjusts the image size up to +/-5%
- For more details on throw distance, see page 11.

Selecting a Location [V311W/V281W]

The further your projector is from the screen or wall, the larger the image. The minimum size the image can be is 30" (0.76 m) measured diagonally when the projector is roughly 41 inches (1.0 m) from the wall or screen. The largest the image can be is 300" (7.6 m) when the projector is about 413 inches (10.5 m) from the wall or screen. Use the chart below as a rough guide.

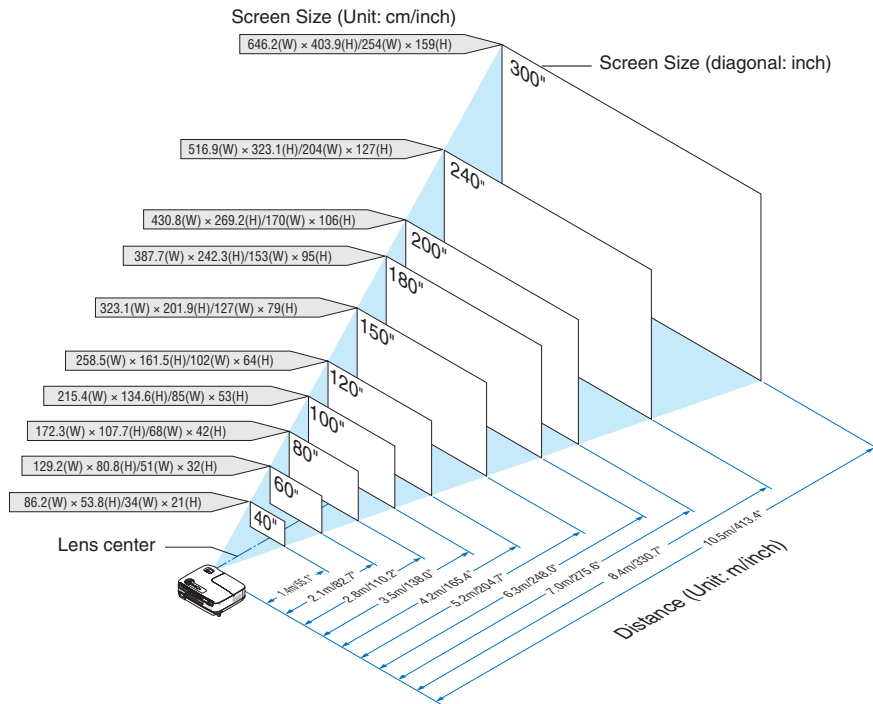

NOTE:

- The distances are indicated by intermediate values between tele and wide. Use as a rule of thumb.
- The Zoom lever adjusts the image size up to +/-5%
- For more details on throw distance, see next page.

Throw Distance and Screen Size

The following shows the proper relative positions of the projector and screen. Refer to the table to determine the position of installation.

Distance Chart

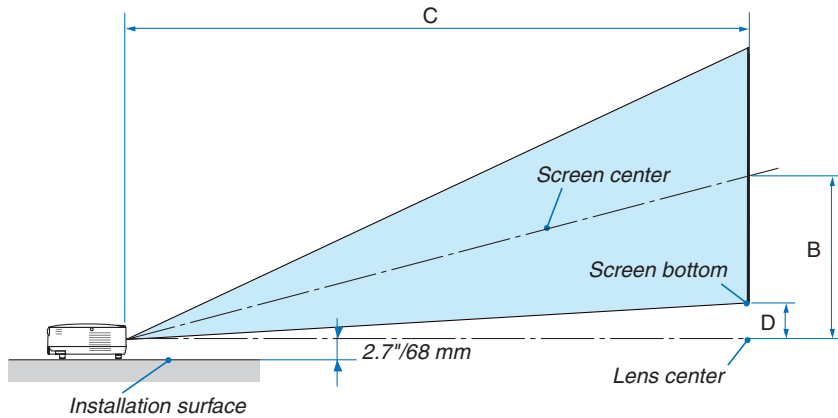

V311X

Diagonal		Screen Size				B		C				D (WIDE)		α			
		Width		Height				Wide		-	Tele				Wide	-	Tele
inch	mm	inch	mm	inch	mm	inch	mm	inch	mm	-	inch	mm	inch	mm	degree	-	degree
30	762	24	610	18	457	12	297	46	1180	-	52	1320	3	69	14.0	-	12.7
40	1016	32	813	24	610	16	396	62	1573	-	69	1760	4	91	14.0	-	12.7
60	1524	48	1219	36	914	23	594	93	2360	-	104	2640	5	137	14.0	-	12.7
70	1778	56	1422	42	1067	27	693	108	2753	-	121	3080	6	160	14.0	-	12.7
80	2032	64	1626	48	1219	31	792	124	3147	-	139	3520	7	183	14.0	-	12.7
90	2286	72	1829	54	1372	35	891	139	3540	-	156	3960	8	206	14.0	-	12.7
100	2540	80	2032	60	1524	39	990	155	3933	-	173	4400	9	228	14.0	-	12.7
120	3048	96	2438	72	1829	47	1188	186	4720	-	208	5280	11	274	14.0	-	12.7
150	3810	120	3048	90	2286	58	1486	232	5900	-	260	6600	13	343	14.0	-	12.7
180	4572	144	3658	108	2743	70	1783	279	7080	-	312	7920	16	411	14.0	-	12.7
200	5080	160	4064	120	3048	78	1981	310	7867	-	346	8800	18	457	14.0	-	12.7
240	6096	192	4877	144	3658	94	2377	372	9440	-	416	10560	22	548	14.0	-	12.7
270	6858	216	5486	162	4115	105	2674	418	10620	-	468	11880	24	617	14.0	-	12.7
300	7620	240	6096	180	4572	117	2971	465	11800	-	520	13200	27	685	14.0	-	12.7

V311W/V281W

Diagonal		Screen Size				B		C				D (WIDE)		α			
		Width		Height				Wide		-	Tele				Wide	-	Tele
inch	mm	inch	mm	inch	mm	inch	mm	inch	mm	-	inch	mm	inch	mm	degree	-	degree
30	762	25	646	16	404	10	252	39	1001	-	43	1098	2	51	14.1	-	12.9
40	1016	34	862	21	538	13	337	53	1335	-	58	1464	3	67	14.1	-	12.9
60	1524	51	1292	32	808	20	505	79	2002	-	86	2196	4	101	14.1	-	12.9
70	1778	59	1508	37	942	23	589	92	2336	-	101	2562	5	118	14.1	-	12.9
80	2032	68	1723	42	1077	27	673	105	2669	-	115	2928	5	135	14.1	-	12.9
90	2286	76	1939	48	1212	30	757	118	3003	-	130	3294	6	152	14.1	-	12.9
100	2540	85	2154	53	1346	33	841	131	3337	-	144	3660	7	168	14.1	-	12.9
120	3048	102	2585	64	1615	40	1010	158	4004	-	173	4392	8	202	14.1	-	12.9
150	3810	127	3231	79	2019	50	1262	197	5005	-	216	5490	10	253	14.1	-	12.9
180	4572	153	3877	95	2423	60	1515	236	6006	-	259	6588	12	303	14.1	-	12.9
200	5080	170	4308	106	2692	66	1683	263	6673	-	288	7320	13	337	14.1	-	12.9
240	6096	204	5169	127	3231	80	2019	315	8008	-	346	8784	16	404	14.1	-	12.9
270	6858	229	5816	143	3635	89	2272	355	9009	-	389	9882	18	455	14.1	-	12.9
300	7620	254	6462	159	4039	99	2524	394	10010	-	432	10980	20	505	14.1	-	12.9

B = Vertical distance between lens center and screen center

C = Throw distance

D = Vertical distance between lens center and bottom of screen (top of screen for ceiling application)

α = Throw angle

NOTE: The values in the tables are design values and may vary.

WARNING

- * Installing your projector on the ceiling must be done by a qualified technician. Contact your NEC dealer for more information.
- * Do not attempt to install the projector yourself.
- Only use your projector on a solid, level surface. If the projector falls to the ground, you can be injured and the projector severely damaged.
- Do not use the projector where temperatures vary greatly. The projector must be used at temperatures between 41°F (5°C) and 104°F (40°C). ([ECO MODE] is set automatically to [ON] at 95°F to 104°F/35°C to 40°C. Note that [ECO] mode will be set to [ON] automatically at 86°F to 104°F/30°C to 40°C when used in [HIGH ALTITUDE].)
- Do not expose the projector to moisture, dust, or smoke. This will harm the screen image.
- Ensure that you have adequate ventilation around your projector so heat can dissipate. Do not cover the vents on the side or the front of the projector.

Reflecting the Image

Using a mirror to reflect your projector's image enables you to enjoy a much larger image when a smaller space is required. Contact your NEC dealer if you need a mirror system. If you're using a mirror system and your image is inverted, use the MENU and $\triangle \nabla \triangleleft \triangleright$ buttons on your projector cabinet or your remote control to correct the orientation. (→ page 68)

② Making Connections

Connecting Your Computer

NOTE: When using with a notebook PC, be sure to connect the projector and notebook PC while the projector is in standby mode and before turning on the power to the notebook PC.

In most cases the output signal from the notebook PC is not turned on unless connected to the projector before being powered up.

* If the screen goes blank while using your remote control, it may be the result of the computer's screen-saver or power management software.

Enabling the computer's external display

Displaying an image on the notebook PC's screen does not necessarily mean it outputs a signal to the projector.

When using a PC compatible laptop, a combination of function keys will enable/disable the external display.

Usually, the combination of the "Fn" key along with one of the 12 function keys gets the external display to come on or off. For example, NEC laptops use Fn + F3, while Dell laptops use Fn + F8 key combinations to toggle through external display selections.

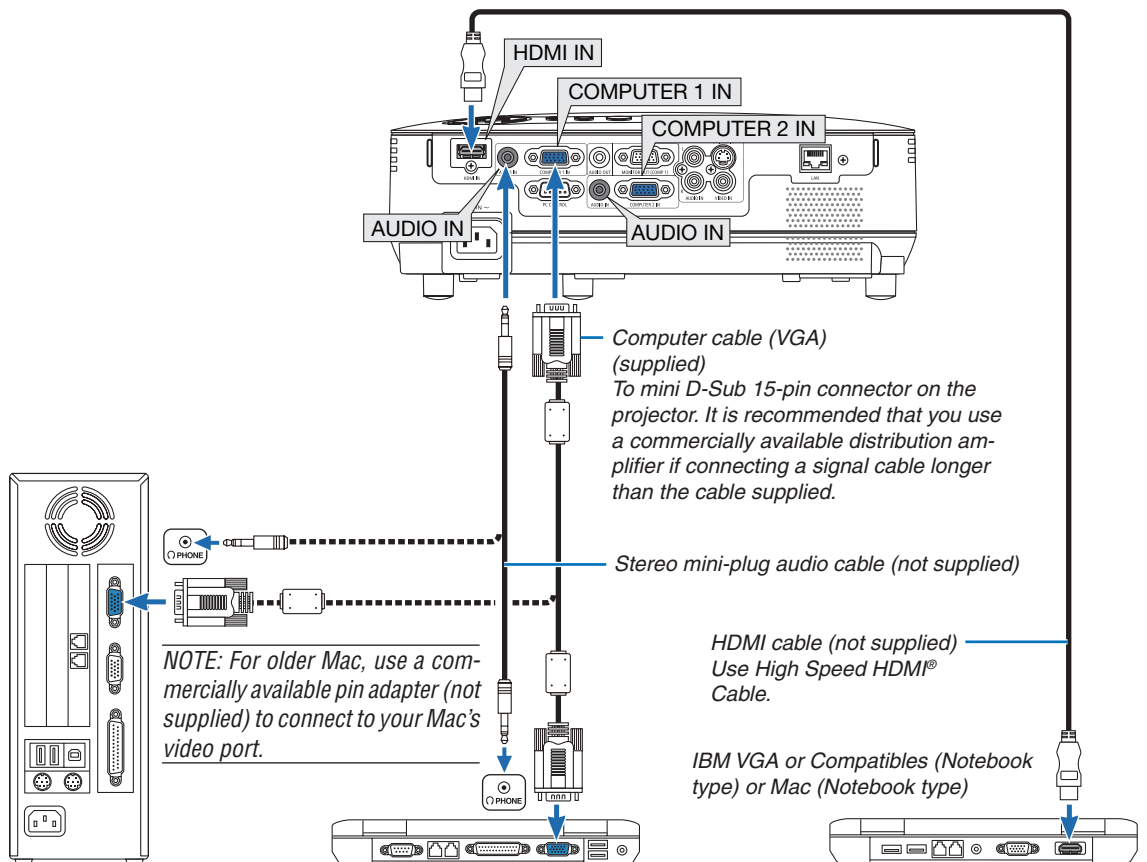

NOTE:

- Before connecting an audio cable to the headphone jack of a computer, adjust the computer's volume level to low. After connecting the projector to the computer, adjust the volume of both projector and computer to suitable level as desired to avoid damage to your ear.
- If an audio output jack of your computer is a mini jack type, connect the audio cable to it.
- An image may not be displayed correctly when a Video or S-Video source is played back via a commercially available scan converter.

This is because the projector will process a video signal as a computer signal at the default setting. In that case, do the following.

- When an image is displayed with the lower and upper black portion of the screen or a dark image is not displayed correctly: Project an image to fill the screen and then press the AUTO ADJ. button on the remote control or the projector cabinet.
- Both the COMPUTER 1 IN and COMPUTER 2 IN connectors support Plug & Play (DDC2B).

Connecting an External Monitor

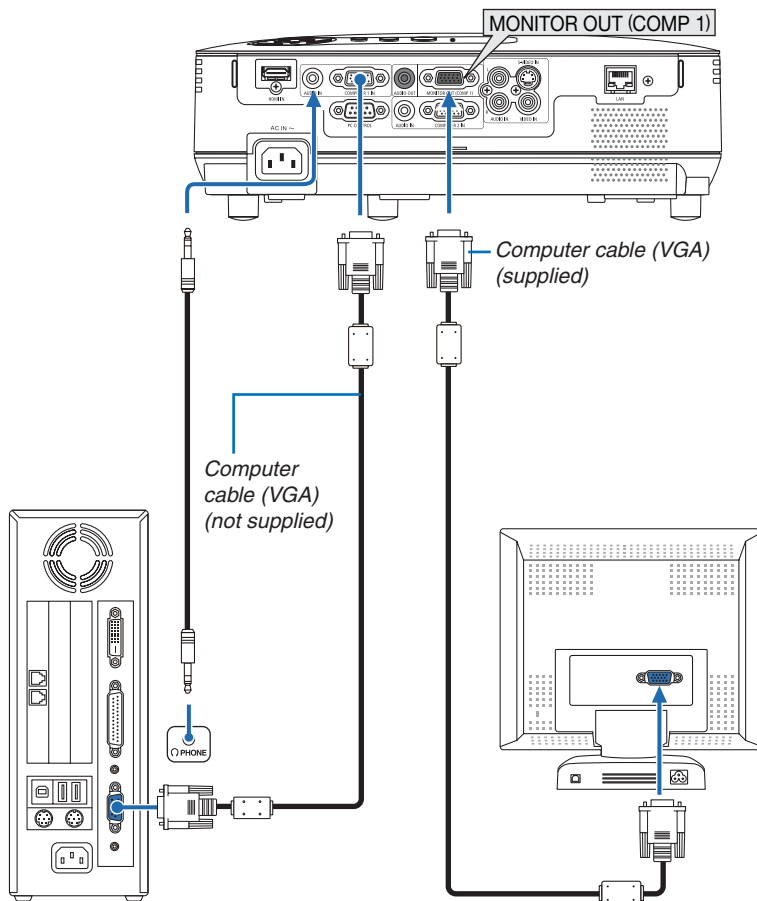

You can connect a separate, external monitor to your projector to simultaneously view on a monitor the computer analog image you're projecting.

NOTE: Daisy chain connection is not possible.

Connecting Your DVD Player with Component Output

Use audio equipment for stereo sound.
The projector's built-in speaker is monaural.

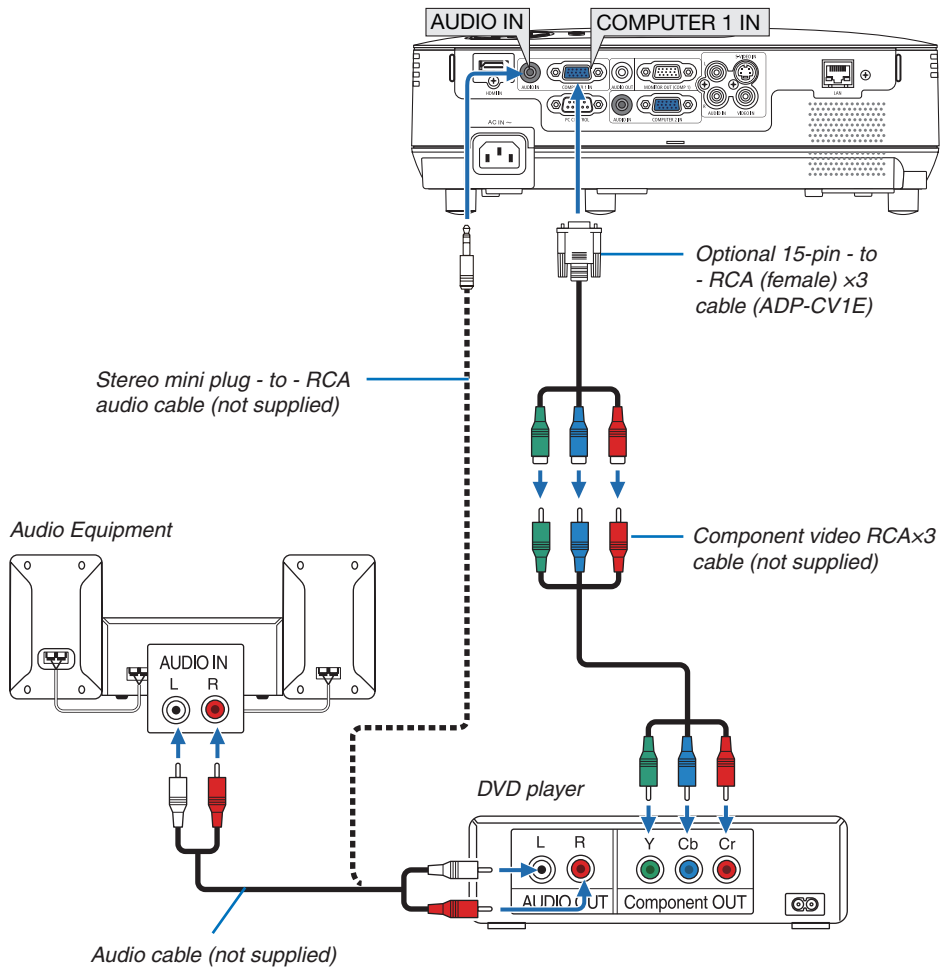

NOTE: Refer to your DVD player's owner's manual for more information about your DVD player's video output requirements.

2. Installation and Connections

Connecting Your VCR

Use audio equipment for stereo sound.
The projector's built-in speaker is monaural.

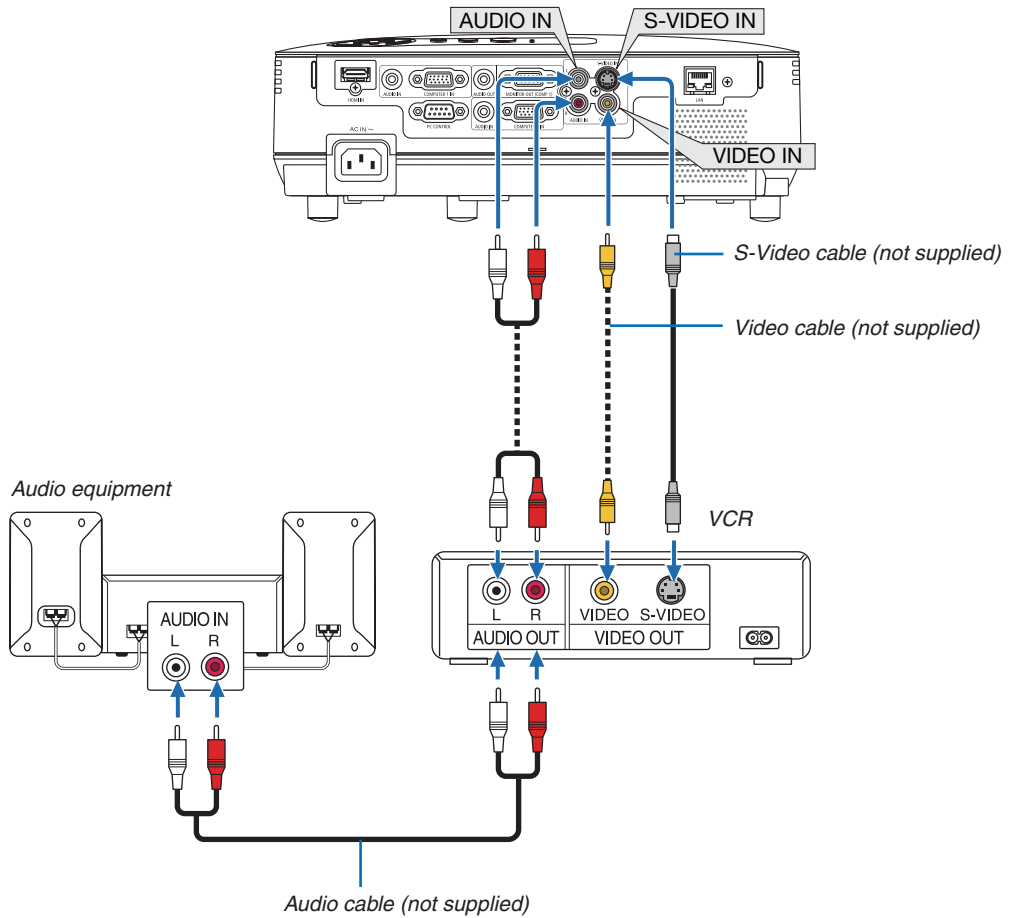

NOTE: Refer to your VCR owner's manual for more information about your equipment's video output requirements.

NOTE: An image may not be displayed correctly when a Video or S-Video source is played back in fast-forward or fast-rewind via a scan converter.

Connecting HDMI Input

You can connect the HDMI output of your DVD player, hard disk player, Blu-ray player, or notebook type PC to the HDMI IN connector of your projector.

NOTE: The HDMI IN connector supports Plug & Play (DDC2B).

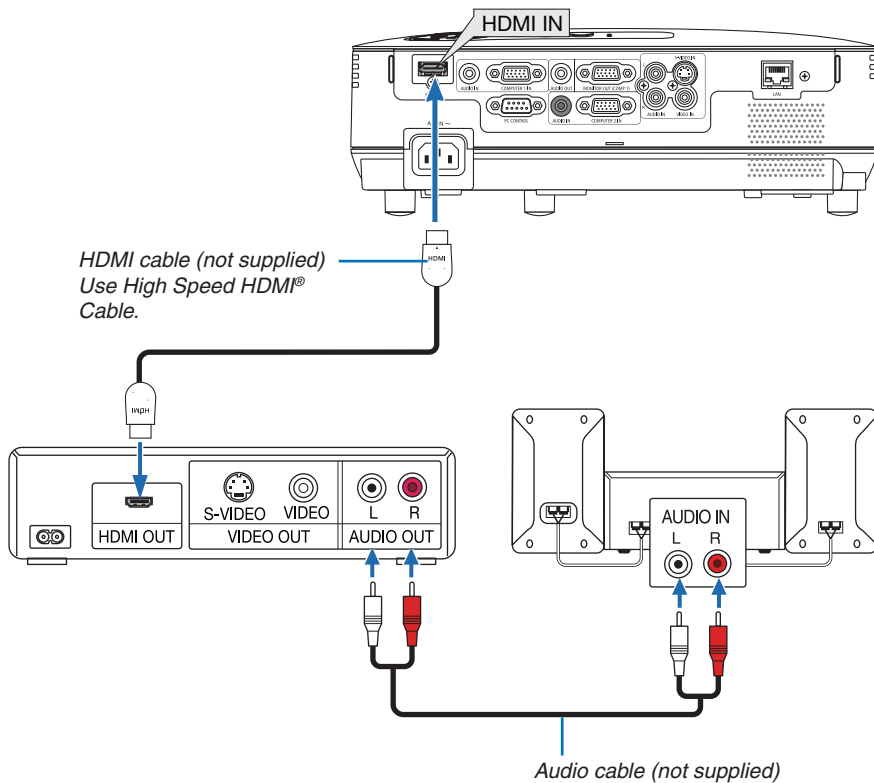

TIP: For users of audio video equipment with an HDMI connector:

Select "Enhanced" rather than "Normal" if HDMI output is switchable between "Enhanced" and "Normal".

This will provide improved image contrast and more detailed dark areas.

For more information on settings, refer to the instruction manual of the audio video equipment to be connected.

- When connecting the HDMI IN connector of the projector to the DVD player, the projector's video level can be made settings in accordance with the DVD player's video level. In the menu select [HDMI SETTINGS] → [VIDEO LEVEL] and make necessary settings.
- If the HDMI input sound cannot be heard, in the menu select [HDMI SETTINGS] → [AUDIO SELECT] → [HDMI] (→ page 71).

NOTE: HDMI signal

If the AC power supply is removed from the projector (Direct Power Off function) while displaying an image connected to the HDMI input, the projector may not display an image properly the next time it is powered up. Should this happen, power off the AC supply, power off your HDMI equipment (or disconnect the HDMI cable), and then power on the AC supply.

Connecting to a Network

The projector comes standard with a LAN port (RJ-45) which provides a LAN connection using a LAN cable. Using a LAN cable allows you to specify the Network Settings and the Alert Mail Settings for the projector over a LAN. To use a LAN connection, you are required to assign an IP address to the projector on the [PROJECTOR NETWORK SETTINGS] screen of the web browser on your computer. For setting, see page 45, 46, 47.

Example of LAN connection

Example of wired LAN connection

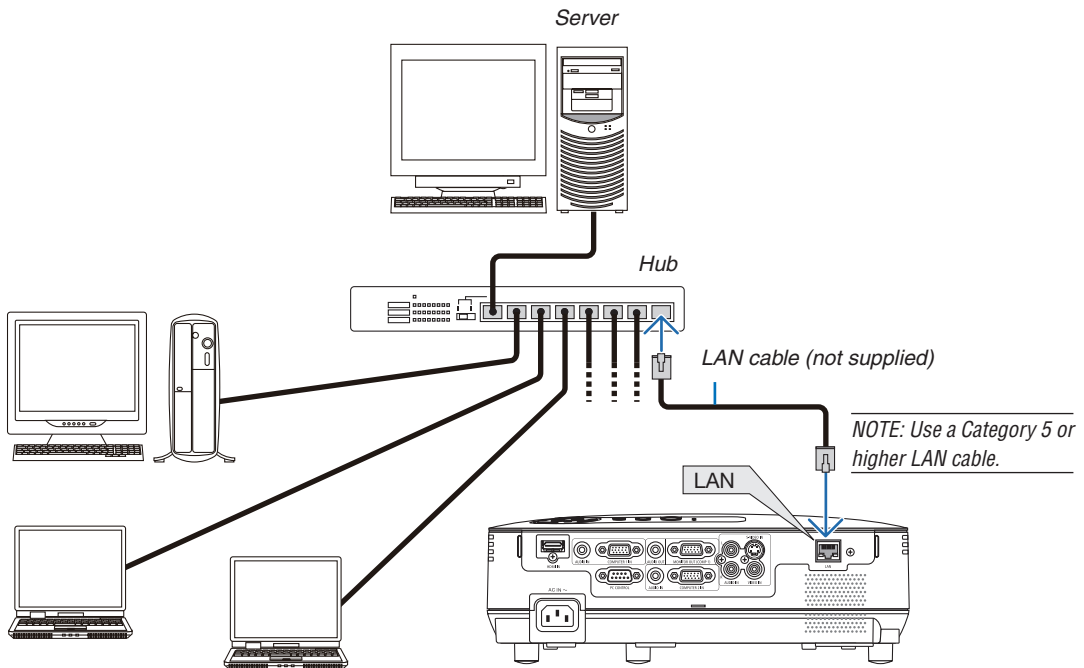

2. Installation and Connections

Connecting the Supplied Power Cord

Connect the supplied power cord to the projector.

First connect the supplied power cord's three-pin plug to the AC IN of the projector, and then connect the other plug of the supplied power cord in the wall outlet.

The projector will go into standby mode. When in standby mode, the POWER indicator will light orange and the STATUS indicator will light green when [NORMAL] is selected for [STANDBY MODE].

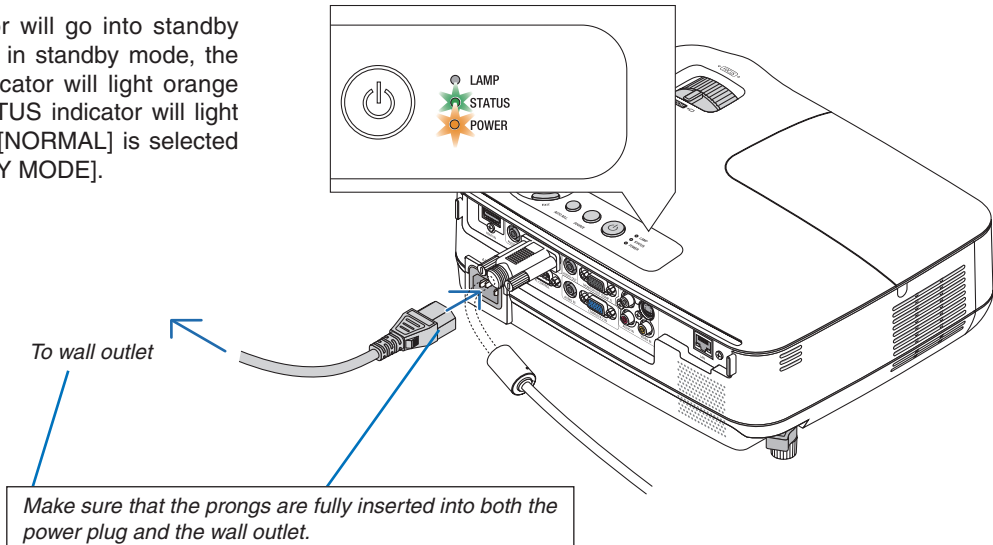

⚠ CAUTION:

Parts of the projector may become temporarily heated if the projector is turned off with the POWER button or if the AC power supply is disconnected during normal projector operation. Use caution when picking up the projector.

3. Projecting an Image (Basic Operation)

This section describes how to turn on the projector and to project a picture onto the screen.

1 Turning on the Projector

1. Remove the lens cap

- Do not remove the lens cap by pulling on the string. Doing so can cause mechanical damage to the part around the lens.

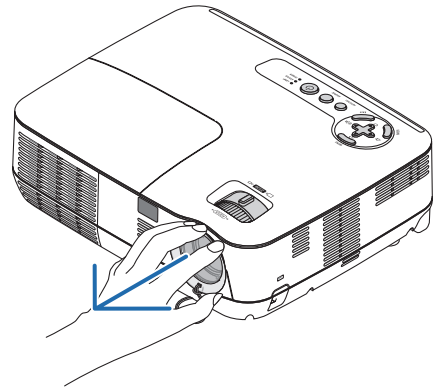

2. Press the (POWER) button on the projector cabinet or the POWER ON button on the remote control.

The POWER indicator will turn to green and the projector will become ready to use.

NOTE: When the projector is turned on, it may take some time before the lamp light becomes bright.

TIP:

- When the STATUS indicator lights orange, it means that the [CONTROL PANEL LOCK] is turned on. (→ page 68)
- When the message “Projector is locked! Enter your password.” is displayed, it means that the [SECURITY] is turned on. (→ page 34)

After you turn on your projector, ensure that the computer or video source is turned on and that your lens cap is removed.

NOTE: When no signal is available, the NEC logo (default), blue, or black screen will be displayed. After a lapse of 45 seconds from when the projector displays a blue, black or logo screen, [ECO MODE] will always switch to [ON]. This is done only when [ECO MODE] is set to [OFF].

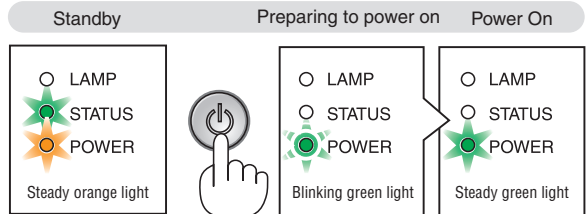
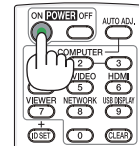
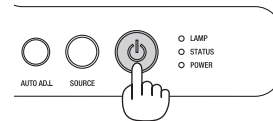

(→ page 84)

3. Projecting an Image (Basic Operation)

Note on Startup screen (Menu Language Select screen)

When you first turn on the projector, you will get the Startup menu. This menu gives you the opportunity to select one of the 27 menu languages.

To select a menu language, follow these steps:

1. Use the Δ , ∇ , \triangleleft or \triangleright button to select one of the 27 languages from the menu.

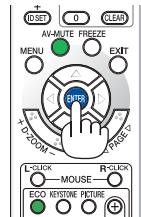
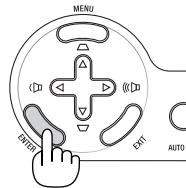
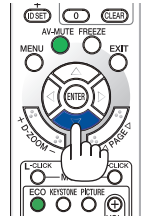
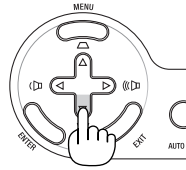

2. Press the ENTER button to execute the selection.

After this has been done, you can proceed to the menu operation.

If you want, you can select the menu language later.

(→ [LANGUAGE] on page 54 and 65)

NOTE:

- If one of the following things happens, the projector will not turn on.
 - If the internal temperature of the projector is too high, the projector detects abnormal high temperature. In this condition the projector will not turn on to protect the internal system. If this happens, wait for the projector's internal components to cool down.
 - When the lamp reaches its end of usable life, the projector will not turn on. If this happens, replace the lamp.
 - If the STATUS indicator lights orange as long as the POWER button is pressed, it means the CONTROL PANEL LOCK has been set.
 - If the lamp fails to light, and if the STATUS indicator flashes on and off in a cycle of six times, wait a full minute and then turn on the power.
- The projector cannot be turned off with the ON/STAND BY button or the POWER OFF button while the POWER indicator is flashing green in a cycle of 0.5 second on and 0.5 second off.
- Do not disconnect the AC power supply to the projector for 60 seconds immediately after turning it on and displaying an image.
- Immediately after turning on the projector, screen flicker may occur. This is normal. Wait 3 to 5 minutes until the lamp lighting is stabilized.
- If you turn on the projector immediately after the lamp is turned off or when the temperature is high, the fans run without displaying an image for some time and then the projector will display the image.

2 Selecting a Source

Selecting the computer or video source

NOTE: Turn on the computer or video source equipment connected to the projector.

Selecting from Source List

Press and quickly release the SOURCE button on the projector cabinet to display the Source list. Each time the SOURCE button is pressed, the input source will change as follows: "COMPUTER", "VIDEO", "S-VIDEO". To display the selected source, press the ENTER button or allow 2 seconds to elapse.

Detecting the Signal Automatically

Press the SOURCE button once. The projector will search for the available input source and display it. The input source will change as follows:

COMPUTER1 → COMPUTER2 → HDMI → VIDEO → S-VIDEO → COMPUTER1 → ...

TIP: If no input signal is present, the input will be skipped.

Using the Remote Control

Press any one of the COMPUTER 1, COMPUTER 2, HDMI, VIDEO, and S-VIDEO buttons.

Selecting Default Source

You can set a source as the default source so that it will be displayed each time the projector is turned on.

1. Press the MENU button.

The menu will be displayed.

2. Press the ▸ button twice to select [SETUP] and press the ▾ button or the ENTER button to select [GENERAL].

3. Press the ▸ button four times to select [OPTIONS(2)].

4. Press the ▾ button six times to select [DEFAULT SOURCE SELECT] and press the ENTER button.

The [DEFAULT SOURCE SELECT] screen will be displayed.

(→ page 73)

5. Select a source as the default source, and press the ENTER button.

6. Press the EXIT button a few times to close the menu.

7. Restart the projector.

The source you selected in step 5 will be projected.

TIP: When the projector is in Standby mode, applying a computer signal from a computer connected to the COMPUTER 1 IN input will power on the projector and simultaneously project the computer's image.

([AUTO POWER ON(COMP1)] → page 73)

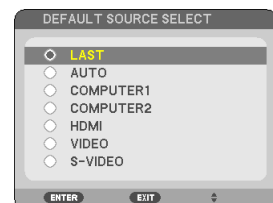
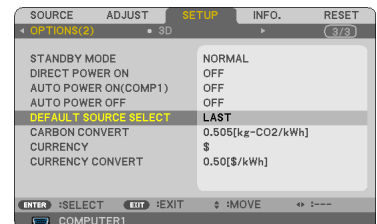
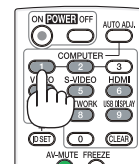
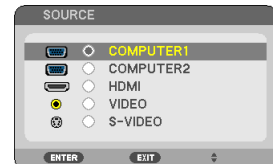
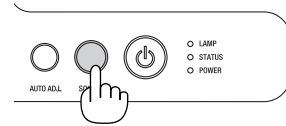

③ Adjusting the Picture Size and Position

Use the adjustable tilt foot, the zoom lever or the focus ring to adjust the picture size and position.
In this chapter drawings and cables are omitted for clarity.

Adjusting the throw angle (the height of an image)
[Tilt foot] (→ page 24)

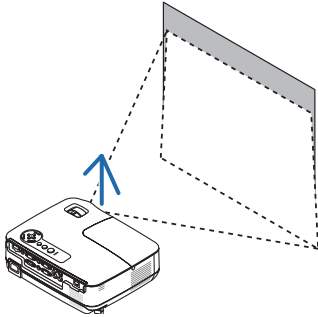

Adjusting the left and right tilt of an image
[Rear foot] (→ page 24)

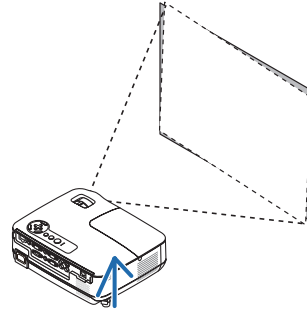

Finely adjusting the size of an image
[Zoom lever] (→ page 25)

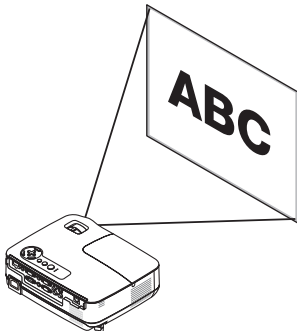

Adjusting the focus
[Focus ring] (→ page 25)

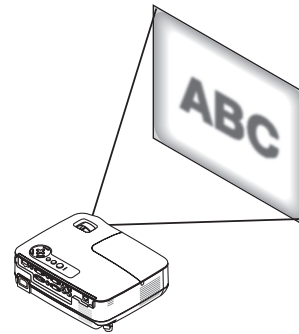

Adjusting the keystone correction [KEystone] (→ page 26)

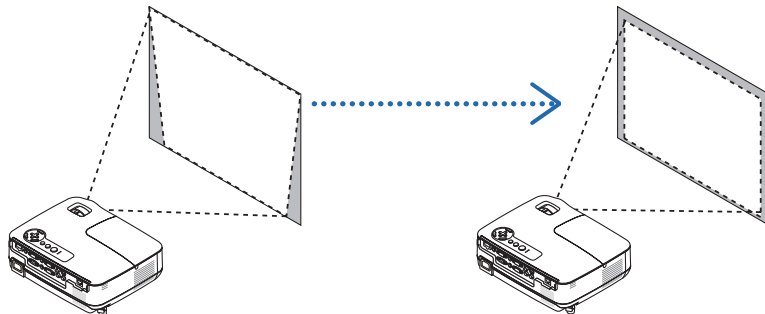

3. Projecting an Image (Basic Operation)

Adjust the Tilt Foot

1. Lift the front edge of the projector.

⚠ CAUTION:

Do not try to touch the ventilation outlet during Tilt Foot adjustment as it can become heated while the projector is turned on and after it is turned off.

2. Push up and hold the Adjustable Tilt Foot Lever on the front of the projector to extend the adjustable tilt foot.

3. Lower the front of the projector to the desired height.

4. Release the Adjustable Tilt Foot Lever to lock the Adjustable tilt foot.

The tilt foot can be extended up to 1.6 inch/40 mm.

There is approximately 10 degrees (up) of adjustment for the front of the projector.

Rotate the rear foot to the desired height in order to square the image on the projection surface.

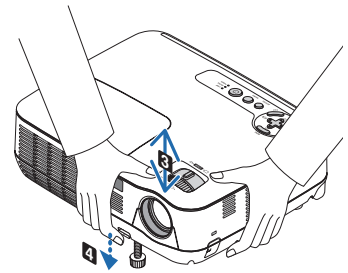
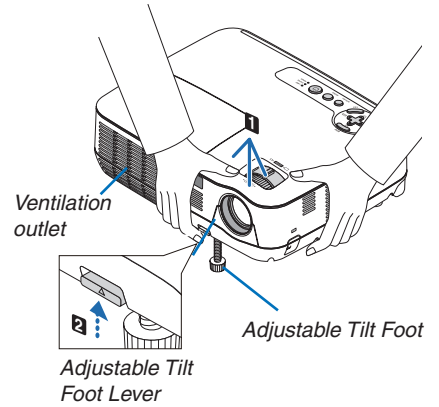

⚠ CAUTION:

- Do not use the tilt-foot for purposes other than originally intended. Misuses such as using the tilt foot to carry or hang (from the wall or ceiling) the projector can cause damage to the projector.

Adjusting the left and right tilt of an image [Rear foot]

1. Remove the spacer (black rubber) from the rear foot.

Keep the spacer for future use.

2. Rotate the rear foot.

The rear foot can be extended up to 0.4 inch/10 mm. Rotating the rear foot allows the projector to be placed horizontally.

NOTE: After using the projector, attach the spacer to the rear foot.

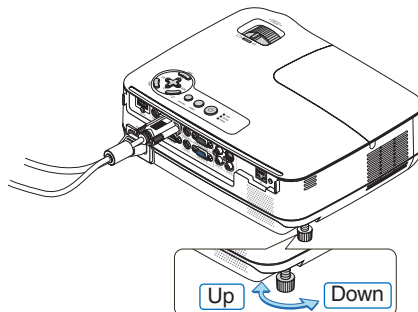
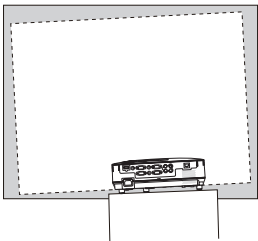
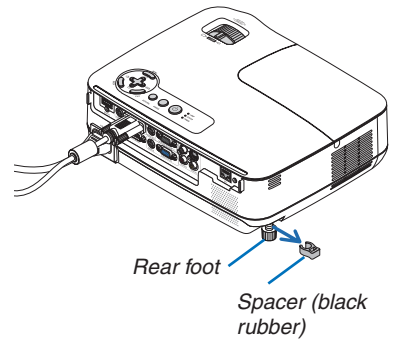

3. Projecting an Image (Basic Operation)

Zoom

Use the ZOOM lever to adjust the image size on the screen.

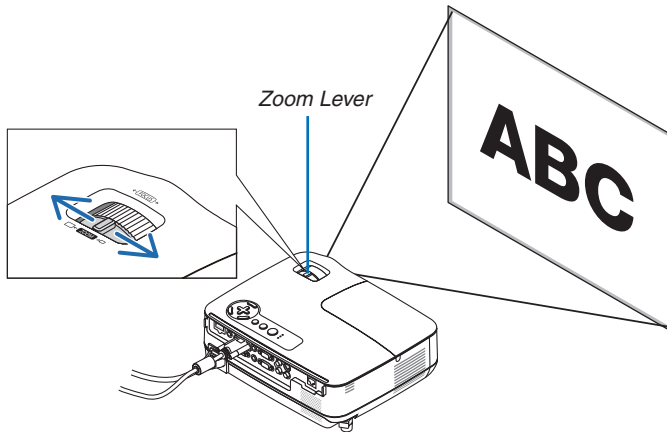

Focus

Use the FOCUS ring to obtain the best focus.

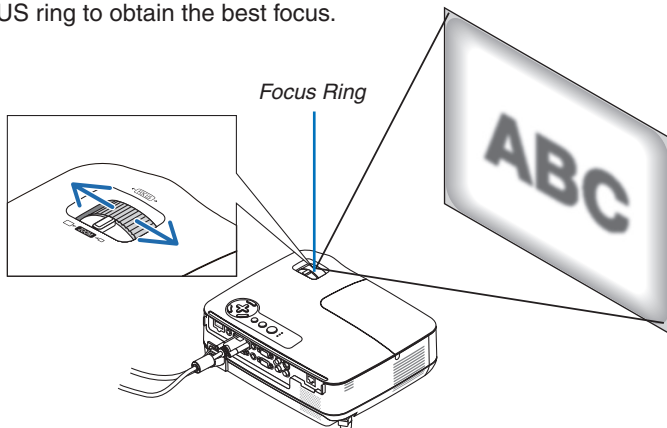

④ Correcting Keystone Distortion

Correcting Keystone Distortion

If the screen is tilted vertically, keystone distortion becomes large. Proceed with the following steps to correct keystone distortion

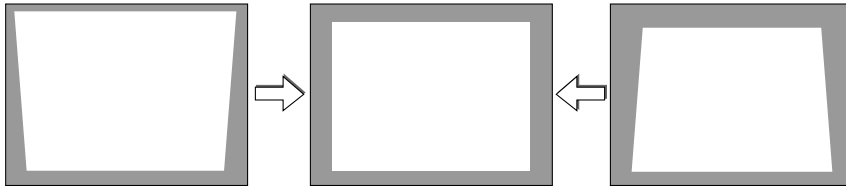

NOTE:

- The Keystone correction can cause an image to be slightly blurred because the correction is made electronically.
- The Keystone correction range can be made narrower, depending on a signal or its aspect ratio selection.

Adjusting with buttons on the cabinet

1. Press the Δ (\triangle) or ∇ (∇) button with no menus displayed.

The keystone bar will be displayed.

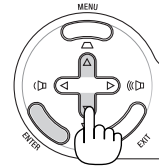
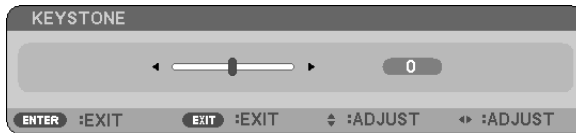

2. Use the Δ or ∇ to correct the keystone distortion.

Adjust so that the right and left sides are parallel.

3. Press the **ENTER** button.

The keystone bar will be closed.

NOTE: When the menu is displayed, the above operation is not available. When the menu is displayed, press the MENU button to close the menu and start the Keystone correction.

From the menu, select [SETUP] → [GENERAL] → [KEYSTONE]. The changes can be saved with [KEYSTONE SAVE]. (→ page 64)

3. Projecting an Image (Basic Operation)

Adjusting with the remote control

1. Press the KEYSTONE button.

The Keystone bar will be displayed.

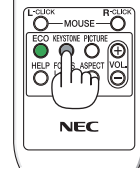

2. Use the ◀ or ▶ button to correct the keystone distortion.

Adjust so that the right and left sides are parallel.

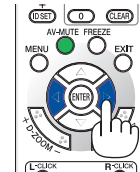
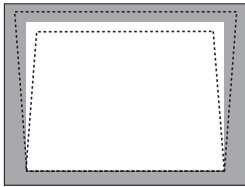

3. Press the ENTER button.

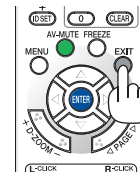

NOTE:

- The Keystone correction can cause an image to be slightly blurred because the correction is made electronically.
- The maximum range of vertical keystone correction is +/-40 degrees. This maximum range may be smaller depending on the signal or aspect ratio setting. The Keystone correction range will also be smaller when 3D mode is enabled.
- The range of keystone correction is not the maximum tilt angle of projector.
- The left and right (horizontal) keystone correction is not available.

TIP: The changes can be saved with [KEYSTONE SAVE]. (→ page 64)

5 Optimizing Computer Signal Automatically

Adjusting the Image Using Auto Adjust

Optimizing a computer image automatically.

Press the AUTO ADJ. button to optimize a computer image automatically.

This adjustment may be necessary when you connect your computer for the first time.

[Poor picture]

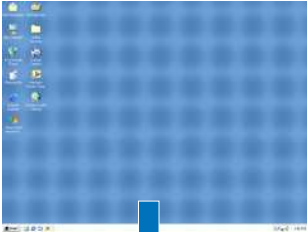

[Normal picture]

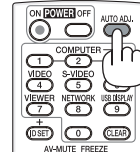
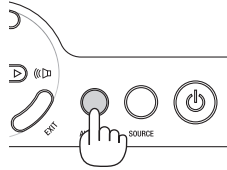
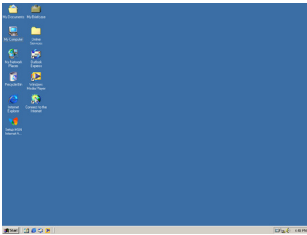

NOTE:

Some signals may take time to display or may not be displayed correctly.

- The Auto Adjust function will work for computer (RGB) signal only.
- If the Auto Adjust operation cannot optimize the computer signal, try to adjust [HORIZONTAL], [VERTICAL], [CLOCK], and [PHASE] manually. (→ page 60, 61)

6 Turning Up or Down Volume

Sound level from the speaker can be adjusted.

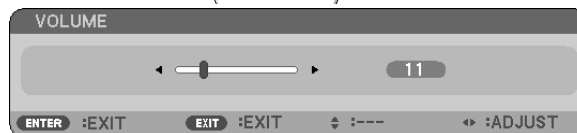
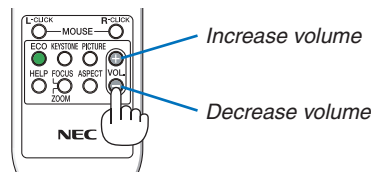

TIP: When no menus appear, the ◀ and ▶ buttons on the projector cabinet work as a volume control.

NOTE: The [BEEP] sound volume cannot be adjusted. To turn off the [BEEP] sound, from the menu, select [SETUP] → [OPTIONS (1)] → [BEEP] → [OFF]. (→ page 71)

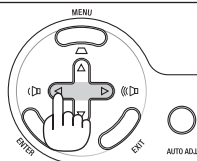

7 Turning off the Projector

To turn off the projector:

1. First, press the  (POWER) button on the projector cabinet or the POWER OFF button on the remote control.

The [POWER OFF / ARE YOU SURE? /CARBON SAVINGS- SESSION X.XXX[g-CO2]] message will appear.

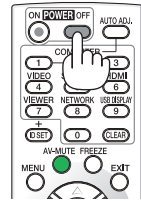
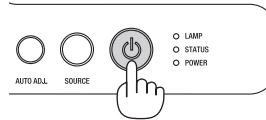
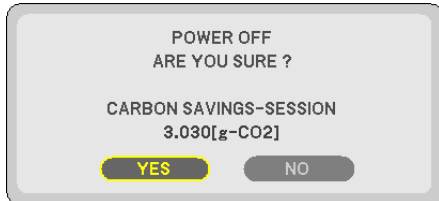

2. Secondly, press the ENTER button or press the  (POWER) or the POWER OFF button again.

The lamp will turn off and the projector will go into standby mode. When in standby mode, the POWER indicator will light orange and the STATUS indicator will light green when [NORMAL] is selected for [STANDBY MODE].

Immediately after turning on the projector and displaying an image, you cannot turn off the projector for 60 seconds.

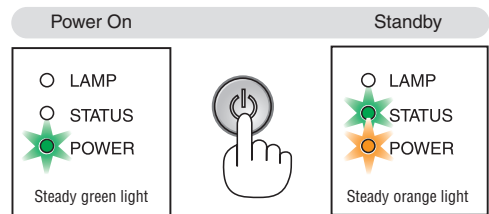

3. Finally, unplug the power cord.

The POWER indicator will go out.

CAUTION:

Parts of the projector may become temporarily heated if the AC power supply is disconnected either during normal projector operation or during cooling fan operation. Use caution when picking up the projector.

NOTE:

- Do not turn off the power for 60 seconds immediately after turning it on and displaying an image.
- Do not disconnect the AC power supply to the projector within 10 seconds of making adjustment or setting changes and closing the menu. Doing so can cause loss of adjustments and settings.

⑧ After Use

Preparation: Make sure that the projector is turned off.

1. *Disconnect any other cables.*
2. *Retract adjustable tilt foot if extended.*
3. *Cover the lens with the lens cap.*

4. Convenient Features

1 Turning off the Image and Sound

Press the AV-MUTE button to turn off the image and sound for a short period of time. Press again to restore the image and sound.

NOTE: Even though the image is turned off, the menu still remains on the screen.

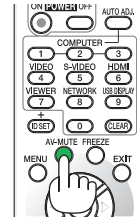

2 Freezing a Picture

Press the FREEZE button to freeze a picture. Press again to resume motion.

NOTE: The image is frozen but the original video is still playing back.

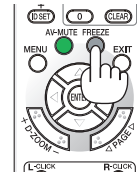

3 Enlarging a Picture

You can enlarge the picture up to four times.

NOTE: The maximum magnification may be less than four times depending on the signal or when [WIDE ZOOM] is selected for [ASPECT RATIO].

To do so:

1. Press the D-ZOOM (+) button to magnify the picture.

To move the magnified image, use the Δ , ∇ , \triangleleft or \triangleright button.

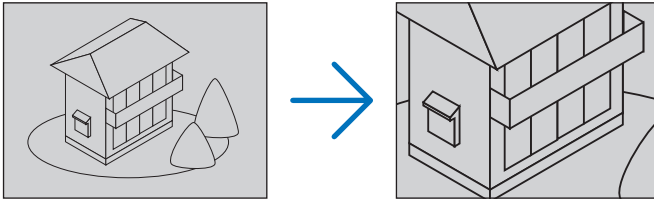

2. Press the Δ ∇ \triangleleft \triangleright button.

The area of the magnified image will be moved

3. Press the D-ZOOM (-) button.

Each time the D-ZOOM (-) button is pressed, the image is reduced.

NOTE:

- The image will be enlarged or reduced at the center of the screen.
- Displaying the menu will cancel the current magnification.

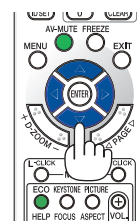
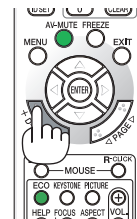

4 Changing Eco Mode

This feature enables you to select two brightness modes of the lamp: OFF and ON modes. The lamp life can be extended by turning on the [ECO MODE].

[ECO MODE]	Description	Status of LAMP indicator
[OFF]	This is the default setting (100% Brightness).	Off ○ LAMP ○ STATUS
[ON]	Select this mode to increase the lamp life (approx. 75% Brightness.)	Steady Green light ★ LAMP ○ STATUS

To turn on the [ECO MODE], do the following:

1. Press the **ECO** button on the remote control to display [ECO MODE] screen.
2. Use the **△** or **▽** button to select [ON].
3. Press the **ENTER** button.

To change from [ON] to [OFF], Go back to Step 2 and select [OFF]. Repeat Step 3.

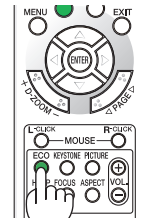

NOTE:

- The [ECO MODE] can be changed by using the menu. Select [SETUP] → [GENERAL] → [ECO MODE].
- The lamp life remaining and lamp hours used can be checked in [USAGE TIME]. Select [INFO.] → [USAGE TIME].
- The projector will always enter into the [ECO MODE] [ON] condition for 90 seconds immediately after the projector is turned on. The lamp condition will not be affected even when [ECO MODE] is changed within this time period.
- After a lapse of 45 seconds from when the projector displays a blue, black or logo screen, [ECO MODE] will automatically switch to [ON]. This is done only when [ECO MODE] is set to [OFF].
- If the projector is overheated in [OFF] mode, there may be a case where the [ECO MODE] automatically changes to [ON] mode to protect the projector. When the projector is in [ON] mode, the picture brightness decreases. When the projector comes back to normal temperature, the [ECO MODE] returns to [OFF] mode. Thermometer symbol [🌡️] indicates the [ECO MODE] is automatically set to [ON] mode because the internal temperature is too high.

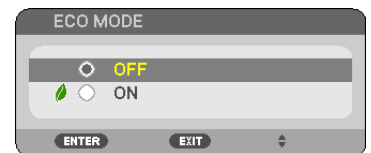

5 Checking Energy-Saving Effect [CARBON METER]

This feature will show energy-saving effect in terms of CO₂ emission reduction (kg) when the projector's [ECO MODE] is set to [ON]. This feature is called [CARBON METER].

There are two messages: [TOTAL CARBON SAVINGS/TOTAL COST SAVINGS] and [CARBON SAVINGS-SESSION]. The [TOTAL CARBON SAVINGS/TOTAL COST SAVINGS] message shows the total amount of CO₂ emission reduction and the electricity cost savings from the time of shipment up to now. You can check the information on [USAGE TIME] from [INFO.] of the menu. (→ page 77)

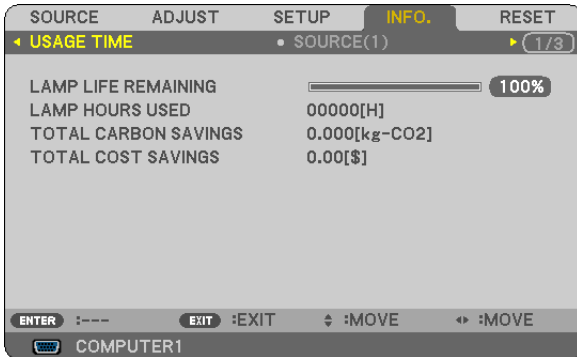

The [CARBON SAVINGS-SESSION] message shows the amount of CO₂ emission reduction between the time of changing to ECO MODE immediately after the time of power-on and the time of power-off. The [CARBON SAVINGS-SESSION] message will be displayed in the [POWER OFF/ ARE YOU SURE?] message at the time of power-off.

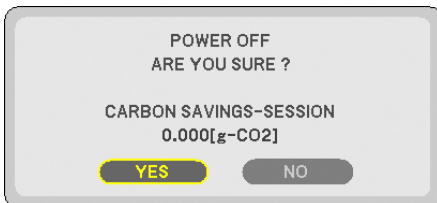

TIP:

- The formula as shown below is used to calculate the amount of CO₂ emission reduction.

$$\text{Amount of CO}_2 \text{ emission reduction} = \text{Power consumption in OFF for ECO MODE} - \text{Power consumption in ON for ECO MODE} \times \text{CO}_2 \text{ conversion factor.}^*$$
- * Calculation for amount of CO₂ emission reduction is based on an OECD publication "CO₂ Emissions from Fuel Combustion, 2008 Edition".
- This formula will not apply to the power consumption which is not affected by whether [ECO MODE] is turned on or off.
- The factors for [TOTAL COST SAVINGS] can be changed from the menu ([CARBON CONVERT] and [CURRENCY CONVERT]). (→ page 73, 74)
- The currency unit for [TOTAL COST SAVINGS] can be changed from the menu ([CURRENCY]). (→ page 74)

6 Preventing the Unauthorized Use of the Projector [SECURITY]

A keyword can be set for your projector using the Menu to avoid operation by an unauthorized user. When a keyword is set, turning on the projector will display the Keyword input screen. Unless the correct keyword is entered, the projector cannot project an image.

- The [SECURITY] setting cannot be cancelled by using the [RESET] of the menu.

To enable the Security function:

1. Press the MENU button.

The menu will be displayed.

2. Press the \triangleright button twice to select [SETUP] and press the ∇ button or the ENTER button to select [GENERAL].

3. Press the \triangleright button to select [INSTALLATION].

4. Press the ∇ button three times to select [SECURITY] and press the ENTER button.

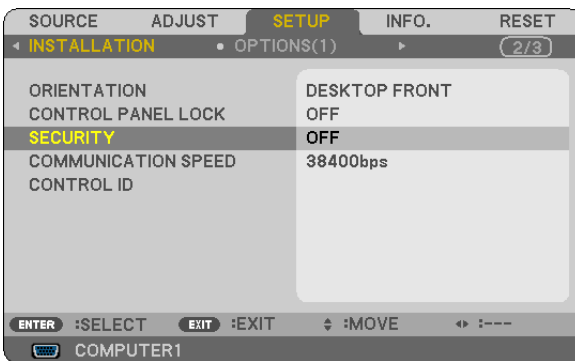

The OFF/ON menu will be displayed.

5. Press the ∇ button to select [ON] and press the ENTER button.

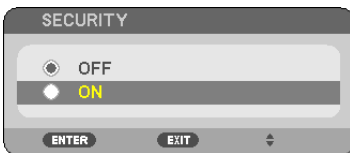

The [SECURITY KEYWORD] screen will be displayed.

6. Type in a combination of the four \triangle ∇ \triangleleft \triangleright buttons and press the ENTER button.

NOTE: A keyword must be 4 to 10 digits in length.



The [CONFIRM KEYWORD] screen will be displayed.

7. Type in the same combination of $\triangle \nabla \triangleleft \triangleright$ buttons and press the ENTER button.



The confirmation screen will be displayed.

8. Select [YES] and press the ENTER button.

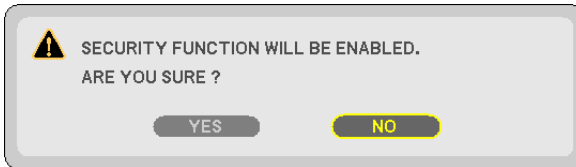

The SECURITY function has been enabled.

To turn on the projector when [SECURITY] is enabled:

1. Press and hold the POWER button.

The projector will be turned on and display a message to the effect that the projector is locked.

2. Press the MENU button.



3. Type in the correct keyword and press the ENTER button. The projector will display an image.



NOTE: The security disable mode is maintained until the power cord is unplugged.

To disable the SECURITY function:

1. Press the MENU button.

The menu will be displayed.

2. Select [SETUP] → [INSTALLATION] → [SECURITY] and press the ENTER button.

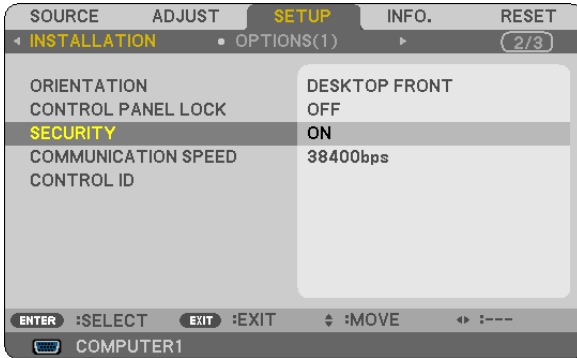

The OFF/ON menu will be displayed.

3. Select [OFF] and press the ENTER button.



The KEYWORD CONFIRMATION screen will be displayed.



4. Type in your keyword and press the ENTER button.

When the correct keyword is entered, the SECURITY function will be disabled.

NOTE: If you forget your keyword, contact your dealer. Your dealer will provide you with your keyword in exchange for your request code. Your request code is displayed in the Keyword Confirmation screen. In this example [K992-45L8-JNGJ-4XU9-1YAT-EEA2] is a request code.

⑦ Using the Optional Remote Mouse Receiver (NP01MR)

The optional remote mouse receiver enables you to operate your computer's mouse functions from the remote control. It is a great convenience for clicking through your computer-generated presentations.

Connecting the remote mouse receiver to your computer

If you wish to use the remote mouse function, connect the mouse receiver and computer.

The mouse receiver can be connected directly to the computer's USB port (type A).

NOTE: Depending on the type of connection or OS installed on your computer, you may have to restart your computer or change your computer settings.

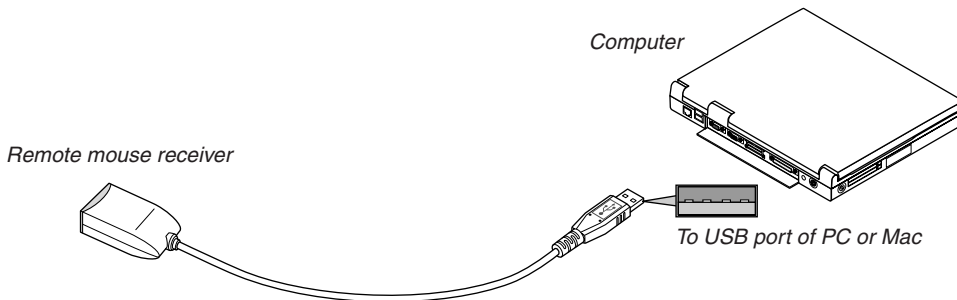

When operating a computer via the remote mouse receiver

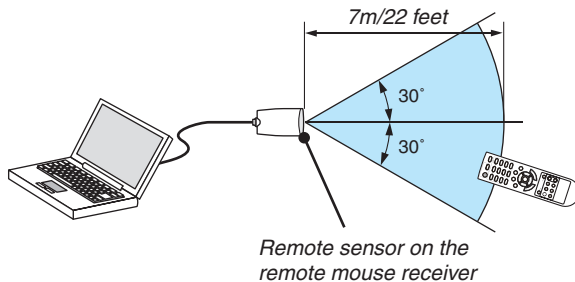

When connecting using the USB terminal

For PC, the mouse receiver can only be used with a Windows XP*, Windows 2000, Windows Vista, Windows 7, or Mac OS X 10.0.0 or later operating system.

** NOTE: In SP1 or older version of Windows XP, if the mouse cursor will not move correctly, do the following: Clear the Enhance pointer precision check box underneath the mouse speed slider in the Mouse Properties dialog box [Pointer Options tab].*

NOTE: The PAGE ▲ and ▼ buttons do not work with PowerPoint for Mac.

NOTE: Wait at least 5 seconds after disconnecting the mouse receiver before reconnecting it and vice versa. The computer may not identify the mouse receiver if it is repeatedly connected and disconnected in rapid intervals.

Operating your computer's mouse from the remote control

You can operate your computer's mouse from the remote control.

PAGE \triangle/∇ Button: scrolls the viewing area of the window or to move to the previous or next slide in PowerPoint on your computer.

$\triangle\nabla\triangleleft\triangleright$ Buttons: moves the mouse cursor on your computer.

MOUSE L-CLICK Button: works as the mouse left button.

MOUSE R-CLICK Button: works as the mouse right button.

NOTE:

- When you operate the computer using the $\triangle\nabla\triangleleft$ or \triangleright button with the menu displayed, both the menu and the mouse pointer will be affected. Close the menu and perform the mouse operation.
 - The PAGE \blacktriangle and \blacktriangledown buttons do not work with PowerPoint for Mac.
-

About Drag Mode:

By pressing the MOUSE L-CLICK or R-CLICK button for 2 or 3 seconds then releasing, the drag mode is set and the drag operation can be performed simply by pressing the $\triangle\nabla\triangleleft\triangleright$ button. To drop the item, press the MOUSE L-CLICK (or R-CLICK) button. To cancel it, press the MOUSE R-CLICK (or L-CLICK) button.

TIP: You can change the Pointer speed on the Mouse Properties dialog box on the Windows. For more information, see the user documentation or online help supplied with your computer.

⑧ Using the Computer Cable (VGA) to Operate the Projector (Virtual Remote Tool)

Using the utility software “Virtual Remote Tool” included on the companion NEC Projector CD-ROM, Virtual Remote screen (or toolbar) can be displayed on your computer screen.

This will help you perform operations such as projector’s power on or off and signal selection via the computer cable (VGA), serial cable, or LAN connection.



Virtual Remote screen

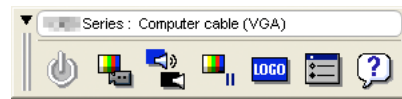

Toolbar

This section provides an outline of preparation for use of Virtual Remote Tool.

For information on how to use Virtual Remote Tool, see Help of Virtual Remote Tool. (→ page 44)

Step 1: Install Virtual Remote Tool on the computer. (→ page 40)

Step 2: Connect the projector to the computer. (→ page 42)

Step 3: Start Virtual Remote Tool. (→ page 43)

TIP:

- Virtual Remote Tool can be used with a LAN and a serial connection.
- For update information on Virtual Remote Tool, visit our website:
<http://www.nec-display.com/dl/en/index.html>

NOTE:

- When [COMPUTER1] is selected from your source selection, the Virtual Remote screen or the toolbar will be displayed as well as your computer screen.
- Use the supplied computer cable (VGA) to connect the COMPUTER 1 IN connector directly with the monitor output connector of the computer to use Virtual Remote Tool.
Using a switcher or other cables than the supplied computer cable (VGA) may cause failure in signal communication.
VGA cable connector:
Pin Nos. 12 and 15 are required for DDC/CI.
- Virtual Remote Tool may not work depending on your computer’s specifications and version of graphic adapters or drivers.
- The LOGO transfer function is not available on this series of projectors.

TIP:

- The projector’s COMPUTER 1 IN connector supports DDC/CI (Display Data Channel Command Interface). DDC/CI is a standard interface for bidirectional communication between display/projector and computer.

Step 1: Install Virtual Remote Tool on the computer

Supported OS

Virtual Remote Tool will run on the following operating systems.

Windows 8 *1, Windows 8 Pro *1, Windows 8 Enterprise *1
Windows 7 Home Basic, Windows 7 Home Premium, Windows 7 Professional, Windows 7 Ultimate, Windows 7 Enterprise, Windows Vista Home Basic, Windows Vista Home Premium, Windows Vista Business, Windows Vista Enterprise, Windows Vista Ultimate
Windows XP Home Edition *1, Windows XP Professional *1

*1: To run Virtual Remote Tool, "Microsoft .NET Framework Version 2.0" is required. The Microsoft .NET Framework Version 2.0, 3.0 or 3.5 is available from Microsoft's web page. Download and install it on your computer.

NOTE:

- To install Virtual Remote Tool, the Windows user account must have "Administrator" privilege (Windows 8, Windows 7, Windows Vista and Windows XP).
- Exit all running programs before installing Virtual Remote Tool. If another program is running, the installation may not be completed.

1 Insert the accompanying NEC Projector CD-ROM into your CD-ROM drive.

The folders in NEC Projector CD-ROM will be displayed. If the folders are not displayed, right-click the CD/DVD drive icon in Windows' "Computer" (or "My Computer") and select "Open".

2 Double-click "Software", "Virtual Remote Tool" and then "32bit" or "64bit".

The "VRT.exe" icon will be displayed.

3 Double-click the "VRT.exe" icon.

The Installer will start and the Wizard screen will appear.

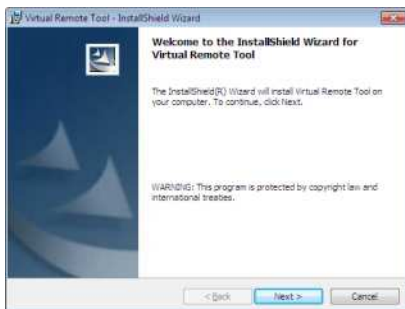

3 Click “Next”.

“END USER LICENSE AGREEMENT” screen will be displayed.



Read “END USER LICENSE AGREEMENT” carefully.

4 If you agree, click “I accept the terms in the license agreement” and then click “Next”.

- Follow the instructions on the installer screens to complete the installation.

TIP:

Uninstalling Virtual Remote Tool

Preparation:

Exit Virtual Remote Tool before uninstalling. To uninstall Virtual Remote Tool, the Windows user account must have “Administrator” privilege (Windows 8, Windows 7, and Windows Vista) or “Computer Administrator” privilege (Windows XP).

• For Windows 7/Windows Vista

1 Click “Start” and then “Control Panel”.

The Control Panel window will be displayed.

2 Click “Uninstall a program” under “Programs”

The “Programs and Features” window will be displayed.

3 Select Virtual Remote Tool and click it.

4 Click “Uninstall/Change” or “Uninstall”.

• When the “User Account Control” window is displayed, click “Continue”.

Follow the instructions on the screens to complete the uninstallation.

• For Windows XP

1 Click “Start” and then “Control Panel”.

The Control Panel window will be displayed.

2 Double-click “Add / Remove Programs”.

The Add / Remove Programs window will be displayed.

3 Click Virtual Remote Tool from the list and then click “Remove”.

Follow the instructions on the screens to complete the uninstallation.

Step 2: Connect the projector to the computer

1 Use the supplied computer cable (VGA) to connect the COMPUTER 1 IN connector of the projector directly with the monitor output connector of the computer.

2 Connect the supplied power cord to the AC IN of the projector and the wall outlet.

The projector is in the standby condition.

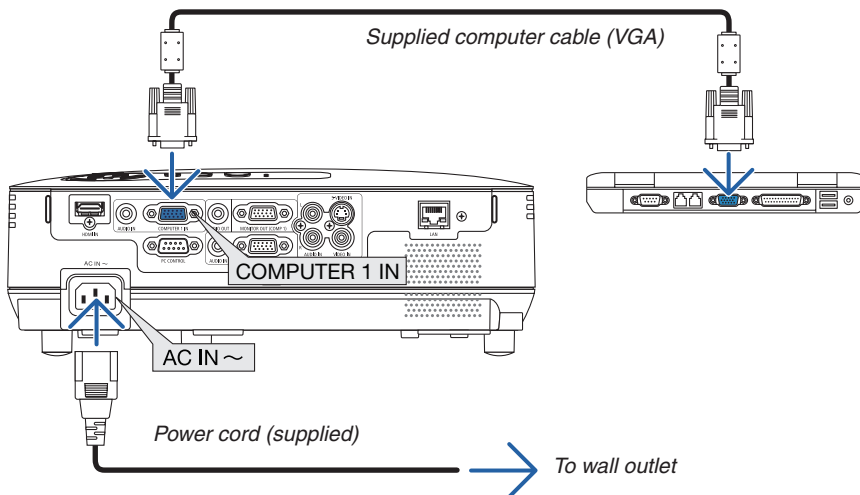

TIP:

- When Virtual Remote Tool starts for the first time, “Easy Setup” window will be displayed to navigate your connections.

Step 3: Start Virtual Remote Tool

Start using the shortcut icon

- Double-click the shortcut icon  on the Windows Desktop.

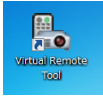

Start from the Start menu

- Click [Start] → [All Programs] or [Programs] → [NEC Projector User Supportware] → [Virtual Remote Tool] → [Virtual Remote Tool].

When Virtual Remote Tool starts for the first time, “Easy Setup” window will be displayed.



Follow the instructions on the screens

When “Easy Setup” is completed, the Virtual Remote Tool screen will be displayed.



NOTE:

- When [POWER-SAVING] is selected for [STANDBY MODE] from the menu, the projector cannot be turned on via the computer cable (VGA) or network (wired LAN/wireless LAN) connection.
-

TIP:

- The Virtual Remote Tool screen (or Toolbar) can be displayed without displaying “Easy Setup” window. To do so, click to place a check mark for “ Do not use Easy Setup next time” on the screen at Step 6 in “Easy Setup”.

Exiting Virtual Remote Tool

1 **Click the Virtual Remote Tool icon**  **on the Taskbar.**

The pop-up menu will be displayed.



2 **Click “Exit”.**

The Virtual Remote Tool will be closed.

Viewing the help file of Virtual Remote Tool

• **Displaying the help file using the taskbar**

1 **Click the Virtual Remote Tool icon**  **on the taskbar when Virtual Remote Tool is running.**

The pop-up menu will be displayed.

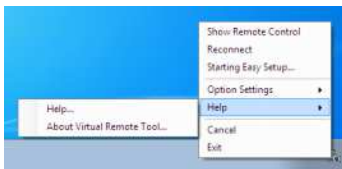

2. **Click “Help”.**

The Help screen will be displayed.

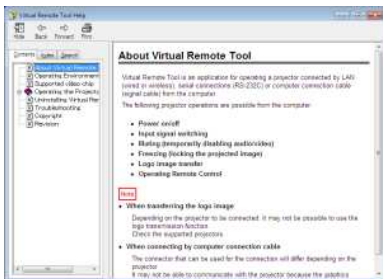

• **Displaying the help file using the Start Menu.**

1. **Click “Start”. “All programs” or “Programs”. “NEC Projector User Supportware”. “Virtual Remote Tool”. and then “Virtual Remote Tool Help” in this order.**

The Help screen will be displayed.

9 Network Setting by Using an HTTP Browser

Overview

Connecting the projector to a network allows the Alert Mail setting (→ page 47) and the projector control from a computer via the network.

To perform the projector control, you must have an exclusive application installed on your computer.

The IP address and subnet mask of the projector can be set on the Network Setting screen of the web browser by using an HTTP server function. Please be sure to use “Microsoft Internet Explorer 6.0” or a higher version for the web browser. (This device uses “JavaScript” and “Cookies” and the browser should be set to accept these functions. The setting method will vary depending on the version of browser. Please refer to the help files and the other information provided in your software.)

Access is gained to the HTTP server function by starting the Web browser on the computer via the network connected to the projector and enter the following URL.

- Network Setting
http://<the projector's IP address>/index.html
- Alert Mail Setting
http://<the projector's IP address>/lanconfig.html

TIP:

- The default IP address is “192.168.0.10”.
- The exclusive application can be downloaded from our website.

NOTE:

- If the **PROJECTOR NETWORK SETTINGS** screen does not appear in the web browser, press the **Ctrl+F5** keys to refresh your web browser (or clear the cache).
 - The display's or button's response can be slowed down or operation may not be accepted depending the settings of your network. Should this happen, consult your network administrator.
The projector may not respond if its buttons are repeatedly pressed in rapid intervals. Should this happen, wait a moment and repeat. If you still can't get any response, turn off and back on the projector.
-

Preparation Before Use

Connect the projector to a commercially available LAN cable before engaging in browser operations. (→ page 18)

Operation with a browser that uses a proxy server may not be possible depending on the type of proxy server and the setting method. Although the type of proxy server will be a factor, it is possible that items that have actually been set will not be displayed depending on the effectiveness of the cache, and the contents set from the browser may not be reflected in operation. It is recommended that a proxy server not be used unless it is unavoidable.

Handling of the Address for Operation via a Browser

Regarding the actual address that is entered for the address or entered to the URL column when operation of the projector is via a browser, the host name can be used as it is when the host name corresponding to the IP address of the projector has been registered to the domain name server by a network administrator, or the host name corresponding to the IP address of the projector has been set in the “HOSTS” file of the computer being used.

Example 1: When the host name of the projector has been set to “pj.nec.co.jp”, access is gained to the network setting by specifying

http://pj.nec.co.jp/index.html

for the address or the entry column of the URL.

Example 2: When the IP address of the projector is “192.168.73.1”, access is gained to the mail alert settings by specifying

http://192.168.73.1/index.html

for the address or the entry column of the URL.

Network Settings

<http://<the projector's IP address> /index.html>

PROJECTOR NETWORK SETTINGS

ITEM	CURRENT VALUE	NEW VALUE
PHYSICAL ADDRESS		
MAC ADDRESS	00-30-13-9F-7E-6D	CANNOT BE MODIFIED
IP NETWORK		
DHCP	DISABLE	<input type="radio"/> ENABLE <input checked="" type="radio"/> DISABLE
IP ADDRESS	192.168.0.10	192 168 0 10
SUBNET MASK	255.255.255.0	255 255 255 0
DEFAULT GATEWAY	192.168.0.1	192 168 0 1
DNS(PRIMARY)	0.0.0.0	0 0 0 0
DNS(SECONDARY)	0.0.0.0	0 0 0 0
CRESTRON CONTROL		
CONTROL SYSTEM	DISABLE	<input type="radio"/> ENABLE <input checked="" type="radio"/> DISABLE
IP ADDRESS	0.0.0.0	0 0 0 0
IP ID	0	0

FIRMWARE VERSION : 0.06 / MODEL : V00000

DHCP Enabling this option automatically assigns an IP address to the projector from your DHCP server. Disabling this option allows you to register the IP address or subnet mask number obtained from your network administrator.

TIP: You can check the IP address in the menu when [ENABLE] is selected for [DHCP]. To do so, from the menu, select [INFO.]

IP ADDRESS Set your IP address of the network connected to the projector when [DISABLE] is selected for [DHCP].

TIP: You can check your specified IP address in the menu To do so, from the menu, select [INFO.] → [WIRED LAN].

SUBNET MASK Set your subnet mask number of the network connected to the projector when [DISABLE] is selected for [DHCP].

DEFAULT GATEWAY Set your default gateway of the network connected to the projector when [DISABLE] is selected for [DHCP].

DNS (PRIMARY) Set your primary DNS settings of the network connected to the projector.

DNS (SECONDARY) Set your secondary DNS settings of the network connected to the projector.

UPDATE Reflect your settings.

NOTE: Close the browser after clicking [UPDATE]. The projector will automatically update your settings.

TIP: Selecting [NETWORK SETTINGS] for [RESET] from the projector's menu allows you to return the following items to the factory default.

[DHCP]: DISABLE/ [IP ADDRESS]: 192.168.0.10/ [SUBNET MASK]: 255.255.255.0/ [DEFAULT GATEWAY]: 192.168.0.1

** [DNS(PRIMARY)] and [DNS(SECONDARY)] will remain unchanged.*

TIP: The CRESTRON CONTROL settings are required only for use with CRESTRON ROOMVIEW.

For more information, visit <http://www.crestron.com>

Alert Mail Setting

http://<the projector's IP address>/lanconfig.html

PROJECTOR NETWORK SETTINGS

ITEM	VALUE
DOMAIN	
HOST NAME	<input type="text"/>
DOMAIN NAME	<input type="text"/>
MAIL	
ALERT MAIL	<input type="checkbox"/> ENABLE <input type="checkbox"/> DISABLE
SENDER'S ADDRESS	<input type="text"/>
SMTP SERVER NAME	<input type="text"/>
RECIPIENT'S ADDRESS 1	<input type="text"/>
RECIPIENT'S ADDRESS 2	<input type="text"/>
RECIPIENT'S ADDRESS 3	<input type="text"/>
<input type="button" value="APPLY"/>	
TEST MAIL	
<input type="button" value="EXECUTE"/>	STATUS
	<input type="text"/>

This option notifies your computer of an error message via e-mail when using wired LAN. An error message notification will be sent when the projector lamp has reached the end of its usable life or an error occurs in the projector.

- HOST NAME Type in the hostname of the network connected to the projector. Up to 60 alphanumeric characters can be used. If the host name is unknown, type in a string of characters representing the projector. Example: Projector 1
- DOMAIN NAME Type in the domain name of the network connected to the projector. Up to 60 alphanumeric characters can be used. If the domain name is unknown, type in the right side of @ in the sender's address. Example: nec. com
- ALERT MAIL Checking [ENABLE] will turn on the Alert Mail feature.
Checking [DISABLE] will turn off the Alert Mail feature.
- SENDER'S ADDRESS..... Type in the senders address. Up to 60 alphanumeric and symbols characters can be used.
- SMTP SERVER NAME..... Type in the SMTP server name to be connected to the projector. Up to 60 alphanumeric characters can be used.
- RECIPIENT'S ADDRESS 1 to 3.... Type in your recipient's address. Up to 60 alphanumeric and symbols characters can be used.
- APPLY..... Click this button to reflect the above settings
- EXECUTE Click this button to send a test mail to check if your settings are correct.
- STATUS..... A reply to a test mail will be displayed.

NOTE:

- If you execute a test, you may not receive an Alert mail. Should this happen, check if the network settings are correct.
- If you entered an incorrect address in a test, you may not receive an Alert mail. Should this happen, check if the Recipient 's Address is correct

TIP: The Alert Mail settings will not be affected even when [RESET] is done from the menu.

10 Viewing 3D Images

The projector provides 3D images to a user wearing commercially available LCD shutter eyeglasses.

CAUTION

Health precautions

Before viewing, be sure to read health care precautions that may be found in the user's manual included with your LCD shutter eyeglasses or your 3D compatible content such as DVDs, video games, computer's video files and the like. To avoid any adverse symptoms, heed the following:

- Do not use LCD shutter eyeglasses for viewing any material other than 3D images.
- Allow a distance of 2 m/7 feet or greater between the screen and a user. Viewing 3D images from too close a distance can strain your eyes.
- Avoid viewing 3D images for a prolonged period of time. Take a break of 15 minutes or longer after every hour of viewing.
- If you or any member of your family has a history of light-sensitive seizures, consult a doctor before viewing 3D images.
- While viewing 3D images, if you get sick such as nausea, dizziness, queasiness, headache, eyestrain, blurry vision, convulsions, and numbness, stop viewing them. If symptoms still persist, consult a doctor.
- View 3D images from the front of the screen. Viewing from an angle may cause fatigue or eyestrain.

LCD shutter eyeglasses (recommended)

- Optional eyeglasses (NP02GL)
- NVIDIA® 3D Vision™ (V311X/V311W only)

You can also use commercially available DLP® Link compatible LCD shutter eyeglasses.

Steps for viewing 3D images on the projector

1. Connect the projector to your video equipment.

2. Turn on the projector, display the on-screen menu, and then select [ON] for the 3D mode.

For the operating procedure to turn on the 3D mode, refer to "On-screen menu for 3D images" on the following page.

3. Play your 3D compatible content and use the projector to display the image.

4. Put on your LCD shutter eyeglasses to view 3D images.

Also refer to the user's manual accompanied with your LCD shutter eyeglasses for more information.

On-screen menu for 3D images

Follow the steps to display the 3D menu.

1. Press the *MENU* button.

The [*SOURCE*] menu will be displayed.



2. Press the *▷* button twice.

The [*SETUP*] menu will be displayed.



3. Press the *▽* button once, and then press the *▷* button five times.

The [*3D*] menu will be displayed

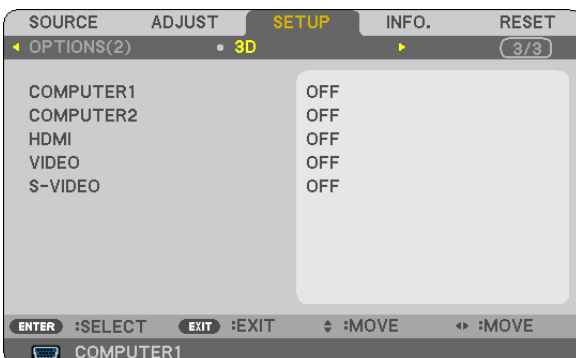

4. Press the *▽* button to select a signal and press the *ENTER* button.

5. Press the *▽* button to select [*3D*] and press the *ENTER* button.

The 3D (DETAIL SETTINGS) screen will be displayed.

6. Press the *▽* button to select [*ON*].

The selected signal will be displayed in 3D.

7. Press the ▾ button to [GLASSES] and press the ENTER button.

The [GLASSES] setting screen will be displayed.

8. Press the ▾ button to select a compatible eyeglass method and press the ENTER button.

(→ **page 75**)

Set other 3D-related menu options such as [FORMAT] and [L/R INVERT] as necessary.

9. Press the MENU button once.

The menu will disappear.

Selecting input connected to a source of 3D images [COMPUTER1/COMPUTER2/HDMI/VIDEO/S-VIDEO]

This function switches the 3D mode between ON and OFF for each input.

NOTE:

To confirm that the supported 3D signal is accepted, use either way of the following:

- Make sure that [3D] is displayed in the top right of the screen after the source is selected.
- Display [INFO.] → [SOURCE] → [3D SIGNAL] and make sure that "SUPPORTED" is displayed.

Using NVIDIA® 3D Vision™ (V311X/V311W only)

1. Setting a computer

(1) Prepare and set devices required for NVIDIA® 3D Vision™.

For more information, visit NVIDIA® website.

http://www.nvidia.com/object/3D_Vision_Requirements.html

(2) From the website of NVIDIA®, download the updated driver of an appropriate graphics board for the projector, and install it to your computer.

To view 3D images, see page 48.

Select [COMPUTER1], [COMPUTER2], or [HDMI].

NOTE:

- The maximum distance for viewing 3D images is 10 m/394 inches from the screen surface under the following restrictions:
 - Brightness on the projector: 2000 lumens or greater
 - Screen gain: 1
 - Viewing position: Facing straight towards the screen center
 - Outside light: None
 - LCD shutter eyeglasses: Using the optional 3D Goggles (NP02GL)
- If 3D content is played back on your computer and the performance is poor it may be caused by the CPU or graphics chip. In this case you may have difficulty seeing the 3D images as they were intended. Check to see if your computer meets the requirements provided in your user's manual included with your 3D content.
- The DLP® Link compatible LCD shutter eyeglasses allow you to view 3D images by receiving synch signals, which are included in left eye and right eye images, reflected from the screen. Depending on environments or conditions such as the ambient brightness, screen size or viewing distance, the LCD shutter eyeglasses may fail to receive synch signals, causing poor 3D images.
- When the 3D mode is enabled, the Keystone correction range will be narrower.
- When the 3D mode is enabled, the following settings are invalid.
[WALL COLOR], [PRESET], [REFERENCE], [COLOR TEMPERATURE]
- Refer to the [SOURCE] screen under the [INFO.] menu for information on whether the input signal is 3D compatible.
- Signals other than those listed in "Compatible Input Signal List" on page 91 will be out of range or will be displayed in 2D.

Troubleshooting on viewing 3D images

If images will not be displayed in 3D or 3D images appear as 2D, check the following table. Also refer to the user's manual accompanied with your 3D content or LCD shutter eyeglasses.

Possible causes	Solutions
<ul style="list-style-type: none"> The content you are playing back is not compatible with 3D. 	<ul style="list-style-type: none"> Play back a content compatible with 3D.
<ul style="list-style-type: none"> The 3D mode was turned off for the selected source. 	<ul style="list-style-type: none"> Use the projector's menu to turn on 3D mode for the selected source. (→ page 75)
<ul style="list-style-type: none"> You are not using our recommended LCD shutter eyeglasses. 	<ul style="list-style-type: none"> Use our recommended LCD shutter eyeglasses. (→ page 48)
<ul style="list-style-type: none"> If the shutter of your LCD shutter eyeglasses cannot synchronize with the currently projected source, the following are possible causes: <ul style="list-style-type: none"> Your LCD shutter eyeglasses are not switched on. The battery in the LCD shutter eyeglasses ran down. The correct eyeglass method is not selected. 	<ul style="list-style-type: none"> Switch on your LCD shutter eyeglasses. Recharge the battery or replace it. Change the eyeglass method for 3D by using the menu.. (→ page 75)
<ul style="list-style-type: none"> The viewing distance between the viewer and the screen is too far. 	<ul style="list-style-type: none"> Move closer to the screen until the viewer gets 3D images. Or use the projector's menu to select [NON-INVERT] for [L/R INVERT].
<ul style="list-style-type: none"> There are bright light sources or other projectors near the viewer. 	<ul style="list-style-type: none"> Keep light sources or other projectors away from the viewer. Do not look toward a bright light source. Or use the projector's menu to select [NON-INVERT] for [L/R INVERT].
<ul style="list-style-type: none"> If your computer is not set for 3D viewing, the following are possible causes: <ul style="list-style-type: none"> Your computer does not meet the requirements for 3D viewing. Your computer is not set for 3D output. The resolution of output signal is out of range. The refresh rate of output signal is out of range. 	<ul style="list-style-type: none"> Check to see if your computer meets the requirements provided in your user's manual included with your 3D content. Set your computer for 3D output. Select the resolution of output signal supporting 3D. Change the refresh rate to 60Hz or 120Hz.

5. Using On-Screen Menu

① Using the Menus

NOTE: The on-screen menu may not be displayed correctly while interlaced motion video image is projected.

1. Press the **MENU** button on the remote control or the projector cabinet to display the menu.

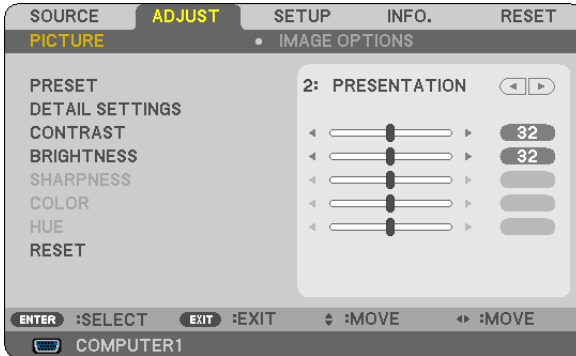

NOTE: The commands such as ENTER, EXIT, Δ ∇ , \triangleleft \triangleright in the bottom show available buttons for your operation.

2. Press the \triangleleft \triangleright buttons on the remote control or the projector cabinet to display the submenu.
3. Press the **ENTER** button on the remote control or the projector cabinet to highlight the top item or the first tab.
4. Use the Δ ∇ buttons on the remote control or the projector cabinet to select the item you want to adjust or set.
You can use the \triangleleft \triangleright buttons on the remote control or the projector cabinet to select the tab you want.
5. Press the **ENTER** button on the remote control or the projector cabinet to display the submenu window.
6. Adjust the level or turn the selected item on or off by using the Δ ∇ \triangleleft \triangleright buttons on the remote control or the projector cabinet.
Changes are stored until adjusted again.
7. Repeat steps 2-6 to adjust an additional item, or press the **EXIT** button on the remote control or the projector cabinet to quit the menu display.

NOTE: When a menu or message is displayed, several lines of information may be lost, depending on the signal or settings.

8. Press the **MENU** button to close the menu.
To return to the previous menu, press the **EXIT** button.

2 Menu Elements

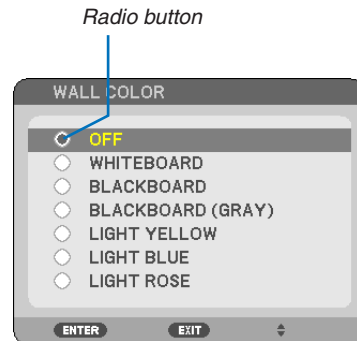
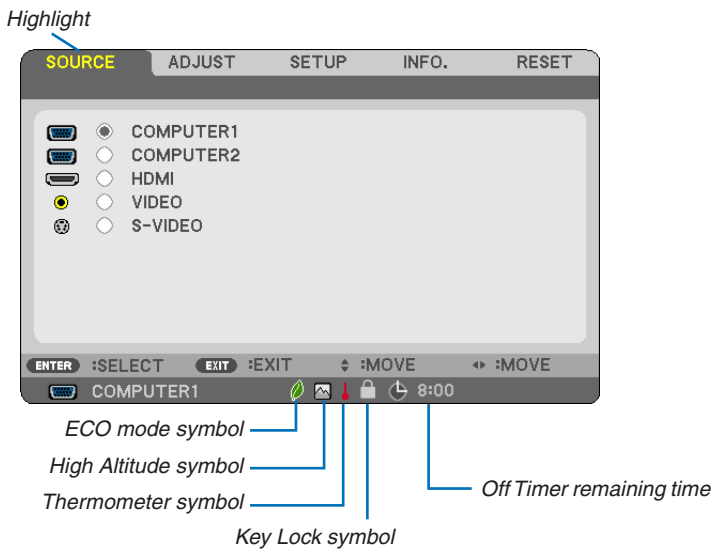
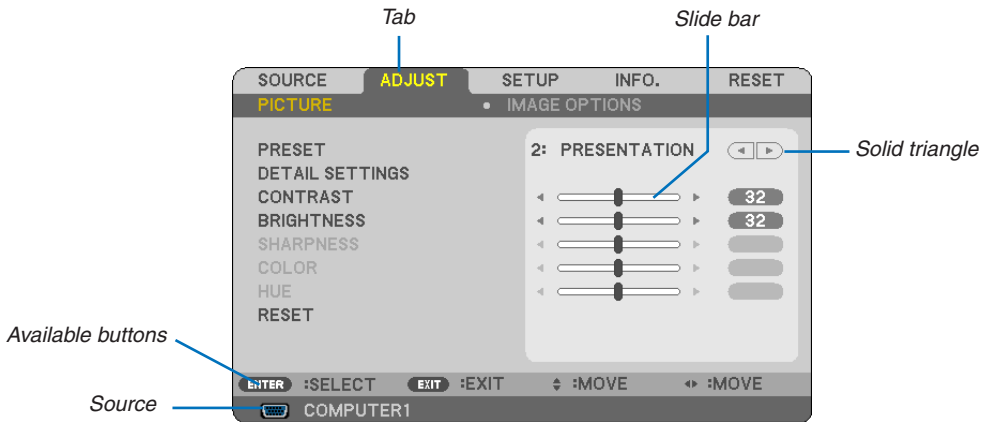

Menu windows or dialog boxes typically have the following elements:

- Highlight..... Indicates the selected menu or item.
- Solid triangle Indicates further choices are available. A highlighted triangle indicates the item is active.
- Tab..... Indicates a group of features in a dialog box. Selecting on any tab brings its page to the front.
- Radio button..... Use this round button to select an option in a dialog box.
- Source Indicates the currently selected source.
- Off Timer remaining time.... Indicates the remaining countdown time when the [OFF TIMER] is preset.
- Slide bar Indicates settings or the direction of adjustment.
- ECO mode symbol Indicates ECO MODE is set.
- Key Lock symbol Indicates the [CONTROL PANEL LOCK] is enabled.
- Thermometer symbol Indicates the [ECO MODE] is forcibly set to [ON] mode because the internal temperature is too high.
- High Altitude symbol Indicates the [FAN MODE] is set to [HIGH ALTITUDE] mode.

③ List of Menu Items

Some menu items are not available depending on the input source.

Menu Item		Default	Options	
SOURCE	COMPUTER1, COMPUTER2	*		
	HDMI	*		
	VIDEO	*		
	S-VIDEO	*		
ADJUST	PICTURE	PRESET	1-6	
		DETAIL SETTINGS	REFERENCE	HIGH-BRIGHT, PRESENTATION, VIDEO, MOVIE, GRAPHIC, sRGB
			GAMMA CORRECTION	DYNAMIC, NATURAL, BLACK DETAIL
			COLOR TEMPERATUR	5000, 6500, 7800, 9300
			BrilliantColor	OFF, ON
		DYNAMIC CONTRAST	OFF, ON	
		CONTRAST		
		BRIGHTNESS		
		SHARPNESS		
		COLOR		
	HUE			
	RESET			
	IMAGE OPTIONS	CLOCK	*	
		PHASE	*	
		HORIZONTAL	*	
		VERTICAL	*	
		OVERSCAN	AUTO	AUTO, OFF, ON
		ASPECT RATIO	*	V311X: AUTO, 4:3, 16:9, 15:9, 16:10, WIDE ZOOM, NATIVE V311W/V281W: AUTO, 4:3, 16:9, 15:9, 16:10, LETTER BOX, NATIVE
		POSITION (V311X)	0	-16 to +16
		NOISE REDUCTION	LOW	OFF, LOW, MEDIUM, HIGH
TELECINE	2-2/2-3 AUTO	OFF, 2-2/2-3 AUTO, 2-2 ON, 2-3 ON		
GENERAL	KEYSTONE	0	-40° to +40°	
	KEYSTONE SAVE	OFF	OFF, ON	
	WALL COLOR	OFF	OFF, WHITEBOARD, BLACKBOARD, BLACKBOARD (GRAY), LIGHT YELLOW, LIGHT BLUE, LIGHT ROSE	
	ECO MODE	OFF	OFF, ON	
	CLOSED CAPTION	OFF	OFF, CAPTION1, CAPTION2, CAPTION3, CAPTION4, TEXT1, TEXT2, TEXT3, TEXT4	
	OFF TIMER	OFF	OFF, 0:30, 1:00, 2:00, 4:00, 8:00, 12:00, 16:00	
	LANGUAGE	ENGLISH	ENGLISH, DEUTSCH, FRANÇAIS, ITALIANO, ESPAÑOL, SVENSKA, 日本語 DANSK, PORTUGUÊS, ČEŠTINA, MAGYAR, POLSKI, NEDERLANDS, SUOMI NORSK, TÜRKÇE, РУССКИЙ, عربي, Ελληνικά, 中文, 한국어 ROMÂNĂ, HRVATSKA, БЪЛГАРСКИ, INDONESIA, हिन्दी, ไทย	
	MENU	COLOR SELECT	COLOR	COLOR, MONOCHROME
		SOURCE DISPLAY	ON	OFF, ON
		ID DISPLAY	ON	OFF, ON
		ECO MESSAGE	OFF	OFF, ON
		DISPLAY TIME	AUTO 45 SEC	MANUAL, AUTO 5 SEC, AUTO 15 SEC, AUTO 45 SEC
BACKGROUND	LOGO	BLUE, BLACK, LOGO		
INSTALLATION	ORIENTATION	DESKTOP FRONT	DESKTOP FRONT, CEILING REAR, DESKTOP REAR, CEILING FRONT	
	CONTROL PANEL LOCK	OFF	OFF, ON	
	SECURITY	OFF	OFF, ON	
	COMMUNICATION SPEED	38400bps	4800bps, 9600bps, 19200bps, 38400bps	
	CONTROL ID	CONTROL ID NUMBER	1	1-254
OPTIONS(1)	FAN MODE	AUTO	AUTO, HIGH, HIGH ALTITUDE	
	COLOR SYSTEM	VIDEO	AUTO	AUTO, NTSC3.58, NTSC4.43, PAL, PAL-M, PAL-N, PAL60, SECAM
		S-VIDEO	AUTO	AUTO, NTSC3.58, NTSC4.43, PAL, PAL-M, PAL-N, PAL60, SECAM
	WXGA MODE	V311X: OFF V311W/V281W: ON	OFF, ON	
	HDMI SETTINGS	VIDEO LEVEL	NORMAL	AUTO, NORMAL, ENHANCED
		AUDIO SELECT	HDMI	HDMI, COMPUTER2
BEEP	ON	OFF, ON		

5. Using On-Screen Menu

SETUP	OPTIONS(2)	STANDBY MODE	POWER-SAVING	NORMAL, POWER-SAVING	
		DIRECT POWER ON	OFF	OFF, ON	
		AUTO POWER ON(COMP1)	OFF	OFF, ON	
		AUTO POWER OFF	0:30	OFF, 0:05, 0:10, 0:20, 0:30	
		DEFAULT SOURCE SELECT	LAST	LAST, AUTO, COMPUTER1, COMPUTER2, HDMI, VIDEO, S-VIDEO	
		CARBON CONVERT			
		CURRENCY			
	CURRENCY CONVERT				
	3D	COMPUTER1 (DETAIL SETTINGS)	3D	OFF	OFF, ON
			GLASSES (V311X/V311W)	DLP® Link	DLP® Link, Nvidia 3D Vision
			GLASSES (V281W)	DLP® Link	DLP® Link, OTHERS
			FORMAT	FRAME SEQUENTIAL	FRAME SEQUENTIAL, OVER/UNDER
		L/R INVERT	NON-INVERT	NON-INVERT, INVERT	
		COMPUTER2 (DETAIL SETTINGS)	3D	OFF	OFF, ON
			GLASSES (V311X/V311W)	DLP® Link	DLP® Link, Nvidia 3D Vision
			GLASSES (V281W)	DLP® Link	DLP® Link, OTHERS
			FORMAT	FRAME SEQUENTIAL	FRAME SEQUENTIAL, OVER/UNDER
		L/R INVERT	NON-INVERT	NON-INVERT, INVERT	
		HDMI (DETAIL SETTINGS)	3D	OFF	OFF, ON
			GLASSES (V311X/V311W)	DLP® Link	DLP® Link, Nvidia 3D Vision
			GLASSES (V281W)	DLP® Link	DLP® Link, OTHERS
			FORMAT	FRAME SEQUENTIAL	FRAME SEQUENTIAL, OVER/UNDER
		L/R INVERT	NON-INVERT	NON-INVERT, INVERT	
		VIDEO (DETAIL SETTINGS)	3D	OFF	OFF, ON
			GLASSES	DLP® Link	DLP® Link, OTHERS
		S-VIDEO (DETAIL SETTINGS)	3D	OFF	OFF, ON
GLASSES			DLP® Link	DLP® Link, OTHERS	
		L/R INVERT	NON-INVERT	NON-INVERT, INVERT	
	L/R INVERT	NON-INVERT	NON-INVERT, INVERT		
INFO.	USAGE TIME	LAMP LIFE REMAINING			
		LAMP HOURS USED			
		TOTAL CARBON SAVINGS			
		TOTAL COST SAVINGS			
	SOURCE(1)	RESOLUTION			
		HORIZONTAL FREQUENCY			
		VERTICAL FREQUENCY			
		SYNC TYPE			
		SYNC POLARITY			
	SOURCE(2)	SCAN TYPE			
		SIGNAL TYPE			
		VIDEO TYPE			
		BIT DEPTH			
	WIRED LAN	VIDEO LEVEL			
		3D SIGNAL			
		PROJECTOR NAME			
		IP ADDRESS			
		SUBNET MASK			
	VERSION	GATEWAY			
		MAC ADDRESS			
		FIRMWARE			
	OTHERS	DATA			
		MODEL NO.			
		SERIAL NUMBER			
		CONTROL ID (when [CONTROL ID] is set)			
	RESET	CURRENT SIGNAL			
ALL DATA					
NETWORK SETTINGS					
CLEAR LAMP HOURS					

* The asterisk (*) indicates that the default setting varies depending on the signal.

4 Menu Descriptions & Functions [SOURCE]

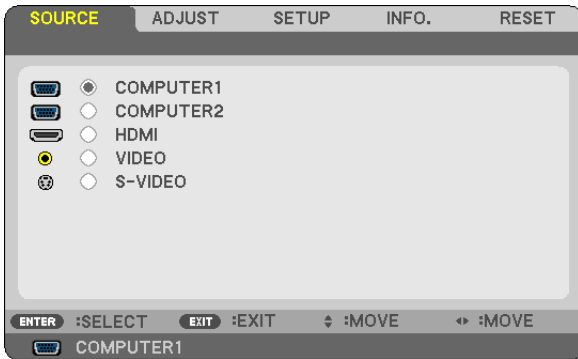

COMPUTER1 & COMPUTER2

Selects the computer connected to your COMPUTER 1 IN or COMPUTER 2 IN input connector.

NOTE:

- When the component input signal is connected to the COMPUTER 1 IN connector, select [COMPUTER1].
- The projector will determine if the input signal is RGB or component signal.

HDMI

Selects the HDMI compatible equipment connected to your HDMI IN connector.

VIDEO

Selects what is connected to your VIDEO input-VCR, DVD player or document camera.

S-VIDEO

Selects what is connected to your S-VIDEO input-VCR or DVD player.

NOTE: A frame may freeze for a brief period of time when a video is played back in fast-forward or fast-rewind with a Video or S-Video source.

5 Menu Descriptions & Functions [ADJUST]

[PICTURE]

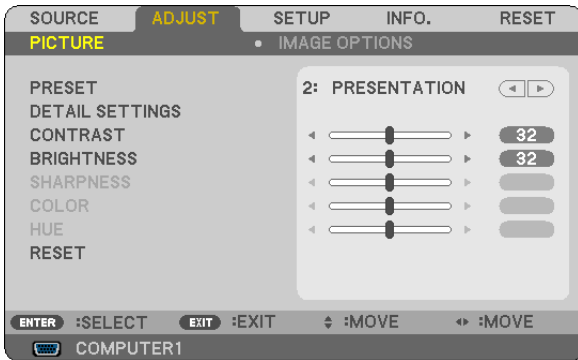

[PRESET]

This function allows you to select optimized settings for your projected image.

You can adjust neutral tint for yellow, cyan or magenta.

There are six factory presets optimized for various types of images. You can also use [DETAIL SETTINGS] to set user adjustable settings to customize each gamma or color.

Your settings can be stored in [PRESET 1] to [PRESET 6].

- HIGH-BRIGHT Recommended for use in a brightly lit room.
- PRESENTATION Recommended for making a presentation using a PowerPoint file.
- VIDEO Recommended for typical TV program viewing.
- MOVIE Recommended for movies.
- GRAPHIC Recommended for graphics.
- sRGB Standard color values

[DETAIL SETTINGS]

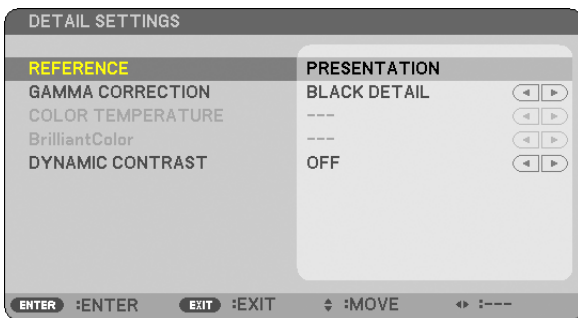

Storing Your Customized Settings [REFERENCE]

This function allows you to store your customized settings in [PRESET 1] to [PRESET 6].

First, select a base preset mode from [REFERENCE], then set [GAMMA CORRECTION], [COLOR TEMPERATURE], [Brilliant Color] and [DYNAMIC CONTRAST].

- HIGH-BRIGHT Recommended for use in a brightly lit room.
- PRESENTATION Recommended for making a presentation using a PowerPoint file.
- VIDEO Recommended for typical TV program viewing.
- MOVIE Recommended for movies.
- GRAPHIC Recommended for graphics.
- sRGB Standard color values.

Selecting Gamma Correction Mode [GAMMA CORRECTION]

Each mode is recommended for:

- DYNAMIC Creates a high-contrast picture.
- NATURAL..... Natural reproduction of the picture.
- BLACK DETAIL..... Emphasizes detail in dark areas of the picture.

Adjusting Color Temperature [COLOR TEMPERATURE]

This option allows you to select the color temperature of your choice.

NOTE:

- When [PRESENTATION] or [HIGH-BRIGHT] is selected in [REFERENCE], this function is not available.
 - When a color option other than [OFF] is selected for [WALL COLOR], this function is not available.
-

Adjusting Brightness of White Areas [BrilliantColor]

This function allows you to adjust the brightness of the white areas. As the picture becomes dim, it looks more natural.

- OFF Turns off the BrilliantColor feature.
- ON Increases brightness of the white areas.

NOTE:

- [BrilliantColor] is not available when [HIGH-BRIGHT] is selected for [REFERENCE].
 - [BrilliantColor] can be set to [ON] when [PRESENTATION] is selected for [REFERENCE]
-

Adjusting Brightness and Contrast [DYNAMIC CONTRAST]

Turning on [DYNAMIC CONTRAST] allows the contrast ratio to be adjusted to the proper level.

[CONTRAST]

Adjusts the intensity of the image according to the incoming signal.

[BRIGHTNESS]

Adjusts the brightness level or the back raster intensity.

[SHARPNESS]

Controls the detail of the image.

[COLOR]

Increases or decreases the color saturation level.

[HUE]

Varies the color level from +/- green to +/- blue. The red level is used as reference.

Input signal	CONTRAST	BRIGHTNESS	SHARPNESS	COLOR	HUE
COMPUTER/HDMI (RGB)	Yes	Yes	No	No	No
COMPUTER/HDMI (COMPONENT)	Yes	Yes	Yes	Yes	Yes
VIDEO/S-VIDEO/COMPONENT	Yes	Yes	Yes	Yes	Yes

Yes = Adjustable, No = Not adjustable

[RESET]

The settings and adjustments for [PICTURE] will be returned to the factory settings with the exception of the following; Preset numbers and [REFERENCE] within the [PRESET] screen.

The settings and adjustments under [DETAIL SETTINGS] within the [PRESET] screen that are not currently selected will not be reset.

[IMAGE OPTIONS]

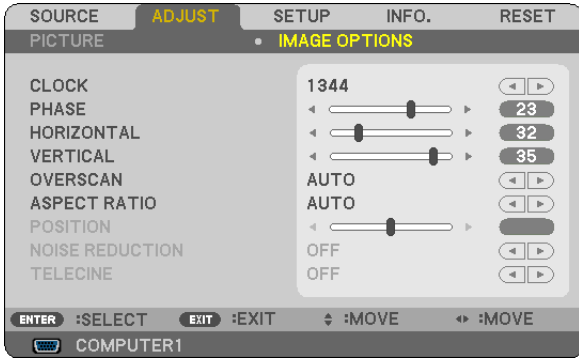

Adjusting Clock and Phase [CLOCK/PHASE]

This allows you to manually adjust CLOCK and PHASE.

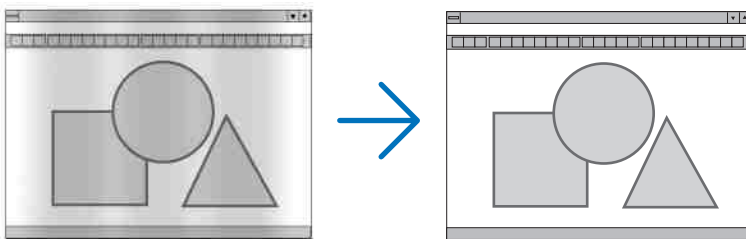

CLOCK..... Use this item to fine tune the computer image or to remove any vertical banding that might appear. This function adjusts the clock frequencies that eliminate the horizontal banding in the image.

This adjustment may be necessary when you connect your computer for the first time.

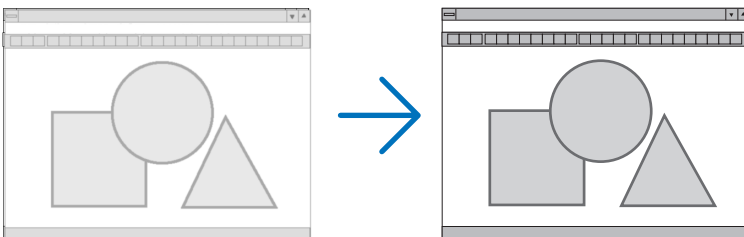

PHASE..... Use this item to adjust the clock phase or to reduce video noise, dot interference or cross talk. (This is evident when part of your image appears to be shimmering.)

Use [PHASE] only after the [CLOCK] is complete.

Adjusting Horizontal/Vertical Position [HORIZONTAL/VERTICAL]

Adjusts the image location horizontally and vertically.

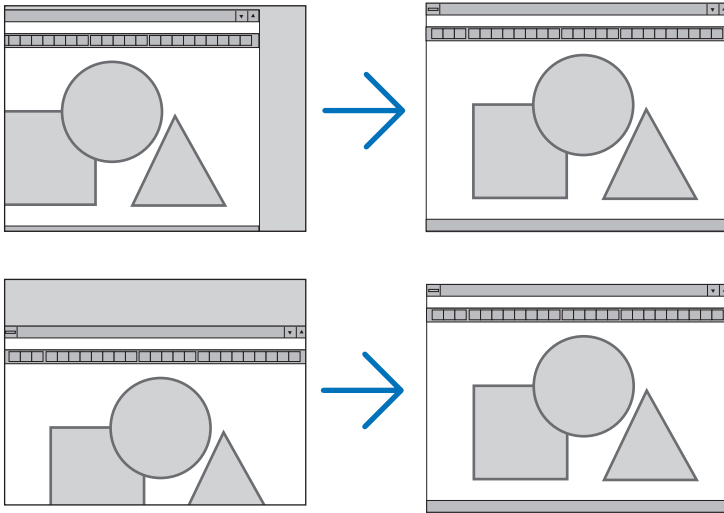

- An image can be distorted during the adjustment of [CLOCK] and [PHASE]. This is not a malfunction.
- Your manual adjustments for [CLOCK], [PHASE], [HORIZONTAL], and [VERTICAL] will be stored in memory for the current signal. The next time you project the signal with the same resolution, horizontal and vertical frequency, its adjustments will be called up and applied.

To delete adjustments stored in memory, from the menu, you select [RESET] → [CURRENT SIGNAL] or [ALL DATA] and reset the adjustments.

Selecting Overscan Percentage [OVERSCAN]

This allows you to set the appropriate overscan for an incoming signal.

- AUTO Display an appropriately overscanned image (factory setting).
- OFF Does not overscan the image.
- ON Overscans the image.

NOTE:

- The [OVERSCAN] cannot be selected when VIDEO and S-VIDEO signals are used.
- The [OVERSCAN] item is not available when [NATIVE] is selected for [ASPECT RATIO].

Selecting Aspect Ratio [ASPECT RATIO]

The term “aspect ratio” refers to the ratio of width to height of a projected image.

The projector automatically determines the incoming signal and displays it in its appropriate aspect ratio.

- This table shows typical resolutions and aspect ratios that most computers support.

	Resolution	Aspect Ratio
VGA	640 x 480	4:3
SVGA	800 x 600	4:3
XGA	1024 x 768	4:3
WXGA	1280 x 768	15:9
WXGA	1280 x 800	16:10
WXGA+	1440 x 900	16:10
SXGA	1280 x 1024	5:4
SXGA+	1400 x 1050	4:3
UXGA	1600 x 1200	4:3

Options	Function
AUTO	The projector will automatically determine the incoming signal and display it in its aspect ratio. (→ next page) The projector may erroneously determine the aspect ratio depending on its signal. If this occurs, select the appropriate aspect ratio from the following.
4:3	The image is displayed in 4:3 aspect ratio.
16:9	The image is displayed in 16:9 aspect ratio.
15:9	The image is displayed in 15:9 aspect ratio.
16:10	The image is displayed in 16:10 aspect ratio.
WIDE ZOOM (V311X)	The image is stretched left and right. Parts of the displayed image are cropped at the left and right edges and therefore not visible.
LETTER BOX (V311W/V281W)	The image of a letterbox signal is stretched equally in the horizontal and vertical directions to fit the screen. Parts of the displayed image are cropped at the top and bottom edges and therefore not visible.
NATIVE	The projector displays the current image in its true resolution when the incoming computer signal has a lower resolution than the projector's native resolution. <div style="display: flex; align-items: center; justify-content: center;"> <div style="margin-right: 20px;"> <p>[Example] When the incoming signal with the resolution of 800 × 600 is displayed on the V311X:</p> </div>  </div> <p><i>NOTE:</i></p> <ul style="list-style-type: none"> • When a non-computer signal is displayed, the [NATIVE] is not available. • When you are displaying an RGB image with a higher resolution than the projector's native resolution such as SXGA, the image will be displayed in the projector's native resolution (XGA) even if [NATIVE] is selected.

Sample image when the appropriate aspect ratio is automatically determined

V311X

[Computer signal]

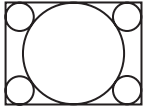
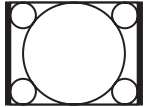
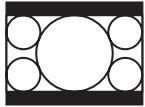
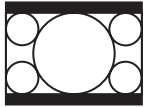
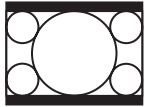
Aspect ratio of incoming signal	4:3	5:4	16:9	15:9	16:10
Sample image when the appropriate aspect ratio is automatically determined					

[Video signal]

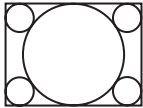
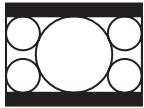
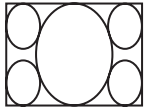
Aspect ratio of incoming signal	4:3	Letterbox	Squeeze
Sample image when the aspect ratio is automatically determined			 <p><i>NOTE: To display a squeezed signal properly, select [16:9] or [WIDE ZOOM].</i></p>

V311W/V281W

[Computer signal]

Aspect ratio of incoming signal	4:3	5:4	16:9	15:9	16:10
Sample image when the appropriate aspect ratio is automatically determined					

[Video signal]

Aspect ratio of incoming signal	4:3	Letterbox	Squeeze
Sample image when the aspect ratio is automatically determined		 <i>NOTE: To display a letterbox signal properly, select [LETTERBOX].</i>	 <i>NOTE: To display a squeezed signal properly, select [16:9].</i>

TIP:

- The term “letterbox” refers to a more landscape-oriented image when compared to a 4:3 image, which is the standard aspect ratio for a video source.
The letterbox signal has aspect ratios with the vista size “1.85:1” or cinema scope size “2.35:1” for movie film.
- The term “squeeze” refers to the compressed image of which aspect ratio is converted from 16:9 to 4:3.

Adjusting the Vertical Position of Image [POSITION] (V311X)

(only when [16:9], [15:9], or [16:10] is selected for [ASPECT RATIO])

When [16:9], [15:9], or [16:10] is selected in [ASPECT RATIO], the image is displayed with black borders on the top and bottom.

You can adjust the vertical position from the top to the bottom of the black area.

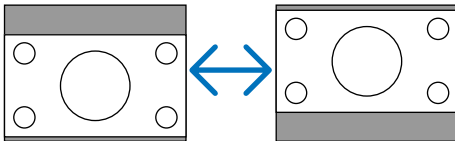

Turning on Noise Reduction [NOISE REDUCTION]

This function allows you to select the level of noise reduction. The projector is set to the optimized level for each signal at the factory. Select your preference item for your signal when video noise is noticeable. The options are [OFF], [LOW], [MEDIUM], and [HIGH].

NOTE: This feature is not available for the RGB signal. Noise reduction set to off gives best image quality by way of higher bandwidth. Noise reduction set to on softens the image.

Setting Telecine Mode [TELECINE]

This function allows you to convert motion picture film images into video. The process adds additional frames to the picture in order to increase the frame rate.

NOTE: This feature is available only when an SDTV signal is selected.

- OFF Turns off the TELECINE mode.
- 2-2/2-3 AUTO Detects pull-down correction method.
- 2-2 ON Uses 2-2 pull-down correction method
- 2-3 ON Uses 2-3 pull-down correction method

NOTE: This feature is not available for 480p, 576p, 720p, 1080i and RGB signals.

6 Menu Descriptions & Functions [SETUP]

[GENERAL]



Correcting Vertical Keystone Distortion Manually [KEYSTONE]

You can correct vertical distortion manually. (→ page 26)

TIP: When this option is highlighted, pressing the ENTER button will display its slide bar for adjustment.

Saving Vertical Keystone Correction [KEYSTONE SAVE]

This option enables you to save your current keystone settings.

- OFF Does not save current keystone correction settings. It will return your keystone correction settings to "zero".
- ON Saves current keystone correction settings

Saving your change once affects all sources. The changes are saved when the projector is turned off.

Using the Wall Color Correction [WALL COLOR]

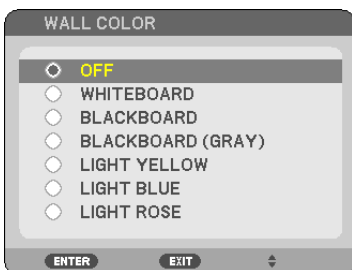

This function allows for quick adaptive color correction in applications where the screen material is not white.

NOTE:

- Selecting color options other than [OFF] will reduce brightness.
- When the 3D mode is enabled, the [WALL COLOR] item is not available.

Setting Eco Mode [ECO MODE]

This feature turns on or off the ECO mode. The lamp life can be extended by selecting [ON]. Selecting [ON] also decreases fan noise when compared to [OFF] mode.

ECO MODE	Description	Status of LAMP indicator
OFF	This is the Default setting (100% Brightness).	Off
ON	Select this mode to increase the lamp life (approx. 75% Brightness.)	Steady Green light

NOTE:

- The [LAMP LIFE REMAINING] and [LAMP HOURS USED] can be checked in [USAGE TIME]. Select [INFO.] → [USAGE TIME]. (→ page 77)
- The projector will always enter into the [ECO MODE] [ON] condition for 90 seconds immediately after the projector is turned on. The lamp condition will not be affected even when [ECO MODE] is changed within this time period.
- After a lapse of 45 seconds from when the projector displays a blue, black or logo screen, [ECO MODE] will automatically switch to [ON]. The projector will return to the [OFF] mode once a signal is accepted.
- If the projector becomes overheated in [OFF] mode because of use in a high-temperature room, there may be a case where the [ECO MODE] automatically changes to [ON] mode to protect the projector. This mode is called “forced ECO mode”. When the projector is in [ON] mode, the picture brightness decreases. The LAMP indicator’s steady light indicates the projector is in [ON] mode. When the projector comes back to normal temperature, the [ECO MODE] returns to [OFF] mode. Thermometer symbol [🔥] indicates the [ECO MODE] is automatically set to [ON] mode because the internal temperature is too high.

Setting Closed Caption [CLOSED CAPTION]

This option sets several closed caption modes that allow text to be superimposed on the projected image of Video or S-Video.

- OFF This exits the closed caption mode.
- CAPTION 1-4 Text is superimposed.
- TEXT 1-4..... Text is displayed.

NOTE:

- The closed caption is not available under the following conditions:
 - when messages or menus are displayed.
 - when an image is magnified, frozen, or muted.
- Portions of superimposed text or closed caption may be truncated. If that happens, try to place the superimposed text or closed caption within the screen.
- The projector does not support optional extended characters for closed captioning.

Using Off Timer [OFF TIMER]

The remaining countdown time will be displayed at the bottom of the menu when the [OFF TIMER] is preset.

1. **Select your desired time between 30 minutes and 16 hours: OFF, 0:30, 1:00, 2:00, 4:00, 8:00, 12:00, 16:00.**
2. **Press the ENTER button on the remote control.**
3. **The remaining time starts counting down.**
4. **The projector will turn off after the countdown is complete.**

NOTE:

- To cancel the preset time, set [OFF] for the preset time or turn off the power.
- When the remaining time reaches 3 minutes before the projector is turned off, the [THE PROJECTOR WILL TURN OFF WITHIN 3 MINUTES] message will be displayed on the bottom of the screen.

Selecting Menu Language [LANGUAGE]

You can choose one of 27 languages for on-screen instructions.

NOTE: Your setting will not be affected even when [RESET] is done from the menu.

[MENU]

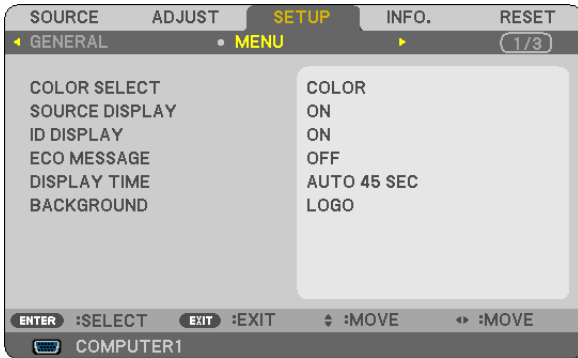

Selecting Menu Color [COLOR SELECT]

You can choose between two options for menu color: COLOR and MONOCHROME.

Turning On / Off Source Display [SOURCE DISPLAY]

This option turns on or off input name display such as COMPUTER, VIDEO, S-VIDEO and No Input to be displayed on the top right of the screen.

When [ON] is selected, the following will be displayed:

- An input name display such as [COMPUTER] will be shown immediately after source selection.
- [NO INPUT] will be shown when there is no signal present.

Turning ON/OFF Control ID [ID DISPLAY]

ID DISPLAY This option turns on or off the ID number which is displayed when the ID SET button on the remote control is pressed.

Turning On / Off Eco Message [ECO MESSAGE]

This option turns on or off the following messages when the projector is turned on.

The Eco Message prompts the user to save energy. When [OFF] is selected for [ECO MODE], you will get a message to prompt you to select [ON] for [ECO MODE].

When [ON] is selected for [ECO MODE]



To close the message, press the ENTER or the EXIT button. The message will disappear if no button operation is done for 30 seconds.

When [OFF] is selected for [ECO MODE]

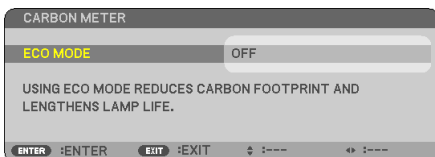

Pressing the ENTER button will display the [ECO MODE] screen. (→ page 65)
To close the message, press the EXIT button.

Selecting Menu Display Time [DISPLAY TIME]

This option allows you to select how long the projector waits after the last touch of a button to turn off the menu. The preset choices are [MANUAL], [AUTO 5 SEC], [AUTO 15 SEC], and [AUTO 45 SEC]. The [AUTO 45 SEC] is the factory preset.

Selecting a Color or Logo for Background [BACKGROUND]

Use this feature to display a blue/black screen or logo when no signal is available. The default background is [LOGO].

TIP: The logo can be changed.

For more information about how to change the logo, please consult your NEC or NEC-designated service station. If you cannot find one in your area, ask your dealer.

NOTE: Your setting will not be affected even when [RESET] is done from the menu.

[INSTALLATION]

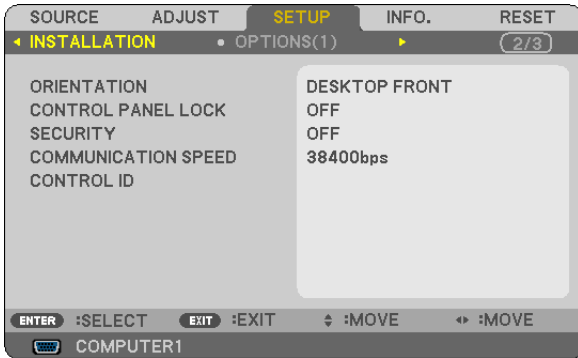

Selecting Projector Orientation [ORIENTATION]

This reorients your image for your type of projection. The options are: desktop front projection, ceiling rear projection, desktop rear projection, and ceiling front projection.

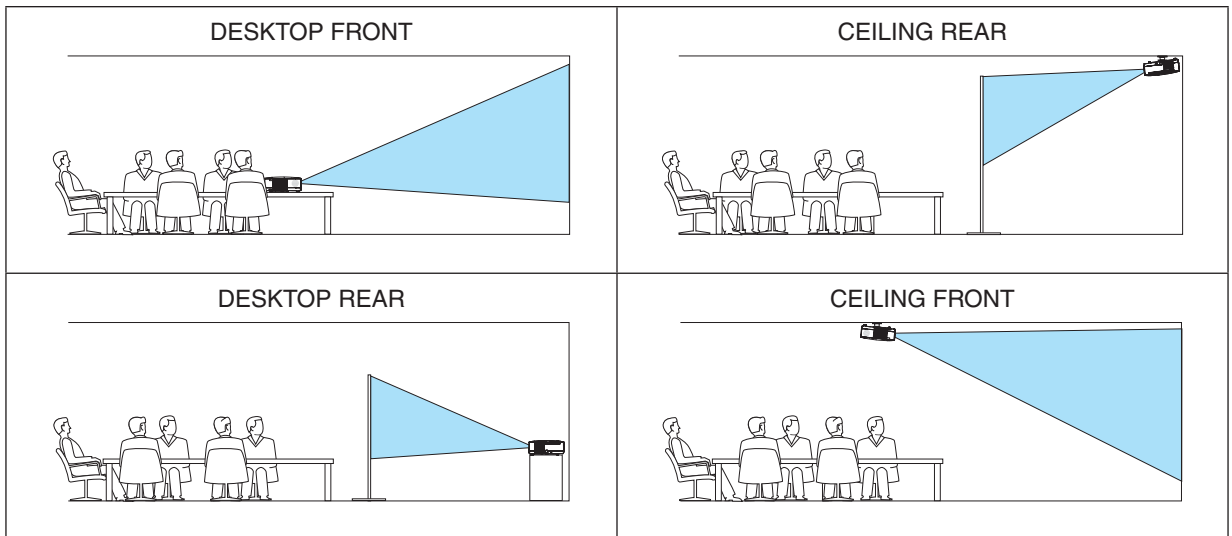

Disabling the Cabinet Buttons [CONTROL PANEL LOCK]

This option turns on or off the CONTROL PANEL LOCK function.

NOTE:

- This CONTROL PANEL LOCK does not affect the remote control functions.
- When the control panel is locked, pressing and holding the EXIT button on the projector cabinet for about 10 seconds will change the setting to [OFF].

TIP: When the [CONTROL PANEL LOCK] is turned on, a key lock icon [] will be displayed at the bottom right of the menu.

Enabling Security [SECURITY]

This feature turns on or off the SECURITY function.

Unless the correct keyword is entered, the projector cannot project an image. (→ page 34)

NOTE: Your setting will not be affected even when [RESET] is done from the menu.

Selecting Communication Speed [COMMUNICATION SPEED]

This feature sets the baud rate of the PC Control port (D-Sub 9P). It supports data rates from 4800 to 38400 bps. The default is 38400 bps. Select the appropriate baud rate for your equipment to be connected (depending on the equipment, a lower baud rate may be recommended for long cable runs).

NOTE: Your selected communication speed will not be affected even when [RESET] is done from the menu.

Setting ID to the Projector [CONTROL ID]

You can operate multiple projectors separately and independently with the single remote control that has the CONTROL ID function. If you assign the same ID to all the projectors, you can conveniently operate all the projectors together using the single remote control. To do so, you have to assign an ID number to each projector.

CONTROL ID NUMBER.....Select a number from 1 to 254 you wish to assign to your projector.

CONTROL ID.....Select [OFF] to turn off the CONTROL ID setting and select [ON] to turn on the CONTROL ID setting.

NOTE:

- When [ON] is selected for [CONTROL ID], the projector cannot be operated by using the remote control that does not support the CONTROL ID function. (In this case the buttons on the projector cabinet can be used.)
- Your setting will not be affected even when [RESET] is done from the menu.
- Pressing and holding the ENTER button on the projector cabinet for 10 seconds will display the menu for canceling the Control ID.

Assigning or Changing the Control ID

1. Turn on the projector.

2. Press the ID SET button on the remote control.

The CONTROL ID screen will be displayed.

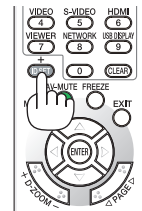

If the projector can be operated with the current remote control ID, the [ACTIVE] will be displayed. If the projector cannot be operated with the current remote control ID, the [INACTIVE] will be displayed. To operate the inactive projector, assign the control ID used for the projector by using the following procedure (Step 3).

3. Press one of numeric keypad buttons while pressing and holding the ID SET button on the remote control.

Example:

To assign "3", press the "3" button on the remote control.

No ID means that all the projectors can be operated together with a single remote control. To set "No ID", enter "000" or press the CLEAR button.

TIP: The range of IDs is from 1 to 254.

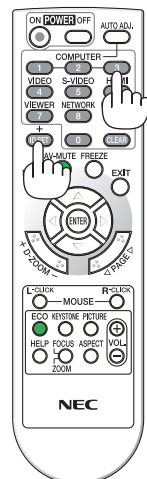

4. Release the ID SET button.

The updated CONTROL ID screen will be displayed.

NOTE:

- The IDs can be cleared in a few days after the batteries are run down or removed.
- Accidentally pressing any one of the buttons of the remote control will clear currently specified ID with batteries removed.

[OPTIONS(1)]

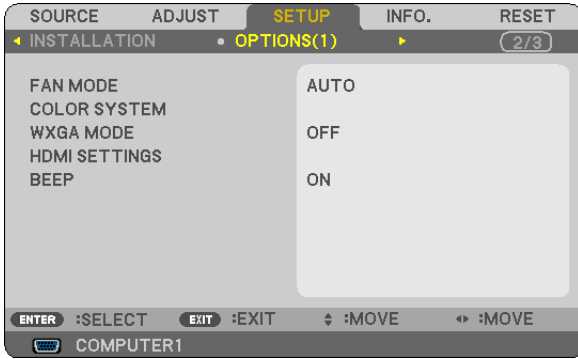

Selecting Fan Mode [FAN MODE]

This option allows you to select three modes for fan speed: Auto mode, High speed mode, and High Altitude mode.

AUTO The built-in fans automatically run at a variable speed according to the internal temperature.

HIGH..... The built-in fans run at high speed.

HIGH ALTITUDE..... The built-in fans run at a high speed. Select this option when using the projector at altitudes approximately 3000 feet/900 meters or higher.

NOTE:

- When you wish to cool down the temperature inside the projector quickly, select [HIGH].
- It is recommended that you select High speed mode if you use the projector non-stop for consecutive days.
- If you use the projector at altitudes approximately 3000 feet/900 meters or higher, you are recommended to set [FAN MODE] to [HIGH ALTITUDE]. Failure to do so may cause the projector to overheat, resulting in malfunction.

High altitude	
12000 ft (3600 m) to 8500 ft (2600 m)	[HIGH ALTITUDE] for [FAN MODE] 5° to 30°C (ECO MODE ON only)
8500 ft (2600 m) to 3000 ft (900 m)	[HIGH ALTITUDE] for [FAN MODE] 5° to 35°C
3000 ft (900 m) to 0	[AUTO] for [FAN MODE] 5° to 40°C

- Using the projector at altitudes approximately 3000 feet/900 meters or higher without setting to [HIGH ALTITUDE] can cause the projector to overheat and the protector could shut down. If this happens, wait a couple minutes and turn on the projector.
- Using the projector at altitudes less than approximately 3000 feet/900 meters and setting to [HIGH ALTITUDE] can cause the lamp to overcool, causing the image to flicker. Switch [FAN MODE] to [AUTO].
- Using the projector at high altitudes or in low air pressure can shorten the life of components.
- Your setting will not be affected even when [RESET] is done from the menu.

Selecting [COLOR SYSTEM]

This feature enables you to select video standards manually.

Normally select [AUTO]. Select the video standard from the pulldown menu. This must be done for VIDEO and S-VIDEO Connectors separately.

Enabling or Disabling WXGA Mode [WXGA MODE]

Selecting [ON] will give priority to a WXGA (1280 × 768) signal in recognizing an input signal.

When [WXGA MODE] is set to [ON], an XGA (1024 × 768) signal may not be recognized on V311X. In this case, select [OFF].

Setting HDMI [HDMI SETTINGS]

Make the settings for video level and audio level when connecting HDMI equipment such as a DVD player.

VIDEO LEVEL..... Select [AUTO] to automatically detect video level. If automatic detection may not work well, select [NORMAL] to disable the [ENHANCED] feature of your HDMI equipment or select [ENHANCED] to improve image contrast and increase detail in the dark areas.

AUDIO SELECT Select [HDMI] to switch the HDMI IN digital audio signal and select [COMPUTER2] to switch the COMPUTER 2 input audio signal.

Enabling Key Sound and Error Sound [BEEP]

This feature turns on or off the button sound or alarm when the following operations are performed.

- Displaying the main menu
- Switching sources
- Pressing POWER ON or POWER OFF button

[OPTIONS(2)]

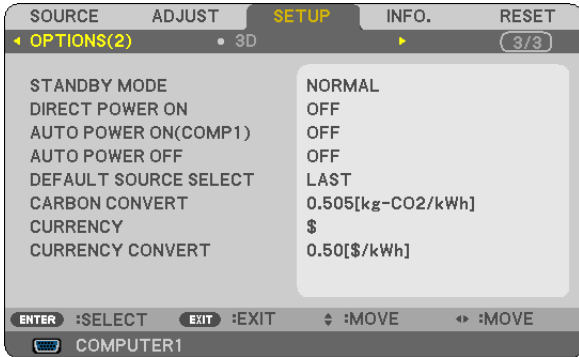

Selecting Power-saving in [STANDBY MODE]

The projector has two standby modes: [NORMAL] and [POWER-SAVING]. The POWER-SAVING mode is the mode that allows you to put the projector in the power-saving condition which consumes less power than the NORMAL mode. The projector is preset for POWER-SAVING mode at the factory.

NORMAL..... Power indicator: Orange light/STATUS indicator: Green light
 POWER-SAVING.... Power indicator: Red light/STATUS indicator: Off

The following connectors, buttons or functions will not work during this mode.

- PC CONTROL port, and COMPUTER OUT connector
- LAN and Mail Alert functions
- Buttons other than POWER button on the cabinet
- Buttons other than POWER ON button on the remote control

NOTE:

- When [CONTROL PANEL LOCK], [CONTROL ID], or [AUTO POWER ON(COMP1)] is turned on, the [STANDBY MODE] setting is not available.
- The power consumption in the standby mode will not be included in calculating CO₂ emission reduction.
- Your setting will not be affected even when [RESET] is done from the menu.

Enabling Direct Power On [DIRECT POWER ON]

Turns the projector on automatically when the power cord is inserted into an active power outlet. This eliminates the need to always use the POWER button on the remote control or projector cabinet.

Turning On the Projector By Applying Computer Signal [AUTO POWER ON(COMP1)]

When the projector is in Standby mode, applying a computer signal from a computer connected to the COMPUTER 1 IN input will power on the projector and simultaneously project the computer's image. This functionality eliminates the need to always use the POWER button on the remote control or the projector cabinet to power on the projector.

NOTE:

- *Disconnecting a computer signal from the computer will not power off the projector. We recommend using this function in combination of the AUTO POWER OFF function.*
- *This function will not be available under the following conditions:*
 - *when a component signal is applied to the COMPUTER 1 IN connector*
 - *when a Sync on Green RGB signal or composite sync signal is applied*
- *To enable the AUTO POWER ON(COMP1) after turning off the projector, wait 3 seconds and input a computer signal. If a computer signal is still present when the projector is turned off, the AUTO POWER ON(COMP1) will not work and the projector remains in standby mode.*

Enabling Power Management [AUTO POWER OFF]

When this option is selected you can enable the projector to automatically turn off (at the selected time: 5min., 10min., 20min., 30min.) if there is no signal received by any input or if no operation is performed.

Selecting Default Source [DEFAULT SOURCE SELECT]

You can set the projector to default to any one of its inputs each time the projector is turned on.

- LAST Sets the projector to default to the previous or last active input each time the projector is turned on.
- AUTO Searches for an active source in order of COMPUTER1 → COMPUTER2 → HDMI → VIDEO → S-VIDEO → COMPUTER1 and displays the first found source.
- COMPUTER1 Displays the computer signal from the COMPUTER 1 IN connector every time the projector is turned on.
- COMPUTER2 Displays the computer signal from the COMPUTER 2 IN connector every time the projector is turned on.
- HDMI Displays the digital source from the HDMI IN connector every time the projector is turned on.
- VIDEO Displays the Video source from the VIDEO IN connector every time the projector is turned on.
- S-VIDEO Displays the Video source from the S-VIDEO IN connector every time the projector is turned on.

Setting carbon footprint factor [CARBON CONVERT]

Adjusts the carbon footprint factor in the carbon saving calculation. The initial setting is 0.505[kg-CO2/kWh] based on the CO2 Emissions from Fuel Combustion (2008 Edition) published by OECD.

Selecting your currency [CURRENCY]

Displays electricity pricing (available in 4 currency units).

- \$ US Dollar
- € EU Euro
- JP¥ Japanese Yen
- RMB¥ Chinese Yuan

Changing currency setting and currency convert setting [CURRENCY CONVERT]

Changes currency setting and currency convert setting for CARBON METER.

The initial setting are as follows:

US Dollar	0.11	[\$/kWh]
EU Euro	0.19	[€/kWh]
Japanese Yen	20	[¥/kWh]
Chinese Yuan	0.48	[¥/kWh]

The initial settings for US dollar, EU Euro, and Japanese Yen are based on “Energy Prices and Taxes (second quarter 2010)” published by OECD.

The initial setting for Chinese Yuan is based on “Chinese Data File (2010)” published by JETRO.

[3D]

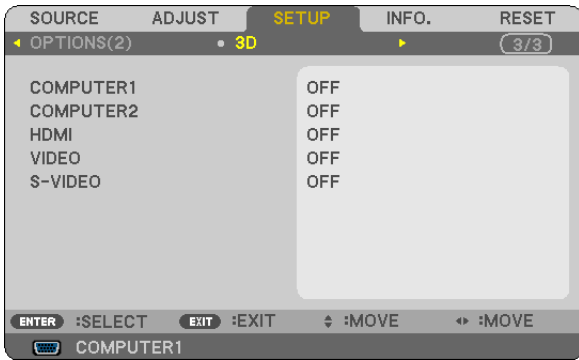

Selecting input connected to a source of 3D images [COMPUTER1/COMPUTER2/HDMI/VIDEO/S-VIDEO]

[3D]

This function switches the 3D mode between ON and OFF for each input.

ON Turns on the 3D mode for the selected input.

NOTE:

To confirm that the supported 3D signal is accepted, use either way of the following:

- *Make sure that [3D] is displayed in the top right of the screen after the source is selected.*
- *Display [INFO.] → [SOURCE] → [3D SIGNAL] and make sure that "SUPPORTED" is displayed.*

OFF Turns off the 3D mode for the selected input.

[GLASSES]

Select a 3D glass method.

- DLP® Link For the optional 3D supported goggles (NP02GL) or DLP® Link compatible LCD shutter eyeglasses.
- Nvidia 3D Vision*1 For NVIDIA® 3D Vision™

NOTE:

This function will not work for VIDEO or S-VIDEO source.

In some cases when NVIDIA® 3D Vision™ is used, the projector's remote control may not work well. If you use LCD shutter eyeglasses that are not compatible with DLP® Link, the LCD shutter eyeglasses may not synchronize to the projector properly.

Others*2 For other LCD shutter eyeglasses such as IR or wired LCD shutter types.

*1: For V311X/V311W only

*2: For V281W only

[FORMAT]

Selects either two formats: frame sequential or over/undert

FRAME SEQUENTIAL..... Normal setting. (frame sequential 3D consists of a sequence of alternating frames wherein each successive frame carries the image meant for one or the other eye.)

OVER/UNDER For viewing a 3D images in under/over format.

NOTE:

This function will not work for VIDEO or S-VIDEO source.

This option is available only when [DLP® Link] is selected for [GLASSES].

[L/R INVERT]

Change the setting if you have difficulty seeing 3D images.

NON-INVERT Normal setting.

INVERT Changes the order of displaying the images for left eye and right eye.

NOTE:

This option is available only when [DLP® Link] is selected for [GLASSES].

7 Menu Descriptions & Functions [INFO.]

Displays the status of the current signal and lamp usage. This item has four pages. The information included is as follows:

TIP: Pressing the HELP button on the remote control will show the [INFO.] menu items.

[USAGE TIME]

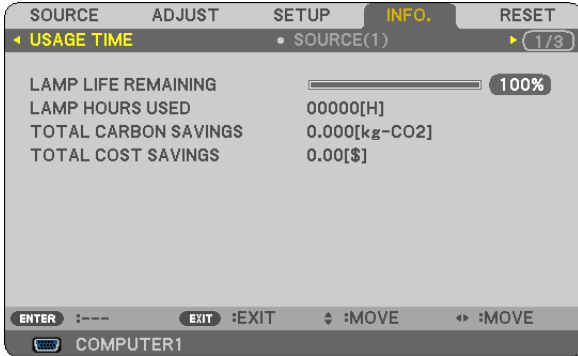

- [LAMP LIFE REMAINING] (%)*
- [LAMP HOURS USED] (H)
- [TOTAL CARBON SAVINGS] (kg-CO2)
- [TOTAL COST SAVINGS]

- * The progress indicator shows the percentage of remaining bulb life. The value informs you of the amount of lamp usage. When the remaining lamp time reaches 0, the LAMP LIFE REMAINING bar indicator changes from 0% to 100 Hours and starts counting down. If the remaining lamp time reaches 0 hours, the projector will not turn on regardless of whether the ECO MODE is set to OFF or ON.
- The message to the effect that the lamp should be replaced will be displayed for one minute when the projector is turned on and when the POWER button on the projector or the remote control is pressed. To dismiss this message, press any button on the projector or the remote control.

Lamp life (H)		Replacement lamp
ECO MODE		
OFF	ON	
3000	5000	NP18LP

- [TOTAL CARBON SAVINGS]
This displays the estimated carbon saving information in kg. The carbon footprint factor in the carbon saving calculation is based on the OECD (2008 Edition).

[SOURCE 1]

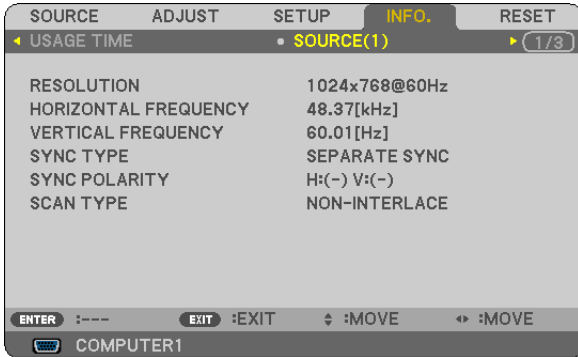

[RESOLUTION]
 [HORIZONTAL FREQUENCY]
 [VERTICAL FREQUENCY]
 [SYNC TYPE]
 [SYNC POLARITY]
 [SCAN TYPE]

[SOURCE 2]

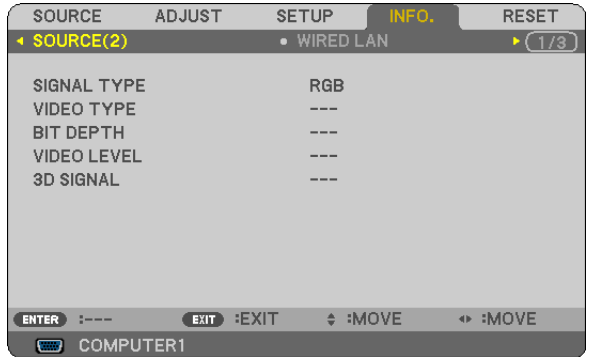

[SIGNAL TYPE]
 [VIDEO TYPE]
 [BIT DEPTH]
 [VIDEO LEVEL]
 [3D SIGNAL]

[WIRED LAN]



[PROJECTOR NAME] [IP ADDRESS]
 [SUBNET MASK] [GATEWAY]
 [MAC ADDRESS]

[VERSION]

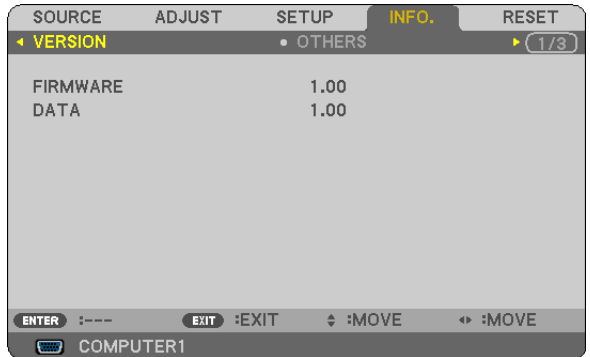

[FIRMWARE] Version
 [DATA] Version

[OTHERS]

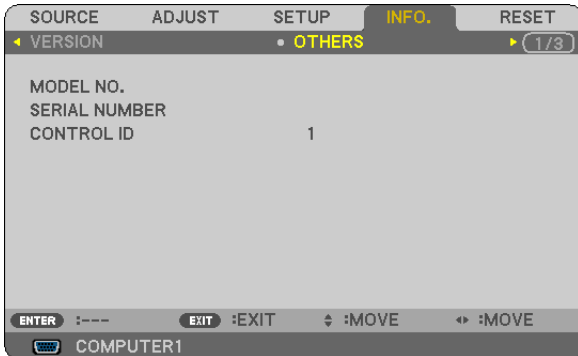

[MODEL NO.]
 [SERIAL NUMBER]
 [CONTROL ID] (when [CONTROL ID] is set)

8 Menu Descriptions & Functions [RESET]

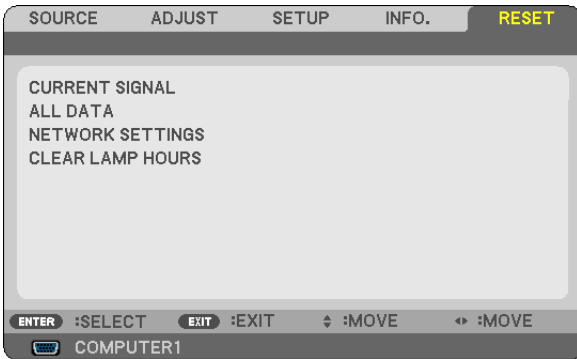

Returning to Factory Default [RESET]

The RESET feature allows you to change adjustments and settings to the factory preset for a (all) source(s) except the following:

[CURRENT SIGNAL]

Resets the adjustments for the current signal to the factory preset levels.

The items that can be reset are: [PRESET], [CONTRAST], [BRIGHTNESS], [COLOR], [HUE], [SHARPNESS], [ASPECT RATIO], [HORIZONTAL], [VERTICAL], [CLOCK], [PHASE], [NOISE REDUCTION], and [TELECINE].

[ALL DATA]

Reset all the adjustments and settings for all the signals to the factory preset.

All items can be reset **EXCEPT** [LANGUAGE], [BACKGROUND], [SECURITY], [COMMUNICATION SPEED], [CONTROL ID], [STANDBY MODE], [FAN MODE], [LAMP LIFE REMAINING], [LAMP HOURS USED], [TOTAL CARBON SAVINGS] [CARBON CONVERT], [CURRENCY], [CURRENCY CONVERT], and [NETWORK SETTINGS].

To reset the lamp usage time, see “Clearing Lamp Hour Meter [CLEAR LAMP HOURS]” below.

Clearing Networking Settings [NETWORK SETTINGS]

Returns [DHCP], [IP ADDRESS], [SUBNET MASK], and [GATEWAY] to the default settings.

Clearing Lamp Hour Meter [CLEAR LAMP HOURS]

Resets the lamp clock back to zero. Selecting this option displays submenu for a confirmation. Select [YES] and press the ENTER button.

NOTE: Elapsed time of the lamp use will not be affected even when [RESET] is done from the menu.

NOTE: The projector will turn off and go into standby mode when you continue to use the projector for another 100 hours after the lamp has reached the end of its life. In this condition you cannot clear the lamp hour meter on the menu. If this happens, press the HELP button on the remote control for 10 seconds to reset the lamp clock back to zero. Do this only after replacing the lamp.

6. Maintenance

This section describes the simple maintenance procedures you should follow to clean the cabinet and the lens, and replace the lamp.

① Cleaning the Cabinet and the Lens

1. Turn off the projector before cleaning.
2. Clean the cabinet periodically with a damp cloth. If heavily soiled, use a mild detergent. Never use strong detergents or solvents such as alcohol or thinner.

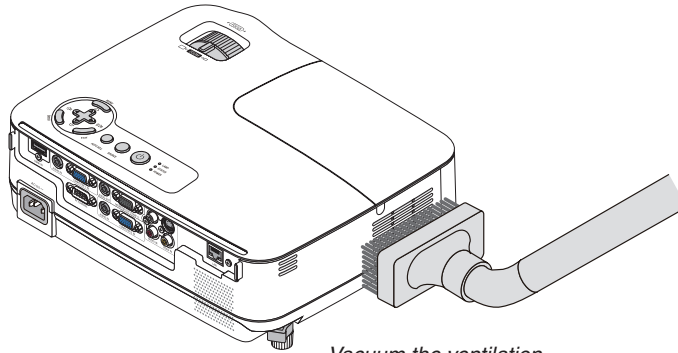

Vacuum the ventilation inlet of the cabinet.

Note on Cleaning the Lens

Use a blower or lens paper to clean the lens, and be careful not to scratch or mar the lens.

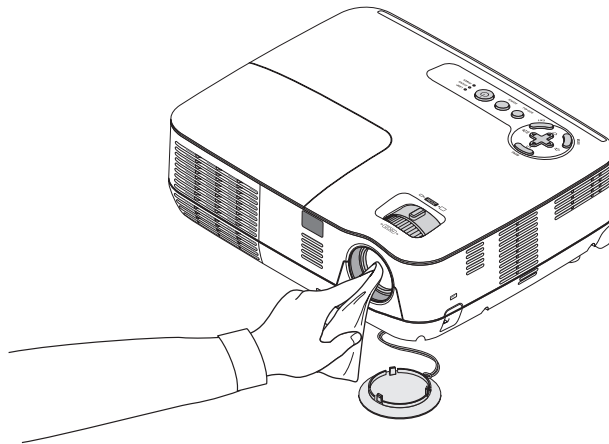

② Replacing the Lamp

When the lamp reaches the end of its life, the LAMP indicator in the cabinet will blink red. Even though the lamp may still be working, replace the lamp to maintain the optimal projector performance. After replacing the lamp, be sure to clear the lamp hour meter. (→ page 79)

CAUTION

- Use the specified lamp for safety and performance.
- DO NOT TOUCH THE LAMP immediately after it has been used. It will be extremely hot. Turn the projector off, and then disconnect the power cord. Allow at least one hour for the lamp to cool before handling.
- DO NOT REMOVE ANY SCREWS except one lamp cover screw and three lamp housing screws. You could receive an electric shock.
- Do not break the glass on the lamp housing.
Keep finger prints off the glass surface on the lamp housing. Leaving finger prints on the glass surface might cause an unwanted shadow and poor picture quality.
- The projector will turn off and go into standby mode when you continue to use the projector for another 100 hours after the lamp has reached the end of its life. If this happens, be sure to replace the lamp. If you continue to use the lamp after the lamp reaches the end of its life, the lamp bulb may shatter, and pieces of glass may be scattered in the lamp case. Do not touch them as the pieces of glass may cause injury. If this happens, contact your NEC dealer for lamp replacement.

**NOTE: This message will be displayed under the following conditions:*

- for one minute after the projector has been powered on
- when the  (POWER) button on the projector cabinet or the POWER OFF button on the remote control is pressed

To turn off the message, press any button on the projector cabinet or the remote control.

To replace the lamp:

Optional lamp and tools needed for replacement:

- Replacement lamp: NP18LP
- Phillips screwdriver or equivalent

1. Remove the lamp cover.

(1) Loosen the lamp cover screw

- The lamp cover screw is not removable.

(2) Push and slide the lamp cover off.

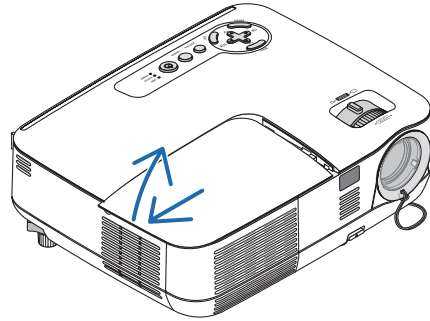
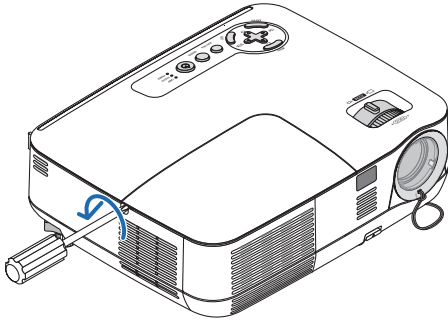

2. Remove the lamp housing.

(1) Loosen the three screws securing the lamp housing until the Phillips screwdriver goes into a freewheeling condition.

- The three screws are not removable.
- There is an interlock on this case to prevent the risk of electrical shock. Do not attempt to circumvent this interlock.

(2) Remove the lamp housing by holding it.



CAUTION:

Make sure that the lamp housing is cool enough to before removing it.

Interlock

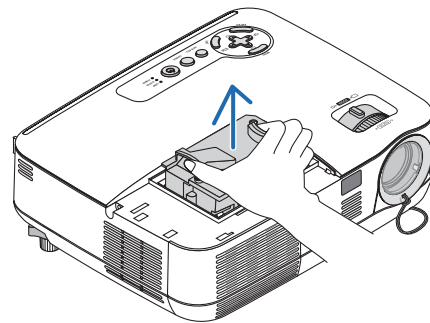
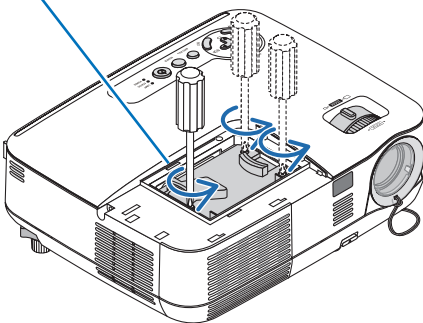

3. Install a new lamp housing.

(1) Insert a new lamp housing until the lamp housing is plugged into the socket.

CAUTION

Do not use a lamp other than the NEC replacement lamp NP18LP.
Order this from your NEC dealer.

(2) Push the top center of the lamp housing to secure it.

(3) Secure it in place with the three screws.

- Be sure to tighten the screws.

Hold the cabinet with your hand to keep it from tilting while you tighten the screw.

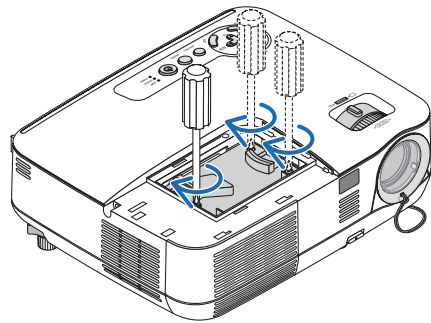
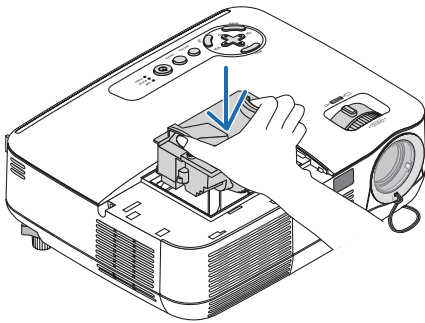

4. Reattach the lamp cover.

(1) Slide the lamp cover back until it snaps into place.

(2) Tighten the screw to secure the lamp cover.

- Be sure to tighten the screw.

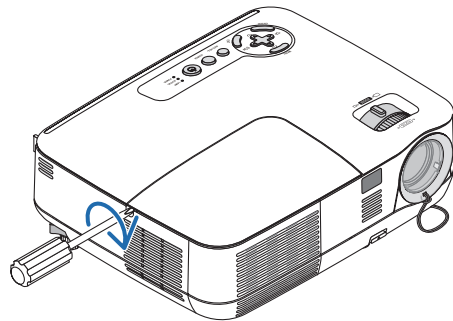
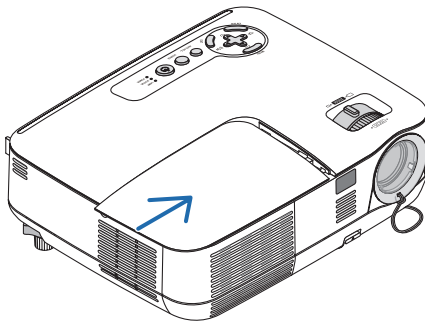

5. Connect the supplied power cord, and turn on the projector.

6. Finally, select the menu → [RESET] → [CLEAR LAMP HOURS] to reset the lamp usage hours.

NOTE: When you continue to use the projector for another 100 hours after the lamp has reached the end of its life, the projector cannot turn on and the menu is not displayed.

If this happens, press the HELP button on the remote control for 10 seconds to reset the lamp clock back to zero.

When the lamp time clock is reset to zero, the LAMP indicator goes out.

7. Appendix

1 Troubleshooting

This section helps you resolve problems you may encounter while setting up or using the projector.

Indicator Messages

Power Indicator

Indicator Condition			Projector Condition	Note
Off			The power cord is unplugged.	–
Blinking light	Green	0.5 sec On, 0.5 sec Off	The projector is getting ready to turn on.	Wait for a moment.
		2.5 sec On, 0.5 sec Off	Off Timer is enabled.	–
Steady light	Green		The projector is turned on.	–
	Orange		[NORMAL] is selected for [STANDBY MODE]	–
	Red		[POWER-SAVING] is selected for [STANDBY MODE]	–

Status Indicator

Indicator Condition			Projector Condition	Note
Off			Normal or Standby ([POWER-SAVING] for [STANDBY MODE])	–
Blinking light	Red	1 cycle (0.5 sec On, 2.5 sec Off)	Lamp cover error or lamp housing error	Replace the lamp cover or lamp housing correctly.
		2 cycle (0.5 sec On, 0.5 sec Off)	Temperature error	The projector is overheated. Move the projector to a cooler location.
		4 cycle (0.5 sec On, 0.5 sec Off)	Fan error	Fans will not work correctly.
		6 cycle (0.5 sec On, 0.5 sec Off)	Lamp error	Lamp fails to light. Wait a full minute and then turn on again.
	Green		Re-firing the lamp (The projector is cooling down.)	The projector is re-firing. Wait for a moment.
Steady light	Green		Standby ([NORMAL] for [STANDBY MODE])	–
	Orange		Cabinet button is locked	You have pressed cabinet button when Cabinet Button is locked.
			CONTROL ID error	Remote control ID and projector ID are not matched.

Lamp Indicator

Indicator Condition		Projector Condition	Note
Off		Normal	–
Blinking light	Red	Lamp has reached its end of life. Lamp replacement message will be displayed.	Replace the lamp.
Steady light	Red	Lamp has been used beyond its limit. The projector will not turn on until the lamp is replaced.	Replace the lamp.
	Green	[ECO MODE] is set to [ON]	–

Over-Temperature Protection

If the temperature inside the projector rises too high, the over-temperature protector will automatically turn off the lamp with the STATUS indicator blinking (2-cycle On and Off.)

Should this happen, do the following:

- Unplug the power cord after the cooling fans stop.
- Move the projector to a cooler location if the room where you are presenting is particularly too warm.
- Clean the ventilation holes if they are clogged with dust.
- Wait about 60 minutes until the inside of the projector becomes cool enough.

Common Problems & Solutions (→ “Power/Status/Lamp Indicator” on page 84.)

Problem	Check These Items
Does not turn on or shut down	<ul style="list-style-type: none"> Check that the power cord is plugged in and that the power button on the projector cabinet or the remote control is on. (→ pages 19 and 20) Ensure that the lamp cover is installed correctly. (→ page 83) Check to see if the projector has overheated. If there is insufficient ventilation around the projector or if the room where you are presenting is particularly warm, move the projector to a cooler location. Check to see if you continue to use the projector for another 100 hours after the lamp has reached the end of its life. If so, replace the lamp. After replacing the lamp, reset the lamp hours used. (→ page 79) The lamp may fail to light. Wait a full minute and then turn on the power again. Set [FAN MODE] to [HIGH ALTITUDE] when using the projector at altitudes approximately 3000 feet/900 meters or higher. Using the projector at altitudes approximately 3000 feet/900 meters or higher without setting to [HIGH ALTITUDE] can cause the projector to overheat and the projector could shut down. If this happens, wait a couple minutes and turn on the projector. (→ page 70) <p>If you turn on the projector immediately after the lamp is turned off, the fans run without displaying an image for some time and then the projector will display the image. Wait for a moment.</p>
Will turn off	<ul style="list-style-type: none"> Ensure that the [OFF TIMER] or [AUTO POWER OFF] is off. (→ page 65, 73)
No picture	<ul style="list-style-type: none"> Use the COMPUTER 1, the COMPUTER 2, the VIDEO or the S-VIDEO button on the remote control to select your source (Computer, Video or S-Video). (→ page 22) If there is still no picture, press the button again. Ensure your cables are connected properly. Use menus to adjust the brightness and contrast. (→ page 58) Remove the lens cap. Reset the settings or adjustments to factory preset levels using the [RESET] in the Menu. (→ page 79) Enter your registered keyword if the Security function is enabled. (→ page 34) Be sure to connect the projector and notebook PC while the projector is in standby mode and before turning on the power to the notebook PC. <p>In most cases the output signal from the notebook PC is not turned on unless connected to the projector before being powered up.</p> <p>* If the screen goes blank while using your remote control, it may be the result of the computer's screen-saver or power management software.</p> <ul style="list-style-type: none"> See also the next page.
Picture suddenly becomes dark	<ul style="list-style-type: none"> Check if the projector is in the Forced ECO mode because of too high ambient temperature. If this is the case, lower the internal temperature of the projector by selecting [HIGH] for [FAN MODE]. (→ page 70)
Color tone or hue is unusual	<ul style="list-style-type: none"> Check if an appropriate color is selected in [WALL COLOR]. If so, select an appropriate option. (→ page 64) Adjust [HUE] in [PICTURE]. (→ page 58)
Image isn't square to the screen	<ul style="list-style-type: none"> Reposition the projector to improve its angle to the screen. (→ page 23) Use the Keystone correction function to correct the trapezoid distortion. (→ page 26)
Picture is blurred	<ul style="list-style-type: none"> Adjust the focus. (→ page 25) Reposition the projector to improve its angle to the screen. (→ page 23) Ensure that the distance between the projector and screen is within the adjustment range of the lens. (→ page 11) Condensation may form on the lens if the projector is cold, brought into a warm place and is then turned on. Should this happen, let the projector stand until there is no condensation on the lens.
Flicker appears on screen	<ul style="list-style-type: none"> Set [FAN MODE] to other than [HIGH ALTITUDE] mode when using the projector at altitudes approximately 3000 feet/900 meters or lower. Using the projector at altitudes less than approximately 3000 feet/900 meters and setting to [HIGH ALTITUDE] can cause the lamp to overcool, causing the image to flicker. Switch [FAN MODE] to [AUTO]. (→ page 70)
Image is scrolling vertically, horizontally or both	<ul style="list-style-type: none"> Check the computer's resolution and frequency. Make sure that the resolution you are trying to display is supported by the projector. (→ page 91) Adjust the computer image manually with the Horizontal/Vertical in the [IMAGE OPTIONS]. (→ page 61)
Remote control does not work	<ul style="list-style-type: none"> Install new batteries. (→ page 8) Make sure there are no obstacles between you and the projector. Stand within 22 feet (7 m) of the projector. (→ page 8) Make sure that the remote control's ID corresponds with the projector's ID. (→ page 69)
Indicator is lit or blinking	<ul style="list-style-type: none"> See the POWER/STATUS/LAMP Indicator. (→ page 84)
Cross color in RGB mode	<ul style="list-style-type: none"> Press the AUTO ADJ. button on the projector cabinet or the remote control. (→ page 28) Adjust the computer image manually with [CLOCK]/[PHASE] in [IMAGE OPTIONS] in the menu. (→ page 60)
Cannot control the projector from external equipment	<ul style="list-style-type: none"> Check to see if [STANDBY MODE] is set to [POWER-SAVING] and if it is, try to set it to [NORMAL]. (→ page 72)
3D picture is not display	<ul style="list-style-type: none"> See “Troubleshooting on viewing 3D images” on page 51.

For more information contact your dealer.

If there is no picture, or the picture is not displayed correctly.

- Power on process for the projector and the PC.

Be sure to connect the projector and notebook PC while the projector is in standby mode and before turning on the power to the notebook PC.

In most cases the output signal from the notebook PC is not turned on unless connected to the projector before being powered up.

NOTE: You can check the horizontal frequency of the current signal in the projector's menu under Information. If it reads "0kHz", this means there is no signal being output from the computer. (→ page 78 or go to next step)

- Enabling the computer's external display.

Displaying an image on the notebook PC's screen does not necessarily mean it outputs a signal to the projector. When using a PC compatible laptop, a combination of function keys will enable/disable the external display. Usually, the combination of the "Fn" key along with one of the 12 function keys gets the external display to come on or off. For example, NEC laptops use Fn + F3, while Dell laptops use Fn + F8 key combinations to toggle through external display selections.

- Non-standard signal output from the computer

If the output signal from a notebook PC is not an industry standard, the projected image may not be displayed correctly. Should this happen, deactivate the notebook PC's LCD screen when the projector display is in use. Each notebook PC has a different way of deactivate/reactivate the local LCD screens as described in the previous step. Refer to your computer's documentation for detailed information.

- Image displayed is incorrect when using a Mac

When using a Mac with the projector, set the DIPswitch of the Mac adapter (not supplied with the projector) according to your resolution. After setting, restart your Mac for the changes to take affect.

For setting display modes other than those supported by your Mac and the projector, changing the DIP switch on a Mac adapter may bounce an image slightly or may display nothing. Should this happen, set the DIP switch to the 13" fixed mode and then restart your Mac. After that, restore the DIP switches to a displayable mode and then restart the Mac again.

NOTE: A Video Adapter cable manufactured by Apple Computer is needed for a MacBook which does not have a mini D-Sub 15-pin connector.

- Mirroring on a MacBook

* When using the projector with a MacBook, output may not be set to 1024 × 768 unless "mirroring" is off on your MacBook. Refer to owner's manual supplied with your Mac computer for mirroring.

- Folders or icons are hidden on the Mac screen

Folders or icons may not be seen on the screen. Should this happen, select [View] → [Arrange] from the Apple menu and arrange icons.

② Specifications

This section provides technical information about projector's performance.

Optical

	V311X	V311W	V281W
Projection System	Single DLP® chip (0.55", aspect 4:3)	Single DLP® chip (0.65", aspect 16:10)	
Resolution*1	1024 × 768 pixels (XGA)	1280 × 800 pixels (WXGA)	
Lens	Manual zoom and focus F=2.41-2.55, f=21.8-24.0 mm		
Lamp	225 W AC (170 W in ECO ON)		
Light Output *2 *3	3100 lumens		2800 lumens
	ECO ON: 75%		
Contrast Ratio*3 (full white: full black)	3000:1		
Image Size (Diagonal)	30–300 inches/0.76–7.6 m (4:3)	30–300 inches/0.76–7.6 m (16:10)	
Projection Distance (mini.-max.)	46" - 465" (wide) / 52" - 520" (tele)	39" - 394" (wide) / 43" - 432" (tele)	
	1.18 - 11.8 m (wide) / 1.32 - 13.2 m (tele)	1.00 - 10.0 m (wide) / 1.10 - 11.0 m (tele)	
Projection Angle	14.0° (wide) / 12.7° (tele)	14.1° (wide) / 12.9° (tele)	

*1 Effective pixels are more than 99.99%.

*2 This is the light output value (lumens) when the [PRESET] mode is set to [HIGH-BRIGHT]. If any other mode is selected as the [PRESET] mode, the light output value may drop slightly.

*3 Compliance with ISO21118-200

Electrical

	V311X	V311W	V281W
Inputs	2 × RGB/Component (D-Sub 15 P), 1 × HDMI (19 P) HDCP supported*4, 1 × S-Video (DIN 4 P), 1 × Video (RCA), 1 × (L/R) RCA Audio, 2 × Stereo Mini Audio		
Output	1 × RGB (D-Sub 15P), 1 × Stereo Mini Audio		
PC Control	1 × PC Control Port (D-Sub 9P)		
Wired LAN Port	1 × RJ-45 (10/100 BASE-T)		
Color Reproduction	16.7 million colors simultaneously, Full color		
Compatible Signals *5	Analog: VGA/SVGA/XGA/WXGA/SXGA/SXGA+/UXGA 480i/480p/576i/576p/720p/1080i HDMI: VGA/SVGA/XGA/WXGA/SXGA 480p/576p/720p/1080i/1080p		
Video Bandwidth	RGB: 80 MHz (Max.)		
Horizontal Resolution	540 TV lines: NTSC/NTSC4.43/PAL/PAL-M/PAL-N/PAL60 300 TV lines: SECAM		
Scan Rate	Horizontal: 15 kHz to 100 kHz (RGB: 24 kHz or over) Vertical: 50 Hz to 120 Hz		
Sync Compatibility	Separate Sync		
Built-in Speaker	7 W (monaural)		
Power Requirement	100 – 240 V AC, 50/60 Hz		
Input Current	3.0-1.4 A		
Power Consumption	ECO MODE	278 W (100-130 V)	
	OFF	268 W (200-240 V)	
	ECO MODE ON	216 W (100-130 V)	
		210 W (200-240 V)	
	STANDBY	3 W (100-130 V)	
	NORMAL	4 W (200-240 V)	
	STANDBY	0.4 W (100-130 V)	
	POWER-SAVING	0.5 W (200-240 V)	

*4 HDMI® (Deep Color, Lip Sync) with HDCP

What is HDCP/HDCP technology?

HDCP is an acronym for High-bandwidth Digital Content Protection. High bandwidth Digital Content Protection (HDCP) is a system for preventing illegal copying of video data sent over a High-Definition Multimedia Interface (HDMI).

If you are unable to view material via the HDMI input, this does not necessarily mean the projector is not functioning properly. With the implementation of HDCP, there may be cases in which certain content is protected with HDCP and might not be displayed due to the decision/intention of the HDCP community (Digital Content Protection, LLC).

Video: Deep Color; 8/10/12-bit, LipSync

Audio: LPCM; up to 2 ch, sample rate 32/44.1/48 KHz, sample bit; 16/20/24-bit

*5 An image with higher or lower resolution than the projector's native resolution (V311X: 1024 × 768 and V311W/V281W: 1280 × 800) will be displayed with scaling technology.

Mechanical

	V311X	V311W	V281W
Installation Orientation	Desktop/Front, Desktop/Rear, Ceiling/Front, Ceiling/Rear		
Dimensions	12.2" (W) × 3.7" (H) × 9.7" (D) 310 mm (W) × 95 mm (H) × 247 mm (D) (not including protrusions)		
Weight	5.5 lbs / 2.5 kg		

Environmental Considerations	Operational Temperatures: 41° to 104°F (5° to 40°C), (ECO mode selected automatically at 95°F to 104°F/35°C to 40°C) 20% to 80% humidity (non-condensing) Storage Temperatures: 14° to 122°F (-10° to 50°C), 20% to 80% humidity (non-condensing) Operating altitude: 0 to 3600 m/12000 feet (900 to 3600 m/3000 to 12000 feet: Set [FAN MODE] to [HIGH ALUTITUDE])
Regulations	UL/C-UL Approved (UL 60950-1, CSA 60950-1) Meets DOC Canada Class B requirements Meets FCC Class B requirements Meets AS/NZS CISPR.22 Class B Meets EMC Directive (EN55022, EN55024, EN61000-3-2, EN61000-3-3) Meets Low Voltage Directive (EN60950-1, TÜV GS Approved) CE

For additional information visit:

US : <http://www.necdisplay.com/>

Europe : <http://www.nec-display-solutions.com/>

Global : <http://www.nec-display.com/global/index.html>

For information on our optional accessories, visit our website or see our brochure.

The specifications are subject to change without notice.

④ Pin Assignments of D-Sub COMPUTER Input Connector

Mini D-Sub 15 Pin Connector

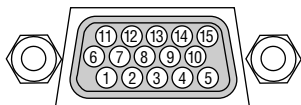

Signal Level

Video signal : 0.7Vp-p (Analog)

Sync signal : TTL level

Pin No.	RGB Signal (Analog)	YCbCr Signal
1	Red	Cr
2	Green or Sync on Green	Y
3	Blue	Cb
4	Ground	
5	Ground	
6	Red Ground	Cr Ground
7	Green Ground	Y Ground
8	Blue Ground	Cb Ground
9	No Connection	
10	Sync Signal Ground	
11	No Connection	
12	Bi-directional DATA (SDA)	
13	Horizontal Sync or Composite Sync	
14	Vertical Sync	
15	Data Clock	

COMPUTER 1 IN

NOTE: Pin Nos. 12 and 15 are required for DDC/CI.

5 Compatible Input Signal List

Horizontal: 15KHz to 100KHz (RGB: 24KHz or over)

Vertical: 50Hz to 120Hz (Signals with higher than refresh rate 85 Hz support resolutions of 1024 × 768 or lower.)

Analog RGB

Signal	Resolution (dots)	Aspect Ratio	Refresh Rate (Hz)
VGA	640 × 480	4:3	60/72/75/85/iMac
SVGA	800 × 600	4:3	56/60/72/75/85/iMac
XGA	1024 × 768 *1	4:3	60/70/75/85/iMac
WXGA	1280 × 768	15:9	60
	1280 × 800 *2	16:10	60
Quad-VGA	1280 × 960	4:3	60
SXGA	1280 × 1024	5:4	60
SXGA+	1400 × 1050	4:3	60
UXGA	1600 × 1200	4:3	60
MAC 13"	640 × 480	4:3	67
MAC 16"	832 × 624	4:3	75
MAC 19"	1024 × 768	4:3	75

HDMI

Signal	Resolution (dots)	Aspect Ratio	Refresh Rate (Hz)
VGA	640 × 480	4:3	60
SVGA	800 × 600	4:3	60
XGA	1024 × 768 *1	4:3	60
WXGA	1280 × 768	15:9	60
	1280 × 800 *2	16:10	60
	1366 × 768	16:9	60
WXGA+	1440 × 900	16:10	60
WXGA++	1600 × 900	16:9	60
Quad-VGA	1280 × 960	4:3	60
SXGA	1280 × 1024	5:4	60
SXGA+	1400 × 1050	4:3	60
WSXGA+	1680 × 1050	16:10	60
HDTV (1080p)	1920 × 1080	16:9	50/60
HDTV (1080i)	1920 × 1080	16:9	50/60
HDTV (720p)	1280 × 720	16:9	50/60
SDTV (480p)	720 × 480	4:3/16:9	60
SDTV (576p)	720 × 576	4:3/16:9	50
SDTV (480i)	720(1440) × 480	4:3/16:9	60
SDTV (576i)	720(1440) × 576	4:3/16:9	50

Component

Signal	Format	Aspect Ratio	Refresh Rate (Hz)
HDTV (1080i)	1920 × 1080	16:9	50/60
HDTV (720p)	1280 × 720	16:9	50/60
SDTV (480p)	720 × 480	4:3/16:9	60
SDTV (576p)	720 × 576	4:3/16:9	50
SDTV (480i)	720 × 480	4:3/16:9	60
SDTV (576i)	720 × 576	4:3/16:9	50

Composite Video/S-Video

Signal	Aspect Ratio	Refresh Rate (Hz)
NTSC	4:3	60
PAL	4:3	50
PAL60	4:3	60
SECAM	4:3	50

3D Computer

Signal	Resolution (dots)	Aspect Ratio	Refresh Rate (Hz)
SVGA	800 × 600	4:3	60*/3/120
XGA	1024 × 768 *1	4:3	60*/3/120
1280 × 720	1280 × 720	16:9	60/120
WXGA	1280 × 800 *2	16:10	60/120*4

3D Component

Signal	Resolution (dots)	Aspect Ratio	Refresh Rate (Hz)
SDTV (480i)	720 × 480	4:3	60

3D Composite Video/S-Video

Signal	Aspect Ratio	Refresh Rate (Hz)
NTSC	4:3	60

*1 Native resolution on XGA model (V311X)

*2 Native resolution on WXGA model (V311W/V281W)

*3 Supports [OVER/UNDER]

*4 Reduced Blanking (RB) signal)

NOTE:

- An image with higher or lower resolution than the projector's native resolution (V311X: 1024 × 768 / V311W/V281W: 1280 × 800) will be displayed with scaling technology.
- Sync on Green and Composite sync signals are not supported.
- Signals other than those specified in the table above may not be displayed correctly. If this should happen, change the refresh rate or resolution on your PC. Refer to Display Properties help section of your PC for procedures.

6 PC Control Codes and Cable Connection

PC Control Codes

Function	Code Data								
POWER ON	02H	00H	00H	00H	00H	02H			
POWER OFF	02H	01H	00H	00H	00H	03H			
INPUT SELECT COMPUTER 1	02H	03H	00H	00H	02H	01H	01H	09H	
INPUT SELECT COMPUTER 2	02H	03H	00H	00H	02H	01H	02H	0AH	
INPUT SELECT HDMI	02H	03H	00H	00H	02H	01H	1AH	22H	
INPUT SELECT VIDEO	02H	03H	00H	00H	02H	01H	06H	0EH	
INPUT SELECT S-VIDEO	02H	03H	00H	00H	02H	01H	0BH	13H	
PICTURE MUTE ON	02H	10H	00H	00H	00H	12H			
PICTURE MUTE OFF	02H	11H	00H	00H	00H	13H			
SOUND MUTE ON	02H	12H	00H	00H	00H	14H			
SOUND MUTE OFF	02H	13H	00H	00H	00H	15H			

NOTE: Contact your local dealer for a full list of the PC Control Codes if needed.

Cable Connection

Communication Protocol

Baud rate38400 bps
 Data length8 bits
 ParityNo parity
 Stop bit.....One bit
 X on/off.....None
 Communications procedure.....Full duplex

NOTE: Depending on the equipment, a lower baud rate may be recommended for long cable runs.

PC Control Connector (D-SUB 9P)

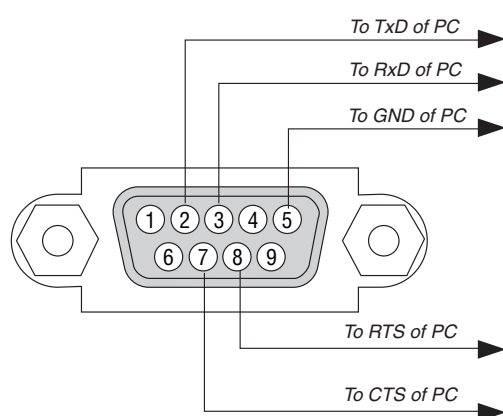

NOTE 1: Pins 1, 4, 6 and 9 are no used.

NOTE 2: Jumper "Request to Send" and "Clear to Send" together on both ends of the cable to simplify cable connection.

NOTE 3: For long cable runs it is recommended to set communication speed within projector menus to 9600 bps.

7 Troubleshooting Check List

Before contacting your dealer or service personnel, check the following list to be sure repairs are needed also by referring to the “Troubleshooting” section in your user’s manual. This checklist below will help us solve your problem more efficiently.

* Print this page and the next page for your check.

Frequency of occurrence always sometimes (How often? _____) other (_____)

Power

- No power (POWER indicator does not light green). See also “Status Indicator (STATUS)”.
- Power cord’s plug is fully inserted into the wall outlet.
- Lamp cover is installed correctly.
- Lamp Hours Used (lamp operation hours) was cleared after lamp replacement.
- No power even though you press and hold the POWER button.
- Shut down during operation.
 - Power cord’s plug is fully inserted into the wall outlet.
 - Lamp cover is installed correctly .
 - [AUTO POWER OFF] is turned off (only models with the [AUTO POWER OFF] function).
 - [OFF TIMER] is turned off (only models with the [OFF TIMER] function).

Video and Audio

- No image is displayed from your PC or video equipment to the projector.
 - Still no image even though you connect the projector to the PC first, then start the PC.
 - Enabling your notebook PC’s signal output to the projector.
 - *A combination of function keys will enable/disable the external display. Usually, the combination of the “Fn” key along with one of the 12 function keys turns the external display on or off.*
 - No image (blue or black background, no display).
 - Still no image even though you press the AUTO ADJ. button.
 - Still no image even though you carry out [RESET] in the projector’s menu.
 - Signal cable’s plug is fully inserted into the input connector
 - A message appears on the screen. (_____)
 - The source connected to the projector is active and available.
 - Still no image even though you adjust the brightness and/or the contrast.
 - Input source’s resolution and frequency are supported by the projector.
- Image is too dark.
 - Remains unchanged even though you adjust the brightness and/or the contrast.
- Image is distorted.
 - Image appears to be trapezoidal (unchanged even though you carry out the [KEYSTONE] adjustment).
- Parts of the image are lost.
 - Still unchanged even though you press the AUTO ADJ. button.
 - Still unchanged even though you carry out [RESET] in the projector’s menu.
- Image is shifted in the vertical or horizontal direction.
 - Horizontal and vertical positions are correctly adjusted on a computer signal.
 - Input source’s resolution and frequency are supported by the projector.
 - Some pixels are lost.
- Image is flickering.
 - Still unchanged even though you press the AUTO ADJ. button.
 - Still unchanged even though you carry out [RESET] in the projector’s menu.
 - Image shows flickering or color drift on a computer signal.
 - Still unchanged even though you change [FAN MODE] from [HIGH ALTITUDE] to [AUTO].
- Image appears blurry or out of focus.
 - Still unchanged even though you checked the signal’s resolution on PC and changed it to projector’s native resolution.
 - Still unchanged even though you adjusted the focus.
- No sound.
 - Audio cable is correctly connected to the audio input of the projector.
 - Still unchanged even though you adjusted the volume level.
 - AUDIO OUT is connected to your audio equipment (only models with the AUDIO OUT connector).

Other

- Remote control does not work.
 - No obstacles between the sensor of the projector and the remote control.
 - Projector is placed near a fluorescent light that can disturb the infrared remote controls.
 - Batteries are new and are not reversed in installation.
- Buttons on the projector cabinet do not work (only models with the [CONTROL PANEL LOCK] function)
 - [CONTROL PANEL LOCK] is not turned on or is disabled in the menu.
 - Still unchanged even though you press and hold the EXIT button for a minimum of 10 seconds.

In the space below please describe your problem in detail.

Information on application and environment where your projector is used

Projector

Model number:

Serial No.:

Date of purchase:

Lamp operating time (hours):

Eco Mode: Off On

Information on input signal:

Horizontal synch frequency [] kHz

Vertical synch frequency [] Hz

Synch polarity H (+) (-)

V (+) (-)

Synch type Separate Composite

Sync on Green

STATUS Indicator:

Steady light Orange Green

Flashing light [] cycles

Remote control model number:

Installation environment

Screen size: inch

Screen type: White matte Beads Polarization
 Wide angle High contrast

Throw distance: feet/inch/m

Orientation: Ceiling mount Desktop

Power outlet connection:

- Connected directly to wall outlet
- Connected to power cord extender or other (the number of connected equipment _____)
- Connected to a power cord reel or other (the number of connected equipment _____)

Computer

Manufacturer:

Model number:

Notebook PC / Desktop

Native resolution:

Refresh rate:

Video adapter:

Other:

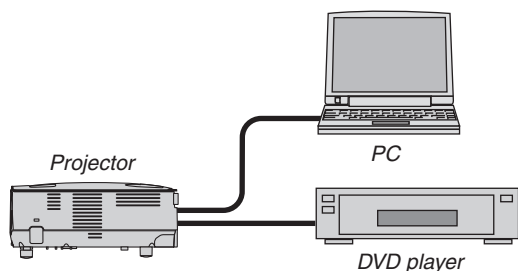

Signal cable

NEC standard or other manufacturer's cable?

Model number: Length: inch/m

Distribution amplifier

Model number:

Switcher

Model number:

Adapter

Model number:

Video equipment

VCR, DVD player, Video camera, Video game or other

Manufacturer:

Model number:

8 REGISTER YOUR PROJECTOR! (for residents in the United States, Canada, and Mexico)

Please take time to register your new projector. This will activate your limited parts and labor warranty and InstaCare service program.

Visit our web site at www.necdisplay.com, click on support center/register product and submit your completed form online. Upon receipt, we will send a confirmation letter with all the details you will need to take advantage of fast, reliable warranty and service programs from the industry leader, NEC Display Solutions of America, Inc.

NEC