

Panasonic®

Operating Instructions Functional Manual

LCD Projector **Commercial Use**

Model No.

PT-LB330

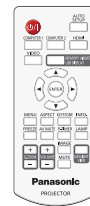
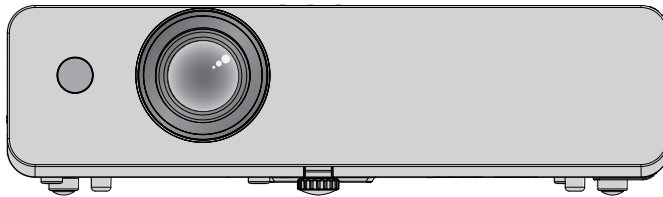

Thank you for purchasing this Panasonic Product.

- Before operating this product, please read the instructions carefully, and save this manual for future use.
- Before using your projector, be sure to read “Read this first!” (➔ pages 2 to 9).

PJLink™

ProSelecta

View :: Compare :: Select - www.ProSelecta.com

Read this first!

WARNING: THIS APPARATUS MUST BE EARTHED.

WARNING: To prevent damage which may result in fire or shock hazard, do not expose this appliance to rain or moisture.
This device is not intended for use in the direct field of view at visual display workplaces. To avoid incommoding reflexions at visual display workplaces this device must not be placed in the direct field of view.
The equipment is not intended for used at a video workstation in compliance BildscharbV.

The sound pressure level at the operator position is equal or less than 70 dB (A) according to ISO 7779.

WARNING:

1. Remove the plug from the mains socket when this unit is not in use for a prolonged period of time.
2. To prevent electric shock, do not remove cover. No user serviceable parts inside. Refer servicing to qualified service personnel.
3. Do not remove the earthing pin on the mains plug. This apparatus is equipped with a three prong earthing type mains plug. This plug will only fit an earthing-type mains socket. This is a safety feature. If you are unable to insert the plug into the mains socket, contact an electrician. Do not defeat the purpose of the earthing plug.

CAUTION: To assure continued compliance, follow the attached installation instructions. This includes using the provided power cord and shielded interface cables when connecting to computer or peripheral devices. Also, any unauthorized changes or modifications to this equipment could void the user's authority to operate this device.

Product information (for Turkey only)

EEE Yönetmeliğine Uygundur.
EEE Complies with Directive of Turkey.

WARNING: TO REDUCE THE RISK OF FIRE OR ELECTRIC SHOCK, DO NOT EXPOSE THIS PRODUCT TO RAIN OR MOISTURE.



The lightning flash with arrowhead symbol, within an equilateral triangle, is intended to alert the user to the presence of uninsulated "dangerous voltage" within the product's enclosure that may be of sufficient magnitude to constitute a risk of electric shock to persons.



The exclamation point within an equilateral triangle is intended to alert the user to the presence of important operating and maintenance (servicing) instructions in the literature accompanying the product.

This is a device to project images onto a screen, etc., and is not intended for use as indoor lighting in a domestic environment.

Directive 2009/125/EC

Importer's name and address within the European Union
Panasonic Marketing Europe GmbH
Panasonic Testing Center
Winsbergring 15, 22525 Hamburg, Germany

CAUTION (North/Middle/South America)

CAUTION: This equipment is equipped with a three-pin grounding-type power plug. Do not remove the grounding pin on the power plug. This plug will only fit a grounding-type power outlet. This is a safety feature. If you are unable to insert the plug into the outlet, contact an electrician. Do not defeat the purpose of the grounding plug.

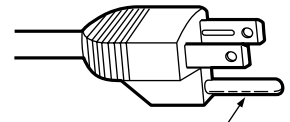

Do not remove

FCC NOTICE (USA)

Declaration of Conformity

Model Number: PT-LW330 / PT-LW280 / PT-LB360 / PT-LB330 / PT-LB300 / PT-LB280
Trade Name: Panasonic
Responsible Party: Panasonic Corporation of North America
Address: Two Riverfront Plaza, Newark, NJ 07102-5490
General Contact: <http://www.panasonic.com/contactinfo>
Projector Contact: <http://www.panasonic.net/avc/projector/>

This device complies with Part 15 of the FCC Rules.

Operation is subject to the following two conditions:

(1) This device may not cause harmful interference, and (2) this device must accept any interference received, including interference that may cause undesired operation.

To assure continued compliance, follow the attached installation instructions and do not make any unauthorized modifications.

CAUTION:

This equipment has been tested and found to comply with the limits for a Class B digital device, pursuant to Part 15 of the FCC Rules. These limits are designed to provide reasonable protection against harmful interference in a residential installation. This equipment generates, uses and can radiate radio frequency energy and, if not installed and used in accordance with the instructions, may cause harmful interference to radio communications. However, there is no guarantee that interference will not occur in a particular installation. If this equipment does cause harmful interference to radio or television reception, which can be determined by turning the equipment off and on, the user is encouraged to try to correct the interference by one of the following measures:

- Reorient or relocate the receiving antenna.
- Increase the separation between the equipment and receiver.
- Connect the equipment into an outlet on a circuit different from that to which the receiver is connected.
- Consult the dealer or an experienced radio/BD technician for help.

The user may find the booklet "Something About Interference" available from FCC local regional offices helpful.

FCC Warning:

To assure continued FCC emission limit compliance, follow the attached installation instructions. This includes using the provided power cord and shielded interface cables when connecting to computer or peripheral devices. Also, any unauthorized changes or modifications to this equipment could void the user's authority to operate this device.

NOTIFICATION (Canada)

This class B digital apparatus complies with Canadian ICES-003.

WARNING:

- Not for use in a computer room as defined in the Standard for the Protection of Electronic Computer/Data Processing Equipment, ANSI/NFPA 75.
- For permanently connected equipment, a readily accessible disconnect device shall be incorporated in the building installation wiring.
- For pluggable equipment, the socket-outlet shall be installed near the equipment and shall be easily accessible.



Notice (USA only):

- This product has a High Intensity Discharge (HID) lamp that contains mercury. Disposal may be regulated in your community due to environmental considerations. For disposal or recycling information, please visit Panasonic website: <http://www.panasonic.com/environmental> or call 1-888-769-0149.

IMPORTANT: THE MOULDED PLUG (U.K. only)

FOR YOUR SAFETY, PLEASE READ THE FOLLOWING TEXT CAREFULLY.

This appliance is supplied with a moulded three pin mains plug for your safety and convenience. A 13 amp fuse is fitted in this plug. Should the fuse need to be replaced, please ensure that the replacement fuse has a rating of 13 amps and that it is approved by ASTA or BSI to BS1362.

Check for the ASTA mark  or the BSI mark  on the body of the fuse.

If the plug contains a removable fuse cover, you must ensure that it is refitted when the fuse is replaced. If you lose the fuse cover, the plug must not be used until a replacement cover is obtained. A replacement fuse cover can be purchased from an Authorised Service Center.

If the fitted moulded plug is unsuitable for the mains socket in your home, then the fuse should be removed and the plug cut off and disposed of safely. There is a danger of severe electrical shock if the cut off plug is inserted into any 13 amp socket.

If a new plug is to be fitted, please observe the wiring code as shown below.

If in any doubt, please consult a qualified electrician.

WARNING: THIS APPLIANCE MUST BE EARTHED.

IMPORTANT: The wires in this mains lead are coloured in accordance with the following code:

Green - and - Yellow:	Earth
Blue:	Neutral
Brown:	Live

As the colours of the wire in the mains lead of this appliance may not correspond with the coloured markings identifying the terminals in your plug, proceed as follows.

The wire which is coloured GREEN - AND - YELLOW must be connected to the terminal in the plug which is marked with the letter E or by the Earth symbol  or coloured GREEN or GREEN - AND - YELLOW.

The wire which is coloured BLUE must be connected to the terminal in the plug which is marked with the letter N or coloured BLACK.

The wire which is coloured BROWN must be connected to the terminal in the plug which is marked with the letter L or coloured RED.

How to replace the fuse: Open the fuse compartment with a screwdriver and replace the fuse.

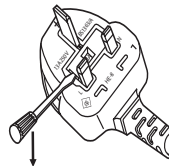

WARNING:

■ POWER

The wall outlet or the circuit breaker shall be installed near the equipment and shall be easily accessible when problems occur. If the following problems occur, cut off the power supply immediately.

Continued use of the projector in these conditions will result in fire or electric shock.

- If foreign objects or water get inside the projector, cut off the power supply.
 - If the projector is dropped or the cabinet is broken, cut off the power supply.
 - If you notice smoke, strange smells or noise coming from the projector, cut off the power supply.
- Please contact an Authorized Service Center for repairs, and do not attempt to repair the projector yourself.

During a thunderstorm, do not touch the projector or the cable.

Electric shocks can result.

Do not do anything that might damage the power cord or the power plug.

If the power cord is used while damaged, electric shocks, short-circuits or fire will result.

- Do not damage the power cord, make any modifications to it, place it near any hot objects, bend it excessively, twist it, pull it, place heavy objects on top of it or wrap it into a bundle.

Ask an Authorized Service Center to carry out any repairs to the power cord that might be necessary.

Completely insert the power plug into the wall outlet and the power connector into the projector terminal.

If the plug is not inserted correctly, electric shocks or overheating will result.

- Do not use plugs which are damaged or wall outlets which are coming loose from the wall.

Do not use anything other than the provided power cord.

- Failure to observe this will result in electric shocks or fire. Please note that if you do not use the provided power cord to ground the device on the side of the outlet, this may result in electric shocks.

Clean the power plug regularly to prevent it from becoming covered in dust.

Failure to observe this will cause a fire.

- If dust builds up on the power plug, the resulting humidity can damage the insulation.
 - If not using the projector for an extended period of time, pull the power plug out from the wall outlet.
- Pull the power plug out from the wall outlet and wipe it with a dry cloth regularly.

Do not handle the power plug and power connector with wet hands.

Failure to observe this will result in electric shocks.

Do not overload the wall outlet.

If the power supply is overloaded (ex., by using too many adapters), overheating may occur and fire will result.

■ ON USE/INSTALLATION

Do not place liquid containers on top of the projector.

If water spills onto the projector or gets inside it, fire or electric shocks will result.

If any water gets inside the projector, contact an Authorized Service Center.

Do not place the projector on soft materials such as carpets or sponge mats.

Doing so will cause the projector to overheat, which can cause burns, fire or damage to the projector.

Do not set up the projector in humid or dusty places or in places where the projector may come into contact with oily smoke or steam.

Using the projector under such conditions will result in fire, electric shocks or components deterioration. Components deterioration (such as ceiling mount brackets) may cause the projector which is mounted on the ceiling to fall down.

Do not install this projector in a place which is not strong enough to take the full weight of the projector or on top of a surface which is sloped or unstable.

Failure to observe this will cause projector to fall down or tip over the projector, and severe injury or damage could result.

Do not place another projector or other heavy objects on top of the projector.

Failure to observe this will cause the projector to become unbalanced and fall, which could result in damage or injury. The projector will be damaged or deformed.

Installation work (such as ceiling mount bracket) should only be carried out by a qualified technician.

If installation is not carried out and secured correctly it can cause injury or accidents, such as electric shocks.

- Do not use anything other than an authorized ceiling mount bracket.
- Be sure to use the wire provided with the projector mount bracket for ceiling mount as an extra safety measure to prevent the projector from falling down (Install in a different location to the ceiling mount bracket).

WARNING:

Do not cover the air intake port or the air exhaust port.

Doing so will cause the projector to overheat, which can cause fire or damage to the projector.

- Do not place the projector in narrow, badly ventilated places.
- Do not place the projector on cloth or papers, as these materials could be drawn into the air intake port.

Do not place your hands or other objects close to the air exhaust port.

Doing so will cause burns or damage your hands or other objects.

- Heated air comes out of the air exhaust port. Do not place your hands or face, or objects which cannot withstand heat close to this port.

Do not look and place your skin into the lights emitted from the lens while the projector is being used.

Doing so can cause burns or loss of sight.

- Strong light is emitted from the projector's lens. Do not look or place your hands directly into this light.
- Be especially careful not to let young children look into the lens. In addition, turn off the power and disconnect the power plug when you are away from the projector.

Do not insert any foreign objects into the projector.

Doing so will cause fire or electric shocks.

- Do not insert any metal objects or flammable objects into the projector or drop them onto the projector.

Never attempt to remodel or disassemble the projector.

High voltages can cause fire or electric shocks.

- For any inspection, adjustment and repair work, please contact an Authorized Service Center.

Do not allow metal objects, flammable objects, or liquids to enter inside of the projector. Do not allow the projector to get wet.

Doing so may cause short circuits or overheating, and result in fire, electric shock, or malfunction of the projector.

- Do not place containers of liquid or metal objects near the projector.
- If liquid enters inside of the projector, consult your dealer.
- Particular attention must be paid to children.

Use the ceiling mount bracket specified by Panasonic.

Defects in the ceiling mount bracket will result in falling accidents.

- Attach the supplied safety cable to the ceiling mount bracket to prevent the projector from falling down.

Do not touch or remove the rubber cap at the bottom of the projector.

- Doing so will cause burns because the temperature is very high when the lamp is lighting and for a while after the lamp is turned off.

■ ACCESSORIES

Do not use or handle the batteries improperly, and refer to the following.

Failure to observe this will cause burns, batteries to leak, overheat, explode or catch fire.

- Do not use unspecified batteries.
- Do not disassemble dry cell batteries.
- Do not heat the batteries or place them into water or fire.
- Do not allow the + and - terminals of the batteries to come into contact with metallic objects such as necklaces or hairpins.
- Do not store or carry batteries together with metallic objects.
- Store the batteries in a plastic bag and keep them away from metallic objects.
- Make sure the polarities (+ and -) are correct when inserting the batteries.
- Do not use a new battery together with an old battery or mix different types of batteries.
- Do not use batteries with the outer cover peeling away or removed.
- Remove the empty batteries from the remote control at once.
- Insulate the battery using tape or something similar before disposal.

Do not allow children to reach the batteries and the rubber cap that is removed from the bottom of the projector.

- The battery can cause personal injury if swallowed.
- If swallowed, seek medical advice immediately.

If the battery fluid leaks, do not touch it with bare hands, and take the following measures if necessary.

- Battery fluid on your skin or clothing could result in skin inflammation or injury.
Rinse with clean water and seek medical advice immediately.
- Battery fluid coming in contact with your eyes could result in loss of sight.
In this case, do not rub your eyes. Rinse with clean water and seek medical advice immediately.

WARNING:

Do not disassemble the lamp unit.

If the lamp breaks, it could cause injury.

Lamp replacement

The lamp has high internal pressure. If improperly handled, an explosion and severe injury or accidents will result.

- The lamp can easily explode if struck against hard objects or dropped.
- Before replacing the lamp, be sure to disconnect the power plug from the wall outlet. Electric shocks or explosions can result if this is not done.
- When replacing the lamp, turn the power off and allow the lamp to cool for at least 1 hour before handling it otherwise it can cause burns.

Do not allow infants or pets to touch the remote control unit.

- Keep the remote control unit out of the reach of infants and pets after using it.

Do not use the supplied power cord with devices other than this projector.

- Using the supplied power cord with devices other than this projector may cause short circuits or overheating, and result in electric shock or fire.

Remove the depleted batteries from the remote control promptly.

- Leaving them in the unit may result in fluid leakage, overheating, or explosion of the batteries.

CAUTION:

■ **POWER**

When disconnecting the power cord, be sure to hold the power plug and power connector.

If the power cord itself is pulled, the lead will become damaged, and fire, short-circuits or serious electric shocks will result.

When not using the projector for an extended period of time, disconnect the power plug from the wall outlet and remove the batteries from the remote control.

Disconnect the power plug from the wall outlet before carrying out any cleaning and replacing the unit.

Electric shocks can result if this is not done.

■ **ON USE/INSTALLATION**

Do not place heavy objects on top of the projector.

Failure to observe this will cause the projector to become unbalanced and fall, which could result in damage or injury. The projector will be damaged or deformed.

Do not put your weight on this projector.

You could fall or the projector could break, and injury will result.

- Be especially careful not to let young children stand or sit on the projector.

Do not place the projector in extremely hot locations.

Doing so will cause the outer casing or internal components to deteriorate, or result in fire.

- Take particular care in locations exposed to direct sunlight or near stoves.

Always disconnect all cables before moving the projector.

Moving the projector with cables still attached can damage the cables, which will cause fire or electric shocks to occur.

Never plug headphones and earphones into <VARIABLE AUDIO OUT> terminal.

Excessive sound pressure from earphones and headphones can cause hearing loss.

■ **ACCESSORIES**

Do not use the old lamp unit.

If used it could cause lamp explosion.

If the lamp has broken, ventilate the room immediately. Do not touch or bring your face close to the broken pieces.

Failure to observe this will cause the user to absorb the gas which was released when the lamp broke and which contains nearly the same amount of mercury as fluorescent lamps, and the broken pieces will cause injury.

- If you believe that you have absorbed the gas or that the gas has got into your eyes or mouth, seek medical advice immediately.
- Ask your dealer about replacing the lamp unit and check the inside of the projector.

CAUTION:

■ **MAINTENANCE**

Ask your dealer about cleaning inside the projector once a year.

Continuous use while dust is accumulated inside the projector may result in fire.

- For cleaning fee, ask your dealer.

Brazil Only

Brasil Apenas

■ **Manuseio de baterias usadas**



BRASIL

Após o uso, as pilhas e /ou baterias deverão ser entregues ao estabelecimento comercial ou rede de assistência técnica autorizada.

Cobrir os terminais positivo (+) e negativo (-) com uma fita isolante adesiva, antes de depositar numa caixa destinada para o recolhimento. O contato entre partes metálicas pode causar vazamentos, gerar calor, romper a blindagem e produzir fogo. (Fig. 1)

Fig. 1
Como isolar os terminais

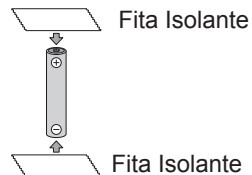

Não desmonte, não remova o invólucro, nem amasse a bateria. O gás liberado pela bateria pode irritar a garganta, danificar o lacre do invólucro ou o vazamento provocar calor, ruptura da blindagem e produzir fogo devido ao curto circuito dos terminais. Não incinere nem aqueça as baterias, elas não podem ficar expostas a temperaturas superiores a 100 °C (212 °F). O gás liberado pela bateria pode irritar a garganta, danificar o lacre do invólucro ou o vazamento provocar calor, ruptura da blindagem e produzir fogo devido ao curto circuito dos terminais provocado internamente.

Evite o contato com o líquido que vazar das baterias. Caso isto ocorra, lave bem a parte afetada com bastante água. Caso haja irritação, consulte um médico.

■ **Remoção das baterias**

1. Pressione a guia e levante a tampa.

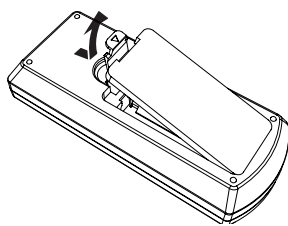

2. Remova as baterias.

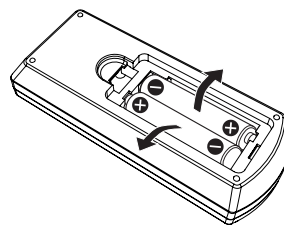



To remove the battery

1. Press the guide and lift the cover.

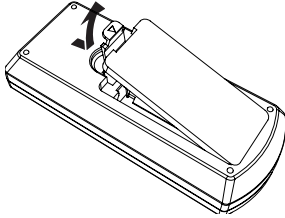

2. Remove the batteries.

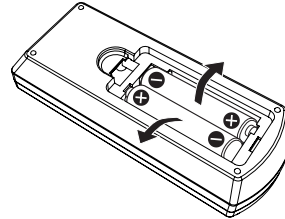

■ Trademarks

- Windows, Windows Vista and Internet Explorer are registered trademarks or trademarks of Microsoft Corporation in the United States and other countries.
- Mac, Mac OS, OS X and Safari are trademarks of Apple Inc., registered in the United States and other countries.
- HDMI, the HDMI logo and High-Definition Multimedia Interface is a trademark or registered trademark of HDMI Licensing LLC.
- PJLink™ is a trademark or pending trademark in Japan, the United States, and other countries and regions.
- Adobe and Adobe Reader are trademarks or registered trademarks of Adobe Systems Inc. in the United States and/or other countries.
- All other names, company names, and product names mentioned in this manual are trademarks or registered trademarks of their respective owners.

Please note that the ® and ™ symbols are not specified in this manual.

■ Illustrations in these operating instructions

- Illustrations of the projector, screen, and other parts may vary from the actual product.

■ Page references

- Reference pages in this manual are indicated as : (➡ page 00).

■ Terms

- In this manual, the “Wireless remote control unit” accessory is referred to as the “Remote control”.
- The <INPUT/ENTER> button on the control panel is functioned as the <ENTER> button when the menu screen is displayed. The operating procedure of menu screen is described as “Press the <ENTER> button” in this manual in order to unify the control panel operation with the remote control operation.

Features of the Projector

Comfortable viewing in a bright environment

- ▶ The high contrast ratio 10 000 : 1 is achieved in a compact body.
- ▶ The low noise level 28 dB*1 supports comfortable viewing during quiet scenes.
- ▶ Supports comfortable viewing in a bright room by pressing the <DAYLIGHT VIEW> button on the remote control. (Daylight View Lite function)

*1 When [Lamp control] is set to [💡 (Eco 2)]

Abundant Image correction Function

(Only for PT-LW330, PT-LW280, PT-LB360 and PT-LB330)

- ▶ H/V Keystone, Corner correction and Curved correction functions allow you to correct the image to fit the screen.

Reduced maintenance costs

- ▶ Maintenance costs are reduced by use of a recommended lamp replacement interval of 8 000 H*1.

*1 When [Lamp control] is constantly set to [💡 (Eco 2)] without switching to other modes
This time is only the target for replacement and not the warranty time.

Quick Steps

For details, see the corresponding pages.

1. **Set up your projector.**
(⇒ page 25)



2. **Connect with other devices.**
(⇒ page 30)



3. **Connect the power cord.**
(⇒ page 34)



4. **Power on.**
(⇒ page 35)



5. **Select the input signal.**
(⇒ page 37)



6. **Adjust the image.**
(⇒ page 37)

Contents

Be sure to read “Read this first!” from page 2.

Read this first! 2

Chapter 1 Preparation

Precautions for use	14
Cautions when transporting.....	14
Cautions when installing.....	14
Security	15
Disposal.....	15
Cautions on use	16
Accessories	17
Contents of the supplied CD-ROM.....	17
Optional accessories	18
About your projector	19
Remote control.....	19
Projector body	20
Using the remote control	23
Inserting and Removing batteries.....	23
Setting Remote control ID numbers	23

Chapter 2 Getting Started

Setting up	25
Installation mode	25
Parts for ceiling mount (Optional).....	25
Screen size and throw distance	26
Adjusting adjustable foot	29
Connecting	30
Before connecting	30
Connecting example : AV equipment	31
Connecting example : Computers	31

Chapter 3 Basic Operations

Powering on/off	34
Connecting the power cord	34
Power indicator.....	34
Powering On the Projector	35
A PIN code input screen appears	35
Making adjustments and selections	36
Powering Off the Projector	36
Projecting	37
Selecting the input signal	37
How to adjust the state of the image	37
Basic operations by using the remote control	38
Using the automatic setup function	38
Switching the input signal.....	38
Switching the aspect ratio of the image.....	39
Using the keystone distortion and curved correction functions	39
Using the information function.....	40
Using the freeze function.....	40
Using the AV mute function	40

Using the presentation timer function.....	40
Switching the lamp power	40
Using the digital zoom function	41
Controlling the volume of the speaker.....	41
Switching the image mode	41
Using the mute function.....	42
Using the Daylight View Lite function	42

Chapter 4 Settings

Menu Navigation	44
Navigating through the menu	44
Main menu.....	45
Sub-menu.....	46
[Input] menu	48
Switching the input source	48
[Display] menu	49
[Auto PC adj.]	49
[Fine sync]	49
[H Position]	49
[V Position]	50
[H.Size].....	50
[Aspect]	50
[Project way].....	51
[Menu position].....	51
[Background display]	51
[System]	51
[Color adjust] menu	52
[Image mode]	52
[Contrast].....	52
[Brightness]	52
[Color].....	53
[Tint].....	53
[Color temp.].....	53
[Red] / [Green] / [Blue].....	53
[Sharpness]	54
[Daylight View].....	54
[Setting] menu	55
[On start].....	55
[Standby mode]	55
[High land]	55
[Lamp control].....	56
[Cooling fast]	56
[Closed caption].....	56
[Key lock].....	57
[Iris].....	57
[Terminal].....	57
[Sound]	57
[HDMI Setup].....	58
[Expand] menu	59
[Language]	59
[Auto setup]	59
[Keystone]	61

[Logo]	64
[Security]	66
[Power management]	67
[Filter counter]	68
[Test pattern].....	68
[Network]	69
[Remote control]	70
[Factory default].....	70
[Memory Viewer] menu	71
[Set Slide]	71
[Slide Transition Effect].....	71
[Sort Order].....	71
[Rotate].....	71
[Best Fit]	72
[Repeat].....	72
[Apply]	72
[Info.] menu	73
[Info.]	73
Network control	74
Network connections	74
Accessing from the Web browser.....	75
Using useful functions	79
Memory Viewer function	79
USB Display function.....	81

Chapter 5 Maintenance

Power/Warning Indicators	84
When an indicator lights up	84
Maintenance/replacement.....	86
Before performing maintenance/replacement	86
Maintenance.....	86
Replacing the unit.....	88
Troubleshooting	91

Chapter 6 Appendix

Technical Information	93
PJLink protocol.....	93
<SERIAL IN> terminal	94
List of compatible signals	97
Specifications	99
Dimensions	101
Ceiling mount bracket safeguards.....	102
Index	103

Chapter 1 Preparation

This chapter describes things you need to know or check before using the projector.

Precautions for use

Cautions when transporting

- When transporting the projector, hold it securely by its bottom and avoid excessive vibration and impacts. Doing so may damage the internal parts and result in malfunctions.
- Do not transport the projector with the adjustable foot extended. Doing so may damage the adjustable foot.

Cautions when installing

■ Do not set up the projector outdoors.

The projector is designed for indoor use only.

■ Do not set up the projector in the following locations.

- Places where vibration and impacts occur such as in a car or vehicle: Doing so may cause damage to internal components or malfunction.
- Near the exhaust of an air conditioner: Depending on the conditions of use, the screen may fluctuate in rare cases due to the heated air from the air exhaust port or the hot or cooled air. Make sure that the exhaust from the projector or other equipment, or the air from the air conditioner does not blow toward the front of the projector.
- Places with sharp temperature fluctuations such as near lights (studio lamps): Doing so may shorten the life of the lamp, or result in deformation of the outer case due to heat, which may cause malfunctions.
The operating environment temperature of the projector should be between 5 °C (41 °F) and 40 °C (104 °F) when using it at elevations lower than 1 400 m (4 593') above sea level, and between 5 °C (41 °F) and 35 °C (95 °F) when using it at high altitudes (between 1 400 m (4 593') and 2 700 m (8 858') above sea level).
- Near high-voltage power lines or near motors: Doing so may interfere with the operation of the projector.

■ Be sure to ask a specialized technician when installing the product to a ceiling.

This requires an optional ceiling mount bracket. Be sure to use the Projector Mount Bracket together with the ceiling mount bracket for high ceilings or low ceilings.

Model No.: ET-PKL100H (for high ceilings), ET-PKL100S (for low ceilings), ET-PKL420B (Projector Mount Bracket)

■ When using the projector in the elevation of below 1 400 m (4 593'), make sure [High land] is set to [Off].

Failure to do so may shorten the life of the internal parts and result in malfunctions.

■ When using the projector in the elevation of above 1 400 m (4 593') and below 2 700 m (8 858'), make sure [High land] is set to [On].

Failure to do so may shorten the life of the internal parts and result in malfunctions.

■ Do not install the projector at elevations of 2 700 m (8 858') or higher above sea level.

Failure to do so may shorten the life of the internal parts and result in malfunctions.

■ Do not tilt the projector or place it on its side.

Do not tilt the projector body more than approximately ± 30 degrees vertically or ± 15 degrees horizontally. Over tilting may result in shortening the life of the components.

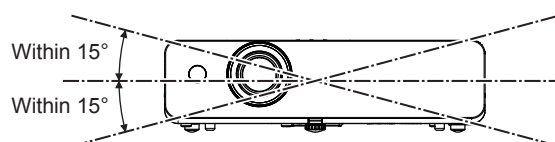
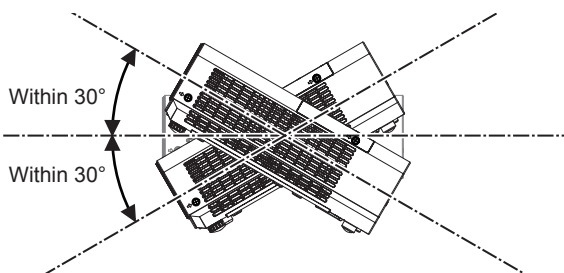

■ Cautions when setting the projectors

- Do not stack the projectors.
- Do not use the projector supporting it by the top.
- Do not block the ventilation ports (intake and exhaust) of the projector.
- Avoid heating and cooling air from the air conditioning system directly blow to the ventilation ports (intake and exhaust) of the projector.

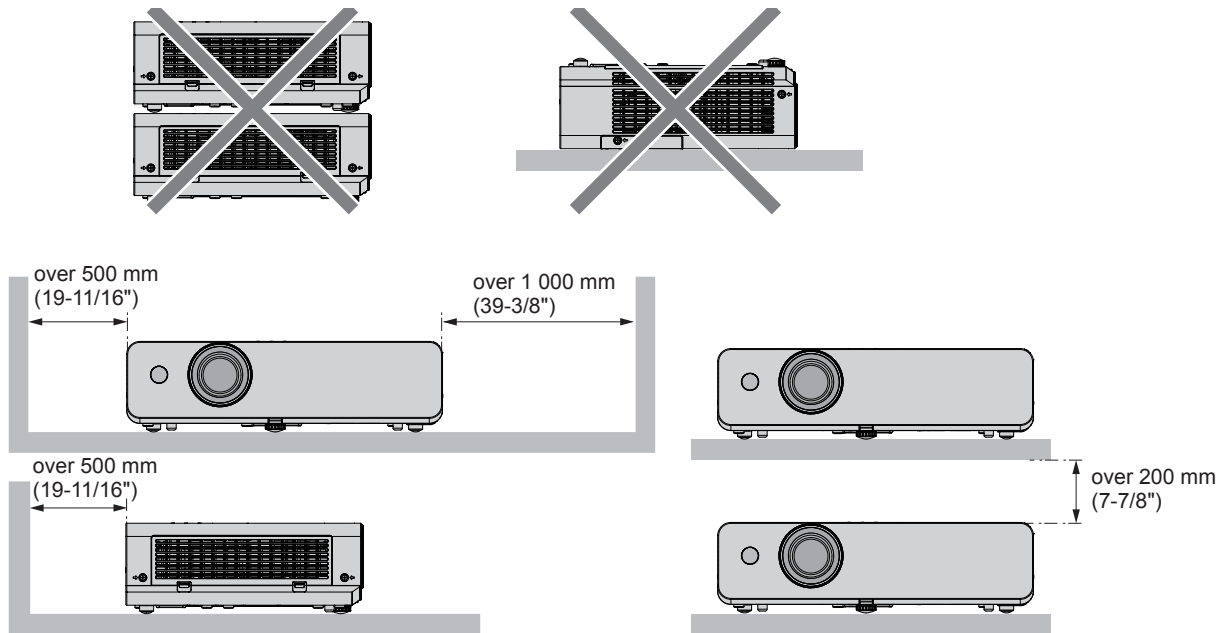

- Do not install the projector in a confined space.
When placing the projector in a confined space, a ventilation and/or air conditioning system is required. Exhaust heat may accumulate when the ventilation is not enough, triggering the protection circuit of the projector.

Security

Take safety measures against following incidents.

- Personal information being leaked via this product.
- Unauthorized operation of this product by a malicious third party.
- Interfering or stopping of this product by a malicious third party.

Security instruction (➔ pages 66, 76)

- Make your password as difficult to guess as possible.
- Change your password periodically.
- Panasonic or its affiliate company never inquires a password directly to a customer. Do not tell your password in case you receive such an inquiry.
- The connecting network must be secured by firewall or others.
- Set a password for web control and restrict the users who can log in.

Note

- LAN function is not available for PT-LB300 and PT-LB280.

Disposal

When disposing of the product, ask your local authority or dealer about the correct methods of disposal.

The lamp contains mercury. When disposing of the used lamp unit, ask your nearest local authorities or dealer about proper disposal of the unit.

Dispose of used batteries according to the instructions or your local disposal rule or guidelines.

Cautions on use

■ To get a good picture quality

- Draw curtains or blinds over windows and turn off any lights near the screen to prevent outside light or light from indoor lamps from shining onto the screen.
- Depending on where the projector is used, heated air from an exhaust port or warm or cold air from an air conditioner can cause a shimmering effect on screen.
Avoid use in locations where exhaust or streams of air from projector, other devices and air conditioners flow between the projector and the screen.
- The lens of projector is affected by the heat from the luminous source. Because of this, the focusing may not be stable right after the power is turned on. Focusing is stabilized after projecting image for 30 minutes and longer.

■ Do not touch the surface of the projector lens with your bare hand.

If the surface of the lens becomes dirty from fingerprints or anything else, this will be magnified and projected onto the screen.

■ LCD Panel

The display unit of this projector comprises three LCD panels. Although an LCD panel is a product of high-precision technology, some of the pixels on the projected image may be missing or constantly lit. Please note that this is not a malfunction.

Displaying a still image for a longer time may result in an after-image on the LCD panels. If this happens, display the all white screen in the Test pattern for an hour or more.

■ Optical components

Operating the projector in an environment with high temperature or heavy exposure to dust or tobacco smoke will reduce the service life of the optical components, such as the LCD panel and polarizing plate, and may necessitate their replacement within less than one year of use. For details, consult your dealer.

■ Lamp

The luminous source of the projector is a mercury lamp with high internal pressure.

A high pressure mercury lamp has following characteristics.

- The brightness of the lamp will decrease by duration of usage.
- The lamp may burst with sound or shorten life by shock or chipping.
- The life of the lamp varies greatly depending on individual specificities and usage conditions. In particular, continuous use over 6 hours and frequent on/off switching of the power greatly deteriorate the lamp and affect the lamp life.
- In rare cases, the lamp burst shortly after the projection.
- The risk of bursting increases when the lamp is used beyond its replacement cycle. Make sure to replace the lamp unit consistently. ("When to replace the lamp unit" (➡ page 88), "Replacing the lamp unit" (➡ page 89))
- If the lamp bursts, gas contained inside of the lamp is released in a form of smoke.
- It is recommended to store replacement lamps for contingency.

■ Computer and external device connections

- When connecting a computer or an external device, read this manual carefully regarding the use of power cords and shielded cables as well.

Accessories

Make sure the following accessories are provided with your projector. Numbers enclosed < > show the number of accessories.

Wireless remote control unit <1>
(H2930094500)

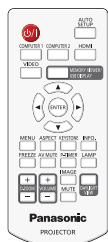

CD-ROM <1>
(H4100603500)

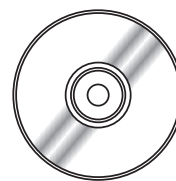

Power cord
(H2100143500)

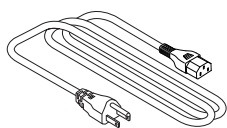

AAA/R03 or AAA/LR03 battery <2>
(for remote control unit)

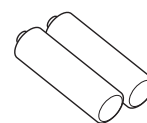

(H2100145500)

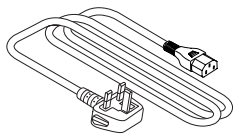

RGB signal cable <1>
(H2100127501)

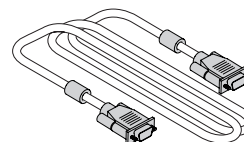

(H2100146500)

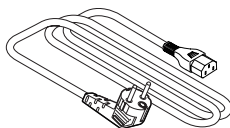

Attention

- After unpacking the projector, discard the power cord cap and packaging material properly.
- Do not use the supplied power cord for devices other than this projector.
- For lost accessories, consult your dealer.
- Store small parts in an appropriate manner, and keep them away from young children.

Note

- The type and number of the power cord depend on the country in which you purchased the product.
- The model numbers of accessories are subject to change without prior notice.

Contents of the supplied CD-ROM

The contents of the supplied CD-ROM are as follow.

Instruction/list (PDF)	Operating Instructions – Functional Manual	
	Operating Instructions – Multi Projector Monitoring & Control Software	
	List of Compatible Projector Models	This is a list of projectors that are compatible with the Multi Projector Monitoring & Control Software and its restrictions.
Software	Multi Projector Monitoring & Control Software (Windows)	This software allows you to monitor and control multiple projectors connected to the LAN.

- The Multi Projector Monitoring & Control Software is only for PT-LW330, PT-LW280, PT-LB360 and PT-LB330.

Optional accessories

Options	Model No.
Ceiling Mount Bracket	ET-PKL100H (for high ceilings) ET-PKL100S (for low ceilings) ET-PKL420B (Projector Mount Bracket)
Replacement Lamp Unit	ET-LAL500
Replacement Filter Unit	ET-RFL300
D-SUB - S Video conversion cable	ET-ADSV

Note

- The model numbers of optional accessories are subject to change without prior notice.

About your projector

Remote control

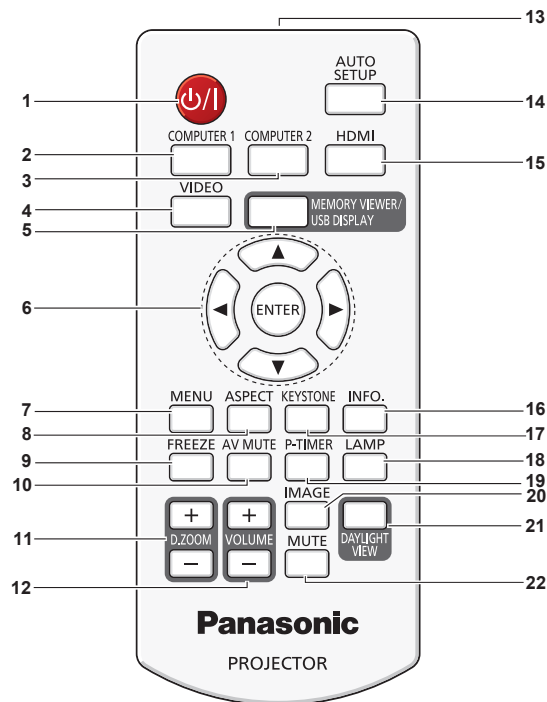

- 1 Power <⏻/⏻> button**
Turns the projector on or off.
- 2 <COMPUTER 1> button**
Switches the Computer 1 or Component signal to project.
- 3 <COMPUTER 2> button**
Switches the Computer 2 signal to project.
- The <COMPUTER 2> button is only for PT-LW330, PT-LW280, PT-LB360 and PT-LB330.
- 4 <VIDEO> button**
Switches the Video signal or S-video signal to project.
- 5 <MEMORY VIEWER/USB DISPLAY> button**
Switches the Memory Viewer signal or the USB Display signal to project.
- The <MEMORY VIEWER/USB DISPLAY> button is only for PT-LW330, PT-LW280, PT-LB360 and PT-LB330.
- 6 <ENTER> button/▲▼◀▶ buttons**
Used to navigate through the menu screen.
- 7 <MENU> button**
Open or close the On-Screen Menu. (➔ page 44)
- 8 <ASPECT> button**
Switches the aspect ratio of the image.
- 9 <FREEZE> button**
Pauses the projected image and mute the audio temporarily. (➔ page 40)
- 10 <AV MUTE> button**
Used to turn off the audio and video temporarily. (➔ page 40)
- 11 <D.ZOOM +/-> buttons**
Zoom in and out the images. (➔ page 41)
- 12 <VOLUME +/-> buttons**
Adjusts the volume of the built-in speaker or audio output. (➔ page 41)
- 13 Remote control signal emitter**
- 14 <AUTO SETUP> button**
Executes Input search, Auto PC adj. and Auto Keystone correction at the same time. (➔ page 38)
- 15 <HDMI> button**
Switches the HDMI signal to project.
- 16 <INFO.> button**
Displays the [Info.] menu. (➔ page 73)
- 17 <KEYSTONE> button**
Displays the [Keystone] menu. (➔ page 39)
- 18 <LAMP> button**
Switches the settings of [Lamp control]. (➔ pages 40, 56)
- 19 <P-TIMER> button**
Operate the P-timer function. (➔ page 40)
- 20 <IMAGE> button**
Switches the image mode. (➔ pages 41, 52)
- 21 <DAYLIGHT VIEW> button**
Used to correct the image when the projector is used in a bright surroundings. (➔ pages 42, 54)
- 22 <MUTE> button**
Used when temporarily turning off the audio. (➔ page 42)

Attention

- Do not drop the remote control.
- Avoid contact with liquids.
- Do not attempt to modify or disassemble the remote control.
- Please observe the following contents that are described on the back of the remote control unit (see the right picture).
 1. Do not use a new battery together with an old battery.
 2. Do not use unspecified batteries.
 3. Make sure the polarities (+ and -) are correct when inserting the batteries.
- In addition, please read the contents that are related to batteries in the "Read this first!".

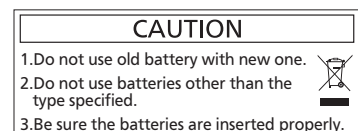

Note

- The remote control can be used within a distance of about 5 m (16'4-13/16") if pointed directly at the remote control signal receiver. The remote control can control at angles of up to $\pm 30^\circ$ vertically and $\pm 30^\circ$ horizontally, but the effective control range may be reduced.
- If there are any obstacles between the remote control and the remote control signal receiver, the remote control may not operate correctly.
- You can operate the projector by reflecting the remote control signal on the screen. The operating range may differ due to the loss of light caused by the properties of the screen.
- When the remote control signal receiver is lit with a fluorescent light or other strong light source, the projector may become inoperative. Set the projector as far from the luminous source as possible.

Projector body

■ **Top**

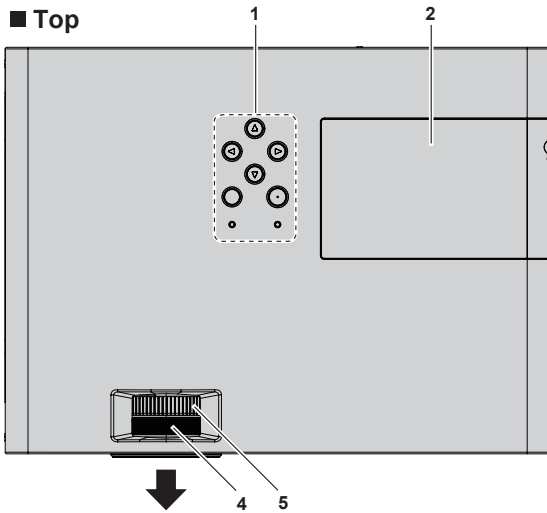

■ **Bottom**

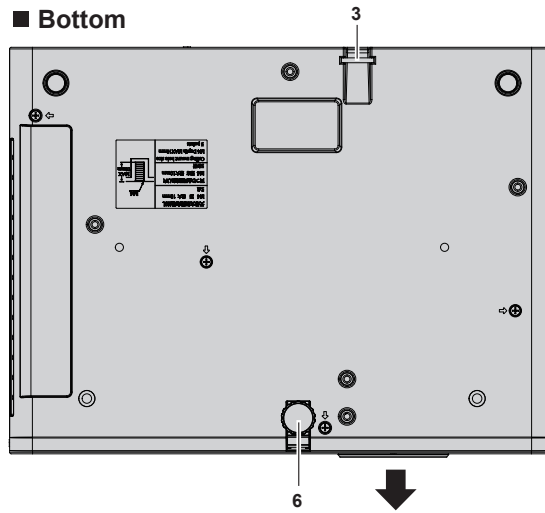

■ **Side**

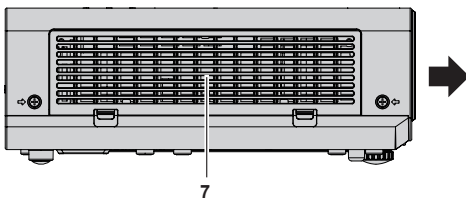

■ **Front**

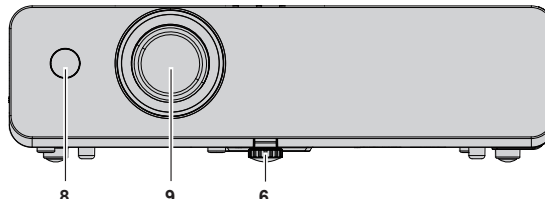

■ **Side**

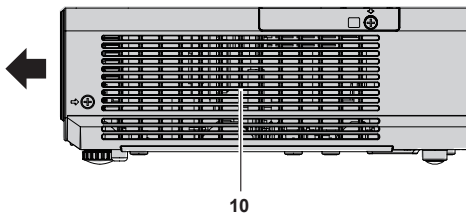

■ **Rear**

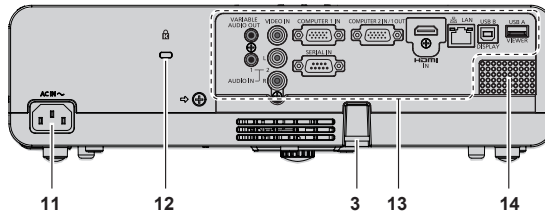

← : Projection direction

WARNING

Keep your hands and other objects away from the air exhaust port.

- Keep your hand and face away.
- Do not insert your finger.
- Keep heat-sensitive articles away.

Heated air from the air exhaust port can cause burns or external damage.

1 Control Panel and Indicators (⇒ page 21)

2 Lamp cover (⇒ page 89)
The lamp unit is located inside.

3 Security Chain Hook
Attaches a burglar prevention cable, etc.

4 Focus ring (Front)
Adjust the focus.

5 Zoom ring (Back)
Adjust the zoom.

6 Adjustable foot
Adjust the projection angle.

7 Air intake port / Air filter cover (⇒ page 86)
The air filter unit is inside.

8 Remote control signal receiver

9 Projection Lens

10 Air exhaust port

11 <AC IN> terminal

Connect the supplied power cord.

12 Security slot

This security slot is compatible with the Kensington security cables.

13 Rear terminals

14 Speaker

Attention

- Do not block the ventilation ports (intake and exhaust) of the projector.

Control panel and Indicators

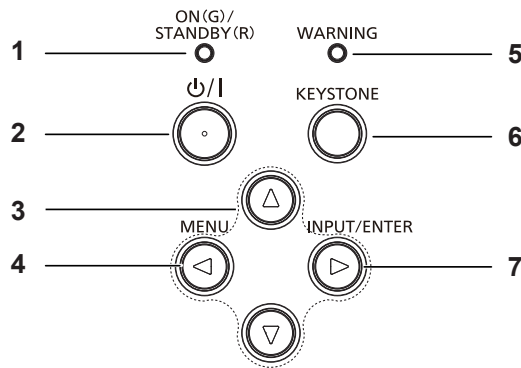

1 Power indicator <ON(G)/STANDBY(R)>

Displays the status of the power.

2 Power ⏻/I button

Turns the projector on/off.

3 ▲▼◀▶ buttons

Used to select the menu items in the menu operation.

4 <MENU> / ◀ button

Displays the menu screen.

5 Warning indicator <WARNING>

Indicates the abnormal conditions of the projector.

6 <KEYSTONE> button

Used to correct the keystone. (➡ page 39)

7 <INPUT/ENTER> / ▶ button

Displays the input source menu. (➡ pages 37, 48)

Used to execute <ENTER> button when the menu screen appears.

Note

- The <INPUT/ENTER> button on the control panel is functioned as the <ENTER> button when the menu screen is displayed. The operating procedure of menu screen is described as "Press the <ENTER> button" in this manual in order to unify the control panel operation with the remote control operation.

Rear terminals

■ Only for PT-LB360, PT-LB330, PT-LW330 and PT-LW280

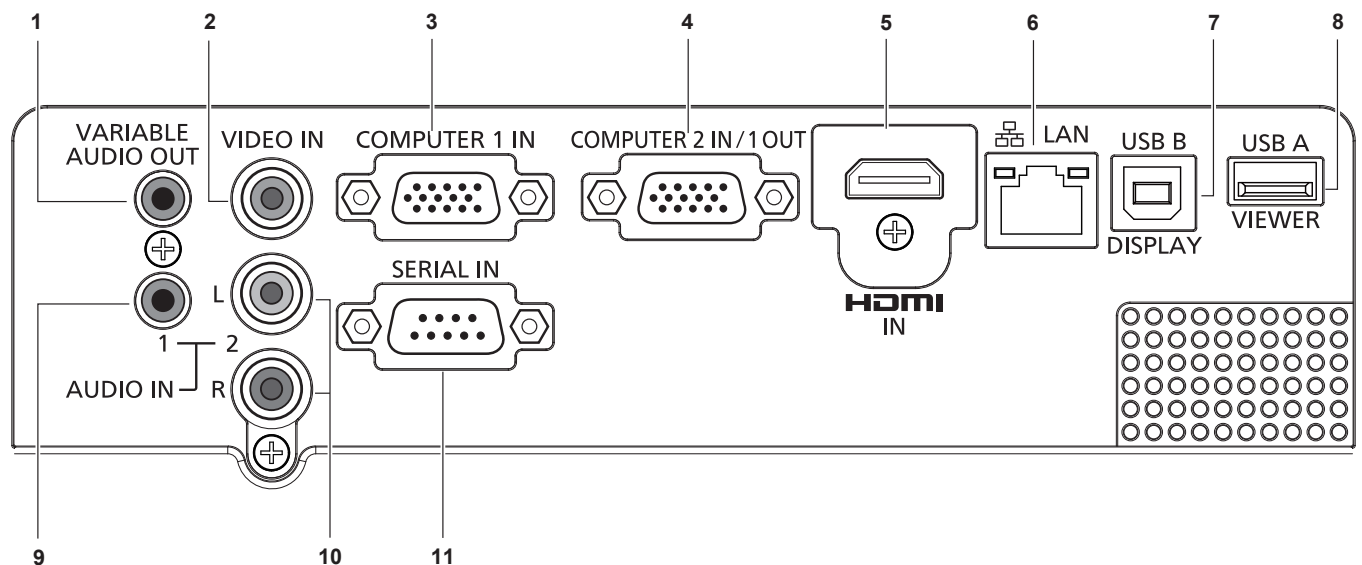

1 <VARIABLE AUDIO OUT> terminal

This is the terminal to output audio signal input to the projector.

2 <VIDEO IN> terminal

This is the terminal to input video signals.

3 <COMPUTER 1 IN> terminal

This is the terminal to input RGB, YP_BP_R/YC_BC_R or S-video signals.

4 <COMPUTER 2 IN/ 1 OUT> terminal

This is the terminal to input RGB signals or output the RGB signals to external monitor.

5 <HDMI IN> terminal

This is the terminal to input HDMI signals.

6 <LAN> terminal

This is the LAN terminal to connect to the network.

7 <USB B (DISPLAY)> terminal

This terminal is used to connect the projector to the computer with a USB cable when you want to use the USB Display function.

8 <USB A (VIEWER)> terminal

When using the Memory Viewer function, insert the USB memory directly to this terminal.

9 <AUDIO IN 1> terminal

This is the terminal to input computer audio signals. In addition, if you have set [HDMI setup] → [Sound] to [Computer], it outputs the analog audio of the input signal which is input to <AUDIO IN 1> terminal when the HDMI input source is selected.

10 <AUDIO IN 2 (L/R)> terminal

This is the terminal to input Video, S-video and YC_BC_R/YP_BP_R audio signals. There are a left (L) terminal and a right (R) terminal.

11 <SERIAL IN> terminal

This is the RS-232C compatible terminal to externally control the projector by connecting a computer.

Attention

- When a LAN cable is directly connected to the projector, the network connection must be made indoors.

■ Only for PT-LB300 and PT-LB280

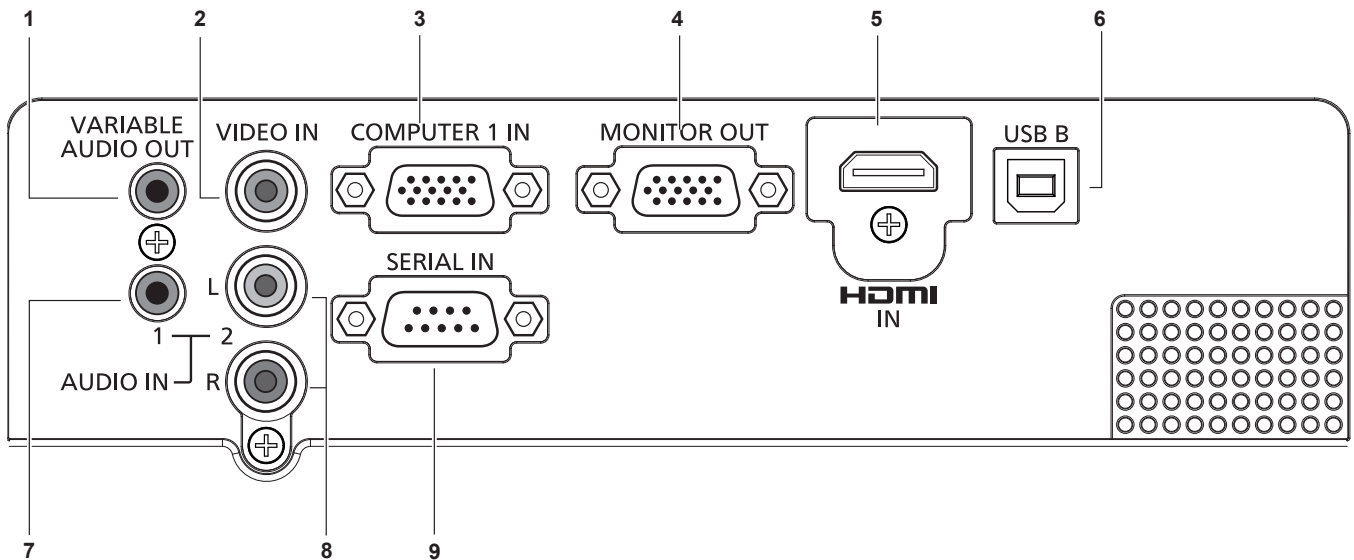

1 <VARIABLE AUDIO OUT> terminal

This is the terminal to output audio signal input to the projector.

2 <VIDEO IN> terminal

This is the terminal to input video signals.

3 <COMPUTER 1 IN> terminal

This is the terminal to input RGB, YP_BP_R/YC_BC_R or S-video signals.

4 <MONITOR OUT> terminal

This is the terminal to output the RGB signals to external monitor.

5 <HDMI IN> terminal

This is the terminal to input HDMI signals.

6 <USB B> terminal

For service use.

7 <AUDIO IN 1> terminal

This is the terminal to input computer audio signals. In addition, if you have set [HDMI setup] → [Sound] to [Computer], it outputs the analog audio of the input signal which is input to <AUDIO IN 1> terminal when the HDMI input source is selected.

8 <AUDIO IN 2 (L/R)> terminal

This is the terminal to input Video, S-video and YC_BC_R/YP_BP_R audio signals. There are a left (L) terminal and a right (R) terminal.

9 <SERIAL IN> terminal

This is the RS-232C compatible terminal to externally control the projector by connecting a computer.

Using the remote control

Inserting and Removing batteries

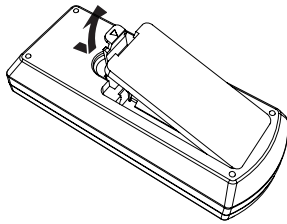

Fig. 1

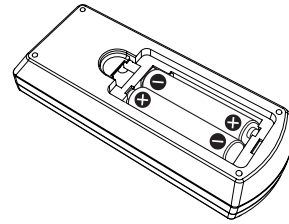

Fig. 2

- 1) **Open the cover. (Fig. 1)**
- 2) **Insert batteries and close the cover (Insert the "⊖" side first.). (Fig. 2)**
 - When removing the batteries, perform the steps in reverse order.

Setting Remote control ID numbers

When you use the system with multiple projectors, you can operate all the projectors simultaneously or each projector individually using single remote control, if unique ID number is assigned to each projector.

After setting the ID number of the projector, set the same ID number to the remote control.

There are 7 different ID codes (All, Code 1~Code 6), the initial ID number is [All].

How to set

- 1) **The ID numbers of the projector are set by pressing the <IMAGE> button one time to six times while holding down the <MENU> button.**
 - The number of times you press the <IMAGE> button corresponds to the desired ID code number. The number of times to press the <IMAGE> button is as follows:
Code 1= Once, Code 2= Twice, Code 3= 3 times, Code 4= 4 times, Code 5= 5 times, Code 6= 6 times.
 - The ID code is changed when the <MENU> button is released.

Attention

- The ID number set on the remote control will be stored unless it is set again. However, it will be returned to [All] if the batteries are run down or removed for a certain period of time.

Note

- Set the ID number of the projector from the [Expand] menu → [Remote control]. (➔ page 70)
- The ID code is reset to [All] (default) by pressing the <MENU> button and <IMAGE> button at the same time for 5 seconds or more.
- If the <IMAGE> button is pressed 7 times or more, the operation is invalid, the ID code cannot be changed.

Chapter 2 Getting Started

This chapter describes things you need to do before using the projector such as the setup and connections.

Setting up

Installation mode

There are four ways to set up the projector. Set the [Display] menu → [Project way] (➔ page 51) depending on the installation location.

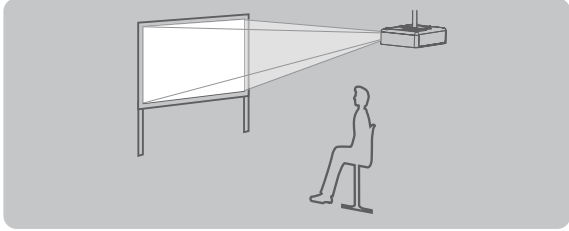
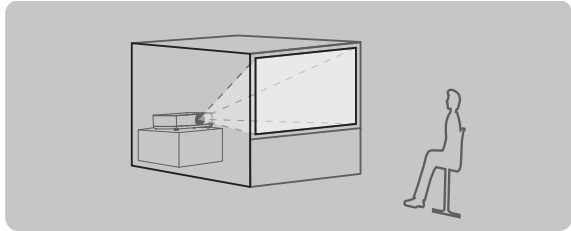
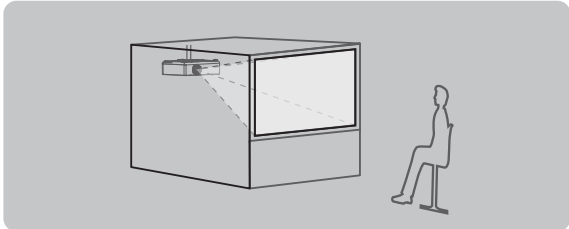
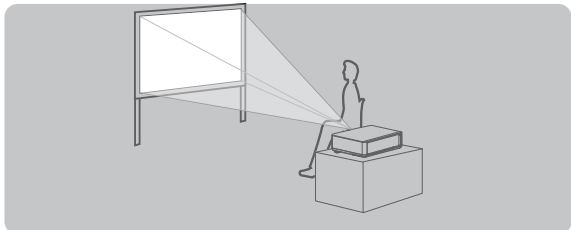
Mounting on the ceiling and projecting forward 		Setting on a desk/floor and projecting from rear (Using the translucent screen) 	
Menu item	Method	Menu item	Method
[Project way]	[Ceiling/Front]	[Project way]	[Rear]
Mounting on the ceiling and projecting from rear (Using the translucent screen) 		Setting on a desk/floor and projecting forward 	
Menu item	Method	Menu item	Method
[Project way]	[Ceiling/Rear]	[Project way]	[Front]

Parts for ceiling mount (Optional)

This requires an optional ceiling mount bracket. Be sure to use the Projector Mount Bracket together with the ceiling mount bracket for high ceilings or low ceilings.

Model No.: ET-PKL100H (for high ceilings), ET-PKL100S (for low ceilings), ET-PKL420B (Projector Mount Bracket)

- Use only the ceiling mount brackets specified for this projector.
- Refer to the Installation Instructions for the ceiling mount bracket when you install the bracket and the projector.

Attention

- To ensure projector performance and security, installation of the ceiling mount bracket must be carried by your dealer or a qualified technician.

Screen size and throw distance

Refer to the screen size and projection distances to install the projector. Image size and image position can be adjusted in accordance with the screen size and screen position.

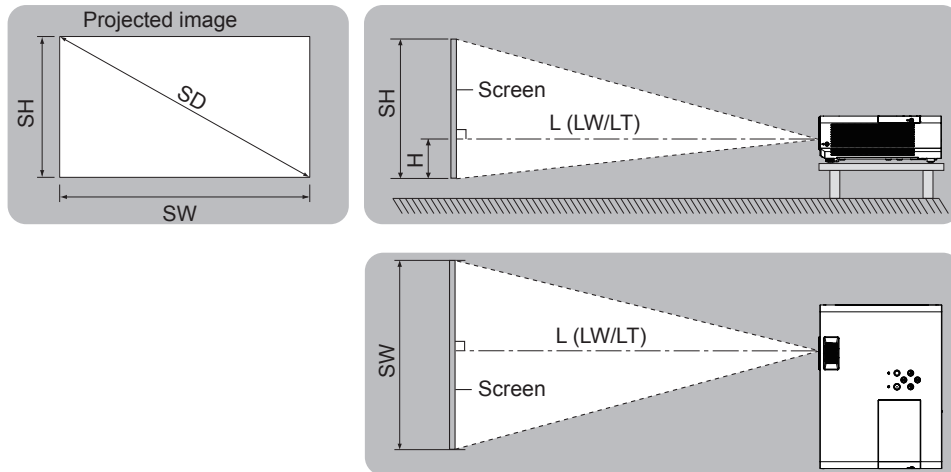

L (LW/LT) *1	Projection distance (m)
SH	Image height (m)
SW	Image width (m)
H	Distance from the center of lens to the image lower end (m)
SD	Projected image size (m)

*1 LW : Minimum distance
LT : Maximum distance

Attention

- Before installing, please read "Precautions for use" (➔ page 14).

Projection distance

For PT-LW330

All measurements below are approximate and may differ slightly from the actual measurements. (Unit: m)

Projection size	4:3 aspect ratio			16:9 aspect ratio			16:10 aspect ratio		
	Screen diagonal (SD)	Minimum distance (LW)	Maximum distance (LT)	Height position (H)	Minimum distance (LW)	Maximum distance (LT)	Height position (H)	Minimum distance (LW)	Maximum distance (LT)
0.76 (30")	1.1	1.3	0.065	1.0	1.2	0.008	0.9	1.1	0.027
1.02 (40")	1.4	1.7	0.087	1.3	1.6	0.011	1.3	1.5	0.036
1.27 (50")	1.8	2.2	0.109	1.6	2.0	0.014	1.6	1.9	0.046
1.52 (60")	2.2	2.6	0.131	2.0	2.4	0.017	1.9	2.3	0.055
1.78 (70")	2.5	3.0	0.152	2.3	2.8	0.019	2.2	2.7	0.063
2.03 (80")	2.9	3.5	0.174	2.6	3.2	0.022	2.6	3.1	0.072
2.29 (90")	3.3	3.9	0.196	3.0	3.6	0.025	2.9	3.5	0.082
2.54 (100")	3.6	4.4	0.218	3.3	4.0	0.028	3.2	3.8	0.091
3.05 (120")	4.4	5.2	0.261	4.0	4.8	0.033	3.8	4.6	0.109
3.81 (150")	5.4	6.6	0.327	4.9	5.9	0.041	4.8	5.8	0.137
5.08 (200")	7.3	8.7	0.435	6.6	7.9	0.054	6.4	7.7	0.181
6.35 (250")	9.1	10.9	0.544	8.3	9.9	0.068	8.0	9.7	0.227
7.62 (300")	10.9	13.1	0.653	9.9	11.9	0.082	9.6	11.6	0.272

Chapter 2 Getting Started - Setting up

For PT-LW280

All measurements below are approximate and may differ slightly from the actual measurements. (Unit: m)

Projection size	4:3 aspect ratio			16:9 aspect ratio			16:10 aspect ratio		
	Screen diagonal (SD)	Minimum distance (LW)	Maximum distance (LT)	Height position (H)	Minimum distance (LW)	Maximum distance (LT)	Height position (H)	Minimum distance (LW)	Maximum distance (LT)
0.76 (30")	1.1	1.3	0.065	1.0	1.2	0.008	0.9	1.1	0.027
1.02 (40")	1.4	1.7	0.087	1.3	1.6	0.011	1.3	1.5	0.036
1.27 (50")	1.8	2.2	0.109	1.6	2.0	0.014	1.6	1.9	0.046
1.52 (60")	2.2	2.6	0.131	2.0	2.4	0.017	1.9	2.3	0.055
1.78 (70")	2.5	3.0	0.152	2.3	2.8	0.019	2.2	2.7	0.063
2.03 (80")	2.9	3.5	0.174	2.6	3.1	0.022	2.5	3.1	0.072
2.29 (90")	3.3	3.9	0.196	3.0	3.5	0.025	2.9	3.4	0.082
2.54 (100")	3.6	4.3	0.218	3.3	3.9	0.028	3.2	3.8	0.091
3.05 (120")	4.3	5.2	0.261	3.9	4.7	0.033	3.8	4.6	0.109
3.81 (150")	5.4	6.5	0.327	4.9	5.9	0.041	4.8	5.8	0.137
5.08 (200")	7.3	8.7	0.435	6.6	7.9	0.054	6.4	7.7	0.181
6.35 (250")	9.1	10.9	0.544	8.2	9.9	0.068	8.0	9.6	0.227
7.62 (300")	10.9	13.1	0.653	9.9	11.9	0.082	9.6	11.6	0.272

For PT-LB360 and PT-LB330

All measurements below are approximate and may differ slightly from the actual measurements. (Unit: m)

Projection size	4:3 aspect ratio			16:9 aspect ratio		
	Screen diagonal (SD)	Minimum distance (LW)	Maximum distance (LT)	Height position (H)	Minimum distance (LW)	Maximum distance (LT)
0.76 (30")	0.9	1.1	0.065	1.0	1.2	0.008
1.02 (40")	1.2	1.4	0.087	1.3	1.6	0.011
1.27 (50")	1.5	1.8	0.109	1.6	2.0	0.014
1.52 (60")	1.8	2.2	0.131	2.0	2.4	0.017
1.78 (70")	2.1	2.5	0.152	2.3	2.8	0.019
2.03 (80")	2.4	2.9	0.174	2.6	3.2	0.022
2.29 (90")	2.7	3.3	0.196	3.0	3.6	0.025
2.54 (100")	3.0	3.6	0.218	3.3	4.0	0.028
3.05 (120")	3.6	4.4	0.261	4.0	4.8	0.033
3.81 (150")	4.5	5.5	0.327	4.9	5.9	0.041
5.08 (200")	6.1	7.3	0.435	6.6	7.9	0.054
6.35 (250")	7.6	9.1	0.544	8.3	9.9	0.068
7.62 (300")	9.1	10.9	0.653	9.9	11.9	0.082

For PT-LB300 and PT-LB280

All measurements below are approximate and may differ slightly from the actual measurements. (Unit: m)

Chapter 2 Getting Started - Setting up

Projection size	4:3 aspect ratio			16:9 aspect ratio		
	Screen diagonal (SD)	Minimum distance (LW)	Maximum distance (LT)	Height position (H)	Minimum distance (LW)	Maximum distance (LT)
0.76 (30")	0.9	1.1	0.065	1.0	1.2	0.008
1.02 (40")	1.2	1.4	0.087	1.3	1.6	0.011
1.27 (50")	1.5	1.8	0.109	1.6	2.0	0.014
1.52 (60")	1.8	2.2	0.131	2.0	2.4	0.017
1.78 (70")	2.1	2.5	0.152	2.3	2.8	0.019
2.03 (80")	2.4	2.9	0.174	2.6	3.1	0.022
2.29 (90")	2.7	3.3	0.196	3.0	3.5	0.025
2.54 (100")	3.0	3.6	0.218	3.3	3.9	0.028
3.05 (120")	3.6	4.3	0.261	3.9	4.7	0.033
3.81 (150")	4.5	5.4	0.327	4.9	5.9	0.041
5.08 (200")	6.0	7.3	0.435	6.6	7.9	0.054
6.35 (250")	7.6	9.1	0.544	8.2	9.9	0.068
7.62 (300")	9.1	10.9	0.653	9.9	11.9	0.082

Projection distance formulas

To use a screen size not listed in this manual, check the screen size SD (m) and use the respective formula to calculate projection distance.

The unit of all the formulae is m. (Values obtained by the following calculation formulae contain a slight error.)

If you want to calculate the projection distance with projected image size SD (unit: inch) by substituting, please assign 0.0254 times to the SD value.

For PT-LW330

	4:3 aspect ratio	16:9 aspect ratio	16:10 aspect ratio
Screen height (SH)	= 0.6 × SD	= 0.490 × SD	= 0.530 × SD
Screen width (SW)	= 0.8 × SD	= 0.872 × SD	= 0.848 × SD
Minimum distance (LW)	= 1.4369 × SD - 0.025	= 1.3045 × SD - 0.025	= 1.2692 × SD - 0.025
Maximum distance (LT)	= 1.7263 × SD - 0.025	= 1.5673 × SD - 0.025	= 1.5249 × SD - 0.025

For PT-LW280

	4:3 aspect ratio	16:9 aspect ratio	16:10 aspect ratio
Screen height (SH)	= 0.6 × SD	= 0.490 × SD	= 0.530 × SD
Screen width (SW)	= 0.8 × SD	= 0.872 × SD	= 0.848 × SD
Minimum distance (LW)	= 1.4332 × SD - 0.02327	= 1.3008 × SD - 0.02327	= 1.2660 × SD - 0.02327
Maximum distance (LT)	= 1.7202 × SD - 0.02367	= 1.5615 × SD - 0.02367	= 1.5195 × SD - 0.02367

For PT-LB360 and PT-LB330

	4:3 aspect ratio	16:9 aspect ratio
Screen height (SH)	= 0.6 × SD	= 0.490 × SD
Screen width (SW)	= 0.8 × SD	= 0.872 × SD
Minimum distance (LW)	= 1.1974 × SD - 0.025	= 1.3045 × SD - 0.025
Maximum distance (LT)	= 1.4386 × SD - 0.025	= 1.5673 × SD - 0.025

For PT-LB300 and PT-LB280

	4:3 aspect ratio	16:9 aspect ratio
Screen height (SH)	= 0.6 × SD	= 0.490 × SD
Screen width (SW)	= 0.8 × SD	= 0.872 × SD
Minimum distance (LW)	= 1.1943 × SD - 0.02327	= 1.3008 × SD - 0.02327
Maximum distance (LT)	= 1.4335 × SD - 0.02367	= 1.5615 × SD - 0.02367

Adjusting adjustable foot

Lift the front of the projector and press the foot lock latch with your finger to adjust the projection angle up and down. Release your finger to lock the adjustable foot.

For slight adjustment, rotate the adjustable foot.

Rotate the adjustable foot to extend it as shown in the figure, and rotate it in the opposite direction to contract it.

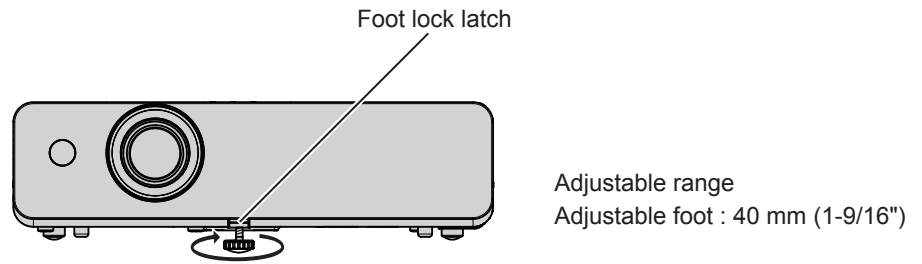

Attention

- Heated air comes out of the air exhaust port while the lamp is lit. Do not touch the air exhaust port directly when you adjust the adjustable foot.
- If keystone distortion occurs on the projected image, perform [Keystone] from the [Expand] menu. (➔ page 61)

Connecting

Before connecting

- Before connecting, carefully read the operating instructions for the external device to be connected.
- Turn off the power switch of the devices before connecting cables.
- Take note of the following points before connecting the cables. Failure to do so may result in malfunctions.
 - When connecting a cable to a device connected to the projector or the projector itself, touch any nearby metallic objects to eliminate static electricity from your body before performing work.
 - Do not use unnecessarily long cables to connect to a device connected to the projector or to the projector body. The longer the cable, the more it is susceptible to noise. Since using a cable while it is wound makes it act like an antenna, it is more susceptible to noise.
 - When connecting cables, connect GND first, then insert the connecting terminal of the connecting device in a straight manner.
- If any connection cable is not supplied with the device, or if no optional cable is available for connection of the device, prepare a necessary system connection cable to suit the device.
- Video signals containing too much jitter may cause the images on the screen to randomly wobble or wafture. In this case, a time base corrector (TBC) must be connected.
- The projector accepts Video signals, S-video signals and $YC_B C_R / YP_B P_R$ signals and analog RGB signals (synchronous signals are TTL level), and digital signal.
- Some computer models are not compatible with the projector.
- When using long cables to connect with each of equipment to the projector, there is a possibility that the image will not be output correctly unless a compensator is used.
- For details on what video signals the projector supports, see "List of compatible signals". (➔ pages 97 - 98)

<COMPUTER 1 IN> terminal pin assignments and signal names

Outside view	Pin No.	Signal names	Pin No.	Signal names
	①	R/P _R /S-C	⑨	+ 5 V
	②	G/Y/S-Y	⑩	GND
	③	B/P _B /-	⑪	GND
	④	—	⑫	DDC data
	⑤	GND	⑬	HD/SYNC
	⑥	GND	⑭	VD
	⑦	GND	⑮	DDC clock
	⑧	GND		

<COMPUTER 2 IN/1 OUT>*1 terminal pin assignments and signal names

Outside view	Pin No.	Signal names	Pin No.	Signal names
	①	R	⑨	+ 5 V *2
	②	G	⑩	GND
	③	B	⑪	—
	④	—	⑫	DDC data *2
	⑤	GND	⑬	HD/SYNC
	⑥	GND	⑭	VD
	⑦	GND	⑮	DDC clock *2
	⑧	GND		

*1 It is <MONITOR OUT> terminal for PT-LB300 and PT-LB280.

*2 No connection for PT-LB300 and PT-LB280.

<HDMI IN> terminal pin assignments and signal names

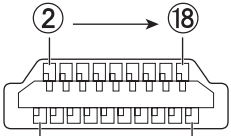
Outside view	Pin No.	Signal names	Pin No.	Signal names
<p>Even-numbered pins ② to ⑱</p>  <p>Odd-numbered pins ① to ⑲</p>	①	T.M.D.S data 2+	⑪	T.M.D.S clock shield
	②	T.M.D.S data 2 shield	⑫	T.M.D.S clock -
	③	T.M.D.S data 2-	⑬	CEC
	④	T.M.D.S data 1+	⑭	—
	⑤	T.M.D.S data 1 shield	⑮	SCL
	⑥	T.M.D.S data 1-	⑯	SDA
	⑦	T.M.D.S data 0+	⑰	DDC/CEC GND
	⑧	T.M.D.S data 0 shield	⑱	+5V
	⑨	T.M.D.S data 0-		Hot plug detection
	⑩	T.M.D.S clock +		

Connecting example : AV equipment

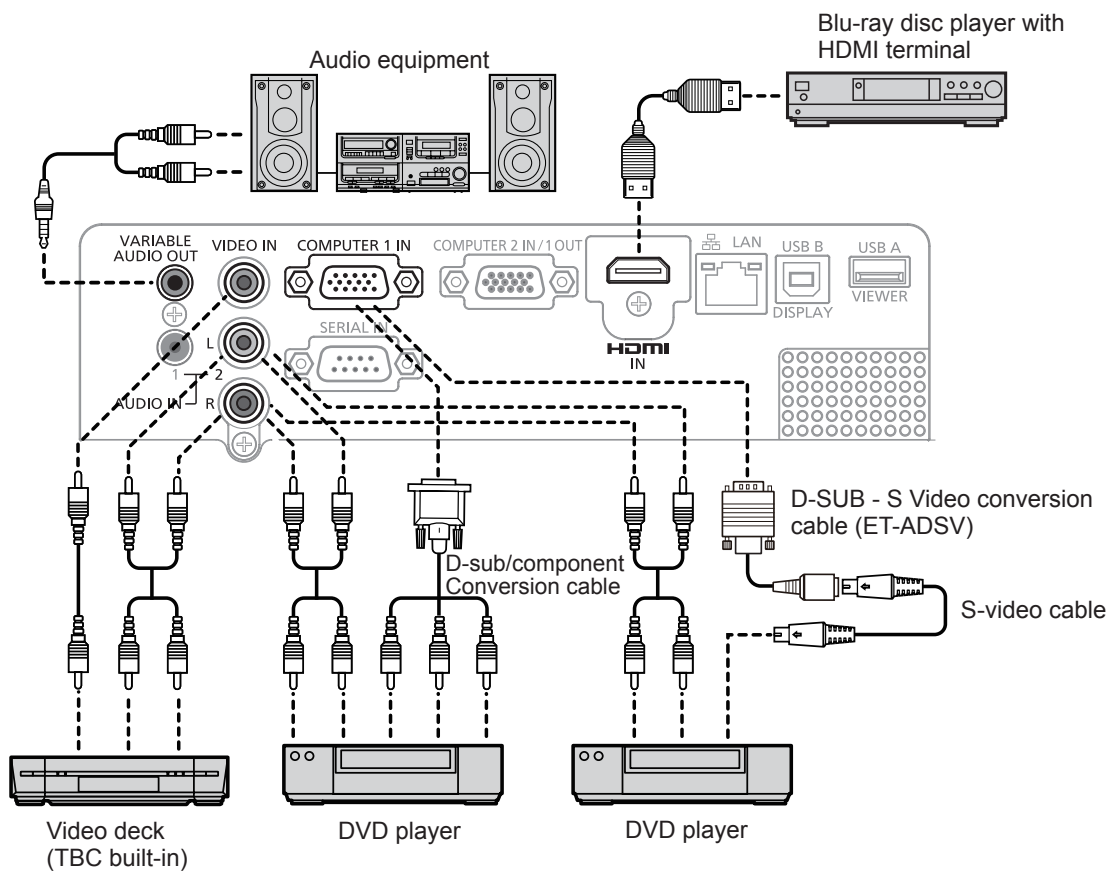

Attention

- Always use one of the following when connecting a VCR.
 - A VCR with built-in time base corrector (TBC).
 - A time base corrector (TBC) between the projector and the VCR.
- If nonstandard burst signals are connected, the image may be distorted. In such case, connect the time base corrector (TBC) between the projector and the external devices.

Note

- For an HDMI cable, use an HDMI High Speed cable that conforms to HDMI standards. If a cable that does not conform to HDMI standards is used, images may be interrupted or may not be displayed.
- This projector does not support the VIERA link (HDMI).
- For the specifications of the RGB signals that can be applied from the PC, refer to “List of compatible signals”. (➡ pages 97 - 98)
- When the <VARIABLE AUDIO OUT> terminal is connected with cable, the sound will not be output from the built-in speaker.
- When input S-video signal, the optional D-SUB - S Video Conversion cable (Model No. ET-ADSV) is required.

Connecting example : Computers

■ For PT-LW330, PT-LW280, PT-LB360 and PT-LB330

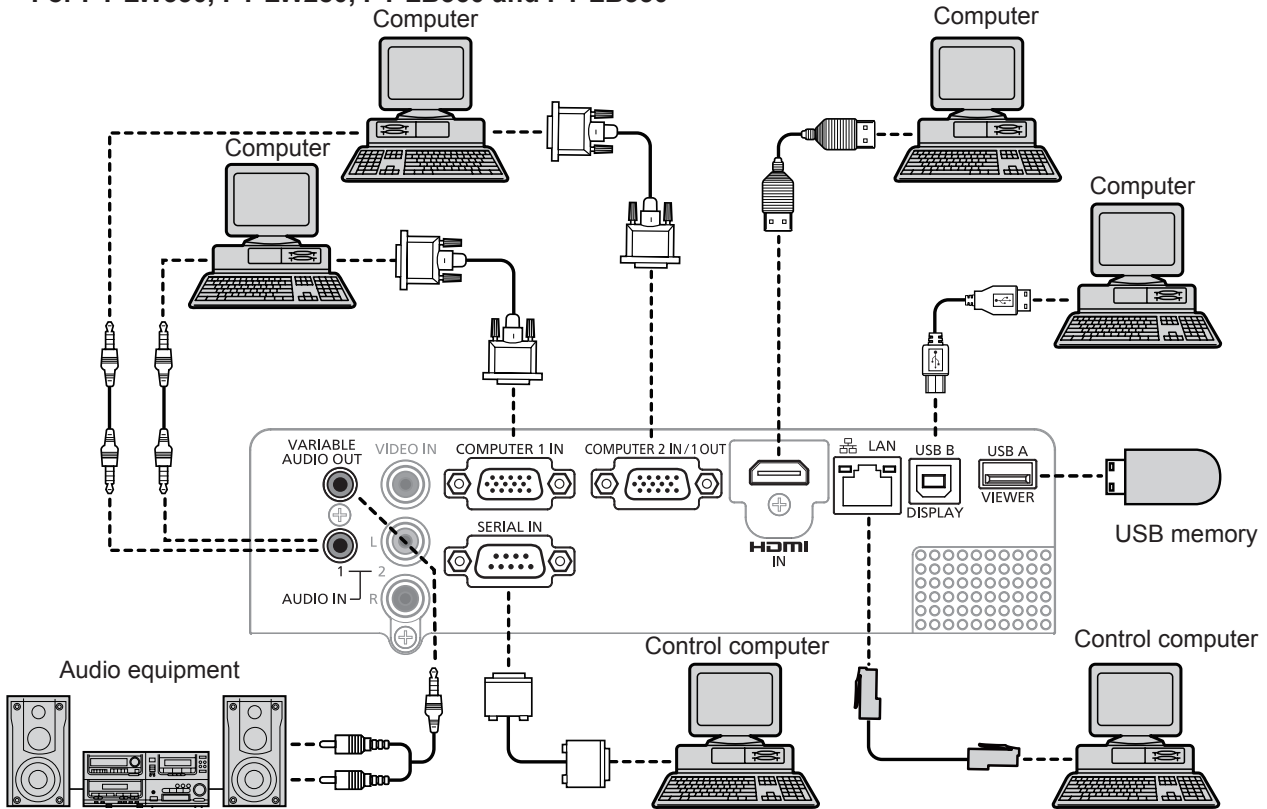

■ For PT-LB300 and PT-LB280

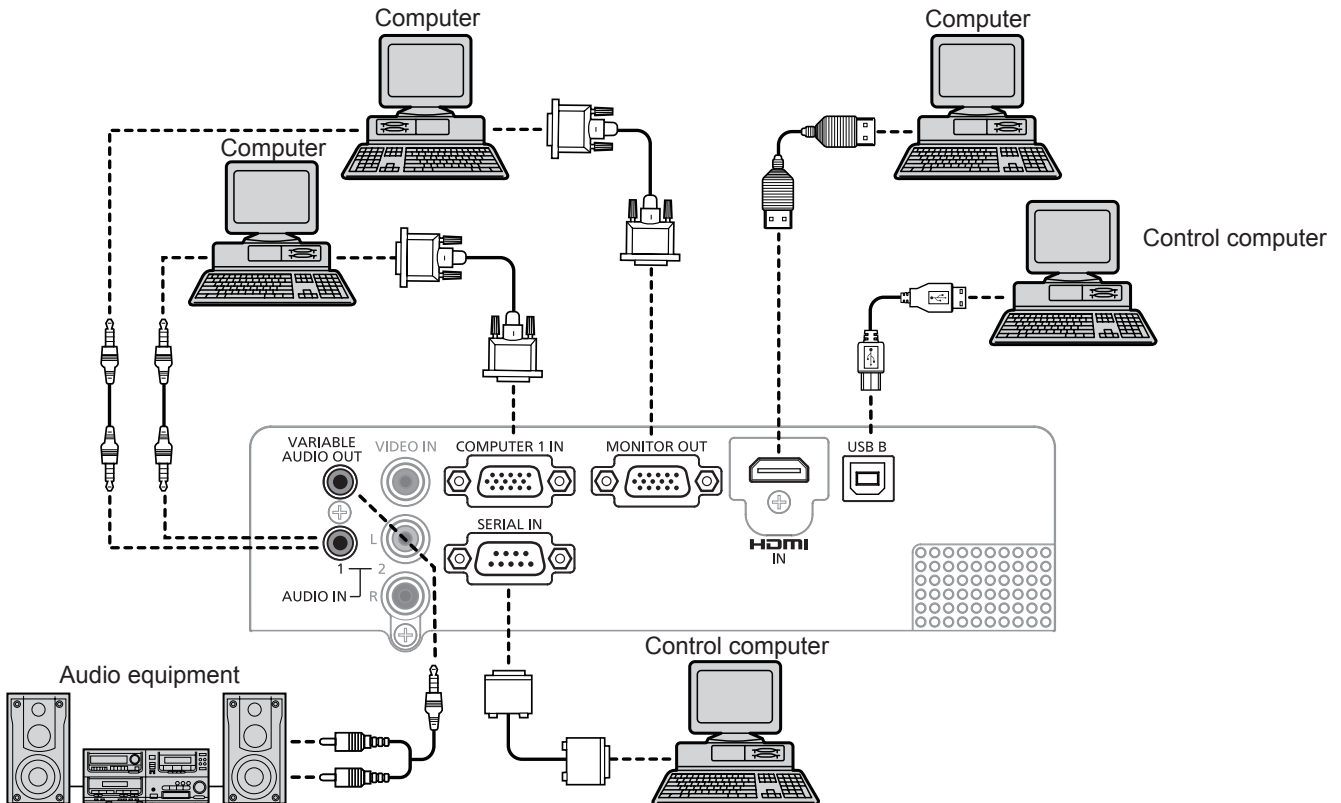

Attention

- When connecting the projector to a computer or an external device, use the power cord supplied with each device and commercially available shielded cables.

Note

- If you operate the projector using the computer with the resume feature (last memory), you may have to reset the resume feature to operate the projector.
- When the <VARIABLE AUDIO OUT> terminal is connected with cable, the sound will not be output from the built-in speaker.

Chapter 3 Basic Operations

This chapter describes basic operations to start with.

Powering on/off

Connecting the power cord

Make sure that the supplied power cord is securely fixed to the projector body to prevent it from being removed easily. For details of power cord handling, refer to "Read this first!" (➔ page 2).

Attaching

- 1) Check the shapes of the <AC IN> terminal on the back of the projector body and the power cord connector and insert the plug completely in the correct direction.

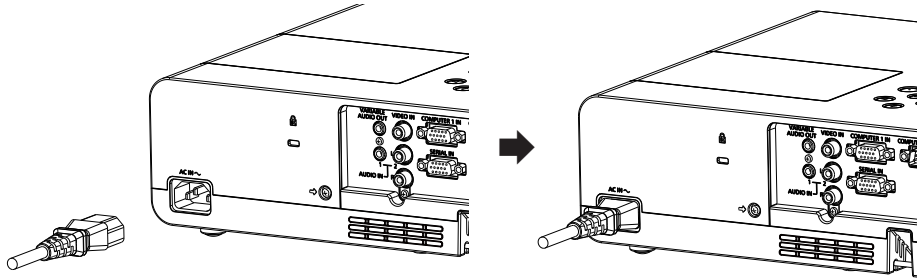

Removing

- 1) Confirm that the projector is in standby mode, and remove the power plug from the outlet.
- 2) Remove the power cord connector from the <AC IN> terminal.

Power indicator

The power indicator <ON(G)/STANDBY(R)> informs you the status of the power. Confirm the status of the power indicator <ON(G)/STANDBY(R)> before operating the projector.

Power indicator <ON(G)/STANDBY(R)>

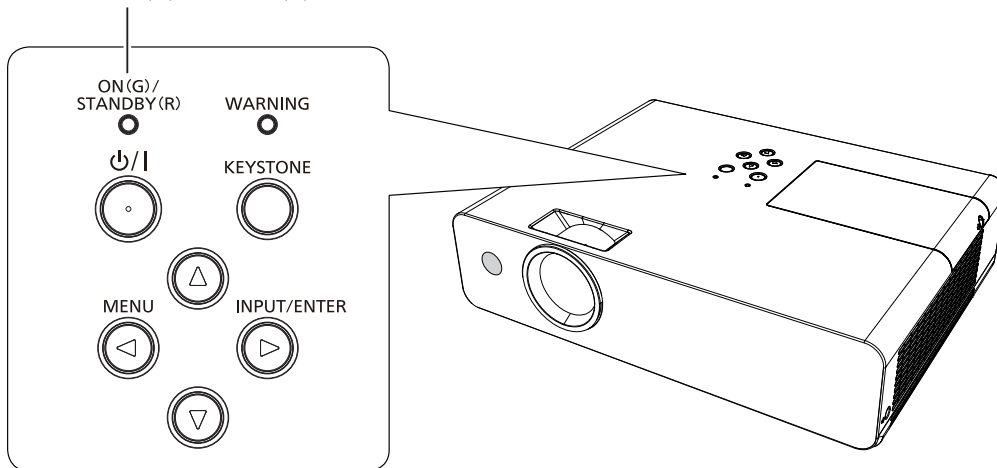

Indicator status		Status
No illumination		The projector is turned off. (The power cord is unplugged.)
Red	Lighting	The power cord is plugged.
		The projector is in standby mode after the cooling is completed.
	Blinking	The projector is in warming up after turning on the power. The projector is in projected state after a while.
		The projector is cooling down. The power is switched off after a while. (Changes to the standby mode.)
Green	Lighting	Projecting.
	Blinking	The projector is in ready mode with Power management function.
Orange	Lighting	The abnormal inside is detected. (Warning)
	Blinking	The temperature inside the projector is abnormally high. (Warning)

Powering On the Projector

Before switching on the projector, make sure all the other devices are correctly connected. (➔ pages 30 - 32)

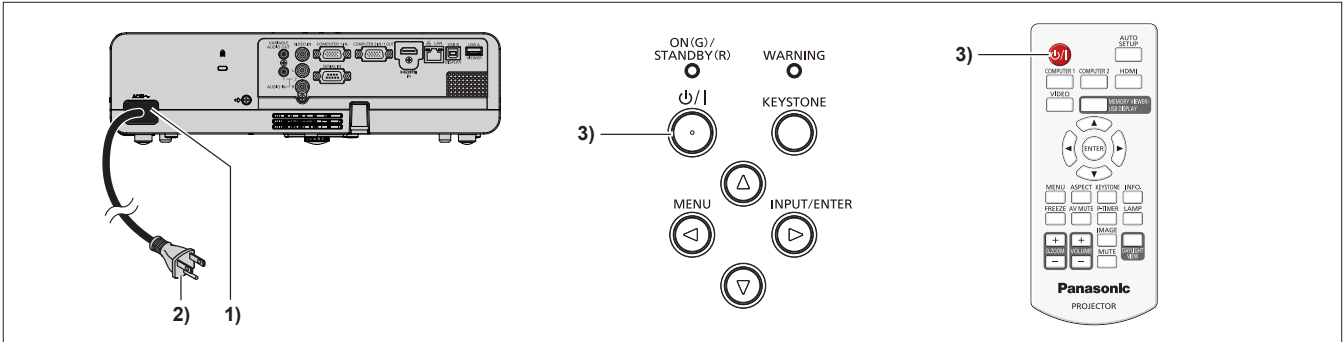

1) Connect the power cord to the projector body.

2) Connect the power plug to an outlet.

- The power indicator <ON(G)/STANDBY(R)> lights in red, and the projector will enter the standby mode.

3) Press the power <⏻/|> button on the control panel or on the remote control.

- The power indicator <ON(G)/STANDBY(R)> blinks in green, after a while the indicator lights in green.
- The startup display appears on the screen and the count down starts, and the image will be projected on the screen after the countdown.

Note

- During count down, all the buttons are not available except for the power <⏻/|> button.

A PIN code input screen appears

If the [PIN code] of the projector has been set, the PIN code input screen will be displayed after the completion of the startup display. Please enter a PIN code as the following steps.

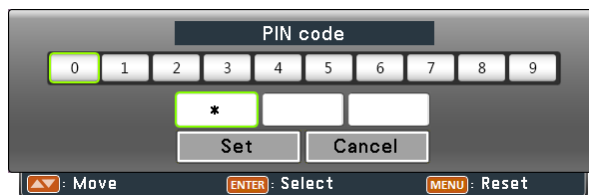

1) Press the <ENTER> button.

2) Press ▲▼ to select the number from 0 to 9.

3) Press the <ENTER> button.

- The fixed number changes to *, and the cursor moves to the next frame.

4) Repeat the above steps to enter a three-digit number.

- Move the cursor to [Set] when fixed a three-digit number.

5) Press the <ENTER> button.

- The image will be projected on the screen.

Note

- When [PIN code lock] is set to [On] in [Security] menu, the PIN code input screen will be displayed after startup display. The projector will turn off automatically when input an incorrect PIN code or without any operation within 3 minutes.
- If you want to correct the digit, press the <MENU> button to reset the digit and then re-enter it.
- Press the <ENTER> button after moving the cursor to [Cancel] to reset the all digits.
- If you entered an incorrect digit, the digit (*) will turn red and reset, and then re-enter a digit.
- The initial PIN code is "111".

Making adjustments and selections

It is recommended that images are projected continuously for at least 30 minutes before the focus is adjusted.

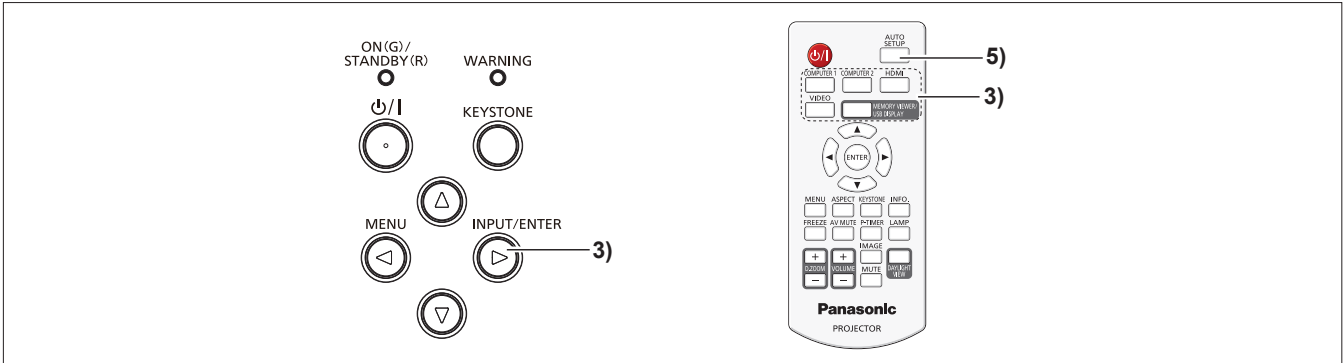

- 1) Adjust the focus of the image roughly. (➔ page 37)
- 2) Change the settings of the [Display] menu → [Project way] depending on the installation mode. (➔ page 51)
 - Refer to “Navigating through the menu” (➔ page 44) for the operation of the menu screen.
- 3) Press the <INPUT/ENTER> button on the control panel or the input selection (<COMPUTER 1>, <COMPUTER 2>, <HDMI>, <VIDEO>, <MEMORY VIEWER/USB DISPLAY>) buttons on the remote control to select the input signal.
 - The <MEMORY VIEWER/USB DISPLAY> button is only for PT-LW330, PT-LW280, PT-LB360 and PT-LB330.
- 4) Adjust the front and back tilt of the projector with the adjustable foot. (➔ page 29)
- 5) Press the <AUTO SETUP> button on the remote control.
- 6) Adjust the size of the image to match the screen with the zoom ring.
- 7) Adjust the focus with the focus ring.

Powering Off the Projector

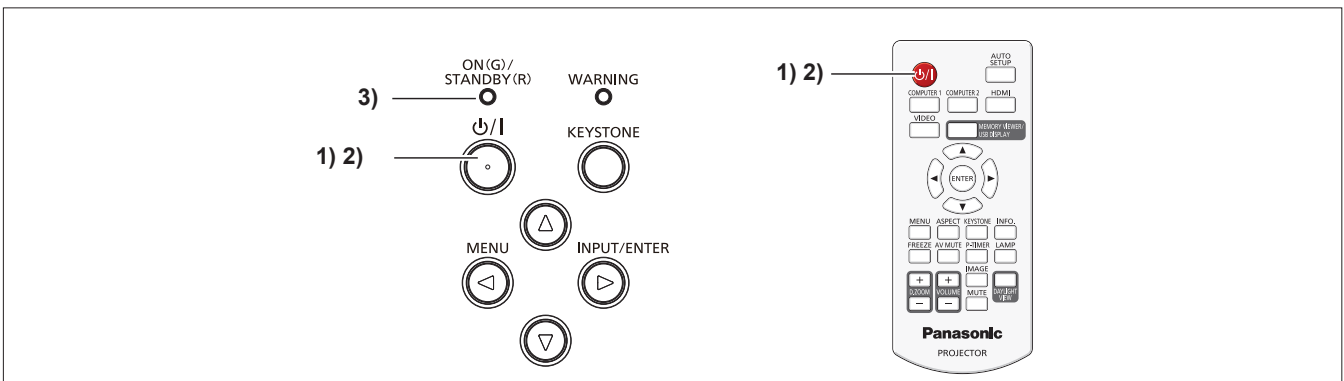

- 1) Press the power <P> button on the control panel or on the remote control.
 - The following message appears.

Power off ?

- 2) Press the power <P> button on the control panel or on the remote control again.
 - Projection of the image will stop, and the power indicator <ON(G)/STANDBY(R)> blinks in red. (The fan keeps running.)
- 3) Wait until the power indicator <ON(G)/STANDBY(R)> lights in red.
 - The projector enters standby mode when the power indicator <ON(G)/STANDBY(R)> lights in red.

Note

- Do not put the projector in a case before the projector is cooled enough.
- While the power indicator <ON(G)/STANDBY(R)> is blinking in red, the lamp is being cooled down and the projector cannot be turned on. Wait until the power indicator <ON(G)/STANDBY(R)> lights in red to turn on the projector again.

Projecting

Check the connections of the peripheral devices (➔ pages 30 - 32) and connection of the power cord (➔ page 34) and switch on the power (➔ page 35) to start the projector. Select the image and adjust the state of the image.

Selecting the input signal

Select an input signal.

- 1) Press the <INPUT/ENTER> button on the control panel or the input selection (<COMPUTER 1>, <COMPUTER 2>, <HDMI>, <VIDEO> or <MEMORY VIEWER/USB DISPLAY>) buttons on the remote control.
 - The <MEMORY VIEWER/USB DISPLAY> button is only for PT-LW330, PT-LW280, PT-LB360 and PT-LB330.
 - The image of the signal being input in the selected terminal is projected.

Attention

- Images may not be projected properly depending on the connected device and DVD, video tape, etc. to be played. Select a system format that is suitable for the input signal in [Display] menu → [System] (➔ page 51).
- Check the aspect ratio of the screen and the image and select the optimum aspect ratio under the [Display] menu → [Aspect] (➔ page 50).

How to adjust the state of the image

If the projected image or the position is not correct when the positioning of the projector and the screen is correctly installed, adjust the focus and zoom.

1) Adjust the projection angle.

- Install the projector on a flat surface and parallel to the screen so that the projected screen is rectangular.
- If the screen is tilted downward, extend the adjustable foot and adjust the projection screen so that the projected screen is rectangular.
- For details, see “Adjusting adjustable foot” (➔ page 29).

2) Adjust the zoom and the focus.

- Rotate the zoom ring to zoom in and out the image.
- Rotate the focus ring to adjust the focus of the projected image.

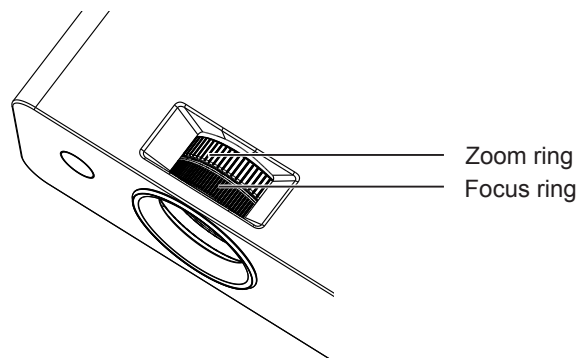

Note

- It is recommended that the images are projected continuously for at least 30 minutes before the focus is adjusted.
- If you adjust the focus, you may need to adjust the size of the image by rotating the zoom ring again.
- If keystone distortion occurs, see the [Expand] menu → [Keystone] (➔ page 61).

Basic operations by using the remote control

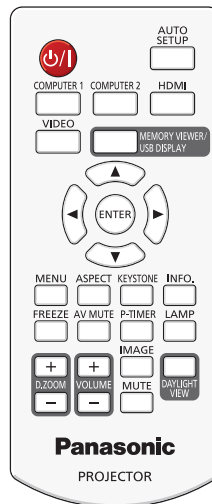

Using the automatic setup function

Input search, Auto PC adjustment (during signal input from a computer) and Auto Keystone correction works at the same time. The Auto PC adjustment function can be used to automatically adjust the resolution, clock phase, and image position when analog RGB signals consisting of bitmap images such as computer signals are being input. Supplying images with bright white borders at the edges and high-contrast black and white characters is recommended when the Auto PC adjustment function is working. Avoid supplying images that include halftones or gradation, such as photographs and computer graphics.



1) Press the <AUTO SETUP> button on the remote control.

Note

- For more details, refer to the [Expand] menu → [Auto setup] (➔ page 59).
- Automatic adjustment may not work depending on the model of the computer and the input signal.
- Images may be disrupted for a few seconds during automatic adjustment, but it is not a malfunction.
- If you press any button on the remote control during the automatic adjustment, the automatic adjustment will be canceled.
- If the automatic setup function is used while moving images are being input, the adjustment may not be performed properly even for an RGB signal that can use automatic setup.

Switching the input signal

You can switch the input signals to project.

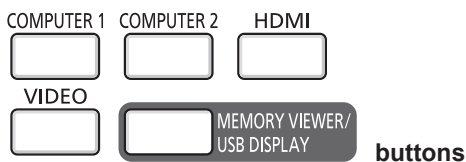

1) Press the <COMPUTER 1>, <COMPUTER 2>, <HDMI>, <VIDEO> or <MEMORY VIEWER/USB DISPLAY> button on the remote control.

- The <COMPUTER 2> button and the <MEMORY VIEWER/USB DISPLAY> button are only for PT-LW330, PT-LW280, PT-LB360 and PT-LB330.
- Press the <INPUT/ENTER> button on the control panel to display the input guide, press ▲▼ to select the input source and then press the <ENTER> button.

<COMPUTER 1>	Switch to Computer 1/Component input.
<COMPUTER 2>*1	Switch to Computer 2 input.
<HDMI >	Switch to HDMI input.
<VIDEO>	Switch to Video/S-video input.
<MEMORY VIEWER/USB DISPLAY>	Switch to Memory Viewer/USB Display input.

*1 When [Terminal] is set to [Monitor out], the operation of the <COMPUTER 2> button is invalid and then the icon  will appear.

Note

- For more details about Memory Viewer function, refer to “Memory Viewer function” (➔ page 79).
- For more details about USB Display function, refer to “USB Display function” (➔ page 81).

Switching the aspect ratio of the image

You can switch aspect ratios according to the input signal.

ASPECT



button

- 1) Press the <ASPECT> button on the remote control.

Note

- For more details, refer to the [Display] menu → [Aspect] (➔ page 50).

Using the keystone distortion and curved correction functions

You can correct the trapezoidal distortion and the curved distortion of the projected image.

KEYSTONE



button

For PT-LW330, PT-LW280, PT-LB360 and PT-LB330

- 1) Press the <KEYSTONE> button on the remote control.

- The selection screen of keystone function is displayed.
- You can also press the <KEYSTONE> button on the control panel.

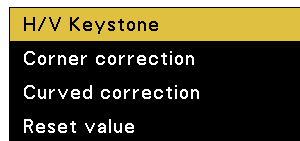

[H/V Keystone]	Select when the trapezoid of the projected image is distorted.
[Corner correction]	Select when the four corners of the projected image are distorted.
[Curved correction]	Select when the linearity is not uniform or the projected image is curved distortion.
[Reset value]	Return the corrected values to the factory default values.

- 2) Press ▲▼ to select [H/V Keystone], [Corner correction], [Curved correction] or [Reset value].

- 3) Press the <ENTER> button.

- The individual adjustment screen of the selected function is displayed.

- 4) Press ▲▼◀▶ to adjust.

For PT-LB300 and PT-LB280

- 1) Press the <KEYSTONE> button on the remote control.

- The [V Keystone] screen is displayed.



- 2) Press ▲▼ to adjust.

- When the [V Keystone] screen is displayed press the <KEYSTONE> button again, the corrected value will be canceled.

Note

- For more details, refer to the [Expand] menu → [Keystone] (➔ page 61).
- Press the <KEYSTONE> button on the control panel or on the remote control when the [H/V Keystone], [Corner correction] or [Curved correction] individual adjustment screen is displaying, the individual adjustment screen will switch as follows.
 - [H/V Keystone] ⇒ [Corner correction] (Upper left) ⇒ [Corner correction] (Upper right) ⇒ [Corner correction] (Lower right) ⇒ [Corner correction] (Lower left) ⇒ [Curved correction X/Y Gain] ⇒ [Curved correction X Offset] ⇒ [Curved correction Y Offset] ⇒ [H/V Keystone] ⇒ ...

Using the information function

This function allows you to display the status of the projector.

INFO.
 button

1) Press the <INFO.> button on the remote control.

- The [Info.] screen is displayed.
- When the [Info.] screen is recalled by using <INFO.> button on the remote control, the on-screen menu cannot be operated.

2) Press the <INFO.> button again.

- The [Info.] screen disappears.

Note

- For more details, refer to the [Info.] menu (➡ page 73).

Using the freeze function

You can freeze the projected image and stop the sound temporarily, regardless of the playing condition of the external device.

FREEZE
 button

1) Press the <FREEZE> button on the remote control.

- The video is paused and the audio is muted. The icon  is displayed on the screen during Freeze.

2) Press the <FREEZE> button again.

- The video playback resumes and the audio is unmuted.

Note

- When no signal input, the key operation is invalid and the icon  will appear.

Using the AV mute function

If the projector is not used for a certain period of time during the meeting intermission, for example, it is possible to turn off the audio and image temporarily.

AV MUTE
 button

1) Press the <AV MUTE> button on the remote control.

- The audio and image turn off.

2) Press the <AV MUTE> button again.

- The audio and image turn on.

Using the presentation timer function

You can operate the P-timer function.

Presentations, etc. can be performed while checking the elapsed time.

P-TIMER
 button

1) Press the <P-TIMER> button on the remote control.

- The count is started.
- The elapsed time is displayed at the bottom right of the projected image.

2) Press the <P-TIMER> button again.

- The count is stopped.

3) Press the <P-TIMER> button again.

- P-timer is finished.

Switching the lamp power

This function allows you to switch the lamp power.

LAMP



button

1) Press the <LAMP> button on the remote control.

- It will switch each time you press the button, [(Normal)] → [(Eco 1)] → [(Eco 2)].

Note

- For details, please refer to the [Setting] menu → [Lamp control] (➔ page 56).

Using the digital zoom function

(Only for still image-based computer (RGB) and still image-based HDMI signals input)

You can enlarge the center area. You can also change the location of the area to be enlarged.



buttons

1) Press the <D.ZOOM +> or <D.ZOOM -> button on the remote control.

- The [D. zoom] individual adjustment screen is displayed.
- Press ▲▼◀▶ on the remote control to move the display position during zoom in.

[D.zoom] individual adjustment screen	Operation	Adjustment	Adjustment range
	Press the <D.ZOOM +> button.	Increases magnification.	0 ~ 33
	Press the <D.ZOOM -> button.	Decreases magnification.	
While the screen is displayed and the image is expanded.	Press the ▲▼ buttons.	Moves the area to the top or the bottom.	-
	Press the ◀▶ buttons.	Moves the area to the left or the right.	

Note

- When the input signals change during [D. zoom], the adjusted value of the digital zoom will be cancelled.
- When no signal input, the key operation is invalid and the icon will appear.
- You can also press ▲▼◀▶ buttons on the control panel to move the display position during zoom in.

Controlling the volume of the speaker

You can adjust the volume of the audio output from the build-in speaker and the <VARIABLE AUDIO OUT> terminal.



buttons

1) Press the <VOLUME +> or <VOLUME -> button on the remote control.

<VOLUME +>	Increases the volume.
<VOLUME ->	Decreases the volume.

Switching the image mode

This function allows you to switch the image mode.

IMAGE



button

1) Press the <IMAGE> button on the remote control.

- It will switch each time you press the button, [Dynamic] → [Standard] → [Cinema] → [Blackboard(Green)] → [Colorboard] → [User image] → [Dynamic] →....

Note

- For details, please refer to the [Color adjust] menu → [Image mode] (➔ page 52).

Using the mute function

This button allows you to turn off the audio output temporarily.

MUTE



button

- 1) **Press the <MUTE> button on the remote control.**
 - The audio turns off.
- 2) **Press the <MUTE> button again.**
 - The audio turns on.

Using the Daylight View Lite function

The Daylight View Lite function improves the vividness of the image even if it is projected under a bright light.



button

- 1) **Press the <DAYLIGHT VIEW> button on the remote control.**
 - The Daylight View Lite function will be switched enable/disable each time you press the button.

Note

- For details, please refer to the [Color adjust] menu → [Daylight View] (➔ page 54).

Chapter 4 **Settings**

This chapter describes the settings and adjustments you can make using the on-screen menu.

Menu Navigation

The on-screen menu (Menu) is used to perform various settings and adjustments of the projector.

Navigating through the menu

Operating procedure



- 1) Press the <MENU> button on the remote control or the control panel.
 - The main menu screen appears.

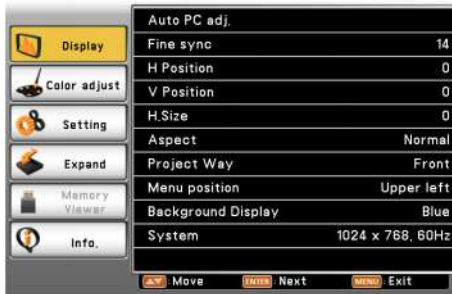

- 2) Press ▲▼ to select an item from the main menu.
 - The selected item is highlighted in orange.



- 3) Press the <ENTER> button.
 - The submenu is displayed, and submenu items become selectable.

(there is no lower menu under the submenu)

(there is lower menu under the submenu)



- Please perform step 4).
- If there is lower menu under the submenu, ... will be displayed. (except for [System] in [Display] menu)
- Please perform step 7).

- 4) Press ▲▼ to select a sub-menu item, press the <ENTER> button.
 - If the selected submenu can be set or adjusted, will be displayed.



5) Press ▲▼ to switch or adjust settings.

- Some items will switch in order as follows each time you press ▲▼.

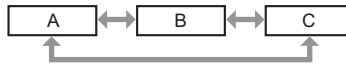

6) Press the <ENTER> button or the <MENU> button.

- The changed settings or the adjusted value is confirmed.

7) Press ▲▼ to select a sub-menu item, press the <ENTER> button.

- Switches to the next layer of the menu screen.

8) Press the <ENTER> button.

- If the selected item can be set or adjusted, ⏏ will be displayed.



9) Press ▲▼ to switch or adjust settings.

- Some items will switch in order as follows each time you press ▲▼.

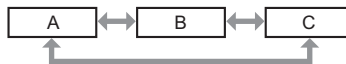

- The selected item will be displayed in a check mark.

10) Press the <ENTER> button or the <MENU> button.

- The changed settings or the adjusted value is confirmed.







Note

- Pressing the <MENU> button while the menu screen is displayed returns to the previous menu or exits the menu screen.
- Some items may not be adjusted or used for certain signal formats to be input to the projector. The menu items that cannot be adjusted or used are shown in gray characters, and they cannot be selected.
- Some items can be adjusted even if signals are not input.
- For menu items, refer to “Main menu” (➔ page 45) and “Sub-menu” (➔ page 46).

Main menu

The following items are in the main menu.

When a main menu item is selected, the screen changes to a submenu selection screen.

Main menu item		Page
	[Display]	49
	[Color adjust]	52
	[Setting]	55
	[Expand]	59
	[Memory Viewer]	71
	[Info.]	73

Sub-menu

The sub-menu screen of the selected main menu appears, and you can set and adjust the various items in the submenu.

[Display]

Sub-menu item	Factory default	Page
[Auto PC adj.]*1	-	49
[Fine sync]*1	-	49
[H Position]*1	-	49
[V Position]*1	-	50
[H.Size]*1	-	50
[Aspect]	[Normal]	50
[Project way]	[Front]	51
[Menu position]	[Upper left]	51
[Background display]	[Blue]	51
[System]	-	51

*1 Only for computer signals.

[Color adjust]



Sub-menu item	Factory default	Page
[Image mode]	[Standard]	52
[Contrast]	[32]	52
[Brightness]	[32]	52
[Color]*1	[32]	53
[Tint]*1	[32]	53
[Color temp.]	[Mid]	53
[Red]	[32]	53
[Green]	[32]	53
[Blue]	[32]	53
[Sharpness]	[8]	54
[Daylight View]	[Off]	54

*1 Only for movie-based signals.

Note

- The factory default settings may vary depending on the image mode.

[Setting]

Sub-menu item	Factory default	Page
[On start]	[Off]	55
[Standby mode]	[Eco]	55
[High land]	[Off]	55
[Lamp control]	[ (Normal)]	56
[Cooling fast]	[Normal]	56
[Closed caption]	[Off]	56
[Key lock]	[ (Off)]	57
[Iris]	[On]	57
[Terminal]*1	[Computer 2]	57
[Sound]	-	57
[HDMI Setup]	-	58

*1 Only for PT-LW330, PT-LW280, PT-LB360 and PT-LB330.

[Expand]

Sub-menu item	Factory default	Page
[Language]	[English]	59

Sub-menu item	Factory default	Page
[Auto setup]	-	59
[Keystone]	[Store]	61
[Logo]	-	64
[Security]	-	66
[Power management]	[Ready]	67
[Filter counter]	-	68
[Test pattern]	[Off]	68
[Network]	-	69
[Remote control]	[All]	70
[Factory default]	-	70

[Memory Viewer]*1



Sub-menu item	Factory default	Page
[Set Slide]	-	71
[Slide Transition Effect]	[Slide Right]	71
[Sort Order]	[Name Order]	71
[Rotate]	[No Rotate]	71
[Best Fit]	[On]	72
[Repeat]	[On]	72
[Apply]	-	72

*1 Only for PT-LW330, PT-LW280, PT-LB360 and PT-LB330.

[Info.]



Details (➔ page 73)

Note

- Some items may not be adjusted or used for certain signal formats to be input to the projector.
The menu items that cannot be adjusted or used are shown in gray characters, and they cannot be selected.
- Sub-menu items and factory default settings differ depending on the selected input terminal.

[Input] menu

To select the input source directly by pressing the input selection buttons on the remote control or to select the input source in the [Input] screen by pressing the <INPUT/ENTER> button on the control panel.

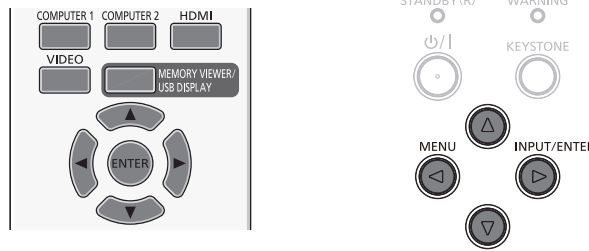

Switching the input source

When using the remote control

- 1) Press the input selection (<COMPUTER 1>, <COMPUTER 2>, <HDMI>, <VIDEO>, <MEMORY VIEWER/USB DISPLAY>) buttons.

- To project the corresponding input signal of the selected terminal.

<COMPUTER 1>	Switches to Computer 1/Component input.
<COMPUTER 2>	Switches to Computer 2 input.
<HDMI>	Switches to HDMI input.
<VIDEO>	Switches to Video/S-video input.
<MEMORY VIEWER/USB DISPLAY>	Switches to Memory viewer/USB Display input.

When using the control panel

- 1) Press the <INPUT/ENTER> button.

- The [Input] screen is displayed.

PT-LW330, PT-LW280,
PT-LB360, PT-LB330

PT-LB300, PT-LB280

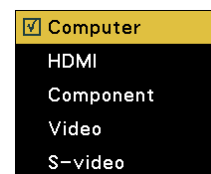
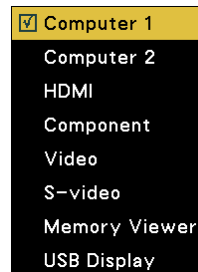

- 2) Switches the input source by pressing ▲▼ to select one item and then press the <ENTER> button.

- To project the corresponding input signal of the selected terminal.

[Computer] ^{*1}	Switches to Computer input.
[Computer 1] ^{*2}	Switches to Computer 1 input.
[Computer 2] ^{*2}	Switches to Computer 2 input.
[HDMI]	Switches to HDMI input.
[Component]	Switches to YP _B P _R /YC _B C _R input.
[Video]	Switches to Video input.
[S-video]	Switches to S-video input.
[Memory Viewer] ^{*2}	Switches to Memory Viewer input.
[USB Display] ^{*2}	Switches to USB Display input.

*1 Only for PT-LB300 and PT-LB280.

*2 Only for PT-LW330, PT-LW280, PT-LB360 and PT-LB330.

Note

- [Computer 2] is not available when [Setting] menu → [Terminal] is set to [Monitor out].

[Display] menu

On the menu screen, select [Display] from the main menu, and select an item from the sub-menu. Refer to "Navigating through the menu" (➔ page 44) for the operation of the menu screen.

- After selecting the item, press ▲▼ to set.

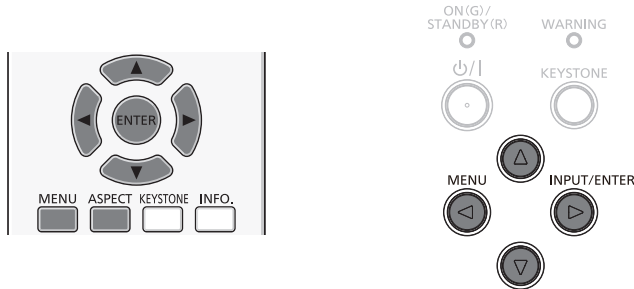

[Auto PC adj.]

(Only for computer signals input)

When input the computer (RGB) signals, the image may be moved up, down, left or right such as flickering, press the <AUTO SETUP> button to adjust [Fine sync], [H position], [V position] and [H.Size] automatically in optimal state. Set the image to get an optimal state to match with the audio-visual surroundings in which the projector is used.

- 1) Press ▲▼ to select [Auto PC adj.].
- 2) Press the <ENTER> button.
 - [Please wait...] screen is displayed, the Auto PC adj. function will be executed.

Note

- The projector executes the Auto PC adj. automatically when the computer signals input the projector for the first time.
- Automatic adjustment may not work depending on the model of the computer and the input signal.
- The [Auto PC adj.] cannot be operated when [480i], [576i], [480p], [576p], [720p], [1080i] or [1080p] is selected in the [Display] menu → [System], or when the signal is coming from the <HDMI IN> terminal.

[Fine sync]

(Only for computer signals input)

You can adjust to achieve an optimal image when there is a flickering image or smeared outlines.

- 1) Press ▲▼ to select [Fine sync].
- 2) Press the <ENTER> button.
- 3) Press ▲▼ to adjust the level.
 - The adjustment values are 0 to +31. Adjust so that the amount of interference is at a minimum.

Note

- Certain signals may not be adjustable.
- Optimal value may not be achieved if the output from the input computer is unstable.
- To project a signal with dot clock frequency with 162 MHz or higher, noise may not disappear even if [Fine sync] is adjusted.
- [Fine sync] cannot be adjusted when a digital signal is input.

[H Position]

(Only for computer signals input)

Move the image position horizontally if the image position projected on the screen is shifted even when the relative position of the projector and the screen is installed correctly.

- 1) Press ▲▼ to select [H Position].
- 2) Press the <ENTER> button.
- 3) Press ▲▼ to adjust the horizontal image position.

Orientation	Operation	Adjustment
Horizontal (left and right) adjustment.	Press the ▲ button.	The image position moves to the right.
	Press the ▼ button.	The image position moves to the left.

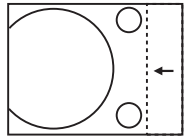
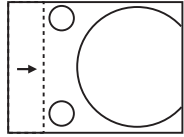

Note

- [H Position] is not available while the image is expanded in the digital zoom function.

[V Position]

(Only for computer signals input)

Move the image position vertically if the image position projected on the screen is shifted even when the relative position of the projector and the screen is installed correctly.

- 1) Press ▲▼ to select [V Position].
- 2) Press the <ENTER> button.
- 3) Press ▲▼ to adjust the vertical image position.

Orientation	Operation	Adjustment
Vertical (up and down) adjustment.	Press the ▲ button.	The image position moves up.
	Press the ▼ button.	The image position moves down.

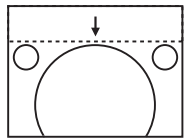
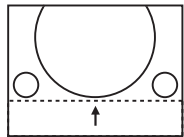

Note

- [V Position] is not available while the image is expanded in the digital zoom function.

[H.Size]

(Only for computer signals input)

Use this function to adjust and minimize the effect of interference caused by projection of patterns consisting of vertical stripes. The projection of the vertical striped pattern may cause cyclic patterns (noise). Adjust so that the amount of interference is at a minimum.

- 1) Press ▲▼ to select [H.Size].
- 2) Press the <ENTER> button.
- 3) Press ▲▼ to adjust the level.
 - The adjustment values are -15 to +15.

Attention

- Set it before adjusting [Fine sync].

[Aspect]

Provide the image to fit the screen size while maintaining the aspect ratio of the input signal.

- 1) Press ▲▼ to select [Aspect].
- 2) Press the <ENTER> button.
- 3) Press ▲▼ to switch the item.
 - The items will switch each time you press the button.

[Normal]	Projects the image at the maximum size while maintaining the aspect ratio of the input signal.
[Wide]	Projects the image at 16:9 aspect ratio.

[Project way]

Set the projection method in accordance with the installation status of the projector.
Change the projection method if the screen display is upside down or inverted.

- 1) Press ▲▼ to select [Project way].
- 2) Press the <ENTER> button.
- 3) Press ▲▼ to switch the item.
 - The items will switch each time you press the button.

[Front]	When installing the projector on the desk, etc. in front of the screen.
[Rear]	When installing the projector on the desk, etc. behind the screen (with a translucent screen).
[Ceiling/Front]	When installing the projector in front of the screen by using the Ceiling Mount Bracket for Projectors (optional).
[Ceiling/Rear]	When installing the projector behind the screen (with a translucent screen) by using the Ceiling Mount Bracket for Projectors (optional).

[Menu position]

Set the position of the menu screen (OSD).

- 1) Press ▲▼ to select [Menu position].
- 2) Press the <ENTER> button.
- 3) Press ▲▼ to change the menu position.
 - The items will switch each time you press the button.
[Upper left] → [Upper right] → [Center] → [Lower left] → [Lower right] → [Upper left] →...

[Background display]

Select the background screen when no input signal is detected.

- 1) Press ▲▼ to select [Background display].
- 2) Press the <ENTER> button.
- 3) Press ▲▼ to switch the item.
 - The items will switch each time you press the button.

[Blue]	Displays the entire projection area in blue.
[Black]	Displays the entire projection area in black.

[System]

Set it to match the resolution of the computer input signals. Set the color system of Video/S-video signals.

- 1) Press ▲▼ to select [System].
- 2) Press the <ENTER> button.
 - The [System] screen is displayed.
- 3) Press ▲▼ to select the desired system.
 - The items will switch each time you press the button.

Input source	Mode	Description
for RGB signal	[1024 x 768, 60Hz], etc	Displays the name of the correspond signal.
	[Auto]	When there is no input signal compatible with the signal from a connected computer on the projector, the Auto PC adj. function works and [Auto] is displayed on the system. If images are not being correctly projected, manually adjust the settings to suit your computer.
for Video/S-video signal	[Auto]	The projector automatically selects the color system of the input signal. Sets [PAL-M] manually.
	[PAL] / [SECAM] / [NTSC] / [NTSC4.43] / [PAL-M] / [PAL-N]	Sets the color system manually when the image is not displayed correctly in [Auto].

- 4) Press the <ENTER> button.

[Color adjust] menu

On the menu screen, select [Color adjust] from the main menu, and select an item from the sub-menu. Refer to “Navigating through the menu” (➔ page 44) for the operation of the menu screen.

- After selecting the item, press ▲▼ to set.

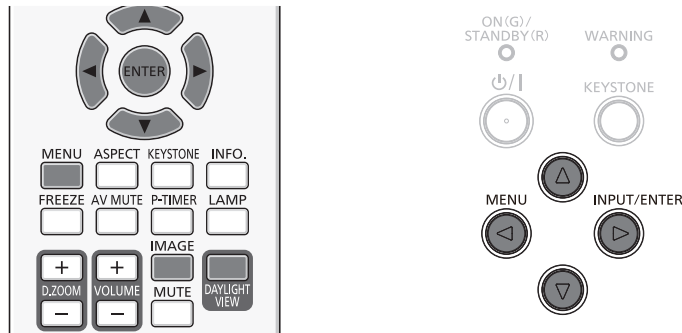

[Image mode]

You can switch to the desired picture mode suitable for the image source and the environment in which the projector is used.

- 1) Press ▲▼ to select [Image mode].
- 2) Press the <ENTER> button.
- 3) Press ▲▼ to switch the item.

- The items will switch each time you press the button.

[Dynamic]	The light output is maximized for use in bright areas.
[Standard]	The picture becomes suitable for moving images in general.
[Cinema]	The picture becomes suitable for movie sources.
[Blackboard (Green)]	The picture becomes suitable for projecting on a black board (green board) such as classroom.
[Colorboard]	The picture becomes suitable for projecting on a color board. To select [Colorboard], press the <ENTER> button, the [Colorboard] screen is displayed. To select [Red], [Blue], [Yellow] or [Green], and press the <ENTER> button.
[User image]	The picture quality is displayed after the manual adjustment of [Color adjust].

- 4) Press the <ENTER> button.

[Contrast]

You can adjust the contrast of the colors.

- 1) Press ▲▼ to select [Contrast].
- 2) Press the <ENTER> button.
- 3) Press ▲▼ to adjust the level.

Operation	Adjustment	Adjustment range
Press the ▲ button.	Brightens the screen and makes the color deeper.	0 ~ +63
Press the ▼ button.	Darkens the screen and makes the color lighter.	

Attention

- Adjust [Brightness] first when you need to adjust [Brightness] and [Contrast].

[Brightness]

You can adjust the dark (black) part of the projected image.

- 1) Press ▲▼ to select [Brightness].
- 2) Press the <ENTER> button.
- 3) Press ▲▼ to adjust the level.

Operation	Adjustment	Adjustment range
Press the ▲ button.	Increases the brightness of the dark (black) parts of the screen.	0 ~ +63
Press the ▼ button.	Reduces the brightness of the dark (black) parts of the screen.	

[Color]

(Except for computer signal input)

You can adjust the color saturation of the projected image.

- 1) Press ▲▼ to select [Color].
- 2) Press the <ENTER> button.
- 3) Press ▲▼ to adjust the level.

Operation	Adjustment	Adjustment range
Press the ▲ button.	Deepens colors.	0 ~ +63
Press the ▼ button.	Weakens colors.	

[Tint]

(Only for HDMI signals/Component signals and NTSC/NTSC4.43 signals when input Video or S-video signals)

You can adjust the skin tone in the projected image.

- 1) Press ▲▼ to select [Tint].
- 2) Press the <ENTER> button.
- 3) Press ▲▼ to adjust the level.

Operation	Adjustment	Adjustment range
Press the ▲ button.	Adjusts skin tone toward greenish color.	0 ~ +63
Press the ▼ button.	Adjusts skin tone toward reddish purple.	

[Color temp.]

You can switch the color temperature if the white areas of the projected image are bluish or reddish.

- 1) Press ▲▼ to select [Color temp.].
- 2) Press the <ENTER> button.
- 3) Press ▲▼ to switch the item.
 - The items will switch each time you press the button.

[High]	Becomes a bluish image at [High]. Becomes a reddish image at [Low]. Selects the suitable natural color.
[Mid]	
[Low]	

Note

- When computer signal input, if the [Display] menu → [System] is set to [PAL], [SECAM], [PAL-M], [PAL-N], [NTSC], [NTSC4.43], [1080i], [1080p], [720p], [576p], [576i], [480p] or [480i], [Color temp.] will be unavailable.

[Red] / [Green] / [Blue]

You can adjust the white balance.

- 1) Press ▲▼ to select [Red] / [Green] / [Blue].
- 2) Press the <ENTER> button.
- 3) Press ▲▼ to adjust the level.

Menu	Operation	Adjustment	Adjustment range
[Red]	Press the ▲ button.	Deepen red tone.	0 ~ +63
	Press the ▼ button.	Lighten red tone.	

[Green]	Press the ▲ button.	Deepen green tone.	0 ~ +63
	Press the ▼ button.	Lighten green tone.	
[Blue]	Press the ▲ button.	Deepen blue tone.	0 ~ +63
	Press the ▼ button.	Lighten blue tone.	

[Sharpness]

You can adjust the sharpness of the projected image.

- 1) Press ▲▼ to select [Sharpness].
- 2) Press the <ENTER> button.
- 3) Press ▲▼ to adjust the level.

Operation	Adjustment	Adjustment range
Press the ▲ button.	Contours become sharper.	0 ~ +15
Press the ▼ button.	Contours become softer.	

[Daylight View]

The Daylight View Lite function improves the vividness of the image even if it is projected under a bright light.

- 1) Press ▲▼ to select [Daylight View].
- 2) Press the <ENTER> button.
- 3) Press ▲▼ to switch the item.
 - The items will switch each time you press the button.
 - You can also press the <DAYLIGHT VIEW> button on the remote control. (➔ page 42)

[On]	Enables Daylight View Lite function.
[Off]	Disables Daylight View Lite function.

[Setting] menu

On the menu screen, select [Setting] from the main menu, and select an item from the sub-menu. Refer to “Navigating through the menu” (➔ page 44) for the operation of the menu screen.

- After selecting the item, press ▲▼ to set.

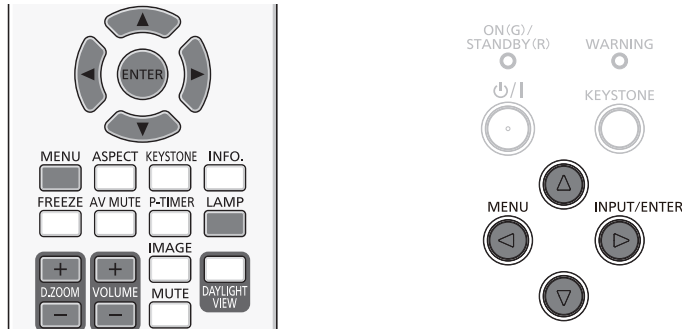

[On start]

Set the method of start up when the power cord plugged into the AC outlet.

- 1) Press ▲▼ to select [On start].
- 2) Press the <ENTER> button.
- 3) Press ▲▼ to switch the item.
 - The items will switch each time you press the button.

[Off]	Starts up in the standby mode.
[On]	Starts the projection immediately.

Note

- When you do not turn off the projector in procedure of “Powering Off the Projector” (➔ page 36), the On start function will not work properly.

[Standby mode]

Set the power consumption during standby. Change the setting whether or not use the network function.

- 1) Press ▲▼ to select [Standby mode].
- 2) Press the <ENTER> button.
- 3) Press ▲▼ to switch the item.
 - The items will switch each time you press the button.

[Eco]	Restricts some functions in the standby mode to reduce power consumption.
[Normal]*1	Does not restrict network function and serial communication function even in the standby mode.

*1 For PT-LB300 and PT-LB280, it cannot restrict the serial communication function even in the standby mode.

Note

- If [Standby mode] is set to [Eco], you cannot use network functions and some RS-232C commands.

[High land]

Change the setting according to the altitude in which you use the projector.

- 1) Press ▲▼ to select [High land].
- 2) Press the <ENTER> button.
- 3) Press ▲▼ to switch the item.
 - The items will switch each time you press the button.

[Off]	When using the projector in the elevation of below 1 400 m (4 593').
[On]	When using the projector in the elevation of above 1 400 m (4 593') and below 2 700 m (8 858').





Note

- It is set to [Off] when using the projector in the elevation of below 1 400 m (4 593'). It is set to [On] when using the projector in the elevation of above 1 400 m (4 593') and below 2 700 m (8 858'). Failure to do so may shorten the life of the internal parts and result in malfunctions.
- Do not set the projector in the elevation of 2 700 m (8 858') or above, otherwise it may shorten the life of the internal parts and result in malfunctions.
- When it is set to [On], the fan noise becomes louder and fan speed increases.

[Lamp control]

Switch the brightness of the lamp according to the operating environment of the projector or the purpose.

- 1) Press ▲▼ to select [Lamp control].
- 2) Press the <ENTER> button.
- 3) Press ▲▼ to switch the item.
 - The items will switch each time you press the button.
 - You can also press the <LAMP> button on the remote control. (➡ page 40)

[ (Normal)]	Select when high luminance is required.
[ (Eco 1)]	Select when high luminance is not required.
[ (Eco 2)]	Select when lower luminance than [ (Eco 1)] is required.

Note

- Set it to [ (Eco 2)] rather than [ (Eco 1)], set it to [ (Eco 1)] rather than [ (Normal)], when you want to reduce power consumption, extend the life of lamp and reduce operation noise.

[Cooling fast]

Switch the cooling fan' speed when the power is turned off and shorten the cooling time of the cooling fan.

- 1) Press ▲▼ to select [Cooling fast].
- 2) Press the <ENTER> button.
- 3) Press ▲▼ to switch the item.
 - The items will switch each time you press the button.

[Normal]	Use this setting normally.
[60 Sec]	Use this setting when short cooling period of time is required.
[0 Sec]	The cooling fans stop immediately after power-off.

Note

- When it is set to [0 sec], you cannot restart the projector immediately after the power-off. The lamp remains high temperature and needs to be cooled, so it sometimes takes longer time than usual for the lamp to light up again.
- When it is set to [60 sec], the cooling fans' speed is faster and the motor noise is louder than [Normal] setting after the power-off.

[Closed caption]

(Only for NTSC input)

Set the closed caption.

- 1) Press ▲▼ to select [Closed caption].
- 2) Press the <ENTER> button.
- 3) Press ▲▼ to switch the item.
 - The items will switch each time you press the button.

[Off]	Closed caption is not displayed.
[CC1]	Displays CC1 data.
[CC2]	Displays CC2 data.
[CC3]	Displays CC3 data.
[CC4]	Displays CC4 data.

Note



- Closed caption is a function that displays text information of video signals mainly used in North America. Captions may not be displayed depending on the connected devices or contents being played back.

- [Closed caption] can only be selected if an NTSC signal is input.
- If [Closed caption] is set to the item except for [Off], the brightness of image may be changed according to the external devices or the used content of the closed caption corresponding connection.
- Closed captions are not displayed when the menu screen is displayed.

[Key lock]

Enable/disable the button operations on the control panel and the remote control.

- 1) Press ▲▼ to select [Key lock].
- 2) Press the <ENTER> button.
- 3) Press ▲▼ to switch the item.
 - The items will switch each time you press the button.

[ (Off)]	Enables the button operations on the control panel or the remote control.
[ (Projector)]	Disables the button operations on the control panel.
[ (Remote control)]	Disables the button operations on the remote control.

[Iris]

Aperture correction and signal compensation are performed automatically based on the image to result in an image of optimum contrast.

- 1) Press ▲▼ to select [Iris].
- 2) Press the <ENTER> button.
- 3) Press ▲▼ to switch the item.
 - The items will switch each time you press the button.

[On]	Corrects the aperture.
[Off]	No aperture correction.

[Terminal]

(Only for PT-LW330, PT-LW280, PT-LB360 and PT-LB330)

The <COMPUTER 2 IN/1 OUT> terminal on the back of the projector is switchable for computer 2 input or monitor output.

- 1) Press ▲▼ to select [Terminal].
- 2) Press the <ENTER> button.
- 3) Press ▲▼ to switch the item.
 - The items will switch each time you press the button.

[Monitor out]	Outputs the RGB signal which have been input <COMPUTER 1 IN> terminal.
[Computer 2]	When input the computer signal.

Note

- The [Terminal] will be unavailable when [Computer 2] is selected as input source.

[Sound]

You can perform more detailed setting for Audio.

Adjusting the volume

- 1) Press ▲▼ to select [Sound].
- 2) Press the <ENTER> button.
 - The [Sound] screen is displayed.
- 3) Press ▲▼ to select [Volume].
- 4) Press the <ENTER> button.
- 5) Press ▲▼ to adjust the level.
 - You can also press the <VOLUME +/-> button on the remote control. (➔ page 41)

Operation	Adjustment	Range
Press the ▲ button.	Turns up the volume.	0 ~ +25
Press the ▼ button.	Turns down the volume.	

Setting the mute

- 1) Press ▲▼ to select [Sound].
- 2) Press the <ENTER> button.
 - The [Sound] screen is displayed.
- 3) Press ▲▼ to select [Mute].
- 4) Press the <ENTER> button.
- 5) Press ▲▼ to switch the item.
 - The items will switch each time you press the button.
 - You can also press the <MUTE> button on the remote control. (➔ page 42)

[On]	Audio is not output.
[Off]	Audio is output.

[HDMI Setup]

Switch the setting when the external equipment is connected to the <HDMI IN> terminal of the projector and the image is not projected correctly. Or switch the setting of the audio input.

[Image]

- 1) Press ▲▼ to select [HDMI Setup].
- 2) Press the <ENTER> button.
 - The [HDMI Setup] screen is displayed.
- 3) Press ▲▼ to select [Image].
- 4) Press the <ENTER> button.
- 5) Press ▲▼ to switch the item.
 - The items will switch each time you press the button.

[64-940]	Select when the HDMI terminal of an external device (such as a blu-ray player) is connected to the <HDMI IN> terminal.
[0-1023]	Select when the DVI-D terminal output of an external device (such as a computer) is connected to the <HDMI IN> terminal via a conversion cable or similar cable. Select also when the HDMI terminal output of a computer or other device is connected to the <HDMI IN> terminal.

Note

- The optimal setting varies depending on the output setting of the connected external device. Refer to the operation instruction of the external device regarding the output of the external device.

[Sound]

- 1) Press ▲▼ to select [HDMI setup].
- 2) Press the <ENTER> button.
 - The [HDMI setup] screen is displayed.
- 3) Press ▲▼ to select [Sound].
- 4) Press the <ENTER> button.
- 5) Press ▲▼ to switch the item.
 - The items will switch each time you press the button.

[HDMI]	Select when the HDMI cable is connected, the image and audio are transmitted, and you do not need to connect the audio signal separately.
[Computer]	Select when the DVI-D terminal output of an external device (such as a computer) is connected to the <HDMI IN> terminal via a conversion cable or similar cable. The image will not be transmitted, the audio signal is input to <AUDIO IN 1> terminal.

[Expand] menu

On the menu screen, select [Expand] from the main menu, and select an item from the sub-menu. Refer to “Navigating through the menu” (➔ page 44) for the operation of the menu screen.

- After selecting the item, press ▲▼◀▶ to set.

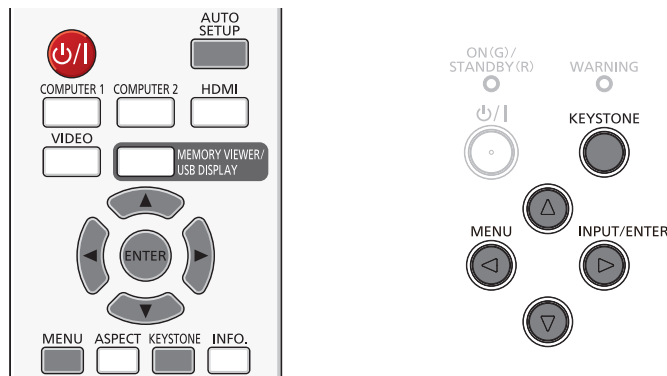

[Language]

You can switch the language of the on-screen display.

- 1) Press ▲▼ to select [Language].
- 2) Press the <ENTER> button.
 - The [Language] screen is displayed. (It is displayed in 23 languages with 3 pages.)
- 3) Press ▲▼ to switch the language.
 - The languages will switch each time you press the button.



- 4) Press the <ENTER> button.
 - Various menus, settings, adjustment screens, control button names, etc., are displayed in the selected language.
 - The language can be changed to English, German, French, Italian, Spanish, Portuguese, Dutch, Swedish, Finnish, Norwegian, Danish, Polish, Hungarian, Czech, Russian, Turkish, Arabic, Kazakh, Vietnamese, Chinese, Korean, Japanese and Thai.

Note

- The on-screen display language of the projector is set to English by default and when [Expand] → [Factory default] is executed (➔ page 70).

[Auto setup]

Press the <AUTO SETUP> button on the remote control to set the automatic operations of the Input search function, Auto PC adj. function and the Auto keystone function.

- 1) Press ▲▼ to select [Auto setup].
- 2) Press the <ENTER> button.
 - The [Auto setup] screen is displayed.
- 3) Press ▲▼ to switch the item.
 - The items will switch each time you press the button.

[Input search]	This function is used to detect the signals and project the automatic input signals automatically.
[Auto PC adj.]	This function is used to adjust [Fine sync], [H position], [V position] and [H.Size] automatically when input the analog computer signal.
[Auto keystone]	This function is used to correct the vertical keystone of the projected image automatically.

[Input search]

This function is used to detect the signals and project the automatic input signals automatically.

- 1) Press ▲▼ to select [Auto setup].
- 2) Press the <ENTER> button.
 - The [Auto setup] screen is displayed.
- 3) Press ▲▼ to select [Input search].
- 4) Press the <ENTER> button.
- 5) Press ▲▼ to switch the item.
 - The items will switch each time you press the button.

[On]	Detects the signals and projects the automatic input signals automatically.
[Off]	Disables the detection of the signals.

[Auto PC adj.]

This function is used to set the automatic execution of Auto PC adj. function.

- 1) Press ▲▼ to select [Auto setup].
- 2) Press the <ENTER> button.
 - The [Auto setup] screen is displayed.
- 3) Press ▲▼ to select [Auto PC adj.].
- 4) Press the <ENTER> button.
- 5) Press ▲▼ to switch the item.
 - The items will switch each time you press the button.

[On]	Enables the automatic execution of Auto PC adj. function.
[Off]	Disables the automatic execution of Auto PC adj. function.

[Auto keystone]

This function is used to set the automatic execution of Auto keystone function.

- 1) Press ▲▼ to select [Auto setup].
- 2) Press the <ENTER> button.
 - The [Auto setup] screen is displayed.
- 3) Press ▲▼ to select [Auto keystone].
- 4) Press the <ENTER> button.
- 5) Press ▲▼ to switch the item.
 - The items will switch each time you press the button.

[Auto]	When detecting the projector is tilted, correct the vertical keystone in real time.
[Manual]	When pressing the <AUTO SETUP> button on the remote control, correct the keystone in vertical.
[Off]	Auto keystone function disabled.

Note

- [Input search], [Auto PC adj.] and [Auto Keystone] cannot be set to [Off] at the same time. At least one of them is set to [On].
- In some times the auto keystone maybe correct image imperfectly, manual keystone is required.
- When [Display] → [Project way] is set to [Ceiling/Front] or [Ceiling/Rear], [Auto PC adj.] will be set to [On] automatically, [Auto keystone] will be set to [Off] automatically and it will be unavailable.

[Keystone]

You can correct the trapezoidal distortion that occurs when the projector is installed tilted or when the screen is tilted.

- 1) Press ▲▼ to select [Keystone].
- 2) Press the <ENTER> button.
 - The [Keystone] screen is displayed.
- 3) Press ▲▼ to select one item.

[Keystone]	Sets whether or not to keep the keystone correction after turn off the projector or plug out the power cord.
[V Keystone] ^{*1}	Adjusts when the vertical trapezoid of the projected image is distorted.
[H/V Keystone]	Adjusts when the horizontal or vertical trapezoid of the projected image is distorted.
[Corner correction]	Adjusts when the four corners of the projected image are distorted.
[Curved correction]	Adjusts when the linearity is not uniform or the vertical and horizontal lines are distorted.
[Reset value]	Return the corrected values to the factory default values.

*1 Only for PT-LB300 and PT-LB280.

[Keystone]

Sets whether or not to keep the keystone correction after turn off the projector or plug out the power cord.

- 1) Press ▲▼ to select [Keystone].
- 2) Press the <ENTER> button.
 - The [Keystone] screen is displayed.
- 3) Press ▲▼ to select [Keystone].
- 4) Press the <ENTER> button.
- 5) Press ▲▼ to switch the item.
 - The items will switch each time you press the button.

[Reset]	When [Standby mode] is set to [Eco], plug out the power cord or turn off the projector, the keystone correction will be canceled. When [Standby mode] is set to [Normal], plug out the power cord, the keystone correction will be canceled; turn off the projector, the keystone correction will be kept.
[Store]	The keystone correction will be kept when plug out the power cord or turn off the projector.

[V Keystone]

(Only for PT-LB300 and PT-LB280)

- 1) Press ▲▼ to select [Keystone].
- 2) Press the <ENTER> button.
 - The [Keystone] screen is displayed.
- 3) Press ▲▼ to select [V Keystone].
- 4) Press the <ENTER> button.
- 5) Press ▲▼ to correct the keystone.

Operation	Adjustment	
Press the ▲ button.	The top becomes smaller.	
Press the ▼ button.	The bottom becomes smaller.	

[H/V Keystone]

(Only for PT-LW330, PT-LW280, PT-LB360 and PT-LB330)

- 1) Press ▲▼ to select [Keystone].

- 2) Press the <ENTER> button.
 - The [Keystone] screen is displayed.
- 3) Press ▲▼ to select [H/V Keystone].
- 4) Press the <ENTER> button.
 - The [H/V Keystone] individual adjustment screen is displayed.
- 5) Press ▲▼◀▶ to adjust the item.

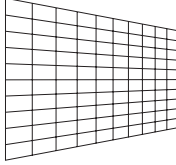
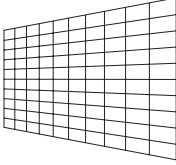
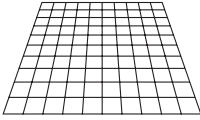
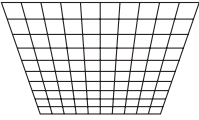
Items	Operation	Adjustment		
Horizontal	Press the ► button.	Adjusts the right of the keystone.		
	Press the ◀ button.	Adjusts the left of the keystone.		
Vertical	Press the ▲ button.	Adjusts the upper of the keystone.		
	Press the ▼ button.	Adjusts the bottom of the keystone.		

Note

- The white arrows indicate that there is no correction.
- A red arrow indicates the direction of correction.
- An arrow disappears at the maximum correction.

[Corner correction]

(Only for PT-LW330, PT-LW280, PT-LB360 and PT-LB330)

- 1) Press ▲▼ to select [Keystone].
- 2) Press the <ENTER> button.
 - The [Keystone] screen is displayed.
- 3) Press ▲▼ to select [Corner correction].
- 4) Press the <ENTER> button.
 - The Corner correction arrows are displayed on the upper left corner of the projected image.
- 5) Press ▲▼◀▶ to adjust.

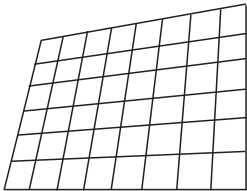
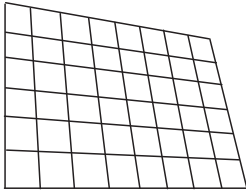
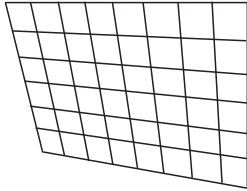
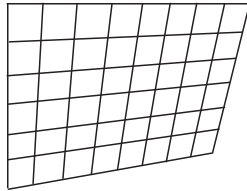
[Corner correction]			
Upper left 	Upper right 	Lower left 	Lower right 

Note





- The white arrows indicate that there is no correction.
- A red arrow indicates the direction of correction.
- An arrow disappears at the maximum correction.

[Curved correction]

(Only for PT-LW330, PT-LW280, PT-LB360 and PT-LB330)

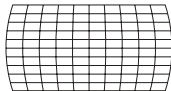
- 1) Press ▲▼ to select [Keystone].

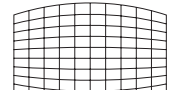
- 2) Press the <ENTER> button.
 - The [Keystone] screen is displayed.
- 3) Press ▲▼ to select [Curved correction].
- 4) Press the <ENTER> button.
 - The [Curved correction] screen is displayed.
- 5) Press ▲▼◀▶ to adjust the item.

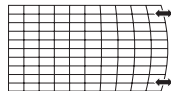
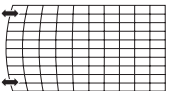
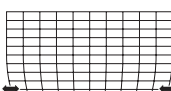
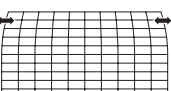
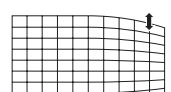
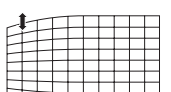
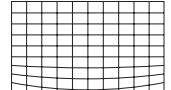
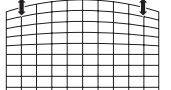
Items	Operation	Adjustment
[Curved correction X/Y Gain]	Press the ▶ button.	Extend the vertical lines to left and right. 
	Press the ◀ button.	Dent the vertical lines to left and right. 
	Press the ▲ button.	Extend the horizontal lines to top and bottom. 
	Press the ▼ button.	Dent the horizontal lines to top and bottom. 
[Curved correction X Offset]	Press the ▶ button.	Used to correct the right side vertical lines. Extend the top and bottom while keeping the center part as it is. 
	Press the ◀ button.	Used to correct the left side vertical lines. Extend the top and bottom while keeping the center part as it is. 
	Press the ▲ button.	Used to correct the both sides of the vertical lines. Extend the lower corners while keeping the center part and the upper part as they are. 
	Press the ▼ button.	Used to correct the both sides of the vertical lines. Extend the top corners while keeping the center part and the lower part as they are. 
[Curved correction Y Offset]	Press the ▶ button.	Used to correct the right side horizontal lines. Extend the top and bottom while keeping the center part as it is. 
	Press the ◀ button.	Used to correct the left side horizontal lines. Extend the top and bottom while keeping the center part as it is. 
	Press the ▲ button.	Used to correct the both sides of the horizontal lines. Extend the lower corners while keeping the center part and the upper part as they are. 
	Press the ▼ button.	Used to correct the both sides of the horizontal lines. Extend the top corners while keeping the center part and the lower part as they are. 

Note

- Either [H/V Keystone] or [Corner correction] setting value is valid. If the other item is adjusted after [H/V Keystone] or [Corner correction] was adjusted, the previous setting value will be reset.
 - The [Curved Correction X Offset] and the [Curved Correction Y Offset] cannot be adjusted independently. After adjusting the [Curved Correction X/Y Gain] at the beginning, please adjust the [Curved Correction X Offset] and the [Curved Correction Y Offset].
 - Press the <KEystone> button on the control panel or on the remote control when the [H/V Keystone], [Corner correction] or [Curved correction] individual adjustment screen is displaying, the individual adjustment screen will switch as follows.
 - [H/V Keystone] ⇒ [Corner correction] (Upper left) ⇒ [Corner correction] (Upper right) ⇒ [Corner correction] (Lower right) ⇒ [Corner correction] (Lower left) ⇒ [Curved correction X/Y Gain] ⇒ [Curved correction X Offset] ⇒ [Curved correction Y Offset] ⇒ [H/V Keystone] ⇒ ...
 - Correcting up to ±30° for the tilt in the vertical direction and ±15°*1 for the tilt in the horizontal direction are available for adjustments with [Keystone]. However, the image quality will degrade and it will get harder to focus with more correction. Install the projector so that the correction will be as small as possible.
- *1 The tilt in horizontal direction is not available for PT-LB300 and PT-LB280.

- Screen size will also change when [H/V Keystone] is used to perform various adjustments.
- Aspect ratio of the image size may shift depending on the correction.

Resetting the keystone correction

(Only for PT-LW330, PT-LW280, PT-LB360 and PT-LB330)

To return to the factory default state by releasing the state of the keystone correction.

- 1) Press ▲▼ to select [Keystone].
- 2) Press the <ENTER> button.
 - The [Keystone] screen is displayed.
- 3) Press ▲▼ to select [Reset value].
- 4) Press the <ENTER> button.
 - The state of the keystone correction is released.

[Logo]

This function allows you to set the Logo select, the image capturing and the Logo PIN code.

- 1) Press ▲▼ to select [Logo].
- 2) Press the <ENTER> button.
 - The [Logo] screen is displayed.
- 3) Press ▲▼ to switch the item.
 - The items will switch each time you press the button.

[Logo select]	Set the logo display when the projector start-up.
[Capture]	The projected image is captured as a still image. The captured image will be displayed as the startup logo when [Logo select] is set to [User].
[Logo PIN code lock]	Set and change the Logo PIN code, and prevents an unauthorized person from changing the PIN code.
[Logo PIN code change]	Change the [Logo PIN code].

[Logo select]

Set the logo display when the projector start-up.

- 1) Press ▲▼ to select [Logo].
- 2) Press the <ENTER> button.
 - The [Logo] screen is displayed.
- 3) Press ▲▼ to select [Logo select].
- 4) Press the <ENTER> button.
- 5) Press ▲▼ to switch the item.
 - The items will switch each time you press the button.

[Off]	Displays nothing to project when the projector start-up.
[Default]	Displays the Panasonic logo when the projector start-up.
[User] ^{*1}	Displays the image registered by the user with the capture function.

*1 [User] will be unavailable when the captured image is not registered.

[Capture]

Set the user logo display when the projector start-up.

- 1) Press ▲▼ to select [Logo].
- 2) Press the <ENTER> button.
 - The [Logo] screen is displayed.
- 3) Press ▲▼ to select [Capture].
- 4) Press the <ENTER> button.

- 5) **A confirmation screen is displayed, press ▲▼ to select [Yes] and then press the <ENTER> button.**
- After capturing the image, the [Logo select] is set to [User]. The captured image will be displayed when the projector start-up next time.

Note

- Only supports still image-based computer (RGB) and still image-based HDMI signals input.
- Capture may not be available depending on the input signal.
- It is recommended to capture the same resolution signal as the display dots (panel resolution) of the projector.
 For PT-LW330, PT-LW280 : 1 280 x 800
 For PT-LB360, PT-LB330, PT-LB300, PT-LB280 : 1 024 x 768
- [Capture] and [Logo select] will be unavailable when [Logo PIN code lock] is set to [On].
- The adjustments of the [Keystone] will be canceled temporarily when the image is capturing.

[Logo PIN code lock]

Set the Logo PIN code (three-digit).

- 1) **Press ▲▼ to select [Logo].**
- 2) **Press the <ENTER> button.**
 - The [Logo] screen is displayed.
- 3) **Press ▲▼ to select [Logo PIN code lock].**
- 4) **Press the <ENTER> button.**
 - The [Logo PIN code] input screen is displayed.
- 5) **Press the <ENTER> button.**
- 6) **Enter the Logo PIN code you have set according to the steps in "Enter a Logo PIN code".**

■ Enter a Logo PIN code

- i) **Press ▲▼ to select a number from 0 to 9.**
 - ii) **Press the <ENTER> button.**
 - The fixed number change to *, the cursor move to the next digit.
 - iii) **Repeat the above steps, and enter a three-digit number.**
 - Move the cursor to [Set] after fixing the three-digit number.
 - iv) **Press the <ENTER> button.**
 - Return to the [Logo] screen.
- 7) **Press ▲▼ to switch the item.**
- The items will switch each time you press the button.

[On]	Set or change [Logo select] and [Capture] are disabled without entering the PIN code.
[Off]	Set or change [Logo select] and [Capture] are enabled without the PIN code.

Attention

- The initial Logo PIN code is "111".
- Change the Logo PIN code periodically that is hard to guess.

Note

- If you want to correct the digit, press the <MENU> button to reset the digit and then re-enter it.
- Press the <ENTER> button after moving the cursor to [Cancel] to reset the all digits.
- If you entered an incorrect digit, the digit (*) will turn red and reset, and then re-enter a digit.

[Logo PIN code change]

Change the Logo PIN code.

- 1) **Press ▲▼ to select [Logo].**
- 2) **Press the <ENTER> button.**
 - The [Logo] screen is displayed.
- 3) **Press ▲▼ to select [Logo PIN code change].**
- 4) **Press the <ENTER> button.**

- The [Logo PIN code] input screen is displayed.
- 5) **Press the <ENTER> button.**
 - 6) **Press ▲▼ to enter the current Logo PIN code from 0 to 9 and press the <ENTER> button.**
 - 7) **Press the <ENTER> button.**
 - The [New logo PIN code] input screen is displayed.
 - 8) **Enter the Logo PIN code you have set according to the steps in "Enter a Logo PIN code".**

Note

- If you want to correct the digit, press ▲▼ to reset the digit and then press ▲▼ re-enter it.
- Press the <ENTER> button after moving the cursor to [Cancel] to return the menu screen.
- If you entered an incorrect digit, the digit (*) will turn red and reset, and then re-enter a digit.

[Security]

Set the PIN code to prevent the unauthorized operation by the third party. The [PIN code] input screen will be displayed when turn on the projector.

- 1) **Press ▲▼ to select [Security].**
- 2) **Press the <ENTER> button.**
 - The [Security] screen is displayed.
- 3) **Press ▲▼ to switch the item.**
 - The items will switch each time you press the button.

[PIN code lock]	The [PIN code] screen will be displayed when turn on the projector. The projector cannot be operated without entering the PIN code.
[PIN code change]	Change the PIN code.

Attention

- The initial PIN code is "111".
- Change the PIN code periodically that is hard to guess.

[PIN code lock]

Set the PIN code (three-digit).

- 1) **Press ▲▼ to select [Security].**
 - 2) **Press the <ENTER> button.**
 - The [Security] screen is displayed.
 - 3) **Press ▲▼ to select [PIN code lock].**
 - 4) **Press the <ENTER> button.**
 - The [PIN code] input screen is displayed.
 - 5) **Press the <ENTER> button.**
 - 6) **Enter the PIN code you have set according to the steps in "Enter a PIN code".**
- **Enter a PIN code**
- i) **Press ▲▼ to select a number from 0 to 9.**
 - ii) **Press the <ENTER> button.**
 - The fixed number change to *, the cursor move to the next digit.
 - iii) **Repeat the above steps, and enter a three-digit number.**
 - Move the cursor to [Set] after fixing the three-digit number.
 - iv) **Press the <ENTER> button.**
 - Return to the [Security] screen.
- 7) **Press ▲▼ to switch the item.**
 - The items will switch each time you press the button.

[On]	The [PIN code] screen will be displayed when turn on the projector. The projector cannot be operated without entering the PIN code.
[Off]	The projector can be operated without the PIN code.

Note

- If you want to correct the digit, press the <MENU> button to reset the digit and then re-enter it.
- Press the <ENTER> button after moving the cursor to [Cancel] to reset the all digits.
- If you entered an incorrect digit, the digit (*) will turn red and reset, and then re-enter a digit.

[PIN code change]

Change the PIN code.

- 1) Press ▲▼ to select [Security].
- 2) Press the <ENTER> button.
 - The [Security] screen is displayed.
- 3) Press ▲▼ to select [PIN code change].
- 4) Press the <ENTER> button.
 - The [PIN code] input screen is displayed.
- 5) Enter the PIN code you have set according to the steps in "Enter a PIN code".
- 6) Press the <ENTER> button.
 - The [New PIN code] input screen is displayed.
- 7) Enter the New PIN code according to the steps in "Enter a PIN code".

[Power management]

This function optimizes lamp power according to the operating status to reduce power consumption.

[Power management]

Set the operation as following if there is no signal input.

- 1) Press ▲▼ to select [Power management].
- 2) Press the <ENTER> button.
 - The [Power management] screen is displayed.
- 3) Press ▲▼ to switch the item.
 - The items will switch each time you press the button.

[Ready]	The countdown timer is displayed after 30 seconds without input signal. The projection lamp turns off and cools down when reaching the set time, meanwhile the projector will enter into the ready mode of the power management. The projection lamp will be turned on if the input signal is reconnected or any button (except for power button <⏻/ >) is pressed.
[Shut down]	The countdown timer is displayed after 30 seconds without input signal. The projection lamp is turned off and cooled down when reached the set time, then the projector enter into standby status.
[Off]	Power management function is off.
[Timer]	Set the time that the Power management starts to work.
[Ready Countdown]	The time from the state which the management function is working to the standby mode can be set to 0 ~ 30 minutes when [Power management] is set to [Ready]. The increment is 1 minute.

Setting [Timer] in step 3)

The time that the Power management starts to work can be set to 1-30 minutes. The increment is 1 minute.

- 1) Press ▲▼ to select [Timer].
- 2) Press the <ENTER> button.
- 3) Press ▲▼ to switch the setting time.
 - The setting times will switch each time you press the button.

Setting [Ready Countdown] in step 3)

The time from the state which the management function is working to the standby mode can be set to 0 ~ 30 minutes when [Power management] is set to [Ready]. The increment is 1 minute.

- 1) Press ▲▼ to select [Ready Countdown].
- 2) Press the <ENTER> button.
- 3) Press ▲▼ to switch the setting time.
 - The items will switch each time you press the button.

[0 Min]	The ready mode of the power management function is continued.
[1 Min] ~ [30 Min]	From the ready mode of the power management function to the standby mode when the projector reach the set time.

[Filter counter]

This function is used to reset the filter use time and set the warning display.

- 1) Press ▲▼ to select [Filter counter].
- 2) Press the <ENTER> button.
 - The [Filter counter] screen is displayed.
- 3) Press ▲▼ to switch the item.
 - The items will switch each time you press the button.

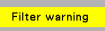
[Filter counter]	Displays the using time of the filter.
[Timer]	Sets the time to display the warning  icon.
[Filter counter reset]	Resets the filter counter.

Setting [Timer]

- 1) Press ▲▼ to select [Timer].
- 2) Press the <ENTER> button.
- 3) Press ▲▼ to switch the setting of the time.
 - The items will switch each time you press the button.
[Off] → [100 H] → [200 H] → [300 H]

[Filter counter reset]

- 1) Press ▲▼ to select [Filter counter reset].
- 2) Press the <ENTER> button.
 - The [Filter counter Reset?] screen is displayed.
- 3) Press ▲▼ to select [Yes] and then press the <ENTER> button.
 - The [OK?] screen is displayed.
- 4) Press ▲▼ to select [Yes] and then press the <ENTER> button.

[Test pattern]

Displays the Test pattern built-in to the projector.

Settings of position, size, and other factors will not be reflected in test patterns. Make sure to display the input signal before performing various adjustments.

- 1) Press ▲▼ to select [Test pattern].
- 2) Press the <ENTER> button.
 - The [Test pattern] screen is displayed.
- 3) Press ▲▼ to switch the item.

[Off]	Test pattern is not displayed.
[Gray scale 1]	Select a test pattern so that it is easy to make various adjustments.
[Gray scale 2]	
[Gray scale 3]	
[Gray scale 4]	
[Color bar]	
[Red]	
[Green]	
[Blue]	
[Cross hatch]	
[White]	
[Black]	
[Raster gray]	

4) Press the <ENTER> button.

- The selected test pattern is displayed and the menu screen is disappeared.

Note

- Press the <MENU> button to display the menu screen and select [Off] in [Test pattern] when you want to cancel the Test pattern function.

[Network]

Initializes the settings of network before using the network function.

[Network setting]

1) Press ▲▼ to select [Network].

2) Press the <ENTER> button.

- The [Network] screen is displayed.

3) Press the <ENTER> button.

- The [Network setting] screen is displayed.

4) Press ▲▼ to select an item, and change the setting according to the instructions.

[DHCP]	<p>[On]: If a DHCP server exists in the network to which the projector is connected, the IP address will automatically be acquired.</p> <p>[Off]: If a DHCP server does not exist in the network to which the projector is connected, additionally set [IP address], [Subnet] and [Gateway].</p>
[IP address]	Enter the IP address if DHCP server is not used.
[Subnet]	If not using a DHCP server, enter the subnet mask.
[Gateway]	Enter the gateway address if DHCP server is not used.
[DNS]	Enter the DNS server address if DHCP server is not used.

5) Press ▲▼ to select [Set], and press the <ENTER> button.

- The following settings are set before the projector leaves the factory.

[DHCP]	Off
[IP address]	192.168.1.100
[Subnet]	255.255.255.0
[Gateway]	192.168.1.1
[DNS]	192.168.1.1

Note

- Before using the DHCP server, make sure the DHCP server is already functioning.
- Consult your network administrator regarding the IP address, Subnet and Gateway.

[Network information]

1) Press ▲▼ to select [Network].

2) Press the <ENTER> button.

- The [Network] screen is displayed and then confirm the following items.

[MAC address]	Displays the MAC address of this projector.
[IP address]	Displays the current IP address of this projector.

[Remote control]

This switching function prevents remote control interference when operating several projectors or video equipment at the same time.

1) Press ▲▼ to select [Remote control].

2) Press the <ENTER> button.

- The [Remote control] screen is displayed.

3) Press ▲▼ to select one item.

- This projector provides 7 different remote control codes: [All], [Code 1]~[Code 6].

[All]	Select when controlling projectors without specifying an ID number.
[Code 1] - [Code 6]	Select when specifying an ID number to control individual projector.

4) Press the <ENTER> button.

- [Remote control] is set.

Note

- To specify an ID number for individual control, the ID number of a remote control must match the ID number of the projector.
- When the ID number is set to [All], the projector will operate regardless of the ID number specified by remote control. If multiple projectors are set up side by side with ID set to [All], they cannot be controlled separately from the projectors with other ID numbers.
- Refer to "Setting Remote control ID numbers" (➡ page 23) for how to set the ID number on the remote control.

[Factory default]

Return various setting values to their factory default settings.

1) Press ▲▼ to select [Factory default].

2) Press the <ENTER> button.

- The [Return to Factory default?] screen is displayed.

3) Press ▲▼ to select [Yes] and then press the <ENTER> button.

- The [OK?] screen is displayed.

4) Press ▲▼ to select [Yes] and then press the <ENTER> button.

- The [Please wait...] message will appear, and resetting operation will start, and after completing the operation, the [Please wait...] message will disappear.

Attention

- After executing the [Factory default], be sure to turn off the projector (➡ page 36), disconnect the power plug from the wall outlet, and then turn on the projector in order to reflect the initial setting values.

Note

- When [Factory default] is executed, all setting values except for User Logo, PIN code lock, Logo PIN code lock, Lamp counter, Filter counter and Logo select to the factory default settings.

[Memory Viewer] menu

On the menu screen, select [Memory Viewer] from the main menu, and select an item from the sub-menu. Refer to “Navigating through the menu” (➔ page 44) for the operation of the menu screen.

- After selecting the item, press ▲▼ to set.

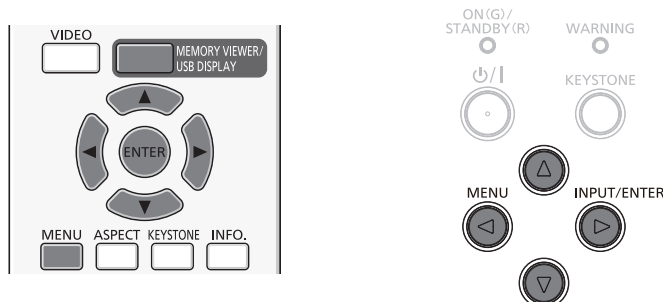

Note

- Memory Viewer function is only for PT-LW330, PT-LW280, PT-LB360 and PT-LB330.
- The [Memory Viewer] menu is available when input the [Memory Viewer] signal.
- The menu except for [Set Slide] which settings have been changed is not yet effective before the [Apply] is not executed.

[Set Slide]

Start the slide show.

- 1) Press ▲▼ to select [Set Slide].
- 2) Press the <ENTER> button.
 - Slide show will start.

[Slide Transition Effect]

Set the slide transition effect when the slide show image is switching.

- 1) Press ▲▼ to select [Slide Transition Effect].
- 2) Press the <ENTER> button.
- 3) Press ▲▼ to switch the item.
 - The items will switch each time you press the button.

[Slide down]	Switches the image from the top to the bottom.
[Slide Right]	Switches the image from the left to the right.

[Sort Order]

Set the sort order of the slide show.

- 1) Press ▲▼ to select [Sort Order].
- 2) Press the <ENTER> button.
- 3) Press ▲▼ to switch the item.
 - The items will switch each time you press the button.

[Extend Order]	Sort files or folders in extended order.
[Size Order]	Sort files or folders in amount of data order.
[Time Order]	Sort files or folders in stored time order.
[Name Order]	Sort files or folders in name order.

[Rotate]

Set the rotate direction of image.

- 1) Press ▲▼ to select [Rotate].
- 2) Press the <ENTER> button.
- 3) Press ▲▼ to switch the item.

- The items will switch each time you press the button.

[No Rotate]	Rotate is disabled.
[270 Degrees]	Rotates 270 degrees in anti-clockwise direction.
[180 Degrees]	Rotates 180 degrees.
[90 Degrees]	Rotates 90 degrees in anti-clockwise direction.

[Best Fit]

Set the image whether or not to fit with the projected screen.

- 1) Press ▲▼ to select [Best Fit].
- 2) Press the <ENTER> button.
- 3) Press ▲▼ to switch the item.

- The items will switch each time you press the button.

[On]	Displays the image to fit with the aspect of the projected screen.
[Off]	Displays in the normal pixels of the image.

[Repeat]

Set whether or not to play the slide show repeatedly.

- 1) Press ▲▼ to select [Repeat].
- 2) Press the <ENTER> button.
- 3) Press ▲▼ to switch the item.

- The items will switch each time you press the button.

[On]	Repeat broadcast the first file after the last file is broadcasted.
[Off]	Return to the thumbnail display after the last file is broadcasted.

[Apply]

Executes the setting in slide show.

- 1) Press ▲▼ to select [Apply].
- 2) Press the <ENTER> button.

- The setting of the items except for [Set Slide] will be effective.

[Info.] menu

On the menu screen, select [Info.] from the main menu.
Refer to “Navigating through the menu” (➔ page 44) for the operation of the menu screen.

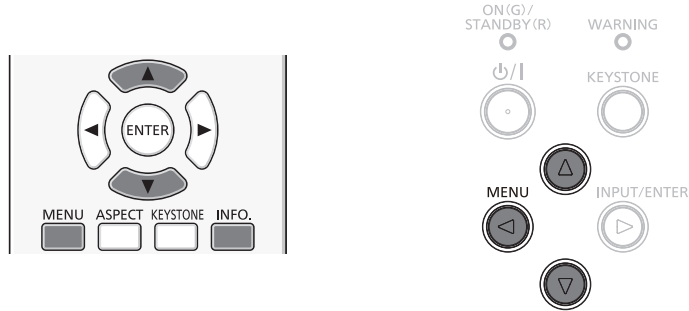

[Info.]

Display the status of the projector.

1) Press ▲▼ to select [Info.].

- The [Info.] screen is displayed.
- You can also press the <INFO.> button on the remote control. (➔ page 40)



[Input]	The selected input source and the system are displayed.
[H-sync freq.]	The horizontal frequency of the input signal is displayed in kHz. [- - - -] is displayed when no signal is detected.
[V-sync freq.]	The vertical frequency of the input signal is displayed in Hz. [- - - -] is displayed when no signal is detected.
[Lamp status]	The setting status of [Lamp control] is displayed.
[Lamp counter]	The usage time of the lamp is displayed. (Displays the converted runtime when [💡 (Eco 1)] is using.)
[Power management]	The setting status of [Power management] is displayed.
[Image mode]	The setting status of [Image mode] is displayed.
[S/N]	The serial number of the projector is displayed. The serial number is used to service the projector.

Network control

Network connections

The projector has a network function, and the following operations are available from the computer using the web browser control.

- Setting and adjustment of the projector.
- Display of the projector status.

Note

- A LAN cable is required to use the network function.

■ Example of a normal network connection

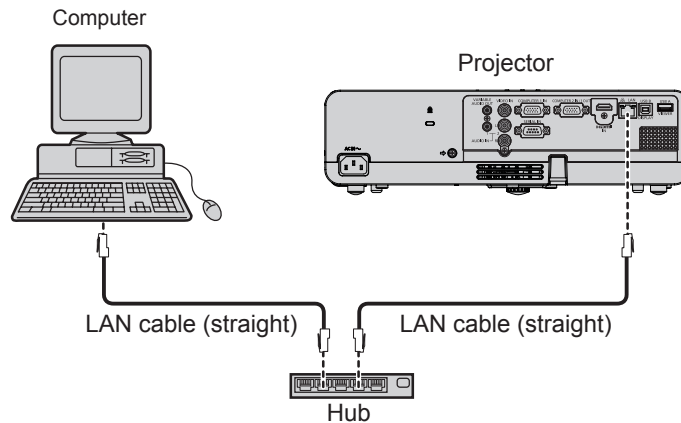

- A Web browser is required to use this function. Confirm that the Web browser can be used beforehand.
Compatible Web Browser : Internet Explorer 7.0/8.0/9.0/10.0, Safari 4.0/5.0/6.0 (Mac OS)
- Use shielded LAN cable (STP cable) that is compatible with category 5 or above.
- Use a LAN cable with length of 100 m or shorter.

■ Name and function of network function parts

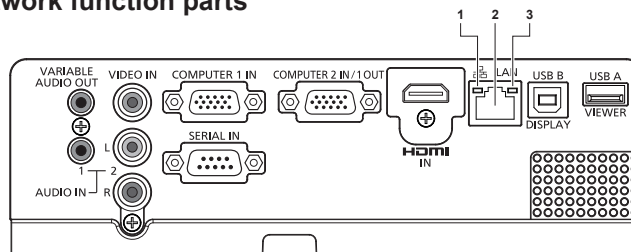

1 LAN LINK/ACT lamp (yellow)

Lights on when connected.
Blinks when transmitting/receiving data.

2 <LAN> terminal (10BASE-T/100BASE-TX)

Used to connect LAN cable here.

3 LAN 10/100 lamp (green)

Lights on when connected to the 100BASE-TX.

Attention

- When a LAN cable is directly connected to the projector, the network connection must be made indoors.
- When connecting cables to both the <HDMI IN> terminal and the <USB B (DISPLAY)> terminal, it may be difficult to remove the LAN cable which is connected to the <LAN> terminal. When removing the LAN cable from the <LAN> terminal, remove a cable connected to the <HDMI IN> terminal or the <USB B (DISPLAY)> terminal beforehand.

Projector settings

- 1) Use the LAN cable (Straight) to connect the projector with computer.
- 2) Turn on the projector.
- 3) Set the [Expand] menu → [Network] → [Network setting]
 - For details, refer to the [Expand] menu → [Network] (➡ page 69).

Note

- Please confirm with your network administrator before you connect to an existing network.
- The following settings are set before the projector leaves the factory.

[DHCP]	Off
[IP address]	192.168.1.100
[Subnet]	255.255.255.0
[Gateway]	192.168.1.1
[DNS]	192.168.1.1

Computer operation

Connection can be made with wired LAN. However, confirm to your system administrator on network settings before changing any settings.

- 1) Turn on the computer.
- 2) Make the network setting according to your system administrator.
 - If the projector settings are the default settings, the computer can be used with the following network settings.

[IP address]	192.168.1.101
[Subnet]	255.255.255.0
[Gateway]	192.168.1.1

Accessing from the Web browser

- 1) Activate the Web browser in the personal computer.
- 2) Enter the IP address set by the projector into the URL input field of the Web browser.
 - The [Network Display System] screen is displayed.
- 3) Click [Login] and enter the password in the [Password] column.
 - The factory default setting of the user name is "admin" (administrator rights) and the password is "admin".

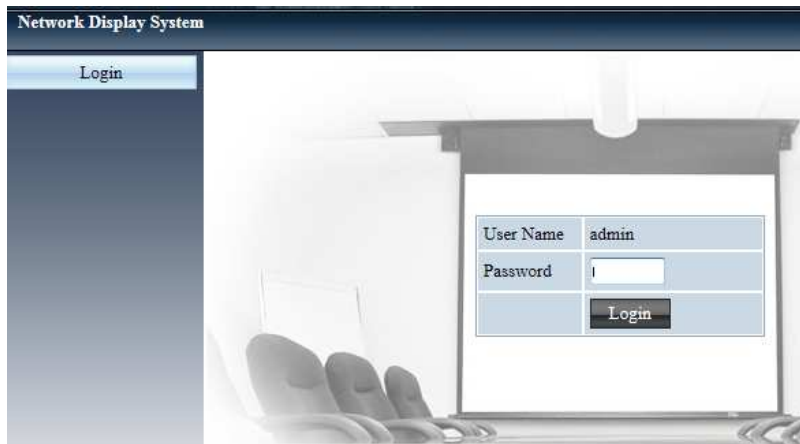

- 4) Click [Login].
 - The [System Status] page is displayed.

Note

- You can click the upper right corner of the web browser screen to select the display language.
- Do not perform setting or control simultaneously by starting up multiple web browsers. Do not set or control the projector from multiple computers.
- Change the password first. (8 half-width characters) (➡ page 76)
- If the screen for the web control is not displayed, consult your network administrator.

Description of each item

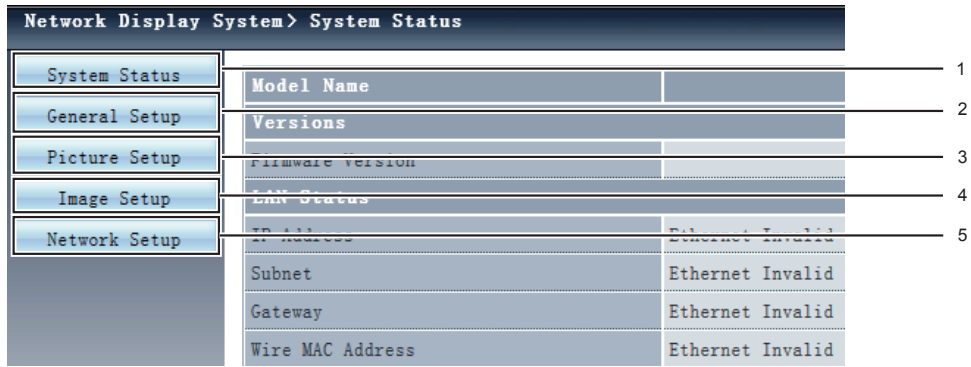

- 1 **[System Status]**
The [System Status] page is displayed by clicking this item.
- 2 **[General Setup]**
The [General Setup] page is displayed by clicking this item.
- 3 **[Picture Setup]**
The [Picture Setup] page is displayed by clicking this item.
- 4 **[Image Setup]**
The [Image Setup] page is displayed by clicking this item.
- 5 **[Network Setup]**
The [Network Setup] page is displayed by clicking this item.

[System status] page

Display the status of the projector for the following items.

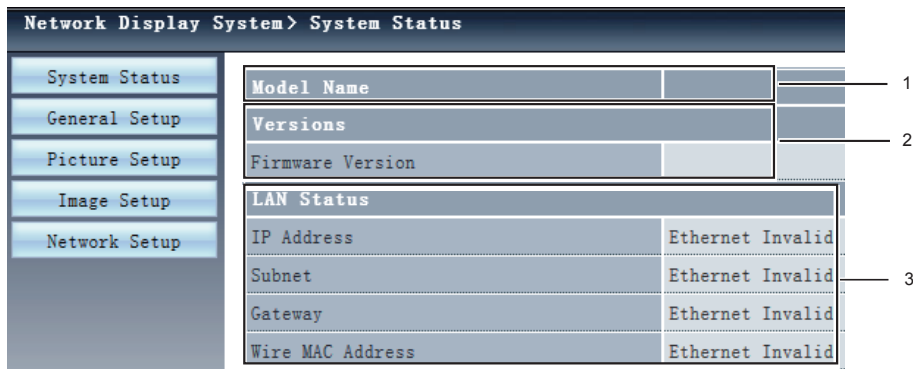

- 1 **[Model Name]**
Displays the model No. of the projector.
- 2 **[Versions]**
Displays the version of the firmware of the projector.
- 3 **[LAN Status]**
Displays the connection status of the LAN.

[General Setup] page

[Change Password for Webpage] is displayed.

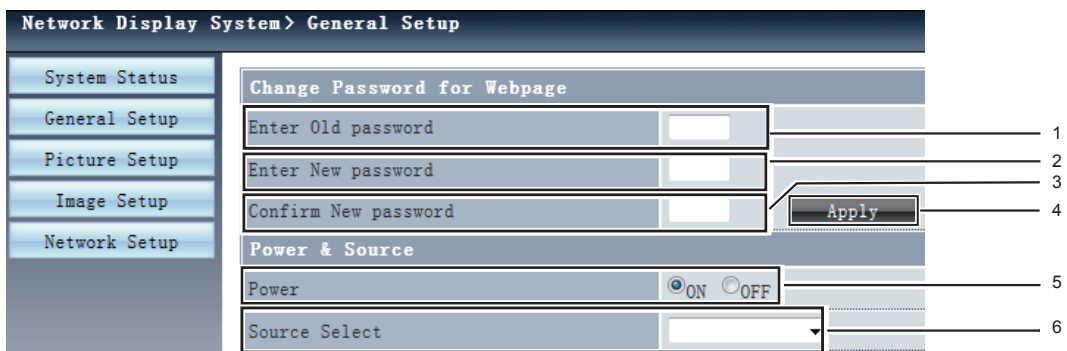

- 1 **[Enter Old password]**
Enters the configured password.
- 2 **[Enter New password]**
Enters the new password.
- 3 **[Confirm New password]**
Enters the desired new password again for confirmation.
- 4 **[Apply]**
Updates the settings.
- 5 **[Power]**
Displays the current status when set it to [ON].
Turns off the projector when set it to [OFF].
- 6 **[Source Select]**
Switches the input source of the projector.

[Picture Setup] page



- | | |
|---|---|
| <p>1 [Brightness]
Adjusts the brightness of the projected image.</p> <p>2 [Contrast]
Adjusts the contrast of the projected image.</p> <p>3 [Sharpness]
Adjusts the sharpness of the projected image.</p> | <p>4 [Color]
Adjusts the color saturation of the projected image.</p> <p>5 [Tint]
Adjusts the skin tone of the projected image.</p> <p>6 [Color temperature]
Adjusts the color temperature of the projected image.</p> |
|---|---|

[Image Setup] page

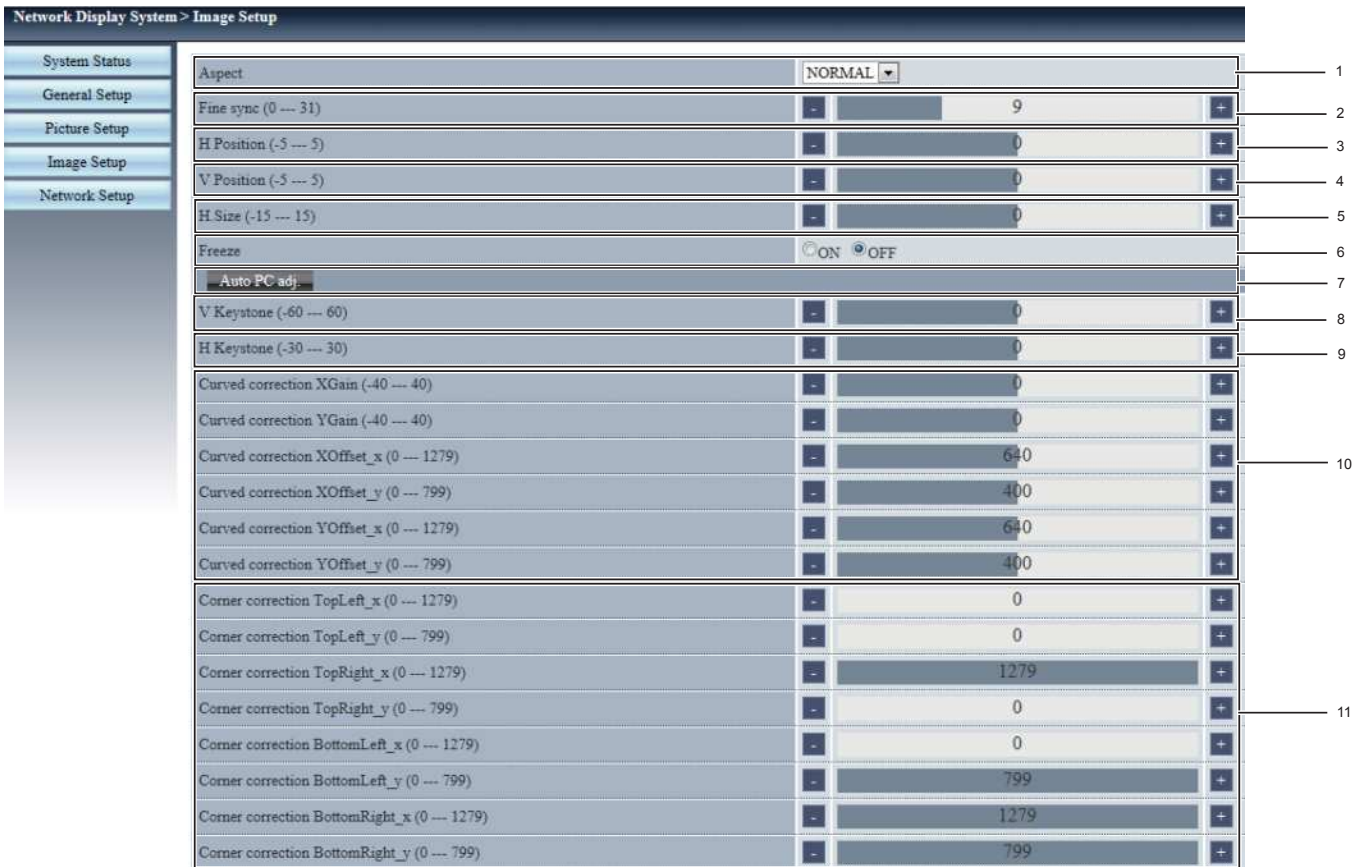

- 1 **[Aspect]**
Switches the aspect of the projected image.
- 2 **[Fine sync]**
Adjusts the fine sync of the projected image.
- 3 **[H Position]**
Adjusts the horizontal position of the projected image.
- 4 **[V Position]**
Adjusts the vertical position of the projected image.
- 5 **[H.Size]**
Adjusts the total number of dots of the projected image.
- 6 **[Freeze]**
Switches the freeze function between on and off.
- 7 **[Auto PC adj.]**
Executes the Auto PC adj. function.
- 8 **[V Keystone]**
Corrects the keystone in vertical direction.
- 9 **[H Keystone]**
Corrects the keystone in horizontal direction.
- 10 **[Curved correction]**
Corrects the pincushion or barrel of the projected image.
- 11 **[Corner correction]**
Corrects the four corners of the projected image.

[Network Setup] page

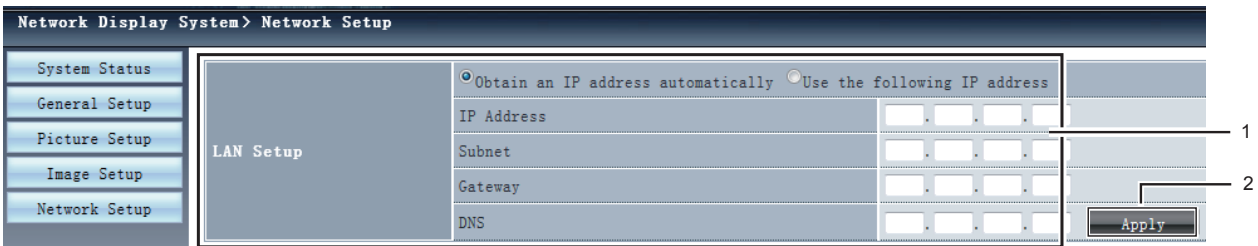

- 1 **[LAN Setup]**
Select [Obtain an IP address automatically] if you want to enable the DHCP client.
[IP Address]
Enter the IP address when not using a DHCP server.
[Subnet]
Enter the subnet mask when not using a DHCP server.
[Gateway]
Enter the default gateway address when not using a DHCP server.
[DNS]
Enter the DNS server when not using a DHCP server.
Allowed characters: Numbers (0 - 9), period (.)
(Example: 192.168.0.253)
- 2 **[Apply]**
Updates the settings.

Using useful functions

Memory Viewer function

The Memory Viewer function makes it possible to project the video and pictures which are stored in the USB memory when the USB memory is inserted into the projector.

■ What you can project with the Memory Viewer function

Memory Viewer function supports the following image files.

Video	Extension	Video codec	Audio codec	Video format
	avi	MotionJpeg	ADPCM	Maximum: 1 280 x 720, 30 fps

Picture	Extension	Format	Description
	jpg/jpeg	Baseline coding 24 bits Progressive RGB 24 bits	Resolution : 8 x 8 ~ 10 000 x 10 000 Resolution : 8 x 8 ~ 1 280 x 800
bmp	Palette-based 1, 4, 8 bits, RGB 24, 32 bits	The maximum resolution : 1 280 x 800	
png	True color 24 bits/48 bits	The maximum resolution : 1 280 x 800	
gif	Palette-based 1, 4, 8 bits,	Palette - 24 bits color spaces; The maximum resolution : 1 280 x 800	
tif / tiff		The maximum resolution : 1 280 x 800	
pdf			

Note

- The maximum size of file is 2 GB.
- The maximum number of file/folder is up to 500. If it exceeds the folder cannot display and an error message appears.
- You cannot play the files which is protected by Digital Rights Management (DRM).
- It maybe impossible to resume playing even if the file is recorded in the supported format.

■ The related device

It is compatible with the USB memory sold in the market. (Do not ensure the security.)

It cannot be used the other format other than the formatted with FAT16 and FAT32.

Displaying the Memory Viewer screen

- 1) Press the <MEMORY VIEWER/USB DISPLAY> button on the remote control or switch the input source to [Memory Viewer].
 - Press the <INPUT/ENTER> button on the control panel and select the input source in the Input menu.
- 2) Insert the USB memory directly into the <USB A (VIEWER)> terminal.
 - The standby screen "please press RC ENTER" is displayed while the USB memory icon is displayed at the lower left of the screen.
 - When the partition are separated in USB memory, several USB icons will be displayed.
- 3) Press the <ENTER> button on the remote control.
 - The root directory of the USB memory will be displayed in thumbnail on the screen.

Playing the pictures

It will display a picture when play the picture manually every time.

- 1) Press ▲▼◀▶ on the remote control to select a file.
- 2) Press the <ENTER> button on the remote control.
 - The picture will display on the full screen.
- 3) Press ▶ to switch to the next picture, press ◀ to return to the previous picture.
- 4) Press the <ENTER> button on the remote control.
 - Return to the thumbnail screen.

Executing the slide

All pictures in the same folder will play automatically when [Sort Order] and [Slide Transition Effect] and so on of [Memory Viewer] menu are set to the special setting.

- 1) Press ▲▼◀▶ on the remote control to select a file.
- 2) Press the <MENU> button to select the [Memory Viewer] → [Set Slide].
- 3) Press the <ENTER> button on the remote control.
 - The picture will display on the full screen.
 - Press the <ENTER> button to return to the thumbnail screen.

Note

- If you press the <MENU> button during the slide show, the image will stop and the a menu displays. The playing will continue when the menu disappears.

Playing the video

Playing the video file.

- 1) Press ▲▼◀▶ on the remote control to select a file.
- 2) Press the <ENTER> button on the remote control.
 - Playing on the full screen.
 - To operate the controller which is displayed on the bottom of the screen with the remote control.



	Video playing is terminated, and return to the thumbnail screen.
	Pauses / plays the video.
	10 seconds backward / forward skip and will continue to play thereafter.
	60 seconds backward / forward skip and will continue to play thereafter.
	The frame will switch between display and non-display each time you press the icon. The video can be played repeatedly when the frame is displayed.

Note

- If there are any invalid operations during video playing, the icon indicating invalid key operations will appear.

Displaying the PDF

Operating the controller to display the PDF.

- 1) Press ▲▼◀▶ on the remote control to select a PDF file.
- 2) Press the <ENTER> button on the remote control.
 - Displaying the PDF on the full screen.
 - To operate the controller which is displayed on the bottom of the screen with the remote control.
 - When the button is selected, the background display will be switched between blue and white.



	Displays the previous or next page.
	The page number ## of [GO ##] increases or decreases by 1 page each time you click the button.
	The page number ## of [GO ##] increases or decreases by 5 pages each time you click the button.
	Jumps to page number ## directly.
	Switches between PDF full width display and single whole page display.
	Switches the display size in 3 levels of magnification each time you click the button.
	When the button is selected, press ▲▼◀▶ on the remote control to move the display screen up, down, left and right. Clicks this button again to release it.
	Terminates the PDF display and returns to the thumbnail display.

Note

- PDF display is switched at intervals. Please do not perform continuous operations during a short period of time.

Termination of the Memory Viewer

- 1) Press ▲▼◀▶ to select the thumbnail  which is displayed on the upper left corner.
- 2) Press the <ENTER> button on the remote control.
 - Return to the standby screen “please press RC ENTER”.
- 3) Remove the USB memory directly.

Attention

- When inserting the USB memory, confirm the direction of the plug not to damage the terminal.
- Please note following points to insert and remove the USB memory.
 - The indicator of the USB memory will be blinking when it is inserted to the projector or while the projector is reading out the data. Do not remove the USB memory while it is blinking.
 - When using a USB memory without indicator, you cannot recognize when the projector reading out the data. Please remove it from the projector after closing the Memory Viewer function or turning off the projector.
 - Do not install and remove the USB memory frequently. Remove the USB memory at least 5 seconds after installation. And install at least 5 seconds after removal. While installing or removing the USB memory, the projector is in switching period for those operation.

■ Caution on handling and storing the USB memory

- Do not put USB memory or its cap within close reach of children. Swallowing them may cause suffocation.
- If the smoke or questionable odor rise, turn off the peripheral equipment and contact your dealer.
- Do not put water, chemical or oil to the USB memory. It may cause short out or fire.
- Do not put foreign objects or put metal objects to the USB terminal. Static electricity may cause data loss or data corruption.
- Do not remove the USB memory from the computer or the projector while the USB memory is reading out or writing the data. It may cause data loss or data corruption.
- Do not store the USB memory where high temperature, humid or dusty place or magnetized items are around.

Note

- The USB memory allows you to insert or remove regardless of the power status of the projector.

USB Display function

The USB Display function makes it is possible to project the image and audio from the computer through a USB converting cable.

When using Windows

■ Windows operating environment

OS	Windows Vista 32 bit, Windows 7 32/64 bit, Windows 8 32/64 bit
CPU	Intel Core 2 Duo 2.0 GHz or faster, the compatible processor
Amount of memory	256 MB or more (Recommended : 512 MB or more)
Hard-disk free space	20 MB or more
Display	Resolution 640 x 480 or more, 1 600 x 1 200 or less

- There is no guarantee for all the computers that meet the above conditions will operate properly.

Projecting the USB display

- 1) Connect the <USB B (DISPLAY)> terminal of the projector to a computer with a USB cable.
- 2) Press the <MEMORY VIEWER/USB DISPLAY> button on the remote control or switch the input source to [USB Display].
 - You can also press the <INPUT/ENTER> button on the control panel and select the input source in the Input menu.
 - The startup screen will be displayed automatically due to the driver which is built-in the projector, and executing the installation according to the instructions of the screen. The displaying of the auto installation screen is depending on the settings of computer. At this time, please select "Run autorun.exe". Please double-click "autorun.exe" in the folder of the "USB Display" when the automatic startup is disabled.
 - The computer screen is projected.
- 3) Click the driver icon  in the task bar of computer and select one item in Pop-up menu.
 - Pop-up menu is only displayed in English.
 - The item which is displayed in gray is unavailable.

[Active audio] / [Disable audio]	Set whether to output the audio from the computer.
[Play video] / [Pause video]	Switch between play and pause the image.
[Start] / [Stop]	Set whether to display the image from the computer.

[Exit]	Displayed in gray and cannot be selected.
--------	---

Note

- The driver is not installed in your computer, and it will be removed from the computer when disconnected the USB cable.
- It will take a while when you want to project the computer screen.
- Connect a USB cable directly to the USB connector of a computer. It will not work when connect through a USB hub.
- The screen resolution of your computer will be switched as follows: PT-LW330 and PT-LW280: 1 280 x 800 (WXGA), PT-LB360 and PT-LB330 : 1 024 x 768 (XGA).

Termination of the USB display

- 1) **When terminate the USB display, remove the USB cable directly.**
 - There is no need to following "Remove hardware safely" when a USB cable is disconnected.

When using Mac OS

■ **Mac OS operating environment**

OS	Mac OS X 10.5, 10.6, 10.7
CPU	Power PC G4 1GHz or faster
Amount of memory	512 MB or more
Hard-disk free space	20 MB or more
Display	Resolution 640 x 480 or more, 1 600 x 1 200 or less

- There is no guarantee for all the computers that meet the above conditions will operate properly.

Projecting the USB display

- 1) **Connect the <USB B (DISPLAY)> terminal of the projector to a computer with a USB cable.**
- 2) **Press the <MEMORY VIEWER/USB DISPLAY> button on the remote control or switch the input source to [USB Display].**
 - You can also press the <INPUT/ENTER> button on the control panel and select the input source in the Input menu.
 - The virtual disk which is named "USB Display" will be mounted on desktop.
- 3) **Double-click "Monitor.app" in the virtual disk that has been mounted.**
 - The computer screen is projected.
- 4) **Right-click the driver icon  in the dock of computer and select one item in Pop-up menu.**
 - The item which is displayed in gray is unavailable.

[Active audio] / [Disable audio]	Set whether to output the audio from the computer.
[Play video] / [Pause video]	Switch between play and pause the image.
[Start] / [Stop]	Set whether to display the image from the computer.
[Options]	Set the items of "Keep in Dock", "Open at Login" or "Show in Finder".
[Show All Windows]	Display the background of computer on the full screen temporarily.
[Hide] / [Show]	Set whether to display the USB driver icon.
[Quit]	Terminate the USB Display.

Note

- It will take a while when you want to project the computer screen.
- Connect a USB cable directly to the USB connector of a computer. It will not work when connect through a USB hub.

Termination of the USB display

- 1) **When terminate the USB display, remove the USB cable directly.**

Chapter 5 Maintenance

This chapter describes methods of inspection when there are problems, maintenance, and replacement of the units.

Power/Warning Indicators

When an indicator lights up

If a problem should occur inside the projector, the power indicator <ON(G)/STANDBY(R)> and the warning indicator <WARNING> will inform you by lighting or blinking. Check the status of the indicators and remedy the indicated problems as follows.

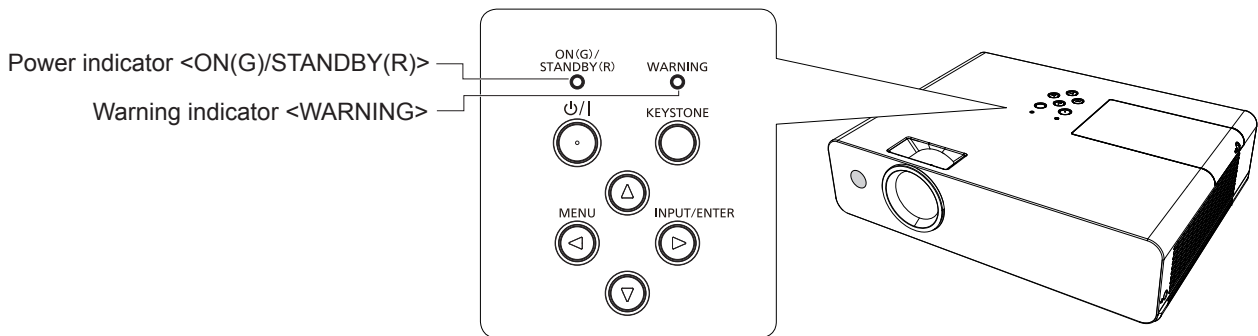

Attention

- Before you take a remedial measure, follow the procedure of switching the power off indicated in “Powering Off the Projector” (➔ page 36).



Power indicator <ON(G)/STANDBY(R)>	Warning indicator <WARNING>	Status	Cause	Solution
Off	Off	The power cord is unplugged.	--	--
Red	Lighting	Off	The power cord is unplugged. The projector is in standby mode after the cooling is completed.	--
		Lighting in red	The replacement time of the lamp unit is displayed. (Standby mode)	<ul style="list-style-type: none"> • The indicator lights up when the usage time of the lamp unit reaches 6 000 hours (when [Lamp control] is set to [💡 (Eco 1)]).
	Lighting	Blinking in red	It has exceeded the replacement time of the lamp unit and the projector is turned off automatically.	<ul style="list-style-type: none"> • The indicator blinks when the usage time of the lamp unit reaches 6 600 hours (when [Lamp control] is set to [💡 (Eco 1)]).
	Blinking	Off	The projector inside is cooling down and after a while, the projector is turned off. (The projector will enter the standby mode)	--

Chapter 5 Maintenance - Power/Warning Indicators

Power indicator <ON(G)/STANDBY(R)>	Warning indicator <WARNING>	Status	Cause	Solution	
Green	Lighting	Off	Projecting.	--	
	Lighting	Lighting in red	The replacement time of the lamp unit is displayed. (Projecting)	<ul style="list-style-type: none"> Is the lamp replacement warning icon  displayed when turn on or turn off the projector? The indicator lights up when the usage time of the lamp unit reaches 6 000 hours (when [Lamp control] is set to [ (Eco 1)]). 	<ul style="list-style-type: none"> Replace the lamp unit.
	Lighting	Blinking in red	It has exceed the replacement time of the lamp unit and the projector is turned off automatically.	<ul style="list-style-type: none"> The indicator blinks when the usage time of the lamp unit reaches 6 600 hours (when [Lamp control] is set to [ (Eco 1)]). 	
	Blinking	Off	The power cord is plugged and the lamp is turned off. [Power management] is set to [Ready].	--	
Orange	Lighting	Off	The projector detects an abnormal condition and cannot be turned on. (Warning)	--	<ul style="list-style-type: none"> If the projector is turned off, unplug the AC power cord and contact the dealer.
	Lighting	Lighting	There is a problem in the contrast shutter circuit for iris. (Warning)	--	<ul style="list-style-type: none"> Turn off the projector, unplug the AC power cord and contact the dealer.
	Blinking	Off	Internal temperature is high. (Warning)	<ul style="list-style-type: none"> Is the air intake/exhaust port blocked? Is the room temperature high? Is the air filter unit clogged? 	<ul style="list-style-type: none"> Remove any objects that are blocking the air intake/ exhaust port. Install the projector in a location with an ambient temperature of 0 °C (32 °F) to 40 °C (104 °F). Do not use the projector at high altitudes of 2 700 m (8 858') or higher above sea level. Clean the air filter unit or replace it.

Note

- If the warning indicator <WARNING> persists to light or blink after taking these measurements such as turn off the projector, unplug the power cord, please contact your dealer for repair services.
- If the power indicator <ON(R)/STANDBY(G)> persists to light or blink in orange after taking these measurements such as turn off the projector, unplug the power cord, please contact your dealer for repair services.

Maintenance/replacement

Before performing maintenance/replacement

- When you perform maintenance or replacement of the parts, make sure to turn off the power and disconnect the power plug from the wall outlet. (➔ page 36)
- Be sure to observe the procedure “Powering Off the Projector” (➔ page 36) when performing power supply operation.

Maintenance

Outer Case

Wipe off dirt and dust using a soft dry cloth.

- If the dirt is persistent, soak the cloth with water and wring it thoroughly before wiping. Dry off the projector with a dry cloth.
- Do not use benzene, thinner, or rubbing alcohol, other solvents, household cleaners. Using them may cause deterioration of the outer case.
- When using chemical treated dusters, follow its instruction.

Front glass surface of the lens

Wipe off the dirt and dust off the front surface of the lens with soft clean cloth.

- Do not use a cloth that has an abrasive surface or a cloth that is moist, oily, or covered with dust.
- Do not use excessive force when wiping the lens as it is fragile.

Attention

- The lens is made of glass. Impacts or excessive force when wiping may scratch its surface. Please handle with care.

Air filter unit

Perform maintenance of the air filter in the following cases.

- If the time which is set in [Expand] menu → [Filter counter] is elapsed, the filter warning icon  will be displayed.
- If the air filter is clogged with dust, the power indicator <ON(G)/STANDBY(R)> lights in orange.

Attention

- Make sure to turn off the power before performing maintenance on the air filter unit.
- Make sure that the projector is stable, and perform the maintenance in a safe place where the unit will not be damaged even if you drop the air filter unit.

Removing the air filter unit

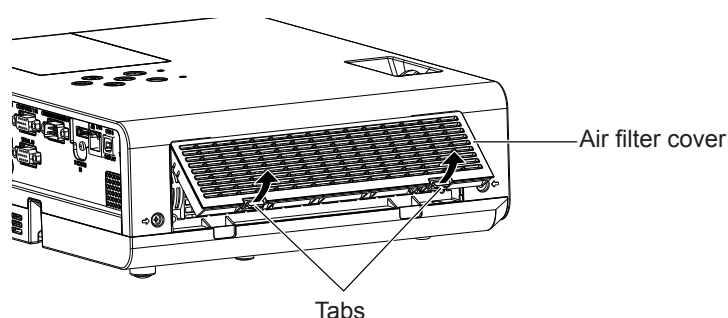

Fig.1

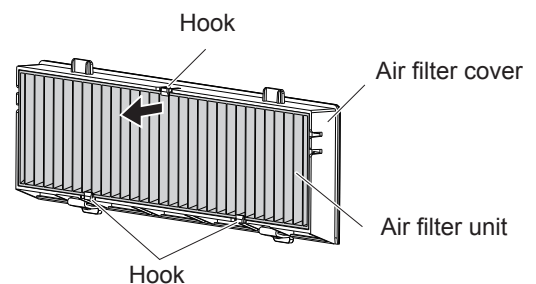

Fig.2

1) Remove the air filter cover. (Fig.1)

- Pull out the air filter cover from the hook of the projector while slightly pushing upward the tabs of the air filter cover and open it in the direction of the arrow in figure.

2) Remove the air filter unit.

- The air filter unit is fixed by the 3 hooks. Grasp the fibre of the air filter unit near to the cover side with one hook and then pull the air filter unit out from the air filter cover as arrow direction shown. (Fig.2)
- After removing the air filter unit, remove foreign objects and dust from the air filter compartment and the projector's air intake port if there are any.

Cleaning the air filter unit

Remove the air filter unit beforehand according to the previously described procedure in "Removing the air filter unit".

1) Clean the air filter unit.

- Vacuum dirt and dust from the air filter unit.
- Do not wash the air filter unit.

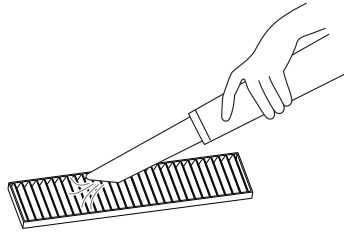

Attaching the air filter unit

1) Attach the new air filter unit to the air filter cover.

- There is a distinction between the inside and outside of the air filter unit. Align the red mark on the air filter unit with the red mark on the air filter cover.

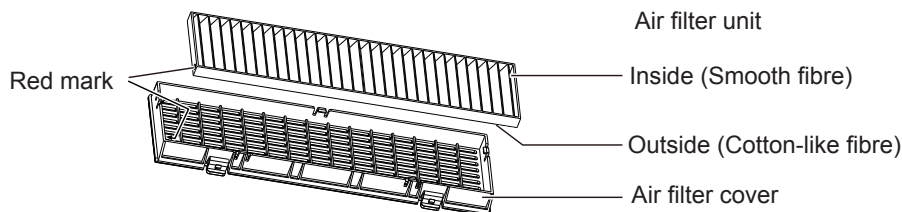

- Insert the air filter unit to the side with the 2 hooks and then press the other side of the air filter unit into the cover side with 1 hook.

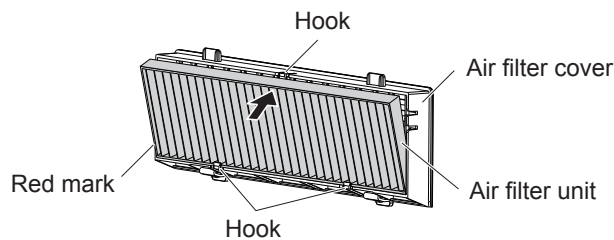

2) Attach the air filter cover to the projector.

- Perform Step 1) in "Removing the air filter unit" (➔ page 86) in the reverse order.
- Make sure that the air filter cover is closed tightly.

Resetting the filter counter

Be sure to reset the filter counter after cleaning the air filter unit.

- 1) Connect the power plug, press the power < ⏻ / | > button on the control panel or on the remote control.
- 2) Press the < MENU > button to display the main menu, then press ▲ ▼ to select [Expand].
- 3) Press the < INPUT/ENTER > button on the control panel or the < ENTER > button on the remote control, then press ▲ ▼ to select [Filter counter].
- 4) Press the < INPUT/ENTER > button on the control panel or the < ENTER > button on the remote control, then press ▲ ▼ to select [Filter counter reset].
- 5) Press the < INPUT/ENTER > button on the control panel or the < ENTER > button on the remote control.
 - The [Filter counter reset ?] confirmation message is displayed.
- 6) Press ▲ ▼ to select [Yes], then press the < INPUT/ENTER > button on the control panel or the < ENTER > button on the remote control.
 - The [OK?] screen is displayed.
- 7) Press ▲ ▼ to select [Yes], then press the < INPUT/ENTER > button on the control panel or the < ENTER > button on the remote control.
 - The filter usage time is 0 after reset.

Attention

- Do not disassemble the air filter unit.
- When attaching the air filter unit, make sure that the projector is stable, and work in an environment that is safe, even in the event of the air filter unit dropping.
- Make sure that the air filter unit is properly attached before using the projector. If it is not attached, the projector will suck in dirt and dust causing a malfunction.

Note

- After cleaning the air filter, reset the filter counter. Otherwise, the warning icon  will appear on screen.
- Replace the air filter unit with the new optional Replacement Filter Unit (Model No.: ET-RFL300) if it is damaged or if the dirt does not come off even after cleaning.

Replacing the unit

Lamp unit

The lamp unit is a consumable component. Refer to “When to replace the lamp unit” for details about the replacement cycle. When purchasing the optional Replacement Lamp Unit (Model No.: ET-LAL500), consult your dealer.

Warning

Do not replace the lamp unit when it is hot. (Wait at least 1 hour after use.)
The inside of the cover can become very hot, take care to avoid burn injuries.

Notes on the replacement of the lamp unit

- A Phillips screwdriver is necessary when replacing the lamp unit.
- Since the luminous lamp is made of glass, it may burst if dropped or hit with a hard object. Handle with care.
- Do not disassemble or modify the lamp unit.
- When replacing the lamp unit, be sure to hold it by the handle because its surface is pointed and its shape is protruded.
- The lamp may rupture. Replace the lamp unit carefully so the glass fragments of the lamp do not scatter. While attaching the projector to the ceiling, do not work right under the lamp unit or do not conduct work while your face is near the lamp unit.
- The lamp contains mercury. When disposing of used lamp units, contact your local authorities or dealer for correct methods of disposal.

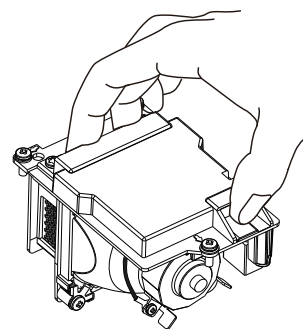

Attention

- Panasonic takes no responsibility for any damage or malfunction of the product resulting from use of lamp units which are not manufactured by Panasonic. Use only specified lamp units.

Note





- The model numbers of accessories and optional accessories are subject to change without prior notice.



When to replace the lamp unit

The lamp unit is a consumable component. Since its brightness gradually decreases over time, it is necessary to replace the lamp unit regularly.

Please refer to the displayed time in [Lamp counter] of [Info.] about the usage time of lamp (➔ page 73).

The estimated duration before replacement is 6 000 hours which is displayed in [Lamp counter], but the lamp may go off before the time above mentioned has elapsed depending on individual lamp characteristics, usage conditions, and the installation environment. It is recommended that the Replacement lamp unit be prepared earlier.

The time which is displayed in [Lamp counter] is a total time when the real usage time in [ (Normal)], [ (Eco 1)] or [ (Eco 2)] is converted to the runtime in [ (Eco 1)]. Please note that they are not displayed individually.

The displayed time in [Lamp counter] = “Lamp runtime of [ (Normal)]” × 1.2 + “Lamp runtime of [ (Eco 1)]”
+ “Lamp runtime of [ (Eco 2)]” × 0.75





The real usage time when the displayed time in [Lamp counter] is 6 000 hours means,

When [Lamp control] is constantly set to [ (Normal)] without switching to other modes = 5 000 hours

When [Lamp control] is constantly set to [ (Eco 1)] without switching to other modes = 6 000 hours

When [Lamp control] is constantly set to [ (Eco 2)] without switching to other modes = 8 000 hours

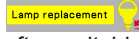
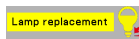
If you continue to use the lamp unit after the displayed time in [Lamp counter] 6 600 hours has elapsed, the lamp turns off automatically at approximately 10 minutes after turning on the power, as it will cause malfunction of the projector.

The displayed time in [Lamp counter]	On-screen display	<WARNING> indicator
Over 5 700 hours less than 6 000 hours	<ul style="list-style-type: none"> The lamp replacement icon  is displayed for 10 seconds. If you press any button within 10 seconds, the icon disappears. The lamp replacement icon  will display for 4 seconds on the screen after switching the input source or turning on the projector. 	--
Over 6 000 hours less than 6 600 hours	<ul style="list-style-type: none"> The lamp replacement warning icon  is displayed for 10 seconds. If you press any button within 10 seconds, the icon disappears. The lamp replacement warning icon  will display for 4 seconds on the screen after switching the input source or turning on the projector. 	Lighting in red. (The indicator will not light in the standby mode)
Over 6 600 hours	<ul style="list-style-type: none"> The lamp replacement warning icon  is displayed for 10 seconds. If you press any button within 10 seconds, the icon disappears. The lamp replacement warning icon  will display for 4 seconds on the screen after switching the input source or turning on the projector. The lamp automatically turns off at approximately 10 minutes after turning on the power. 	Blinking in red. (The indicator will not light in the standby mode)

Note

- The lamp replacement icon or lamp replacement warning icon will not be displayed when during "Freeze" or "AV mute".
- The usage period of 6 000 hours which is displayed in [Lamp counter] is a rough estimate and is not guaranteed.

Replacing the Lamp unit

Attention

- When the projector is mounted on a ceiling, do not work with your face close to the projector.
- Do not remove or loosen the screws other than specified ones when replacing the lamp unit.
- Make sure to attach the lamp unit and the lamp cover securely.

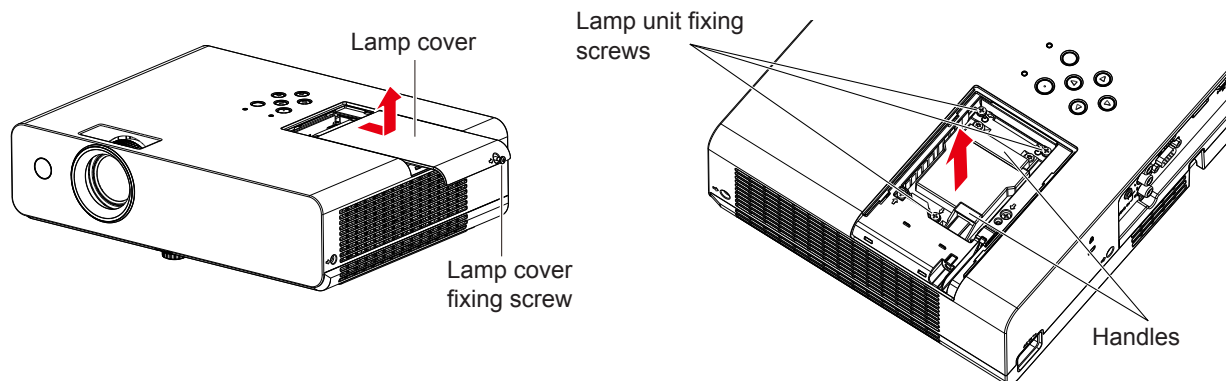

- 1) Turn off the power by following the procedure in "Powering Off the Projector" (⇒ page 36). Remove the AC power plug from the wall outlet.
 - Wait at least 1 hour and make sure the lamp unit and surroundings are cool.
- 2) Use a Phillips screwdriver to loosen the lamp cover fixing screw (×1) until it turns freely and remove the lamp cover.
 - Remove the lamp cover by pulling it slowly toward the direction of the arrow as the above figure shown.
- 3) Use a Phillips screwdriver to loosen the three lamp unit fixing screws (×3) until they turn freely.
- 4) Hold the used lamp unit by its handles, and pull it gently from the projector.
- 5) Insert the new lamp unit in correct direction. Tighten the three lamp unit fixing screws (×3) securely with a Phillips screwdriver.
 - When you experience difficulty in installing the lamp unit, remove it and try again. If you use force to install the lamp unit, the connector may be damaged.
- 6) Attach the lamp cover. Tighten the lamp cover fixing screw (×1) securely with a Phillips screwdriver.

- Perform step 2) in reverse direction to attach the lamp cover.

Resetting the lamp counter

Be sure to reset the lamp counter after replacing the lamp unit.

- 1) **Connect the power plug, press the power <⏻/> button on the control panel or on the remote control.**
- 2) **While pressing the ▲ button on the control panel, press and hold the <INPUT/ENTER> button on the control panel for 8 seconds or more.**
 - The lamp counter will be reset to 0. (At this time, there is displaying nothing.)
- 3) **Press the <INFO.> button on the remote control.**
 - The [Info.] screen is displayed.
 - To make sure that the display of the [Lamp counter] is reset to [0 H].
 - Please try step 2) again if the lamp counter has not been reset.

Air filter unit

When the dust remains after cleaning, the filter replacement timing has come.

The Replacement Filter Unit (Model No.: ET-RFL300) is an optional accessory. To purchase the product, consult your dealer.

Replacing the air filter unit

Attention

- Make sure to turn off the power before replacing the air filter unit.
 - Make sure that the projector is stable, and perform the replacement in a safe place where the unit will not be damaged even if you drop the air filter unit.
- 1) **Remove the air filter cover.**
 - Refer to “Removing the air filter unit” (➔ page 86).
 - 2) **Remove the air filter unit.**
 - Refer to “Removing the air filter unit” (➔ page 86).
 - 3) **Attach the optional Replacement Filter Unit (Model No.: ET-RFL300) to the air filter cover.**
 - Refer to “Attaching the air filter unit” (➔ page 87).
 - 4) **Attach the air filter cover to the projector.**
 - Refer to “Attaching the air filter unit” (➔ page 87).
 - 5) **Reset the filter counter.**
 - Refer to “Resetting the filter counter” (➔ page 87).

Attention

- When using the projector, be sure to attach the air filter unit. If it is not attached, the projector will suck in dirt and dust causing a malfunction.
- The air filter unit to be replaced should be an unused product.

Note

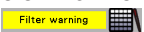
- The replacement cycle of the air filter unit varies greatly depending on the usage environment.
- After replacing the air filter, reset the filter counter. Otherwise, the warning icon  will appear on screen.

Troubleshooting

Please check following points. For details, see the corresponding pages.

Problem	Cause	Reference page
Power does not turn on.	<ul style="list-style-type: none"> The power cord may not be connected. No electric supply is at the wall outlet. The circuit breakers have tripped. Is the power indicator <ON(G)/STANDBY(R)> or the warning indicator <WARNING > indicator lit or blinking? The lamp cover has not been securely installed. 	— — — 84 89
No picture appears.	<ul style="list-style-type: none"> The video signal input source may not be connected to a terminal properly. The input selection setting may not be correct. The [Brightness] adjustment setting may be at the minimum setting. The input source which is connected to the projector may have a problem. The AV mute function may be in use. 	30 - 32 38, 48 52 — 40
The picture is fuzzy.	<ul style="list-style-type: none"> The lens focus may not have been set correctly. The projector may not be at the correct distance from the screen. The lens may be dirty. The projector may be tilted too much. 	37 26 - 28 16 —
The color is pale or grayish.	<ul style="list-style-type: none"> [Color] or [Tint] adjustment may be incorrect. The input source which is connected to the projector may not be adjusted correctly. RGB cable is damaged. 	53 — —
No sound from the internal speaker.	<ul style="list-style-type: none"> The input terminals may not have been correctly connected. The volume may have been set to the minimum level. The AV mute function may have been turned on. When the VARIABLE AUDIO OUT is plugged-in, the projector's built-in speaker is not available. The Mute function may have been turned on. 	31 - 32 41, 57 40 30 - 32 42, 58
The remote control does not operate.	<ul style="list-style-type: none"> The batteries may be weak. The batteries may not have been inserted correctly. The remote control signal receptor on the projector may be obstructed. The remote control unit may be out of the operation range. Strong light such as fluorescent shine onto the signal receptor. Is the operation of the remote control set to disabled in [Key lock] of the [Setting] menu? When different codes are set on the projector and on the remote control. 	— 23 20 20 20 57 23
The control buttons of the projector do not operate.	<ul style="list-style-type: none"> Is the operation of the control panel set to disabled in [Key lock] of the [Setting] menu? 	57
The picture does not display correctly.	<ul style="list-style-type: none"> There may be a problem with the VCR or other signal source. A signal which is not compatible with the projector is being input. 	— 97 - 98
Picture from a computer does not appear.	<ul style="list-style-type: none"> The cable may be longer than the optional cable. The external video output from a laptop computer may not be correct. 	— —
Picture from a HDMI device does not appear or picture is not stable.	<ul style="list-style-type: none"> Is the HDMI cable securely connected? Turn off the power of the projector and the connected devices. Then turn the power of the projector and the connected devices back on. Isn't unsupported signal cable connected? 	30 - 32 — 97 - 98
No sound is output from a HDMI device.	<ul style="list-style-type: none"> Set the sound channel of the attached device to Linear PCM. Connect the computer to the <HDMI IN> terminal through the HDMI-DVI conversion cable, set [Sound] of [HDMI Setup] to [Computer], and then input the analog audio signal to the <AUDIO IN 1> terminal. 	— 58
The  mark appears on the screen.	<ul style="list-style-type: none"> To inform that the projector cannot execute the operation. Check the connections and the input signals, then operate correctly. 	—

Attention

- If the problem persists, after confirming the contents of the table, please consult your dealer.

Chapter 6 Appendix

This chapter describes specifications and after-sales service for the projector.

Technical Information

PJLink protocol

The network function of the projector supports PJLink class 1, and the PJLink protocol can be used to perform projector setting and projector status query operations from a computer.

Control commands

The following table lists the PJLink protocol commands that can be used to control the projector.

- x characters in tables are non-specific characters.

Command	Control details	Parameter / return string	Remark		
POWR	Power supply control	0 1	Standby Power on		
POWR ?	Power supply status query	0 1 2 3	Standby Power on Cool-down in progress Warm-up in progress		
INPT	Input selection	11 12 21 22	RGB 1 RGB 2 VIDEO S-VIDEO COMPONENT HDMI MEMORY VIEWER USB DISPLAY		
INPT ?	Input selection query	23 31 41 51			
AVMT	AV mute/Mute control	10 11 20	Video mute off Video mute on Audio mute off Audio mute on AV mute off AV mute on		
AVMT ?	AV mute/Mute status query	21 30 31			
ERST ?	Error status query	xxxxxx	1st byte	Fixed at 0	<ul style="list-style-type: none"> • 0 = No error known • 1 = Warning • 2 = Error
			2nd byte	Indicates lamp errors, range 0 – 2	
			3rd byte	Indicates temperature errors, range 0 – 2	
			4th byte	Fixed at 0	
			5th byte	Fixed at 0	
			6th byte	Fixed at 0	
LAMP ?	Lamp status query	xxxxxxxxxxxx	1st digits (1 – 5 digits) : Lamp cumulative operating time 2nd digit : 0 = Lamp off, 1 = Lamp on		
INST ?	Input selection list query	11 12 21 22 23 31 41 51			
NAME ?	Projector name query	PROJECTOR			
INF1 ?	Manufacturer name query	Panasonic	Returns manufacturer name.		
INF2 ?	Model name query	PT-LW330 / PT-LW280 / PT-LB360 / PT-LB330 / PT-LB300 / PT-LB280	Returns model name.		
INF0 ?	Other information query	xxxxx	Returns information such as version number.		
CLSS ?	Class information query	1	Returns class for PJLink.		

PJLink security authorization

The password used for PJLink is the same as that of the password set for web control.

When using the projector without security authentication, do not set a password for web control.

- For specifications related to PJLink, refer to the website of Japan Business Machine and Information System Industries Association.

URL <http://pjlink.jbmia.or.jp/english/>

<SERIAL IN> terminal

The <SERIAL IN> terminal of the projector conforms with RS-232C so that the projector can be connected to and controlled from a computer.

Connection

Connecting terminals on projector

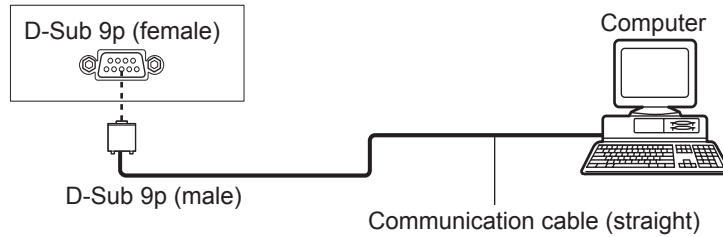

Pin assignments and signal names

D-Sub 9-pin (female) Outside view	Pin No.	Signal name	Contents
	①	—	NC
	②	TXD	Transmitted data
	③	RXD	Received data
	④	—	NC
	⑤	GND	Earth
	⑥	—	NC
	⑦	CTS	Connected internally
	⑧	RTS	
	⑨	—	NC

Communication conditions (Factory default)

Signal level	RS-232C-compliant
Sync. method	Asynchronous
Baud rate	19 200 bps
Parity	None
Character length	8 bits
Stop bit	1 bit
X parameter	None
S parameter	None

Basic format

Transmission from the computer starts with STX, then the command, parameter, and ETX are sent in this order. Add parameters according to the details of control.

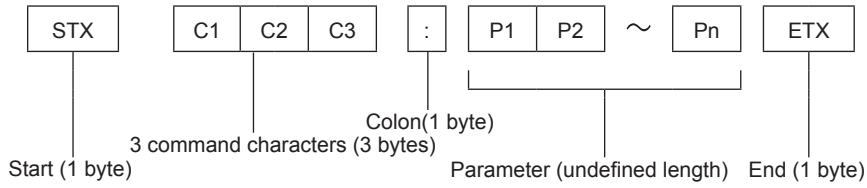

Basic format (with sub command)

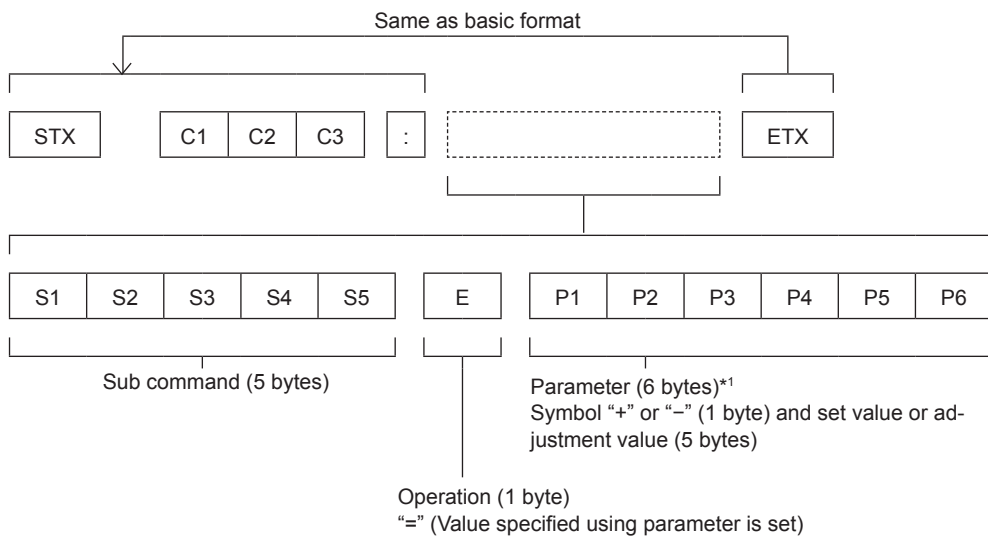

*1 When transmitting a command which does not need a parameter, the operation (E) and parameter are not necessary.

Attention

- If a command is transmitted after the lamp starts illuminating, there may be a delay in response or the command may not be executed. Try sending or receiving any command after 60 seconds.
- When transmitting multiple commands, be sure to wait until 0.5 seconds has elapsed after receiving the response from the projector before sending the next command. When transmitting a command which does not need a parameter, a colon (:) is not necessary.

Note

- If a command cannot be executed, the "ER401" response is sent from the projector to the computer.
- If an invalid parameter is sent, the "ER402" response is sent from the projector to the computer.
- STX and ETX are character codes. STX shown in hexadecimal is 02, and ETX shown in hexadecimal is 03.

Cable specifications

[When connected to a computer]

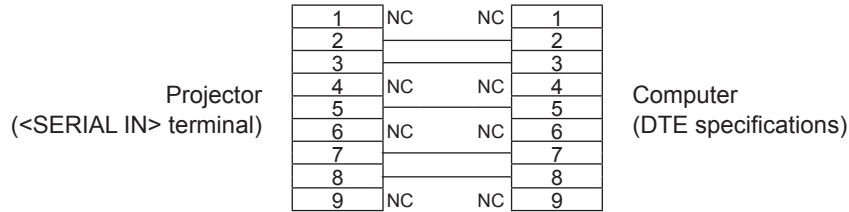

Control commands

When controlling the projector from a computer, the following commands are available.

■ Projector control command

Command	Control contents	Parameter/return string	Remark (parameter)
PON	Power on	—	To check if the power is on, use the “Power query” command.
POF	Power standby		
IIS	Switching the input signal	VID SVD RG1 RG2 HD1 CP1 MV1 UD1	VIDEO S-VIDEO RGB1 RGB2 HDMI COMPONENT MEMORY VIEWER USB DISPLAY
AUU	Volume up		
AUD	Volume down		
OSH	AV mute function	—	Sending the command switches on/off. Do not switch on/off in a short period of time.
AMT	Mute function	0	Off
		1	On
QPW	Power query	000	Standby
		001	Power on
Q\$\$	Lamp condition query	0	Stand-by
		1	Lamp ON control active
		2	Lamp ON
		3	Lamp OFF control active

List of compatible signals

The following table specifies the type of signals compatible with the projectors.

- Symbols that indicate formats are as follows.

V = VIDEO/S-VIDEO, R = RGB, Y = YC_BC_R/YP_BP_R, H = HDMI

Mode	Display resolution (dots)	Scanning frequency		Dot clock frequency (MHz)	Format*1	PnP *2	
		H (kHz)	V (Hz)			Computer 1/ Computer 2	HDMI
NTSC/NTSC4.43/ PAL-M/PAL60	720 x 480i	15.7	59.9	--	V	--	--
PAL/PAL-N/ SECAM	720 x 576i	15.6	50.0	--	V	--	--
525i (480i)	720 x 480i	15.7	59.9	13.5	R/Y	--	--
625i (576i)	720 x 576i	15.6	50.0	13.5	R/Y	--	--
525i (480i)	720 (1 440) x 480i*3	15.7	59.9	27.0	H	--	✓
625i (576i)	720 (1 440) x 576i*3	15.6	50.0	27.0	H	--	✓
525p (480p)	720 x 483	31.5	59.9	27.0	R/Y/H	--	✓
625p (576p)	720 x 576	31.3	50.0	27.0	R/Y/H	--	✓
750 (720) /60p	1 280 x 720	45.0	60.0	74.3	R/Y/H	--	✓
750 (720) /50p	1 280 x 720	37.5	50.0	74.3	R/Y/H	--	✓
1125 (1080) /60i	1 920 x 1 080i	33.8	60.0	74.3	R/Y/H	--	✓
1125 (1080) /50i	1 920 x 1 080i	28.1	50.0	74.3	R/Y/H	--	✓
1125 (1080) /24p	1 920 x 1 080	27.0	24.0	74.3	R/Y/H	--	✓
1125 (1080) /24sF	1 920 x 1 080i	27.0	48.0	74.3	R/Y/H	--	--
1125 (1080) /25p	1 920 x 1 080	28.1	25.0	74.3	R/Y/H	--	--
1125 (1080) /30p	1 920 x 1 080	33.8	30.0	74.3	R/Y/H	--	--
1125 (1080) /60p	1 920 x 1 080	67.5	60.0	148.5	R/Y/H	--	✓
1125 (1080) /50p	1 920 x 1 080	56.3	50.0	148.5	R/Y/H	--	✓
VGA	640 x 480	31.5	59.9	25.2	R/H	✓	✓
	640 x 480	35.0	66.7	30.2	R/H	--	--
	640 x 480	37.9	72.8	31.5	R/H	✓	✓
	640 x 480	37.5	75.0	31.5	R/H	✓	✓
	640 x 480	43.3	85.0	36.0	R/H	--	--
SVGA	800 x 600	35.2	56.3	36.0	R/H	✓	✓
	800 x 600	37.9	60.3	40.0	R/H	✓	✓
	800 x 600	48.1	72.2	50.0	R/H	✓	✓
	800 x 600	46.9	75.0	49.5	R/H	✓	✓
	800 x 600	53.7	85.1	56.3	R/H	--	--
MAC 16	832 x 624	49.7	74.6	57.3	R/H	✓	✓
XGA	1 024 x 768	48.4	60.0	65.0	R/H	✓	✓
	1 024 x 768	56.5	70.1	75.0	R/H	✓	✓
	1 024 x 768	60.0	75.0	78.8	R/H	--	--
	1 024 x 768	68.7	85.0	94.5	R/H	--	--
MXGA	1 152 x 864	67.5	74.9	108.0	R/H	--	--
MAC 21	1 152 x 870	68.7	75.1	100.0	R/H	✓	✓
1280 x 720	1 280 x 720	37.1	49.8	60.5	R/H	--	--
	1 280 x 720	44.8	59.9	74.5	R/H	--	--
1280 x 768	1 280 x 768	47.8	59.9	79.5	R/H	--	--
	1 280 x 768	60.3	74.9	102.3	R/H	--	--
	1 280 x 768	68.6	84.8	117.5	R/H	--	--
1280 x 800	1 280 x 800	41.3	50.0	68.0	R/H	--	--
	1 280 x 800	49.7	59.8	83.5	R/H	✓	✓
	1 280 x 800	62.8	74.9	106.5	R/H	--	--
	1 280 x 800	71.6	84.9	122.5	R/H	--	--

Chapter 6 Appendix - Technical Information

Mode	Display resolution (dots)	Scanning frequency		Dot clock frequency (MHz)	Format* ¹	PnP * ²	
		H (kHz)	V (Hz)			Computer 1/ Computer 2	HDMI
MSXGA	1 280 x 960	60.0	60.0	108.0	R/H	✓	✓
SXGA	1 280 x 1 024	64.0	60.0	108.0	R/H	✓	✓
	1 280 x 1 024	78.2	72.0	135.1	R/H	--	--
	1 280 x 1 024	80.0	75.0	135.0	R/H	✓	✓
	1 280 x 1 024	91.1	85.0	157.5	R/H	--	--
1366 x 768	1 366 x 768	39.6	49.9	69.0	R/H	--	--
	1 366 x 768	47.7	59.8	84.8	R/H	--	--
SXGA +	1 400 x 1 050	65.3	60.0	121.8	R/H	--	--
	1 400 x 1 050	82.3	74.9	156.0	R/H	--	--
WXGA +	1 440 x 900* ⁴	55.9	59.9	106.5	R/H	--	--
1600 x 900	1 600 x 900	55.9	60.0	119.0	R/H	--	--
UXGA	1 600 x 1200	75.0	60.0	162.0	R/H	✓	✓
WSXGA +	1 680 x 1 050	65.3	60.0	146.3	R/H	--	--
1920 x 1080	1 920 x 1 080* ⁴	66.6	59.9	138.5	R/H	--	--
WUXGA	1 920 x 1 200* ⁴	74.0	60.0	154.0	R/H	--	--

*1 <COMPUTER 2 IN> terminal is only for RGB signals input.

*2 Where marked "✓" signals indicates in Plug and Play is compatible with EDID of projector. Unmarked signals in Plug and Play may also be compliant if input terminals are written in the format list. Where Plug and Play is unmarked and nothing is written in the format list, difficulties in projecting image may occur even when computer and projector appear to have same resolution.

*3 Pixel-Repetition signal (dot clock frequency 27.0 MHz) only.

*4 VESA CVT-RB (Reduced Blanking)-compliant.

Note

- The number of display dots is 1 280 x 800 for the PT-LW330 and PT-LW280 and 1 024 x 768 for the PT-LB360, PT-LB330, PT-LB300 and PT-LB280.
A signal with a different resolution will be projected after converting the resolution to match the projector display.
- "i" added to the resolution value indicates an interlaced signal.
- When interlaced signals are connected, flicker may occur on the projected image.

Specifications

The specifications of the projector are as follows.



Power supply		AC100 V - 240 V, 50 Hz/60 Hz	
Power consumption		100 V - 240 V, ~ 3.5 A, 300 W When [Standby mode] of [Setting] is set to [Eco]: 0.5 W When [Standby mode] of [Setting] is set to [Normal]: 6 W	
LCD panel	Panel size	PT-LW330, PT-LW280	1.5 cm (0.59") (aspect ratio 16 : 10)
		PT-LB360, PT-LB330, PT-LB300, PT-LB280	1.6 cm (0.63") (aspect ratio 4 : 3)
	Display method	3 transparent LCD panels (RGB)	
	Drive method	Active matrix method	
	Pixels	PT-LW330, PT-LW280	1 024 000 pixels (1 280 x 800 dots) x 3 panels
		PT-LB360, PT-LB330, PT-LB300, PT-LB280	786 432 pixels (1 024 x 768 dots) x 3 panels
Lens	Zoom	1.2 x	
	Focus	PT-LW330, PT-LB360, PT-LB330	F 1.6 ~ 1.76, f 19.16 mm ~ 23.02 mm
PT-LW280, PT-LB300, PT-LB280		F 2.1 ~ 2.25, f 19.11 mm ~ 22.94 mm	
Luminous lamp		230 W UHM lamp	
Light output *1	PT-LB360	3 700 lm	
	PT-LW330, PT-LB330	3 300 lm	
	PT-LW280, PT-LB280	2 800 lm	
	PT-LB300	3 100 lm	
Contrast ratio *1		10 000 : 1 (When [Lamp control] is set to [ (Normal)], [Image mode] is set to [Dynamic] and [Iris] is set to [On].)	
Applicable scanning frequency *2	for Video signal (including S-video)	Horizontal : 15.73 kHz, Vertical : 59.94 Hz, Horizontal : 15.63 kHz, Vertical : 50.00 Hz	
	for RGB signal	Horizontal 15 kHz - 91 kHz, Vertical 24 Hz - 85 Hz	
		Dot clock frequency: 162 MHz or less	
	for YP_BP_R signal	525i(480i)	Horizontal 15.73 kHz, Vertical 59.94 Hz
625i(576i)		Horizontal 15.63 kHz, Vertical 50 Hz	
525p(480p)		Horizontal 31.47 kHz, Vertical 59.94 Hz	
625p(576p)		Horizontal 31.25 kHz, Vertical 50 Hz	
750(720)/60p		Horizontal 45.00 kHz, Vertical 60 Hz	
750(720)/50p		Horizontal 37.50 kHz, Vertical 50 Hz	
1125(1080)/60i		Horizontal 33.75 kHz, Vertical 60 Hz	
1125(1080)/50i		Horizontal 28.13 kHz, Vertical 50 Hz	
1125(1080)/60p		Horizontal 67.50 kHz, Vertical 60 Hz	
1125(1080)/50p		Horizontal 56.25 kHz, Vertical 50 Hz	
1125(1080)/24p		Horizontal 27.00 kHz, Vertical 24 Hz	
1125(1080)/24sF		Horizontal 27.00 kHz, Vertical 48 Hz	
1125(1080)/25p	Horizontal 28.13 kHz, Vertical 25 Hz		
1125(1080)/30p	Horizontal 33.75 kHz, Vertical 30 Hz		
HD/SYNC and V terminals are not compliant with 3 value composite SYNC			
for HDMI signal	525i(480i), 625i(576i), 525p(480p), 625p(576p), 750(720)/60p, 750(720)/50p, 1125(1080)/24p, 1125(1080)/24sF, 1125(1080)/25p, 1125(1080)/30p, 1125(1080)/60p, 1125(1080)/50p, 1125(1080)/60i, 1125(1080)/50i		
	Displayable resolution: VGA - WUXGA (non-interlace), VESA CVT-RB-compliant Dot clock frequency: 162 MHz or less		
Color system		7 (NTSC, NTSC4.43, PAL, PAL-N, PAL-M, SECAM, PAL60)	
Projection size		0.76 m - 7.62 m (30" - 300")	
Screen aspect ratio	PT-LW330, PT-LW280	16 : 10	
	PT-LB360, PT-LB330, PT-LB300, PT-LB280	4 : 3	

*1 Measurement, measuring conditions and method of notation all comply with ISO21118 international standards.

*2 For details of video signals that can be projected using this projector, refer to "List of compatible signals".

(➡ pages 97 - 98)

Chapter 6 Appendix - Specifications

Projection scheme		[Front], [Rear], [Ceiling/Front], [Ceiling/Rear] (Menu setting system)	
Built-in speaker		PT-LW330, PT-LW280, PT-LB360, PT-LB330	10 W (monaural) x 1
		PT-LB300, PT-LB280	2 W (monaural) x 1
Terminals	<COMPUTER 1 IN>	1 (High-density D-sub 15 pin female) [RGB signal] 0.7 V [p-p] 75 Ω (When G-SYNC: 1.0 V [p-p] 75 Ω) HD/SYNC TTL high impedance, automatic positive/negative polarity compatible VD TTL high impedance, automatic positive/negative polarity compatible [Y _P P _R signal] Y: 1.0 V [p-p] including synchronization signal, P _B P _R : 0.7 V [p-p] 75 Ω [Y/C signal] Y: 1.0 V [p-p] C: 0.286 V [p-p] 75 Ω S1 signal compatible	
	<COMPUTER 2 IN/1 OUT>*3	1 (High-density D-sub 15 pin female) (Input/Output switching) [RGB signal] 0.7 V [p-p] 75 Ω (When G-SYNC: 1.0 V [p-p] 75 Ω) HD/SYNC TTL high impedance, automatic positive/negative polarity compatible VD TTL high impedance, automatic positive/negative polarity compatible	
	<VIDEO IN>	1 (Pin jack 1.0 V [p-p] 75 Ω)	
	<HDMI IN>	1 (HDMI 19 pin, HDCP and Deep color compatible) Audio signals: Linear PCM (Sampling frequency: 48 kHz/44.1 kHz/32 kHz)	
	<AUDIO IN>	1 (M3 stereo mini jack, 0.5 V [rms], input impedance 22 kΩ and more) 1 (Pin jack x 2 (L-R), 0.5 V [rms], input impedance 22 kΩ and more)	
	<VARIABLE AUDIO OUT>	1 (M3 stereo mini jack, stereo monitor output compatible, 0 V [rms] to 2.0 V [rms] variable, output impedance 2.2 kΩ and less)	
	<USB A/VIEWER>*4	USB connector (type A x 1, output DC 5V, 500mA maximum)	
	<USB B/DISPLAY>*5	USB connector (type B x 1)	
	<SERIAL IN>	1 (D-sub 9 pin, RS-232C compliant, for computer control use)	
<LAN>*4	1 (for RJ-45 network connection, PLink compatible, 10Base-T/100Base-TX)		
Power cable length		1.8 m (70-7/8")	
Cabinet		Molded plastic	
Dimensions		Width: 335 mm (13-3/16") Height: 96 mm (3-25/32") (when adjustable foot shortened) Depth: 252 mm (9-29/32")	
Weight		Approx. 2.8 kg (6.17 lbs.) *6	
Noise level *7		When set to [ (Normal)] in [Lamp control] : 37 dB When set to [ (Eco 1)] in [Lamp control] : 33 dB When set to [ (Eco 2)] in [Lamp control] : 28 dB	
Operating environment	Operating environment temperature *8	5 °C (41 °F) to 40 °C (104 °F) (Elevation: below 1 400 m (4 593'); [High land]: [Off]) 5 °C (41 °F) to 35 °C (95 °F) (Elevation: 1 400 m (4 593') ~ 2 700 m (8 858'); [High land]: [On])	
	Operating environment humidity	20 % to 80 % (no condensation)	
Remote control	Power supply	DC 3 V (AAA/R03/LR03 battery x 2)	
	Operating range	Approx. 5 m (16'4-13/16") (when operated directly in front of receptor)	
	Weight	63 g (2.22 ozs.) (including batteries)	
	Dimensions	Width : 44 mm (1-23/32"), Length : 105 mm (4-1/8"), Height : 20.5 mm (13/16")	

*3 The <MONITOR OUT> terminal is only for PT-LB300 and PT-LB280.

*4 This terminal is only for PT-LW330, PT-LW280, PT-LB360 and PT-LB330.

*5 The <USB> terminal is only for PT-LB300 and PT-LB280.

*6 This is an average value. It may differ depending on individual product.

*7 Measurement, measuring conditions and method of notation all comply with ISO21118 international standards.

*8 [Lamp control] will be switched to [ (Eco 1)] automatically when the operating environment temperature is 35 °C to 40 °C.

Note

- The part numbers of accessories and separately sold components are subject to change without notice.

Dimensions

<Unit : mm (inch)>

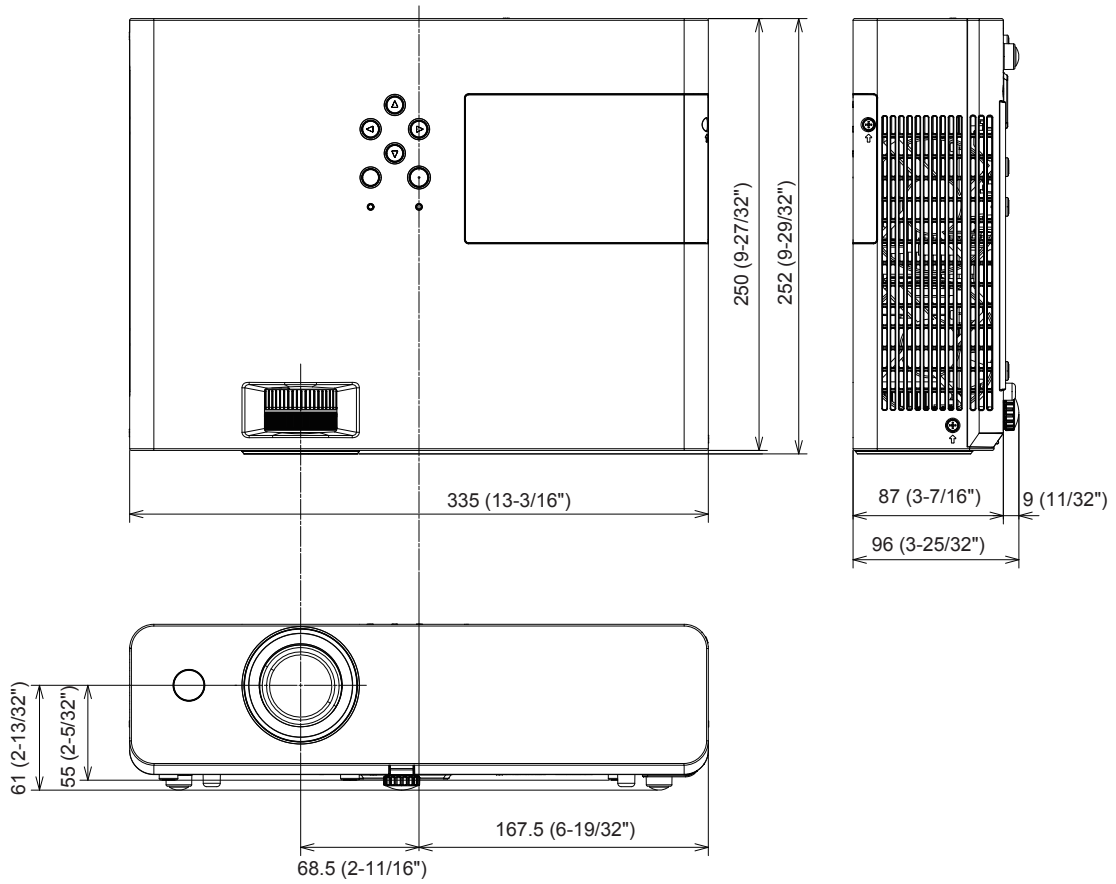

* Actual dimension may differ by product.

Ceiling mount bracket safeguards

- When installing the projector to a ceiling, be sure to use the specified optional Ceiling Mount Bracket for Projectors. Model No.: ET-PKL100H (for high ceilings), ET-PKL100S (for low ceilings), ET-PKL420B (Projector Mount Bracket)
- When installing the projector, attach the drop-prevention kit included with the Ceiling Mount Bracket for Projectors.
- Ask a qualified technician to do the installation work such as mounting the projector on the ceiling.
- Panasonic takes no responsibility for any damage to the projector resulting from use of a ceiling mount bracket not manufactured by Panasonic or the inappropriate choice of location for installation, even if the warranty period of the projector has not expired.
- Unused products must be removed promptly by a qualified technician.
- Use a torque screwdriver or Allen torque wrench to tighten bolts to their specified tightening torques. Do not use electric screwdrivers or impact screwdrivers.
- Read the Installation Instructions for the Ceiling Mount Bracket for Projectors for details.
- The model numbers of accessories and optional accessories are subject to change without prior notice.

Bottom View

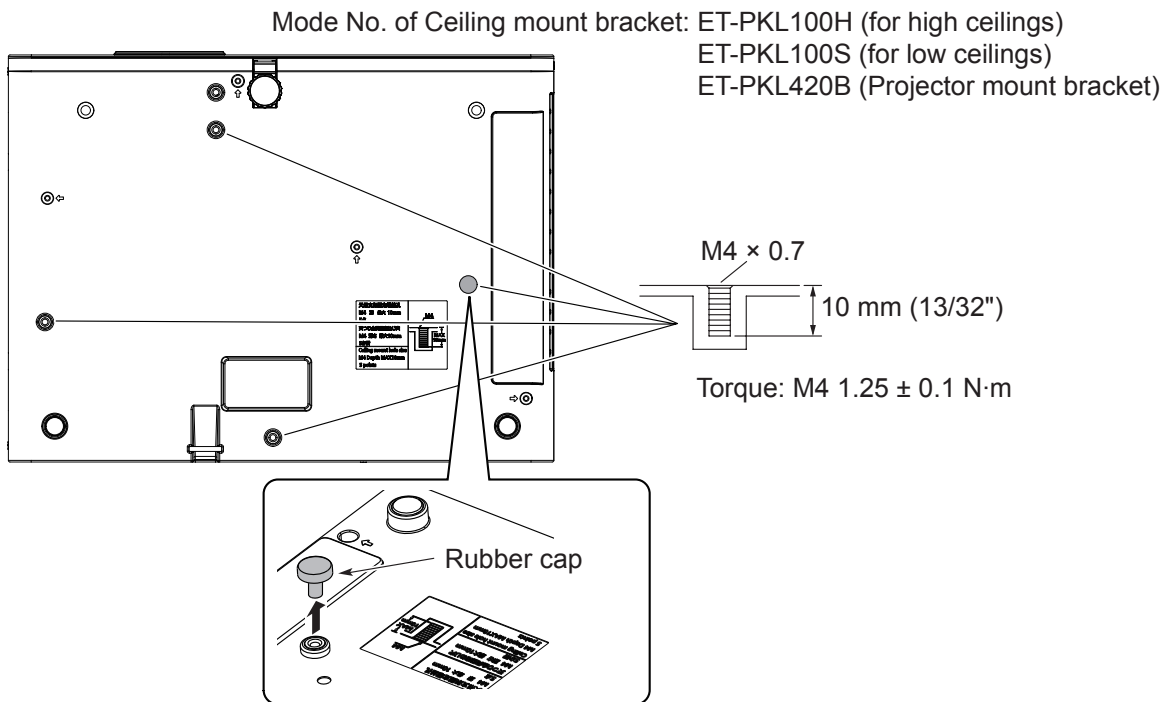

Attention

- The above figure shows the attaching of the rubber cap to the fixing screw hole of the ceiling mount bracket. Before installing the ceiling mount bracket, remove the rubber cap first and then attach the projector mount bracket.
- If the projector will be used for the desktop instead of for the ceiling, the rubber cap will be necessary to prevent burning. Save it for future use.
- When ceiling mounting is not needed, please do not touch or remove the rubber cap in order to prevent burning.