



Owner's Manual

DLP PROJECTOR

Please read the safety information carefully before using the product.

BC775

ProSelecta

View :: Compare :: Select - www.ProSelecta.com

LICENSE

Supported licenses may differ by model. For more information about licenses, visit www.lg.com.



Manufactured under license from Dolby Laboratories. Dolby and the double-D symbol are trademarks of Dolby Laboratories.



ABOUT DIVX VIDEO: DivX® is a digital video format created by DivX, LLC, a subsidiary of Rovi Corporation. . This is an official DivX Certified® device that plays DivX video. Visit divx.com for more information and software tools to convert your files into DivX video.

ABOUT DIVX VIDEO-ON-DEMAND: This DivX Certified® device must be registered in order to play purchased DivX Video-on-Demand (VOD) movies. To obtain your registration code, locate the DivX VOD section in your device setup menu. Go to vod.divx.com for more information on how to complete your registration.

“DivX Certified® to play DivX® video up to HD 1080p, including premium content.”

“DivX®, DivX Certified® and associated logos are trademarks of Rovi Corporation or its subsidiaries and are used under license.”

“Covered by one or more of the following U.S. patents : 7,295,673; 7,460,668; 7,515,710; 7,519,274”



The terms HDMI and HDMI High-Definition Multimedia Interface, and the HDMI logo are trademarks or registered trademarks of HDMI Licensing LLC in the United States and other countries.

This equipment complies with EMC requirements for home use (Class B). It is designed to be used mainly in homes but may be used in all places.

NOTE

- The product images and on-screen display (OSD) in this manual are examples to help you understand how to operate the product; they may differ from the actual product.

SAFETY PRECAUTIONS

Please take note of the safety instructions to prevent any potential accident or misuse of the product.

- Safety precautions are provided in two forms: **WARNING** and **CAUTION**. These are detailed below.

 **WARNING:** Failure to follow the instructions may cause serious injury and even death.

 **WARNING (Do not touch the hot surface):** Failure to follow the instructions may cause burns.

 **CAUTION:** Failure to follow the instructions may cause minor injury to persons or damage to the product.

- Read the owner's manual carefully and keep it for future use.



WARNING/CAUTION

RISK OF ELECTRIC SHOCK

DO NOT OPEN



The lightning flash with arrowhead symbol, within an equilateral triangle, is intended to alert the user to the presence of uninsulated “dangerous voltage” within the product’s enclosure that may be of sufficient magnitude to constitute a risk of electric shock to persons.

The exclamation point within an equilateral triangle is intended to alert the user to the presence of important operating and maintenance(servicing) instructions in the literature accompanying the appliance.

WARNING/CAUTION

- TO REDUCE THE RISK OF FIRE AND ELECTRIC SHOCK, DO NOT EXPOSE THIS PRODUCT TO RAIN OR MOISTURE.

Read these instructions.

Keep these instructions.

Heed all warnings.

Follow all instructions.

Indoor Installation

WARNING

- Do not place the projector in direct sunlight or near heat sources, such as radiators, fires, and stoves.
 - Otherwise, this may result in fire.
- Do not place flammable materials, such as aerosols, near the projector.
 - Otherwise, this may result in fire.
- Do not allow children to hang from or climb on the projector.
 - This may cause the projector to fall, causing injury or death.
- Do not install the product into a place with no ventilation (e.g., on a bookshelf or in a closet) or on a carpet or cushion.
 - Doing so may result in a fire due to increased internal temperature.

- Do not place the product close to sources of steam, oil or oil mist, such as humidifiers and kitchen counters.
 - Failure to do so may result in fire, electric shock, or corrosion.
- Do not install the product onto a wall or ceiling that is close to sources of oil or oil mist.
 - The product may be damaged and fall, resulting in serious injury.
- Do not place the projector where it might be exposed to dust.
 - Otherwise, this may result in fire.
- Do not use the projector in a damp place, such as a bathroom where it is likely to get wet.
 - This may cause fire or electric shock.
- Make sure the air vent is not blocked by a tablecloth or curtain.
 - This could result in fire due to increased internal temperature.
- When using the projector, make sure that the air vents (air filters) at the bottom of the product are not blocked.
- Make sure there is good ventilation around the projector. The distance between the projector and wall should be more than 30 cm.
 - Doing so may result in a fire due to increased internal temperature.

 CAUTION

- When placing the projector on a table or shelf, be careful not to put it near the edge.
 - The projector could fall, causing injury and damage to the projector. Only use a suitable stand.
- Disconnect the projector from the power supply and all connected apparatuses before moving or cleaning.

- The power cord may be damaged and create a fire hazard or result in electric shock.
- Do not place the projector on an unstable or vibrating surface, such as a wobbly shelf or on a slope.
 - It may fall and cause injury.
- Make sure that the projector does not fall when connecting it to an external device.
 - It may cause personal injury or damage to the product.

Power

 WARNING

- The ground cable should be connected.
 - Make sure that you connect the ground cable to prevent possible electric shock. If it is not possible to ground the unit, have a qualified electrician install a separate circuit breaker. Do not try to ground the projector by connecting it to telephone wires, lightning rods, or gas pipes.
- The power plug should be inserted fully into the power outlet.
 - An unstable connection may cause fire.
- Do not place heavy objects on the power cord.
 - This may cause fire or electric shock.
- Never touch the power plug with wet hands.
 - This may result in electric shock or fire.
- Do not plug too many devices into one multipower outlet or power strip.
 - This may result in the power outlet overheating and creating a fire hazard.
- Prevent dust from collecting on the power plug pins or outlet.
 - This may result in electric shock or fire.

- To turn off the main power, remove the power plug, which should be positioned so it is easy to access for operation.
- Disconnecting the power cord without allowing the lamp to cool for two minutes after switching off the power may damage the lamp.

CAUTION

- Hold the plug firmly when unplugging.
 - A damaged wire may create a fire hazard.
- Ensure the power cord and plug are not damaged, modified, severely bent, twisted, pulled, sandwiched, or heated. Do not use the product if the power outlet is loose.
 - This may cause fire or electric shock.
- Keep the power cord away from heating devices.
 - The wire coating may melt, which may cause fire or result in electric shock.
- Place the projector where people cannot trip over or walk on the power cord to protect the power cord and plug from damage.
 - This may cause fire or electric shock.
- Do not turn the projector on or off by plugging in the power plug or unplugging it from the wall outlet. (Do not use the power plug as a switch.)
 - This may cause an electric shock or product malfunction.
- Do not insert a conductor into the other side of the wall outlet while the power plug is inserted into the wall outlet. Also, avoid touching the power plug immediately after pulling it out of the wall outlet.
 - This may cause electric shock.
- Only use the authentic power cord provided by LG Electronics. Do not use any other products.
 - This may cause fire or electric shock.

When in Use

WARNING

- Do not place anything containing liquid on top of the projector, such as a flower vase, flower pot, cup, cosmetics, medicine, ornaments, and candles.
 - This may create a fire hazard, result in electric shock, or cause injury due to falling.
- In the event that there is a large impact shock or the cabinet is damaged, switch it off, unplug it from the power outlet, and contact an authorized service center.
 - This may cause fire or electric shock.
- Do not insert pieces of metal, such as coins, hairpins, and metal debris, or flammable materials, such as paper or matches, into the projector.
 - This may cause fire or electric shock.
- In the event that liquid or a foreign object enters into the projector, switch it off, unplug it from the power outlet, and contact an LG Electronics Service Center.
 - This may cause fire or electric shock.
- Make sure that a child does not swallow the batteries when you replace the old remote control batteries with new ones. Keep batteries out of reach of children.
 - If a child swallows a battery, consult a doctor immediately.

- Do not remove any covers, except the lens and dust covers. There is a high risk of electric shock.
- Do not look directly into the lens when the projector is in use. The strong light may injure your eyes.
- When the lamp is on or has just been turned off, avoid touching the air vent or lamp because they are very hot.
- If there is a gas leak, do not touch the power outlet and open the windows for ventilation.
 - Sparks may cause fire or burns.
- Never touch the product or power cord during thunder or lightning.
 - This may cause electric shock.
- Do not use the projector near electronic devices that generate a strong magnetic field.
- Do not cover your head with the packaging plastic of the projector.
 - It may cause suffocation.
- Do not keep your hand on the projector for a long time when it is running.
- When you play a game by connecting a game console to a projector, it is recommended that you maintain a distance of more than four times the diagonal length of the screen.
- Make sure that the length of connecting cable is long enough.
 - Otherwise, the product may fall causing personal injury or damage to the product.
- Do not insert or drop metal and inflammable objects inside the product through the vents.
 - This may result in fire or electric shock.

 WARNING

- Do not touch the lens area of the projector while in use. It is very hot.
 - This may cause burns.

 CAUTION

- Do not place heavy objects onto the product.
 - They may fall and cause injury.
- Be careful to protect the lens from heavy impact during transport.
- Do not touch the lens of the projector. The lens may be damaged.
- Do not use sharp tools on the projector, such as a knife or hammer, as this may damage the casing.
- In the event that no image appears on the screen or no sound is heard, stop using the projector. Switch off the projector immediately, unplug it from the power outlet, and contact the LG Electronics Service Center.
 - This may cause fire or electric shock.
- Do not drop anything onto the projector or allow anything to impact the projector.
 - This may cause mechanical failure or personal injury.
- The distance between the screen and your eyes should be at least five to seven times the diagonal size of the screen.
 - After watching too closely for a long period of time, you may experience blurred vision.

Cleaning

⚠ WARNING

- Do not spray the projector with water when cleaning. Make sure water does not flow into the projector.
 - This may cause fire or electric shock.
- In the unlikely event of smoke or a strange smell coming out from the projector, switch it off immediately, unplug it from the power outlet, and contact the LG Electronics Service Center.
 - Otherwise, it may create a fire hazard or result in electric shock.
- Use an air spray or soft cloth or cotton swab moistened with a lens cleaning chemical or alcohol to remove dust or stains from the front projection lens.

⚠ CAUTION

- Contact the sales representative or service center for internal cleaning of the projector about once a year.
 - If you do not clean the projector, dust will accumulate inside and may create a fire hazard or malfunction.
- When cleaning plastic parts such as the projector case, unplug the power cord first and wipe with a soft cloth. Do not spray with water or wipe with a wet cloth. Never use glass cleaner, automobile or industrial shiner, abrasives or wax, benzene, alcohol, etc.; they can damage the projector.
 - This may create a fire hazard or result in electric shock or product damage (deformation, corrosion, or breakage).

Other

⚠ WARNING

- Only a qualified technician can disassemble or modify the projector. For diagnosis, adjustment, or repair, contact your dealer or service center.
 - This may cause fire or electric shock.
- Do not charge the battery using devices other than the one provided with the product.
 - This may result in damage to the battery or fire.
- Dispose of the used battery properly.
 - Failure to do so may cause explosion or fire. The correct method of disposal may vary depending on your country or region. Dispose of the battery pack according to the appropriate instructions.
- Do not throw or disassemble the battery.
 - Otherwise, this may result in fire or explosion due to damage to the battery.
- Always use batteries approved and certified by LG Electronics.
 - Otherwise, this may result in fire or explosion.
- The lamp contains mercury. Dispose of it in compliance with your local regulations.

- Store the battery away from metal objects, such as keys and paper clips.
 - Excess current may cause rapid increase in temperature, resulting in fire or burns.
 - Do not store the battery near heat sources, such as heaters.
 - Otherwise, this may result in fire or explosion.
 - Do not store the battery at temperatures higher than 60 °C or in high humidity.
 - Otherwise, it may cause explosion or fire.
 - Keep the battery out of reach of children.
 - Otherwise, this may result in personal injury or damage to the product.
 - Make sure that the battery is installed correctly.
 - Otherwise, this may result in fire or explosion.
 - The battery contains lithium ion, so please handle with care.
 - Otherwise, this may result in fire or explosion.
 - Make sure you use the same type of battery for replacement.
 - Incorrect battery replacement may cause fire.
-  CAUTION
- Do not mix new batteries with old ones.
 - Burst or leaking batteries are a fire hazard or may result in electric shock.
 - Be sure to unplug the projector if it will not be used for a long period.
 - Accumulated dust is a fire hazard and may result in electric shock due to overheating, ignition, or poor insulation.
 - Only use the specified type of battery.
 - Burst or leaking batteries are a fire hazard or may result in electric shock.
 - Do not stare directly into lens when in operation, eye damage can occur.
 - No user serviceable parts inside unit. High voltage parts can cause shock and even electrocution.
 - Proper ventilation required, do not block airflow around unit. Doing so can cause injury and internal overheating.
 - To prevent damage to lamp, unit must remain plugged in for approximately 3 minutes after power down to allow for proper cool down (not applicable on LED models).

-
- Do not touch the lens; doing so can result in burns or damage to lens. Lens and unit may be HOT during and immediately after use. Use caution when handling unit, allowing for proper cool down.
 - Only use a grounded electrical outlet.
 - Do not insert anything into or cover up the exhaust vents.
 - Follow all maintenance guidelines for optimal use; service only at an authorized service center.
 - Lamp contains mercury and as such must be disposed of according to local, state and federal laws (not applicable on LED models).

CONTENTS

LICENSE	2	CUSTOMIZING SETTINGS	42
SAFETY PRECAUTIONS	3	Settings	42
PREPARATION	11	PICTURE Settings	43
Accessories	11	AUDIO Settings	47
Optional Accessories	12	TIME Settings	48
Part Name	13	OPTION Settings	49
- Main Unit	13	CONNECTING EXTERNAL	
- Back	14	DEVICES	51
- Control Panel	15	Connecting an HD Receiver, DVD	
Projector Status Indicator	16	Player, or VCR	52
Installation	17	- HDMI Connection	52
- Installation Precautions	17	- HDMI to DVI Connection	52
- Projection Distance per Screen Size	18	Connecting a PC	53
- Kensington Security System	19	- RGB Connection	53
		- RGB to DVI Connection	53
REMOTE CONTROL	20	AV Connection	54
USING THE PROJECTOR	22	- AV Connection	54
Using the Projector	22	- Component Connection	54
- Turning on the Projector	22	Connecting Headphones	55
- Adjusting Focus and Position		Connecting a Laptop	55
of the Screen Image	22	- RGB Connection	55
- Using the Projector	22	MAINTENANCE	56
Replacing the Lamp	23	Cleaning	56
- Replacing the Lamp	23	- Cleaning the Lens	56
- Be careful when replacing the lamp	23	- Cleaning the Projector Case	56
- Purchasing a replacement lamp	23	- Cleaning the Vents	56
- Disposing of lamps	23	Replacing the lamp	57
Additional Options	24	Mounting the Lens Cap	58
- Adjusting the Aspect Ratio	24	SERIAL COMMUNICATION	
- Using the Keystone Function	25	FUNCTION	59
- Using the Input List	25	Using Serial Communication	59
- Blank Function	26	Establishing Serial Communication	59
Using Quick Menu	26	Communication Protocol	60
ENTERTAINMENT	27	Key Code	67
Using SCREEN SHARE	27	SPECIFICATIONS	68
MY MEDIA	28		
- Connecting a USB Device	28		
- Removing a USB Device	28		
- Watching Videos	30		
- Viewing Photos	36		
- Listening to Music	38		
- Viewing Files	39		

PREPARATION

Accessories

Check the accessories provided with the product.
The picture may be different from the actual product.

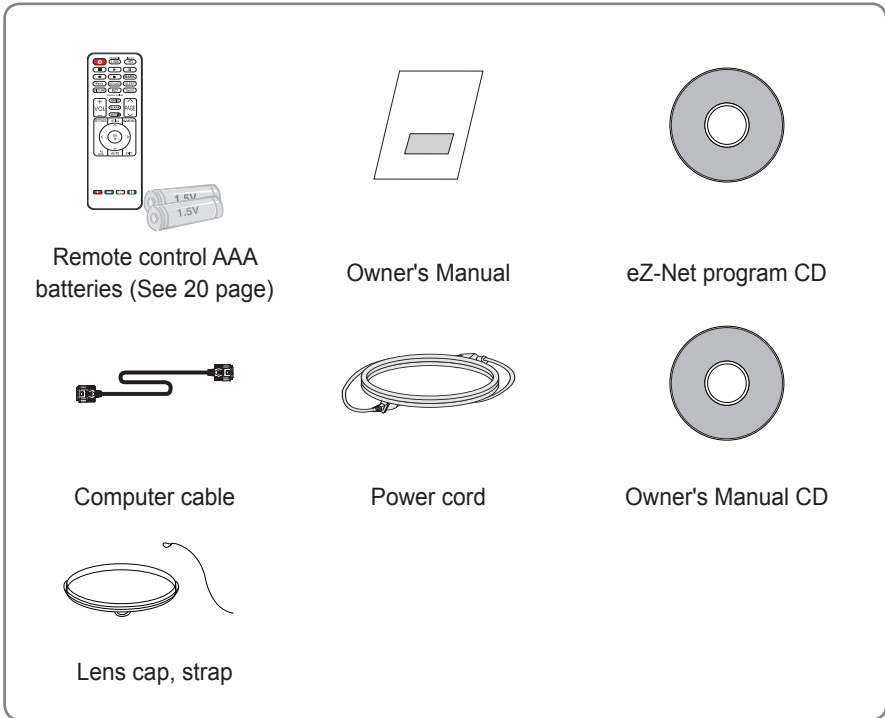

- When connecting a cable to the HDMI or USB port, be sure to use the jack that fits into the USB/HDMI port. Always use a standard-sized jack.
- Use a certified cable with the HDMI logo attached.
- If you do not use a certified HDMI cable, the screen may not display or a connection error may occur. (Recommended HDMI cable types)
 - High-Speed HDMI[®]/TM Cable
 - High-Speed HDMI[®]/TM Cable with Ethernet

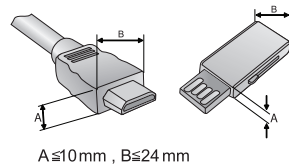

Optional Accessories

To purchase optional accessories, visit an electronics store or online shopping site or contact the retail store where you purchased the product.

Without prior notice, optional accessories are subject to change in order to improve the performance of the product, and new optional accessories may be added.

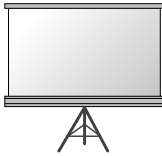

Projection screen



HDMI cable

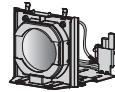

Replacement lamp



Video cable



Audio cable



Ethernet cable



RGB-to-component cable



Component cable



RS-232C cable



DVI-to-HDMI cable

Part Name

* The projector is manufactured using high-precision technology. You may, however, see tiny black dots and/or bright colored dots (red, blue, or green) that continuously appear on the projector screen. This is a normal result of the manufacturing process and does not indicate a malfunction.

Main Unit

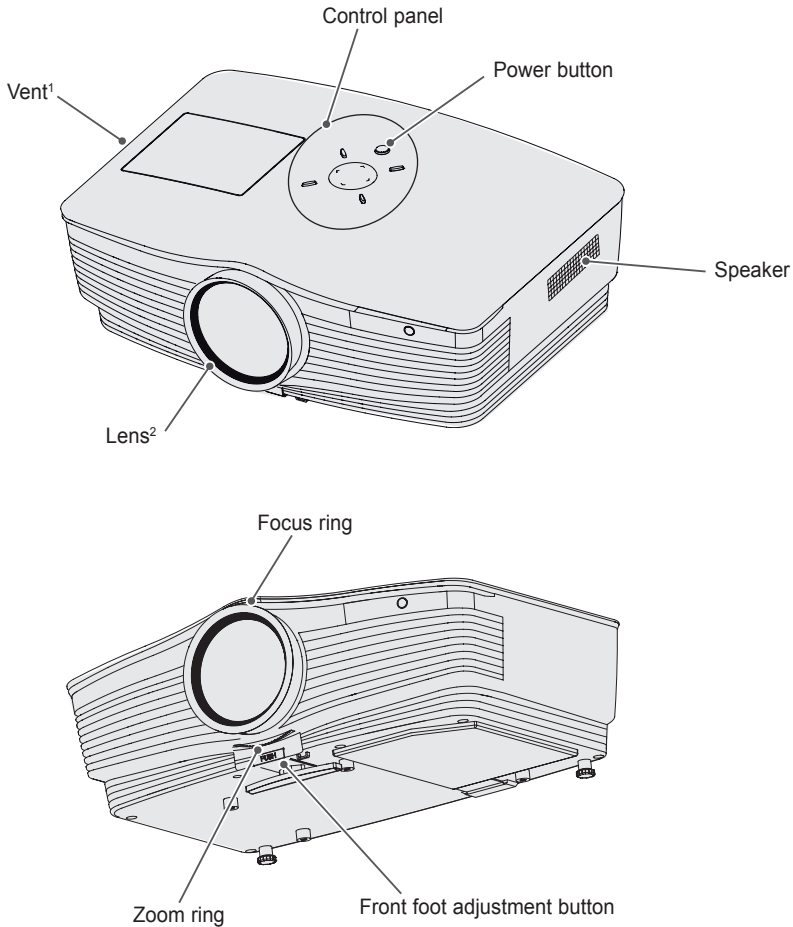

- 1 Due to the high temperature of the vent area, do not get close to the vent area.
- 2 Do not touch the lens while using the projector. The lens may be damaged.

Back

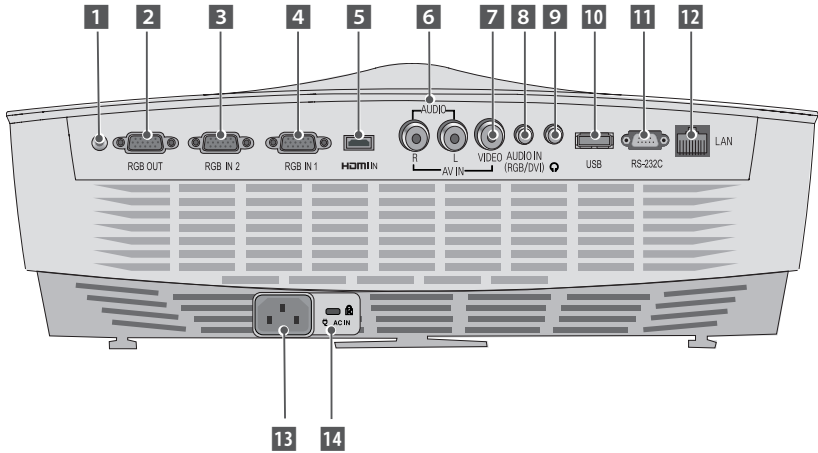

- | | |
|--|---|
| <p>1 Remote control sensor
* Do not block this sensor or remote control will not function properly.</p> <p>2 RGB OUT connector</p> <p>3 RGB IN 2 connector</p> <p>4 RGB IN 1 connector</p> <p>5 HDMI IN connector</p> <p>6 AUDIO connector</p> | <p>7 VIDEO connectors</p> <p>8 AUDIO IN (RGB/ DVI) connector</p> <p>9 Headphone connector</p> <p>10 USB port</p> <p>11 RS-232C connector</p> <p>12 LAN connector</p> <p>13 Power input connector</p> <p>14 Kensington security system connector</p> |
|--|---|

Control Panel

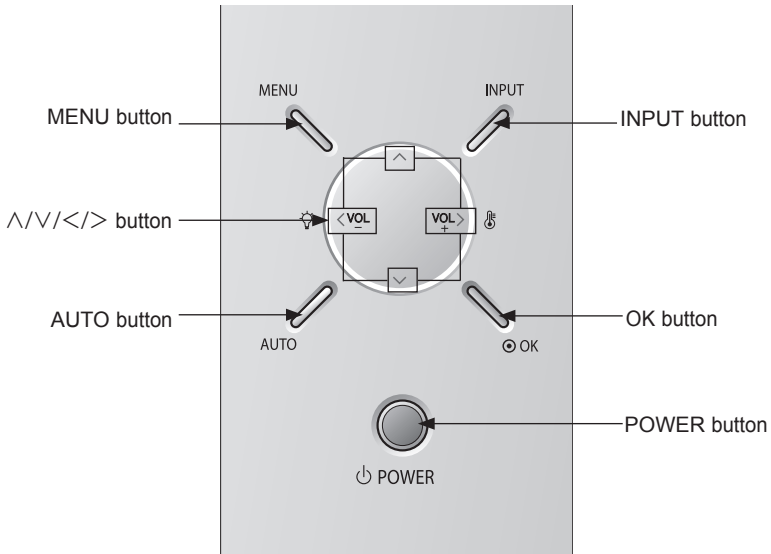

Button	Description
POWER	Turns the projector on or off.
MENU	Selects or closes menus.
^/V/</>	Moves between menus and changes the settings. (<, > button: The volume can be adjusted according to the input mode.)
OK	Shows the current mode and saves changes to the settings.
AUTO	Automatically adjusts the picture position and minimizes image shaking in RGB mode.
INPUT	Toggles between RGB1 (Component 1), RGB2 (Component 1), HDMI, and External Input.

Projector Status Indicator

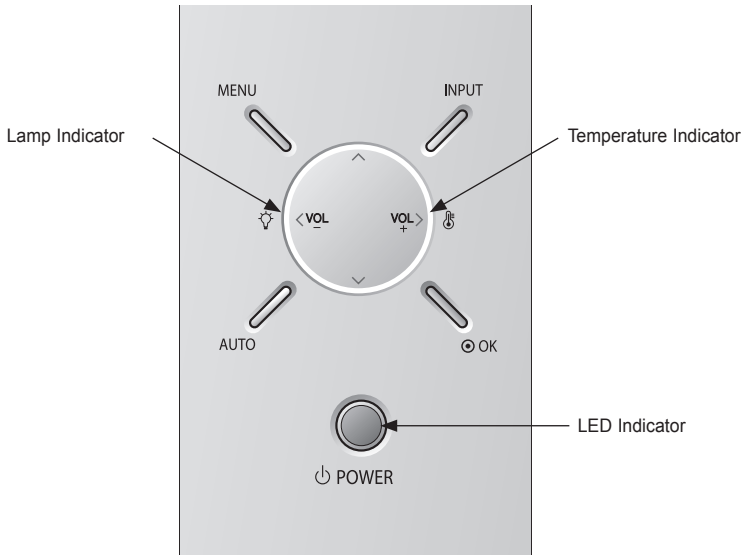

LED Indicator	Red	STANDBY (power standby mode)
	Green (flashing)	Lamp cooling until turned on.
	Green	Operating (lamp is on)
	Orange (flashing)	Lamp cooling after being turned off (approximately 20 seconds).
	Off	Power is off.
	Orange	STANDBY. (Power standby mode: naturally cools for four minutes after lamp is turned off)
	Red (flashing)	There is a problem with the projector color wheel. Please contact the nearest service center.
Lamp Indicator	Red	The lamp must be replaced because its lifespan has expired.
	Red (flashing)	There is a problem with, or related to, the projector lamp. Turn on the projector again after waiting a while. If this indicator flashes red again, contact the nearest service center.
	Green (flashing)	The lamp cover is not closed.
Temperature Indicator	Orange	High temperature warning. Please turn the projector off and check the vents.
	Red	The projector turned off due to high temperature.
	Red (flashing)	The projector turned off because the internal fan is not working. Please contact the nearest service center.

Installation

Installation Precautions

- Use the projector in a well-ventilated environment.
- To prevent excessive internal heat, install the projector in a well-ventilated location. Do not place anything near the projector, as this may block its air vents. If the air vents are blocked, the internal temperature increases.

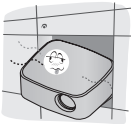

- Do not place the projector on a carpet or rug. If the projector's inlet vent is on the bottom, be careful not to block the vent and always use the projector on a solid, level surface.



- Be sure to prevent foreign objects, such as paper and debris, from entering the projector.



- Leave adequate distance (at least 30 cm) around the projector.



- Do not place the projector in a hot or humid environment.
 - Do not place the projector in a hot, cold, or humid environment.
- Do not place the projector in a place where it can attract dust.
 - Otherwise, this may result in fire.
- Do not remove any covers, except for the lens cap. There is a high risk of electric shock.
- The projector is manufactured using high-precision technology. You may, however, see tiny black dots and/or bright colored dots that continuously appear on the projector screen. This is a normal result of the manufacturing process and does not indicate a malfunction.
- The remote control may not work in an environment where a lamp equipped with electronic ballasts or a three-wavelength fluorescent lamp is installed. In this case, replace the lamp with a standard international lamp for the remote control to work properly.

Projection Distance per Screen Size

- 1 Place the projector on a sturdy, level surface, together with the computer or audio/video source.
- 2 Place the projector at an appropriate distance from the screen. The distance between the projector and the screen determines the actual size of the image.
- 3 Position the projector so that the lens is perpendicular to the screen. If the lens is not perpendicular to the screen, the projected image will look distorted. To correct the distortion, use the Keystone function. (See 25 page)
- 4 Connect the power cords of the projector and connected devices to the wall outlet.

Ratio of upward projection: 100 %

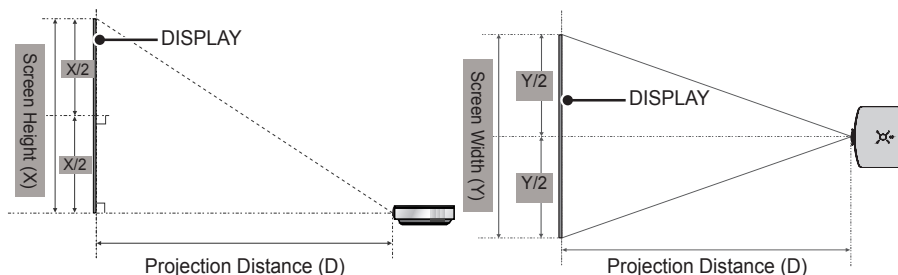

4:3 aspect ratio				
Screen Size (mm)	Screen Width (Y) (mm)	Screen Height (X) (mm)	Shortest Distance (D) (mm)	Longest Distance (D) (mm)
1016	813	610	1000	1198
1270	1016	762	1250	1497
1524	1219	914	1500	1796
1778	1422	1067	1750	2095
2032	1626	1219	2000	2395
2286	1829	1372	2250	2694
2540	2032	1524	2500	2994
3048	2438	1829	3000	3593
3556	2845	2134	3500	4192
4064	3251	2438	4000	4791
4572	3658	2743	4500	5390
5080	4064	3048	5000	5989
5588	4470	3353	5500	6588
6096	4877	3658	6000	7187
6604	5283	3962	6500	7786
7112	5690	4267	7000	8385
7620	6096	4572	7500	8984

- The Shortest Distance/Longest Distance is adjusted by rotating the zoom ring using the zoom function.
- The projection distance for each screen size is just a reference, and there is about ±5 % deviation.

Kensington Security System

- This projector has a Kensington Security Standard connector as an anti-theft mechanism. Connect a Kensington Security System cable as shown below:
- For more information on installation and use of the Kensington Security System, refer to the user's guide provided with the Kensington Security System.
- The Kensington Security System is an optional accessory.
- About Kensington Kensington sells anti-theft locks for computers, laptops, and other high-value electronic devices. Website: <http://www.kensington.com>

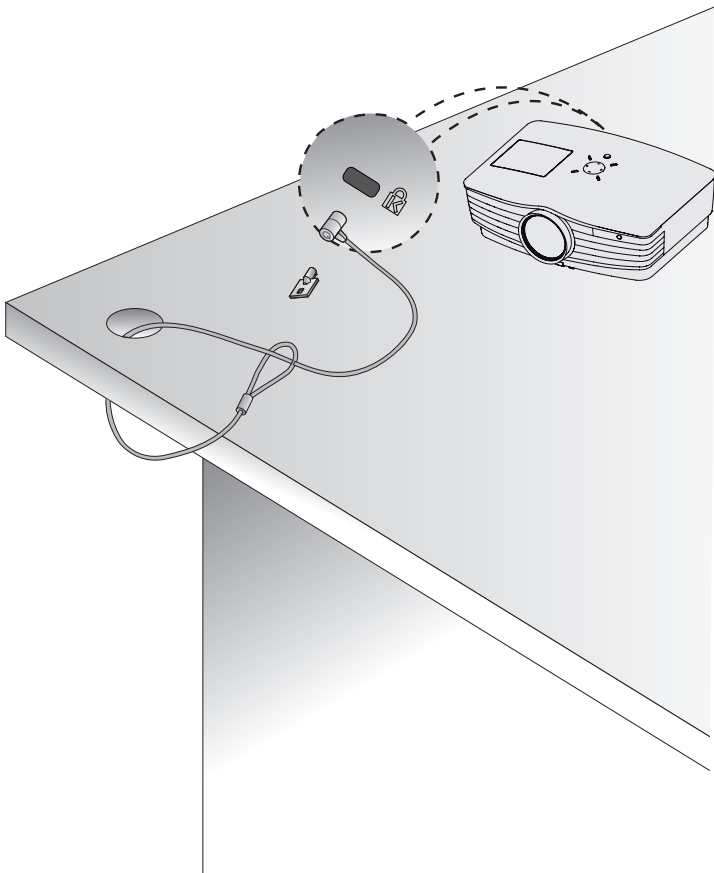

REMOTE CONTROL

Open the battery cover on the back of the remote control, and insert the batteries into the battery compartment as indicated, with \oplus \ominus poles pointing in the correct direction. Always use the same type of batteries as those provided (1.5 V AAA).

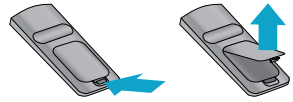

CAUTION

- Do not mix new batteries with old ones.

Power
Turns the projector on or off.

USB/MY MEDIA
Changes to USB mode.

INPUT
Changes the input source.

Playback control buttons
Adjusts the play of My Media.

Key's
Adjusts the Keystone settings.

SOUND
Changes the Sound mode.

SLEEP
Sets the sleep timer.

PICTURE
Changes the picture mode.

ENERGY SAVING
Changes the Energy Saving mode.

TIMER
Changes the settings of the presentation timer.

VOL +, -
Adjusts the volume level.

RATIO
Changes the aspect ratio.

BLANK
Displays the blank screen.

MUTE
Mutes all sound.

PAGE \wedge , \vee
Moves to the previous or next screen.

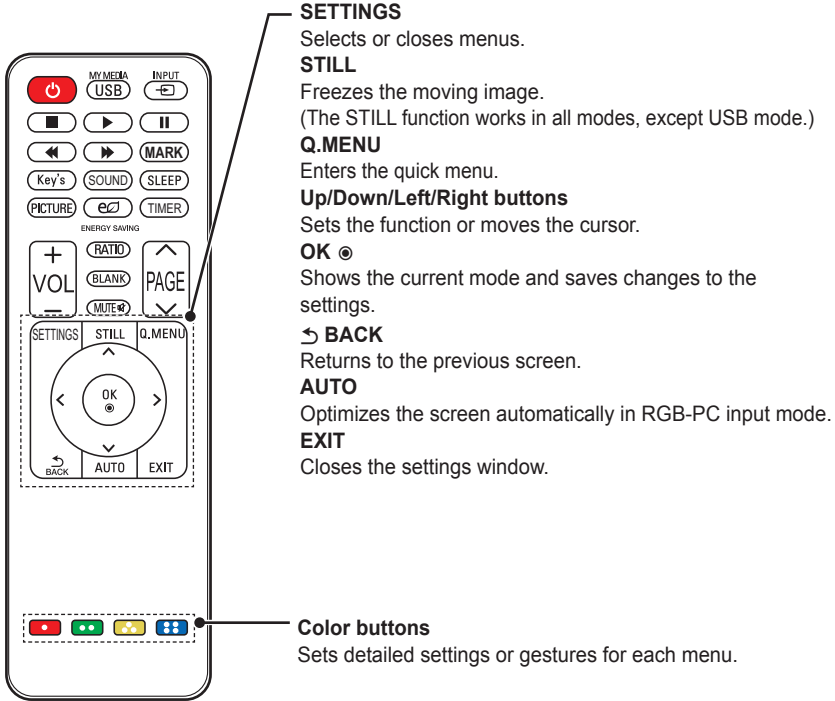

* **MARK** button is used when a software update is required.
(**MARK** button is not available for a user.)

NOTE

- When using the remote control, the optimal operation range is 6 m or less (left/right) and within a 30 degree arc of the remote control infrared receiver.
- If a cable is connected to the back port, the optimal operating range is 3 m or less (left/right) and within a 30 degree arc of the remote control infrared receiver.
- For seamless operation, do not block the infrared receiver.

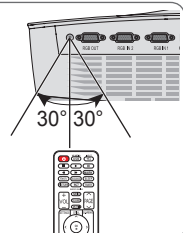

USING THE PROJECTOR

Using the Projector

Turning on the Projector

- 1 Connect the power cord.
- 2 Wait a moment after connecting the power cord, then open the lens cap and press the **POWER** button on the control panel or remote control. (The light on the control panel turn on.)
- 3 In the Language Selection screen, select a language.
- 4 Use the **INPUT** button on the remote control to select an input signal.

Adjusting Focus and Position of the Screen Image

When an image appears on the screen, check that it is in focus and fits in the screen properly.

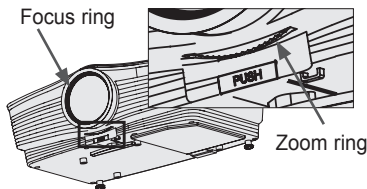

- To adjust the focus of the image, rotate the focus ring (the outer ring of the projector lens).
- To adjust the size of the image, rotate the inner zoom ring.
To move the screen image upward/downward, adjust the height of the foot at the bottom of the projector.

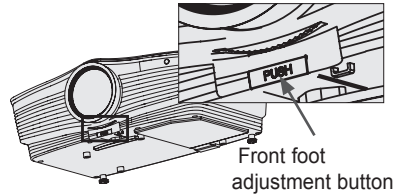

- While pressing the front foot adjustment button, adjust the projector upward/downward until the screen image is in the desired position.
- When you release the front foot adjustment button, the front foot becomes fixed at the current position.

Using the Projector

- 1 In Standby mode, press the **POWER** button to turn the projector on.
- 2 Press the **INPUT** button to select the input signal you want.
- 3 Control the projector using the following buttons while watching the screen.

Button	Description
VOL -, +	Adjusts the volume level.
MUTE	Mutes all sounds.
Q.MENU	Accesses the quick menu.
RATIO	Resizes an image.
Key's	Adjusts Keystone.

- 4 Press the **POWER** button to turn the projector off.

Replacing the Lamp

Replacing the Lamp

The lifespan of the lamp depends on the environment in which the projector is used.

You can check how long the projector lamp has been used in the **OPTION** menu. Make sure to replace the lamp in the following situations:

- The projected image gets darker or the quality deteriorates.
- The lamp warning indicator is red.
- The “Replace the lamp” message appears on the screen when turning the projector on.

Be careful when replacing the lamp

- Turn off the power by pressing the **POWER** button on the remote control or control panel.
- Do not remove the power cord when the operation indicator is flashing orange, i.e. the fan is working (about 20 seconds). When the operation indicator is orange and no longer flashing, remove the power cord.
- Allow the lamp to cool for one hour before replacing it.
- Replace only with the same type of lamp from an LG Electronics Service Center. Using another manufacturer's lamp may damage the projector and lamp.
- Only pull the lamp out when replacing it.

- Keep the lamp unit out of reach of children. Keep the lamp away from heat sources, such as radiators and stoves. There is a fire or burn hazard.
- Do not expose the lamp to liquids or foreign materials. The lamp may burst.
- Do not insert flammable or metal objects into the lamp socket after removing the lamp. This can result in electrical shock or damage the product.
- Securely tighten the new lamp with screws. If it is not securely tightened, the projected image may become darker and there may be a fire hazard.
- Do not touch the front glass of the new lamp or the glass of the lamp container. Picture quality and lamp lifespan may suffer.

Purchasing a replacement lamp

Check the lamp model and then purchase the replacement lamp from an LG Electronics Service Center.

(Use a lamp designed specifically for the projector; otherwise, it may damage the projector.)

Disposing of lamps

Dispose of a used lamp by returning it to an LG Electronics Service Center.

Additional Options

Adjusting the Aspect Ratio

You can adjust the aspect ratio of the picture by pressing **RATIO** while watching.

! NOTE

- Available options may vary depending on the input signal.
- You can also use the **Q.MENU** or **SETTINGS** button.

- **16:9:** Resizes the picture to a 16:9 ratio.



- **Just Scan:** Displays high-definition images in the original size without cutting off the edges.

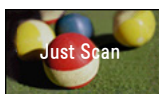

! NOTE

- In Just Scan, you may see image noise at the edges of the screen.

- **Set By Program:** Displays images in the same aspect ratio as the original image.



- **4:3:** Resizes the picture to a 4:3 ratio.



- **Zoom:** Enlarges an image to fit the screen width. The top and bottom of the image may be truncated.
 - Press the **<** or **>** button to zoom in to or out of the image.
 - Press the **^** or **v** button to move the image.



- **Cinema Zoom 1:** Enlarges an image at a cinemascope ratio of 2.35:1 without distortion. It ranges from 1 to 16.
 - Press the **<** or **>** button to zoom in to or out of the image.
 - Press the **^** or **v** button to move the image.



! NOTE

- If you enlarge or reduce the picture, it may be distorted.

Using the Keystone Function

To prevent the screen image from becoming trapezoidal, **Keystone** adjusts the top and bottom width of the image if the projector is not set up at a right angle to the screen. Because the **Keystone** function may cause inferior screen image quality, use this function only when it is not possible to set up the projector at an optimal angle.

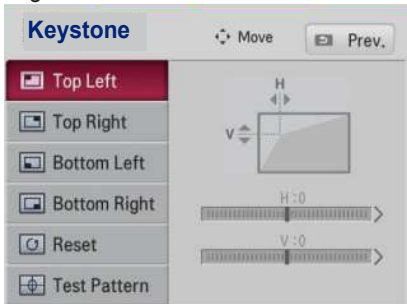

- Adjust the screen using the **Key's** button.
 - Keystone** value ranges are as follows.
 - Top left (H: 0 to 100, V: 0 to 100)
 - Top right (H: -100 to 0, V: 0 to 100)
 - Bottom left (H: 0 to 100, V: -100 to 0)
 - Bottom right (H: -100 to 0, V: -100 to 0)

- Press the **OK** button after adjustment.

Using the Input List

Using the Input List

- Press the **INPUT** button to display the input selection screen.
 - The connected input mode appears first. Note that the component is always enabled.

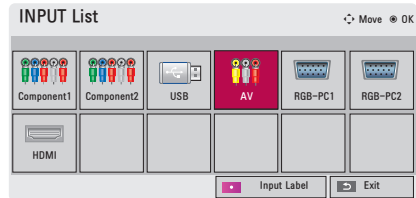

- Use the **INPUT** button to select an input signal to switch the projector to the desired input mode. Use the \wedge , \vee , \lt or \gt button to switch between all input modes.

Selecting an Input Label

You can select an input label to display which devices are connected to which input ports.

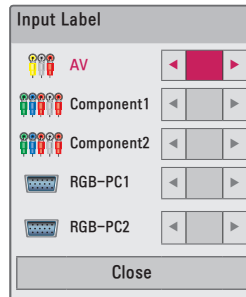

- Press the **INPUT** button to display the input selection screen.
- Press the **RED** button.
- Use the \wedge or \vee button to scroll to one of the input sources.
- Use the \lt or \gt button to select a device name.

Blank Function

Using Blank Image Function

This function is effective when you want to draw attention to you during a meeting or training session.

- 1 Press the **BLANK** button to display the blank background color on the screen.
You can change the background color by referring to "Selecting the background color of the blank image".
- 2 Press any button to clear the blank image function. To cover the screen temporarily, press the **BLANK** button on the remote control. Never block the lens with an object while the projector is running. The lens may become overheated, resulting in deformation of the lens or fire.

Selecting the background color of the blank image

- 1 Press the **SETTINGS** button.
- 2 Use the \wedge , \vee , \lt , or \gt button to select **OPTION**, then press the **OK** button.
- 3 Press the \wedge , \vee , \lt , or \gt button to select **Blank Image**, then press the **OK** button.
- 4 Use the \wedge or \vee button to move to the desired item, then press the **OK** button.

Using Quick Menu

You can easily customize your frequently used menus.

- 1 Press the **Q.MENU** button to open Quick Menu.
- 2 Press the \lt or \gt button to select a menu, then press **OK**.

Menu	Description
Aspect Ratio	Changes the aspect ratio. (See 24 page)
Picture Mode	Changes the picture mode. (See 43 page)
Energy Saving	Adjusts brightness.
Clear Voice II	Makes the voice from the projector crisp and clear.
Sound Mode	Sets the sound mode.
Sleep Timer	Sets the specific time to turn off the projector automatically.
PJT Mode	Turns the projected image upside down or flips it horizontally.
USB Device	Disconnects a USB device.

- 3 Press the \wedge , \vee , \lt , and \gt buttons to scroll through the following menus.

ENTERTAINMENT

Using SCREEN SHARE

- 1 Enable related SCREEN SHARE function on the device you wish to connect.
- 2 Connect the Projector from the search list on the device you wish to connect. (When you connect the projector to your laptop, input the PIN code shown on your display. The request for a PIN will be shown only at the initial connection.)
- 3 If the desired device accepts the request, SCREEN SHARE will be started.



CAUTION

- Windows 7 / 8 / 8.1 are compatible with SCREEN SHARE. However, other versions of Windows, and some other operating systems, may not be compatible with SCREEN SHARE.
- Ice Cream Sandwich, Jellybean, and KitKat versions of LG's Android devices are guaranteed to be compatible.
- When connecting via SCREEN SHARE, place the device close to the projector.
- The response rate and image quality may vary depending upon the user's environment.
- For more information on the device you want to connect to, refer to its owner's manual.

MY MEDIA

Connecting a USB Device

When a USB storage device is connected, the USB adjustment screen appears. You cannot write or delete data to or from the USB device.

Connect a USB flash drive as shown below.

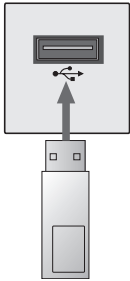

USB Flash drive

Removing a USB Device

- 1 Press the **Q.MENU** button.
- 2 Use the **<** or **>** button to move to **USB Device**, then press the **OK** button.
- 3 Remove the USB device.

! NOTE

- After the USB device is disconnected, it cannot be read. Remove the USB device, then connect it again.

Tips for Using a USB Device

- Only a USB storage device is recognizable.
- USB hubs are not supported.
- A USB storage device that uses its own driver may not be recognized.
- The recognition speed of a USB storage device depends on each device.
- If a normal USB device does not work, disconnect and reconnect it. Please do not turn off the projector or unplug the USB device while the connected USB device is being accessed. If such a device is forcefully unplugged, the USB device or stored files may be damaged.
- Do not connect the USB storage device that has been manipulated on the PC. The projector may not operate properly or fail to play files. Use a USB storage device that contains normal music, photo, video, or document files.
- Only use a USB storage device formatted as a FAT16, FAT32, or NTFS file system provided by Windows. If a storage device is formatted with a non-Windows program, it may not be recognized.
- Connect the power cord of a USB storage device that requires an external power supply. If not, the device may not be recognized.
- Connect a USB storage device with a cable provided by the USB manufacturer. When you use a cable that is not provided by the USB device manufacturer or an excessively long cable, the device may not be recognized.
- Some USB devices may not be supported or may not work properly.
- If the length of a folder or file is too long, the folder or file may not be recognized properly.
- The files in a USB storage device are sorted in the same way as in Windows XP. Up to 100 English characters for a file name are allowed.
- It is possible for data in a USB device to become damaged, so it is recommended to back up important files. Users are responsible for data management. The manufacturer bears no responsibility.
- It is recommended to use a USB flash drive that is 32 GB or less and a USB hard disk that is 1 TB or less. Any USB device with more than the recommended capacity may not work properly.
- If a USB storage device is not working properly, disconnect it and reconnect it.
- If a USB external hard drive with the power saving function does not work, turn the hard drive off and on again to make it work properly.
- USB storage devices below USB 2.0 are supported as well. However, they may not work properly in the movie list.

Watching Videos

In the Movie List, you can watch movies stored on the connected USB device.

Tips for Playing Videos

- Some user-created subtitles may not work.
- Some special characters are not supported in subtitles.
- HTML tags are not supported in subtitles.
- Time information in a subtitle file should be arranged in ascending order to play the subtitle properly.
- Changing font and color in subtitles is not supported.
- Languages not specified in the subtitle languages menu are not supported. (See 34 page)
- Subtitle files 1 MB or larger are not supported.
- The screen may suffer temporary interruptions (stopped image, faster playback, etc.) when the audio language is changed.
- A damaged video file may not play properly, or some functions may not be available.
- Video files created by some encoders may not be played back.
- Audio or video may only be supported depending on the video or audio packet structure of the video file.
- Video files with higher resolution than the maximum supported for each frame may not play properly.
- Video files in formats other than those specified here may not play back.
- Streaming files that include GMC (Global Motion Compensation) or Qpel (Quarter Pixel Motion Estimation) is not supported.
- Up to 10,000 sync blocks are supported in the subtitle file.
- Seamless playback is not guaranteed for files encoded at level 4.1 or higher in H.264/AVC.
- Video files larger than 30 GB (giga-bytes) are not supported.
- A video played via a USB connection that does not support high speed may not work properly.
- A video file and its subtitle file must be located in the same folder. A video file name and its subtitle file name must be identical in order to display the subtitles properly.
- While watching a video using the Movie List function, you cannot adjust the picture mode.
- Trick Mode does not support functions other than ► if video files do not have index information.
- When playing a video file over the network, Trick mode is limited to 2x speed.
- Video file names that contain special characters may not be playable.

Supported Files

Extension	Codec Category	Code Type	Profile/Level Support
.asf .wmv	Video codec	VC-1 Advanced Profile	Advanced Profile @ Level 3 (e.g., 720p60, 1080i60, and 1080p30) Only files compliant with the SMPTE 421M VC-1 standard can be streamed.
		VC-1 Simple and Main Profiles	Simple Profile @ Medium Level (e.g., CIF and QVGA) Main Profile @ High Level (e.g., 1080p30) Only files compliant with the SMPTE 421M VC-1 standard can be streamed.
	Audio codec	WMA Standard	
.divx .avi	Video codec	DivX 3.11	
		DivX 4 DivX 5 DivX 6	Advanced Simple Profile (720p/1080i)
		Xvid	Advanced Simple Profile (720p/1080i)
		H.264/AVC Motion JPEG	
	Audio codec	MPEG-1 Layer 1, I2	
		Dolby Digital	
		MPEG-1 Layer III (MP3)	
.mp4 .m4v .mov	Video codec	H.264 /AVC	Main Profile @ Level 4.1 High Profile @ Level 4.1 (e.g., 720p60, 1080i60, and 1080p30)
		MPEG-4 Part 2	Advanced Simple Profile (720p/1080i)
		Xvid	
	Audio codec	AAC MPEG-1 Layer 3 (MP3)	
.mkv	Video codec	H.264 /AVC	Main Profile @ Level 4.1 High Profile @ Level 4.1 (e.g., 720p60, 1080i60, and 1080p30)
		MPEG-4 Part 2	
		Xvid	
	Audio codec	HE-AAC	HE-AAC-LC and HE-AAC
		Dolby Digital MPEG-1 Layer 3 (MP3)	
.ts .trp .tp	Video codec	H.264 /AVC	Main Profile @ Level 4.1 High Profile @ Level 4.1 (e.g., 720p60, 1080i60, and 1080p30)
		MPEG-2	Main Profile @ High Level (e.g., 720p60 and 1080i60)
	Audio codec	MPEG-1 Layer 1/2	
		MPEG-1 Layer 3 (MP3)	
		Dolby Digital AAC	
.vob	Video codec	MPEG-1	
		MPEG-2	Main Profile @ High Level (e.g., 720p60 and 1080i60)
	Audio codec	MPEG-1 Layer 1/2	
		Dolby Digital DVD-LPCM	
.mpg .mpeg .mpe	Video codec	MPEG-1	
	Audio codec	MPEG-1 Layer 1/2	Only files configured properly for TS, PS, or ES can be streamed.

Supported Audio Files

No	Audio Codec	Bit Rate	Sampling Rate	Remark
1	MP3	32 Kbps - 320 Kbps	32 kHz - 48 kHz	
2	AC3	32 kbps - 640 kbps	32 kHz, 44.1 kHz, 48 kHz	
3	MPEG	32 kbps - 448 kbps	32 kHz - 48 kHz	
4	AAC, HE-AAC	24 kbps - 3844 kbps	8 kHz - 96 kHz	
5	CDDA	1.44 kbps	44.1 kHz	
6	LPCM	1.41 Mbps - 9.6 Mbps	Multi-channel: 44.1 kHz, 88.2 kHz / 48 kHz, 96 kHz Stereo: 176.4 kHz, 192 kHz	

Browsing Movie List

Play a video file stored in the connected device.

- 1 Connect a USB storage device.
- 2 Press the **USB** button.
- 3 Press the \wedge , \vee , \lt , or \gt button to select **Movie List**, then press the **OK** button.
- 4 Use the \wedge , \vee , \lt , or \gt button to select a file, then press the **OK** button.

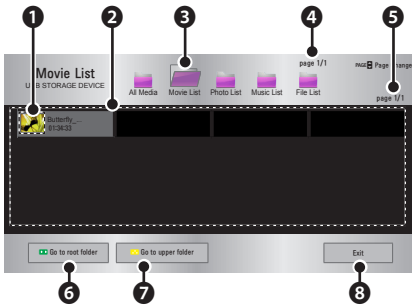

	Description	
1	Thumbnails	
	Abnormal file	
	File not supported	
2	File list	
3	Moves to the upper-level folder.	
4	Current page/Total no. of folder pages	
5	Current page/Total no. of file pages	
6	Moves to the top-level folder.	
7	Moves to the upper-level folder.	
8	Exit movie list.	

- 5 Use the following playback buttons to control playback:



Item	Description
$\ll \gg$	Shows the current playback position. You can use the \lt or \gt button to move the playback position forward or backward.
■	Stops playback and returns to Movie List.
\triangleright	Resumes normal playback.
	Pauses the media player. If no button is pressed on the remote control for 10 minutes after pausing, playback resumes automatically.
$\text{ } \triangleright$	Displays in slow motion.
$\ll \gg$	Whenever this button is pressed, the playback speed is changed. : x2, x4, x8, x16, x32
eS	You can use Energy Saving mode.
Option	A settings pop-up window appears.
Hide	Hides the playback bar. Press the OK button to make it appear.
Exit	Returns to the Movie List screen.

Setting Options

- 1 Press the **Quick Menu** button.
- 2 Use the \wedge or \vee button to move to a desired option, then press the **OK** button.
- 3 Use the \wedge , \vee , \lt , or \gt button to set up each item.

Set Video Play.

Item	Description
Picture Size	Selects the aspect ratio of the image. <ul style="list-style-type: none"> • Full: Files play in full-screen mode based on the aspect ratio of the video. • Original: Displays the video in the original aspect ratio.
Audio Language	Select the language you want in a file offering multiple languages. This option is not available if the file has only one language.
Subtitle Language	Turn subtitles on or off. <ul style="list-style-type: none"> • Language: Select one of the available languages. • Code Page: Select a character set for subtitles. By default, subtitles are displayed in the language configured in OPTION → Menu Language. • Sync: If subtitles are not synchronized with the video, you can adjust the timing by 0.5-second units. • Position: Moves the location of the subtitles. • Size: Changes the subtitle font size.
Repeat	Turns the repeat function on or off. When it is set to Off, the next file can be played sequentially if the file name is similar.

• Subtitle Language

Subtitle Language	Language
Latin1	English, Spanish, Irish, Welsh, French, German, Italian, Dutch, Swedish, Finnish, Portuguese, Danish, Romanian, Norwegian, Albanian, Gaelic, Catalan, Valencian
Latin2	Bosnian, Polish, Croatian, Czech, Slovak, Slovene, Serbian, Hungarian
Latin4	Estonian, Latvian, Lithuanian
Greek	Greek
Cyrillic	Bulgarian, Russian, Ukrainian, Kazakh, Macedonian
Hebrew	Hebrew
Chinese	Chinese
Korean	Korean
Arabic	Arabic
Turkish	Turkish
Thai	Thai

Set Video.

You can change video settings. (Refer to "PICTURE Settings" on 43 page.)

Set Audio.

You can change audio settings. (Refer to "Audio Settings" on 47 page.)

Checking DivX registration code

Please check your DivX registration code. For more information on the registration process, visit www.divx.com/vod. After registration, you can enjoy VOD content protected by the DivX® DRM.

- 1 Move from the menu to **OPTION**, then press **DivX(R) VOD**.



- 2 Press the \wedge or \vee button to move to **Registration**, then press the **OK** button.

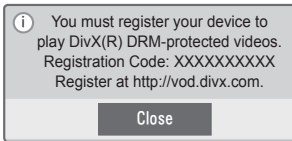

- 3 Check the DivX registration code.

! NOTE

- You cannot use DivX registration codes assigned to other devices. Make sure to use the DivX registration code assigned to your device.
- Video or audio files that are not converted by the standard DivX codec may be corrupted or not play.

Deregistering the DivX Code

Use the DivX deregistration code to deactivate the DivX DRM function.

- 1 Move from the menu to **OPTION**, then press **DivX(R) VOD**.
- 2 Use the \wedge or \vee button to go to **Deregistration**, then press the **OK** button.
- 3 Select **Yes**.

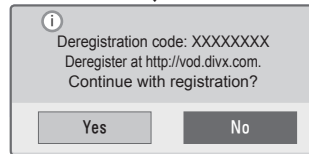
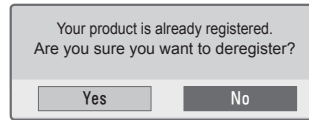

! NOTE

- About Digital Rights Management (DRM) DRM technologies and services protect the interests and rights of copyright holders by preventing illegal use of digital content. Files can be played after the license is verified through, for example, an online method.

Viewing Photos

You can view photos stored on a connected device.

Photo File

PHOTO (*.JPEG)

Baseline: 64 (W) x 64 (H) pixels - 15360 (W) x 8640 (H) pixels



Progressive: 64 (W) x 64 (H) pixels - 1920 (W) x 1440 (H) pixels

- Only JPEG files are supported.
- Unsupported files are indicated with an icon.
- An error message is displayed for corrupted files or file formats that cannot be played.
- Corrupted files may not be displayed properly.
- It may take some time to view high-resolution images in full screen.

Browsing Photo List

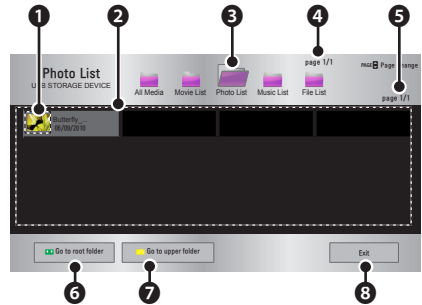
- 1 Connect a USB storage device.
- 2 Press the **USB** button.
- 3 Use the \wedge , \vee , \lt , or \gt button to select **Photo List**, then press the **OK** button.
- 4 Use the \wedge , \vee , \lt , or \gt button to select a file, then press the **OK** button.



	Description
1	Thumbnails Abnormal file  File not supported 
2	File list
3	Moves to the upper-level folder.
4	Current page/Total no. of folder pages
5	Current page/Total no. of file pages
6	Moves to the top-level folder.
7	Moves to the upper-level folder.
8	Shutdown

5 Use the following buttons to control playback:



Item	Description
	Selects the previous or next photo.
Slide show	Displays all photos in a slide show. <ul style="list-style-type: none"> • Set Slide Speed in the Option → Set Photo View menu.
BGM	Listen to background music while viewing full-size photos. <ul style="list-style-type: none"> • Set BGM in the Option → Set Photo View menu.
	Rotates photos. <ul style="list-style-type: none"> • Rotates a photo 90°, 180°, 270°, 360° clockwise. • Photos cannot be rotated if the width is greater than the height of the maximum supported resolution.
	Enlarges or reduces the photo. Press the blue button to enlarge the image.
	You can use Energy Saving mode.
Option	A settings pop-up window appears.
Hide	Hides the menu on the full-size screen. <ul style="list-style-type: none"> • To view the menu again, press the OK button on the remote control.
Exit	Exit from full-screen photo view.

Setting Options

- 1 Press the **Q.Menu** button.
- 2 Use the \wedge or \vee button to move to a desired option, then press the **OK** button.
- 3 Use the \wedge , \vee , $<$, or $>$ button to set up each item.

Set Photo View.

Item	Description
Slide Speed	Selects a slide show transition speed.
BGM	Selects a music folder for background music. <ul style="list-style-type: none"> • You cannot change the music folder while background music is playing. • For background music, you can only select a folder from the same device.
Repeat	Selects repeat.
Random	Selects random play.

Set Video.

You can change video settings. (Refer to "PICTURE Settings" on 43 page.)

Set Audio.

You can change audio settings. (Refer to "Audio Settings" on 47 page.)

Listening to Music

Play audio files stored on the connected device.

Audio File

*.MP3

Bit rate range 32 Kbps - 320 Kbps

- Sampling rate MPEG1 Layer3: 32 kHz, 44.1 kHz, 48 kHz
- Sampling rate MPEG2 Layer3: 16 kHz, 22.05 kHz, 24 kHz

Browsing Music List

- 1 Connect a USB storage device.
- 2 Press the **USB** button.
- 3 Use the \wedge , \vee , \lt , or \gt button to select **Music List**, then press the **OK** button.
- 4 Use the \wedge , \vee , \lt , or \gt button to select a file, then press the **OK** button.

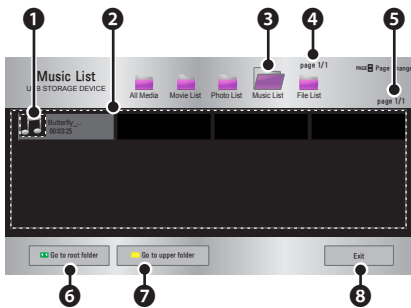

	Description	
1	Thumbnails	
	Abnormal file	
	File not supported	

	Description
2	File list
3	Moves to the upper-level folder.
4	Current page/Total no. of folder pages
5	Current page/Total no. of file pages
6	Moves to the top-level folder.
7	Moves to the upper-level folder.
8	Shutdown

5 Use the following buttons to control playback:

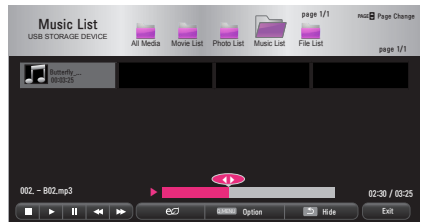

Item	Description
	Changes the playing position.
	Stops playing.
	Resumes normal playback.
	Pauses the media player.
	Plays the previous/next file.
	You can use Energy Saving mode.
Option	Sets Option for the music list.
Hide	Hides the playback bar. Press the OK button to show it again.
Exit	Returns to the Music List screen.

Setting Options

- 1 Press the **Q.Menu** button.
- 2 Use the \wedge or \vee button to move to a desired option, then press the **OK** button.
- 3 Use the \wedge , \vee , \lt , or \gt button to set up each item.

Set Audio Play.

Item	Description
Repeat	Selects repeat.
Random	Selects random play.

Set Audio.

You can change audio settings.
(Refer to "Audio Settings" on 47 page.)

Viewing Files

You can view document files stored on a connected device.

Supported File Formats

XLS, DOC, PPT, TXT, XLSX, PPTX,
DOCX, PDF, HWP
Microsoft Office 97/2000/2002/2003/2007
Adobe PDF 1.0/1.1/1.2/1.3/1.4
Hangul 97/2000/2002/2005/2007

- File Viewer realigns documents, so documents may look different from what is displayed on the PC.
- For documents that include images, the resolution may look lower during the realignment process.
- If the document is large or has many pages, it may take longer to load the document.
- Unsupported fonts may be replaced by other fonts.
- The file viewer may not open for Office documents that contain many high resolution images.
In that case, reduce the image file size, save it on a USB storage device and run the file viewer again or connect your PC to the projector and open the file on your PC.

File List Screen

- 1 Connect a USB storage device.
- 2 Press the **USB** button.
- 3 Use the \wedge , \vee , \lt , or \gt button to select **File List**, then press the **OK** button.
- 4 Use the \wedge , \vee , \lt , or \gt button to select a file, then press the **OK** button.

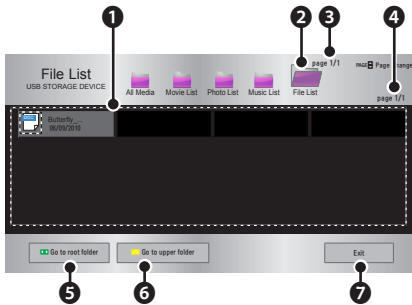

	Description
1	File list
2	Moves to the upper-level folder.
3	Current page/Total no. of folder pages
4	Current page/Total no. of file pages
5	Moves to the top-level folder.
6	Moves to the upper-level folder.
7	Shutdown

5 Use the following buttons to control playback:

- When you press the **Go Page** button, a window where you can enter a page number appears. Enter a page number to go to that page.
- Press the volume button to **Zoom in** or **Zoom out**.
 1. Press the **OK** button.
 2. Press the **Up/Down/Left/Right** buttons to move to Go to Page or Zoom.

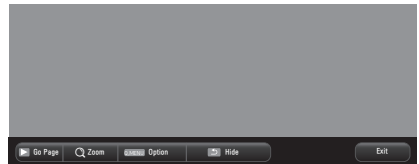

Item	Description
Go Page	Moves to the page you want. Use the Up/Down/Left/Right buttons to select a page, then press the OK button.
Zoom	Enlarges or reduces the image.
Option	Sets Options for File Viewer.
Hide	Hides the menu. <ul style="list-style-type: none"> • Press the OK button to show it again.
Exit	Returns to the File List screen.

Set FileViewer Option







Item	Description	
Single Page Loading	On	Loads and displays pages one by one. The initial loading time is short, but a content-heavy page may be displayed slowly.
	Off	The entire document is loaded to memory before displaying. Initial loading may take a long time, but page navigation is very fast. If a file is too large, it may fail to load all the pages.
Image Quality	You can set the quality of the image included in the document. Three levels: low, medium, and high. A higher image quality may be displayed at a low speed on a screen.	
Document Align	Selects the initial document arrangement method.	

The File Viewer Option settings are default, so close the currently opened document to apply changes to the new document.

CUSTOMIZING SETTINGS

Settings

- 1 Press the **SETTINGS** button.
- 2 Use the **^**, **v**, **<**, or **>** button to select a desired item, then press the **OK** button.
- 3 Use the **^**, **v**, **<**, or **>** button to set the desired item, then press the **OK** button.
- 4 Press the **EXIT** button when completed.

Menu		Description
	PICTURE	Adjusts the image quality for optimal viewing.
	AUDIO	Adjusts the sound quality and volume level.
	TIME	For time-related settings.
	OPTION	Customizes the general settings.
	INPUT	Lets you select the desired input.
	MY MEDIA	Accesses photo, music, movie, and document files.

PICTURE Settings

- 1 Press the **SETTINGS** button.
- 2 Use the \wedge , \vee , \lt , or \gt button to select **PICTURE**, then press the **OK** \odot button.
- 3 Use the \wedge , \vee , \lt , or \gt button to set up the desired item, then press the **OK** \odot button.
- To return to the previous menu, press the \rightarrow **BACK** button.
- 4 Press the **EXIT** button when completed.

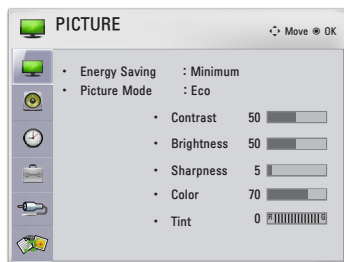

The available picture settings are as follows:

Item	Description	
Energy Saving	Reduces power consumption by adjusting screen brightness.	
Picture Mode	Selects one of the preset images, or customizes options in each mode for the best screen performance. You can also customize advanced options for each mode.	
	Mode	
	Vivid	Maximizes the visual effect of the video. Displays a crystal clear picture by enhancing contrast, brightness, and sharpness.
	Standard	Displays the picture at normal contrast, brightness, and sharpness.
	Eco	Reduces power consumption by adjusting the brightness corresponding to image movement on the screen.
	Cinema	Optimizes the image for movies.
	Game	Optimizes the image for playing games on fast-moving screens.
	Expert1/2	Adjusts the detailed image settings.
	Black Mode	Provides optimized picture quality on a dark-colored screen or a chalkboard by removing the input image's colors and reversing the contrast. * Black mode is only available when the external input is set to either of RGB-PC1, RGB-PC2 or HDMI and the resolution is set to 1024x768. * If you change the resolution to other value than 1024 x 768 while the picture mode is set to the black mode, the picture mode is automatically reset to the default value. * You cannot control the picture settings when the picture mode is set to the black mode.

Item	Description	
Contrast	Increases or decreases the gradient of the video signal.	
Brightness	Adjusts the base level of the video signal to make the image brighter or darker.	
Sharpness	Adjusts the level of sharpness in the edge between the light and dark areas of the picture. The lower the level is, the softer the image looks. Horizontal and Vertical Sharpness are available only Expert1/2.	
Color	Adjusts the intensity of all colors.	
Tint	Adjusts the balance between red and green levels.	
Picture Option	Sets optional settings.	
Advanced /Expert Control	Customizes the advanced settings.	
Picture Reset	Restores each mode's options to the factory default.	
Aspect Ratio	Changes the aspect ratio.	
Screen (RGB-PC)	Adjusts the picture quality for RGB-PC input.	
	Item	
	Resolution	Available resolutions are 768 (1024 x 768 / 1280 x 768, 60 Hz) and 1050 (1400 x 1050 / 1680 x 1050, 60 Hz).
	Auto Config.	Provides optimized picture quality by automatically calibrating mismatched horizontal width and a shaky picture caused by conflicts between the internal settings of the projector and various PC graphic signals. <ul style="list-style-type: none"> You can also use the AUTO button on the remote control.
	Posição	Moves the image up/down/left/right.
	Ratio	Changes the aspect ratio.
	Phase	Makes the picture look clear by removing horizontal noise.
Initial Settings	Restores all the settings to the factory default.	

Advanced / Expert Control

Item	Description
Dynamic Contrast	Adjusts contrast to keep it at the best level for the brightness of the screen.
Dynamic Color	Adjusts screen colors so that they look natural.

Item	Description
Skin Color	Detects the skin area in the image and adjusts it to achieve natural skin color.
Sky Color	Adjusts only the color of the sky.
Grass Color	Adjusts only the natural color area of, for example, fields and mountains.
Gamma	Adjusts the overall color of the screen to suit your preference. In Expert and Cinema mode, you can customize the options of each mode.
Color Gamut	Selects the range of colors to display.
Edge Enhancer	Provides much sharper and clearer edges to the picture.
Color Filter	Accurately adjusts color and tint by filtering a specific color area of RGB space.
Color Temperature	<p>Gamma: Select 1.9, 2.2, or 2.4.</p> <p>a. Method: 2 points</p> <ul style="list-style-type: none"> - Pattern: Inner, Outer - Points: Low, High - Red/Green/Blue: The adjustment range is -50 - +50. - Apply to all inputs: The values of the Color Temperature is applied to all the input modes. <p>b. Method: 10 points IRE</p> <ul style="list-style-type: none"> - Pattern: Inner, Outer - IRE (Institute of Radio Engineers) is the unit that indicates the size of the video signal and can be set as either 10, 20, 30 - 90, or 100. You can fine-tune for each setting as shown below. - Luminance: If you set up luminance for 100 IRE, a luminance value satisfying each gamma is automatically calculated for each step from 10 IRE to 90 IRE. - Red/Green/Blue: The adjustment range is -50 - +50. - Apply to all inputs: The values of the Color Temperature is applied to all the input modes.
Color Management	<p>Adjusts Red/Green/Blue/Yellow/Cyan/Magenta colors. Allows an expert to adjust the tint using a test pattern. Six colors (Red/Green/Blue/Cyan/Magenta/Yellow) can be selectively adjusted without affecting other colors. You may not see colors change on a normal picture even after adjustment.</p> <ul style="list-style-type: none"> - Chroma Red/Green/Blue/Yellow/Cyan/Magenta, Tone Red/Green/Blue/Yellow/Cyan/Magenta : The adjustment range is -30 - +30 each.

* Available options may differ depending on the input signal or video mode, etc.

Picture Option

Item	Description
Noise Reduction	Removes noise from the picture.
MPEG Noise Reduction	Reduces the noise produced while creating digital video signals.
Black Level	Compensates the screen brightness and contrast to balance with the black level of the video input.
Real Cinema	Provides optimal picture quality for watching a movie.
Color Temperature	Adjusts the overall color of the screen to suit your preference. Select Warm , Cool , Medium or Natural . In Expert mode, you can customize the options for each mode.

AUDIO Settings

- 1 Press the **SETTINGS** button.
- 2 Use the **^**, **v**, **<**, or **>** button to select **AUDIO**, then press the **OK** button.
- 3 Use the **^**, **v**, **<**, or **>** button to set up the desired item, then press the **OK** button.
 - To return to the previous menu, press the **↶** **BACK** button.
- 4 Press the **EXIT** button when completed.



The available sound settings are as follows:

Item	Description
Sound Mode	Adjusts sound.
	Mode
	Standard Selects a standard sound.
	Music Select when listening to music.
	Movie Select when watching a movie.
	Sport Select when watching sports events.
	Game Select when playing a game.
User Set-ting	Audio-band (100 Hz / 300 Hz/ 1 kHz/ 3 kHz / 10 kHz) can be adjusted from -10 to 10. Reset: Restores all the settings to the factory default.
Clear Voice II	Makes the voice from the projector crisp and clear.
Auto Volume	Automatically adjusts the volume level.

TIME Settings

- 1 Press the **SETTINGS** button.
- 2 Use the \wedge , \vee , \lt , or \gt button to select **TIME**, then press the **OK** button.
- 3 Use the \wedge , \vee , \lt , or \gt button to set up the desired item, then press the **OK** button.
 - To return to the previous menu, press the **BACK** button.
- 4 Press the **EXIT** button when completed.

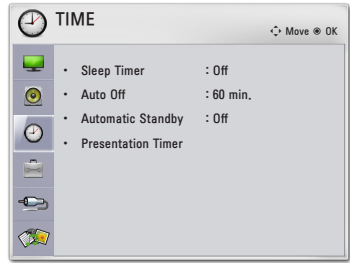

The available time settings are as follows:

Item	Description	
Sleep Timer	Sets the projector to turn off at a specified time.	
Auto Off	If there is no signal, the projector automatically turns off after the preset time has elapsed.	
Automatic Standby	Turns off the projector automatically if there is no input for the given time.	
Presentation Timer	Time Alarm	<p>Displays an alarm at the specified time.</p> <p>* If you set the time to 5 minutes, the time is displayed on the screen at 1-minute intervals. If you set the time to 10 minutes or more, the time is displayed at 5-minute intervals. If the remaining time is less than 5 minutes, it is displayed at 1-minute intervals.</p> <p>* You can set the time to 5, 10... 60 minutes in 5-minute increments.</p>
	Time Keeper	<p>Displays the time remaining until the time specified on the screen.</p> <p>* Between 1 and 10 minutes, the time can be set in increments of 1 minute and, between 10 and 60 minutes, in increments of 5 minutes.</p>

OPTION Settings

- 1 Press the **SETTINGS** button.
- 2 Use the \wedge , \vee , \lt , or \gt button to select **OPTION**, then press the **OK** \odot button.
- 3 Use the \wedge , \vee , \lt , or \gt button to set up the desired item, then press the **OK** \odot button.
 - To return to the previous menu, press the \curvearrowright **BACK** button.
- 4 Press the **EXIT** button when completed.

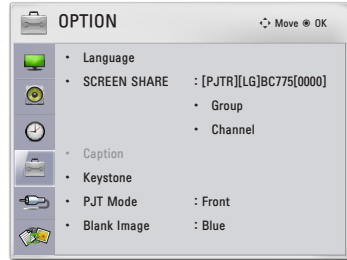

The available option settings are described below:

Item	Description						
Language	Selects the desired language.						
SCREEN SHARE	The SCREEN SHARE displays the screen of the connected device. <ul style="list-style-type: none"> • You can check the SCREEN SHARE's ID. <table border="1" style="width: 100%; border-collapse: collapse;"> <thead> <tr> <th colspan="2">Item</th> </tr> </thead> <tbody> <tr> <td style="width: 20%;">Group</td> <td>This is the Group setting for each device supporting the SCREEN SHARE feature. When the wireless connection is weak or unstable, adjust the Group setting to correct the problem.</td> </tr> <tr> <td>Channel</td> <td>You can change the channel used for wireless connections. <ul style="list-style-type: none"> • Search Channels: Select channel searching methods. <ul style="list-style-type: none"> - Auto: The projector searches for available channels and automatically selects the least used channel. - Manual: You can select a channel manually. • Channel: This is shown when Search Channels is set to Manual. It allows you to specify a channel number to use. </td> </tr> </tbody> </table>	Item		Group	This is the Group setting for each device supporting the SCREEN SHARE feature. When the wireless connection is weak or unstable, adjust the Group setting to correct the problem.	Channel	You can change the channel used for wireless connections. <ul style="list-style-type: none"> • Search Channels: Select channel searching methods. <ul style="list-style-type: none"> - Auto: The projector searches for available channels and automatically selects the least used channel. - Manual: You can select a channel manually. • Channel: This is shown when Search Channels is set to Manual. It allows you to specify a channel number to use.
Item							
Group	This is the Group setting for each device supporting the SCREEN SHARE feature. When the wireless connection is weak or unstable, adjust the Group setting to correct the problem.						
Channel	You can change the channel used for wireless connections. <ul style="list-style-type: none"> • Search Channels: Select channel searching methods. <ul style="list-style-type: none"> - Auto: The projector searches for available channels and automatically selects the least used channel. - Manual: You can select a channel manually. • Channel: This is shown when Search Channels is set to Manual. It allows you to specify a channel number to use. 						
Caption	Turns subtitles On/Off when Korean is used for the AV input.						
Keystone	To prevent the screen image from becoming trapezoidal, Keystone adjusts the top and bottom width of the image if the projector is not set up at a right angle to the screen.						
PJT Mode	Turns the projected image upside down or flips it horizontally. <ul style="list-style-type: none"> • Select Rear to project an image onto the back of a transparent screen (purchased separately). • Select Front Ceiling if you installed the projector onto a ceiling. 						
Blank Image	Select the background for the blank image. (See 26 page)						

Item	Description			
Auto Power	Make the projector turn on automatically when the power cord is connected.			
	Item			
	<table border="1"> <tr> <td data-bbox="273 308 389 371">On</td> <td data-bbox="389 308 1016 371">The projector turns on automatically when the power cord is connected to the projector.</td> </tr> <tr> <td data-bbox="273 371 389 437">Off</td> <td data-bbox="389 371 1016 437">The projector goes into standby mode when the power cord is connected to the projector.</td> </tr> </table>	On	The projector turns on automatically when the power cord is connected to the projector.	Off
On	The projector turns on automatically when the power cord is connected to the projector.			
Off	The projector goes into standby mode when the power cord is connected to the projector.			
Auto Input Search	Automatically searches and displays an input signal type when it is received.			
High Altitude	When using the projector at an altitude of 1200 m or higher, set this option to "On." Using the projector without changing the High Altitude option may result in overheating or activation of the projector's protection functions. If this happens, turn the projector off and then on again after waiting several minutes.			
Monitor Out	Selects one of the two connected RGB input videos as monitor out. "Auto" mode outputs the "RGB1" or "RGB2" input that is currently being displayed.			
DivX(R) VOD	Sets DivX-related settings.			
Initial Setting	Resets all projector settings to the factory default.			
Set ID	If the projector is connected to a PC through an RS-232C cable, you can use the PC to control functions of the projector such as power On/Off and input selection.			
eZ-Net Manager	Allows you to control one or more projectors easily through a local area network.			
Lamp Use Time	Checks lamp usage time.			
Self Diagnosis	Troubleshoots functional problems that can arise while using the product.			

CONNECTING EXTERNAL DEVICES

You can connect various external devices to the projector.

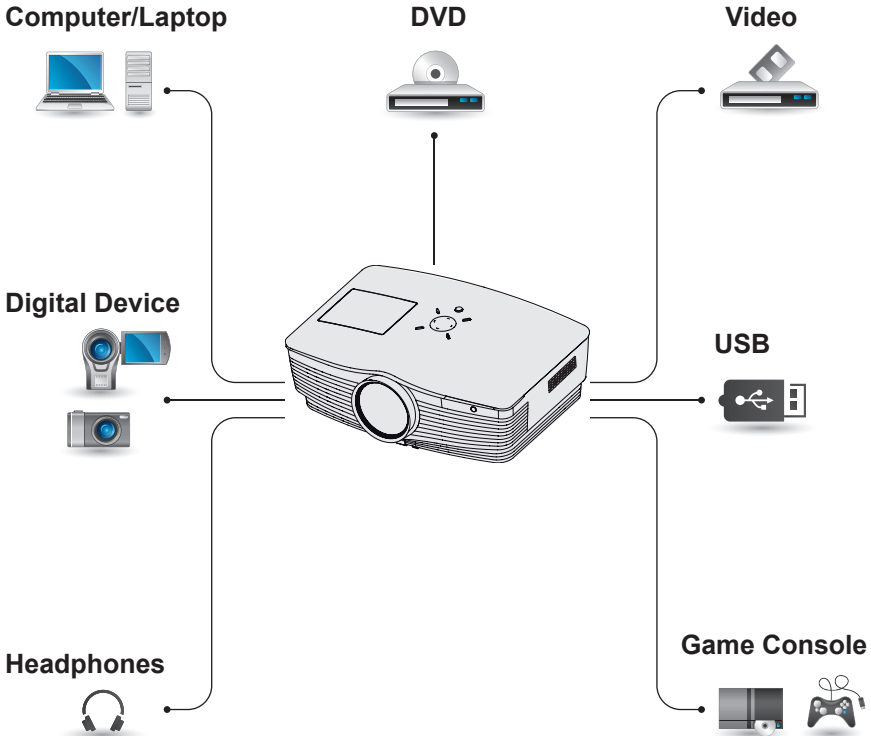

HDMI - 52 page
 Component 1, Component 2 - 54 page
 Input (AV) - 54 page
 RGB1, RGB2 - 53 page
 Memory - 28 page
 Headphones - 55 page

Connecting an HD Receiver, DVD Player, or VCR

Connect an HD receiver, DVD Player or VCR, then select an appropriate input mode.

HDMI Connection

With an HDMI cable, you can enjoy high-quality picture and sound. Connect the **HDMI IN** connector of a projector to the HDMI output connector. Press the **INPUT** button on the remote control to select **HDMI**.

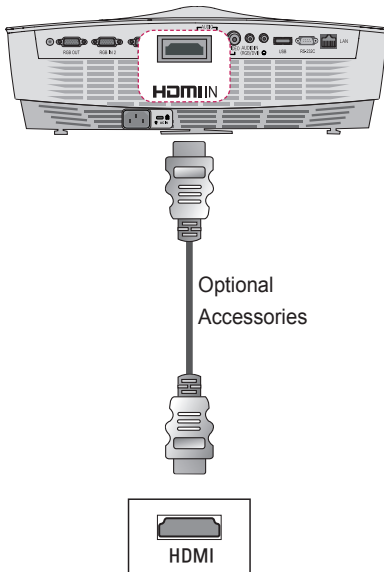

HDMI to DVI Connection

Connect the **HDMI IN** connector of a projector to the DVI output connector using a HDMI-to-DVI cable. For the audio signal, connect using an audio cable. Press the **INPUT** button on the remote control to select **HDMI**.

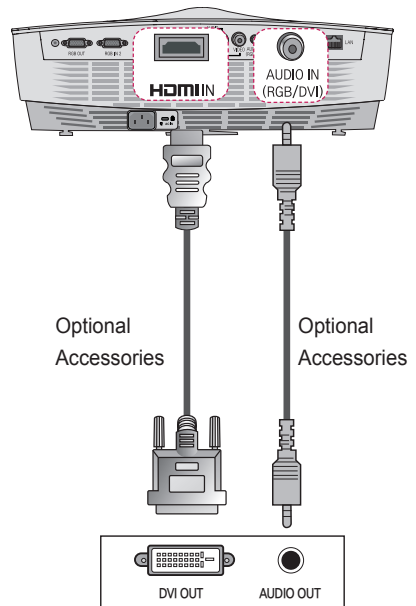

Connecting a PC

The projector supports plug and play. Your PC automatically detects plug and play devices and requires no driver installation.

RGB Connection

Connect the PC output and the PC video input port of the projector using the RGB cable. Connect the **RGB IN 1** or **RGB IN 2** connector of a projector to the DVI output connector. For the audio signal, connect the PC and projector using an optional audio cable.

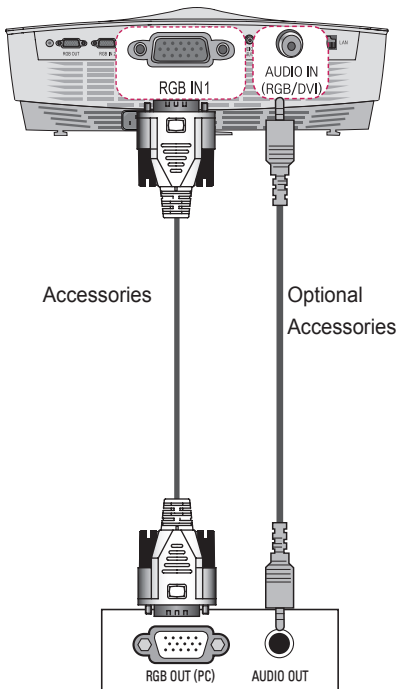

RGB to DVI Connection

Connect the **RGB IN 1** or **RGB IN 2** connector of a projector to the DVI output connector.

For the audio output, connect the PC and the projector using an audio cable.

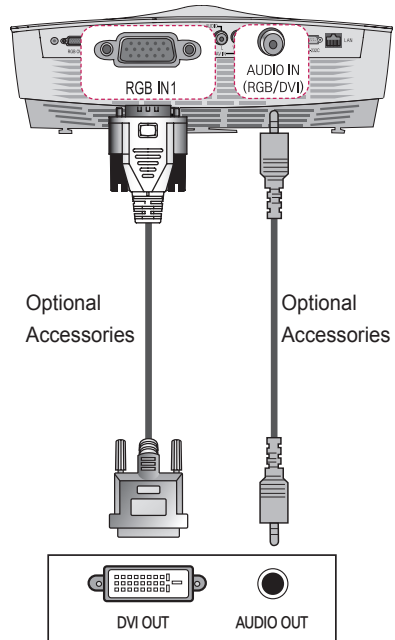

AV Connection

AV Connection

Connect the output ports of an external device and the AV INPUT port of the projector. Press the **INPUT** button on the remote control to select **AV**.

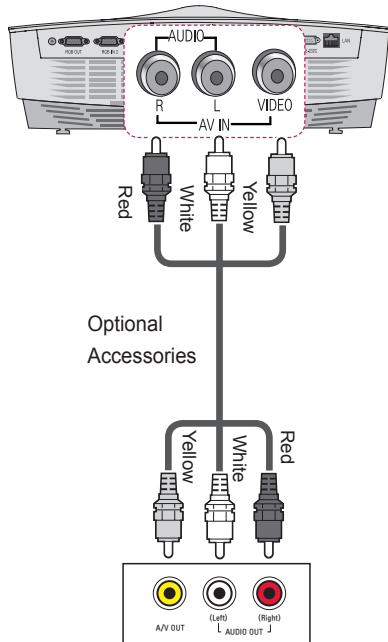

Component Connection

Enjoy vivid images when you connect an external device with a component port to the RGB In port of the projector. Press the **INPUT** button on the remote control to select **Component**.

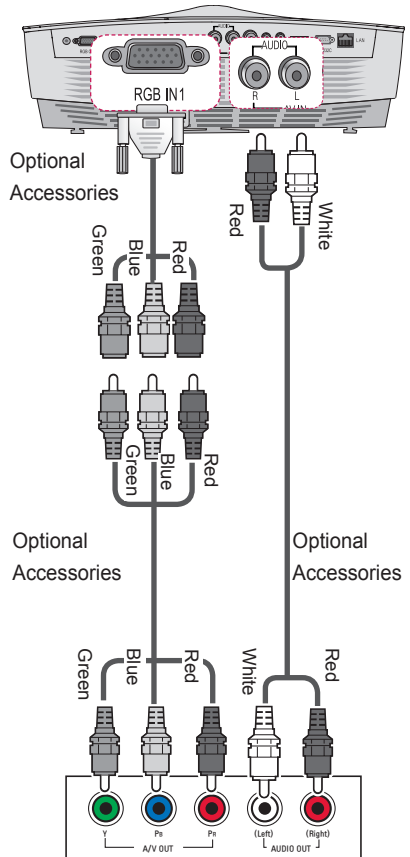

Connecting Headphones

You can listen to the audio through headphones.

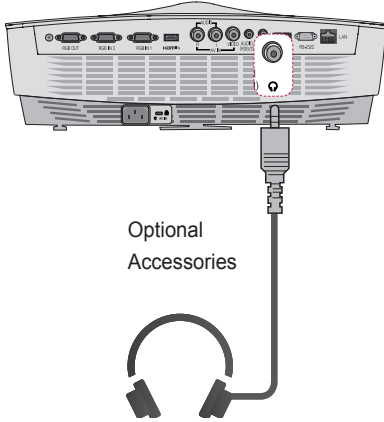

Connecting a Laptop

You can connect the projector to a laptop for various functions.

RGB Connection

You can connect your laptop to the **RGB In 1** or **RGB In 2** port of the projector.

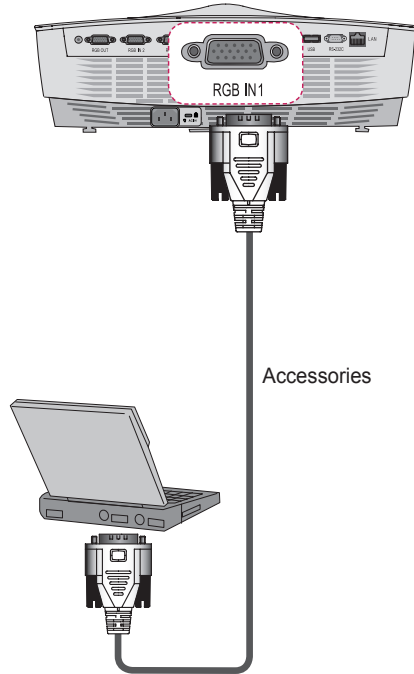

MAINTENANCE

Clean your projector to keep it in optimal condition.

Cleaning

Cleaning the Lens

If there is any dust or staining on the lens surface, you must clean the lens. Use an air spray or a cleaning cloth to clean the lens.

To remove dust or stains, use an air spray or apply a small amount of cleaning agent to a swab or soft cloth and gently rub the lens.

Make sure that liquid does not flow into the lens if the product is sprayed directly onto the lens.

Cleaning the Projector Case

To clean the projector case, first unplug the power cord.

To remove dust or stains, use only a soft, dry, lint-free cloth.

Do not use alcohol, benzene, thinners, or other chemicals, as they may damage the case.

Cleaning the Vents

Dust and foreign material tend to adhere to the vents.

It is important to use a vacuum cleaner to periodically remove dust and foreign material.

Using the projector with excessive dust around the vents may cause the internal components to overheat and malfunction.

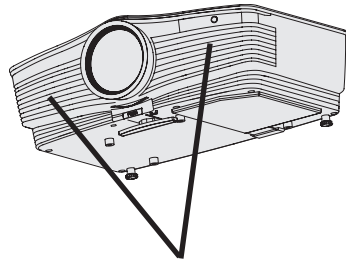

Outflow vents

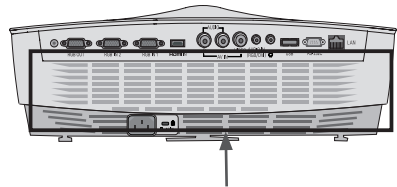

Inflow vents

Replacing the lamp

1 Turn off the projector, unplug the power cable from the outlet, and then place the projector onto a table or flat surface.

- Allow the lamp to cool for 1 hour before removing the used lamp from the projector; it is very hot.

2 Use a screwdriver or similar object to remove the screw from the side. After removing the screw, tilt the lamp cover upward in the direction of the arrow. Do not pull the cover vertically. If the lamp cover cannot be lifted, press part "A."

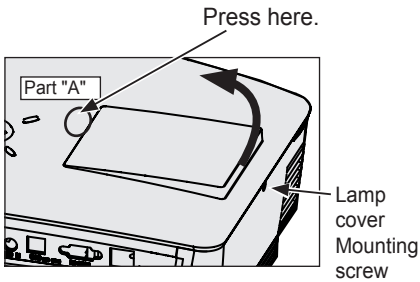

3 After opening the lamp cover, unscrew the 2 screws that hold the lamp using a screwdriver or its equivalent.

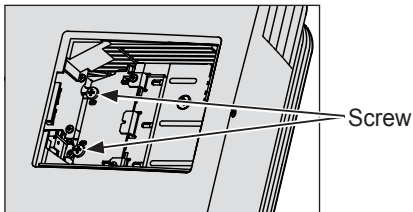

4 Pull out the lamp knob from the hitch.
Lamp knob

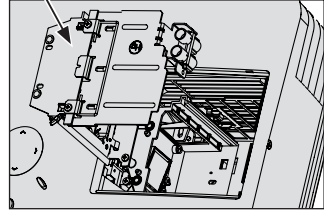

5 Hold the lamp and pull it out slowly to remove the lamp case.

6 Carefully insert the new lamp case into the correct position. (Check to see that it is correctly positioned.)

7 Tighten the screws you removed in step 3. (Check to see that the lamp is securely fixed.)

8 Close the lamp cover and tighten the screw loosened in step 2 to fix the cover.

- If you turn on the projector while the lamp cover is open, the lamp warning indicator flashes green and the projector does not turn on.

! NOTE

- Make sure to use the same type of lamp for replacement. If the lamp cover is not closed correctly, the projector does not turn on. In this case, check that the lamp is correctly mounted. If the problem persists, contact the LG Electronics Service Center.

Mounting the Lens Cap

- 1 Prepare the lens cap and strap supplied as accessories. Put the knotless end of the strap through the hole at the bottom of the projector lens.

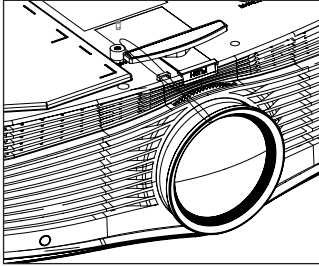

- 2 Put the knotless end of the strap inside and pull it to fix it onto the projector hole.

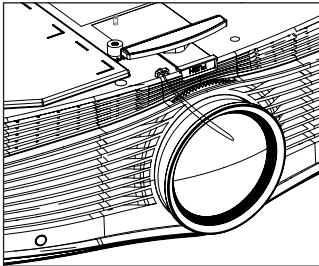

- 3 Insert the other end of the strap into the hole of the lens cap, and then pass the lens cap through the strap.

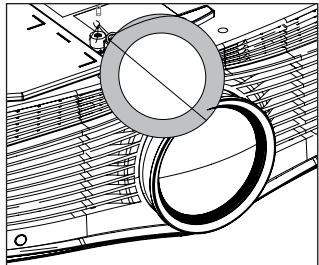

- 4 The lens cap is mounted as illustrated.

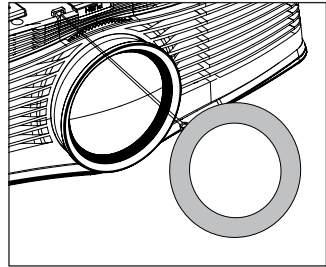

Serial Communication Function

Using Serial Communication

If the projector is connected to a PC through an RS-232C cable, you can use the PC to control projector functions such as power On/Off and input selection. It cannot be used with the eZ-Net Manager concurrently. For serial communication, set LAN to Off in the eZ-Net Manager. This function may not be available for a particular menu or input mode.

Establishing Serial Communication

Connect the RS-232C (serial connector) of the PC to the RS-232C connector at the back of the projector. You must purchase a cable to connect the RS-232C connectors, as it is not provided as an accessory.

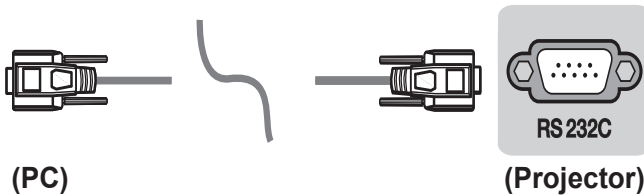

* A RS-232C cable is necessary for the remote control of the projector (see Figure 1).

[Figure 1] RS-232 Connection Diagram



* There is no connection to Pin 1 and Pin 9.

Communication Parameter Setup

- Baud Rate: 9600 bps (UART)
- Data Length: 8 bits
- Parity: None
- Stop bit: 1 bit
- Flow Control: None
- Communication code: ASCII code

Communication Protocol

1. Transmission

[Command1] [Command2] [] [Set ID] [] [Data] [Cr]

- * [Command1]: The first command to control the projector (k, j, x, m, n ASCII code, 1 Character)
- * [Command2]: The second command to control the projector (ASCII code, 1 character)
- * [Set ID]: You can adjust the set ID to choose desired monitor ID number in option menu. Adjustment range is 1 to 99. When selecting Set ID '0', every connected set is controlled. Set ID is indicated as decimal (1 to 99) on menu and as Hexa decimal (0x0to 0x63) on transmission/receiving protocol.
- * [Data]: To transmit command data (hexadecimal). Transmit 'FF' data to read status of command.
- * If the data is 'FF', it means data read mode.
- * [Cr]: Carriage Return
It corresponds to ASCII code '0x0D'.
- * []: ASCII code 'space (0x20)

2. OK Acknowledgement

[Command2] [] [Set ID] [] [OK] [Data] [x]

- * The set transmits ACK (acknowledgement) based on this format when receiving normal data. At this time, if the data is data read mode, it indicates present status data. If the data is data write mode, it returns the data of the PC computer.

3. Error Acknowledgement

[Command2] [] [Set ID] [] [NG] [Data] [x]

- * If a set receives an abnormal piece of data, such as a unsupported function, or there is a communication error, it returns ACK in the above format.
- Data [01]: illegal code
(This command is not supported.)

Data Structure

10	16																		
0	00	10	16	10	16	10	16	10	16	10	16	10	16	10	16	10	16	10	16
1	01	11	0B	21	15	31	1F	41	29	51	33	61	3D	71	47	81	51	91	5B
2	02	12	0C	22	16	32	20	42	2A	52	34	62	3E	72	48	82	52	92	5C
3	03	13	0D	23	17	33	21	43	2B	53	35	63	3F	73	49	83	53	93	5D
4	04	14	0E	24	18	34	22	44	2C	54	36	64	40	74	4A	84	54	94	5E
5	05	15	0F	25	19	35	23	45	2D	55	37	65	41	75	4B	85	55	95	5F
6	06	16	10	26	1A	36	24	46	2E	56	38	66	42	76	4C	86	56	96	60
7	07	17	11	27	1B	37	25	47	2F	57	39	67	43	77	4D	87	57	97	61
8	08	18	12	28	1C	38	26	48	30	58	3A	68	44	78	4E	88	58	98	62
9	09	19	13	29	1D	39	27	49	31	59	3B	69	45	79	4F	89	59	99	63
10	0A	20	14	30	1E	40	28	50	32	60	3C	70	46	80	50	90	5A	100	64

Command Reference List

	Command 1	Command 2	Data (Hexadecimal)
01. Power	k	a	00 - 01
02. Aspect Ratio	k	c	*
03. Blank Image	k	d	00 - 01
04. Contrast	k	g	00 - 64
05. Brightness	k	h	00 - 64
06. Color	k	i	00 - 64
07. Tint	k	j	00 - 64
08. Sharpness	k	k	00 - 32
09. OSD Control	k	l	00 - 01
10. Key Lock	k	m	00 - 01
11. Color Temp	k	u	00 - 04 (excluding 03)
12. Black Level	n	m	00 - 01
13. Energy Saving	n	p	00 - 01
14. Auto Configure	j	u	01
15. Input	x	b	*
16. Key	m	c	Key Code
17. Picture Mode	n	s	00 - 07
18. Mute	k	e	00 - 01
19. Volume	k	f	00 - 64
20. Monitor Out	n	r	00 - 02

- For more information on the data (*), refer to next page.
- When playing a video or photo file stored on a storage media (USB memory stick or HDD, etc.) that is connected through USB, all commands are disabled, other than Power (ka), Key (mc). If a command cannot be used in a specific menu or input state, it is processed as NG.

01. Power (Command: ka)

⇒ Powers the set on/off.

Transmission

[k][a][Set ID][Data][Cr]

Data 00: Power Off
01: Power On

Ack

[a][Set ID][OK][Data][x]

Data 00: Power Off
01: Power On

⇒ Shows the power on status.

Transmission (Only working when the projector is turned on).

Transmission

[k][a][Set ID][FF][Cr]

Ack

[a][Set ID][OK][Data][x]

Data 01: Power On

* As with other functions, if data is transmitted as '0xFF' in the above format, the current status of each function is returned as a feedback in Ack data.

02. Aspect Ratio (Command: kc)

⇒ Adjusts the aspect ratio.

Transmission

[k][c][Set ID][Data][Cr]

Data 01 : 4:3
02 : 16:9
04: Zoom
06: Set by Program
09 : Original
10 - 1f: Cinema Zoom 1 - 16

Ack

[c][Set ID][OK][Data][x]

Data 01 : 4:3
02 : 16:9
04: Zoom
06: Set by Program
09 : Original
10 - 1f: Cinema Zoom 1 - 16

03. Blank Image (Command: kd)

⇒ Enables/disables the blank image.

Transmission

[k][d][Set ID][Data][Cr]

Data 00: Disables blank image (picture on)
01: Enables the blank image (picture off).

Ack

[d][Set ID][OK][Data][x]

Data 00: Disables blank image (picture on)
01: Enables the blank image (picture off).

04. Contrast (Command: kg)

⇒ Adjusts screen contrast.
Disabled when Black Mode is selected.

Transmission

```
[k][g][Set ID][Data][Cr]
```

Data Min: 0H - Max: 64H
(* Transmitted in hexadecimal code)
* See the data structure.

Ack

```
[g][Set ID][OK][Data][x]
```

Data Min: 0H - Max: 64H

06. Color (Command: ki)

⇒ Adjusts the color.
Disabled when Black Mode is selected.

Transmission

```
[k][i][Set ID][Data][Cr]
```

Data Min: 0H - Max: 64H
(* Transmitted in hexadecimal code)
* See the data structure.

Ack

```
[i][Set ID][OK][Data][x]
```

Data Min: 0H - Max: 64H

05. Brightness (Command: kh)

⇒ Adjusts screen brightness.
Disabled when Black Mode is selected.

Transmission

```
[k][h][Set ID][Data][Cr]
```

Data Min: 0H - Max: 64H
(* Transmitted in hexadecimal code)
* See the data structure.

Ack

```
[h][Set ID][OK][Data][x]
```

Data Min: 0H - Max: 64H

07. Tint (Command: kj)

⇒ Adjusts the tint.
Disabled when Black Mode is selected.

Transmission

```
[k][j][Set ID][Data][Cr]
```

Data Red: 0H - Green: 64H
(* Transmitted in hexadecimal code)
* See the data structure.

Ack

```
[j][Set ID][OK][Data][x]
```

Data Red: 0H - Green: 64H

08. Sharpness (Command: kk)

⇒ Adjusts the sharpness.
 Disabled when Black Mode is selected.

Transmission

[k][k][Set ID][Data][Cr]

Data Min: 0H - Max: 32H
 (* Transmitted in hexadecimal code)
 * See the data structure.

Ack

[k][Set ID][OK][Data][x]

Data Min: 0H - Max: 32H

09. OSD Control (Command: kl)

⇒ Selects OSD On/Off.

Transmission

[k][l][Set ID][Data][Cr]

Data 00: OSD selection mode off
 01: OSD selection mode on

Ack

[l][Set ID][OK][Data][x]

Data 00: OSD selection mode off
 01: OSD selection mode on

10. Key Lock (Command: km)

⇒ To Set the function of locking the remote control and front panel control on the projector.

Transmission

[k][m][Set ID][Data][Cr]

Data 00 : Disables the key lock.
 01 : Enables the key lock.

Ack

[m][Set ID][OK][Data][x]

Data 00 : Disables the key lock.
 01 : Enables the key lock.

* This function is configured when the keys on the remote control or control panel are not used. If the unit is fully discharged after its power plug is pulled out of a wall outlet, the LOCK function is cleared.

* If the unit is in the key lock standby mode, the projector will not respond to the power button on the remote control or control panel..

11. Color Temperature (Command: ku)

⇒ Adjusts the color temperature value.
 Disabled when Black Mode is selected.

Transmission

[k][u][Set ID][Data][Cr]

Data 00: Medium 01: Cool
 02: Warm 04: Natural
 (* Transmitted in hexadecimal code)

*Data 03 is not used.

Ack

[u][Set ID][OK][Data][x]

Data 00: Medium 01: Cool
 02: Warm 04: Natural

12. Black Level (Command: nm)

⇒ Adjusts the black level value. Disabled when Black Mode is selected.

Transmission

```
[n][m][Set ID][Data][Cr]
```

Data 00: Low 01: High
(* Transmitted in hexadecimal code)

Ack

```
[m][Set ID][OK][Data][x]
```

Data 00: Low 01: High

13. Energy Saving (Command: np)

⇒ Sets energy saving mode.

Transmission

```
[n][p][Set ID][Data][Cr]
```

Data 00: Minimum
01: Maximum
(* Transmitted in hexadecimal code)

Ack

```
[p][Set ID][OK][Data][x]
```

Data 00: Minimum
01: Maximum

14. Auto Configure (Command: ju)

⇒ Optimizes the screen automatically in PC input mode.

Transmission

```
[j][u][Set ID][Data][Cr]
```

Data 01: To set
(* Transmitted in hexadecimal code)

Ack

```
[u][Set ID][OK][Data][x]
```

Data 01: To set

15. Input (Command: xb)

⇒ Select the input signal of the set.

Transmission

```
[x][b][Set ID][Data][Cr]
```

Data 20: External input
40: Component 1
41: Component 2
60: RGB 1
61: RGB 2
90: HDMI
(* Transmitted in hexadecimal code)

Ack

```
[b][Set ID][OK][Data][x]
```

Data 20: External input
40: Component 1
41: Component 2
60: RGB 1
61: RGB 2
90: HDMI
(* Transmitted in hexadecimal code)

16. Key (Command: mc)

⇒ Sends a key code of the IR remote control.

Transmission

[m][c][Set ID][Data][Cr]

Data Key Code: see 67 page .
(* Transmitted in hexadecimal code)

Ack

[c][Set ID][OK][Data][x]

Data Key Code

17. Picture Mode (Command: ns)

⇒ Sets the picture mode.

Transmission

[n][s][Set ID][Data][Cr]

Data 00: Vivid
01: Standard
02: ECO
03: Cinema
04: Game
05: Expert 1
06: Expert 2
07: Black Mode
(* Transmitted in hexadecimal code)

Ack

[s][Set ID][OK][Data][x]

Data 00: Vivid
01: Standard
02: ECO
03: Cinema
04: Game
05: Expert 1
06: Expert 2
07: Black Mode
(* Transmitted in hexadecimal code)

18. Mute (Command: ke)

⇒ Enables/disables the mute function.

Transmission

[k][e][Set ID][Data][Cr]

Data 00 : Turns on the mute function (volume off).
01 : Turns off the mute function (volume on).

Ack

[e][Set ID][OK][Data][x]

Data 00 : Turns on the mute function (volume off).
01 : Turns off the mute function (volume on).

19. Volume (Command: kf)

⇒ Adjusts the volume.

Transmission

[k][f][Set ID][Data][Cr]

Data Min: 0H - Max: 64H
(* Transmitted in hexadecimal code)
* See the data structure.

Ack

[f][Set ID][OK][Data][x]

Data Min : 0H(Vol 0) - Max : 64H(Vol 100)

20. Monitor Out (Command: nr)

⇒ Select either RGB1 or RGB2 input as an output of the RGB OUT port.

Transmission

[n][r][Set ID][Data][Cr]

Data 00 : RGB 1 01 : RGB 2
02: Auto

Ack

[r][Set ID][OK][Data][x]

Data 00 : RGB 1 01 : RGB 2
02: Auto

Key Code

Key Name	Key Code	Key Name	Key Code
∧	0x40	YELLOW	0x63
∨	0x41	BLUE	0x61
>	0x06	Key's	0xA4
<	0x07	USB	0x7C
POWER	0xAD	MUTE	0x09
INPUT	0xEF	STILL	0xBC
SETTINGS	0x43	EXIT	0x5B
↶ BACK	0x28	■	0xB1
OK ●	0x44	▶	0xB0
ENERGY SAVING	0x95		0xBA
RATIO	0x79	◀◀	0x8F
BLANK	0x84	▶▶	0x8E
PICTURE	0x4D	TIMER	0x26
AUTO	0x92	PAGE ∧	0x00
Q.MENU	0x45	PAGE ∨	0x01
SLEEP	0x0E		
SOUND	0x52		
VOL +	0x02		
VOL -	0x03		
RED	0x72		
GREEN	0x71		

SPECIFICATIONS

MODELS	BC775 (BC775-JD)	
Resolution (pixels)	1024 (H) × 768 (V)	
Aspect ratio	4:3 (H:V)	
Panel size (mm)	17.78	
Projection distance (video size)	Wide: 1000 - 7500 mm Tele: 1198 - 8684 mm	
Ratio of upward projection	100 %	
Remote control range	12 m	
Audio output	7 W MONO	
Reception type	NTSC M, NTSC 4.43, PAL-B/D/G/H/I PAL M, PAL N, PAL 60, SECAM	
Height (mm)	148.5 (including stands)	
Width (mm)	403.3	
Depth (mm)	295.5	
Weight (kg)	6.2	
Headphone, earphone	Impedance: 16 Ω / Output power: 10 mW / Jack thickness: 3.5 mm	
USB	5 V, 0.5 A (max.)	
Power sources	AC 100 to 240 V, 50 Hz / 60 Hz	
Operating environment	Temperature	
	Operation	0 °C - 40 °C
	Storage	-20 °C - 60 °C
	Relative humidity	
	Operation	0 % - 80 %
	Storage	0 % - 85 %

- The images used and specifications stated in this owner's manual are subject to change to improve the performance of the product.
- The power consumption of this projector is 0.5 W or lower when in standby mode. Therefore, unplug the power plug from the outlet to prevent unnecessary power consumption when you do not use the projector for a long time.

Supported Monitor Displays

Resolution	Horizontal Frequency (kHz)	Vertical Frequency (Hz)
640 x 350	31.468	70.09
640 x 480	31.469	59.94
720 x 400	31.469	70.08
800 x 600	37.879	60.31
1024 x 768	48.363	60.00
1152 x 864	54.348	60.053
1280 x 800	49.7	59.81
1280 x 1024	63.981	60.02
1400 x 1050	65.3	60
1680 x 1050	65.3	59.95

- If an invalid signal is input into the product, it is not displayed properly on the screen or a message, such as “No Signal” or “Invalid Mode,” is displayed.
- This product supports the DDC1/2B plug-and-play protocol (auto-recognition of PC monitor).
- PC synchronization signal types supported: Separate synchronization type.
- 1024 x 768 is recommended for best picture quality in PC mode.

Supported HDMI/DVI-DTV Modes

Resolution	Horizontal Frequency (kHz)	Vertical Frequency (Hz)
480p	31.47	60
	31.47	59.94
	31.5	60
576p	31.25	50
720p	45	60
	44.96	59.94
	37.5	50
1080i	33.75	60
	33.72	59.94
	28.125	50
1080p	67.5	60
	67.432	59.939
	27	24
	26.97	23.976
	33.75	30
	33.71	29.97
	56.25	50

Component Port Connection

Signal	Component
480i/576i	o
480p/576p	o
720p/1080i	o
1080p	o

**Open Source Software
Information**

To obtain the source code under GPL, LGPL, MPL and other open source licenses, that is contained in this product, please visit <http://opensource.lge.com>. In addition to the source code, all referred license terms, warranty disclaimers and copyright notices are available for download.

LG Electronics will also provide open source code to you on CD-ROM for a charge covering the cost of performing such distribution (such as the cost of media, shipping and handling) upon email request to opensource@lge.com. This offer is valid for three (3) years from the date on which you purchased the product.



The model and serial number of the projector are located on the back or on the side of the projector. Record them below should you ever need service.

MODEL _____

SERIAL _____