

Acer Projector  
P5227/P5327W/P1285i/  
P1285B/P1385Wi/P1385WB/  
S1385WHBe/S1385WHne  
Series User's Guide

# First Thing First

## Usage Notes

Do:

- Turn off the product before cleaning.
- Use a soft cloth moistened with mild detergent to clean the display housing.
- Disconnect the power plug from AC outlet if the product is not being used for a long period of time.

Don't:

- Block the slots and openings on the projector provided for ventilation.
- Use abrasive cleaners, waxes or solvents to clean the unit.
- Use under the following conditions:
  - In extremely hot, cold or humid environments.
  - In areas susceptible to excessive dust and dirt.
  - Near any appliance that generates a strong magnetic field.
  - Place in direct sunlight.

## Precautions

Follow all warnings, precautions and maintenance as recommended in this user's guide to maximize the life of your unit.



### Warning:

- Do not look into the projector's lens when the lamp is on. The bright light may hurt your eyes.
- To reduce the risk of fire or electric shock, do not expose this product to rain or moisture.
- Please do not open or disassemble the product as this may cause electric shock.
- The product will detect the life of the lamp itself. Please contact your local dealer or Acer service center for changing the lamp, when lamp warning message displays.
- When switching the projector off, please ensure the projector completes its cooling cycle before disconnecting power.
- Turn on the projector first and then the signal sources.
- Do not use lens cap when projector is in operation.
- When the lamp reaches the end of its life, it will burn out and may make a loud popping sound. If this happens, the projector will not turn back on until the lamp module has been replaced. To replace the lamp, contact your local dealer or Acer service center.

Information for Your Safety and Comfort	iii
First Thing First	viii
Usage Notes	viii
Precautions	viii
Introduction	1
Product Features	1
Package Overview	2
Projector Overview	3
Projector Outlook	3
Control Panel	4
Remote Control Layout	5
MHL Feature Introduction	7
Getting Started	8
Connecting the Projector	8
Turning the Projector On/Off	10
Turning On the Projector	10
Turning Off the Projector	11
Adjusting the Projected Image	12
Adjusting the Height of the Projected Image	12
How to Optimize Image Size and Distance	13
How to Get a Preferred Image Size by Adjusting Distance and Zoom	18
User Controls	23
Installation Menu	23
Onscreen Display (OSD) Menus	24
Color	25
Image	27
Setting	30
Management	37
Audio	37
3D	38
Language	39
Appendices	40

# Contents

Troubleshooting	40
LED & Alarm Definition Listing	44
Using the inner connector(s)	45
Ceiling Mount Installation	46
Specifications	49
Compatibility Modes	53
<b>Regulations and safety notices</b>	<b>57</b>

# Introduction

## Product Features

This product is a single-chip DLP® projector, including the following outstanding features:

- DLP® technology
- P5227/P1285i/P1285B: Native 1024 x 768 XGA resolution, Auto/4:3/16:9 aspect ratio supported  
P5327W/P1385Wi/P1385WB/S1385WHBe/S1385WHne: Native 1280 x 800 WXGA resolution, Auto/Full/4:3 /16:9/L.BOX aspect ratio supported
- Enables projecting 3D content via DLP Link Technology: Blu-Ray 3D supported
- One-touch "3D" button on remote control allows quick and easy access to the 3D functions
- Acer ColorBoost technology delivers vivid, life-like images
- High brightness and contrast ratio
- Versatile display modes enable optimum performance in any situation
- NTSC/PAL/SECAM compatible and HDTV (720p, 1080i, 1080p) supported
- Lower power consumption and economy (ECO) mode extends lamp life
- Dynamic Black / ExtremeEco functions help decrease lamp power consumption and further extend lamp life.
  - Dynamic Black: If turned on, the projector dynamically adjusts the power consumption of the lamp according to the brightness of the image being projected. When projecting darker images the power consumption will be reduced and the contrast of the image will also be enhanced.
  - ExtremeEco: The projector will decrease the power consumption of the lamp by up to 70% when no input signal can be detected for 5 minutes.
- Acer EcoProjection Technology delivers Intelligent power management approach and physical efficiency improvement
- Advanced keystone correction delivers optimum presentations
- Multi-language Onscreen Display (OSD) menus
- Manual focus/zoom projection lens
- 2X digital zoom and pan move function
- Microsoft® Windows® 2000, XP, 7, 8, 8.1, Vista®, Macintosh OS compliant
- LAN settings enable remote management of projectors via a web browser
- Crestron compliant

# Package Overview

This projector comes with all the items shown below. Check to make sure you have them all. Contact your dealer immediately if any thing is missing.

S1385WH&amp;S1385WH&amp;e



Projector

P5227/P5327WP/1285/  
P1285B/P1385WP/P1385WB

Power cord



VGA cable



Security card



User's guide (CD-ROM)



Remote control

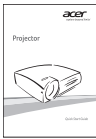

Quick start guide

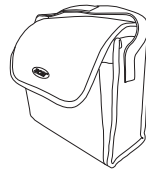
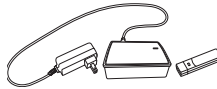
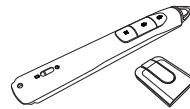

Battery x 2

Carrying case  
(Optional)Dust filter  
(Optional)WirelessHD dongle kit  
(MWIHD1) (Optional)SmartPen & PB dongle  
(Optional)

USB WiFi adapter (Optional)

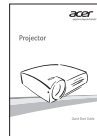
Acer Projector Multi-media  
(CD-ROM) (Optional)Acer Projector Multi-media  
quick start guide (Optional)

# Projector Overview

## Projector Outlook

### Front/upper side

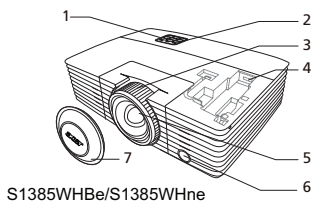

S1385WHBe/S1385WHne

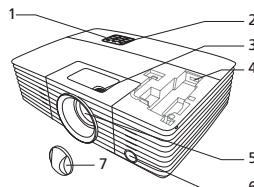
P5227/P5327W/P1285i/  
P1285B/P1385Wi/P1385WB

#	Description	#	Description
1	Control panel	4	HDMI (MHL) connector Micro USB cable
2	Power key and Power indicator LED	5	Projection lens
3	Zoom ring and Focus ring Focus ring	6	Remote control receiver
		7	Lens cap

### Rear side

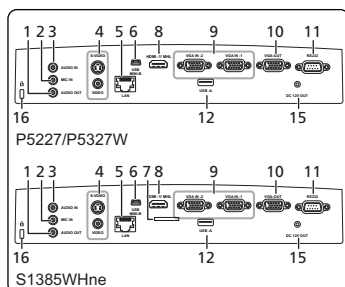

P5227/P5327W

S1385WHne

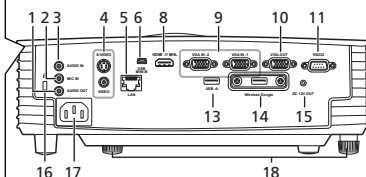

P1285i/P1285B/P1385Wi/P1385WB/S1385WHBe

#	Description	#	Description
1	Audio output connector	10	Monitor loop-through output connector
2	Microphone input connector	11	RS232 connector
3	Audio input connector	12	USB connector (Type A) (DC 5V output)
4	S-Video input connector Composite video input connector	13	USB connector (Type A)
5	LAN (RJ45 port for 10/100M Ethernet)	14	Wireless dongle connector (DC 5V output)
6	Mini USB connector	15	12V DC output connector
7	PB dongle slot	16	Kensington™ lock port
8	HDMI (MHL) connector	17	Power socket
9	Analog RGB signal/HDTV/ component video input connector	18	Tilt adjusting wheel

## Control Panel

P5227/P5327W/S1385WHne

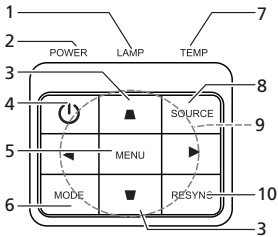
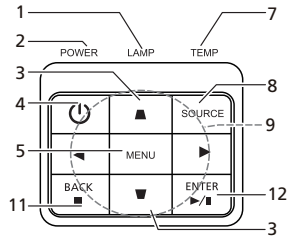

P1285i/P1285B/P1385Wi/  
P1385WB/S1385WHBe

#	Function	Description
1	LAMP	Lamp Indicator LED.
2	POWER indicator LED	Refer to the "Turning the Projector On/Off" section.
3	Keystone	Adjusts image distortion caused by tilting projection.
4	Power key	Refer to the "Turning the Projector On/Off" section.
5	MENU	Launches the Onscreen Display (OSD) menu, returns to the previous step for the OSD menu operation or exits the OSD menu.
6	MODE	Chooses a display mode.
7	TEMP	Temp Indicator LED.
8	SOURCE	Chooses RGB, component video, S-Video, composite video, HDMI (MHL) or HDTV source.
9	Four directional selection keys	Selects items or makes adjustments to your selection
10	RESYNC	Automatically synchronizes the projector to the input source.
11	BACK ■ Stop	Cancels your selection, or goes back to previous page. Stops the playing of media files.
12	ENTER ▶/⏸ Play/Pause	Confirms your selection of items. Plays/Pauses the playing of media files.

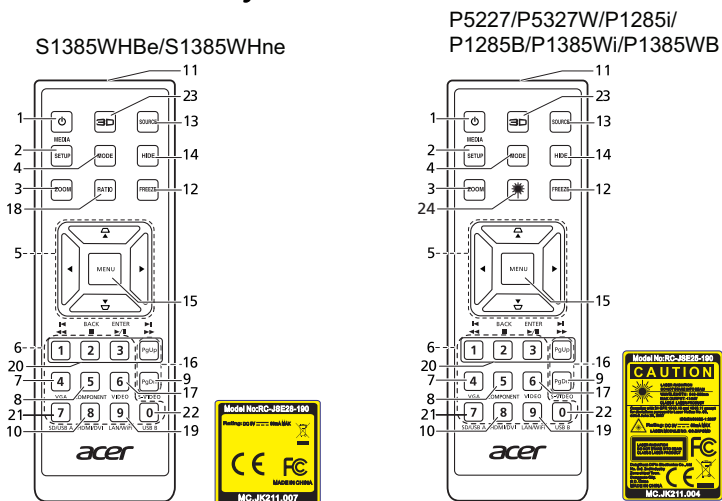

## Remote Control Layout



#	Function	Description
1	POWER	Refer to the "Turning the Projector On/Off" section.
2	MEDIA SETUP	Opens MEDIA SETUP page. (for P1285i/P1285B/P1385Wi/P1385WB/S1385WHBe)
3	ZOOM	Zooms the projector display in or out.
4	MODE	Chooses a display mode.
5	 Keystone  Four directional selection keys	Adjusts image distortion caused by tilting projection. Selects items or makes adjustments to your selection.
6	Keypad 0~9	Press "0~9" to input a password in the "Setting" > "Security" OSD.
7	VGA	To change source to VGA. This connection supports analog RGB, YPbPr (480p/576p/720p/1080i/1080p), and YCbCr (480i/576i).
8	COMPONENT	To change source to Component video. This connector supports YPbPr/YCbCr.
9	S-VIDEO	To change source to S-Video.
10	HDMI™/DVI	To change source to HDMI™ (or DVI). (for the model with HDMI™ or DVI connector)
11	Infrared transmitter	Sends signals to the projector.

#	Function	Description
12	FREEZE	To pause the screen image.
13	SOURCE	Chooses RGB, component video, S-Video, composite video, HDMI (MHL) or HDTV source.
14	HIDE	Press "HIDE" to hide screen image; press again to display the image.
15	MENU	Launches the Onscreen Display (OSD) menu, returns to the previous step for the OSD menu operation or exits the OSD menu.
16	PgUp/PgDn	For computer mode only. Use this button to select the next or previous page. This function is only available when connected to a computer via a USB cable.
17	VIDEO	To change source to composite video.
18	RATIO	Chooses an aspect ratio.
19	WIRELESS; LAN/WiFi	To change source to LAN/WiFi. (for LAN/wireless compatible models)
20	◀◀ Rewind ▶/⏸ Play/Pause ■ Stop ▶▶ Fast-forward	(No function)
21	SD/USB A	To change source to SD/USB A. This projector only supports files in JPEG format. (for S1385WHBe)
22	USB B	To change source to USB B. (for S1385WHBe)
23	3D	Press to open the 3D menu for adjusting 3D settings.
24	Laser	Emits visible laser pointer light for presentation purposes. This function is not available for the projectors sold in the Japanese market.

## MHL Feature Introduction

When your smart device is connected to the projector, you can use some buttons on the remote control to control your smart device. Press "MODE" for one second to enter or leave the MHL control mode. After entering the MHL control mode, press "SOURCE" to switch between the navigation mode (default), media mode and numeric mode.

#	Function		Description		
			Navigation mode	Media mode	Numeric mode
4	MODE		Long press for one second to enter or leave the MHL control mode.		
13	SOURCE		After entering the MHL control mode, press to switch between the navigation mode (default), media mode and numeric mode.		
5	 Four directional select keys	Up	Up	(No function)	(No function)
		down	down	(No function)	(No function)
		Left	Left	Decreases the volume.	(No function)
		Right	Right	Increases the volume.	(No function)
6	Keypad 0~9		(No function)	(No function)	Enters 0~9.
15	MENU		Goes to the root menu.	(No function)	(No function)
20	⏮ Rewind		(No function)	Rewinds/Plays/Pauses/Stops/Fast-forwards the playing of media files.	Enters 1.
	▶/⏸ Play/Pause		Selects or enters items.		Enters 2.
	■ Stop		Exits current page.		Enters 3.
	▶▶ Fast-forward		(No function)		(No function)

# Getting Started

## Connecting the Projector

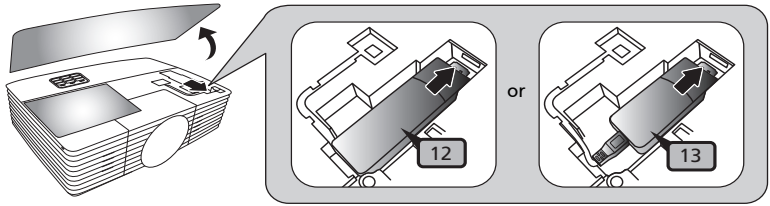
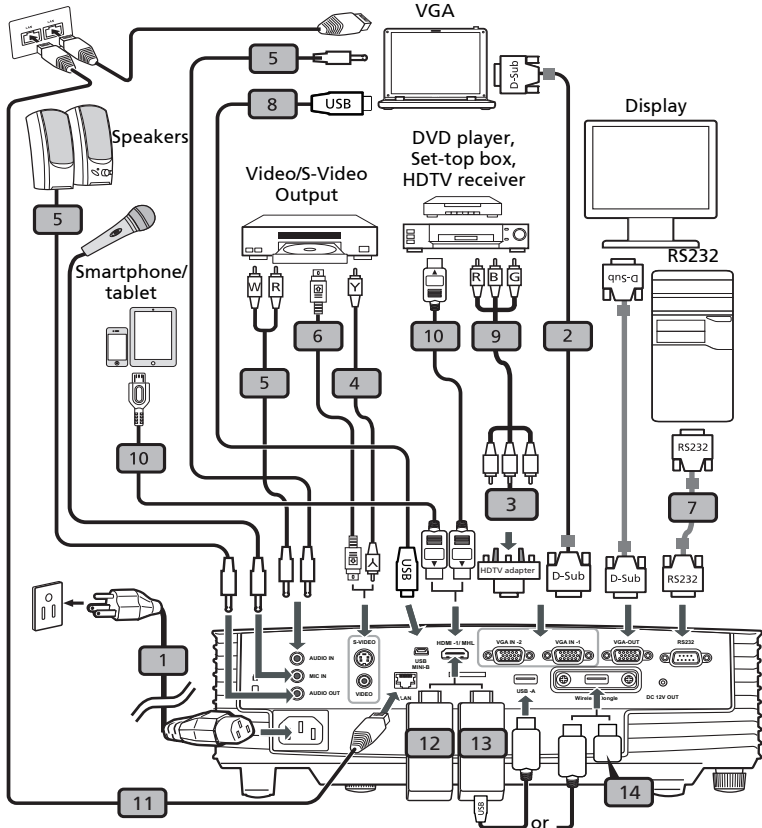

#	Description	#	Description
1	Power cord	9	3 RCA component cable
2	VGA cable	10	HDMI (MHL) cable
3	VGA to component video/HDTV adapter	11	RJ45 cable

#	Description	#	Description
4	Composite video cable	12	WirelessHD dongle
5	Audio cable	13	Wireless dongle
6	S-Video cable	14*	USB storage device/USB Wifi adapter (Optional)
7	RS232 cable		
8	USB cable		



.....

**Note:** To ensure the projector works well with your computer, please make sure the timing of the display mode is compatible with the projector.

**Note:** Some smart devices require a converter (supplied by the smart device maker) to enable the MHL function.

**Note:** Compatible HDMI/MHL dongles: WirelessHD (MWIHD1), MWA3, Android (MWND1), Chromecast™.

**Note:** "\*" USB drive limitation, do not support power.

# Turning the Projector On/Off

## Turning On the Projector

- 1 Ensure that the power cord and signal cable are securely connected. The Power LED will light red.
- 2 Turn on the projector by pressing  (POWER) on the control panel or remote control, and the Power indicator LED will turn blue.
- 3 Turn on your source (computer, notebook, video player, etc.). The projector will detect your source automatically (when the Source Lock function is disabled).
  - If the screen displays "No Signal", please make sure the signal cables are securely connected.
  - If you connect to multiple sources at the same time, use "SOURCE" on the control panel or remote control, or the direct source key on the remote control to switch between inputs.

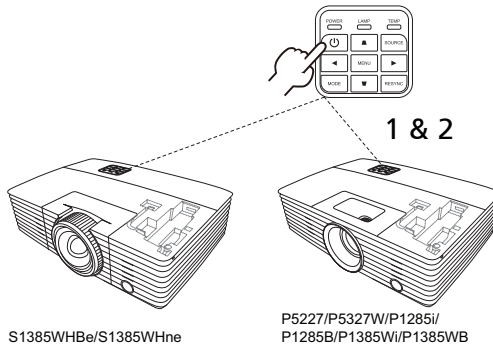

## Turning Off the Projector

- 1 To turn the projector off, press the power button. This message appears:  
**"Please press power button again to complete the shutdown process"**  
 Press the power button again.
- 2 The LED Power indicator will turn solid red to indicate standby mode.
- 3 It is now safe to unplug the power cord.

### When Instant Resume is selected:

- 1 The LED Power indicator will turn RED and blink rapidly after the projector is turned off, and the fan(s) will continue to operate for about 2 minutes to ensure that the system cools properly.
- 2 As long as the power cord remains plugged in, you can press the power button to turn the projector immediately back on anytime during the 2-minute shutdown process.
- 3 Once the system has finished cooling, the LED Power indicator will stop blinking and turn solid red to indicate standby mode.
- 4 It is now safe to unplug the power cord.



#### Warning indicators:

- **"Projector Overheated. Lamp will automatically turn off soon."**  
 This onscreen message indicates that the projector has overheated. The lamp will automatically turn off, the projector will automatically shut down, and the LED Temp indicator will turn solid red. Contact your local dealer or service center.
- **"Fan failed. Lamp will automatically turn off soon."**  
 This onscreen message indicates that the fan has failed. The lamp will automatically turn off, the projector will automatically shut down, and the LED Temp indicator will blink. Contact your local dealer or service center.



**Note:** Whenever the projector automatically shuts down and the LED Temp indicator turns solid red, contact your local reseller or service center.

## Adjusting the Projected Image

### Adjusting the Height of the Projected Image

The projector is equipped with two elevator feet for adjusting the image height.

To raise the image:

- 1 Use the front Tilt adjusting wheel to raise the image to the desired height and angle.
- 2 Use the rear Tilt adjusting wheel to fine-tune the display angle.

To lower the image:

- 1 Use the front Tilt adjusting wheel to lower the image to the desired height angle.
- 2 Use the rear Tilt adjusting wheel to fine-tune the display angle.

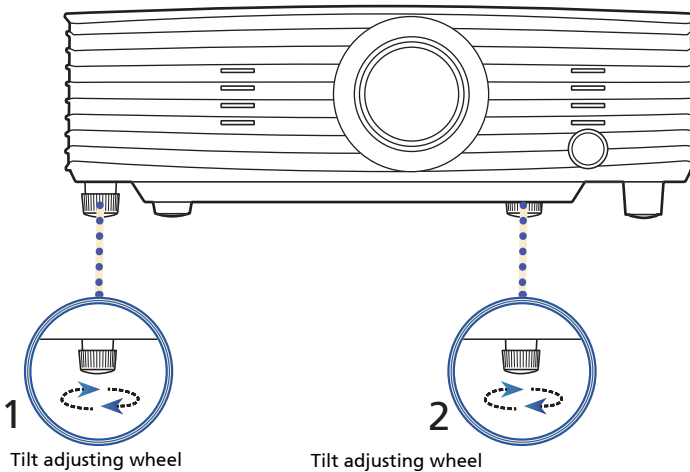



## How to Optimize Image Size and Distance

Consult the table below to find the optimal image sizes achievable when the projector is positioned at a desired distance from the screen.

- P5227

If the projector is 3 m from the screen, good image quality is possible for image sizes between 75" and 98".



**Note:** Remind as below figure, the space of 160 cm height is required when the projector is located at 3 m distance.

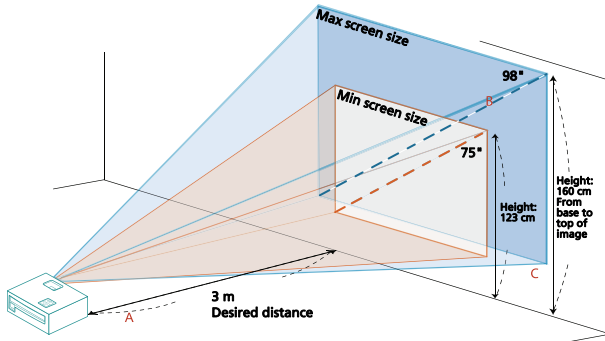

Desired Distance (m) < A >	Minimum Screen Size (Min zoom)			Maximum Screen Size (Max zoom)		
	Diagonal (inch) < B >	W (cm) x H (cm)	From base to top of image (cm) < C >	Diagonal (inch) < B >	W (cm) x H (cm)	From base to top of image (cm) < C >
1	25	51 x 38	41	33	66 x 50	53
1.5	37	76 x 57	61	49	99 x 75	80
2	50	102 x 76	82	65	132 x 99	107
2.5	62	127 x 95	102	81	166 x 124	133
3	75	152 x 114	123	98	199 x 149	160
3.5	87	178 x 133	143	114	232 x 174	187
4	100	203 x 152	164	130	265 x 199	214
4.5	112	228 x 171	184	147	298 x 224	240
5	125	254 x 190	205	163	331 x 248	267
6	150	305 x 228	246	196	397 x 298	320
7	175	355 x 266	286	228	464 x 348	374
8	200	406 x 305	327	261	530 x 397	427
9	225	457 x 343	368	293	596 x 447	481
10	250	508 x 381	409	326	662 x 497	534
11	275	558 x 419	450	359	728 x 546	587
12	300	609 x 457	491	391	795 x 596	641

Zoom Ratio: 1.3 x

- P1285i/P1285B

If the projector is 3 m from the screen, good image quality is possible for image sizes between 75" and 79".



**Note:** Remind as below figure, the space of 133 cm height is required when the projector is located at 3 m distance.

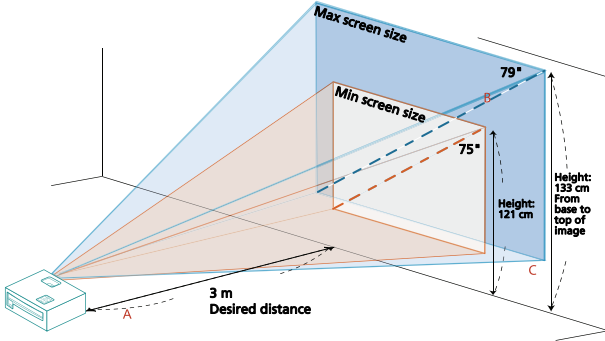

Desired Distance (m) < A >	Minimum Screen Size (Min zoom)			Maximum Screen Size (Max zoom)		
	Diagonal (inch) < B >	W (cm) x H (cm)	From base to top of image (cm) < C >	Diagonal (inch) < B >	W (cm) x H (cm)	From base to top of image (cm) < C >
1	24	49 x 37	40	26	54 x 40	44
1.5	36	74 x 55	61	40	81 x 60	67
2	48	98 x 74	81	53	108 x 81	89
2.5	60	123 x 92	101	66	134 x 101	111
3	75	147 x 110	121	79	161 x 121	133
3.5	84	172 x 129	142	93	188 x 141	155
4	96	196 x 147	162	106	215 x 161	177
4.5	109	221 x 165	182	119	242 x 181	200
5	121	245 x 184	202	132	269 x 202	222
6	145	294 x 221	243	159	323 x 242	266
7	169	343 x 257	283	185	376 x 282	310
8	193	392 x 294	324	212	430 x 323	355
9	217	441 x 331	364	238	484 x 363	399
10	241	490 x 368	404	265	538 x 403	444
11	265	539 x 404	445	291	591 x 444	488
12	289	588 x 441	485	318	645 x 484	532

Zoom Ratio: 1.1 x

- P5327W

If the projector is 3 m from the screen, good image quality is possible for image sizes between 89" and 115".



**Note:** Remind as below figure, the space of 170 cm height is required when the projector is located at 3 m distance.

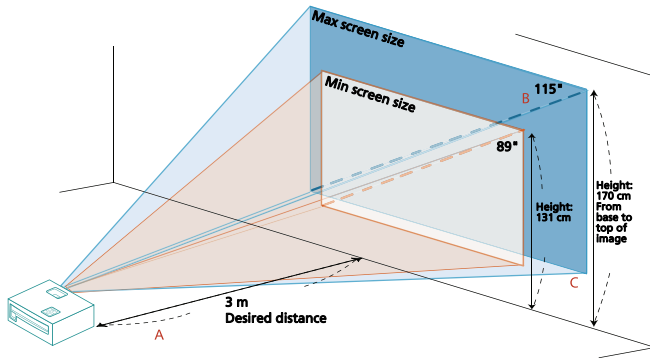

Desired Distance (m) < A >	Minimum Screen Size (Min zoom)			Maximum Screen Size (Max zoom)		
	Diagonal (inch) < B >	W (cm) x H (cm)	From base to top of image (cm) < C >	Diagonal (inch) < B >	W (cm) x H (cm)	From base to top of image (cm) < C >
1	30	64 x 40	44	38	83 x 52	57
1.5	44	96 x 60	66	58	124 x 77	85
2	59	127 x 80	88	77	165 x 103	114
2.5	74	159 x 100	109	96	207 x 129	142
3	89	191 x 119	131	115	248 x 155	170
3.5	103	223 x 139	153	134	289 x 181	199
4	118	255 x 159	175	153	331 x 207	227
4.5	133	287 x 179	197	173	372 x 232	256
5	148	318 x 199	219	192	413 x 258	284
6	177	382 x 239	263	230	496 x 310	341
7	207	446 x 279	307	269	579 x 362	398
8	237	510 x 318	350	307	661 x 413	455
9	266	573 x 358	394	345	744 x 465	511
10	296	637 x 398	438	384	826 x 517	568
11	325	701 x 438	482	422	909 x 568	625
12	355	764 x 478	525	460	992 x 620	682

Zoom Ratio: 1.3 x

- P1385Wi/P1385WB

If the projector is 3 m from the screen, good image quality is possible for image sizes between 84" and 93".



**Note:** Remind as below figure, the space of 125 cm height is required when the projector is located at 3 m distance.

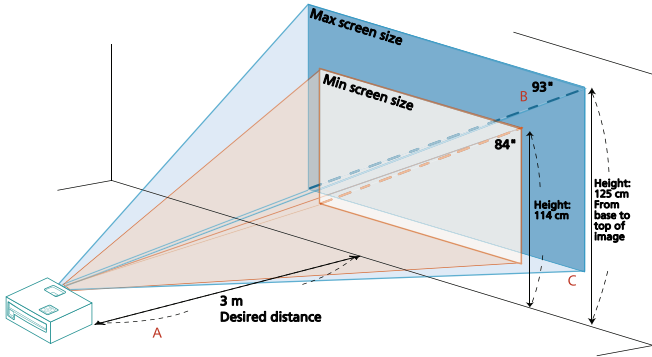

Desired Distance (m) < A >	Minimum Screen Size (Min zoom)			Maximum Screen Size (Max zoom)		
	Diagonal (inch) < B >	W (cm) x H (cm)	From base to top of image (cm) < C >	Diagonal (inch) < B >	W (cm) x H (cm)	From base to top of image (cm) < C >
1	28	61 x 38	38	31	67 x 42	42
1.5	42	91 x 57	57	46	100 x 63	63
2	56	121 x 76	76	62	133 x 83	83
2.5	70	152 x 95	95	77	167 x 104	104
3	84	182 x 114	114	93	200 x 125	125
3.5	98	212 x 133	133	108	233 x 146	146
4	113	242 x 152	152	124	267 x 167	167
4.5	127	273 x 170	170	139	300 x 188	188
5	141	303 x 189	189	155	333 x 208	208
6	169	364 x 227	227	186	400 x 250	250
7	197	424 x 265	265	217	467 x 292	292
8	225	485 x 303	303	248	533 x 333	333
9	253	545 x 341	341	279	600 x 375	375
10	281	606 x 379	379	310	667 x 417	417
11	310	667 x 417	417	340	733 x 458	458
12	338	727 x 455	455	371	800 x 500	500

Zoom Ratio: 1.1 x

- S1385WHBe/S1385WHne

If the projector is 3 m from the screen, good image quality is possible for image sizes around 284".



**Note:** Remind as below figure, the space of 402 cm height is required when located at 3 m distance.

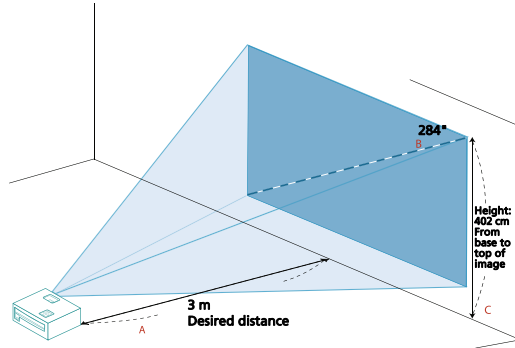

Desired Distance (m) < A >	Screen Size		
	Diagonal (inch) < B >	W (cm) x H (cm)	From base to top of image (cm) < C >
1	95	204 x 128	134
1.5	142	306 x 191	201
2	189	408 x 255	268
2.5	237	510 x 319	335
3	284	612 x 383	402
3.5	332	714 x 446	469
4	379	816 x 510	536
4.5	426	918 x 574	603
5	474	1020 x 638	670
6	568	1224 x 765	804
7	663	1429 x 893	938
8	758	1633 x 1020	1071
9	853	1837 x 1148	1205
10	947	2041 x 1276	1339
11	1042	2245 x 1403	1473
12	1137	2449 x 1531	1607

Zoom Ratio: 1.0 x

## How to Get a Preferred Image Size by Adjusting Distance and Zoom

The table below shows how to achieve a desired image size by adjusting either the position or the zoom ring.

- P5227

To obtain an image size of 70", set the projector at a distance between 2.1 m and 2.8 m from the screen and adjust the zoom level accordingly.

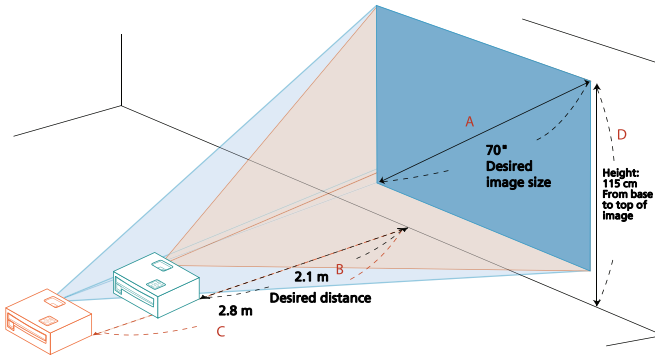

Desired Image Size		Distance (m)		Top (cm)
Diagonal (inch) < A >	W (cm) x H (cm)	Max zoom < B >	Min zoom < C >	From base to top of image < D >
30	61 x 46		1.2	49
40	81 x 61	1.2	1.6	66
50	102 x 76	1.5	2.0	82
60	122 x 91	1.8	2.4	98
70	142 x 107	2.1	2.8	115
80	163 x 122	2.5	3.2	131
90	183 x 137	2.8	3.6	147
100	203 x 152	3.1	4.0	164
120	244 x 183	3.7	4.8	197
150	305 x 229	4.6	6.0	246
180	366 x 274	5.5	7.2	295
200	406 x 305	6.1	8.0	328
250	508 x 381	7.7	10.0	410
300	610 x 457	9.2		491

Zoom Ratio: 1.3 x

- P1285i/P1285B

To obtain an image size of 70", set the projector at a distance between 2.6 m and 2.9 m from the screen and adjust the zoom level accordingly.

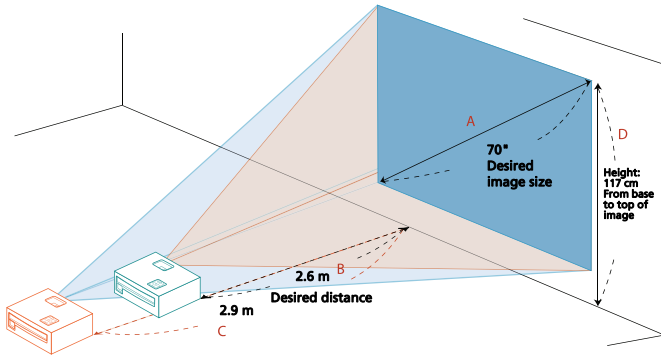

Desired Image Size		Distance (m)		Top (cm)
Diagonal (inch) < A >	W (cm) x H (cm)	Max zoom < B >	Min zoom < C >	From base to top of image < D >
30	61 x 46		1.2	50
40	81 x 61	1.5	1.7	67
50	102 x 76	1.9	2.1	84
60	122 x 91	2.3	2.5	101
70	142 x 107	2.6	2.9	117
80	163 x 122	3.0	3.3	134
90	183 x 137	3.4	3.7	151
100	203 x 152	3.8	4.1	168
120	244 x 183	4.5	5.0	201
150	305 x 229	5.7	6.2	251
180	366 x 274	6.8	7.5	302
200	406 x 305	7.6	8.3	335
250	508 x 381	9.4	10.4	419
300	610 x 457	11.3		503

Zoom Ratio: 1.1 x

- P5327W

To obtain an image size of 70", set the projector at a distance between 1.8 m and 2.4 m from the screen and adjust the zoom level accordingly.

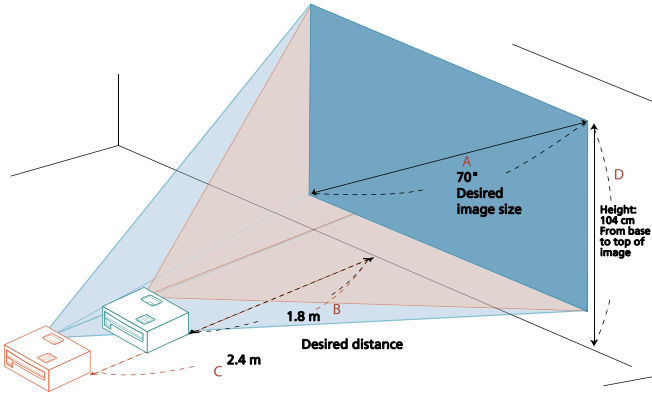

Desired Image Size		Distance (m)		Top (cm)
Diagonal (inch) < A >	W (cm) x H (cm)	Max zoom < B >	Min zoom < C >	From base to top of image < D >
30	65 x 40		1.0	44
40	86 x 54	1.0	1.4	59
50	108 x 67	1.3	1.7	74
60	129 x 81	1.6	2.0	89
70	151 x 94	1.8	2.4	104
80	172 x 108	2.1	2.7	118
90	194 x 121	2.3	3.0	133
100	215 x 135	2.6	3.4	148
120	258 x 162	3.1	4.1	178
150	323 x 202	3.9	5.1	222
180	388 x 242	4.7	6.1	267
200	431 x 269	5.2	6.8	296
250	538 x 337	6.5	8.5	370
300	646 x 404	7.8		444

Zoom Ratio: 1.3 x



- P1385Wi/P1385WB

To obtain an image size of 70", set the projector at a distance between 2.3 m and 2.5 m from the screen and adjust the zoom level accordingly.

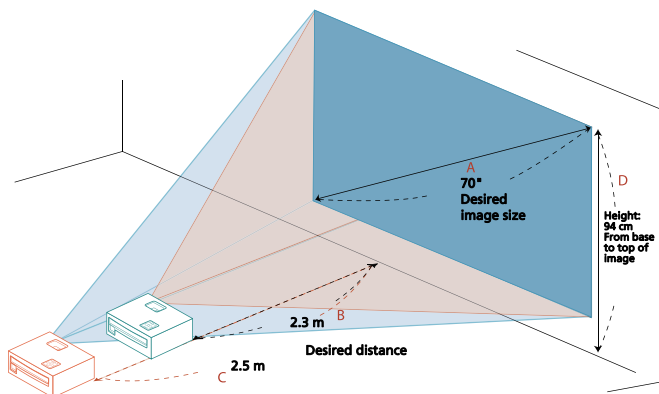

Desired Image Size		Distance (m)		Top (cm)
Diagonal (inch) < A >	W (cm) x H (cm)	Max zoom < B >	Min zoom < C >	From base to top of image < D >
30	65 x 40		1.1	40
40	86 x 54	1.3	1.4	54
50	108 x 67	1.6	1.8	67
60	129 x 81	1.9	2.1	81
70	151 x 94	2.3	2.5	94
80	172 x 108	2.6	2.8	108
90	194 x 121	2.9	3.2	121
100	215 x 135	3.2	3.6	135
120	258 x 162	3.9	4.3	162
150	323 x 202	4.8	5.3	202
180	388 x 242	5.8	6.4	242
200	431 x 269	6.5	7.1	269
250	538 x 337	8.1	8.9	337
300	646 x 404	9.7		404

Zoom Ratio: 1.1 x

- S1385WHBe/S1385WHne

To obtain an image size of 70" set the projector at a distance 0.7 m from the screen.

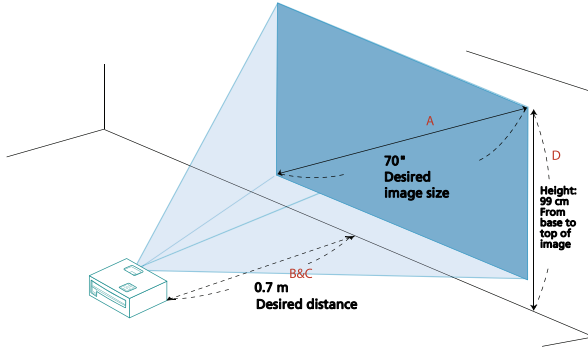

Desired Image Size		Distance (m)		Top (cm)
Diagonal (inch) < A >	W (cm) x H (cm)	Max zoom < B >	Min zoom < C >	From base to top of image < D >
30	65 x 40		0.3	42
40	86 x 54	0.4	0.4	57
50	108 x 67	0.5	0.5	71
60	129 x 81	0.6	0.6	85
70	151 x 94	0.7	0.7	99
80	172 x 108	0.8	0.8	113
90	194 x 121	0.9	0.9	127
100	215 x 135	1.1	1.1	141
120	258 x 162	1.3	1.3	170
150	323 x 202	1.6	1.6	212
180	388 x 242	1.9	1.9	254
200	431 x 269	2.1	2.1	283
250	538 x 337	2.6	2.6	353
300	646 x 404	3.2		424

Zoom Ratio: 1.0 x

# User Controls

## Installation Menu

The Installation menu provides an Onscreen Display (OSD) for projector installation and maintenance. Use the OSD only when the message "No signal" is displayed on the screen.

- 1 Turn on the projector by pressing  (POWER) on the control panel or remote control.
- 2 Press "MENU" on the control panel or remote control to launch the OSD for projector installation and maintenance.



- 3 The background pattern acts as a guide to adjusting the calibration and alignment settings, such as screen size and distance, focus and more.



.....







**Note:** The OSD screenshot is for reference only and may differ from the actual design.

- 4 The Installation menu includes several options.  
Use the up and down arrow keys to select an option, the left and right arrow keys to adjust selected option settings, and the right arrow key to enter a submenu for feature setting. The new settings will be saved automatically upon exiting the menu.
- 5 Press "MENU" anytime to exit the menu and return to the Acer welcome screen.

## Onscreen Display (OSD) Menus

The projector has multilingual Onscreen Display (OSD) menus that allow you to make image adjustments and change a variety of settings.

### Using the OSD menus

- To open the OSD menu, press "MENU" on the control panel or remote control.
- When the OSD is displayed, use   to select an item in the main menu. After selecting the desired main menu item, press  to enter a submenu for feature setting.
- Use   to select the desired item and adjust the settings by using  .
- Select the next item to be adjusted in the submenu and adjust as described above.
- Press "MENU" on the control panel or remote control, the screen will return to the main menu.
- To exit the OSD menu, press "MENU" on the control panel or remote control again. It will close and the projector will automatically save the new settings.

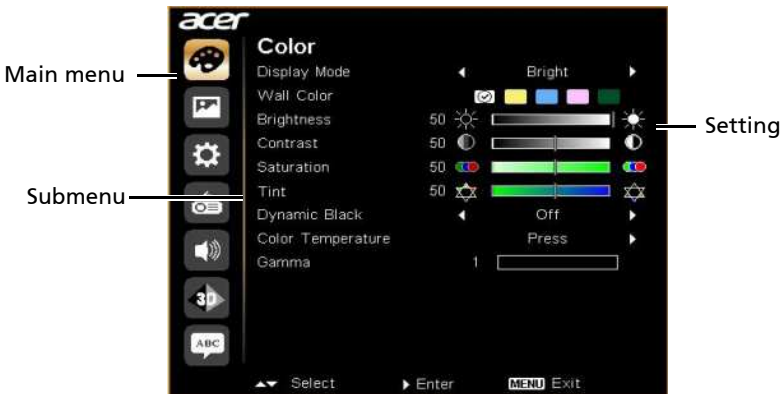

**Note:** Some of the following OSD settings may not be available. Please refer to the actual OSD of your projector.

## Color

<b>Display Mode</b>	<p>There are many factory presets optimized for various types of images.</p> <ul style="list-style-type: none"> <li>• Bright: For brightness optimization.</li> <li>• Presentation: For meeting presentation with higher brightness.</li> <li>• Standard: For common environment.</li> <li>• Movie: For brighter and general movie/video/photo playing.</li> <li>• Dark Cinema: For dark movie content.</li> <li>• Video: For playing video in a bright environment.</li> <li>• Picture: For graphic picture.</li> <li>• Game: For game content.</li> <li>• Education: For education environment.</li> <li>• Sport: For sport picture.</li> <li>• User: Memorize user's settings.</li> </ul>
<b>Wall Color</b>	<p>Use this function to choose a proper color according to the wall. There are several choices, including White, Light Yellow, Light Blue, Pink and Dark Green. It will compensate for the color deviation due to the wall color to show the correct image tone.</p>
<b>Brightness</b>	<p>Adjusts the brightness of the image.</p> <ul style="list-style-type: none"> <li>• Press ◀ to darken the image.</li> <li>• Press ▶ to lighten the image.</li> </ul>
<b>Contrast</b>	<p>Controls the degree of difference between the lightest and darkest parts of the picture. Adjusting the contrast changes the amount of black and white in the image.</p> <ul style="list-style-type: none"> <li>• Press ◀ to decrease the contrast.</li> <li>• Press ▶ to increase the contrast.</li> </ul>
<b>Saturation</b>	<p>Adjusts a video image from black and white to fully saturated colors.</p> <ul style="list-style-type: none"> <li>• Press ◀ to decrease the amount of color in the image.</li> <li>• Press ▶ to increase the amount of color in the image.</li> </ul>









<b>Tint</b>	Adjusts the color balance of red and green. <ul style="list-style-type: none"> <li>• Press ◀ to increase the amount of green in the image.</li> <li>• Press ▶ to increase the amount of red in the image.</li> </ul>
<b>Dynamic Black</b>	If turned on, the projector dynamically adjusts the power consumption of the lamp according to the brightness of the image being projected. When projecting darker images the power consumption will be reduced and the contrast of the image will also be enhanced.
<b>Gamma</b>	Effects the representation of dark scenery. With greater gamma value, dark scenery will look brighter.
<b>Color Temperature</b>	Adjusts the color temperature. At higher color temperatures, the screen looks colder; at lower color temperatures, the screen looks warmer.









-----

Note: "Saturation" and "Tint" functions are not supported under computer mode.

## Image

<b>Projection</b>	<ul style="list-style-type: none"> <li>•  <b>Front-Desktop</b>: The factory default setting.</li> <li>•  <b>Front-Ceiling</b>: When you select this function, the projector inverts the image for ceiling-mounted projection.</li> <li>•  <b>Rear-Desktop</b>: When you select this function, the projector reverses the image so that you can project behind a translucent screen.</li> <li>•  <b>Rear-Ceiling</b>: When you select this function, the projector reverses and inverts the image at same time. You can project from behind a translucent screen with ceiling mounted projection.</li> </ul>
<b>Projection Mode</b>	<ul style="list-style-type: none"> <li>•  <b>Front</b>: The factory default setting.</li> <li>•  <b>Rear</b>: Reverses the image so you can project from behind a translucent screen.</li> </ul>
<b>Projection Location</b>	<ul style="list-style-type: none"> <li>•  <b>Auto</b>: Automatically adjusts projection location of image.</li> <li>•  <b>Desktop</b></li> <li>•  <b>Ceiling</b>: Turns the image upside down for ceiling-mounted projection.</li> </ul>
<b>Aspect Ratio</b>	<p>Use this function to choose your desired aspect ratio.</p> <ul style="list-style-type: none"> <li>• <b>Auto</b>: Keeps the image with original width-height ratio and maximizes the image to fit native horizontal or vertical pixels.</li> <li>• <b>Full</b> (for WXGA/1080p models): The image will be displayed making full use of the horizontal and vertical pixels.</li> <li>• <b>4:3</b>: The image will be scaled to fit the screen and displayed using a 4:3 ratio.</li> <li>• <b>16:9</b>: The image will be scaled to fit the screen and displayed using a 16:9 ratio.</li> <li>• <b>L.Box</b> (for WXGA/1080p models): Keeps the original signal aspect ratio and zooms in by 1.333 times.</li> </ul>

<b>Keystone</b>	<p>Manually adjusts image distortion caused by tilting projection (<math>\pm 40</math> degrees).</p> 
<b>H/V Keystone</b>	<ul style="list-style-type: none"> <li>• V. Keystone: Manually adjusts image distortion caused by tilting projection (<math>\pm 30</math> degrees).</li> </ul>  <ul style="list-style-type: none"> <li>• H. Keystone: Manually adjusts image distortion caused by tilting projection (<math>\pm 30</math> degrees).</li> </ul> 
<b>4 Corner Correction</b>	<p>Manually adjusts the shape and size of an image that is unevenly rectangular on all sides. Press "MODE" repeatedly to select the corner that you wish to adjust. Press four directional selection keys to adjust the image shape.</p> 
<b>Auto Keystone</b>	<p>Automatically adjusts image distortion caused by tilting projection.</p>
<b>Keystone</b>	<p>Manually adjusts image distortion caused by tilting projection.</p>
<b>Manual Keystone</b>	  <p>-----</p> <p>This function is unavailable when Auto Keystone is set to "On".</p>



<b>Sharpness</b>	<p>Adjusts the sharpness of the image.</p> <ul style="list-style-type: none"> <li>• Press ◀ to decrease the sharpness.</li> <li>• Press ▶ to increase the sharpness.</li> </ul>
<b>H. Position (Horizontal Position)</b>	<ul style="list-style-type: none"> <li>• Press ◀ to move the image left.</li> <li>• Press ▶ to move the image right.</li> </ul>
<b>V. Position (Vertical Position)</b>	<ul style="list-style-type: none"> <li>• Press ◀ to move the image down.</li> <li>• Press ▶ to move the image up.</li> </ul>
<b>Frequency</b>	<p>Changes the projector's refresh rate to match the frequency of your computer's graphics card. If you experience a vertical flickering bar in the projected image, use this function to correct it.</p>
<b>Tracking</b>	<p>Synchronizes the signal timing of the display with the graphics card. If you experience an unstable or flickering image, use this function to correct it.</p>
<b>HDMI Color Range</b>	<p>Adjusts the color range of the HDMI image data to prevent color display error.</p> <ul style="list-style-type: none"> <li>• Auto: Automatically adjusts the color range by information from the player.</li> <li>• Limited Range: Processes the input image as limited color range data.</li> <li>• Full Range: Processes the input image as full color range data.</li> </ul>
<b>HDMI Scan Info</b>	<p>Adjusts the overscan ratio of the HDMI image on screen.</p> <ul style="list-style-type: none"> <li>• Auto: Automatically adjusts the overscan ratio by information from the player.</li> <li>• Underscan: Always no overscan on the HDMI image.</li> <li>• Overscan: Always keep overscan on the HDMI image.</li> </ul>









**Note:** "H. Position", "V. Position", "Frequency" and "Tracking" functions are not supported under video mode.





**Note:** "HDMI Color Range" and "HDMI Scan Info" are only available when the input signal is HDMI.

## Setting

<b>Startup Screen</b>	<p>Use this function to select your desired startup screen. If you change the setting, it will take effect when you exit the OSD menu.</p> <ul style="list-style-type: none"> <li>• Acer: The default startup screen of your Acer projector.</li> <li>• User: Use the memorized picture from the "Screen Capture" function.</li> </ul>
<b>Screen Capture</b>	<p>Use this function to customize the startup screen. To capture the image that you want to use as the startup screen, follow the instructions below.</p> <p><b>Notice</b> Before proceeding with the following steps, make sure that the "Keystone" is set to the default value "0", and the "Aspect Ratio" is set to "4:3". For details, refer to the "Image" section.</p> <ul style="list-style-type: none"> <li>• Change the "Startup Screen" from the default setting "Acer" to "User".</li> <li>• Select "Screen Capture" to customize the startup screen.</li> <li>• A dialog box appears to confirm the action. Choose "Yes" to use the current image as your customized startup screen. Choose "No" to cancel the screen capture and exist the Onscreen Display (OSD).</li> <li>• A message appears stating that the screen capture is in progress.</li> <li>• When the screen capture is finished, the message disappears and the original display is shown.</li> </ul>
<b>Source Lock</b>	<p>Selecting "On" enables the function and when switching input signals, you need to press "SOURCE" on the control panel or remote control, or the direct source key on the remote control. When this function is disabled, the projector will detect your source automatically.</p>
<b>Closed Caption</b>	<p>Selects a preferred closed captioning mode from CC1, CC2, CC3, CC4 (CC1 displays captions in the primary language in your area). Select "Off" to turn off the captioning feature. This function is only available when a composite video or S-Video input signal is selected and its system format is NTSC.</p>

<b>VGA OUT (Standby)</b>	<p>Selecting "On" enables the function. The projector can output a VGA signal when it is in standby mode and the VGA IN (or VGA IN 1) and VGA OUT sockets are correctly connected to the devices.</p> <p> -----</p> <p>Enabling this function slightly increases the standby power consumption.</p>
<b>DC 5V Out (Standby)</b>	<p>Selecting "On" enables the function. Both micro USB cable inside the projector and the DC 5V out port/USB A port (if available) on the back of the projector can output 5V power when it is in standby mode.</p> <p> -----</p> <p>Enabling this function slightly increases the standby power consumption.</p>
<b>Reset</b>	<p>Press  after choosing "Yes" to return the display parameters on all menus to the factory default settings.</p>

<b>Security</b>	<p><b>Security</b>  This projector provides a useful security function for the administrator to manage the projector.  Press  to change the "Security" setting. If the security function is enabled, you must enter "Administrator Password" first before changing the security setting.</p> <p> .....  The factory default of "Administrator Password" is "1234".</p> <ul style="list-style-type: none"> <li>• Select "On" to enable the security function. You have to enter password depending on the "Security Mode". Please refer to "User Password" section for details.</li> <li>• If "Off" is selected, you can switch on the projector without password.</li> </ul>
	<p><b>Timeout (Min.)</b>  Once "Security" is set to "On", you can set timeout function.</p> <ul style="list-style-type: none"> <li>• Press   to select timeout duration.</li> <li>• The range is from 10 to 990 minutes.</li> <li>• When time is up, the projector will request you to enter the password again.</li> <li>• The factory default setting of "Timeout (Min.)" is "Off".</li> <li>• Once the security function is enabled, the projector will request you to enter password when switching on the projector. Both "User Password" and "Administrator Password" can be accepted for this dialogue.</li> </ul>

Security	<p><b>User Password</b></p> <ul style="list-style-type: none"> <li>• Press  to set up or change "User Password".</li> <li>• Use the numerical keys on the remote control to set the password and press "MENU" to confirm.</li> <li>• To delete the digits, Press .</li> <li>• Enter the password again when you see "Confirm Password" displayed.</li> <li>• The password should be 4~8 digits in length.</li> <li>• If you select "Request password only after plugging power cord", you are requested to input the password every time the power cord is plugged.</li> <li>• If you select "Always request password while projector turns on", you are requested to input the password every time the projector is turned on.</li> </ul>
	<p><b>Administrator Password</b></p> <p>You can enter "Administrator Password" when the "Enter Administrator Password" or "Enter Password" dialogue box displays.</p> <ul style="list-style-type: none"> <li>• Press  to change "Administrator Password".</li> <li>• The factory default of "Administrator Password" is "1234".</li> </ul> <p>If you forget your administrator password, do the following to retrieve the administrator password:</p> <ul style="list-style-type: none"> <li>• Enter the unique 6-digit "Universal Password" which is printed on the Security Card that came with your projector. This unique password will be accepted by the projector no matter what the administrator password is.</li> <li>• If the Security Card is lost, please contact your local Acer service center.</li> </ul>
	<p><b>Lock User Startup Screen</b></p> <p>This function is set to "OFF" by default. If set to "ON", the startup screen is locked and cannot be changed by the "Startup Screen" and "Screen Capture" functions.</p>
LAN	<p><b>LAN</b></p> <p>The default value is "Off". Choose "On" to enable the LAN connection.</p> <p><b>LAN IP/Mask</b></p> <p>Identify IP and Mask address.</p> <p><b>LAN Reset</b></p> <p>Press  after choosing "Yes" to return all items on the Tools page to the default settings.</p>

<b>LAN/WiFi</b>	<p><b>LAN/WiFi</b> The default value is "Off". Choose "On" to enable the LAN connection.</p> <p><b>LAN IP/Mask</b> Identify IP and Mask address.</p> <p><b>LAN Reset</b> Press  after choosing "Yes" to return all items on the Tools page to the default settings.</p>
<b>SmartPen</b>	<p>The Acer SmartPen can work in place of your regular computer mouse. Just hold the pen in your hand, and point it at the projected image to point, click, and drag. It gives you more flexibility to operate your computer without standing next to it.</p> <p><b>Pen Function</b></p> <ul style="list-style-type: none"> <li>To use the Acer SmartPen, select "On" to activate this function.</li> </ul> <p><b>Link Channel</b></p> <ul style="list-style-type: none"> <li>Set a channel to differentiate between projectors and communicate with the Acer SmartPen.</li> </ul> <p><b>Double Click Speed</b></p> <ul style="list-style-type: none"> <li>Adjust the double click speed of your pen to make it response faster or slower to meet your needs.</li> </ul> <p><b>Pairing</b></p> <ul style="list-style-type: none"> <li>To pair a pen, select "Pairing" and follow the on-screen instructions. To release a pen, select "Release" and follow the on-screen instructions.</li> </ul> <p><b>Information</b></p> <ul style="list-style-type: none"> <li>Displays more information about smart pen such as battery capability and RF strength.</li> </ul> <p>For more details, see the notes following this table.</p>



.....

**About LAN Setting**

**Note 1 :** An overview of the remote network operation page

To switch input signals, click your desired signal.

See Note 2 and Note 3.

These buttons function the same as those on the OSD menus, projector control panel, or remote control.

**Note 2 :** An overview of the Tools page

You can enter the projector information.

You can adjust the LAN control settings.

You can set the user password/administrator password to prevent unauthorized use of the remote network operation/Tools page.

**Note 3:** The Info page shows the projector information and status.



## About Acer SmartPen Setting

**Note 1:** Preparations

1. Connect the projector and your computer with a USB cable and VGA cable.
2. Turn on your projector and make sure it is displaying the computer's image.

3. Plug the PB dongle to the PB dongle slot on the projector.

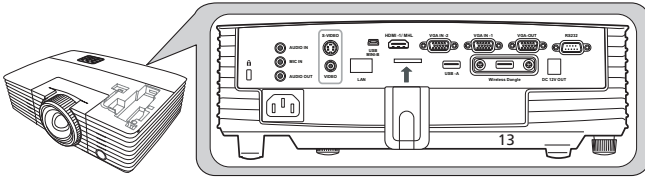

4. Enable the pen by selecting "On" in the **Setting > SmartPen > Pen Function** menu. The pen's link light starts to blink.
5. Point the pen at the screen to point, click, and drag.

**Note 2:** Overview of the Acer SmartPen

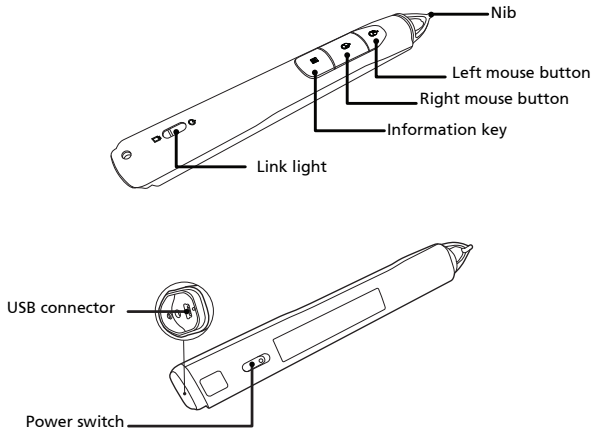

**Note 3:** Charging the battery

1. To charge the battery, open the flap on the back of the pen to expose the USB connector.
2. Take a USB cable, and connect the smaller end to the pen and the larger end to a computer. Make sure the computer is powered on.
3. The battery light stays on while the battery is charging. When charging is finished, the battery light is off. You can disconnect the USB cable or keep it connected.

**Note 4:** Other notes about using the pen





1. Avoid standing too far from the screen. The closer you are to the screen, the better performance the pen has.
2. Hold the pen the way you hold a remote control or a pen.
3. A full battery charge takes 3-4 hours and will allow 30 hours non-stop use. The battery is only rechargeable, and is not user serviceable or user replaceable.
4. Avoid shadows! The pen cannot work if its tip is in a shadow or it is pointing at a shadow.



## Management

<b>ECO Mode</b>	Choose "On" to dim the projector lamp, which will also lower the power consumption, reduce noise, and extend the lamp life. Choose "Off" to return to the normal mode.
<b>High Altitude</b>	Choose "On" to turn on the High Altitude mode. When this function is turned on, the projector fans operate at full speed continuously to cool down the projector's temperature.
<b>Turn Off Mode</b>	<ul style="list-style-type: none"> <li>Instant Off: Enables you to turn off the projector immediately without fan cooling process by pressing the power button twice.</li> <li>Instant Resume: Enables you to restart the projector immediately within 2 minutes after turning it off.</li> </ul>
<b>Auto Shutdown (Minutes)</b>	The projector will automatically shut down while there is no signal input detected after the time you set.
<b>AC Power On</b>	Selecting "On" enables the function. The projector will automatically turn on when power is supplied via the power cord.
<b>Lamp Hour Elapse</b>	Displays the lamp's elapsed operating time (in hours).
<b>Lamp Reminding</b>	Choose this function to show or hide warning message when the changing lamp message is displayed. The message will show up 30 hours before end of life.
<b>Lamp Hour Reset</b>	Press  after choosing "Yes" to reset the lamp hour counter to 0 hours.

## Audio

<b>Volume</b>	<ul style="list-style-type: none"> <li>Press  to decrease the volume.</li> <li>Press  to increase the volume.</li> </ul>
<b>Microphone Volume</b>	<ul style="list-style-type: none"> <li>Press  to decrease the microphone volume.</li> <li>Press  to increase the microphone volume.</li> </ul>
<b>Mute</b>	<ul style="list-style-type: none"> <li>Choose "On" to turn mute on.</li> <li>Choose "Off" to turn mute off.</li> </ul>
<b>Power On/Off Volume</b>	Select this function to adjust the notification volume when turning the projector on/off.
<b>Alarm Volume</b>	Select this function to adjust the volume of any warning notifications.

## 3D

3D	Selects "On" to enable the 3D function supported by DLP 3D technology. <ul style="list-style-type: none"> <li>On: Select this item while using DLP 3D glasses, quad buffer (NVIDIA/ATI...) graphics card and HQFS format file or DVD with corresponding SW player.</li> <li>Off: Turns off the 3D mode.</li> </ul>
3D Format	If the 3D content is not displayed correctly, you can select a 3D format that suits the 3D content you are viewing and obtain the best result.
3D Sync Invert	If you see a discrete or overlapping image while wearing DLP 3D glasses, you may need to execute "Invert" to get best match of left/right image sequence to get the correct image (for DLP 3D).
24P 3D	Choose 96Hz or 144Hz for 24p 3D.
3D Warning Message	Choose "On" to display the 3D warning message. <div data-bbox="342 651 888 794" style="background-color: black; color: white; padding: 5px; margin-top: 10px;"> <p>Note: 3D display is now enabled.</p> <ol style="list-style-type: none"> <li>1. Please make sure you have the correct 3D signals and glasses.</li> <li>2. Remember to turn off 3D if you don't want to see 3D images.</li> <li>3. If the 3D display isn't correct, please try to enable 3D Sync Invert.</li> <li>4. Display mode options will be disabled while in 3D mode.</li> </ol> </div>



**Note:** Supported 3D signal timings:

Signal source type	Supported timing
Video/S-Video/Component video	HQFS 3D (480i@60Hz), 576i@50Hz
VGA/HDMI (PC mode)	640 x 480@50/60/100/120Hz 800 x 600@50/60/100/120Hz 1024 x 768@50/60/100/120Hz 1280 x 800@50/60/100/120Hz (RB)
HDMI (Video mode)	HQFS 3D (480i@60Hz) , 576i@50Hz, Frame Packing (1080p@23.98/24Hz, 720p@50/60Hz) Side-by-Side Horizontal (1080i@50/60Hz, 1080p@50/60Hz) Top-and-Bottom (720p@50/60Hz, 1080p@23.97/24Hz, 1080p@50/60Hz)



It needs correct settings on graphics card 3D application program for correct 3D display.

The SW players, such as Stereoscopic Player and DDD TriDef Media Player can support 3D format files. You can download these players on the web page below.

- Stereoscopic Player (Trial): [http://www.3dtv.at/Downloads/Index\\_en.aspx](http://www.3dtv.at/Downloads/Index_en.aspx)
- DDD TriDef Media Player (Trial): <http://www.tridef.com/download/TriDef-3-D-Experience-4.0.2.html>

**Note:** "3D Sync Invert" and "3D Format" are only available when "3D" is enabled.

## Language

<b>Language</b>	Sets a language for the OSD menus. Use   to select your preferred language.
-----------------	---

# Appendices

## Troubleshooting

If you experience a problem with your Acer projector, refer to the following troubleshooting guide. If the problem persists, please contact your local reseller or service center.

### Image Problems and Solutions

#	Problem	Solution
1	No image appears onscreen	<ul style="list-style-type: none"> <li>• Make sure all the cables are correctly connected as described in the "Getting Started" section.</li> <li>• Ensure none of the connector pins are bent or broken.</li> <li>• Make sure the projector is switched on.</li> </ul>
2	Partial, scrolling or incorrectly displayed image (For PC (Windows 95/98/2000/XP/Win7/Vista))	<ul style="list-style-type: none"> <li>• Press "RESYNC" on the control panel or remote control.</li> <li>• For an incorrectly displayed image:             <ul style="list-style-type: none"> <li>• Open "My Computer &gt; Control Panel," and then double-click the "Display" icon.</li> <li>• Select the "Settings" tab.</li> <li>• Verify that your display resolution setting is lower than or equal to 1600 x 1200 or 1920 x 1080.</li> <li>• Click the "Advanced Properties" button.</li> </ul> </li> </ul> <p>If the problem still appears, change the monitor display you are using and follow the steps below:</p> <ul style="list-style-type: none"> <li>• Verify that the resolution setting is lower than or equal to 1600 x 1200 or 1920 x 1080.</li> <li>• Click the "Change" button under the "Monitor" tab.</li> <li>• Click "Show all devices &gt; Standard monitor types" under the SP box, and choose the resolution mode you need under the "Models" box.</li> <li>• Verify that the resolution setting of the monitor display is lower than or equal to 1600 x 1200 or 1920 x 1080.</li> </ul>

3	Partial, scrolling or incorrectly displayed image (For notebooks)	<ul style="list-style-type: none"> <li>• Press "RESYNC" on the control panel or remote control.</li> <li>• For an incorrectly displayed image: <ul style="list-style-type: none"> <li>• Follow the steps for item 2 (above) to adjust the resolution of your computer.</li> <li>• Press the toggle output settings. Example: [Fn]+[F4], Compaq [Fn]+[F4], Dell [Fn]+[F8], Gateway [Fn]+[F4], IBM [Fn]+[F7], HP [Fn]+[F4], NEC [Fn]+[F3], Toshiba [Fn]+[F5]</li> </ul> </li> <li>• If you experience difficulty changing resolutions or your monitor freezes, restart all equipment including the projector.</li> </ul>
4	The screen of the notebook computer is not displaying your presentation	<ul style="list-style-type: none"> <li>• If you are using a Microsoft® Windows® based notebook: Some notebook PCs may deactivate their own screens when a second display device is in use. Each has a different way to be reactivated. Refer to your computer's manual for detailed information.</li> <li>• If you are using an Apple® Mac® OS based notebook: In System Preferences, open Display and select Video Mirroring "On."</li> </ul>
5	Image is unstable or flickering	<ul style="list-style-type: none"> <li>• Use "Tracking" to correct it. Refer to the "Image" section for more information.</li> <li>• Change the display color setting on your computer.</li> </ul>
6	Image has vertical flickering bar	<ul style="list-style-type: none"> <li>• Use "Frequency" to make an adjustment. Refer to the "Image" section for more information.</li> <li>• Check and reconfigure the display mode of your graphics card to make it compatible with the projector.</li> </ul>
7	Image is out of focus	<ul style="list-style-type: none"> <li>• Adjust the focus ring on the projector lens.</li> <li>• Make sure the projection screen is within the required distance:  P5227:  6.1 to 30.2 feet (1.9 to 9.2 meters)  P5327W:  5.2 to 25.7 feet (1.6 to 7.8 meters)  P1285i/P1285B:  7.4 to 37.2 feet (2.3 to 11.3 meters)  P1385Wi/P1385WB:  6.4 to 31.8 feet (1.9 to 9.7 meters)  S1385WHne/S1385WHBe:  2.4 to 10.4 feet (0.7 to 3.2 meters)  Refer to the "How to Get a Preferred Image Size by Adjusting Distance and Zoom" section for more information.</li> </ul>

8	Image is stretched when displaying a "widescreen" DVD title	<p>When you play a DVD encoded in anamorphic or 16:9 aspect ratio you may need to adjust the following settings:</p> <ul style="list-style-type: none"> <li>• If you play a 4:3 format DVD title, please change the format to 4:3 with the projector OSD.</li> <li>• If the image is still stretched, you will also need to adjust the aspect ratio. Set up the display format to 16:9 (wide) aspect ratio on your DVD player.</li> </ul>
9	Image is too small or too large	<ul style="list-style-type: none"> <li>• Adjust the zoom lever on the top of the projector.</li> <li>• Move the projector closer to or further from the screen.</li> <li>• Press "MENU" on the control panel or remote control. Go to "Image" &gt; "Aspect Ratio" and try different settings.</li> </ul>
10	Image has slanted sides	<ul style="list-style-type: none"> <li>• If possible, reposition the projector so that it is centered on the screen and below the bottom of the screen.</li> <li>• Press the Keystone correction keys on the control panel or remote control until the image becomes square.</li> <li>• Press "MENU" on the control panel or remote control to open the OSD menu. Go to "Image" to make adjustments.</li> </ul>
11	Image is reversed	<ul style="list-style-type: none"> <li>• Select "Image" &gt; "Projection Mode", "Image" &gt; "Projection Location" on the OSD and adjust the projection direction.</li> </ul>

## Problems with the Projector

#	Condition	Solution
1	The projector stops responding to all controls	If possible, turn off the projector, then unplug the power cord and wait at least 30 seconds before reconnecting power.
2	Lamp burns out or makes a popping sound	When the lamp reaches the end of its useful life, it will burn out and may make a loud popping sound. If this happens, the projector will not turn on until the lamp module has been replaced. To replace the lamp, contact your local dealer or Acer service center.

## OSD Messages

#	Condition	Message Reminder
1	Message	<p data-bbox="394 277 736 300">Fan Fail - the system fan is not working.</p> <div data-bbox="394 304 934 373" style="background-color: black; color: white; padding: 5px; text-align: center;"> <p data-bbox="631 316 697 335">Fan Fail.</p> <p data-bbox="521 339 806 359">Lamp will automatically turn off soon.</p> </div> <p data-bbox="394 387 932 491">Projector Overheated - the projector has exceeded its recommended operating temperature and must be allowed to cool down before it is used. Please also check the dust filters if they are installed. If the dust filter is clogged with dust, please clean it.</p> <div data-bbox="394 501 934 569" style="background-color: black; color: white; padding: 5px; text-align: center;"> <p data-bbox="582 512 746 531">Projector Overheated.</p> <p data-bbox="521 536 806 555">Lamp will automatically turn off soon.</p> </div> <p data-bbox="394 576 901 619">Replace the lamp - the lamp is about to reach its maximum lifetime. Prepare to replace it soon.</p> <div data-bbox="394 628 934 697" style="background-color: black; color: white; padding: 5px; text-align: center;"> <p data-bbox="407 639 921 659">Lamp is approaching the end of its useful life in full power operation.</p> <p data-bbox="572 663 756 683">Replacement suggested!</p> </div>

# LED & Alarm Definition Listing

## LED Messages

Message	Power LED		LAMP LED	TEMP LED
	Red	Blue	Red	Red
Standby (Power cord plugged in)	V	--	--	--
Power on	--	V	--	--
Lamp retry	--	Quick flashing	--	--
Turning off (Cooling state)	Quick flashing	--	--	--
Turning off (Cooling completed)	V	--	--	--
Error (Thermal failure)	--	V	--	V
Error (Fan lock failure)	--	V	--	Quick flashing
Error (Lamp breakdown)	--	V	V	--
Error (Color wheel failure)	--	V	Quick flashing	--



## Using the inner connector(s)

Turn the projector off by pressing  (POWER). Allow the projector at least 45 minutes to cool down. Disconnect the power cord.

- 1 Use a screwdriver to remove the screw(s) from the cover. (Illustration #1)
- 2 Push up and remove the cover. (Illustration #2)
- 3 Locate the HDMI (MHL) connector beside the focus/zoom ring.
- 4 Insert the WirelessHD dongle (MWIHD1) or other HDMI/MHL dongle into the HDMI (MHL) connector. (Illustration #3)
- 5 A micro USB cable is also available if you need to power the HDMI/MHL dongle.
- 6 Replace the cover and tighten the screw(s). (Illustration #4 - #5)

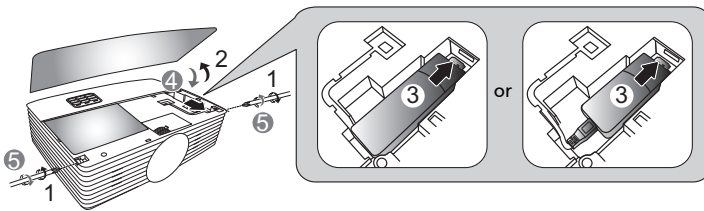

# Ceiling Mount Installation

If you wish to install the projector using a ceiling mount, please refer to the steps below:

- 1 Drill four holes into a solid, structurally sound part of the ceiling, and secure the mount base.

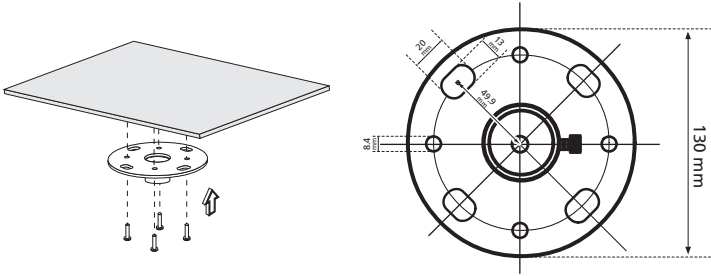

**Note:** Screws are not included. Please obtain the appropriate screws for your type of ceiling.

- 2 Secure the ceiling rod using the appropriate type of cylinder screws.

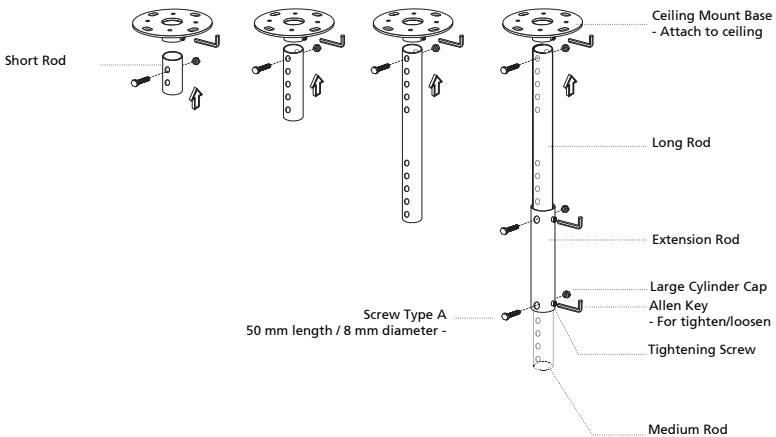

- 3 Use the appropriate number of screws for the projector size to attach the projector to the ceiling mount bracket.

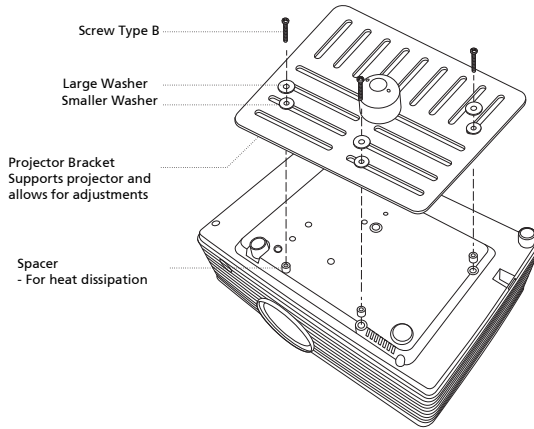

**Note:** It is recommended that you keep a reasonable space between the bracket and the projector to allow for proper heat distribution. Use two washers for extra support, if deemed necessary.

- 4 Attach the ceiling bracket to the ceiling rod.

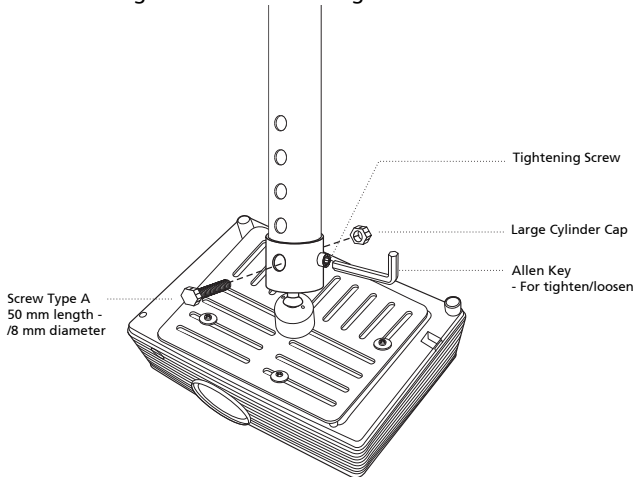

5 Adjust the angle and positioning as necessary.

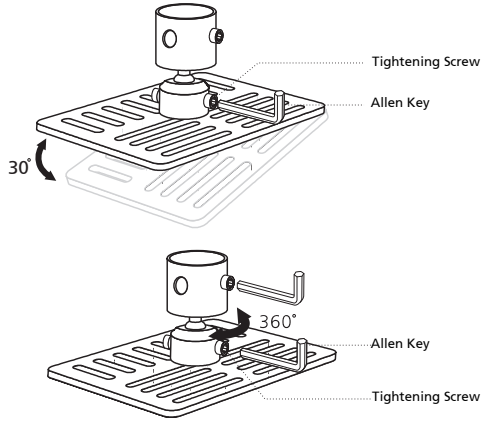

**Note:** The appropriate type of screw and washer for each model is listed in the table below. 4 mm diameter screws are enclosed in the screw pack.

Screw Type B		Washer Type	
Diameter (mm)	Length (mm)	Large	Small
4	25	V	V

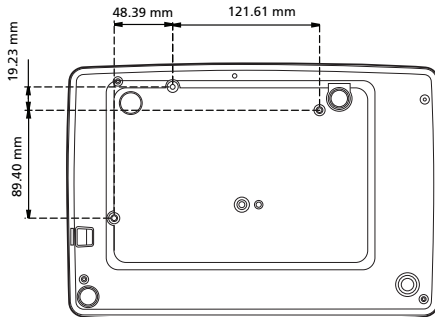

## Specifications

The specifications below are subject to change without notice. For final specs, please refer to Acer's marketing documentation.

Projection system	DLP™
Resolution	<ul style="list-style-type: none"> <li>• P5227/P1285i/P1285B: Native: XGA (1024 x 768) Maximum: UXGA (1600 x 1200), 1080p (1920 x 1080), WUXGA (1920 x 1200) (supports reduce blanking only)</li> <li>• P5327W/P1385Wi/P1385WB/S1385WHBe/S1385WHne: Native: WXGA (1280 x 800) Maximum: UXGA (1600 x 1200), 1080p (1920 x 1080), WUXGA (1920 x 1200) (supports reduce blanking only)</li> </ul>
Computer compatibility	Refer to the "Compatibility Modes" section for more information.
Video compatibility	NTSC (3.58/4.43), PAL (M/N), PAL 60, SECAM, HDTV (720p, 1080i, 1080p), EDTV (480p, 576p), SDTV (480i, 576i)
Aspect ratio	Auto, 4:3, 16:9, Full, L.Box
Displayable colors	1.07 billion colors
Projection lens	<ul style="list-style-type: none"> <li>• P5227/P5327W: F = 2.59 - 2.87, f = 16.88 mm - 21.88 mm, 1:1.3 Manual Zoom and Manual Focus</li> <li>• P1285i/P1285B/P1385Wi/P1385WB: F = 2.56 - 2.8, f = 21.00 mm - 23.10 mm, 1:1.1 Manual Zoom and Manual Focus</li> <li>• S1385WHBe/S1385WHne: F = 2.6, f = 6.9 mm, 1:1.0 Manual Zoom and Manual Focus</li> </ul>
Projection screen size (diagonal) with clear focus	<ul style="list-style-type: none"> <li>• P5227: 46" (117 cm) - 300" (762 cm)</li> <li>• P5327W: 46" (118 cm) - 300" (762 cm)</li> <li>• P1285i/P1285B: 55" (138 cm) - 300" (762 cm)</li> <li>• P1385Wi/P1385WB: 55" (139 cm) - 300" (762 cm)</li> <li>• S1385WHBe/S1385WHne: 70" (178 cm) - 300" (762 cm)</li> </ul>

Projection distance with clear focus	<ul style="list-style-type: none"> <li>• P5227: 6.1' (1.9 m) - 30.2' (9.2 m)</li> <li>• P5327W: 5.2' (1.6 m) - 25.7' (7.8 m)</li> <li>• P1285i/P1285B: 7.4' (2.3 m) - 37.2' (11.3 m)</li> <li>• P1385Wi/P1385WB: 6.4' (1.9 m) - 31.8' (9.7 m)</li> <li>• S1385WHBe/S1385WHne: 2.4' (0.7 m) - 10.4' (3.2 m)</li> </ul>
Throw ratio	<ul style="list-style-type: none"> <li>• P5227: 78"±3% @ 2.4 m (1.51 - 1.97:1)</li> <li>• P5327W: 87"±3% @ 2.26 m (1.21 - 1.57:1)</li> <li>• P1285i/P1285B: 53"±3% @ 2 m (1.86 - 2.04:1)</li> <li>• P1385Wi/P1385WB: 62"±3% @ 2 m (1.50 - 1.65:1)</li> <li>• S1385WHBe/S1385WHne: 87"±3% @ 0.915 m (0.49 - 0.49:1)</li> </ul>
Horizontal scan rate	31 - 99 KHz
Vertical refresh scan rate	23 - 120 Hz
Keystone correction	<ul style="list-style-type: none"> <li>• P5227/P5327W: +/-30 Degrees (Vertical/Horizontal), Manual</li> <li>• P1285i/P1285B/P1385Wi/P1385WB: +/-40 Degrees (Vertical), Manual &amp; Auto</li> <li>• S1385WHBe/S1385WHne: +/-40 Degrees (Vertical), Manual</li> </ul>
Digital zoom	2 X
Audio	10W x 2
Weight	<ul style="list-style-type: none"> <li>• P5227/P5327W/P1285i/P1285B/P1385Wi/ P1385WB: Approximate 2.0 kg (4.41 lbs.)</li> <li>• S1385WHBe/S1385WHne: Approximate 2.3 kg (5.07 lbs.)</li> </ul>
Dimensions (W x D x H)	<ul style="list-style-type: none"> <li>• P5227/P5327W/P1285i/P1285B/P1385Wi/ P1385WB: 309 x 233 x 106 mm (10.1' x 7.6' x 3.5')</li> <li>• S1385WHBe/S1385WHne: 308 x 211 x 86 mm (10.1' x 6.9' x 2.8')</li> </ul>
Power supply	Universal AC input 100 - 240 V, input frequency 50/60 Hz
Power consumption (typical)	<ul style="list-style-type: none"> <li>• P5227/P5327W: 361 W</li> <li>• P1285i/P1285B/P1385Wi/P1385WB: 270 W</li> <li>• S1385WHBe/S1385WHne: 305 W</li> </ul>
Operating temperature	0°C to 40°C / 32°F to 104°F

---

I/O connectors	<p data-bbox="473 145 607 165">P5227/P5327W:</p> <ul data-bbox="473 172 784 608" style="list-style-type: none"><li data-bbox="473 172 663 193">• Power socket x 1</li><li data-bbox="473 199 689 220">• USB Type mini B x 1</li><li data-bbox="473 226 784 247">• USB Type A (DC 5V output) x 1</li><li data-bbox="473 253 642 274">• VGA input x 2</li><li data-bbox="473 280 653 301">• VGA output x 1</li><li data-bbox="473 308 598 328">• RS232 x 1</li><li data-bbox="473 335 692 355">• Composite video x 1</li><li data-bbox="473 362 615 383">• S-Video x 1</li><li data-bbox="473 389 645 410">• HDMI/MHL x 2</li><li data-bbox="473 416 681 437">• RJ45 LAN input x 1</li><li data-bbox="473 443 757 464">• 3.5 mm audio jack input x 1</li><li data-bbox="473 470 703 491">• Microphone input x 1</li><li data-bbox="473 497 768 518">• 3.5 mm audio jack output x 1</li><li data-bbox="473 525 689 545">• Micro USB cable x 1</li><li data-bbox="473 552 648 572">• DC 12V out x 1</li></ul>
I/O connectors	<p data-bbox="473 619 583 639">S1385WHne:</p> <ul data-bbox="473 646 784 1115" style="list-style-type: none"><li data-bbox="473 646 663 667">• Power socket x 1</li><li data-bbox="473 673 689 694">• USB Type mini B x 1</li><li data-bbox="473 700 784 721">• USB Type A (DC 5V output) x 1</li><li data-bbox="473 727 674 748">• PB dongle slot x 1</li><li data-bbox="473 754 642 775">• VGA input x 2</li><li data-bbox="473 782 653 802">• VGA output x 1</li><li data-bbox="473 809 598 829">• RS232 x 1</li><li data-bbox="473 836 692 857">• Composite video x 1</li><li data-bbox="473 863 615 884">• S-Video x 1</li><li data-bbox="473 890 645 911">• HDMI/MHL x 2</li><li data-bbox="473 917 681 938">• RJ45 LAN input x 1</li><li data-bbox="473 944 757 965">• 3.5 mm audio jack input x 1</li><li data-bbox="473 971 703 992">• Microphone input x 1</li><li data-bbox="473 999 768 1019">• 3.5 mm audio jack output x 1</li><li data-bbox="473 1026 689 1046">• Micro USB cable x 1</li><li data-bbox="473 1053 648 1074">• DC 12V out x 1</li></ul>

---

I/O connectors	P1285i/P1285B/P1385Wi/P1385WB/S1385WHBe:
	<ul style="list-style-type: none"> <li>• Power socket x 1</li> <li>• USB Type mini B x 1</li> <li>• USB Type A x 1</li> <li>• Wireless dongle input (DC 5V output) x 1</li> <li>• VGA input x 2</li> <li>• VGA output x 1</li> <li>• RS232 x 1</li> <li>• Composite video x 1</li> <li>• S-Video x 1</li> <li>• HDMI/MHL x 2</li> <li>• RJ45 LAN input x 1</li> <li>• 3.5 mm audio jack input x 1</li> <li>• Microphone input x 1</li> <li>• 3.5 mm audio jack output x 1</li> <li>• Micro USB cable x 1</li> <li>• DC 12V out x 1</li> </ul>
Standard package contents	<ul style="list-style-type: none"> <li>• AC power cord x 1</li> <li>• VGA cable x 1</li> <li>• Remote control x 1</li> <li>• Battery x 2 (for the remote control)</li> <li>• User's guide (CD-ROM) x 1</li> <li>• Quick start guide x 1</li> <li>• Security card x 1</li> </ul>
Accessory (optional)	<ul style="list-style-type: none"> <li>• Composite video cable x 1</li> <li>• Carrying case x 1</li> <li>• Dust filter x 1</li> <li>• SmartPen x 1</li> <li>• PB dongle x 1</li> <li>• WirelessHD dongle kit (MWIHD1) x 1</li> <li>• USB WiFi adapter x 1</li> <li>• Acer Projector Multi-media (CD-ROM) x 1</li> <li>• Acer Projector Multi-media quick start guide x 1</li> </ul>

\* Design and specifications are subject to change without notice.



# Compatibility Modes

## 1 VGA Analog - PC Signal

Mode	Resolution	V.Frequency [Hz]	H.Frequency [KHz]
VGA	640 x 480	60	31.47
		72	37.86
		75	37.50
		85	43.27
		120	61.91
SVGA	800 x 600	56	35.20
		60	37.88
		72	48.08
		75	46.88
		85	53.67
		120	77.43
XGA	1024 x 768	60	48.36
		70	56.48
		75	60.02
		85	68.68
		120	98.96
SXGA	1152 x 864	70	63.85
		75	67.50
		85	77.10
	1280 x 1024	60	63.98
		72	76.97
		75	79.98
		85	91.15
QuadVGA	1280 x 960	60	60.00
	1280 x 960	75	75.00
SXGA+	1400 x 1050	60	65.32
UXGA	1600 x 1200	60	75.00
PowerBook G4	640 x 480	60	31.50
	640 x 480	66.6 (67)	35.00
	800 x 600	60	37.88
	1024 x 768	60	48.36
	1024 x 768	75	60.241
	1152 x 870	75	68.681

WXGA	1280 x 768	60	47.78
	1280 x 768	75	60.29
	1280 x 768	85	68.63
	1280 x 720	60	45.00
	1280 x 800	60	49.70
	1280 x 800 - RB	120	101.6
	1440 x 900	60	55.94
	1680 x 1050	60	65.29
	1366 x 768	60	47.71
	1920 x 1080-RB	60	66.60
	1920 x 1080-EIA	60	67.50
	1024 x 600	60	37.50
	1920 x 1200-RB	59.95	74.04

## 2 HDMI - PC Signal

Mode	Resolution	V.Frequency [Hz]	H.Frequency [KHz]
VGA_60	640 x 480	59.94	31.469
VGA_72		72.809	37.861
VGA_75		75	37.5
VGA_85		85.008	43.269
VGA_120		119.518	61.91
SVGA_56	800 x 600	56.25	35.156
SVGA_60		60.317	37.879
SVGA_72		72.188	48.077
SVGA_75		75	46.875
SVGA_85		85.061	53.674
SVGA_120		119.854	77.425
XGA_60	1024 x 768	60.004	48.363
XGA_70		70.069	56.476
XGA_75		75.029	60.023
XGA_120		119.804	98.958
SXGA_75	1152 x 864	75	67.5
SXGA_85		84.99	77.094
SXGA_60	1280 x 1024	60.02	63.981
SXGA_72		72	76.97
SXGA_75		75.025	79.976
SXGA_85		85.024	91.146
QuadVGA_75	1280 x 960	75	75

SXGA+_60	1400 x 1050	59.978	65.317
UXGA_60	1600 x 1200	60	75
Mac G4	640 x 480@60Hz	59.94	31.469
MAC13	640 x 480@67Hz	66.667	35
Mac G4	800 x 600@60Hz	60.317	37.879
Mac G4	1024 x 768@60Hz	60.004	48.363
MAC19	1024 x 768@75Hz	75.02	60.241
MAC21	1152 x 870@75Hz	75.061	68.681
WXGA_60	1280 x 768	59.87	47.776
WXGA_75		74.893	60.289
WXGA_85		84.837	68.633
WXGA_60	1280 x 720	60	45
WXGA_60	1280 x 800	59.81	49.702
WXGA_120-RB	1280 x 800	119.909	101.563
WXGA+_60	1440 x 900	59.887	55.935
1680x1050_60	1680 x 1050	59.954	65.29
acer_16:9	1366 x 768	59.79	47.712
1920 x 1080_RB	1920 x 1080	60	66.587
1920 x 1080_EIA	1920 x 1080	60	67.5
acer_timing	1024 x 600	60	37.5
1920 x 1200-RB	1920 x 1200	59.95	74.038

### 3 HDMI - Video Signal

Mode	Resolution	V.Frequency [Hz]	H.Frequency [KHz]
480i	720 x 480 (1440 x 480)	60	15.73
480p	720 x 480	60	31.47
576i	720 x 576 (1440 x 576)	50	15.63
576p	720 x 576	50	31.25
720p	1280 x 720	60	45.00
720p	1280 x 720	50	37.50
1080i	1920 x 1080	60	33.75
1080i	1920 x 1080	50	28.13
1080p	1920 x 1080	60	67.50
1080p	1920 x 1080	50	56.26
1080p	1920 x 1080	24	27.00
1080p	1920 x 1080	23.98	26.97

#### 4 MHL - Video Signal

Mode	Resolution	V.Frequency [Hz]	H.Frequency [KHz]
480i	720 x 480 (1440 x 480)	60	15.73
480p	720 x 480	60	31.47
576i	720 x 576 (1440 x 576)	50	15.63
576p	720 x 576	50	31.25
720p	1280 x 720	60	45.00
720p	1280 x 720	50	37.50
1080i	1920 x 1080	60	33.75
1080i	1920 x 1080	50	28.13
1080p	1920 x 1080	24	27.00
1080p	1920 x 1080	23.98	26.97
1080p	1920 x 1080	30	33.75

#### 5 YPbPr Signal

Mode	Resolution	V.Frequency [Hz]	H.Frequency [KHz]
480i	720 x 480	59.94	15.73
480p	720 x 480	59.94	31.47
576i	720 x 576	50.00	15.63
576p	720 x 576	50.00	31.25
720p	1280 x 720	60.00	45.00
720p	1280 x 720	50.00	37.50
1080i	1920 x 1080	60.00	33.75
1080i	1920 x 1080	50.00	28.13
1080p	1920 x 1080	60.00	67.5
1080p	1920 x 1080	50.00	56.26
1080p	1920 x 1080	24.00	27.00
1080p	1920 x 1080	23.98	26.97

#### 6 Video, S-Video Signal

Mode	V.Frequency [Hz]	H.Frequency [KHz]	fsc (MHz)
NTSC	15.73	60	3.58
PAL	15.63	50	4.43
SECAM	15.63	50	4.25 or 4.41
PAL-M	15.73	60	3.58
PAL-N	15.63	50	3.58
PAL-60	15.73	60	4.43
NTSC4.43	15.73	60	4.43