

## MULTIMEDIA DATA/VIDEO PROJECTORS

*Bright, Vivid Images,  
Exceptional Performance &  
Enhanced Functionality*

**NEW** Mobile XGA Projector

# EX321U

**HDMI™**  
HIGH DEFINITION MULTIMEDIA INTERFACE

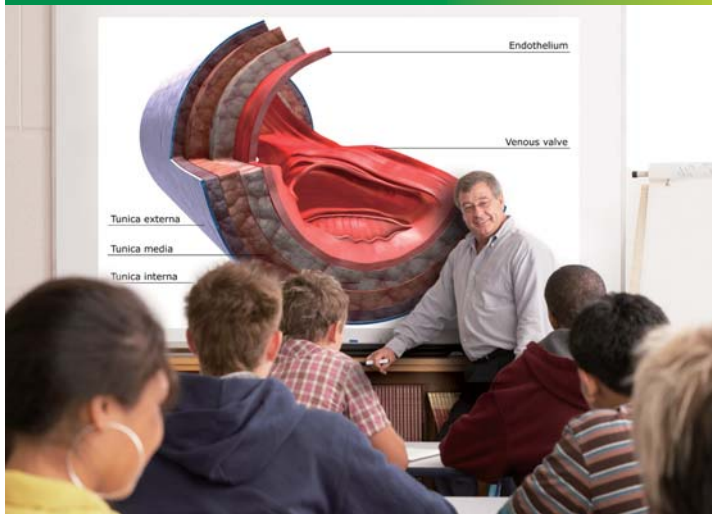

### High Image Quality

## 3000lm Brightness and 2700:1 Contrast

The EX321U reproduces vivid images using 3000lm brightness at a high contrast ratio of 2700:1. Whether used in a meeting room or classroom, clear images are reproduced even with ambient light.

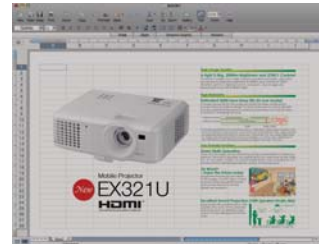

1500lm



3000lm

### High Reliability

## Estimated 5000-hour lamp life (in Low mode)

A longer service life for the projection lamp has been achieved by incorporating an optimal design for lamp temperature control. Benefits include substantial reductions in projector operating cost and the labor required for changing the lamp.

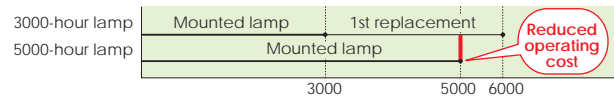

Lamp life specification is an estimate based on verification under proper conditions and is not the duration of the warranty. Lamp will shut-off automatically when usage reaches the specified estimated maximum lamp hours. Service life may vary widely depending on usage and operating environment and conditions, as well as users' adherence to the maintenance and cleaning procedures provided in the user's manual.

### User friendly function

- **Quiet 28dB Operation**
- **Advanced Network Management**



### More Functions

- **3D READY** - Enjoy the future today
- **Wall Screen**
- **Direct Power Off**
- **Top-loading lamp\***

\*1: A lamp replacement attachment is included to prevent the lamp from being dropped during replacement.



Top-loading lamp

- **Stand-by Mode under 0.5W\*2**

\*2: When LAN control is set to RS-232C, and "Stand-by Audio Out" and "Stand-by Monitor Out" are set to "Off."

- **BrilliantColor™\*3 (6-segment color wheel) Adopted**

\*3: BrilliantColor is a trademark of Texas Instruments.

- **18-language On-screen Display Capable**
- **Closed Caption (CC) Capable**
- **Dual RGB Input Terminal**
- **Audio Pass Through**

**NEW**



# Mobile XGA Projector EX321U

Brilliant Color™	Wall Screen	Password Lock	Direct Power Off	Long-life Lamp	Low Standby Power	Picture Performance User Friendly
Top Loading Lamp	Closed Caption	Low Fan Noise	LAN (RJ-45)	HDMI		

## Input and Output Terminals

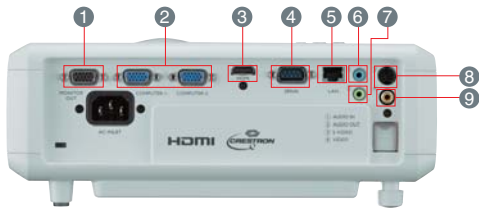

- 1 Monitor output
- 2 PC/Component video input
- 3 HDMI
- 4 Serial RS-232C
- 5 LAN (RJ-45)
- 6 Audio input
- 7 Audio output
- 8 S-Video
- 9 Video

## Dimensions

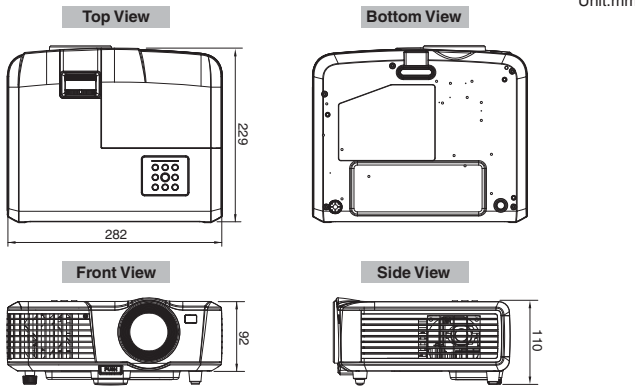

Specifications	
Model	EX321U
Display Technology	0.55" 1-Chip DMD
Resolution	1024 x 768 (Total 786,432 pixels)
Brightness*	3000lm
Contrast Ratio	2700 : 1
Picture Size	40" - 300"
Throw Ratio	1.5 - 2.0
Est. Lamp Life Rating	Standard Mode: 3500hrs Low Mode: 5000hrs
PC Compatibility	640 x 480 - 1600 x 1200, True : 1024 x 768, Sync on Green available
Video Compatibility	NTSC / NTSC 4.43 / PAL (including PAL-M, N) / SECAM / PAL-60 Component Video; 480i/p (525i/p), 576i/p (625i/p), 720p (750p), 1080i/p (1125i/p 60Hz), 1080i/p (1125i/p 50Hz)
Input Terminals	RGB: mini D-sub 15pin x 2 Video: RCA x 1 + S-VIDEO x 1 Digital: HDMI x 1 Audio: Stereo mini jack (ø3.5mm) x 1
Output Terminals	RGB: mini D-sub 15pin x 1 Audio: Stereo mini jack (ø3.5mm) x 1
Communication Terminals	Serial: D-Sub 9pin x 1 (RS-232C) LAN: RJ-45 x 1 (Projector Control)
Speaker Output	10W Mono
Dimensions (W x H x D)	11.1" x 3.6" x 9.0"
Weight	5.5lbs
Power Requirements	AC 100-240V, 50/60Hz
Optional Lamp	VLT-EX320LP
Warranty	3-Years of Parts/Labor, 3-Years of Express Replacement Assistance (ERA), 1-year or 500 hours lamp warranty (whichever comes first)

\*Compliant with ISO21118-2005 • Varies depended on condition. • All brand names and product names are trademarks, registered trademarks or trade names of their respective holders. • Lamp life specification is an estimate based on verification under proper conditions and is not the duration of the warranty. Lamp will shut-off automatically when usage reaches the specified estimated maximum lamp hours. Service life may vary widely depending on usage and operating environment and conditions, as well as users' adherence to the maintenance and cleaning procedures provided in the user manual. • "HDMI", the HDMI Logo, and High-Definition Multimedia Interface are trademarks or registered trademarks of HDMI Licensing LLC in the United States and other countries.

## Screen size and Projection distance

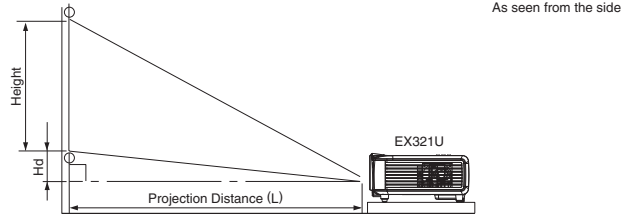

Screen size chart (4:3 aspect ratio)

Diagonal Size		Screen				Distance from screen (L)				Height projected image (Hd)	
		Width (W)		Height (H)		Shortest (Wide)		Longest (Tele)		inch	cm
inch	cm	inch	cm	inch	cm	inch	m	inch	m	inch	cm
40	102	32	81	24	61	48	1.2	63	1.6	2	5
60	152	48	122	36	91	73	1.8	94	2.4	3	7
80	203	64	163	48	122	97	2.5	126	3.2	4	9
100	254	80	203	60	152	121	3.1	157	4.0	5	11
120	305	96	244	72	183	145	3.7	189	4.8	5	14
150	381	120	305	90	229	182	4.6	236	6.0	7	17
200	508	160	406	120	305	242	6.2	315	8.0	9	23
250	635	200	508	150	381	303	7.7	394	10.0	11	29
300	762	240	610	180	457	363	9.2	472	12.0	14	34

The above numbers are approximate, and may be slightly different from the actual measurements.

Screen size chart (16:9 aspect ratio)

Diagonal Size		Screen				Distance from screen (L)				Height projected image (Hd)	
		Width (W)		Height (H)		Shortest (Wide)		Longest (Tele)		inch	cm
inch	cm	inch	cm	inch	cm	inch	m	inch	m	inch	cm
40	102	35	89	20	50	52	1.3	68	1.7	5	13
60	152	52	133	29	75	78	2.0	102	2.6	8	20
80	203	70	177	39	100	105	2.7	136	3.5	10	26
100	254	87	221	49	125	131	3.3	170	4.3	13	33
120	305	105	266	59	149	157	4.0	204	5.2	16	40
150	381	131	332	74	187	196	5.0	255	6.5	19	49
200	508	174	443	98	249	261	6.6	340	8.6	26	66
250	635	218	553	123	311	327	8.3	425	10.8	32	82
300	762	261	664	147	374	392	10.0	-	-	39	99

The above numbers are approximate, and may be slightly different from the actual measurements.

**eco changes for a greener tomorrow**

Eco Changes is the Mitsubishi Electric Group's environmental statement, and expresses the Group's stance on environmental management. Through a wide range of businesses, we are helping contribute to the realization of a sustainable society.

**MITSUBISHI ELECTRIC VISUAL SOLUTIONS AMERICA**  
Professional Product Sales  
Phone: 888.307.0349  
www.mitsubishi-presentations.com

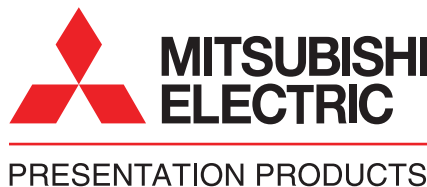

**MITSUBISHI ELECTRIC SALES CANADA, INC.**  
Display & Imaging Solutions Division  
Phone: 905.475.7728  
www.mitsubishielectric.ca