

HD102

**HDTV
DLP Projector**



Users Manual v1.1

FCC Warning

Note: This equipment has been tested and found to comply with the limits for a Class B digital device, pursuant to part 15 of the FCC Rules. These limits are designed to provide reasonable protection against harmful interference in a residential installation. This equipment generates, uses and can radiate radio frequency energy and, if not installed and used in accordance with the instructions, may cause harmful interference to radio communications. However, there is no guarantee that interference will not occur in a particular installation. If this equipment does cause harmful interference to radio or television reception, which can be determined by turning the equipment off and on, the user is encouraged to try to correct the interference by one or more of the following measures:

- Reorient or relocate the receiving antenna.
- Increase the separation between the equipment and receiver.
- Connect the equipment into an outlet on a circuit different from that to which the receiver is connected.
- Consult the dealer or an experienced radio/TV technician for help.

Canada

This Class B digital apparatus complies with Canadian ICES-003.
Cet appareil numérique de la classe B est conforme à la norme NMB-003 du Canada.

Safety Certifications

UI, cUL, TUV, GOST

Other specific Country Approvals may apply. Please see product certification label.

Declaration of Conformity

Knoll Systems, 11791 Machrina Way #210, Richmond, BC V7A 4V3, Canada

We declare under our sole responsibility that this projector conform to the following directives and norms:

EMC Directive 89/336/EEC, Amended by 93/68/EEC
EMC: EN 55022
EN 55024
EN 61000-3-2
EN 61000-3-3
Low Voltage Directive 73/23/EEC, Amended by 93/68/EEC
Safety: EN 60950: 2000

April 2004

Trademarks

Apple, Macintosh, and PowerBook are trademarks or registered trademarks of Apple Computer, Inc. IBM is a trademark or registered trademark of International Business Machines, Inc. Microsoft, PowerPoint™, and Windows are trademarks or registered trademarks of Microsoft Corporation. Adobe and Acrobat are trademarks or registered trademarks of Adobe Systems Incorporated. Digital Light Processing is a trademark or registered trademark of Texas Instruments. Faroudja, DCDi, and TrueLife are trademarks or registered trademarks of Faroudja. Knoll and Knöll are trademarks of Pacific Sound & Signal Inc.

WARNING: This product contains chemicals, including lead, known to the State of California to cause birth defects or other reproductive harm. ***Wash hands after handling.***

WARNING: This product has a lamp, which contains a very small amount of mercury. Dispose of it as required by local, state, or federal ordinances and regulations. For more information, see www.eiae.org.

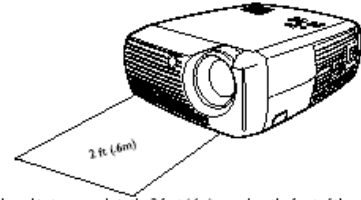
TABLE OF CONTENTS

Safety Warnings	2
Introduction	5
Positioning the projector	6
Projector and Device Connector Guide	6
Computer connections	6
Video connections	7
Connecting a computer source	8
Required computer connections	8
Optional computer connections	8
Displaying a computer source image	9
Adjusting the image	9
Using the projector with Windows 98 for the first time	10
Connecting a video device	11
Video device connections	11
RCA composite video connection	12
S-video connection	12
RCA component connection	12
DVI connection	12
Displaying video	13
Adjusting the image	13
Shutting down the projector	14
Troubleshooting your setup	14
Using the remote control	19
Using the audio	19
Using the keypad buttons	19
Optimizing computer images	20
Optimizing video images	20
Customizing the projector	21
Using the menus	21
Picture menu	22
Settings menu	25
Maintenance	25
Cleaning the Lens	24
Replacing the Projection Lamp	25
Cleaning the Lamp Housing Screens	26
Using the security lock	26
Appendix	27
Projected Image Size	27
Red LED Behavior and Projector Errors	27

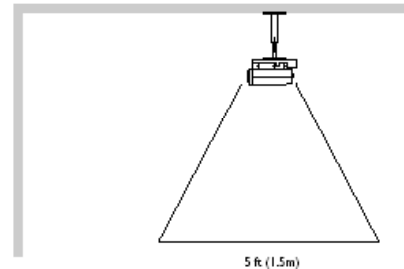
If you are experienced in setting up projection systems, use the *Quick Setup* card that is included with the projector. For complete details on connecting and operating the projector, refer to this User's Guide.

Important Operating Considerations for Safety

- Place the projector in a horizontal position no greater than 15 degrees off axis.
- Locate the projector in a well-ventilated area without any obstructions to intake or exhaust vents.
- Do not place the projector on a tablecloth or other soft covering that may block the vents.
- Locate the projector at least 4' (1.2 m) away from any heating or cooling vents.
- Use only Knoll-approved ceiling mounts.
- Use only the power cord provided. A surge-protected power strip is recommended.
- Refer to this manual for proper startup and shutdown procedures.
- In the unlikely event of the lamp rupturing, discard any edible items placed in the surrounding area and thoroughly clean the area along all sides of the projector.
- Wash hands after cleaning the area and handling the ruptured lamp. This product has a lamp, which contains a very small amount of mercury. Dispose of it as required by local, state or federal ordinances and regulations. For more information see www.eiae.org.



Do not place objects or people in the 2 foot (.6m) area along the front of the projector. For ceiling mount applications, this area should be 5 foot (1.5m).



Follow these instructions to help ensure image quality and lamp life over the life of the projector. Failure to follow these instructions *may* affect the warranty. For complete details of the warranty, see the Warranty section at the end of this User's Guide.

Introduction

Congratulations and thank you for your excellent choice of a superior digital image projection device. Your new Knoll HD102 projector is specifically designed for home cinema applications. The HD102 sets a high standard using the latest DLP™ technology and new DCDi Plus video processing from Faroudja™. Whether you are watching movies or High Definition broadcasts or playing the latest video game, you will enjoy amazing image quality.

Product specifications

To read the latest specifications on your multimedia projector, be sure to visit our website, as specifications are subject to change. Visit www.knollsystems.com for more information.

Accessories

The standard accessories that came with your projector can be found on the included packing list. Optional accessories are listed in the Accessories catalog that came with the projector and can also found on our website. See the inside back cover for the web address.

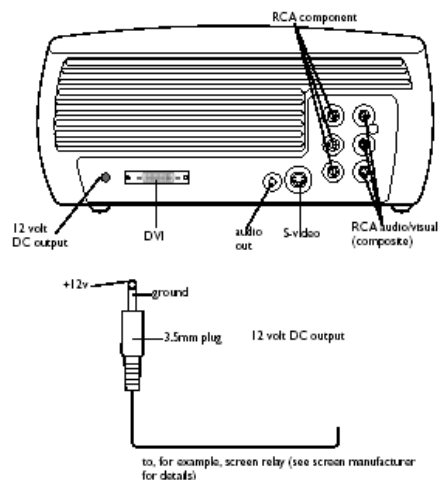
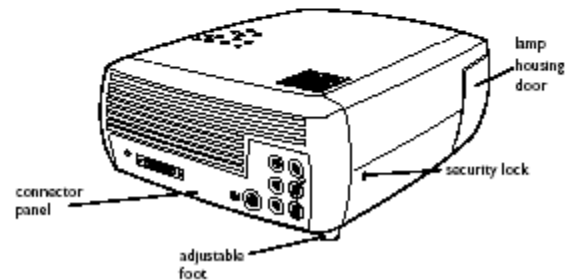
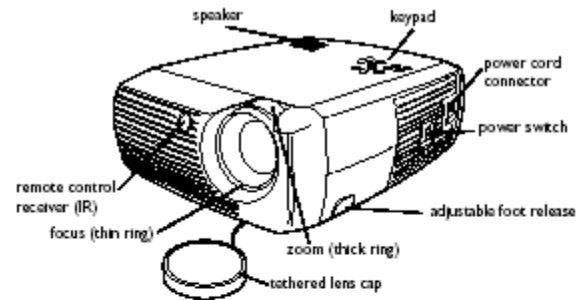
Connector Panel

The projector provides both computer and video connection options, including:

- DVI (M1-DA)
- Component SD/ED/HD (RCA)
- S-video
- Composite audio/video (RCA)

The projector also provides the following connectors:

- Audio out
- 12-volt DC output (see next page)



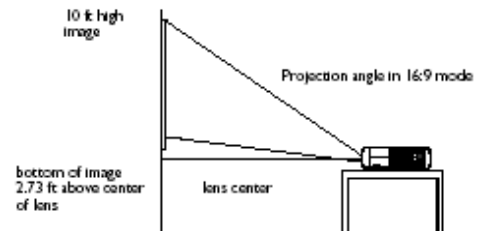
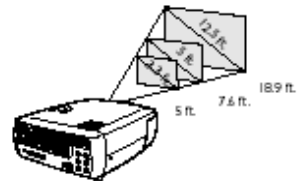
12-volt DC output

The 3.5mm mini-jack trigger provides a 12-volt DC output. It provides a constant output while the projector is on. It has numerous uses. For example, if you connect your projection screen to the 12-volt DC output with the cable that came with your screen, when you turn on the projector the screen will move down; when you turn the projector off, the screen will return to the storage position. To use the 12-volt DC output, you must first remove the safety plug.

Positioning the projector

To determine where to position the projector, consider the size and shape of your screen, the location of your power outlets, and the distance between the projector and the rest of your equipment. Here are some general guidelines:

- Position the projector on a flat surface at a right angle to the screen. The projector must be at least 4.9 feet (1.49m) from the projection screen.
- Position the projector within 10 feet (3m) of your power source and within 6 feet (1.8m) of your video device (unless you purchase extension cables). To ensure adequate cable access, do not place the projector within 6 inches (.15m) of a wall or other object.
- To turn the image upside down, see “Ceiling” on page 24. We recommend using an authorized ceiling mount.



- Position the projector the desired distance from the screen. The distance from the lens of the projector to the screen, the zoom setting, and the video format determine the size of the projected image. The top illustration to the right shows three projected image sizes. For more information about image sizes at different distances, see “Projected Image Size” on page 27.
- The image offset is 127.3% when the projector is in 16:9 mode. This means that if you have an image 10’ high, the bottom of the image will be 2.73’ above the center of the lens.
- See “Connecting a video device” on page 11 for additional information on 16:9 mode.

Projector and Device Connector Guide

The following illustration and table should help you find the connectors to use and obtain the best resolution possible from your input devices, such as computers, standard VCRs, DVD players (progressive and interlaced), HDTV sources, TV and satellite tuners, camcorders, video games (progressive and interlaced), and laser disc players.

Computer connections

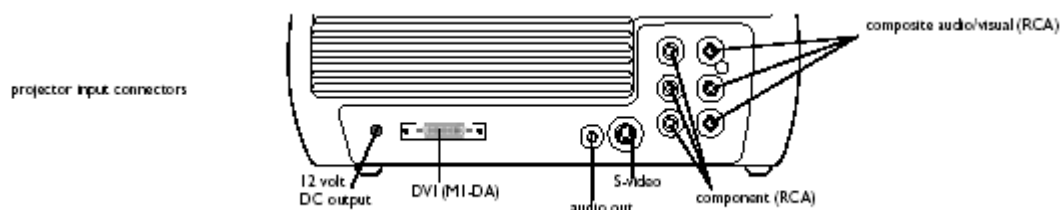
Computer connections involve attaching the VGA and USB ends of the provided computer cable to a computer and connecting the other end (M1 cable end) to the **Computer In** input on the projector. The USB part of the computer cable allows you to advance slides in a PowerPoint™ presentation via a remote control. See page 6 for computer/projector setup information.

Video connections

The first step for connecting video is deciding what type of output connector you want to connect to the projector. If there is more than one output, select the one with the highest quality. The best quality ranking, with **1** being the highest and **3** being the lowest, is:

1. component video (RCA)
2. S-video
3. audio/visual composite video (RCA)

If your video device has a VGA connector, you can use the DVI connector on the back of the projector for very high quality.



Video Device	Video Compatibility	If Your Device Connector is	Attached to Adapter or Labeled Connector on projector	For Setup Instructions see	Comments
Standard Broadcast TV (not HDTV) via cable digital cable, satellite TV, DVD, or VCR	NTSC, PAL, and SECAM formats Component 480i	Composite video or S-video Component Video	Composite video or S-video Component Video	Composite (RCA) video connection on page 11. Component on page 12.	Not for progressive (i.e. HDTV sources). See page 6.
Standard Video Camera	NTSC, PAL, and SECAM formats Component 480i	Composite video or S-video Component Video	Composite video or S-video Component Video	Composite (RCA) video connection on page 11. Component on page 12.	Not for progressive (i.e. HDTV sources). See page 6.
Standard Video Game	NTSC, PAL, and SECAM formats Component 480i	Composite video or S-video Component Video	Composite video or S-video Component Video	Composite (RCA) video connection on page 11. Component on page 12.	Not for progressive (i.e. HDTV sources). See page 6.

Video Device	Video Compatibility	If Your Device Connector is	Attached to Adapter or Labeled Connector on projector	For Setup Instructions see	Comments
HDTV (High Definition TV)	1035i, 1080i, 720p Component 480i, 480p, 576i, 576p	DVI Component Video	Computer In (DVI) Video 1 (component RCA)	DVI connection on page 12 Component on page 13	
Progressive DVD	1035i, 1080i, 720p Component 480i, 480p, 576i, 576p	DVI Component Video	Computer In (DVI) Video 1 (component RCA)	DVI connection on page 12 Component on page 13	
Progressive Video Game	1035i, 1080i, 720p Component 480i, 480p, 576i, 576p	DVI Component Video	Computer In (DVI) Video 1 (component RCA)	DVI connection on page 12 Component on page 13	

Connecting a computer source

Required computer connections

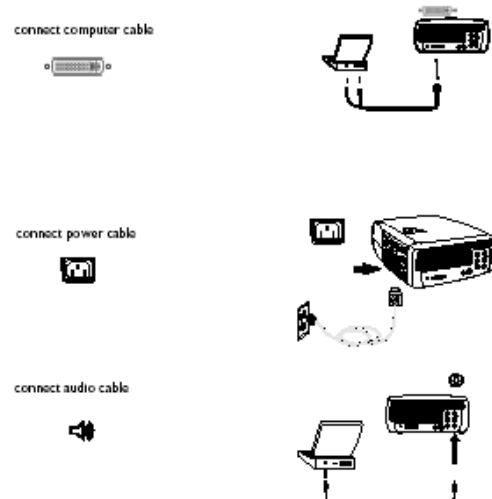
Connect one end of the provided computer cable (see page 11 for connecting video devices) to the blue DVI **Computer In** connector on the projector. Connect the other ends (USB and VESA) to the USB and VGA ports on your computer. If you are using a desktop computer, you will need to disconnect the monitor cable from the computer's video port first. This connection allows you to advance slides in a PowerPoint™ presentation using the remote. USB drivers must be installed to use the USB feature. For more information, see page 10.

Connect the black power cord to the **Power** connector on the side of the projector and to your electrical outlet.

NOTE: Always use the power cord shipped with the projector.

Optional computer connections

To have sound with your presentation, connect an audio cable (not included) to your computer and to the red and/or white **Audio In** connectors on the projector.



Displaying a computer source image

Remove the lens cap. Toggle the **Power** switch on the side of the projector to the On position.

The LED flashes green and the fans start to run. When the lamp comes on, the start up screen displays and the LED is steady green. It can take a minute for the image to achieve full brightness.

? No start up screen? Get help on page 15. Turn on your computer.

The computer's image should appear on the projection screen. If it doesn't, press the **Computer** button on the projector's keypad. If your computer has Windows 98 as its operating system, see "Using the projector with Windows 98 for the first time" on page 10, regarding the driver setup process. Make sure your laptop's external video port is active. Many laptops do not automatically turn on their external video port when a projector is connected.

Usually a key combination like FN + F8 or CRT/LCD key turns the external display on and off. Locate a function key labeled CRT/LCD or a function key with a monitor symbol. Press FN and the labeled function key simultaneously. **Refer to your laptop's documentation to learn your laptop's key combination.**

? No laptop image? Try pressing the keypad **Auto Image** button. Get help on page 15.

Adjusting the image

If necessary, adjust the height of the projector by pressing the release button to extend the foot.

If necessary, rotate the leveling foot located at the rear of the projector.

Avoid placing your hands near the hot exhaust vent in front of the projector.

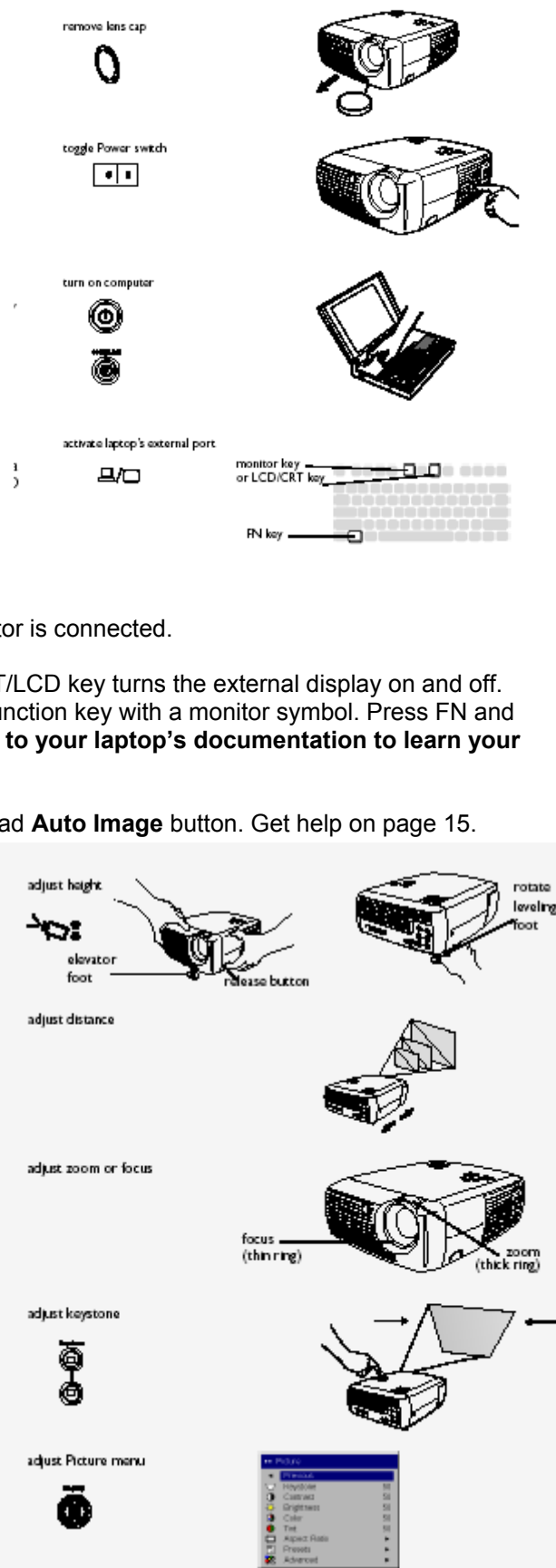
Position the projector the desired distance from the screen at a 90-degree angle to the screen.

See page 27 for a table listing screen sizes and distances.

Adjust the zoom or focus.

If the image is not square, adjust the keystone using the buttons on the keypad.

(continued next page)



Press the top **Keystone** button to reduce the upper part of the image, and press the bottom **Keystone** button to reduce the lower part.

Adjust the Contrast or Brightness in the Picture menu.

See page 21 for help with these menu adjustments.

Using the projector with Windows 98 for the first time

The first time you connect a computer running Windows 98 to the projector, the computer recognizes the projector as “new hardware” and the Add New Hardware Wizard appears. Follow these instructions to use the Wizard to load the correct driver (which was installed with your Windows operating system).

If you are running Windows 2000 or Windows ME, skip these steps and go to “Adjusting the image” on page 9.

a) Click **Next** to begin searching for the driver.



b) Make sure “Search for the best driver” is selected, then click **Next**.



c) Uncheck any checked boxes, and then click **Next**. Windows automatically locates the driver. If this driver has been removed, reload the driver using your Windows operating system CD.



d) When Windows finds the driver, you are ready to install it. Click **Next**.



Skip this section if you did not connect a USB mouse cable for Windows 98:

- If you connected the USB cable, the Add New Hardware Wizard appears again. Drivers must be installed to use the USB functionality.

The Wizard launches three times:

- The first time it detects a USB Composite Device.
- The second time a USB Human Interface Device (for the keyboard).
- The third time it detects a USB Human Interface Device (for the mouse).

For Windows 2000, Windows ME, and Windows XP:

- The USB drivers are automatically installed.

Connecting a video device

You can connect video devices such as VCRs, DVD players, camcorders, digital cameras, video game consoles, HDTV receivers, and TV tuners to the projector. There is also an audio input via the red and white A/V connectors.

You can connect the audio directly to the projector to get sound from the built-in speaker, or you can connect the audio to your stereo system via the Audio Out connector.

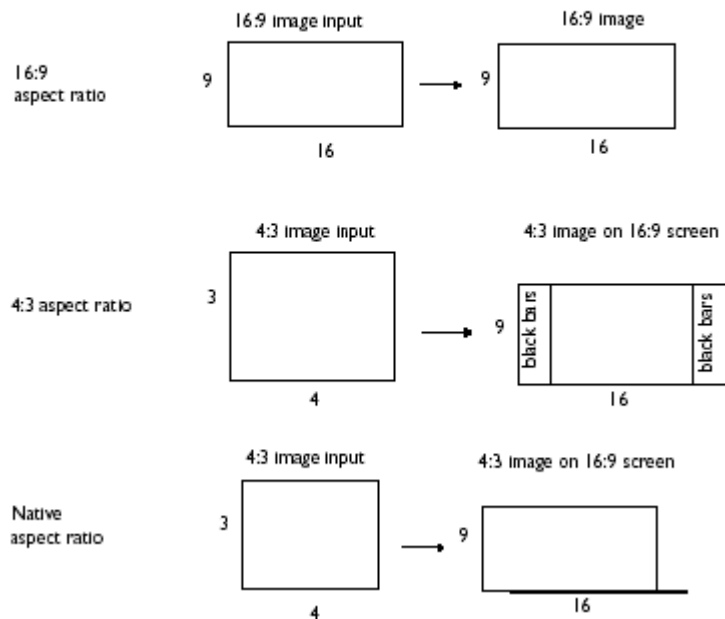
You can connect the projector to most video devices that can output video. You cannot directly connect the coaxial cable that enters your house from a cable or satellite company the signal must pass through a tuner first. Examples of tuners are digital cable boxes, VCRs, digital video recorders, and satellite TV boxes. Basically, any device that can change channels is considered a tuner.

Before connecting your projector, you should decide which aspect ratio you want to use. The projector's Aspect Ratio setting is accessed through the projector's Picture Menu. See page 22 for more information.

What is Aspect Ratio?

Aspect ratio is the ratio of the image width to image height. HDTV and most DVDs are 16:9, which is the default for this projector. This projector is not intended for use with 4:3 screens. When in 4:3 mode the projector places black bars on both sides of the image. Native mode centers the image and turns off the internal scaler so that any resolution larger than 854x480 is cropped on the edges.

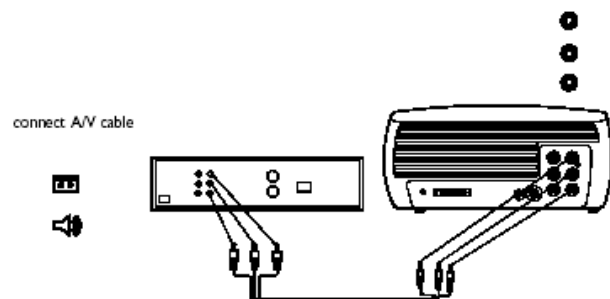
If you are projecting onto a screen, the size/shape of the screen may determine which aspect ratio to use. If you are projecting onto a blank wall, you don't have the screen size restriction. What you plan to project will also help you choose between 4:3 and 16:9. For example, most TV shows are 4:3, while most movies are 16:9. If you have a 16:9 screen, then you should select an aspect ratio of 16:9 for anamorphic movies and HDTV, and Native for 4:3 content. If you have a 4:3 screen you should still use 16:9 for anamorphic movies or HDTV, but you also have the option of using either 4:3 or Native for 4:3 content. Keep in mind that anamorphic movies only appear correctly if the DVD player is set to output to a 16:9 television.



Video device connections

Composite (RCA) video connection

Plug the provided composite A/V cable's yellow connector into the video out connector on the video device. Plug the other yellow connector into the yellow **Video 2** connector on the projector.



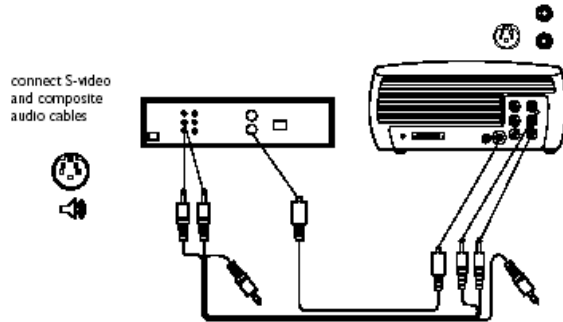
Plug a white connector into the left audio out connector on the video device and plug a red connector into the right audio out connector on the video device. Plug the remaining white connector into the white **audio in** connector on the projector, and plug the remaining red connector into the red **audio in** connector on the projector.

Keep in mind that video output from composite connections are not as high quality as S-video or component video.

S-video connection

If your video device uses a round, seven-prong S-video connector, plug an S-video cable into the S-video connector on your video device and into the **S-video** connector on the projector. Use the A/V cable's red and white audio connectors as described directly above (the yellow connectors on the A/V cable are not used).

Keep in mind that S-video delivers higher-quality video output than composite, but not as high as component video.

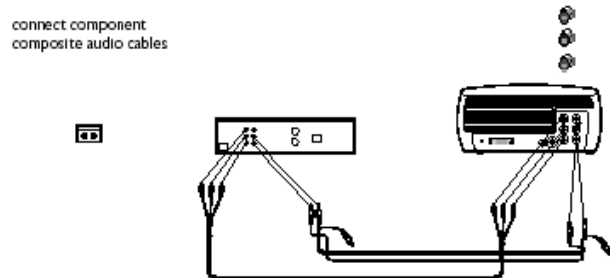


Component (RCA) connection

To connect a progressive scan DVD or HD source, use the component connector. Connect a component video cable with red, green, and blue RCA connectors into the source device component connector. Connect the other three ends of the component cable into the component Video connector on the projector.

Use the composite A/V cable's red and white audio connectors as described on the previous page (the yellow connectors on the A/V cable are not used).

Keep in mind that component video delivers higher quality video output than S-video or composite video.

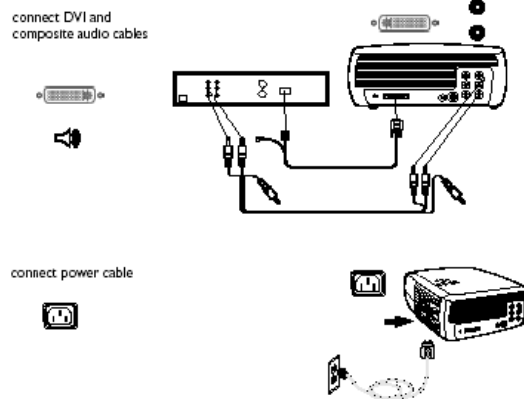


DVI connection

If your video device uses a DVI connector, plug the DVI end of the M1-DA cable into the video-out connector on the video device. This connector may be labeled "To Monitor" on the video source. Plug the M1 computer end of the cable into the **Computer In** connector on the projector. Do not plug the USB end of this cable into the video device.

Use the composite A/V cable's red and white audio connectors as described on the previous page (the yellow connectors on the A/V cable are not used).

Keep in mind that DVI video delivers the highest quality video output.



Connect the power cord to the **Power** connector on the side of the projector and to your electrical outlet.

NOTE: Always use the power cord that shipped with the projector.

Displaying video

Remove the lens cap.

Toggle the **Power** switch on the side of the projector to the **On** position. The LED flashes green and the fans start to run. When the lamp comes on, the start-up screen is displayed and the LED is steady green. It can take a minute for the image to achieve full brightness.

? No start up screen? Get help on page 15.

Plug in and turn on your video device.

The video device's image should appear on the projection screen. If it doesn't, press the **Video** button on the keypad.

? No image? Try pressing the **Source** or **Auto Image** Get help on page 15.

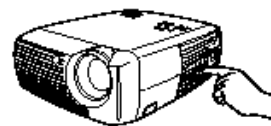
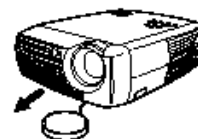
remove lens cap



toggle Power switch



turn on video device



Adjusting the image

Adjust the height of the projector by pressing the release button to extend the foot.

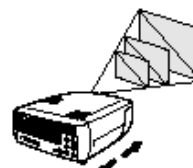
Rotate the leveling foot at the rear of the projector, if necessary. Position the projector the desired distance from the screen at a 90-degree angle to the screen.

See page 27 for a table listing screen sizes and distances to the screen.

adjust height

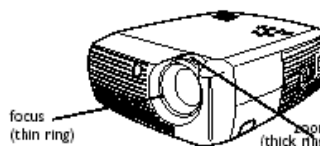


adjust distance



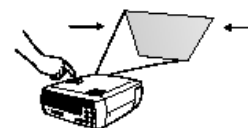
Adjust the zoom and focus.

adjust zoom and focus



If the image is not square, adjust the keystone using the buttons on the keypad. Press the top **Keystone** button to reduce the upper part of the image, and press the bottom **Keystone** button to reduce the lower part.

adjust keystone



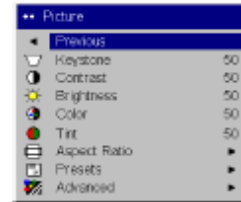
Adjust the volume on the keypad or remote.

adjust volume



Adjust the Contrast, Brightness, Color, Tint, or Aspect Ratio in the Picture menu. See page 22 for help with the menus and these adjustments.

adjust Picture menu options including Aspect Ratio



For Aspect Ratio, keep in mind that DVD players must be configured for 16:9 in order to view the highest quality image. For more information regarding Aspect Ratio, see page 11.

Shutting down the projector

The projector automatically displays a black screen after no active source is detected for 30 minutes. This black screen helps preserve the life of the projector. The image returns when an active source is detected or a remote or keypad button is pressed.

Screen Save

You can make the black screen appear after a preset number of minutes by turning on the Screen Save feature in the **Settings>System** menu. See page 24.

Power Save

The projector also has a Power Save feature that automatically turns the lamp off after no active sources are detected and no user interaction with the projector is performed for 20 minutes. By default, this feature is off. See page 24.

Turning off the projector

You can turn the projector off simply by toggling the power switch to the off position.

You can also press the remote's **Power** button to place the projector in the Off state while it is running. When the **Power** button is pressed twice (once to start the power-down process and a second time to verify that you want to power the projector off), the lamp turns off and the LED blinks green for one (1) minute while the fans continue to run to cool the lamp. While the LED is blinking green, the projector does not accept any keypad and remote control input.

When the lamp has cooled, the LED lights solid green and the fans slow down to minimal speed. To turn off the projector, toggle the power switch to the off position. **NOTE:** Once the projector has been toggled off, you must wait for one (1) minute before turning the projector on again. This allows the lamp to properly cool. However, if the remote was used to power the projector to the Off state you do not need to wait one minute to turn it on again.

Troubleshooting your setup

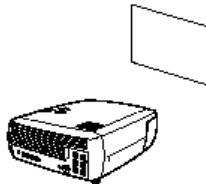
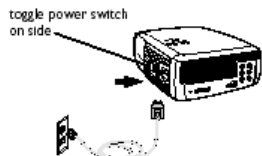
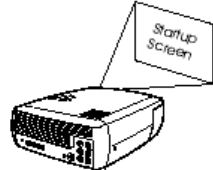
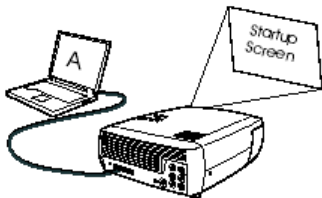

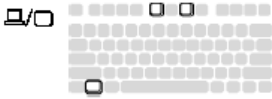
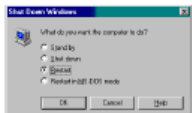
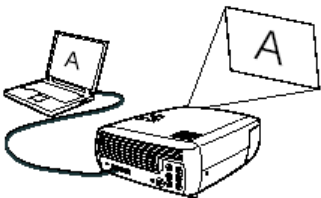
If your image appears correctly on the screen, skip to the next section. If it does not, troubleshoot the setup.

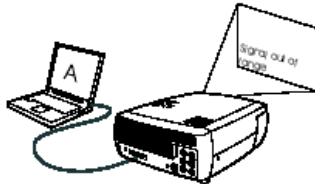


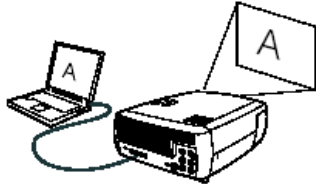
The LED on top of the projector indicates the state of the projector and can help you troubleshoot.

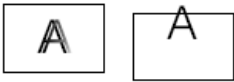

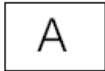
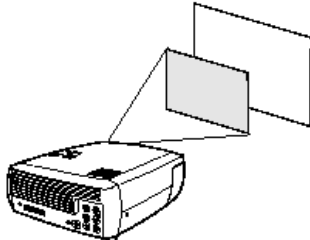
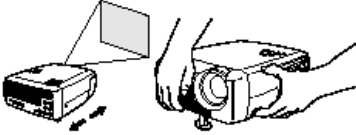
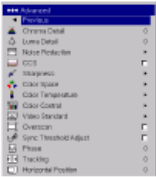
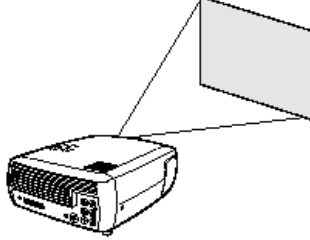
Table 1: LED behavior and meaning


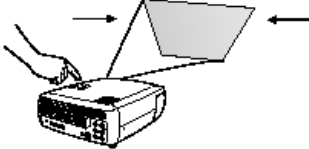




LED color/behavior	Meaning
Solid Green	The power switch has been toggled on and the software has initialized or the projector has been powered off via the remote.
Blinking Green	The power switch has been toggled on and the software is initializing, or the projector is powering down and the fans are running to cool the lamp.
Blinking Red See page 18 for more information	A fan or lamp failure has occurred. Make sure the vents aren't blocked (see page 18). Turn off the projector and wait one minute, then turn the projector on again. If the projector exceeds its lamp life (page 25), replace the lamp and reset the lamp timer. Contact Technical Support if the problem persists.
Solid Red	An unidentifiable error; please contact Technical Support.







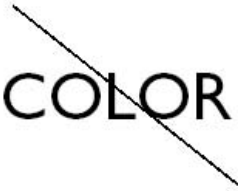


The following tables show common problems. In some cases, more than one possible solution is provided. Try the solutions in the order they are presented. When the problem is solved, you can skip the additional solutions.

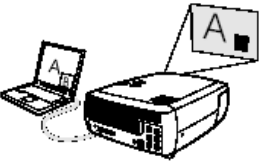
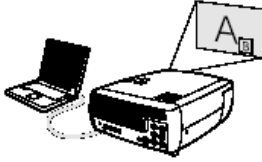
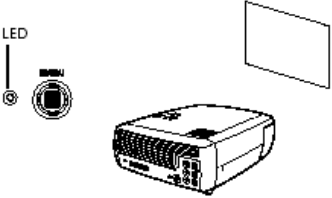

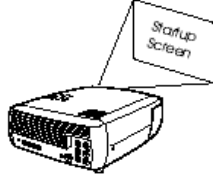
Problem	Solution	Result
<p>no start up screen</p> 	<p>plug power cord in projector's left side remove lens cap toggle power switch</p> 	<p>correct image</p> 
<p>only start up screen appears</p> 	<p>press the Computer button  activate laptop's external port</p>  <p>restart laptop</p> 	<p>computer image projected</p> 

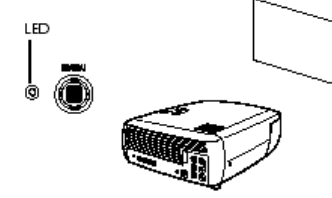
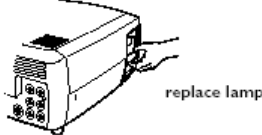
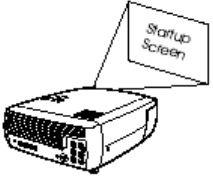
Problem	Solution	Result
<p>no computer image, just the words "Signal out of range"</p> 	<p>press the Auto Image button on keypad</p>  <p>adjust computer refresh rate in Control Panel>Display>Settings>Advanced>Adapter (location varies by operating system)</p>  <p>you may also need to set a different resolution on your computer, as shown in the following problem, "image fuzzy or cropped"</p>	<p>computer image projected</p> 

Problem	Solution	Result
<p>image fuzzy or cropped</p> 	<p>set your computer's display resolution to the native resolution of the projector (Start>Settings>Control Panel>Display>Settings tab) select 854x480</p> <p>For a laptop, disable laptop monitor or turn-on dual-display mode</p> 	<p>image clear and not cropped</p> 
<p>image not centered on screen</p> 	<p>move projector, adjust zoom, adjust height</p>  <p>adjust horizontal or vertical position in Picture>Advanced menu</p> 	<p>correct image</p> 

Problem	Solution	Result
image not square 	adjust Keystone on keypad 	square image 
image not sharp 	adjust Sharpness (video sources only) in the Picture>Advanced menu 	correct image 

Problem	Solution	Result
image upside down 	turn off ceiling in Settings>System menu 	correct image 
image reversed left to right 	turn off rear in Settings>System menu 	correct image 
projected colors don't match source 	adjust color, tint, color temperature, brightness, contrast in the menus 	correct image 

Problem	Solution	Result
<p>The video embedded in my PowerPoint presentation does not play on the screen</p> 	<p>Turn off the internal LCD display on your laptop</p>	<p>Embedded video plays correctly</p> 
<p>lamp won't turn on, LED blinking red</p> 	<p>make sure vents aren't blocked, turn off the projector and allow it to cool for one minute</p> 	<p>lamp turns on</p> 

Problem	Solution	Result
<p>"Change lamp" message appears at startup or lamp won't turn on and LED blinking red</p> 	<p>lamp must be replaced (see page 40)</p> 	<p>lamp turns on</p> 

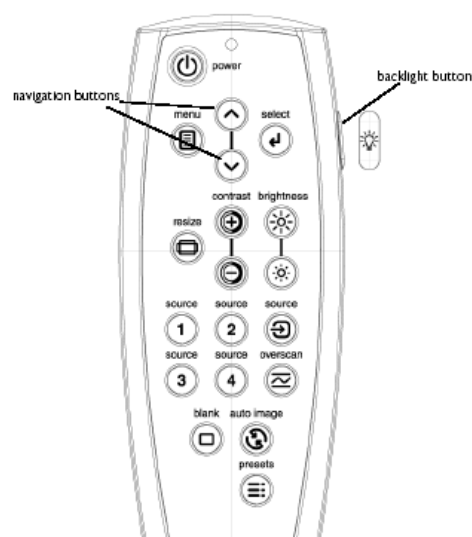
If you still need assistance, visit our website or call us. See the inside of the back cover for support contact information. This product is backed by a limited warranty. When sending the projector in for repair, we recommend shipping the unit in its original packing material, or having a professional packaging company pack the unit. Please insure your shipment for its full value.

Using the remote control

The remote uses two (2) provided AAA batteries. They are easily installed by sliding the cover off the remote's back, aligning the + and - ends of the batteries, sliding them into place, and then replacing the cover.

To operate, point the remote at the projection screen or at the projector (not at the video device or computer). The range of optimum operation is up to 30 feet (9.14m). Press the remote's **Menu** button to open the projector's menu system. Use the arrow buttons to navigate, and the **Select** button to select features and adjust values in the menus. See page 21 for more info on the menus. The remote also has:

- **Power** button to turn the projector on and off (see page 14 for shutdown info)
- **Backlight** button to light the remote's buttons in the dark
- **Brightness** and **Contrast** buttons to adjust the image
- **Blank** button to display a blank screen instead of the current image (to change the color of the screen, see page 24)
- **Source** buttons to switch among sources (to assign a particular source to a source button, see page 23) and a source toggle
- **Resize** button to change the Aspect Ratio (see page 22)
- **Auto Image** button to resynch the projector to the source
- **Preset** button to restore stored settings (see page 22)
- **Overscan** button to remove noise in a video image (page 23)



Troubleshooting the remote

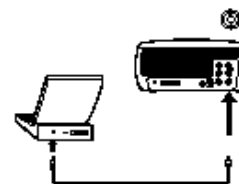
- Ensure the batteries are installed in the proper orientation and are not dead. Ensure you're pointing the remote at the projector or the screen, not at the video device or the computer, and are within the remote range of 30 feet (9.14m).

Using the audio

Using the projector's speakers

To use the projector's speaker, connect your source to the **Audio In** connectors (**L** and/or **R**) on the projector's composite connectors. To adjust the volume, press the **Volume** buttons on the keypad or remote. To mute the sound, press the **Mute** button on the remote.

connect audio cable



Troubleshooting Audio

If you aren't hearing the audio, check the following:

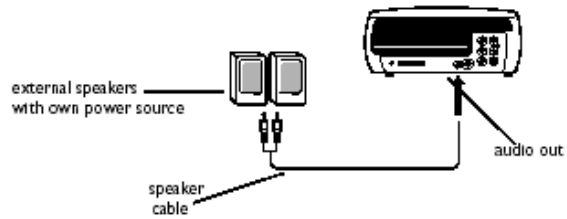
- Make sure the audio cable is connected.
- Make sure mute is not active (press the **Mute** button on the remote).
- Make sure the volume is turned up enough.
- Press the **Volume** button on the keypad or remote.
- Make sure the correct source is active.
- Adjust the audio source.
- If playing a video, make sure the playback has not been paused.

adjust volume



Connecting external speakers

The projector can be attached to external speakers that have their own power source by plugging a speaker cable (not included) into the projector's **Audio Out** connector.



Using the keypad buttons

Most buttons are described in detail in other sections, but here is an overview of their functions:

Menu—opens the on-screen menus (page 21).

Select—confirms choices made in the menus (page 21).

Up/Down arrows—navigates to and adjusts settings in the menus (page 21).

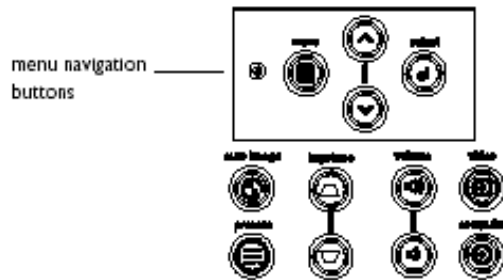
Auto Image—resets the projector to the source.

Presets—cycles through the available preset settings (page 22).

Keystone—adjusts squareness of the image (page 9).

Volume—adjusts sound (page 19).

Video and **Computer**—changes the active source.



Optimizing computer images

After your computer is connected properly and the computer's image is on the screen, you can optimize the image using the onscreen menus. For general information on using the menus, see page 21.

- Adjust the Keystone, Contrast, or Brightness in the Picture menu (page 22).
- Change the Aspect Ratio. Choose the option that best fits your input source (page 22).
- Adjust the Color Temperature in the Advanced menu (page 21).
- Adjust the Phase, Tracking, or Horizontal or Vertical position in the Advanced menu (page 23).
- Once you have optimized the image for a particular source, you can save the settings using Presets. This allows you to quickly recall these settings later (page 22).

Optimizing video images

After your video device is connected properly and the image is on the screen, you can optimize the image using the onscreen menus. For general information on using the menus, see page 21.

- Adjust the Keystone, Contrast, Brightness, Color, or Tint in the Picture menu (page 22).
- Select a Sharpness setting (page 22).
- Use the Color Control to adjust the color gain (page 22).
- Adjust the Color Temperature. Select a listed value (page 22).
- Turn on Overscan to remove noise on the edges of the video image (page 23).
- Change the Aspect ratio (page 21). Aspect ratio is the ratio of the image width to image height. TV screens are usually 1.33:1, also known as 4:3. HDTV and most DVDs are 1.78:1, or 16:9 (the projector's default).
- Choose the option that best fits your input source in the menus, or press the **Resize** button on the remote to cycle through the options. See page 19.
- Select a specific Color Space. See page 22.
- Select a different Video Standard. Auto tries to determine the standard of the incoming video.

- Select a different standard if necessary. See page 23.
- Make sure your DVD player is set for a 16:9 television. See your DVD player's user's guide for instructions.

Customizing the projector

You can customize the projector for your specific setup and needs.

- For rear projection, turn rear mode on in the **Settings>System** menu.
- For ceiling mounted projection, turn ceiling mode on in the **Settings> System** menu.
- Specify which source the projector checks first for active video during power-up.
- Turn the projector's display messages on and off.
- Turn on power saving features.
- Specify blank screen colors and start up logos.
- Specify the language viewed on the menus.
- Save settings for the active source as a preset.

Using the menus

To open the menus, press the **Menu** button on the keypad or remote. (The menus automatically close after 60 seconds if no buttons are pressed.) The Main menu appears.



Main menu



keypad navigation buttons

navigation

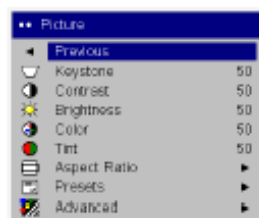
Use the arrow buttons to move up and down to highlight the desired submenu, then press the **Select** button.

To change a menu setting, highlight it, press **Select**, then use the up and down arrow buttons to adjust the value, select an option using radio buttons, or turn the feature on or off using check boxes. Press **Select** to confirm your changes. Use the arrows to navigate to another setting. When your adjustments are complete, navigate to Previous or Exit, then press **Select** to go to the previous menu; press the **Menu** button at any time to close the menus.

Dots appear before the menu name. The number of dots indicate menu levels, ranging from one (the Main menu) to four (the most nested menus).

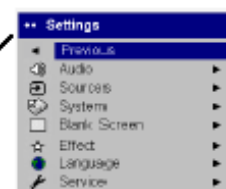
The menus are grouped by usage:

- The Picture menu provides image adjustments.
- The Settings menu provides set-up type adjustments that are not changed often.
- The About menu provides a read-only display of information about the projector and source.



Picture menu

dots



Settings menu

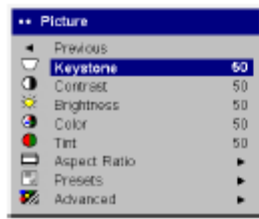
Certain menu items may not be visible or may be grayed depending upon a particular source being connected. For example, Sharpness is only available for video sources and is not visible when a computer source is active. Menu options are grayed out only if the source is selected but no signal is present. For example, if the projector is set to a video source but the source, such as a DVD player, is turned off video menu options are grayed out.



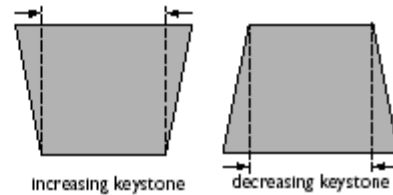
About menu

Picture menu

To adjust the following settings, highlight the setting, press **Select**, use the up and down arrows to adjust the values, then press **Select** to confirm the changes.



Picture menu



Keystone: adjusts the image vertically and makes a squarer image. You can also adjust keystone from the keypad.

Contrast: controls the degree of difference between the lightest and darkest parts of the picture and changes the amount of black and white in the image.

Brightness: changes the intensity of the image.

Color: adjusts a video image from black and white to fully saturated color. The color setting applies to video sources only.

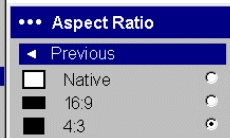
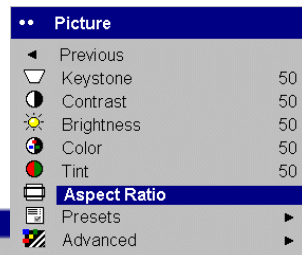
Tint: adjusts the red-green color balance in the image of NTSC video images. The tint setting applies to NTSC video sources only.

Aspect Ratio: Aspect ratio is the ratio of the image width to image height. TV screens are usually 4:3. HDTV and most DVDs are 16:9. The projector's default is 16:9. See "What is Aspect Ratio?" on page 11 for more information.

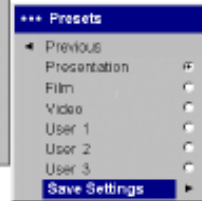
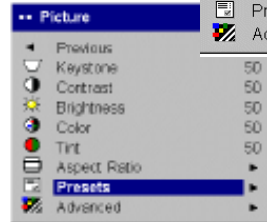
Select Native to see the unmodified input with no resizing by the projector.

Select 16:9 to watch enhanced widescreen DVDs.

For more information regarding Aspect Ratio, see page 11.



Presets: Presets are provided that optimize the projector for displaying computer presentations, photographs, film images, and video images. Film input is material originally captured on a film camera, like a movie; video input is material originally captured on a video camera, like a TV show or sporting event. You can use the preset as a starting point, then further customize the settings for each source. The settings you customize are saved in the preset for each source. To restore the factory default settings, choose Factory Reset in the **Settings>Service** menu (page 24).



Presets



Save User Settings

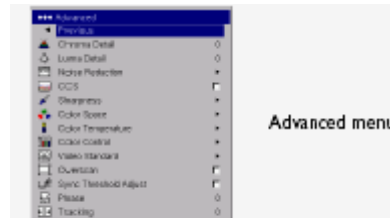
There is also a user-definable preset. To set a preset for the current source, adjust the image, select Save User in the Presets menu, then select Yes. You can recall these settings in the future by selecting the User 1 preset.

Advanced menu

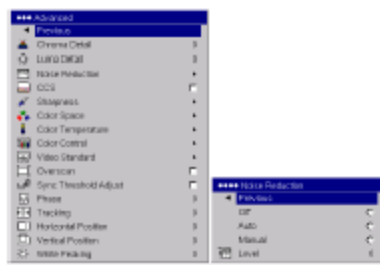
Chroma Detail: This adjusts the color sharpness.

Luma Detail: This adjusts the overall sharpness (edge enhancement) of the Luma signal.

Noise Reduction: adjusts signal noise reduction. Choose Off to have no noise reduction, choose Auto to have the software determine the amount of noise reduction, or choose Manual and adjust the Level.



Advanced menu



Noise Reduction

CCS: (Cross-Color Suppression) processes the signal to remove any color information from the luma portion of the signal. It is On for all composite signals, and can be turned off for S-video and interlaced component signals.

Sharpness: (video sources only) changes the clarity of the edges of a video image. Select a sharpness setting.

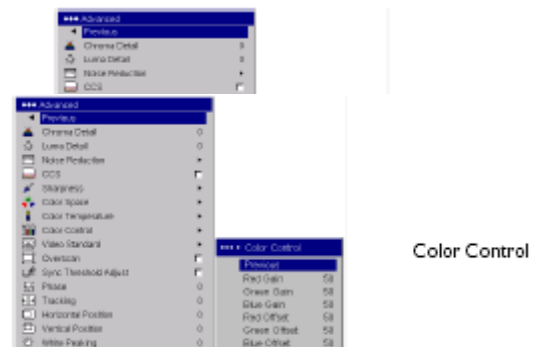


Color Space: This option applies to computer and component video sources. It allows you to select a color space that has been specifically tuned for the input signal. When Auto is selected, the projector automatically determines the standard. To choose a different setting, turn off Auto, then choose RGB for computer sources, choose either REC709 or REC601 for component video sources.



Color Temperature: changes the intensity of the colors. Select a value.

Color Control: allows you to individually adjust the gain (relative warmth of the color) and the offset (the amount of black in the color) of the red, green, and blue colors.



Video Standard: when it is set to Auto, the projector attempts to automatically pick the video standard based on the input signal it receives. (The video standard options may vary depending on your region of the world.) If the projector is unable to detect the correct standard, the colors may not look right or the image may appear "torn." If this happens, manually select a video standard by selecting NTSC, PAL, or SECAM from the Video Standard menu.



Overscan: (video sources only) removes noise around the video image.

Sync Threshold Adjust: If a hardware device, such as a DVD player, is not syncing properly with the projector, select this option to help it to sync when connected to the projector. The following four (4) options are for computer sources only.

Phase: adjusts the horizontal phase of a computer source.

Tracking: adjusts the vertical scan of a computer source.

Horizontal/Vertical Position: adjusts the position of a computer source.

White Peaking: increases the brightness of whites that are near 100 percent.

Settings menu

Audio: allows adjustments to Volume of the internal speaker and allows a chime to play when starting the projector.

Adjustments can also be made from the projector's keypad and the remote.

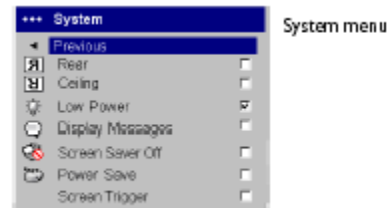


Sources: determines which source the projector checks first for active video during power-up. When **Autosource** is selected, the **Source Enable** feature indicates which sources the projector attempts to lock onto. You can use the Source Enable feature to eliminate certain sources from this search, which will speed the search. The source options are **Computer** for a computer, progressive DVD, or HDTV source, **Video 1** for S-video connections, **Video 2** for component video connections and **Video 3** for composite video sources.

By default, the check boxes for all sources are checked. Uncheck a source box to eliminate it from the search. When Autosource is not checked, the projector defaults to the source selected in **Sources**. To display another source, you must manually select one by pressing the **Computer** or **Video** button on the remote or keypad.



System>Rear: reverses the image so you can project from behind a translucent screen. **Ceiling:** turns the image upside down for ceiling-mounted projection. **Low Power:** toggles between on and Off. Turn it on to lower the light output of the lamp. This also lowers the fan speed, making the projector quieter. **Display Messages:** displays status messages (such as "Searching" or "Mute") in the lower-left corner of the screen. **Screen Saver Off:** prevents the screensaver on your computer from being activated if the USB portion of the M1 is plugged into the computer. This function was previously called NND. **Power Save:** automatically turns the lamp off after no signals are detected for 20 minutes. After 10 additional minutes with no signal, the projector powers down. If an active signal is received before the projector powers down, the image will be displayed. After an additional 10 minutes with no signal, the projector powers down and can be toggled off. If an active signal is received before the projector powers down, the image will be displayed.



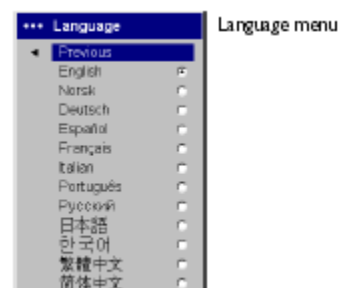
Startup Logo: allows you to display a blank screen instead of the Default screen at startup, and when no source is detected.



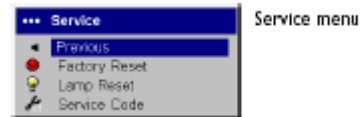
Blank Screen: determines what color is displayed when you press the Blank button on the remote.



Language: allows you to select a language for the onscreen display.



Service: To use these features, highlight them and press **Select**.



Factory Reset: restores all settings to their default.

Lamp Reset: resets the lamp hours used counter in the About menu to zero. Do this only after changing the lamp.

Service Code: only used by authorized service personnel.

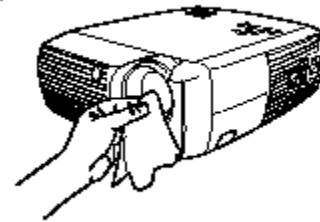
About: provides information about the projector and the active source.



Maintenance

Cleaning the Lens

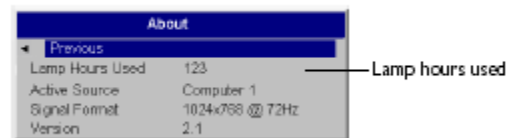
- 1 Apply a non-abrasive camera lens cleaner to a soft, dry cloth.
 - Avoid using an excessive amount of cleaner, and don't apply the cleaner directly to the lens. Abrasive cleaners, solvents or other harsh chemicals might scratch the lens.



- 2 Lightly wipe the cleaning cloth over the lens in a circular motion. Replace the lens cap immediately, if you don't intend to use the projector.

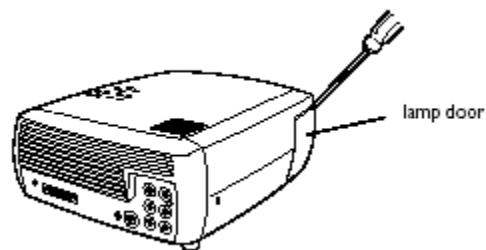
Replacing the Projection Lamp

The lamp hours used timer in the About menu counts the number of hours the lamp has been in use. Twenty hours before the lamp life expires, the message "Change lamp" appears on the screen at startup. If the maximum lamp time is exceeded, the lamp will not light. In this case, after replacing the lamp you must reset the lamp hours by simultaneously pressing both **Volume** buttons on the keypad and holding them for 10 seconds.



NOTE: You can order new lamp housings from your dealer or directly from Knoll. See the *packing list* for information. Use only a replacement lamp with the same type and rating as the original lamp, model SP-LAMP-021 or LP21.

- 1 Turn off the projector and unplug the power cord.
- 2 Wait 30 minutes to allow the projector to cool thoroughly.
- 3 Turn the projector on its side so that the lamp door is facing you. Using a flat-blade screwdriver, gently pry the lamp door from the projector by placing the screwdriver blade into the space between the top of the lamp door and the projector.
- 4 Loosen the two captive screws that attach the lamp housing to the projector.
- 5 Detach the lamp connector from the projector by depressing the locking tab on the connector and lightly pulling it free.



WARNING:

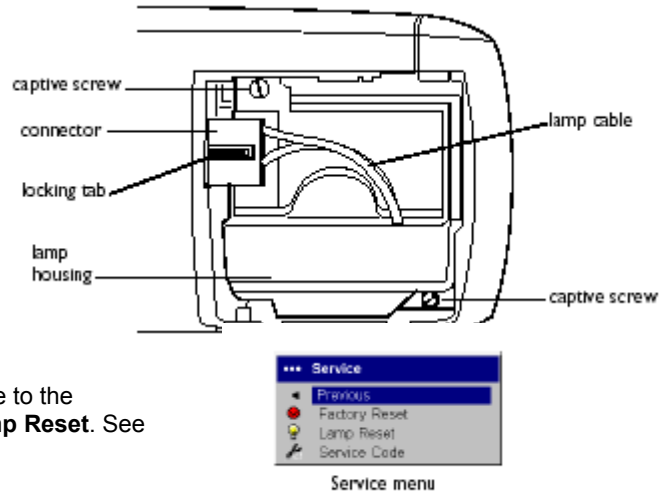
To avoid burns, allow the projector to cool for at least 30 minutes before you replace the lamp.

Do not drop the lamp housing or touch the glass bulb! The glass may shatter and cause injury.

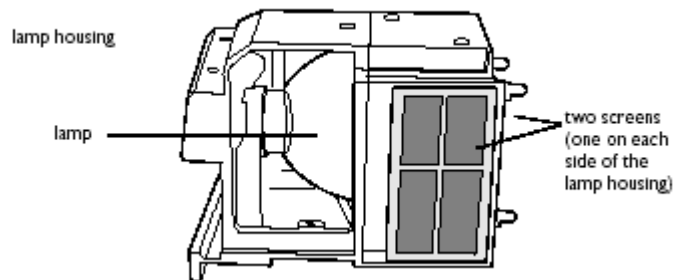
Be extremely careful when removing the lamp housing. In the unlikely event that the bulb ruptures, small glass fragments may be generated. The lamp housing is designed to contain these fragments, but use caution when removing the lamp housing. Before replacing the lamp, clean the lamp compartment and dispose of cleaning materials. Wash hands after lamp replacement. This product has a lamp, which contains a very small amount of mercury. Dispose of it as required by local, state or federal ordinances and regulations. For more information see www.eiae.org.

6 Carefully remove the lamp housing.

Dispose of the lamp in an environmentally proper manner.

7 Install the new lamp housing and tighten the screws.**8** Re-attach the lamp connector to the projector. The locking tab should engage when the connector is fully plugged in.**9** Replace the lamp door.**10** Plug in the power cord and toggle the **Power** switch to turn the projector back on.**11** To reset the lamp hour timer, navigate to the **Settings>Service** menu and select **Lamp Reset**. See page 24 for details.**Cleaning the Lamp Housing Screens**

In dirty or dusty environments, the two dust filter screens in the lamp housing can become clogged, causing high temperatures and premature lamp failure. Routine maintenance to remove dust from the screens lowers the lamp operating temperature and prolongs lamp life. To maximize lamp life, you should clean the screen at least every 250 hours depending upon environmental conditions. The dirtier or dustier the environment, the more often you should clean the screens.

**1** Remove the lamp housing.**2** Examine the dust filter screens on the lamp housing. If necessary, use a vacuum cleaner set on low power to clean the screens. Be careful not to disturb any internal components when cleaning the screens.**3** Replace the lamp housing and lamp door.**Using the security lock**

The projector has a security lock for use with a PC Guardian Cable Lock System. Refer to the information that came with the lock for instructions on how to use it.



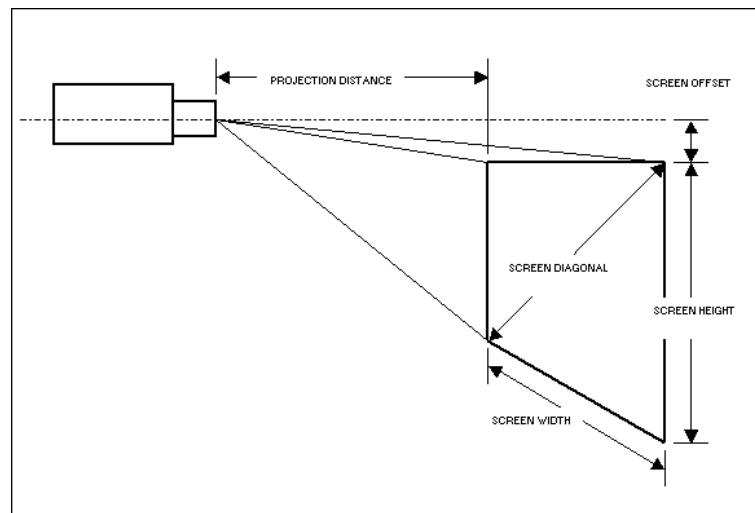
Appendix 1: HD102 Projection Throw Distance (16:9 Aspect Screen)

Screen Diagonal	92"	103"	106"	110"	122.5"	146.75"
Minimum Distance	139.5"	156.1"	160.7"	166.7"	185.7"	222.5"
Maximum Distance	167.2"	187"	192.5"	200"	222.7"	266.8"
Screen offset	7.3"	8.2"	8.4"	8.8"	9.8"	11.7"
Viewing Area	45"x80"	50.5"x89.75"	52"x92"	54"x96"	60"x107"	72"x128"

Maximum distance to screen (16:9) = 1.818 x Screen diagonal size

Minimum distance to screen (16:9) = 1.516 x Screen diagonal size

Screen offset (image drop or rise) = 0.08 x Screen diagonal size



Red LED Behavior and Projector Errors

If the projector is not functioning properly and the LED is blinking red, consult **Table 3** to determine a possible cause. There are two-second pauses between the blinking cycles.

Table 3:

Red LED Behavior	Explanation
One (1) blink	The lamp won't strike after five (5) attempts. Check the lamp and lamp door installations for loose connections.
Two (2) blinks	The lamp counter hours have exceeded lamp life hours. Replace the lamp and reset the lamp hours counter.
Three (3) blinks	The projector has shutdown. Check to see if the lamp door is open. If the lamp door is closed, toggle off the projector and wait one minute, then toggle the projector on again. If the lamp does not strike after one minute, replace the lamp. Contact Technical Support (see page 18) for repair if replacing the lamp does not solve the problem.
Four (4) blinks	The fan has failed. Contact Technical Support (see page 25) for repair or replacing the fan.
Five (5) blinks	The projector is overheating. Check for a blocked air vent. Contact Technical Support (see page 25) for repair if clearing the air vents does not solve this problem.

LIMITED WARRANTY

Knoll Systems, Inc. ("Knoll") warrants that each HD102 ("the Product") sold hereunder will conform to and function in accordance with the written specifications of Knoll. Said limited warranty shall apply only to the first person or entity that purchases the Product for personal or business use and not for the purpose of distribution or resale. Said warranty shall continue for a period of two (2) years from the date of such purchase. The standard limited warranty excludes the lamps in projectors after 90 days or 500 hours and the accessories after one year. Knoll does not warrant that the Product will meet the specific requirements of the first person or entity that purchases the Product for personal or business use. Knoll' liability for the breach of the foregoing limited warranty is limited to the repair or replacement of the Product or refund of the purchase price of the Product, at Knoll' sole option. Replacement Product may be re-furbished in "like-new" condition, at Knoll' sole discretion. To exercise the Purchaser's rights under the foregoing warranty, the Product must be returned at the Purchaser's sole cost and expense, to Knoll or to any authorized Knoll service center provided, and the Product must be accompanied by a written letter explaining the problem and which includes (i) proof of date of purchase; (ii) the dealer's name; and (iii) the model and serial number of the Product. When sending your unit in for repair, please ship your unit in its original packing material or a Knoll approved ATA Shipping Case, or have a professional packaging company pack the unit. Please insure your shipment for its full value. A return authorization number, issued by the Knoll customer service department, must also be clearly displayed on the outside of the shipping carton containing the Product.

Note: Remanufactured Products are exempt from the foregoing Limited Warranty. Please refer to the Remanufactured Product Warranty for applicable warranty information.

WARRANTY LIMITATION AND EXCLUSION

Knoll shall have no further obligation under the foregoing limited warranty if the Product has been damaged due to abuse, misuse, neglect, accident, unusual physical or electrical stress, unauthorized modifications, tampering, alterations, or service other than by Knoll or its authorized agents, causes other than from ordinary use or failure to properly use the Product in the application for which said Product is intended.

DISCLAIMER OF UNSTATED WARRANTIES

THE WARRANTY PRINTED ABOVE IS THE ONLY WARRANTY APPLICABLE TO THIS PURCHASE. ALL OTHER WARRANTIES, EXPRESS OR IMPLIED, INCLUDING, BUT NOT LIMITED TO, THE IMPLIED WARRANTIES OF MERCHANTABILITY AND FITNESS FOR A PARTICULAR PURPOSE ARE DISCLAIMED. THERE ARE NO WARRANTIES THAT EXTEND BEYOND THE FACE HEREOF AND THE FOREGOING WARRANTY SHALL NOT BE EXTENDED, ALTERED OR VARIED EXCEPT BY WRITTEN INSTRUMENT SIGNED BY KNOLL. SOME STATES DO NOT ALLOW LIMITATIONS ON HOW LONG AN IMPLIED WARRANTY MAY LAST, SO SUCH LIMITATIONS MAY NOT APPLY TO YOU.

LIMITATION OF LIABILITY

IT IS UNDERSTOOD AND AGREED THAT KNOLL' LIABILITY WHETHER IN CONTRACT, IN TORT, UNDER ANY WARRANTY, IN NEGLIGENCE OR OTHERWISE SHALL NOT EXCEED THE RETURN OF THE AMOUNT OF THE PURCHASE PRICE PAID BY PURCHASER AND UNDER NO CIRCUMSTANCES SHALL KNOLL BE LIABLE FOR SPECIAL, INDIRECT, INCIDENTAL OR CONSEQUENTIAL DAMAGES OR LOST PROFITS, LOST REVENUES OR LOST SAVINGS. THE PRICE STATED FOR THE PRODUCT IS A CONSIDERATION IN LIMITING KNOLL' LIABILITY. NO ACTION, REGARDLESS OF FORM, ARISING OUT OF THE AGREEMENT TO PURCHASE THE PRODUCT MAY BE BROUGHT BY PURCHASER MORE THAN ONE YEAR AFTER THE CAUSE OF ACTION HAS ACCRUED. SOME STATES DO NOT ALLOW THE EXCLUSION OR LIMITATION OF INCIDENTAL OR CONSEQUENTIAL DAMAGES SO THE ABOVE LIMITATION OR EXCLUSION MAY NOT APPLY TO YOU. THIS LIMITED WARRANTY GIVES YOU SPECIFIC LEGAL RIGHTS, AND YOU MAY ALSO HAVE OTHER RIGHT WHICH VARIES FROM STATE TO STATE.

© Copyright 2004 Knoll Systems. All Rights Reserved.

Knoll Systems
11791 Machrina Way #210
Richmond, BC V7A 4V3
Canada
www.knollsystems.com