

User's Manual – Operating Guide

EDPJ32

Thank you for purchasing this projector.

⚠WARNING ► Before using this product, please read the "User's Manual - Safety Guide" and related manuals to ensure the proper use of this product. After reading them, store them in a safe place for future reference.

NOTE • The information in this manual is subject to change without notice.
• The manufacturer assumes no responsibility for any errors that may appear in this manual.
• The reproduction, transfer or copy of all or any part of this document is not permitted without express written consent.

Trademark acknowledgment

- VGA and XGA are registered trademarks of International Business Machines Corporation.
 - Apple and Mac are registered trademarks of Apple Computer, Inc.
 - VESA and SVGA are trademarks of Video Electronics Standard Association.
 - Windows is a registered trademark of Microsoft Corporation.
- All other trademarks are the properties of their respective owners.

The logo for ProSelecta features the word "ProSelecta" in a stylized, 3D font. "Pro" is blue, "Selecta" is green, and the final "a" is red. The letters have a textured, blocky appearance.

View :: Compare :: Select - www.ProSelecta.com

Content

| | |
|--|-----------|
| Before use | 4 |
| Projector features..... | 4 |
| About this manual..... | 4 |
| About contents of package..... | 5 |
| Part names..... | 6 |
| Projector..... | 6 |
| Control buttons..... | 7 |
| Remote control..... | 7 |
| Preparations | 8 |
| Fastening the lens cover..... | 8 |
| About the filter cover for bottom-up use..... | 9 |
| Arrangement..... | 10 |
| Adjusting the projector's elevator..... | 12 |
| Connecting your devices..... | 13 |
| Example of connection with a VCR/DVD player..... | 13 |
| Example of connection with a computer..... | 14 |
| Example of computer signal..... | 15 |
| Connecting power supply..... | 16 |
| Loading batteries into the remote control..... | 17 |
| Using the remote control..... | 18 |
| Power on/off | 19 |
| Turning on the power..... | 19 |
| Turning off the power..... | 20 |
| Operating | 21 |
| Adjusting the volume..... | 21 |
| Temporarily muting the sound..... | 21 |
| Selecting an input signal..... | 22 |
| Searching an input signal..... | 22 |
| Selecting an aspect ratio..... | 23 |
| Adjusting the zoom (magnifying power)..... | 24 |
| Adjusting the focus..... | 24 |
| Using the automatic adjustment feature..... | 24 |
| Adjusting the position..... | 25 |
| Correcting the keystone distortions..... | 25 |
| Using the partial magnify feature..... | 26 |
| Freezing the screen..... | 26 |
| Temporarily blanking the screen..... | 27 |

| | |
|--|-----------|
| Multifunctional settings | 28 |
| Using the menu function | 28 |
| EASY MENU | 31 |
| Aspect / Zoom / Keystone / Mode / Bright / Contrast / Color / Tint | 31 |
| Sharpness / Whisper / Mirror / Reset / Filter time | 32 |
| Language / Go to advanced menu | 32 |
| PICTURE menu | 33 |
| Bright / Contrast / Gamma | 33 |
| Color temp / Color / Tint / Sharpness | 34 |
| Progressive / My memory | 35 |
| IMAGE menu | 36 |
| Aspect | 36 |
| Over scan / V. position / H. position / H. phase / H. size | 37 |
| Auto adjust execute | 38 |
| INPUT menu | 39 |
| Color space / Video format / Frame lock / Information | 39 |
| SETUP menu | 40 |
| Zoom / Keystone / Whisper / Mirror / Volume | 40 |
| SCREEN menu | 41 |
| Language / Menu position / OSD bright / Blank | 41 |
| Start up / MyScreen | 42 |
| MyScreen lock / Message | 43 |
| OPTION menu | 44 |
| Auto search / Auto off / Lamp time | 44 |
| Filter time / Service | 45 |
| Maintenance | 47 |
| Lamp | 47 |
| Air filter | 50 |
| Inside of the projector | 52 |
| Caring for the lens | 52 |
| Caring for the cabinet and remote control | 52 |
| Troubleshooting | 53 |
| Related messages | 53 |
| Regarding the indicator lamps | 54 |
| Phenomena that may easily be taken as machine defects | 56 |
| Warranty and after-service | 58 |
| Specifications | 58 |
| Dimension diagram | 59 |

Before use

Projector features

This projector is used to project various computer signals as well as NTSC/PAL/SECAM video signals onto a screen. It requires just a little space for installation and gets a large image from short distance.

- High Brightness
Newly developed 165W UHB (Ultra high Brightness) lamp gives you a higher brightness image on a screen. The image can be still kept as bright and clean enough for use in bright rooms.
- Low Noise
WHISPER mode is available for reducing acoustic noise to realize quieter operation. It is perfect for use in low luminance rooms where low noise is more important than brightness.
- Compact Body
Even with its many features, this projector is extremely compact and slim, which gives you more flexibility and usability to use it where you want.

About this manual

Various symbols are used in this manual. The meanings of these symbols are described below.

- ▲ **WARNING** This symbol indicates information that, if ignored, could possibly result in personal injury or even death due to incorrect handling.
- ▲ **CAUTION** This symbol indicates information that, if ignored, could result possibly in personal injury or physical damage due to incorrect handling.







NOTE • To suitably use, please be aware of what is written following this symbol.

 Please refer to the pages written following this symbol.

About contents of package

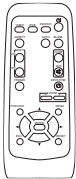
Your projector should come with the items shown below. Check to make sure that all the items are included. Contact immediately your dealer if anything is missing.

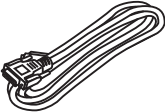
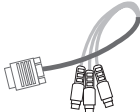
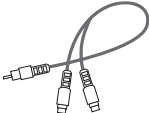
ENGLISH

- (1) Projector with Lens cover..... 
- (2) Strap (for Lens cover) 
- (3) Filter cover (for bottom-up use)..... 
- (4) Remote control..... 
- (5) Two AA batteries (for Remote control) 
- (6) Power cord 
- (7) RGB cable..... 
- (8) Component video adapter (RCA – D-sub) 
- (9) Audio adapter (RCA – Stereo mini)..... 
- (10) User's manuals 

⚠ WARNING ► Do not place the projector on an unstable surface.

NOTE • Keep the original packing materials for future reshipment. For moving the projector, be sure to use the original packing material. Use special caution for the lens part.

Part names

Projector

Vent (10)
Please do not block and cover the vents.

Lens (19, 52)

Lens cover (8, 19)

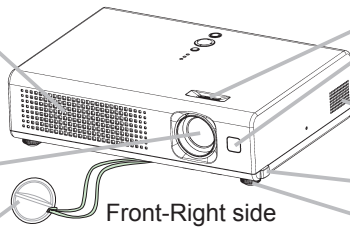

Front-Right side

Focus ring (24)

Remote sensor (18)

Speaker

Elevator button (12)

Elevator foot (12)

Lamp cover (47, 48, 49)
Lamp unit is inside.

A lamp has a finite product life. Preparation of a new lamp and early replacement are recommended.

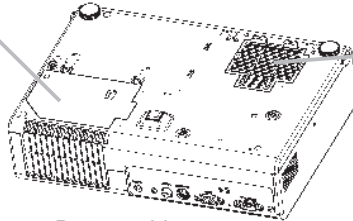

Bottom side

Filter cover (9, 50)

Air filter and intake vent are inside.

Please take care of the air filter to normal ventilate.

Control buttons (7)

Ports
See below.
About connection, please see the section "Connecting your devices". (13, 14)

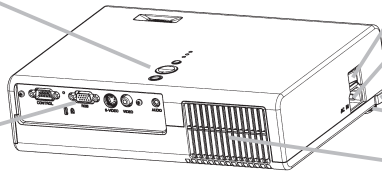

Rear-Left side

Power switch (19, 20)

AC inlet (16)

Elevator button (12)

Elevator foot (12)

Vent (10)
Please do not block and cover the vents.

RGB port (14, 22)

Restart switch (20)

CONTROL port (14)

Kensington lock slot

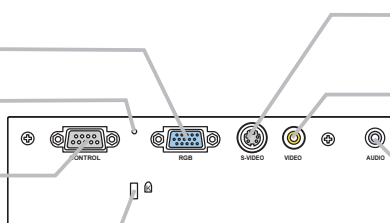

Ports

S-VIDEO port (13, 22)

VIDEO port (13, 22)

AUDIO port (13, 14)

Control buttons

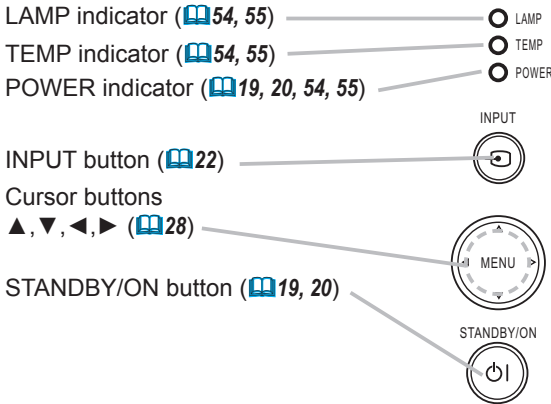

Remote control

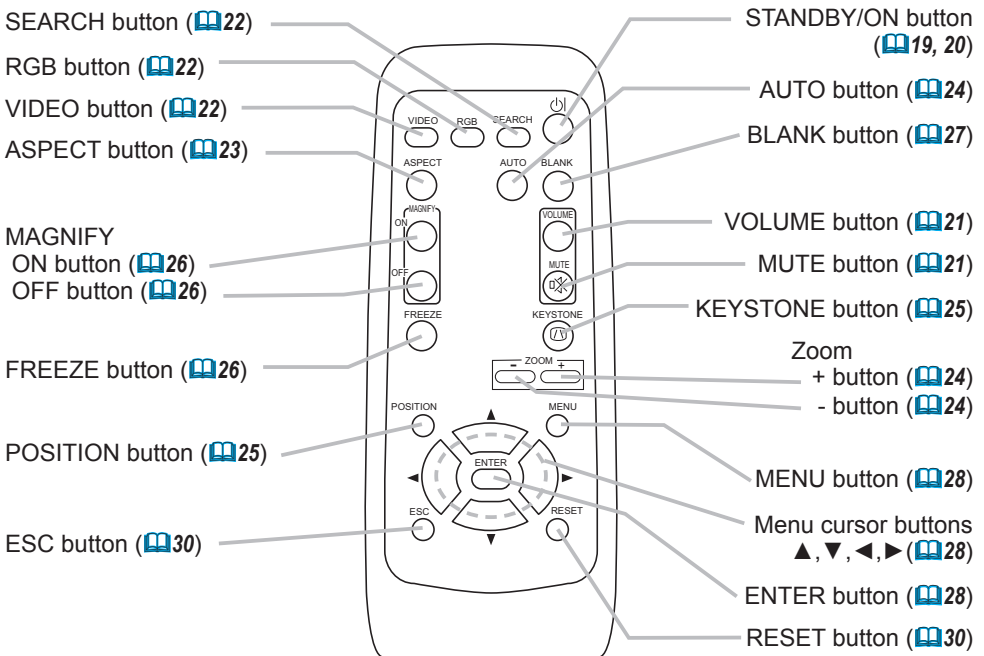

Preparations

Fastening the lens cover

To avoid losing the lens cover, please fasten the projector using the strap.

1. Slowly turn over the projector, so that the bottom is facing up.

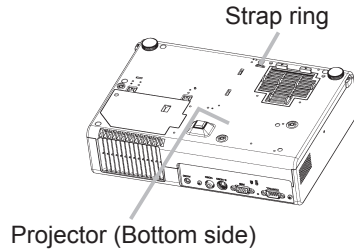

2. Fix the strap to the strap ring of the projector.

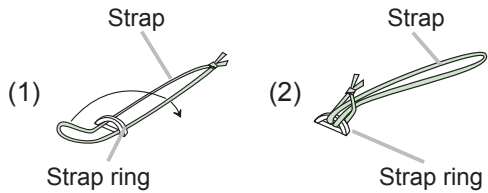

3. Fix the strap to the strap ring of the lens cover.

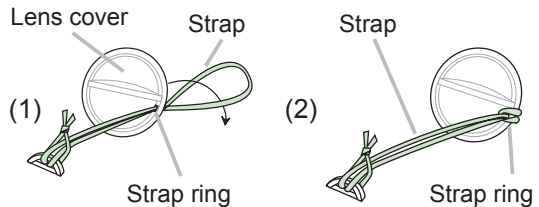

4. Attach the lens cover to the lens of the projector, and slowly turn over the projector, so that the top is facing up.

⚠ WARNING ► Do not fasten the lens cover during use or immediately after use. Handling while the projector is in a high temperature could cause a burn and/or malfunction to the projector.

⚠ CAUTION ► Close the lens cover to prevent the lens surface being scratched when the projector is not used.

About the filter cover bottom-up use

When the projector is installed bottom up, please use the accessory filter cover for bottom-up use. It is higher than usual filter cover, to keep the space for intake ventilation. Please change the filter cover in the following procedure.

1. Disconnect all the connectors and adapters that were connected to the projector's ports.
Then slowly turn the projector so that the lens-side is facing up. While the projector is placed lens-side up, hold the projector.
2. Remove the filter cover. Hold the knobs while pulling out it. If the projector was used before, please clean the air filter referring the section "Air filter". (p.50)
3. Slowly turn the projector so that the bottom is facing up.
4. Set the filter cover for bottom-up use. Interlocking the tabs, snap the filter cover for bottom-up use into place.

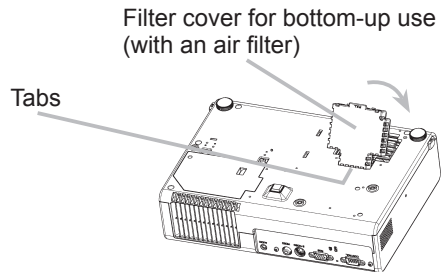
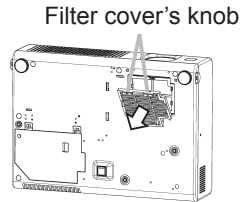

⚠ WARNING ▶ Do not replace the filter cover and/or air filter during use or immediately after use. Handling while the projector is in a high temperature could cause a burn and/or malfunction to the projector.

▶ Do not use the projector with the air filter and the filter cover removed. Do not remove the filter cover and the air filter in a smoky or dusty place. It could result in a fire and/or malfunction to the projector.

⚠ CAUTION ▶ Please be careful for the projector not to fall. While the projector is placed lens-side up, hold the projector.

Arrangement

Please select the arrangement way depending on your use or the environment.

When put on a table

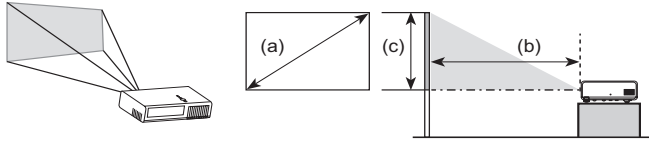

When suspended from the ceiling

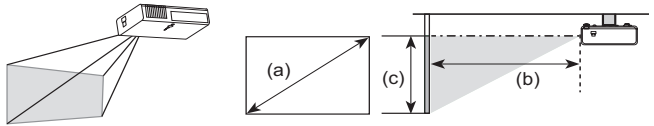

- ⚠ WARNING** ► Place the projector in a stable position horizontally. A fall or a turnover could cause an injury and/or damage to the projector. Then using damaged projector could result in a fire and/or an electric shock.
- Do not place the projector on an unstable, slant or vibrant surface such as a wobbly or inclined stand.
 - Do not place the projector in the side/front/rear-up position, except caring of the sir filter.
 - For the projector installed bottom-up, use the accessory filter cover for bottom-up use. And in the case of a ceiling installation or the like, contact your dealer before installation.
- Place the projection in a cool place, and pay attention enough to ventilation. The high temperature of the projector could cause a fire, a burn and/or malfunction to the projector.
- Do not stop up, block and cover the projector's vents.
 - Keep a space of 30 cm or more between the sides and other objects such as walls.
 - Do not place the projector on a metallic thing or anything weak in heat.
 - Do not place the projector on a carpet, cushion or bedding.
 - Do not place the projector in direct sunlight or near a hot object such as heater.
 - Put nothing about lens and vents of the projector. Put nothing on the projector.
 - Put nothing that is sucked or sticks to the bottom of projector. This projector has some intake vents also on the bottom.
- Do not place the projector on the place that gets wet. Damping the projector or inserting liquid in the projector could cause a fire, an electric shock and/or malfunction to the projector.
- Do not place the projector in a bathroom or the outdoors.
 - Put nothing containing the liquid near the projector.

Refer to the illustrations and tables below to determine the screen size and projection distance.

The values shown in the table are calculated ($\pm 3\%$) for a full size screen: 854x480.

For 16:9 screens

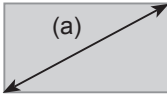

| (a) Screen size | | (b) Projection distance | | (c) Screen height | |
|-----------------|-------|-------------------------|--------|-------------------|--------|
| inch | (m) | m | (inch) | m | (inch) |
| 40 | (1.0) | 1.5 | (57) | 50 | (20) |
| 50 | (1.3) | 1.8 | (72) | 62 | (25) |
| 60 | (1.5) | 2.2 | (87) | 75 | (29) |
| 70 | (1.8) | 2.6 | (101) | 87 | (34) |
| 80 | (2.0) | 2.9 | (116) | 100 | (39) |
| 90 | (2.3) | 3.3 | (130) | 112 | (44) |
| 100 | (2.5) | 3.7 | (145) | 125 | (49) |
| 120 | (3.0) | 4.4 | (174) | 149 | (59) |
| 150 | (3.8) | 5.5 | (218) | 187 | (74) |
| 200 | (5.1) | 7.4 | (291) | 249 | (98) |

For 4:3 screens

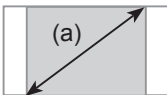

| (a) Screen size | | (b) Projection distance | | (c) Screen height | |
|-----------------|-------|-------------------------|--------|-------------------|--------|
| inch | (m) | m | (inch) | m | (inch) |
| 40 | (1.0) | 1.8 | (70) | 61 | (24) |
| 50 | (1.3) | 2.2 | (88) | 76 | (30) |
| 60 | (1.5) | 2.7 | (106) | 91 | (36) |
| 70 | (1.8) | 3.2 | (124) | 107 | (42) |
| 80 | (2.0) | 3.6 | (142) | 122 | (48) |
| 90 | (2.3) | 4.1 | (160) | 137 | (54) |
| 100 | (2.5) | 4.5 | (178) | 152 | (60) |
| 120 | (3.0) | 5.4 | (214) | 183 | (72) |
| 150 | (3.8) | 6.8 | (267) | 229 | (90) |
| 200 | (5.1) | 9.1 | (357) | 305 | (120) |

⚠ CAUTION ▶ Avoid a smoky, humid or dusty place. Placing the projector in such place could cause a fire, an electric shock and/or malfunction to the projector.

- Do not place the projector near a humidifier, a smoking space or a kitchen.
- ▶ Adjust the direction of the projector to keep the light from directly hitting the projector's remote sensor.

Adjusting the projector's elevator

You can use the elevator feet to make adjustments if the surface on which you need to set the projector is uneven or if you otherwise need to adjust the angle of projection. The adjustment range of the elevator feet is 0 to 9 degrees.

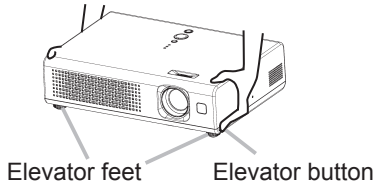

1. Press and hold in the elevator buttons while holding the projector. The elevator buttons and the elevator feet are on the both sides.
2. Raise or lower the projector to the desired height and release the elevator buttons. When you release the elevator buttons, the elevator feet will lock into position.
3. If necessary, you can also finely adjust the height of the projector by twisting the elevator feet by hand.

⚠ WARNING ► Do not adjust the projector's elevator during use or immediately after use. Handling while the projector is in a high temperature could cause a burn and/or malfunction to the projector. Before operating, make sure that the power switch is off, that the power cord is not plugged in, and that the projector is cool adequately.

⚠ CAUTION ► If you press the elevator button without holding the projector, the projector might crash down, overturn, smash your fingers and possibly result in malfunction. To prevent damaging the projector and injuring yourself, always hold the projector whenever using the elevator buttons to adjust the elevator feet.

► Do not incline the projector rightward or leftward. Also do not incline it backward or forward exceeding 9 degrees. Exceeding these range could cause malfunction, and could shorten the lifetime of the consumables.

► Except for inclining by the elevator feet adjustment, place the projector horizontally.

Connecting your devices

Examples of connection with a VCR/DVD player

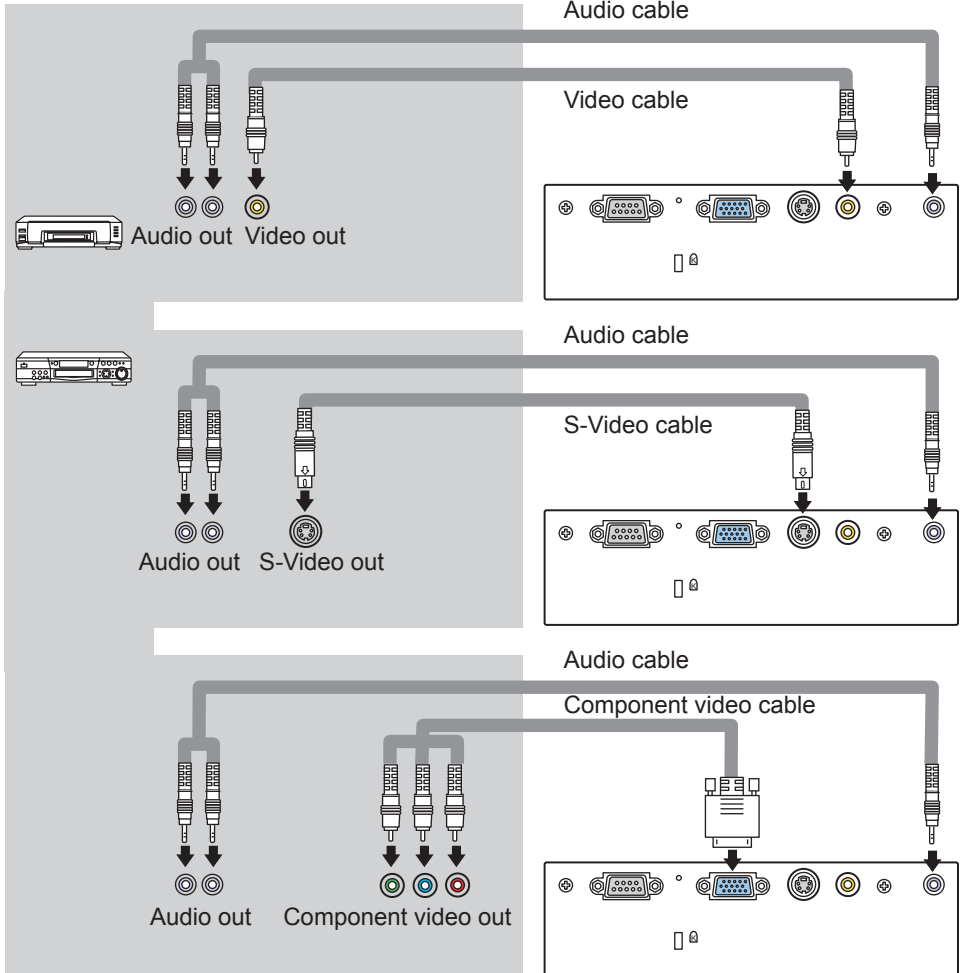

NOTE • Secure the screws on the connectors and tighten.

• For an audio cable with 2 RCA connectors to 2 RCA connectors, use the accessory audio adapter.

• For a component video cable with 3 RCA connectors to 3 RCA connectors, use the accessory component video adapter.

Examples of connection with a computer

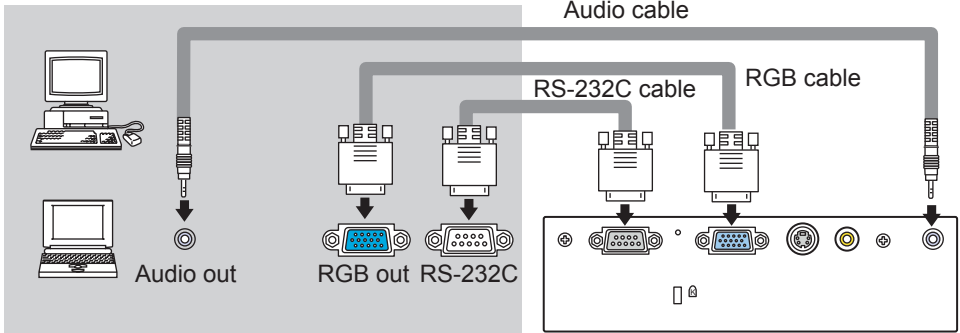

CAUTION ▶ Turn off all devices prior to connecting them to the projector. Attempting to connect a live device to the projector may generate extremely loud noises or other abnormalities that may result in malfunction and/or damage to the device and/or projector.

- ▶ Use the accessory cable or a designated-type cable for the connection. Some cables have to be used with core set. A too long cable may cause a certain picture degradation. Please consult with your dealer for details. For cables that have a core only at one end, connect the core to the projector.
- ▶ Make sure that you connect devices to the correct port. Incorrect connection may result in malfunction and/or damage to the device and/or projector.

NOTE • Whenever attempting to connect a laptop computer to the projector, be sure to activate the laptop's RGB external image output (set the laptop to CRT display or to simultaneous LCD and CRT display). For details on how this is done, please refer to the instruction manual of the corresponding laptop computer.

- Be sure to check jack type, signal level, timing and resolution before connecting this projector to a computer.
- Secure the screws on the connectors and tighten.
- Some computers may have multiple display screen modes. Use of some of these modes will not be possible with this projector.
- The image may not be displayed correctly when the input sync signal is a composite sync or a sync on G.
- For some RGB signal modes, the optional Mac adapter is necessary.
- Automatically adjustment may not function correctly with some input signals.
- When the image resolution is changed on a computer, depending on an input, automatic adjustment function may take some time and may not be completed. In this case, you may not be able to see a check box to select "Yes/No" for the new resolution on Windows. Then the resolution will go back to the original. It might be recommended to use other CRT or LCD monitors to change the resolution.

Example of computer signal

| Resolution (H x V) | H. frequency (kHz) | V. frequency (Hz) | Rating | Signal mode |
|--------------------|--------------------|-------------------|--------|--------------|
| 720 x 400 | 37.9 | 85.0 | VESA | TEXT |
| 640 x 480 | 31.5 | 59.9 | VESA | VGA (60Hz) |
| 640 x 480 | 37.9 | 72.8 | VESA | VGA (72Hz) |
| 640 x 480 | 37.5 | 75.0 | VESA | VGA (75Hz) |
| 640 x 480 | 43.3 | 85.0 | VESA | VGA (85Hz) |
| 848 x 480 | 31.0 | 60.0 | VESA | - |
| 800 x 600 | 35.2 | 56.3 | VESA | SVGA (56Hz) |
| 800 x 600 | 37.9 | 60.3 | VESA | SVGA (60Hz) |
| 800 x 600 | 48.1 | 72.2 | VESA | SVGA (72Hz) |
| 800 x 600 | 46.9 | 75.0 | VESA | SVGA (75Hz) |
| 800 x 600 | 53.7 | 85.1 | VESA | SVGA (85Hz) |
| 832 x 624 | 49.7 | 74.6 | - | Mac 16" mode |
| 1024 x 768 | 48.4 | 60.0 | VESA | XGA (60Hz) |
| 1024 x 768 | 56.5 | 70.1 | VESA | XGA (70Hz) |
| 1024 x 768 | 60.0 | 75.0 | VESA | XGA (75Hz) |
| 1024 x 768 | 68.7 | 85.0 | VESA | XGA (85Hz) |

NOTE • Depending on the input signal, full-size display may not be possible in some cases. Refer to the number of display pixels above.

- Although the projector can display signals with resolution up to XGA (1024x768), the signal will be converted to the projector's panel resolution before being displayed. The best display performance will be achieved if the resolutions of the input signal and projector panel are identical.

About Plug-and-Play capability

Plug-and-Play is a system composed of a computer, its operating system and peripheral equipment (i.e. display devices). This projector is compatible with VESA DDC 2B. Plug-and-Play can be achieved by connecting this projector to computer that is VESA DDC (display data channel) compatible.

- Please take advantage of this function by connecting the accessory RGB cable to the RGB port (DDC 2B compatible). Plug-and-Play may not work properly if any other type of connection is attempted.
- Please use the standard drivers in your computer as this projector is a Plug-and-Play monitor.

Connecting power supply

Before connecting, make sure that the power switch is the OFF position (pressed the side marked "O").



1. Connect the connector of the power cord to the AC inlet of the projector.

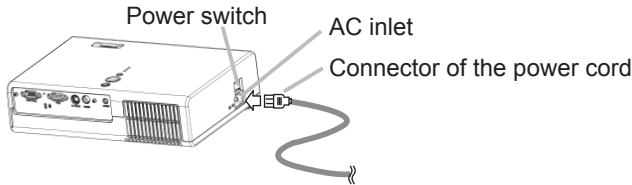

2. Firmly plug the power cord's plug into the outlet.

⚠ WARNING ► Please use extra caution when connecting the power cord as incorrect or faulty connections may result in fire and/or electrical shock.

- Only use the power cord that came with the projector. If it is damaged, contact your dealer to newly get correct one.
- Only plug the power cord into an outlet rated for use with the power cord's specified voltage range.
- Never modify the power cord. Never attempt to defeat the ground connection of the three-pronged plug.
- The power outlet should be close to the projector and easily accessible.
- Do not touch the power cord with a wet hand.
- Check that the connecting portion of the power cord is clean (with no dust) before using. Use a soft and dry cloth to clean the power plug.
- Insert the power plug into a power outlet firmly. Avoid using a loose, unsound outlet or contact failure.

Loading batteries into the remote control

To use the remote control, please load the batteries. Whenever the remote control starts to malfunction, replace the batteries. If you will not use the remote control for an extended period, remove the batteries from the remote control and store them in a safe place.

1. Remove the battery cover. Slide back and remove the battery cover in the direction of the arrow.
2. Take old batteries out and/or put new batteries in. When putting in batteries, align and insert the two AA batteries according to their plus and minus terminals as indicated in the remote control.
3. Close the battery cover. Replace the battery cover in the direction of the arrow and snap it back into place.

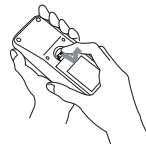
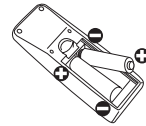
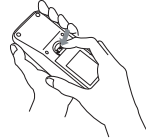

- ⚠ WARNING** ► Always handle the batteries with care and use them only as directed. Improper use may result in battery explosion, cracking or leakage, which could result in fire, injury and/or pollution of the surrounding environment.
- Be sure to use only the batteries specified. Do not use batteries of different types at the same time. Do not mix a new battery with used one.
 - Make sure the plus and minus terminals are correctly aligned when loading a battery.
 - Keep a battery away from children and pets.
 - Do not recharge, short circuit, solder or disassemble a battery.
 - Do not allow a battery in a fire or water. Keep batteries in a dark, cool and dry place.
 - Do not give the battery a physical impact.
 - If you observe a leakage of a battery, wipe out the liquid and then replace a battery. If the liquid adheres to your body or clothes, rinse well with water immediately.
 - Obey the local laws on disposing a battery.

Using the remote control

The remote control works with the projector's remote sensor.

- The range of the remote sensor is 3 meters with a 60-degree range (30-degrees to the left and right of the remote sensor).
- Also a remote signal reflected in the screen etc. may be available. If it is difficult to send a remote signal to the sensor directly, please try to use reflected signal.
- Since the remote control uses infrared light to send signals to the projector (Class1 LED), be sure to use the remote control in an area free from obstacles that could block the remote control's output signal to the projector.

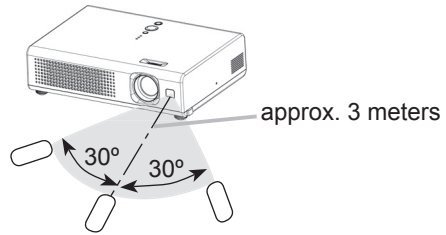

⚠ CAUTION ► Be careful in handling the remote control. Incorrect handling could cause damage or malfunction.

- Do not drop or expose the remote control to physical impact.
- Do not get the remote control wet or place it on wet objects.
- Remove the batteries from the remote control and store them in a safe place if you will not be using the remote control for an extended period.

NOTE • Replace the batteries whenever the remote control starts malfunctioning.

- When strong lights (such as direct sunlight) or light from an extremely close range (such as from an inverter fluorescent lamp) hit the projector's remote sensor, the remote control may not function correctly. Adjust the direction of the projector to keep the light from directly hitting the projector's remote sensor.

Power on/off

Turning on the power

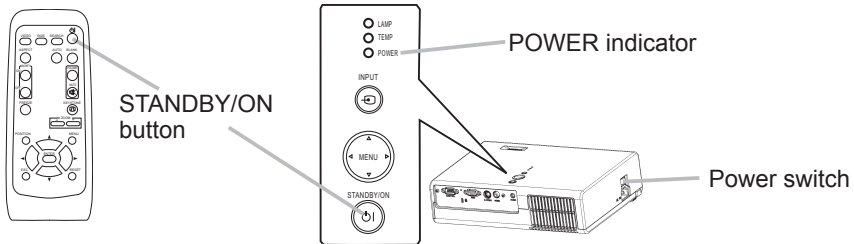

1. Make sure that the power cord is firmly and correctly connected to the projector and the outlet.
2. Open the lens cover, and set the power switch to the ON position.
The power indicator will light up in steady orange. Then wait several seconds because buttons may not function for these several seconds.
3. Press the STANDBY/ON button on the projector or the remote control.
The projector lamp will light up and the POWER indicator will begin blinking in green. When the power is completely on, the indicator will stop blinking and light in green.

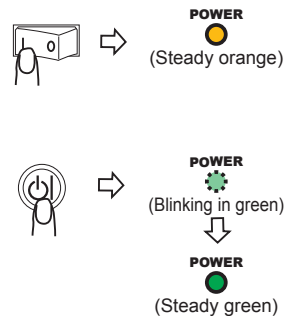

To display the picture, select an input signal according to the section "Selecting an input signal" (22).

⚠ WARNING ► When the power is on, a strong light is emitted. Do not look into the lens and openings of the projector.

NOTE • Turn the power on in right order. Please power on the projector prior to the connected devices.

Turning off the power

1. Press the STANDBY/ON button on the projector or the remote control.

The message "Power off?" will appear on the screen for approximately 5 seconds.



2. Press the STANDBY/ON button on the projector or the remote control again while the message appears.

The projector lamp will go off, and the POWER indicator will begin blinking in orange. Then the POWER indicator will stop blinking and light in steady orange when the lamp cooling is complete.

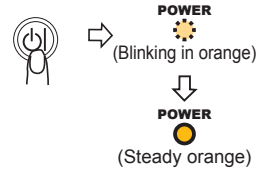

3. Make sure that the power indicator lights in steady orange, and set the power switch to the OFF position. The POWER indicator will go off. Do not set the power switch to the OFF position while the POWER indicator is green or blinking.



4. Close the lens cover. For safety purposes, disconnect the power cord if the projector is not to be used for prolonged periods of time.

- NOTE**
- Turn the power off in right order. First power off the connected devices and then the projector.
 - Except for an emergency, whenever you turn the projector off, obey the procedure of the following "Turning off the power", and do not disconnect the power cord until the procedure is completed. Neglect causes a damage of the electrode and un-lighting of the lamp.
 - This projector is controlled by an internal microprocessor. Under certain exceptional circumstances, the projector may not operate correctly even for turning off the power. In such a case, please push the restart switch () by using a pin or similar. After making sure that the power indicator lights to solid orange, set the power switch to the OFF position. Only push the restart switch in these exceptional instances.
 - When a power supply is shut off with a power failure or the restart switch, before turning on again, make the projector cool down at least 10 minutes without operating.

Operating

Adjusting the volume

1. Press the VOLUME button on the remote control. A dialog will appear on the screen to aid you in adjusting the volume.
2. Use the cursor buttons ▲/▼ to adjust the volume. To close the dialog and complete the operation, press the VOLUME button again. Even if you do not do anything, the dialog will automatically disappear after a few seconds.

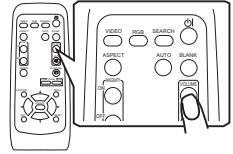

ENGLISH

Temporarily muting the sound

1. Press the MUTE button on the remote control. A dialog will appear on the screen indicating that you have muted the sound. To restore the sound, press the MUTE button or VOLUME button. Even if you do not do anything, the dialog will automatically disappear after a few seconds.

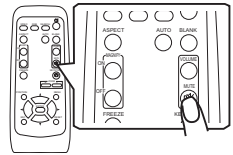

Selecting an input signal

1. Press the INPUT button on the projector.
 - Each time you press the button, the projector switches its input port as below.

RGB → S-VIDEO → VIDEO

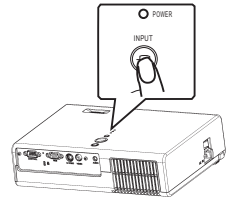

1. Press the RGB button on the remote control to select the RGB port.

RGB

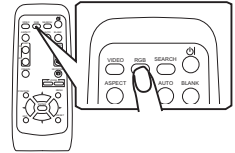

1. Press the VIDEO button on the remote control to select an input port for the video signal.
 - Each time you press the button, the projector switches its video input port as below.

S-VIDEO → VIDEO

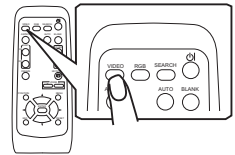

- When the TURN ON is selected to the AUTO SEARCH item in the OPTION menu (44), the projector selects the S-VIDEO port first. If no input is detected at the S-VIDEO port, the projector will check the VIDEO port automatically.

Searching an input signal

1. Press the SEARCH button on the remote control.
 - The projector will begin to check its input ports in order to find any input signals.
 - Then when an input is found, the projector will stop searching and display the image.
 - If no signal is found, the projector will return to the state selected before the operation.

RGB → S-VIDEO → VIDEO

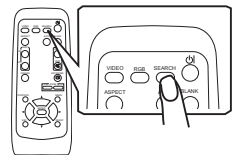

Selecting an aspect ratio

- 1 Press the ASPECT button on the remote control. Each time you press the button, the projector switches the modes for aspect ratio in turn.

For a 16:9 signal

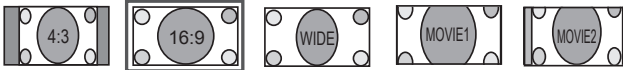

For a 4:3 signal

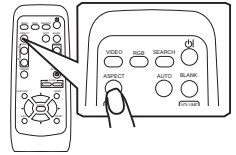
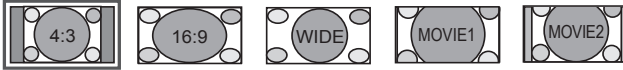

○ For an RGB signal

NORMAL → 4:3 → 16:9



○ For a video signal, s-video signal or component video signal

4:3 → 16:9 → WIDE → MOVIE1 → MOVIE2



○ For no signal

4:3 → 16:9



- The NORMAL mode keeps the original aspect ratio of the signal.
- For an HDTV component video signal of 1125i (1080i) or 750p (720p), only 16:9 mode can be selected.
- Performing the automatic adjustment initializes the aspect ratio setting.
- While setting the WIDE mode, the correction of keystone distortion is not effective. ([25](#), [40](#))
- Setting the WIDE mode may limit the magnify range. ([26](#))

Adjusting the zoom (magnifying power)

1. Press the ZOOM +/- button on the remote control.
A dialog will appear on the screen to aid you in adjusting the zoom.
2. Use the ZOOM buttons +/- to adjust the zoom.
To close the dialog and complete this operation, do not perform operation for a few seconds.

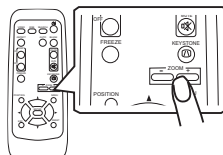

Adjusting the focus

1. Use the focus ring to focus on the picture.

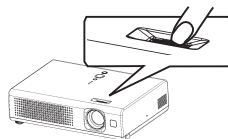

Using the automatic adjustment feature

1. Press the AUTO button on the remote control.
 - **For an RGB signal**
The vertical position, the horizontal position, the clock phase and the horizontal size will be automatically adjusted. And the aspect ratio will be automatically selected.
Make sure that the application window is set to its maximum size prior to attempting to use this feature. A dark picture may still be incorrectly adjusted. Use a bright picture when adjusting.
 - **For a video signal or s-video signal**
The video format best suited for the respective input signal will be automatically selected. This function is available only when the AUTO mode is selected to the VIDEO FORMAT item in the INPUT menu ([p.39](#)).
And the aspect ratio will be selected automatically.
 - **For a video signal, s-video signal or component video signal**
The vertical position and horizontal position will be automatically adjusted.
 - **For a component video signal**
The aspect ratio will be automatically selected.
The clock phase will be automatically adjusted.
- The automatic adjustment operation requires approximately 10 seconds. Also please note that it may not function correctly with some input.

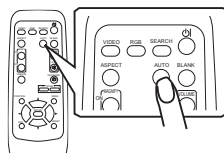

Adjusting the position

1. Press the POSITION button on the remote control.
The "POSITION" indication will appear on the screen.
2. Use the cursor buttons ▲/▼/◀/▶ to adjust the picture position.

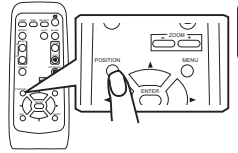

When you want to reset the operation, press the RESET button on the remote control during the operation. To complete this operation, press the POSITION button again. Even if you do not do anything, the dialog will automatically disappear after a few seconds.

- When this function is performed for a video signal, a certain extra such as a line may appear outside a picture.

Correcting the keystone distortions

1. Press the KEYSTONE button on the remote control.
A dialog will appear on the screen to aid you in correcting the distortion.
2. Use the cursor buttons ▲/▼ to correct the distortion.
To close the dialog and complete this operation, press the KEYSTONE button again. Even if you don't do anything, the dialog will automatically disappear after a few seconds.

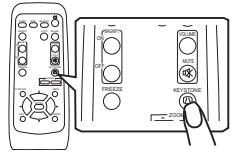

- The adjustable range for correction will vary among inputs. For some signals, this function may not work well.
- While setting the WIDE mode for aspect ratio, the correction of keystone distortion is not effective. (📖 23, 36)

Using the partial magnify feature

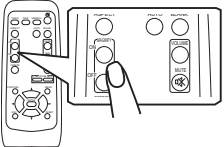
1. Press the ON button of MAGNIFY on the remote control. The “MAGNIFY” indication will appear on the screen (although the indication will disappear after several seconds with no operation), and the projector will enter the MAGNIFY mode.
 
2. Use the cursor buttons ▲/▼ to adjust the zoom level. To move the zoom area, press the POSITION button in the MAGNIFY mode, then use the cursor buttons ▲/▼/◀/▶. And to finalize the zoom area, press the POSITION button again. To exit the MAGNIFY mode and restore the screen to normal, press the OFF button of MAGNIFY on the remote control.
 - The projector automatically exits the MAGNIFY mode when the input signal is changed, or when the display condition is changed (automatic adjustment, etc. is executed.)
 - Although the keystone distortion condition may vary in the MAGNIFY mode, it will be restored when the projector exits the MAGNIFY mode.
 - Setting the WIDE mode may limit the magnify range. (📖23, 36)

Freezing the screen

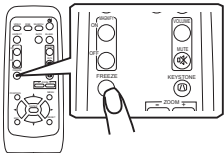
1. Press the FREEZE button on the remote control. The “FREEZE” indication will appear on the screen, and the projector will enter the FREEZE mode. To exit the FREEZE mode and restore the screen to normal, press the FREEZE button again.
 
- The projector automatically exits the FREEZE mode when the input signal is changed, or when one of the projector's buttons or the remote control buttons of STANDBY/ON, SEARCH, RGB, VIDEO, BLANK, AUTO, ASPECT, VOLUME, MUTE, KEYSTONE, POSITION and MENU is pressed.
- If the projector continues projecting a still image for long time, the LCD panel might possibly be printed. Do not leave the projector in the FREEZE mode for too long.

Temporarily blanking the screen

1. Press the BLANK button on the remote control. The blank screen will be displayed instead of the screen of input signal. Please refer to BLANK item in the SCREEN menu. (P.41)

To exit the blank screen and return to the input signal screen, press the BLANK button again.

- The projector automatically returns to the input signal screen when the input signal is changed, or when one of the projector's buttons or the remote control buttons are pressed.

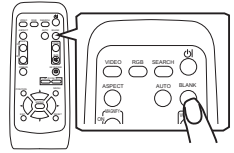

Multifunctional settings

Using the menu function

This projector has the following menus: PICTURE, IMAGE, INPUT, SETUP, SCREEN, OPTION and EASY MENU. Each of these menus is operated using the same methods. The basic operations of these menus are as follows.

NOTE • Regardless of description of this manual, these functions may not work correctly with some input.

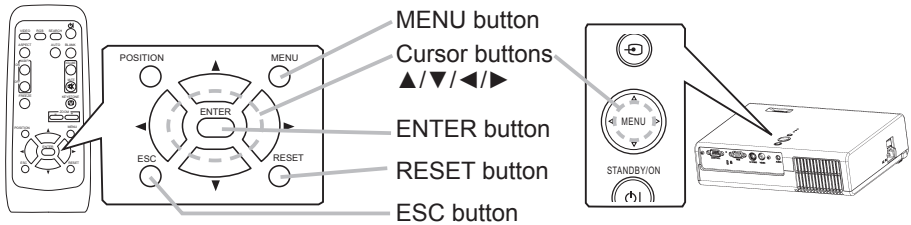

1. To display a menu

- Press the MENU button on the remote control or one of the cursor buttons ▲/▼/◀/▶ on the projector. The Advanced MENU or EASY MENU will appear.

2. To choose the target menu

- Point at one of choices on the menu using the cursor buttons ▲/▼, then press the cursor button ▶ or the ENTER button. In the Advance menu, when some menu is chosen already and you want to choose other menu, please return to the main menu beforehand, using the cursor button ◀ or the ESC button before choosing the menu.

(1) EASY MENU → Advanced MENU

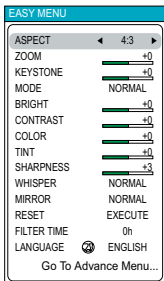

EASY MENU

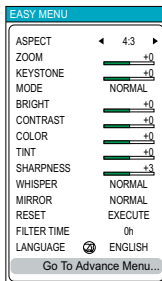

EASY MENU

▶ / ENTER



Advanced MENU
(EASY MENU is pointed at.)

(ASPECT is pointed at.) ("Go to Advanced Menu..." is pointed at.)

(2) Advanced MENU → One of Advanced menus (ex. SETUP menu)

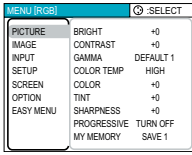

Advanced MENU
(PICTURE is pointed at.)

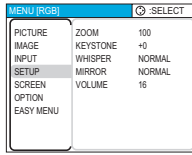

Advanced MENU
(SETUP is pointed at.)

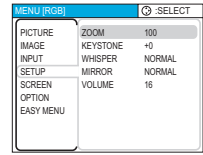

SETUP menu
(ZOOM is pointed at.)

(3) Advanced MENU → EASY MENU

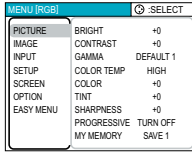

Advanced MENU
(PICTURE is pointed at.)



Advanced MENU
(EASY MENU is pointed at.)

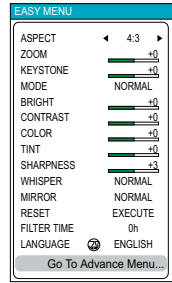

EASY MENU

3. To choose the target item

Point at one of choices on the menu using the cursor buttons▲/▼. In an Advanced menu, then press the cursor button ► or the ENTER button.

(1) In the EASY MENU (ex. KEYSTONE)

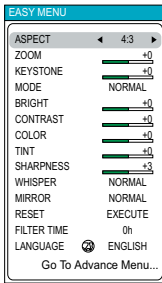

EASY MENU
(ASPECT is chosen.)

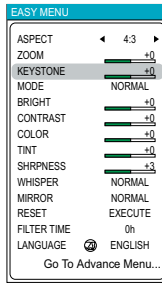

EASY MENU
(KEYSTONE is chosen.)

(2) In an Advanced menu (ex. KEYSTONE)

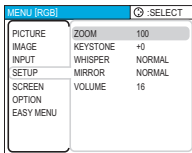

SETUP MENU
(ZOOM is pointed at.)

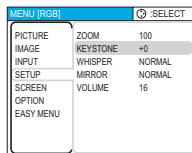

SETUP MENU
(KEYSTONE is pointed at.)

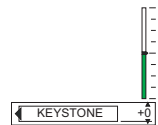

Dialog for KEYSTONE

4. To operate

- (1) Please follow of the mention concerned in each. In general,
 - (1) In the EASY MENU, use the cursor buttons ◀/▶ to operate.
 - (2) In the Advanced MENU, use the cursor buttons ▲/▼.

5. To return to the previous menu

- Press the cursor button ◀ or the ESC button.
 - (1) One of Advanced Menus (ex. SETUP menu) → Advanced MENU

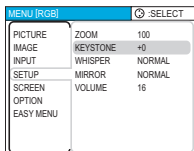

SETUP MENU
(KEYSTONE is pointed at.)

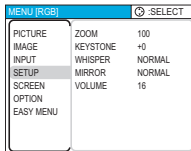

Advanced MENU
(SETUP is pointed at.)

- (2) Dialogs for operation (ex. KEYSTONE) → Advanced MENU

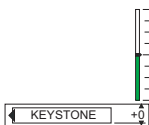

Dialog for KEYSTONE

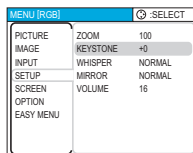

SETUP MENU
(KEYSTONE is pointed at.)

6. To reset

- (1) Each item:
 - Press the RESET button while operating.
- (2) Items of EASY MENU (at a time):
 - Point at “RESET” on the menu using the cursor buttons ▲/▼, then press the cursor button ▶ or the ENTER button. The dialog for reset will appear. Point at “RESET” on the dialog using the cursor button ▲.
- (3) Items of an Advanced MENU:
 - Press the RESET button while pointing the menu name. The dialog for reset will appear. Point at “RESET” on the dialog using the cursor button ▲.



Note that items whose functions are performed simultaneously with operation (LANGUAGE, H PHASE, VOLUME etc.) cannot reset.

7. To close the menu

- Press the MENU button again. Even if you do not do anything, the operation will complete and the menu will disappear automatically after about 10 seconds.

EASY MENU

With the EASY MENU, the items shown in the table below can be performed.

Choose an item using the cursor buttons ▲/▼ on the projector or remote control. Then perform it referring to the following table.

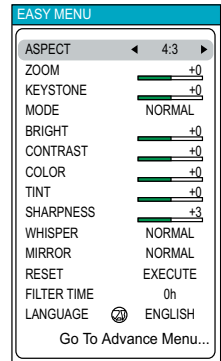

| Item | Description |
|-----------------|---|
| ASPECT | Using the buttons ◀/▶ switches the mode for aspect ratio. See the ASPECT item in the IMAGE menu. (📖36) |
| ZOOM | Using the buttons ◀/▶ adjusts the zoom. See the ZOOM item in the SETUP menu. (📖40) |
| KEystone | Using the buttons ◀/▶ corrects the keystone distortion. See the KEystone item in the SETUP menu. (📖40) |
| MODE | Using the buttons ◀/▶ switches the mode of picture type. The modes of picture type are combinations of a mode of GAMMA (📖33) and a mode of COLOR TEMP. (📖34) Choose a suitable mode according to the projected source. NORMAL ⇄ CINEMA ⇄ DYNAMIC ↑—————↑ NORMAL: (COLOR TEMP = MIDDLE) + (GAMMA = #1 DEFAULT) CINEMA: (COLOR TEMP = LOW) + (GAMMA = #2 DEFAULT) DYNAMIC: (COLOR TEMP = HIGH) + (GAMMA = #3 DEFAULT) • When the combination of GAMMA and COLOR TEMP differs from pre-assigned modes above, the display on the menu for the MODE is “CUSTOM”. |
| BRIGHT | Using the buttons ◀/▶ adjusts the brightness. See the BRIGHT item in the PICTURE menu. (📖33) |
| CONTRAST | Using the buttons ◀/▶ adjusts the contrast. See the CONTRAST item in the PICTURE menu. (📖33) |
| COLOR | Using the buttons ◀/▶ adjusts the strength of whole color. See the COLOR item in the PICTURE menu. (📖34) • This item can be chosen only for a video signal. |
| TINT | Using the buttons ◀/▶ adjusts the tint. See the TINT item in the PICTURE menu. (📖34) • This item can be chosen only for a video signal. |

EASY MENU (continued)

| Item | Description |
|----------------------------|---|
| SHARPNESS | Using the buttons ◀/▶ adjusts the sharpness. See the SHARPNESS item in the PICTURE menu. (📖34) |
| WHISPER | Using the buttons ◀/▶ turns off/on the whisper mode. See the WHISPER item in the SETUP menu. (📖40) |
| MIRROR | Using the buttons ◀/▶ switches the mode for mirror status. See the MIRROR item in the SETUP menu. (📖40) |
| RESET | Performing this item resets all of the items of EASY MENU except FILTER TIME and LANGUAGE. Pressing the button ▶ displays a dialog for confirmation. To perform reset, point at RESET using the button ▲. (📖30) |
| FILTER TIME | Performing this item resets the filter timer which counts usage time of the air filter. See the FILTER TIME item in the OPTION menu. (📖45) |
| LANGUAGE | Using the buttons ◀/▶ switches the language of menu. See the LANGUAGE item in the SCREEN menu. (📖41) |
| Go To Advanced Menu | Pointing at the “Go To Advanced Menu” and pressing the button ▶ changes the EASY MENU into the Advanced MENU. (📖28) Perform to use the menu of PICTURE, IMAGE, INPUT, SETUP, SCREEN or OPTION. |

PICTURE menu (continued)

| Item | Description |
|--------------------------|--|
| <p>COLOR TEMP</p> | <p>Using the buttons ▲/▼ switches the mode of color temperature.</p> <p>HIGH ⇄ MIDDLE ↓ ↓ CUSTOM ⇄ LOW</p> <p>To adjust CUSTOM</p> <p>Selecting the CUSTOM and then pressing the button ► or the ENTER button displays a dialog to aid you in adjusting the OFFSET and/or GAIN of the CUSTOM mode.</p> <p>OFFSET adjustments change the color intensity on the whole tones of the test pattern.</p> <p>GAIN adjustments mainly affect color intensity on the brighter tones of the test pattern.</p> <p>Choose an item using the buttons ◀/▶, and adjust the level using the buttons ▲/▼.</p> <p>Using a test pattern</p> <p>You can display a test pattern for checking the effect of your adjustment by pressing the ENTER button. Each time you press the ENTER button, the pattern changes as below.</p> <p>No pattern ⇄ Gray scale of 9 steps ↷ ↶ ⇄ Ramp ⇄ Gray scale of 15 steps</p> |
| <p>COLOR</p> | <p>Using the buttons ▲/▼ adjusts the strength of whole color.</p> <p>Strong ⇄ Weak</p> <ul style="list-style-type: none"> • This item can be chosen only for a video signal. |
| <p>TINT</p> | <p>Using the buttons ▲/▼ adjusts the tint.</p> <p>Green ⇄ Red</p> <ul style="list-style-type: none"> • This item can be selected only for a video signal. |
| <p>SHARPNESS</p> | <p>Using the buttons ▲/▼ adjusts the sharpness.</p> <p>Strong ⇄ Weak</p> |

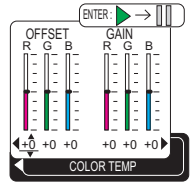
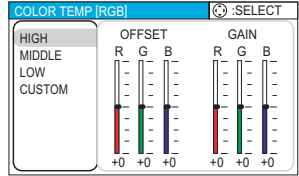

PICTURE menu (continued)

| Item | Description |
|--------------------|---|
| PROGRESSIVE | <p>Using the buttons ▲/▼ switches the progress mode. TV ⇔ FILM ⇔ TURN OFF</p>  <ul style="list-style-type: none"> • This function is performed only for an interlaced signal of a VIDEO input, an S-VIDEO input or a component video input of 525i (480i) or 625i (576i) signal. • When the TV or FILM is selected, the screen image will be sharp. The FILM mode can also be used for the 2-3 Pull-Down conversion system (not be used for the 2-2 Pull-Down system). But these may cause a certain defect (for example, jagged line) of the picture for a quick moving object. In such a case, please select the TURN OFF, even though the screen image may lose the sharp. |
| MY MEMORY | <p>Choosing a mode of MY MEMORY using the buttons ▲/▼ and then pressing the button ► or the ENTER button performs each function.</p>  <p>This projector has 4 numbered memories for adjustment data. Performing the LOAD1, LOAD2, LOAD3 or LOAD4 loads the data on the memory whose number corresponds to the command's number, and adjusts the picture automatically depending on the data.</p> <p>Performing the SAVE1, SAVE2, SAVE3 or SAVE4 saves the current adjustment data on the memory whose number corresponds with the command's number.</p> <ul style="list-style-type: none"> • The current adjustment data of the items in the PICTURE menu is stored. Except for the adjustment data in the CUSTOM modes for the GAMMA (M33) and COLOR TEMP items. (M34) |

IMAGE menu

With the IMAGE menu, the items shown in the table below can be performed.

Choose an item using the cursor buttons ▲/▼ on the projector or remote control, and press the cursor button ► on the projector or remote control, or the ENTER button on the remote control to execute the item. Then perform it referring to the following table.

| MENU [RGB] | | SELECT |
|------------|---------------------|--------|
| PICTURE | ASPECT | 4:3 |
| IMAGE | OVER SCAN | 5 |
| INPUT | V POSITION | 25 |
| SETUP | H POSITION | 142 |
| SCREEN | H PHASE | 16 |
| OPTION | H SIZE | 1344 |
| EASY MENU | AUTO ADJUST EXECUTE | |

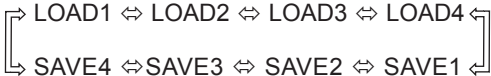



| Item | Description |
|--|---|
| ASPECT | Using the buttons ▲/▼ switches the mode for aspect ratio. |
| | For a 16:9 signal |
| |  |
| | For a 4:3 signal |
| |  |
| | For an RGB signal |
| 4:3 ⇄ 16:9 ⇄ NORMAL | |
|  | |
| For a video signal, s-video signal or component video signal | |
| 4:3 ⇄ 16:9 ⇄ WIDE ⇄ MOVIE1 ⇄ MOVIE2 | |
|  | |
| For no signal | |
| 4:3 ⇄ 16:9 | |
|  | |
| <ul style="list-style-type: none"> • The NORMAL mode keeps the original aspect ratio of the signal. • For an HDTV component video signal of 1125i (1080i) or 750p (720p), this item cannot be chosen. • Performing the automatic adjustment initializes the aspect ratio setting. • While setting the WIDE mode, the correction of keystone distortion is not effective. (📖25, 40) • Setting the WIDE mode may limit the magnify range. (📖26) | |

IMAGE menu (continued)

| Item | Description |
|-------------------|---|
| OVER SCAN | Using the buttons ▲/▼ adjusts the over-scan ratio. Large (It reduces picture) ⇔ Small (It magnifies picture) <ul style="list-style-type: none"> • This item can be chosen only for a video signal. • When this adjustment is too large, certain degradation may appear at the frame area of the picture. In such a case, please adjust small. • The number displayed on the menu during this adjustment is just for your reference, and might not be exact display ratio. |
| V POSITION | Using the buttons ▲/▼ adjusts the vertical position. Up ⇔ Down |
| H POSITION | Using the buttons ▲/▼ adjusts the horizontal position. Left ⇔ Right |
| H PHASE | Using the buttons ▲/▼ adjusts the horizontal phase to eliminate flicker. Right ⇔ Left <ul style="list-style-type: none"> • This item can be chosen only for an RGB signal or a component video signal (except 525i (480i) and 625i (576i)). |
| H SIZE | Using the buttons ▲/▼ adjusts the horizontal size. Large ⇔ Small <ul style="list-style-type: none"> • This item can be chosen only for an RGB signal. • When this adjustment is excessive, the picture may not be displayed correctly. In such a case, please reset the adjustment by pressing the RESET button during this operation. |

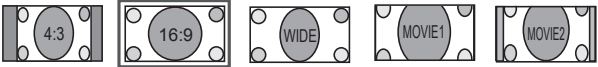
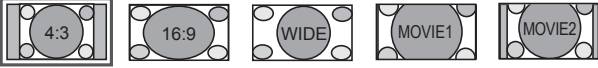
IMAGE menu (continued)



| Item | Description |
|----------------------------|---|
| AUTO ADJUST EXECUTE | <p>Choosing this item performs the automatic adjustment feature.</p> <p>For an RGB signal The vertical position, the horizontal position, the clock phase and the horizontal size will be automatically adjusted. And the aspect ratio will be automatically selected. Make sure that the application window is set to its maximum size prior to attempting to use this feature. A dark picture may still be incorrectly adjusted. Use a bright picture when adjusting.</p> <p>For a video signal or s-video signal The video format best suited for the respective input signal will be automatically selected. This function is available only when the AUTO mode is selected to the VIDEO FORMAT item in the INPUT menu. (P.39) And the aspect ratio will be selected automatically.</p> <p>For a video signal, s-video signal or component video signal The vertical position and horizontal position will be automatically adjusted.</p> <p>For a component video signal The aspect ratio will be automatically selected. The clock phase will be automatically adjusted.</p> <ul style="list-style-type: none"> • The automatic adjustment operation requires approximately 10 seconds. Also please note that it may not function correctly with some input. |

INPUT menu

With the INPUT menu, the items shown in the table below can be performed.

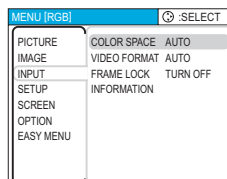
Choose an item using the cursor buttons ▲/▼ on the projector or remote control, and press the cursor button ► on the projector or remote control, or the ENTER button on the remote control to execute the item. Then perform it referring to the following table.



| Item | Description |
|----------------------------|--|
| <p>COLOR SPACE</p> | <p>Using the buttons ▲/▼ switches the mode for color space. AUTO ⇄ RGB ⇄ SMPTE240 ⇄ REC709 ⇄ REC601 </p> <ul style="list-style-type: none"> • This item can be chosen only for an RGB signal or a component video signal. • The AUTO mode automatically selects the optimum mode. • The AUTO operation may not work well at some signals. In such a case, select a suitable mode other than AUTO. |
| <p>VIDEO FORMAT</p> | <p>Using the buttons ▲/▼ switches the mode for video format. AUTO ⇄ NTSC ⇄ PAL ⇄ SECAM </p> <ul style="list-style-type: none"> • This item is performed only for a video signal from the VIDEO port or the S-VIDEO port. For a component video signal, the signal type is identified automatically, independently of this function. • The AUTO mode automatically selects the optimum mode. • The AUTO operation may not work well for some signals. If the picture becomes unstable (ex. an irregular picture, a color lack), please select the mode depending on the input signal. |
| <p>FRAME LOCK</p> | <p>Using the buttons ▲/▼ turns the frame lock function on/off. TURN ON ⇄ TURN OFF</p> <ul style="list-style-type: none"> • This item performs only for an RGB signal with vertical frequency of 50 to 72 Hz. • When the TURN ON is selected, a moving picture is displayed more smoothly. • This function may cause a certain degradation of the picture. In such a case, please select the TURN OFF. |
| <p>INFORMATION</p> | <p>Choosing this item displays a dialog titled “INPUT INFORMATION”. It shows the information about the current input.</p> <ul style="list-style-type: none"> •The “FRAME LOCK” message on the dialog means the frame lock function is working. ( 39) •This item cannot be chosen for no signal. <div style="display: flex; justify-content: space-between; align-items: flex-start;"> <div style="border: 1px solid black; padding: 5px; width: 45%;"> <p>◀ INPUT-INFORMATION RGB 1024x768 @60.0 FRAME LOCK</p> </div> <div style="border: 1px solid black; padding: 5px; width: 45%;"> <p>◀ INPUT-INFORMATION S-VIDEO SECAM AUTO</p> </div> </div> |

SETUP menu

With the SETUP menu, the items shown in the table below can be performed.

Choose an item using the cursor buttons ▲/▼ on the projector or remote control, and press the cursor button ► on the projector or remote control, or the ENTER button on the remote control to execute the item. Then perform it referring to the following table.

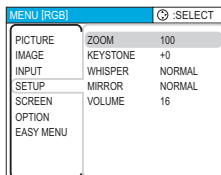

| Item | Description |
|-----------------|---|
| ZOOM | Using the buttons ▲/▼ adjusts the zoom (magnifying power). Large ⇄ Small |
| KEYSTONE | Using the buttons ▲/▼ corrects the keystone distortion. Upper in the data ⇄ Lower in the data <ul style="list-style-type: none"> • The adjustable range for correction will vary among inputs. For some signals, this function may not work well. • When the V:INVERT or H&V:INVERT is selected under the MIRROR item in the SETUP menu, if the projector screen is inclined or angled downward, this function may not work correctly. • While setting the WIDE mode for aspect ratio, the correction of keystone distortion is not effective. (p.23, 36) |
| WHISPER | Using the buttons ▲/▼ turns off/on the whisper mode. NORMAL ⇄ WHISPER <ul style="list-style-type: none"> • When the WHISPER is selected, acoustic noise and screen brightness are reduced. |
| MIRROR | Using the buttons ▲/▼ switches the mode for mirror status. NORMAL ⇄ H:INVERT ⇄ V:INVERT ⇄ H&V:INVERT |
| VOLUME | Using the buttons ▲/▼ adjusts the volume. High ⇄ Low |

SCREEN menu

With the SCREEN menu, the items shown in the table below can be performed.

Choose an item using the cursor buttons ▲/▼ on the projector or remote control, and press the cursor button ► on the projector or remote control, or the ENTER button on the remote control to execute the item. Then perform it referring to the following table.

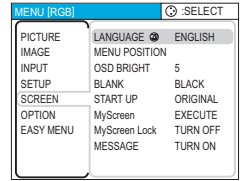

ENGLISH

| Item | Description |
|----------------------|--|
| LANGUAGE | <p>Using the buttons ▲/▼ switches the OSD (On Screen Display) language.</p> <p>ENGLISH ⇄ FRANÇAIS ⇄ DEUTSCH ⇄ ESPAÑOL ⇄ ITALIANO ↳ NORSK ⇄ NEDERLANDS ⇄ PORTUGUÊS ⇄ 日本語 ↳ 简体中文 ⇄ 繁體中文 ⇄ 한글 ⇄ SVENSKA ⇄ РУССКИЙ ↳ SUOMI ⇄ POLSKI ⇄ TÜRKÇE ↳</p> |
| MENU POSITION | <p>Using the buttons ◀/▶/▲/▼ adjusts the menu position. To quit the operation, press the MENU button or keep no operation for 10 seconds.</p> |
| OSD BRIGHT. | <p>Using the buttons ▲/▼ switches the brightness level of the OSD (On Screen Display). BRIGHT ⇄ DARK</p> |
| BLANK | <p>Using the buttons ▲/▼ switches the mode for the blank screen. The blank screen is a screen for the temporarily blanking feature. (P.27) It is displayed by pressing the BLANK button. MyScreen ⇄ ORIGINAL ⇄ BLUE ⇄ WHITE ⇄ BLACK ↳</p> <p>MyScreen is a screen you can register as a desired screen. The ORIGINAL screen is the existing standard screen. BLUE, WHITE and BLACK are non-patterned (plain) screens in each color.</p> <ul style="list-style-type: none"> • To avoid remaining as an afterimage, the MyScreen and the ORIGINAL screens will change to the BLACK screen after several minutes. • For the MyScreen, please refer to the MyScreen item. (P.42) |

SCREEN menu (continued)

| Item | Description |
|------------------------|--|
| <p>START UP</p> | <p>Using the buttons ▲/▼ switches the mode for the start up screen. The start up screen is a screen displayed when no signal or an unsuitable signal is detected.</p> <p style="text-align: center;">MyScreen ⇄ ORIGINAL ⇄ TURN OFF </p> <p>MyScreen is a screen you can register as a desired screen. The ORIGINAL screen is the existing standard screen. When the TURN OFF is selected, the BLACK screen is used.</p> <ul style="list-style-type: none"> • To avoid remaining as an afterimage, the MyScreen and the ORIGINAL screens will change to the BLANK screen after several minutes. If also the BLANK screen is the MyScreen or ORIGINAL, it will change to the BLACK screen. • For the MyScreen, please refer to the item MyScreen below. About the BLACK and BLANK screens, please refer to the item BLANK. (P.41) |
| <p>MyScreen</p> | <p>This item functions for capturing the MyScreen of the blank screen and the start up screen. Please execute displaying the input including the picture you want to capture.</p> <ol style="list-style-type: none"> Choosing this item displays a dialog titled “MyScreen”. It will ask you if you start capturing the picture from the current screen. Please wait for the target picture to be displayed. Press the ENTER button when the picture is display. The picture will freeze and the frame for capturing appears. To restore the screen and return to the previous dialog, press the RESET or ESC button. Using the buttons ◀/▶/▲/▼ adjusts the frame position. Please move the frame to the position of the picture which you want to use. Although the adjustable range will vary depending on inputs, and the frame may not move for some signals. To restore the screen and return to the previous dialog, press the RESET or ESC button. To start registration, press the ENTER button. <ul style="list-style-type: none"> • Registration takes several minutes. When the registration is completed, the registered screen and the message “MyScreen registration is finished.” are displayed for several seconds. If the registration failed, the message “A capturing error has occurred. Please try again.” is displayed. |

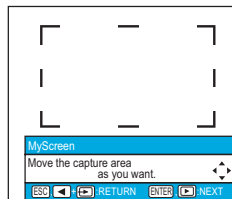
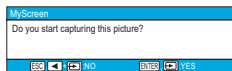

SCREEN menu (continued)

| Item | Description |
|----------------------|--|
| MyScreen Lock | Using the buttons ▲/▼ turns on/off the MyScreen lock function. TURN ON ⇔ TURN OFF When the TURN ON is selected, the item MyScreen is locked. Use this function for protecting the current MyScreen. |
| MESSAGE | Using the buttons ▲/▼ turns on/off the message function. TURN ON ⇔ TURN OFF When the TURN ON is selected, the following message function works. "AUTO IN PROGRESS" while automatically adjusting "NO INPUT IS DETECTED" "SYNC IS OUT OF RANGE" "Searching ..." while searching for an input signal "Detecting ..." when an input signal is detected The input signal display displayed when it is changed The aspect ratio display displayed when it is changed |

OPTION menu

With the OPTION menu, the items shown in the table below can be performed.

Choose an item using the cursor buttons ▲/▼ on the projector or remote control, and press the cursor button ► on the projector or remote control, or the ENTER button on the remote control to execute the item. Then perform it referring to the following table.

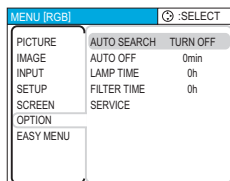

| Item | Description |
|---------------------------|---|
| <p>AUTO SEARCH</p> | <p>Using the buttons ▲/▼ turns on/off the automatic signal search function.</p> <p>TURN ON ⇔ TURN OFF</p> <p>When the TURN ON is selected, detecting no signal automatically cycles through input ports in the following order.</p> <p>RGB ⇨ S-VIDEO ⇨ VIDEO</p> <p>Then when an input is found, the projector will stop searching and display the image.</p> |
| <p>AUTO OFF</p> | <p>Using the buttons ▲/▼ adjusts the time to count down to automatically turn the projector off.</p> <p>Long (max. 99 minutes) ⇔ Short (min. 0 minute = DISABLE)</p> <p>When the time is set to 0, the projector is not turned off automatically. When the time is set to 1 to 99, and when the passed time with a no-signal or an unsuitable signal reaches at the set time, the projector lamp will go off and the power indicator begins blinking. Please refer to the section “Turning off the power”. (P. 20)</p> |
| <p>LAMP TIME</p> | <p>The lamp time is the time counted after the last resetting. It is shown in the OPTION menu as the usage time of the lamp. Performing this item resets the time.</p> <p>Pressing the RESET button on the remote control or the button ► on the projector displays a dialog to make sure.</p> <p>To perform reset, point at RESET using the button ▲.</p> <p>RESET ⇔ CANCEL</p> <ul style="list-style-type: none"> • Please reset the lamp time only when you have replaced the lamp, for a suitable indication about the lamp. • For the lamp replacement, please see the section "Lamp". (P. 47, 48, 49) |

OPTION menu (continued)

ENGLISH

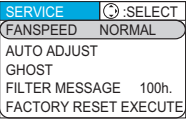
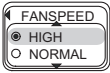
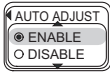
| Item | Description |
|--|--|
| <p>FILTER TIME</p> | <p>The filter time is the time counted after the last resetting. It is shown in the OPTION menu as the usage time of the air filter. Performing this item resets the time. Pressing the RESET button on the remote control or the button ► on the projector displays a dialog to make sure. To perform reset, point at RESET using the button ▲.</p> <p>RESET ⇄ CANCEL</p>  <ul style="list-style-type: none"> • Please reset the filter time only when you have cleaned or replaced the lamp, for a suitable indication about the air filter. • For the air filter care, please see the section "Air filter". (P.50) |
| <p>SERVICE</p> <p>(to be continued)</p> | <p>Choosing this item displays the SERVICE menu. Choose an item using the buttons ▲/▼, and press the button ► or the ENTER button to execute the item.</p>  <p>FAN SPEED ⇄ AUTO ADJUST ⇄ GHOST</p> <p>↕</p> <p>FACTORY RESET ⇄ FILTER MESSAGE ← ↗</p> <p>FAN SPEED Using the buttons ▲/▼ switches the rotation speed of the cooling fans.</p> <p>HIGH ⇄ NORMAL</p>  <p>The HIGH is the mode for use at highlands etc.</p> <ul style="list-style-type: none"> • Note that the projector is noisier when the HIGH is selected. • Except for use at highlands, please use setting the NORMAL mode. The HIGH mode may shorten the lifetimes of the lamp. <p>AUTO ADJUST Using the buttons ▲/▼ enables or disables the automatic adjustment.</p> <p>ENABLE ⇄ DISABLE</p>  <p>Depending on conditions, such as input image, signal cable to the unit, environment around the unit, etc. the automatic adjustment may not work correctly. In such a case, please choose DISABLE to disable the automatic adjustment, and make adjustment manually.</p> |

Maintenance

Lamp

**WARNING**

HIGH VOLTAGE



HIGH TEMPERATURE



HIGH PRESSURE

► The projector uses a high-pressure mercury glass lamp. The lamp can break with a loud bang, or burn out, if jolted or scratched, handled while hot, or worn over time. Note that each lamp has a different lifetime, and some may burst or burn out soon after you start using them. In addition, when the bulb bursts, it is possible for shards of glass to fly into the lamp housing, and for gas containing mercury to escape from the projector's vent holes.

► **About disposal of a lamp** • This product contains a mercury lamp; do not put it in a trash. Dispose of it in accordance with environmental laws. For lamp recycling, go to www.lamprecycle.org. (in the US) For product disposal, contact your local government agency or www.eiae.org (in the US) or www.epsc.ca (in Canada). For more information, call your dealer.



Disconnect the plug from the power outlet

- If the lamp should break (it will make a loud bang when it does), unplug the power cord from the outlet, and make sure to request a replacement lamp from your local dealer. Note that shards of glass could damage the projector's internals, or cause injury during handling, so please do not try to clean the projector or replace the lamp yourself.
- If the lamp should break (it will make a loud bang when it does), ventilate the room well, and make sure not to breathe the gas that comes out of the projector vents, or get it in your eyes or mouth.
- Before replacing the lamp, turn the projector off and unplug the power cord, then wait at least 45 minutes for the lamp to cool sufficiently. Handling the lamp while hot can cause burns, as well as damaging the lamp.



- Never unscrew except the appointed (marked by an arrow) screws.
- Do not open the lamp cover while the projector is suspended from above. This is dangerous, since if the lamp's bulb has broken, the shards will fall out when the cover is opened. In addition, working in high places is dangerous, so ask your local dealer to have the lamp replaced even if the bulb is not broken.
- Do not use the projector with the lamp cover removed. At the lamp replacing, make sure that the screws are screwed in firmly. Loose screws could result in damage or injury.



- Use only the lamp of the specified type.
- If the lamp breaks soon after the first time it is used, it is possible that there are electrical problems elsewhere besides the lamp. If this happens, contact your local dealer or a service representative.
- Handle with care: jolting or scratching could cause the lamp bulb to burst during use.
- Using the lamp for long periods of time, could cause it dark, not to light up or to burst. When the pictures appear dark, or when the color tone is poor, please replace the lamp as soon as possible. Do not use old (used) lamps; this is a cause of breakage.

A lamp has a finite product life. Using the lamp for long periods of time could cause the pictures darker or the color tone poor. Note that each lamp has a different lifetime, and some may burst or burn out soon after you start using them. Preparation of a new lamp and early replacement are recommended.

To prepare a new lamp, contact your dealer and tell the lamp type number.

Type number = DT00707

1. Turn the projector off, and unplug the power cord. Allow the lamp to cool for at least 45 minutes.
2. Prepare a new lamp.
If the projector is mounted on the ceiling, or if the lamp has broken, also ask the dealer to replace the lamp.

In the case of replacement by yourself,

3. After making sure that the projector has cooled adequately, slowly turn over the projector, so that the bottom is facing up.

4. Please loosen the screw (marked by arrow). Then, unhook the claws of the lamp cover and remove the lamp cover.

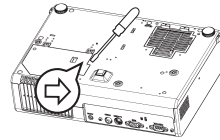

5. Loosen the 2 screws (marked by arrow) of the lamp, and slowly pick up the lamp by the handles. Please be careful in handling the lamp. Breaking the lamp could cause an injury and an escape of gas containing mercury.

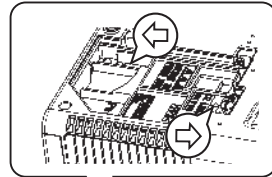

6. Insert the new lamp, and retighten firmly the 2 screws that are loosened in the previous process to lock it in place.

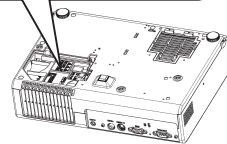

7. While interlocking the 2 tabs of the lamp cover to the projector, position the lamp cover on the projector, and push the center point of the two claws to fix the lamp cover. Then retighten firmly the screw of the lamp cover.

Center point of claws

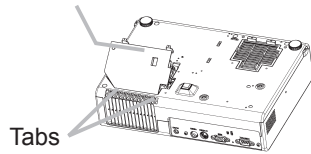

8. Please reposition and reconnect the projector, to return as before. (📖12~16)
Then turn the projector on. (📖19)
9. Reset the lamp time using the LAMP TIME function in the OPTION menu. (📖44)
- (1) Press the MENU button to display a menu.
Only when the EASY MENU has appeared, please perform the next step (2).
 - (2) Point at the “Go To Advance Menu ...” in the menu using ▼/▲ button, then press the ► button.
 - (3) Point at the “OPTION” in the left column of the menu using ▼/▲ button, then press the ► button.
 - (4) Point at the “LAMP TIME” using ▼/▲ button, then press the ► button. A dialog will appear.
 - (5) Press the ▲ button to select “RESET” on the dialog. It performs resetting the lamp time.

NOTE • Please reset the lamp time only when you have replaced the lamp, for a suitable indication about the lamp.

Air filter

If the air filter becomes clogged by dust or the like, internal temperatures rise and could cause a fire, a burn and/or malfunction to the projector.

When the indicators or a message prompts you to clean the air filter, clean the air filter as soon as possible. Please check and clean the air filter periodically, even if there is no message.

Please replace the air filter when it is damaged or too soiled. Preparation of a new air filter is recommended.

To prepare a new air filter, contact your dealer and tell the air filter type number.

Type number = NJ22642

And also when you replace the lamp, please replace the air filter. An air filter of specified type will come together with a replacement lamp for this projector.

1. Turn the projector off, and unplug the power cord. Allow the lamp to cool sufficiently.
2. When the projector is suspended from the ceiling, apply the vacuum cleaner to and around the filter cover first, to prevent of dust or the like.
3. Disconnect all the connectors and adapters that were connected to the projector's ports. Then slowly turn the projector so that the lens-side is facing up. While the projector is placed lens-side up, hold the projector.
4. Remove the filter cover and the air filter. Then slowly turn the projector, so that the bottom is facing up.

Usual filter cover

- (1) Remove the filter cover.
Hold the **knobs** while pulling out it.

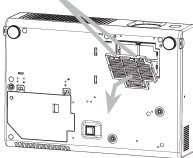

- (2) Remove the air filter.
Hold the **knob** while pulling out it.

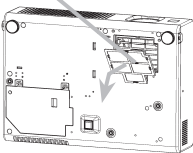

- (3) Slowly turn the projector bottom up.

5. Apply a vacuum cleaner to the vent of the projector for the air filter, the air filter and filter cover.

Please replace the air filter when it is damaged or too soiled.

Filter cover for bottom-up use

- (1) Remove the filter cover.
Hold the **knob** while pulling out it.

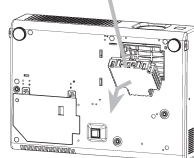

- (2) Slowly turn the projector bottom up.
- (3) Remove the air filter from the filter cover.

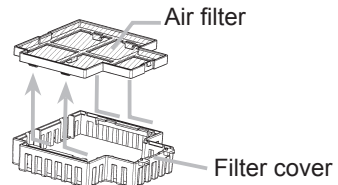

6. Position the air filter and filter cover into place.

- (1) Set an air filter into place.
Push the points of "PUSH" mark.

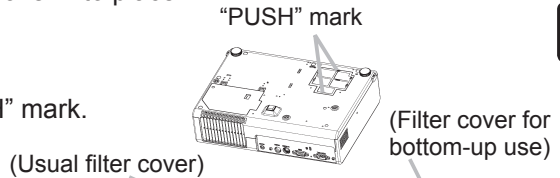

- (2) Interlocking the tabs, snap the cover into place.

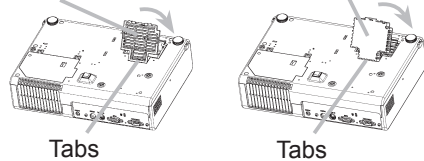

7. Please reposition and reconnect the projector, to return as before. (12~16)

Then turn the projector on. (19)

8. Reset the filter time using the FILTER TIME function in the OPTION menu. (45)

- (1) Press the MENU button to display a menu.
When the EASY MENU has appeared, please skip the next step (2).
- (2) Point at the "OPTION" in the left column of the menu using ▼/▲ button, then press the ► button.
- (3) Point at the "FILTER TIME" using ▼/▲ button, then press the ► button. A dialog will appear.
- (4) Press the ▲ button to select "RESET" on the dialog. It performs resetting the filter time.

⚠ WARNING ► Before caring, make sure the power switch is off and the power cable is not plugged in, then allow the projector to cool sufficiently. The care in a high temperature state of the projector could cause an electric shock, a burn and/or malfunction to the projector.

► Use only the air filter of the specified type. Do not use the projector with the air filter and the filter cover removed. Do not remove the filter cover and the air filter in a smoky or dusty place. It could result in a fire and/or malfunction to the projector.

► The air filter should be cleaned periodically. If the air filter becomes clogged by dust or the like, internal temperatures rise and could cause a fire, a burn and/or malfunction to the projector.

⚠ CAUTION ► Please be careful for the projector not to fall. While the projector is placed lens-side up, hold the projector.

NOTE • Please replace the air filter when it is damaged or too soiled, and also when you replace the lamp.

• Please reset the filter time only when you have cleaned or replaced the air filter, for a suitable indication about the air filter. (45, 53)

• The projector may display the message such as "CHECK THE AIR FLOW" or turn off the projector, to prevent the internal heat level rising.

Inside of the projector

In order to ensure the safe use of your projector, please have it cleaned and inspected by your dealer about once every year.

Caring for the lens

If the lens is flawed, soiled or fogged, it could cause deterioration of display quality. Please take care of the lens, being cautious of handling.

1. Turn the projector off, and unplug the power cord. Allow the projector to cool sufficiently.
2. After making sure that the projector is cool adequately, lightly wipe the lens with a commercially available lens-cleaning wipe. Do not touch the lens directly with your hand.

Caring for the cabinet and remote control

Incorrect care could have adverse influence such as discoloration, peeling paint, etc.

1. Turn the projector off, and unplug the power cord. Allow the projector to cool sufficiently.
2. After making sure that the projector is cool adequately, lightly wipe with gauze or a soft cloth.
If soiling is severe, dip soft cloth in water or a neutral cleaner dilute in water, and wipe lightly after wringing well. Then, wipe lightly with a soft, dry cloth.

⚠WARNING ▶ Do not take care of the projector during use or immediately after use. Handling while the projector is in a high temperature could cause a burn and/or malfunction to the projector. Before operating, make sure that the power switch is off, that the power cord is not plugged in, and that the projector is cool adequately.

▶ Never try to care for the inside of the projector personally. Doing is so dangerous.

▶ Avoid wetting the projector or inserting liquids in the projector. It could result in a fire, an electric shock, and/or malfunction to the projector.

• Do not put a container containing water, cleaner or chemicals near the projector.

• Do not use aerosols or sprays.

⚠CAUTION ▶ Please take right care of the projector according to the following. Incorrect care could cause not only an injury but adverse influence such as discoloration, peeling paint, etc.

• Do not use cleaner or chemicals other than those listed above.

• Do not polish or wipe with hard objects.

Troubleshooting

Related messages

When the unit's power is on, messages such as those shown below may be displayed. When any such message is displayed on the screen, please follow the instructions described below. If the same message is displayed after the remedy, or if a message other than the following appears, please contact your dealer or service company.

Although these messages will be automatically disappeared around several minutes, it will be reappeared every time the power is turned on.

| Message | Description |
|---|---|
| <div style="border: 1px solid black; padding: 5px; text-align: center;"> NO INPUT IS DETECTED ON *** </div> | <p>There is no input signal. Please confirm the signal input connection, and the status of the signal source.</p> |
| <div style="border: 1px solid black; padding: 5px; text-align: center;"> SYNC IS OUT OF RANGE ON *** [FH] *****kHz [FV] *****Hz </div> | <p>The horizontal or vertical wavelength of the input signal is out of the response parameter range of this unit. Please confirm the specs for your projector or the signal source specs.</p> |
| <p>CHECK THE AIR FLOW</p> | <p>The internal portion temperature is rising. Please turn the power OFF, and allow the unit to cool down at least 20 minutes. After having confirmed the following items, please turn the power ON again.</p> <ul style="list-style-type: none"> • Is there blockage of the air passage aperture? • Is the air filter dirty? • Does the peripheral temperature exceed 35°C? • If the same indication is displayed after the remedy, please set FAN SPEED of the SERVICE item in the OPTION menu to HIGH. (P45) |
| <p>REMINDER *** HRS PASSED AFTER THE LAST FILTER CHECK. FILTER MAINTENANCE IS ESSENTIAL TO REMOVE WARNING MESSAGE, RESET FILTER TIMER. SEE MANUAL FURTHER INFO</p> | <p>A note of precaution when cleaning the air filter. Please immediately turn the power off, and clean or change the air filter by referring to the “Air Filter” section of this manual. After you have cleaned or changed the air filter, please be sure to reset the filter timer. (P45)</p> |

Regarding the indicator lamps

Lighting and flashing of the POWER indicator, the LAMP indicator, and the TEMP indicator have the meanings as described in the table below. Please follow the instructions within the table. If the same indication is displayed after the remedy, or if an indication other than the following is displayed, please contact your dealer or service company.

| POWER indicator | LAMP indicator | TEMP indicator | Description |
|---|----------------------------------|----------------------|---|
| Lighting In Orange | Turned off | Turned off | The projector is in a standby state. Please refer to the section "Power On/Off". (P.19) |
| <i>Blinking</i> In Green | Turned off | Turned off | The projector is warming up. Please wait. |
| Lighting In Green | Turned off | Turned off | The projector is in an on state. Ordinary operations may be performed. |
| <i>Blinking</i> In Orange | Turned off | Turned off | The projector is cooling down. Please wait. |
| <i>Blinking</i> In Red | (discretionary) | (discretionary) | The projector is cooling down. A certain error has been detected. Please wait until the POWER indicator finishes blinking, and then perform the proper measure, referring to the item descriptions below. |
| <i>Blinking</i> In Red or Lighting In Red | Lighting In Red | Turned off | The lamp does not light, and there is a possibility that interior portion has become heated. Please turn the power off, and allow the projector to cool down at least 20 minutes. After the projector has sufficiently cooled down, please make confirmation of the following items, and then turn the power on again. <ul style="list-style-type: none"> • Is there blockage of the air passage aperture? • Is the air filter dirty? • Does the peripheral temperature exceed 35°C? If the same indication is displayed after the remedy, please change the lamp referring to the section "Lamp" (P.48, 49). |
| <i>Blinking</i> In Red or Lighting In Red | <i>Blinking</i> In Red | Turned off | The lamp cover has not been properly fixed. Please turn the power off, and allow the projector to cool down at least 45 minutes. After the projector has sufficiently cooled down, please make confirmation of the attachment state of the lamp cover. After performing any needed maintenance, turn the power on again. If the same indication is displayed after the remedy, please contact your dealer or service company. |

Regarding the indicator lamps (continued)

| POWER indicator | LAMP indicator | TEMP indicator | Description |
|--|-------------------------------------|------------------------|---|
| Blinking In Red or Lighting In Red | Turned off | Blinking In Red | <p>The cooling fan is not operating.</p> <p>Please turn the power off, and allow the projector to cool down at least 20 minutes. After the projector has sufficiently cooled down, please make confirmation that no foreign matter has become caught in the fan, etc., and then turn the power on again. If the same indication is displayed after the remedy, please contact your dealer or service company.</p> |
| Blinking In Red or Lighting In Red | Turned off | Lighting In Red | <p>There is a possibility that the interior portion has become heated.</p> <p>Please turn the power off, and allow the projector to cool down at least 20 minutes. After the projector has sufficiently cooled down, please make confirmation of the following items, and then turn the power on again.</p> <ul style="list-style-type: none"> • Is there blockage of the air passage aperture? • Is the air filter dirty? • Does the peripheral temperature exceed 35°C? • Is the projector used at a highland? Please set FAN SPEED of the SERVICE item in the OPTION menu to HIGH, only when the projector is used at a highland. <p>(45)</p> |
| Lighting In Green | Alternative blinking in Red | | <p>There is a possibility that the interior portion has become overcooled.</p> <p>Please use the projector within the usage temperature parameters (5°C to 35°C). After the remedy, reset the power to ON.</p> |
| Lighting In Green | Simultaneous blinking in Red | | <p>It is time to clean the air filter.</p> <p>Please immediately turn the power off, and clean or change the air filter referring to the section “Air Filter”. After cleaning or changing the air filter, please be sure to reset the filter timer. After the remedy, reset the power to ON.</p> |

NOTE • When the interior portion has become overheated, for safety purposes, the power source is automatically turned off, and the indicator lamps may also be turned off. In such a case, press the “O” (OFF) side of the power switch, and wait at least 45 minutes. After the projector has sufficiently cooled down, please make confirmation of the attachment state of the lamp and lamp cover, and then turn the power on again.

Phenomena that may easily be taken as machine defects

1. Before requesting repair, please check in accordance with the following chart.
This operation sometimes resolves your problem.

If the situation cannot be corrected,

2. The projector's microprocessor may need to be reset. Please push the restart switch by using a pin or similar. (🔗20)
3. Some setting may be wrong. Please use the FACTORY RESET function of the SERVICE item in the OPTION menu (🔗46) to reset all settings to factory default.

Then, if the problem is not removed after maintenance, please contact your dealer or service company.

⚠WARNING ▶ Never use the projector if abnormal operations such as smoke, strange odor, excessive sound, damaged casing or elements or cables, penetration of liquids or foreign matter, etc. should occur. In such cases, immediately turn off the power switch and then disconnect the power plug from the power outlet. After making sure that the smoke or odor has stopped, contact your dealer or service company.

| Phenomenon | Cases not involving a machine defect | Reference page🔗 |
|--|--|-----------------|
| Power does not come on. | The electrical power cord is not plugged in. Correctly connect the power cord. | 16 |
| | The power switch is not set to the on position. Set the power switch to [] (On). | 19 |
| | The main power source has been interrupted during operation such as by a power outage (blackout), etc. Please turn the power off, and allow the unit to cool down at least 20 minutes. After the projector has sufficiently cooled down, please turn the power on again. | 19, 20 |
| | The computer cannot detect the projector as a plug and play monitor. Make sure that the computer's can detect a plug and play monitor using other plug and play monitor. | 15 |
| Neither sounds nor pictures are outputted. | The signal cables are not correctly connected. Correctly connect the connection cables. | 13, 14 |
| | Signal source does not correctly work. Correctly set up the signal source device by referring to the manual of the source device. | - |
| | The input changeover settings are mismatched. Select the input signal, and correct the setting. | 22 |

Phenomena that may be easy to be mistaken for machine defects (continued)

| Phenomenon | Cases not involving a machine defect | Reference page  |
|---|--|--|
| Pictures are displayed, but no sounds are heard. | The signal cables are not correctly connected. Correctly connect the connection cables. | 13, 14 |
| | The volume is adjusted to an extremely low level. Adjust the VOLUME to a higher level. | 21 |
| | The sound is muted. Press the MUTE button to restore the sound. | 21 |
| Sounds are heard, but no pictures are displayed. | The lens cover is closed. Remove the lens cover. | 19 |
| | The signal cables are not correctly connected. Correctly connect the connection cables. | 13, 14 |
| | The brightness is adjusted to an extremely low level. Adjust the BRIGHT to a higher level using the menu function or the remote control. | 31, 33 |
| | The computer cannot detect the projector as a plug and play monitor. Make sure that the computer can detect a plug and play monitor using another plug and play monitor. | 15 |
| Colors have a faded- out appearance, or Color tone is poor. | Color settings are not correctly adjusted. Perform picture adjustments by changing the COLOR TEMP, COLOR, TINT and/or COLOR SPACE settings, using the menu functions. | 31, 34, 39 |
| | COLOR SPACE setting is not suitable. Change the COLOR SPACE setting to AUTO, RGB, SMPTE240, REC709 or REC601. | 39 |
| Pictures appear dark. | The brightness and/or contrast are adjusted to an extremely low level. Adjust BRIGHTNESS and/or CONTRAST settings to a higher level using the menu function. | 31, 33 |
| | The WHISPER function is working. Select NORMAL for the WHISPER item in the SETUP menu. | 32, 40 |
| | The lamp is approaching the end of its product lifetime. Replace the lamp. | 47~49 |
| Pictures appear blurry. | Either the focus and/or horizontal phase settings are not properly adjusted. Adjust the focus using the focus ring, and/or H PHASE using the menu function. | 24, 37 |
| | The lens is dirty or misty. Clean the lens referring to the section "Caring for the lens". | 52 |

NOTE • Although bright spots or dark spots may appear on the screen, this is a unique characteristic of liquid crystal displays. And performing some function (changing a mode, adjusting the sharpness or position, etc.) may cause a certain noise on the screen. These phenomena do not constitute or imply a machine defect.

Warranty and after-service

If a problem occurs with the equipment, first refer to the “Troubleshooting” (📖53~57) and run through the suggested checks.

If this does not resolve the problem, please contact your dealer or service company. They will tell you what warranty condition is applied.

Specifications

| Item | | Specification |
|----------------------|--------------|---|
| Product name | | Liquid crystal projector |
| Liquid Crystal panel | Panel size | 1.4 cm (0.55 type) |
| | Drive system | TFT active matrix |
| | Pixels | 415,272 pixels (858 horizontal x 484 vertical) |
| Lens | | F=1.65 f=20.4 mm |
| Lamp | | 165W UHB |
| Power Supply | | AC100-120V/2.7A, AC220-240V/1.5A |
| Power Consumption | | 240W |
| Temperature range | | 5 ~ 35°C (Operating) |
| Size | | 285 (W) x 73 (H) x 202 (D) mm (Not including protruding parts) • Please refer to the following figure. |
| Weight (mass) | | 2.2 kg |
| Ports | | RGB input: RGB.....D-sub 15pin mini x 1 Communication port: CONTROL..... D-sub 9pin x 1 Video input: VIDEO RCA x 1 S-VIDEO S-Video x 1 Audio input: AUDIO Stereo mini x 1 |
| Optional parts | Lamp | DT00707 |
| | Air filter | NJ22642 |
| | Others | • Please consult your dealer. |

NOTE • These specifications are subject to change without notice.

Dimension diagram

