

Operating Instructions Functional Manual

DLP™ Projector Commercial Use

Model No. **PT-RZ21K**
PT-RS20K

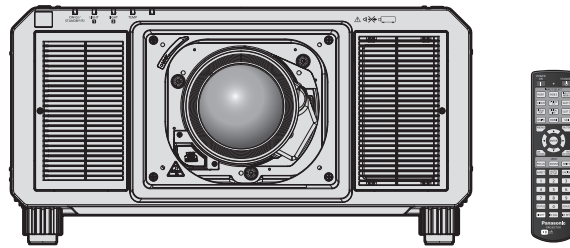

The projection lens is sold separately.

Thank you for purchasing this Panasonic product.

- This manual is common to all the models.
 - for India
PT-RZ21KD
 - for Taiwan
PT-RZ21K
 - for other countries or regions
PT-RZ21K / PT-RS20K
- Before operating this product, please read the instructions carefully and save this manual for future use.
- Before using this product, be sure to read “Read this first!” (➔ pages 5 to 15).



real D) 3D



Contents

Read this first! 5

Chapter 1 Preparation

Precautions for use	19
Cautions when transporting	19
Cautions when installing	19
Cautions when setting up the projector	20
Security	22
DIGITAL LINK	23
Art-Net	23
Application software supported by the projector	23
Storing	23
Disposal	23
Cautions on use	23
Accessories	25
Optional accessories	27
About your projector	28
Remote control	28
Projector body	30
Preparing the remote control	33
Inserting and removing the batteries	33
When using the multiple projectors	33
Connecting the remote control to the projector with a cable	34

Chapter 2 Getting Started

Setting up	36
Usable outlet	36
Installation mode	36
Parts for installation (optional)	38
Projected image and throw distance	38
Adjusting adjustable feet	48
Attaching/removing the projection lens (optional)	49
Attaching the projection lens	49
Removing the projection lens	50
Connecting	52
Before connecting	52
Connecting example: AV equipment	53
Connecting example: Computers	54
Connecting example using DIGITAL LINK	55
Connecting example when using the contrast synchronization function/shutter synchronization function	56

Chapter 3 Basic Operations

Switching on/off the projector	59
Connecting the power cord	59
Power indicator	60
Switching on the projector	61
When the initial setting screen is displayed	62
Making adjustments and selections	68
Switching off the projector	69
Projecting	70
Selecting the input signal	70
Adjusting the focus, zoom, and lens shift	71
Adjusting the focus when the Fixed-focus Lens (Model No.: ET-D75LE95, ET-D75LE90) is used	72
Setting the lens type	73
Executing the lens calibration	73
Moving the projection lens to the home position	75
Lens shift range	76
Adjusting the lens mounter when the focus is unbalanced	78
Operating with the remote control	80
Using the shutter function	80
Using the on-screen display function	80
Using the automatic setup function	81
Switching the image aspect ratio	81
Using the function button	81
Displaying internal test pattern	82
Using the status function	82
Using the AC voltage monitor function	83
Setting ID number of the remote control	83

Chapter 4 Settings

Menu navigation	85
Navigating through the menu	85
Main menu	86
Sub-menu	87

Contents

[PICTURE] menu	91	[DISPLAY OPTION] menu	117
[PICTURE MODE].....	91	[COLOR MATCHING].....	117
[CONTRAST].....	91	[LARGE SCREEN CORRECTION].....	118
[BRIGHTNESS].....	92	[SCREEN SETTING].....	118
[COLOR].....	92	[AUTO SIGNAL].....	119
[TINT].....	92	[AUTO SETUP].....	119
[COLOR TEMPERATURE].....	92	[BACKUP INPUT SETTING].....	120
[GAMMA].....	94	[SIMUL INPUT SETTING].....	121
[SYSTEM DAYLIGHT VIEW].....	95	[RGB IN].....	122
[SHARPNESS].....	95	[DVI-D IN].....	123
[NOISE REDUCTION].....	96	[HDMI IN].....	125
[DYNAMIC CONTRAST].....	96	[DIGITAL LINK IN].....	126
[COLOR SPACE].....	97	[SDI IN].....	127
[SYSTEM SELECTOR].....	98	[ON-SCREEN DISPLAY].....	130
sRGB-compliant video.....	98	[MENU MODE].....	132
[POSITION] menu	99	[IMAGE ROTATION].....	132
[SHIFT].....	99	[BACK COLOR].....	132
[ASPECT].....	99	[STARTUP LOGO].....	132
[ZOOM].....	100	[UNIFORMITY].....	133
[CLOCK PHASE].....	101	[SHUTTER SETTING].....	134
[GEOMETRY].....	102	[FREEZE].....	136
[ADVANCED MENU] menu	105	[WAVEFORM MONITOR].....	136
[DIGITAL CINEMA REALITY].....	105	[CUT OFF].....	138
[BLANKING].....	105	[PROJECTOR SETUP] menu	139
[INPUT RESOLUTION].....	106	[PROJECTOR ID].....	139
[CLAMP POSITION].....	106	[PROJECTION METHOD].....	139
[EDGE BLENDING].....	107	[LENS].....	140
[FRAME RESPONSE].....	108	[OPERATION SETTING].....	152
[FRAME DELAY].....	109	[LIGHT OUTPUT].....	154
[FRAME CREATION].....	109	[BRIGHTNESS CONTROL].....	155
[FRAME LOCK].....	110	[STANDBY MODE].....	159
[RASTER POSITION].....	110	[NO SIGNAL SHUT-OFF].....	159
[DISPLAY LANGUAGE] menu	111	[NO SIGNAL LIGHTS-OUT].....	159
Changing the display language.....	111	[INITIAL STARTUP].....	160
[3D SETTINGS] menu	112	[STARTUP INPUT SELECT].....	160
[3D SYSTEM SETTING].....	112	[DATE AND TIME].....	160
[3D SYNC SETTING].....	112	[SCHEDULE].....	161
[3D INPUT FORMAT].....	113	[MULTI PROJECTOR SYNC].....	163
[LEFT/RIGHT SWAP].....	113	[RS-232C].....	165
[3D COLOR MATCHING].....	114	[REMOTE2 MODE].....	166
[3D PICTURE BALANCE].....	114	[FUNCTION BUTTON].....	167
[DARK TIME SETTING].....	114	[STATUS].....	167
[3D TEST MODE].....	115	[AC VOLTAGE MONITOR].....	169
[3D TEST PATTERN].....	115	[SAVE ALL USER DATA].....	169
[SAFETY PRECAUTIONS MESSAGE].....	116	[LOAD ALL USER DATA].....	170
[3D SAFETY PRECAUTIONS].....	116	[INITIALIZE].....	170
		[SERVICE PASSWORD].....	171
		[P IN P] menu	172
		Using P IN P function.....	172
		[TEST PATTERN] menu	174
		[TEST PATTERN].....	174

[SIGNAL LIST] menu	175
Registering new signals	175
Renaming the registered signal	175
Deleting the registered signal	175
Protecting the registered signal	176
Expanding signal lock-in range	176
Sub memory	177
[SECURITY] menu	178
[SECURITY PASSWORD]	178
[SECURITY PASSWORD CHANGE]	178
[DISPLAY SETTING]	178
[TEXT CHANGE]	179
[CONTROL DEVICE SETUP]	179
[CONTROL DEVICE PASSWORD CHANGE]	
.....	180
[NETWORK] menu	182
[DIGITAL LINK MODE]	182
[DIGITAL LINK STATUS]	182
[NETWORK SETUP]	183
[NETWORK CONTROL]	183
[NETWORK STATUS]	184
[DIGITAL LINK MENU]	184
[Art-Net SETUP]	184
[Art-Net CHANNEL SETTING]	185
[Art-Net STATUS]	186

Chapter 5 Operations

Network connection	188
Connecting to the network	188
Web control function	191
Computer that can be used for setting	191
Accessing from the web browser	191

Chapter 6 Maintenance

Light source/temperature indicators	210
When an indicator lights up	210
Maintenance	212
Before maintenance	212
Maintenance	212
Troubleshooting	213
Self-diagnosis display	215

Chapter 7 Appendix

Technical information	219
PJLink protocol	219
Using Art-Net function	221
Control commands via LAN	226
<SERIAL IN>/<SERIAL OUT> terminal	229
<REMOTE 2 IN> terminal	233
Setting the IP address in standby status	233
Two-window display combination list	236
Control device password	237
Upgrade Kit	237
List of compatible signals	238
Specifications	246
Dimensions	249
Precautions for attaching the Ceiling Mount	
Bracket	250
Index	252

Read this first!

WARNING: THIS APPARATUS MUST BE EARTHED.

WARNING: To prevent damage which may result in fire or shock hazard, do not expose this appliance to rain or moisture.
This device is not intended for use in the direct field of view at visual display workplaces. To avoid incommoding reflexions at visual display workplaces this device must not be placed in the direct field of view.
The equipment is not intended for used at a video workstation in compliance BildscharbV.

The sound pressure level at the operator position is equal or less than 70 dB (A) according to ISO 7779.

WARNING:

1. Remove the plug from the mains socket when this unit is not in use for a prolonged period of time.
2. To prevent electric shock, do not remove cover. No user serviceable parts inside. Refer servicing to qualified service personnel.
3. Do not remove the earthing pin on the mains plug. This apparatus is equipped with a three prong earthing-type mains plug. This plug will only fit an earthing-type mains socket. This is a safety feature. If you are unable to insert the plug into the mains socket, contact an electrician. Do not defeat the purpose of the earthing plug.

WARNING:

This equipment is compliant with Class A of CISPR32.
In a residential environment this equipment may cause radio interference.

(for Taiwan)

WARNING:

This equipment complies with the Class A standard of CISPR32.
This is Class A information technology equipment that may cause radio frequency interference when used in a residential environment, in which the user will be required to take certain appropriate countermeasures.

CAUTION: To assure continued compliance, follow the attached installation instructions. This includes using the provided power cord and shielded interface cables when connecting to computer or peripheral devices. Also, any unauthorized changes or modifications to this equipment could void the user's authority to operate this device.

This is a device to project images onto a screen, etc., and is not intended for use as indoor lighting in a domestic environment.

Directive 2009/125/EC

WARNING: TO REDUCE THE RISK OF FIRE OR ELECTRIC SHOCK, DO NOT EXPOSE THIS PRODUCT TO RAIN OR MOISTURE.

Read this first!

WARNING: RISK OF ELECTRIC SHOCK. DON'T OPEN



or

Indicated on the projector



The lightning flash with arrowhead symbol, within an equilateral triangle, is intended to alert the user to the presence of uninsulated “dangerous voltage” within the product’s enclosure that may be of sufficient magnitude to constitute a risk of electric shock to persons.



The exclamation point within an equilateral triangle is intended to alert the user to the presence of important operating and maintenance (servicing) instructions in the literature accompanying the product.

WARNING: Do not look at the light emitted from the lens while the projector is being used.



Indicated on the projector



This projector is designed for commercial use.

**Notice on laser
(for USA and Canada)**

This projector is the Class 3R laser product that complies with IEC 60825-1:2007.

130
For North America
*Complies with 21 CFR Parts 1040.10 and 1040.11
except for deviations pursuant to Laser Notice
No.50 dated June 24,2007
IEC 60825-1:2007
LASER RADIATION
AVOID DIRECT EYE EXPOSURE
CLASS 3R LASER PRODUCT
WAVE LENGTH:1445-1465nm
MAXIMUM OUTPUT:333mW
IEC 60825-1:2007
RAYONNEMENT LASER
EXPOSITION DIRECTE DANGEREUSE POUR LES YEUX
APPAREIL A LASER DE CLASSE 3R
LONGUEURS D'ONDES:1445-1465nm
MAXIMALE DU RAYONNEMENT:333mW
DPPT11002A

RISK GROUP 3
WARNING:POSSIBLY HAZARDOUS OPTICAL RADIATION
EMITTED FROM THIS PRODUCT.
HAZARD DISTANCE: REFER TO THE OPERATING INSTRUCTIONS.
AVERTISSEMENT:DES RADIATIONS OPTIQUES NUISIBLES
PEUVENT ÊTRE EMISES PAR CE PRODUIT.
DISTANCE DU RISQUE : CONSULTEZ LE MANUEL D' UTILISATION.
WARNING:DIESES PRODUKT EMITTIERT MÖGLICHERWEISE
GEFÄHRLICHE OPTISCHE STRAHLUNG.
GEFÄHRDUNGSABSTAND: BEACHTEN SIE DIE
BEDIENUNGSANLEITUNG.
ПРЕДУПРЕЖДЕНИЕ:данная ПРОДУКЦИЯ МОЖЕТ СОЗДАВАТЬ
ОПАСНОЕ ОПТИЧЕСКОЕ ИЗЛУЧЕНИЕ.
ОПАСНОЕ РАСТОЯНИЕ: СМ. ИНСТРУКЦИИ ПО ЭКСПЛУАТАЦИИ.
경고:본 제품에서 유해한 광방사가 방출되었을 가능성이 있습니다.
위험 거리 : 사용설명서를 참조하십시오.

危険-開放時クラス4のレーザー放射 TQFX608
直接放射又は分散放射に眼又は皮膚を暴露させないこと
DANGER-CLASS 4 LASER RADIATION WHEN OPEN AVOID EYE OR
SKIN EXPOSURE TO DIRECT OR SCATTERED RADIATION
DANGER-RAYONNEMENT LASER DE CLASSE 4 - EN CAS D'OUVERTURE
EXPOSITION DANGEREUSE AU RAYONNEMENT DIRECT OU
DIFFUS DES YEUX OU DE LA PEAU

(Inside of product)

Read this first!

(for India)

This projector is the Class 1 laser product that complies with IEC/EN 60825-1:2014.



(for other countries or regions)

This projector is the Class 1 laser product that complies with IEC/EN 60825-1:2014.

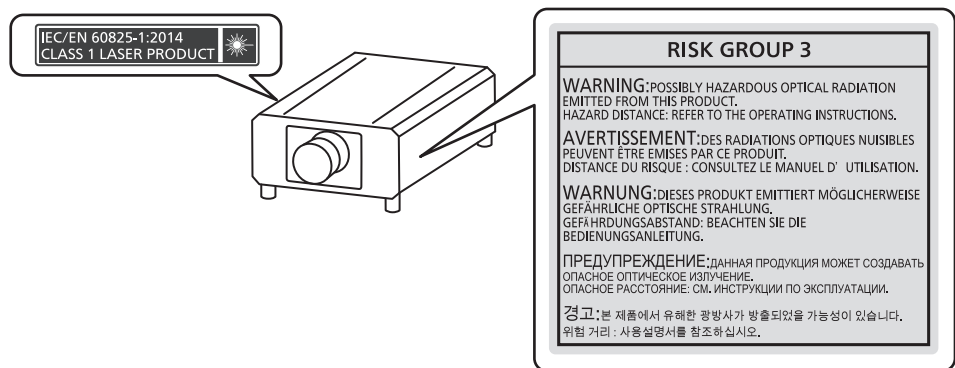

CAUTION: Use of controls or adjustments or performance of procedures other than those specified herein may result in hazardous radiation exposure.

WARNING (North America)

This projector would become Class IIIb laser product if used with interchangeable lens, types ET-D75LE8/LE30/LE40; and if used without lens hood mounted over the long lens. If you use under this condition, you must receive variance approval letter from FDA before usage.

Class IIIb levels of laser radiation are considered to be an acute hazard to the skin and eyes from direct radiation.

CAUTION (North/Middle/South America/Taiwan)

This equipment is equipped with a three-pin grounding-type power plug. Do not remove the grounding pin on the power plug. This plug will only fit a grounding-type power outlet. This is a safety feature. If you are unable to insert the plug into the outlet, contact an electrician. Do not defeat the purpose of the grounding plug.

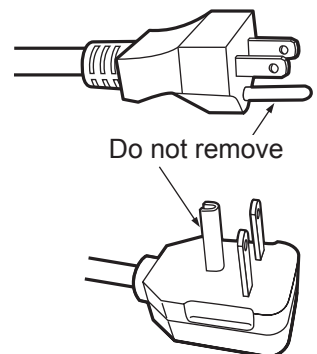

WARNING (USA and Canada)

- Not for use in a computer room as defined in the Standard for the Protection of Electronic Computer/Data Processing Equipment, ANSI/NFPA 75.
- For permanently connected equipment, a readily accessible disconnect device shall be incorporated in the building installation wiring.
- For pluggable equipment, the socket-outlet shall be installed near the equipment and shall be easily accessible.

NOTIFICATION (Canada)

This class A digital apparatus complies with Canadian ICES-003.

For USA-California Only

This product contains a CR Coin Cell Lithium Battery which contains Perchlorate Material – special handling may apply.

See www.dtsc.ca.gov/hazardouswaste/perchlorate

FCC NOTICE (USA)

Verification

Model Number: PT-RZ21K / PT-RS20K
Trade Name: Panasonic
Responsible Party: Panasonic Corporation of North America
Address: Two Riverfront Plaza, Newark, NJ 07102-5490
General Contact: <http://www.panasonic.com/support>
Projector Contact: <https://panasonic.net/cns/projector/>

This device complies with Part 15 of the FCC Rules.

Operation is subject to the following two conditions:

(1) This device may not cause harmful interference, and (2) this device must accept any interference received, including interference that may cause undesired operation.

Caution:

This equipment has been tested and found to comply with the limits for a Class A digital device, pursuant to part 15 of the FCC Rules. These limits are designed to provide reasonable protection against harmful interference when the equipment is operated in a commercial environment. This equipment generates, uses, and can radiate radio frequency energy and, if not installed and used in accordance with the instruction manual, may cause harmful interference to radio communications. Operation of this equipment in a residential area is likely to cause harmful interference in which case the user will be required to correct the interference at his own expense.

FCC Warning:

To assure continued compliance, follow the attached installation instructions. This includes using the provided power cord and shielded interface cables when connecting to computer or peripheral devices. Also, any unauthorized changes or modifications to this equipment could void the user's authority to operate this device.

IMPORTANT: THE MOLDED PLUG

FOR YOUR SAFETY, PLEASE READ THE FOLLOWING TEXT CAREFULLY.

This appliance is supplied with a molded three pin mains plug for your safety and convenience. A 13 amp fuse is fitted in this plug. Should the fuse need to be replaced, please ensure that the replacement fuse has a rating of 13 amps and that it is approved by ASTA or BSI to BS1362.

Check for the ASTA mark  or the BSI mark  on the body of the fuse.

If the plug contains a removable fuse cover, you must ensure that it is refitted when the fuse is replaced. If you lose the fuse cover, the plug must not be used until a replacement cover is obtained. A replacement fuse cover can be purchased from an Authorized Service Center.

If the fitted molded plug is unsuitable for the mains socket in your home, then the fuse should be removed and the plug cut off and disposed of safely. There is a danger of severe electrical shock if the cut off plug is inserted into any 13 amp socket.

If a new plug is to be fitted, please observe the wiring code as shown below.
If in any doubt, please consult a qualified electrician.

WARNING: THIS APPLIANCE MUST BE EARTHED.

IMPORTANT: The wires in this mains lead are colored in accordance with the following code:

Green - and - Yellow: Earth
Blue: Neutral
Brown: Live

As the colors of the wire in the mains lead of this appliance may not correspond with the colored markings identifying the terminals in your plug, proceed as follows.

The wire which is colored GREEN - AND - YELLOW must be connected to the terminal in the plug which is marked with the letter E or by the Earth symbol  or colored GREEN or GREEN - AND - YELLOW.

The wire which is colored BLUE must be connected to the terminal in the plug which is marked with the letter N or colored BLACK.

The wire which is colored BROWN must be connected to the terminal in the plug which is marked with the letter L or colored RED.

How to replace the fuse: Open the fuse compartment with a screwdriver and replace the fuse.

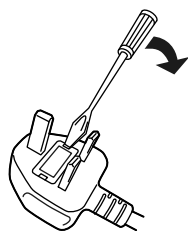

Importer's name and address within the European Union

Panasonic Marketing Europe GmbH

Panasonic Testing Centre

Winsbergring 15, 22525 Hamburg, Germany

Hazard distance (IEC 62471-5)

The distance at which the level of exposure has dropped to the level of the applicable Exposure Limit Value is known as the hazard distance or safety distance.

Do not look or stare into the light beam from a distance closer than the hazard distance (RG3 = risk group 3). Beyond this distance the light beam is considered to be safe. (RG2 = risk group 2)

RG3 level is considered to be a hazard to the eyes from direct radiation.

RG2 level does not pose any optical hazard and can be safely used in all situations.

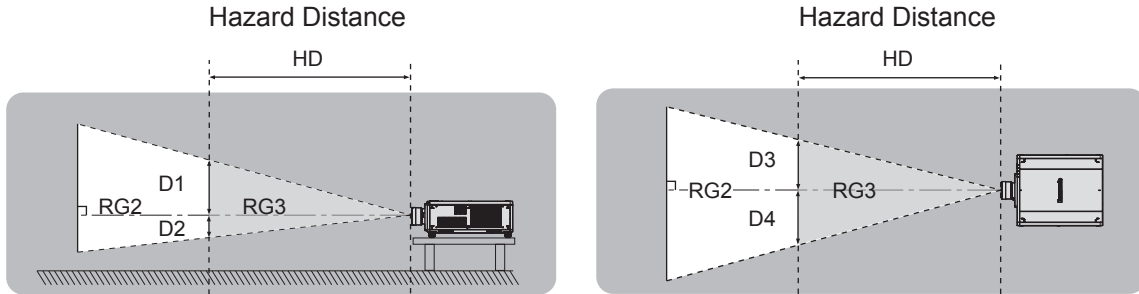

Except ET-D75LE90, ET-D75LE95

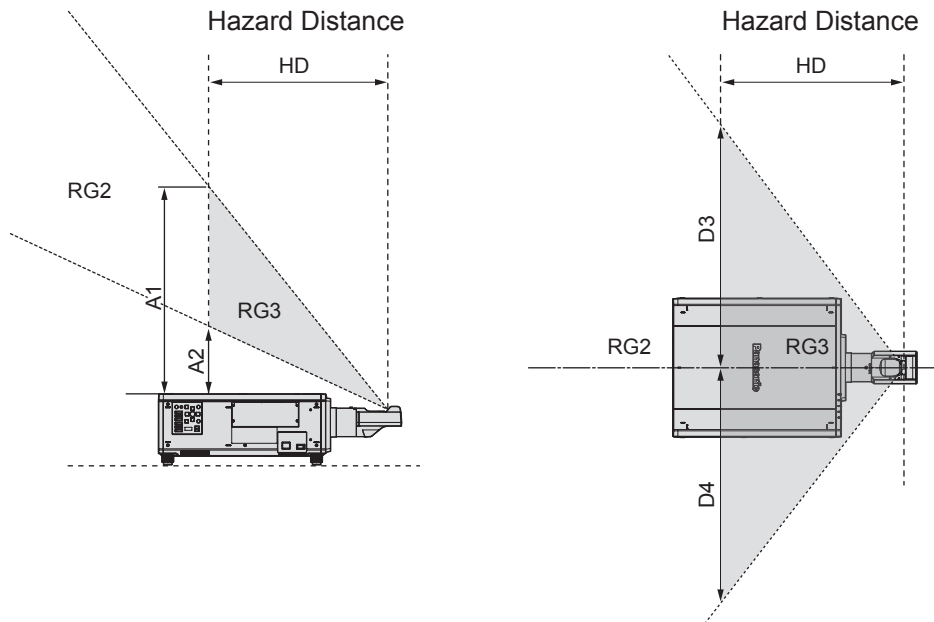

ET-D75LE90, ET-D75LE95

(Unit: m)

Lens	HD*1	D1*2 max.	D2*2 max.	D3*2 max.	D4*2 max.
ET-D75LE50	< 1.0	0.52	0.52	0.75	0.75
ET-D75LE6		0.70	0.70	0.73	0.73
ET-D75LE10	1.2	0.68	0.68	0.72	0.72
ET-D75LE20	1.7	0.73	0.73	0.78	0.78
ET-D75LE30	3.2	0.94	0.94	1.01	1.01
ET-D75LE40	4.8	0.74	0.74	0.79	0.79
ET-D75LE8	7.8	0.76	0.76	0.81	0.81
Lens	HD*1	A1*2 max.	A2*2 min.	D3*2 max.	D4*2 max.
ET-D75LE90	< 1.0	2.16	0.26	1.70	1.70
ET-D75LE95					

*1 Hazard Distance

*2 D1, D2, D3, D4, A1 and A2 changes in accordance with projection lens shift amount.
Each number in this table is worst case.

Note: Each table complies with IEC 60825-1 (2014) and IEC 62471-5 (2015)

WARNING:

■ POWER

The wall outlet or the circuit breaker shall be installed near the equipment and shall be easily accessible when problems occur. If the following problems occur, cut off the power supply immediately.

Continued use of the projector in these conditions will result in fire or electric shock, or will cause visual impairment.

- If foreign objects or water get inside the projector, cut off the power supply.
- If the projector is dropped or the cabinet is broken, cut off the power supply.
- If you notice smoke, strange smells or noise coming from the projector, cut off the power supply.

Please contact an Authorized Service Center for repairs, and do not attempt to repair the projector yourself.

During a thunderstorm, do not touch the projector or the cable.

Electric shocks can result.

Do not do anything that might damage the power cord or the power plug.

If the power cord is used while damaged, electric shocks, short-circuits or fire will result.

- Do not damage the power cord, make any modifications to it, place it near any hot objects, bend it excessively, twist it, pull it, place heavy objects on top of it or wrap it into a bundle.

Ask an Authorized Service Center to carry out any repairs to the power cord that might be necessary.

Do not use anything other than the provided power cord.

Failure to observe this will result in electric shocks or fire. Please note that if you do not use the provided power cord to ground the device on the side of the outlet, this may result in electric shocks.

Completely insert the power plug into the wall outlet and the power connector into the projector terminal.

If the plug is not inserted correctly, electric shocks or overheating will result.

- Do not use plugs which are damaged or wall outlets which are coming loose from the wall.

Do not handle the power plug and power connector with wet hands.

Failure to observe this will result in electric shocks.

Use an outlet supporting 15 A independently.

Using an outlet together with another device may result in fires due to heat generation.

Do not overload the wall outlet.

If the power supply is overloaded (ex., by using too many adapters), overheating may occur and fire will result.

Clean the power plug regularly to prevent it from becoming covered in dust.

Failure to observe this will cause a fire.

- If dust builds up on the power plug, the resulting humidity can damage the insulation.
- If not using the projector for an extended period of time, pull the power plug out from the wall outlet.

Pull the power plug out from the wall outlet and wipe it with a dry cloth regularly.

■ ON USE/INSTALLATION

Do not place the projector on soft materials such as carpets or sponge mats.

Doing so will cause the projector to overheat, which can cause burns, fire or damage to the projector.

Do not set up the projector in humid or dusty places or in places where the projector may come into contact with oily smoke or steam.

Using the projector under such conditions will result in fire, electric shocks or deterioration of components. Oil may also distort the plastic and the projector could fall such as when mounted on the ceiling.

Do not install this projector in a place which is not strong enough to take the full weight of the projector or on top of a surface which is sloped or unstable.

Failure to observe this will cause projector to fall down or tip over the projector, and severe injury or damage could result.

Do not install the projector in a location where people pass through.

People may bump into the projector or trip on the power cord, which may result in fire, electric shock, or injury.

Do not cover the air intake/exhaust ports or place anything within 500 mm (19-11/16") of them.

Doing so will cause the projector to overheat, which can cause fire or damage to the projector.

- Do not place the projector in narrow, badly ventilated places.
- Do not place the projector on cloth or papers, as these materials could be drawn into the air intake port.

WARNING:

Do not look at or place your skin into the light emitted from the lens while the projector is being used. Do not enter the projection luminous flux using an optical device (such as magnifier or mirror).

Doing so can cause burns or loss of sight.

- Strong light is emitted from the projector's lens. Do not look at or place your hands directly into this light.
- Be especially careful not to let young children look into the lens. In addition, turn off the power and switch off the main power when you are away from the projector.

Do not project an image with the lens cover of the projection lens (optional) attached.

Doing so can cause fire.

Never attempt to remodel or disassemble the projector.

High voltages can cause fire or electric shocks.

- For any inspection, adjustment and repair work, please contact an Authorized Service Center.

Do not allow metal objects, flammable objects, or liquids to enter inside of the projector. Do not allow the projector to get wet.

Doing so may cause short circuits or overheating, and result in fire, electric shock, or malfunction of the projector.

- Do not place containers of liquid or metal objects near the projector.
- If liquid enters inside of the projector, consult your dealer.
- Particular attention must be paid to children.

Use the ceiling mount bracket specified by Panasonic.

Using the ceiling mount bracket other than the specified one will result in falling accidents.

- Attach the supplied safety cable to the ceiling mount bracket to prevent the projector from falling down.

Installation work such as mounting the projector on the ceiling should only be carried out by a qualified technician.

If installation is not carried out and secured correctly, it can cause injury or accidents, such as electric shocks.

■ ACCESSORIES

Do not use or handle the batteries improperly, and refer to the following.

Failure to observe this will cause burns, batteries to leak, overheat, explode or catch fire.

- Do not use unspecified batteries.
- Do not charge dry cell batteries.
- Do not disassemble dry cell batteries.
- Do not heat the batteries or place them into water or fire.
- Do not allow the + and – terminals of the batteries to come into contact with metallic objects such as necklaces or hairpins.
- Do not store or carry batteries together with metallic objects.
- Store the batteries in a plastic bag and keep them away from metallic objects.
- Make sure the polarities (+ and –) are correct when inserting the batteries.
- Do not use a new battery together with an old battery or mix different types of batteries.
- Do not use batteries with the outer cover peeling away or removed.

If the battery fluid leaks, do not touch it with bare hands, and take the following measures if necessary.

- Battery fluid on your skin or clothing could result in skin inflammation or injury.
Rinse with clean water and seek medical advice immediately.
- Battery fluid coming in contact with your eyes could result in loss of sight.
In this case, do not rub your eyes. Rinse with clean water and seek medical advice immediately.

Do not allow children to reach the lens fixing screw, the lens hood screws, and the knurled head screws.

Accidentally swallowing them can cause physical harm.

- If swallowed, seek medical advice immediately.

Remove the depleted batteries from the remote control promptly.

- Leaving them in the unit may result in fluid leakage, overheating, or explosion of the batteries.

CAUTION:

■ POWER

When disconnecting the power cord, be sure to hold the power plug and power connector.

If the power cord itself is pulled, the lead will become damaged, and fire, short-circuits or serious electric shocks will result.

When not using the projector for an extended period of time, disconnect the power plug from the wall outlet.

Failure to do so may result in fire or electric shock.

Before replacing the projection lens, be sure to turn off the power and disconnect the power plug from the wall outlet.

- Unexpected projection of light may cause injury to eyes.
- Replacing the projection lens without removing the power plug may result in electric shock.

Disconnect the power plug from the wall outlet before carrying out any cleaning.

Failure to do so may result in electric shock.

■ ON USE/INSTALLATION

Do not place heavy objects on top of the projector.

Failure to observe this will cause the projector to become unbalanced and fall, which could result in damage or injury. The projector will be damaged or deformed.

Do not put your weight on this projector.

You could fall or the projector could break, and injury will result.

- Be especially careful not to let young children stand or sit on the projector.

Do not place the projector in extremely hot locations.

Doing so will cause the outer casing or internal components to deteriorate, or result in fire.

- Take particular care in locations exposed to direct sunlight or near heaters.

Do not place your hands in the openings beside the optical lens, while shifting the lens.

Failure to observe this could cause injury.

Do not install the projector in a location where salt pollution or corrosive gas may occur.

Doing so may result in falling due to corrosion. Also, it may result in malfunctions.

Do not stand in front of the lens while the projector is being used.

Doing so can cause damage and burns to clothing.

- Strong light is emitted from the projector's lens.

Do not place objects in front of the lens while the projector is being used.

Do not block the projection by placing an object in front of the projection lens.

Doing so can cause fire, damage to an object, or malfunction of the projector.

- Strong light is emitted from the projector's lens.

The projector must be carried or installed by two or more people.

Failure to do so may cause falling accidents.

Always disconnect all cables before moving the projector.

Moving the projector with cables still attached can damage the cables, which will cause fire or electric shocks to occur.

When mounting the projector on the ceiling, keep mounting screws and power cord from contact with metal parts inside the ceiling.

Contact with metal parts inside the ceiling can cause electric shocks.

CAUTION:

■ **ACCESSORIES**

When not using the projector for an extended period of time, remove the batteries from the remote control.

Failure to observe this will cause the batteries to leak, overheat, catch fire or explode, which may result in fire or contamination of surrounding area.

■ **MAINTENANCE**

Ask your dealer about cleaning inside the projector every 20 000 hours of usage as an estimated duration.

Continuous use while dust is accumulated inside the projector may result in fire.

- For cleaning fee, ask your dealer.

■ **VIEWING 3D VIDEO**

Those with a medical history of oversensitivity to light, heart problems, or poor physical health should not view 3D images.

This may lead to a worsening of medical conditions.

If you feel tiredness or discomfort, or other abnormality while viewing with 3D Eyewear, discontinue viewing.

Continuing use may cause health problems. Take a break as necessary.

When viewing 3D movies, aim to view one movie at a time and take a break as necessary.

When viewing 3D images, for example when playing 3D games or using a PC where two way interaction is possible, take an appropriate break every 30 to 60 minutes.

Watching for long periods of time may cause eye fatigue.

When preparing contents, use contents properly created to be used for 3D.

This may cause eye fatigue or health problems.

When viewing 3D images, pay attention to people and objects in the vicinity.

3D video may be mistaken for actual objects, and the related bodily movements can cause damage to objects and lead to injury.

Use 3D Eyewear when viewing 3D videos.

Do not tilt your head when viewing with 3D Eyewear.

Those who are near or far sighted, those with weaker eyesight in one eye, or those with astigmatism should use corrective glasses etc. when using 3D Eyewear.

If the image appears distinctly double when viewing 3D video, discontinue viewing.

Watching for long periods of time may cause eye fatigue.

View at a distance of at least three times the effective height of the screen.

Viewing at distance closer than the recommended distance may cause eye fatigue. As with movies, if there are black bands at the top and bottom of the video, view at a distance of 3 times or more of the height of the video section.

Children younger than 5 or 6 years old should not use 3D Eyewear.

As it is difficult to gauge the reactions of children to fatigue and discomfort their condition may worsen suddenly. If a child uses the 3D Eyewear, guardians should beware of the child's eyes becoming tired.

To remove the battery

Remote Control Battery

1. Press the guide and lift the cover.

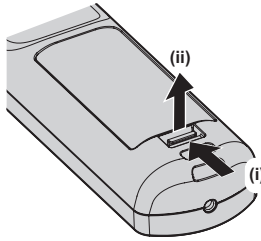

2. Remove the batteries.

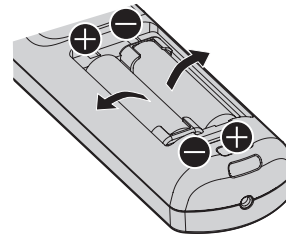

Brazil Only

Brasil Apenas

■ Manuseio de baterias usadas



BRASIL

Após o uso, as pilhas e/ou baterias deverão ser entregues ao estabelecimento comercial ou rede de assistência técnica autorizada.

Cobrir os terminais positivo (+) e negativo (-) com uma fita isolante adesiva, antes de depositar numa caixa destinada para o recolhimento. O contato entre partes metálicas pode causar vazamentos, gerar calor, romper a blindagem e produzir fogo. (Fig. 1)

Fig. 1
Como isolar os terminais

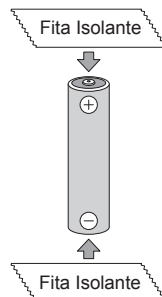

Não desmonte, não remova o invólucro, nem amasse a bateria. O gás liberado pela bateria pode irritar a garganta, danificar o lacre do invólucro ou o vazamento provocar calor, ruptura da blindagem e produzir fogo devido ao curto circuito dos terminais. Não incinere nem aqueça as baterias, elas não podem ficar expostas a temperaturas superiores a 100 °C (212 °F). O gás liberado pela bateria pode irritar a garganta, danificar o lacre do invólucro ou o vazamento provocar calor, ruptura da blindagem e produzir fogo devido ao curto circuito dos terminais provocado internamente.

Evite o contato com o líquido que vazar das baterias. Caso isto ocorra, lave bem a parte afetada com bastante água. Caso haja irritação, consulte um médico.

■ Remoção das baterias

1. Pressione a guia e levante a tampa.

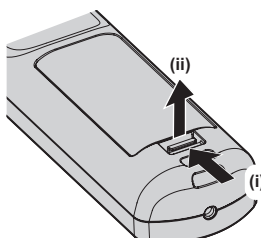

2. Remova as baterias.

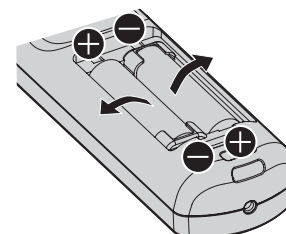

■ Trademarks

- SOLID SHINE is a trademark of Panasonic Corporation.
- Windows and Internet Explorer are registered trademarks or trademarks of Microsoft Corporation in the United States and other countries.
- Mac, macOS, and Safari are trademarks of Apple Inc., registered in the United States and other countries.
- PJLink™ is a registered trademark or pending trademark in Japan, the United States, and other countries and regions.
- DLP is a trademark or registered trademark of Texas Instruments.
- The terms HDMI and HDMI High-Definition Multimedia Interface, and the HDMI Logo are trademarks or registered trademarks of HDMI Licensing Administrator, Inc. in the United States and other countries.
- RoomView and Crestron RoomView are registered trademarks of Crestron Electronics, Inc. Crestron Connected™ and Fusion RV are trademarks of Crestron Electronics, Inc.
- HDBaseT™ is a trademark of HDBaseT Alliance.
- Art-Net™ Designed by and Copyright Artistic Licence Holdings Ltd
- DisplayPort is a trademark or registered trademark of the Video Electronics Standards Association.
- Adobe, Adobe Flash Player, and Adobe Reader are trademarks or registered trademarks of Adobe Systems Inc. in the United States and/or other countries.
- RealD 3D is a trademark of RealD Inc.
- Some of the fonts used in the on-screen menu are Ricoh bitmap fonts, which are manufactured and sold by Ricoh Company, Ltd.
- All other names, company names, and product names mentioned in this manual are trademarks or registered trademarks of their respective owners.
Please note that the ® and ™ symbols are not specified in this manual.

■ Illustrations in this manual

- Illustrations of the projector, screen, and other parts may vary from the actual product.
- Illustrations of the projector with the power cord attached are only examples. The shape of the supplied power cords varies depending on the country where you purchased the product.

■ Reference pages

- Reference pages in this manual are indicated as (➔ page 00).

■ Term

- In this manual, the “Wireless/wired remote control unit” accessory is referred to as “Remote control”.

Features of the Projector

High luminance and high contrast

- ▶ With the high efficient optical system that maximizes the output of the solid-state light source, and unique drive system, despite the compact body, high luminance of 20 000 lm and high contrast of 20 000:1*1 are realized in addition to the high color reproduction. Also, high-contrast image content supported by HDR (High Dynamic Range) can be reproduced as a projected image.

*1 When [DYNAMIC CONTRAST] is set to [3]

Supporting wide variety of usages and renderings

- ▶ In addition to the DIGITAL LINK support, Art-Net support, and abundant lineup of optional lenses, the projector has inherited installation property with wide latitude that supports all 360° direction projection utilizing the feature of solid-state light source. Advanced rendering in wide range of usages is now possible.

Long life and high reliability

- ▶ In addition to adopting the solid-state light source with long life, it has enhanced the dust resistance property of the optical unit that is sensitive to dust. By eliminating the filter, the long-period maintenance cost is reduced drastically.

Quick Steps

For details, refer to the corresponding pages.

1. **Set up the projector.**
(⇒ page 36)



2. **Attach the projection lens (optional).**
(⇒ page 49)



3. **Connect with external devices.**
(⇒ page 52)



4. **Connect the power cord.**
(⇒ page 59)



5. **Switch on the projector.**
(⇒ page 61)



6. **Make initial settings.**
(⇒ page 62)
Set the lens type.
(⇒ page 73)
Execute the lens calibration.
(⇒ page 73)
 - Take this step when you switch on the power for the first time after purchasing the projector.



7. **Select the input signal.**
(⇒ page 70)



8. **Adjust the image.**
(⇒ page 71)

Chapter 1 Preparation

This chapter describes things you need to know or check before using the projector.

Precautions for use

Cautions when transporting

- Transport the projector with two or more people. Failure to do so may drop the projector, which may result in damage or deformation of the projector, or injury.
- When transporting the projector, hold it securely by its bottom and avoid excessive vibration and impact. Failure to do so may cause a failure due to the damaged internal components.
- Do not transport the projector with the adjustable feet extended. Doing so may damage the adjustable feet.

Cautions when installing

■ Do not set up the projector outdoors.

The projector is designed for indoor use only.

■ Do not set up the projector in the following locations.

- Places where vibration and impacts occur such as in a car or vehicle: Doing so may cause damage to internal components or malfunction.
- Location close to sea or where corrosive gas may occur: The projector may fall due to corrosion. Also, failure to do so may shorten the life of the components and result in malfunctions.
- Near the exhaust of an air conditioner: Depending on the conditions of use, the screen may fluctuate in rare cases due to the heated air from the air exhaust port or the hot or cooled air. Make sure that the exhaust from the projector or other equipment, or the air from the air conditioner does not blow toward the front of the projector.
- Places with sharp temperature fluctuations such as near lights (studio lamps): Doing so may shorten the life of the light source, or result in deformation of the projector due to heat, which may cause malfunctions. Follow the operating environment temperature of the projector.
- Near high-voltage power lines or near motors: Doing so may interfere with the operation of the projector.
- Places where there is high-power laser equipment: Directing a laser beam onto the projection lens surface causes damage to the DLP chips.

■ Ask a qualified technician or your dealer for the installation work such as installing to a ceiling, etc.

To ensure projector performance and safety, ask a qualified technician or your dealer when installing to a ceiling or in a high place.

■ Ask a qualified technician or your dealer to install the cable wiring for DIGITAL LINK connection.

Image and sound may be disrupted if cable transmission characteristics cannot be obtained due to inadequate installation.

■ The projector may not work properly due to strong radio wave from the broadcast station or the radio.

If there is any facility or equipment which outputs strong radio waves near the installation location, install the projector at a location sufficiently far from the source of the radio waves. Or, wrap the LAN cable connected to the <DIGITAL LINK/LAN> terminal using a piece of metal foil or a metal pipe which is grounded at both ends.

■ Focus adjustment

The high clarity projection lens is thermally affected by the light from the light source, making the focus unstable in the period just after switching on the power.

It is recommended to perform the focus adjustment after 30 minutes have elapsed with the focus test pattern displayed. For details of the test pattern, refer to “[TEST PATTERN] menu” (➔ page 174).

■ Do not install the projector at an altitude of 4 200 m (13 780') or higher above sea level.

■ **Do not use the projector in a location that the ambient temperature exceeds 50 °C (122 °F).**

Using the projector in a location that the altitude is too high or the ambient temperature is too high may reduce the life of the components or result in malfunctions.

Upper limit of the operating environment temperature varies depending on the altitude above sea level.

When using the projector at an altitude between 0 m (0') and 1 400 m (4 593') above sea level: 0 °C (32 °F) to 50 °C (122 °F)

When using the projector at an altitude between 1 400 m (4 593') and 4 200 m (13 780') above sea level: 0 °C (32 °F) to 45 °C (113 °F)

■ **Projection in all 360° direction is possible.**

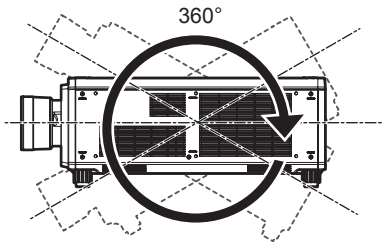

360° vertically

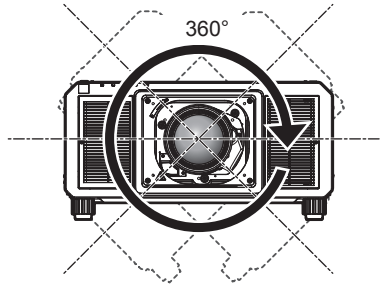

360° horizontally

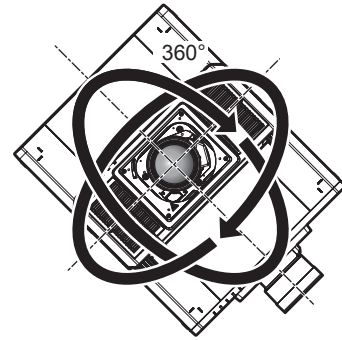

360° tilted
(combination of vertical and horizontal)

Cautions when setting up the projector

- Install the projector in a place or with a mount that can sufficiently tolerate the weight. The position of the projected image may shift if the strength is not sufficient.
- Use the adjustable feet only for the floor standing installation and for adjusting the angle. Using them for other purposes may damage the projector.
- The adjustable feet can be removed if not needed in the installation. However, do not use the screw holes where the adjustable feet were removed to fix the projector to a mount.
Also, do not attach any screws not instructed in the operating instructions of the optional accessories into the screw holes where the adjustable feet are removed. Doing so may damage the projector.
- When using the projector in any method other than the floor installation using the adjustable feet or ceiling mounting installation using the Ceiling Mount Bracket, remove the four adjustable feet and use the six screw holes (as shown in the figure) to fix the projector to a mount.

- Use a torque screwdriver or Allen torque wrench to tighten the fixing screws to their specified tightening torques. Do not use electric screwdrivers or impact screwdrivers.
(Screw diameter: M6, tapping depth inside the projector: 27 mm (1-1/16"), screw tightening torque: 4 ± 0.5 N·m)

Unit: mm

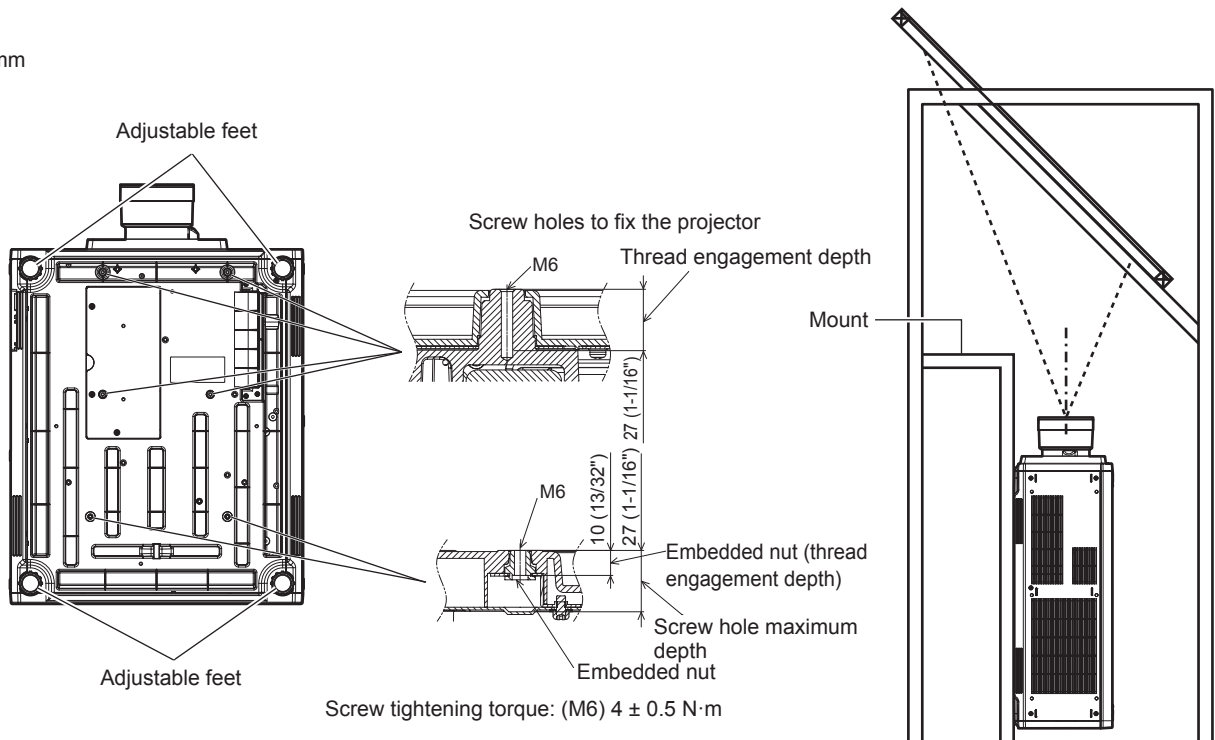

Screw tightening torque: (M6) 4 ± 0.5 N·m

Positions of screw holes to fix projector and adjustable feet

- When using two projectors stacked on each other, take a measure to prevent falling just in case. Or, use the optional Frame (Model No.: ET-PFD510).
- Do not stack three or more projectors.
- Do not use the projector supporting it by the top.
- Do not block the ventilation ports (intake and exhaust) of the projector.

- Prevent hot and cool air from the air conditioning system to blow directly to the ventilation ports (intake and exhaust) of the projector.

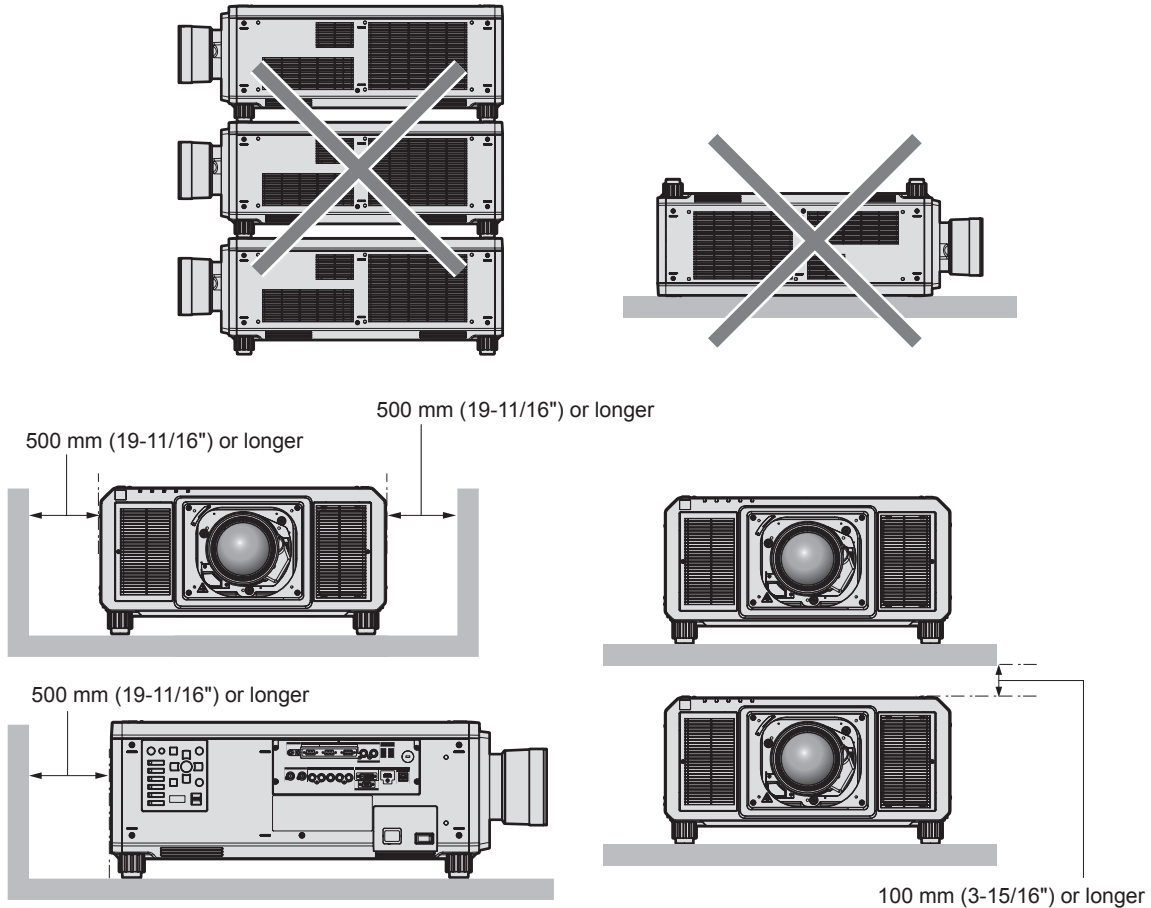

- Do not install the projector in a confined space.
When installing the projector in a confined space, provide air conditioning or ventilation separately. Exhaust heat may accumulate when the ventilation is not enough, triggering the protection circuit of the projector.
- Panasonic takes no responsibility for any damage to the product caused by an inappropriate choice of location for installing the projector, even if the warranty period of the product has not expired.

Security

When using this product, take safety measures against the following incidents.

- Personal information being leaked via this product
- Unauthorized operation of this product by a malicious third party
- Interfering or stopping of this product by a malicious third party

Take sufficient security measures.

- Make your password difficult to guess as much as possible.
- Change your password periodically. A password can be set in the [SECURITY] menu → [SECURITY PASSWORD CHANGE].
- Panasonic Corporation or its affiliate companies will never ask for your password directly. Do not divulge your password in case you receive such inquiries.
- The connecting network must be secured by a firewall, etc.
- Set a password for the web control and restrict the users who can log in. A password for the web control can be set in the [Change password] page of the web control screen.

DIGITAL LINK

“DIGITAL LINK” is a technology to transmit the video, audio, Ethernet, and serial control signals using a twisted pair cable by adding unique functions by Panasonic to the HDBaseT™ communication standard formulated by HDBaseT Alliance.

This projector supports the optional Panasonic DIGITAL LINK output supported device (Model No.: ET-YFB100G, ET-YFB200G) and peripheral devices by other manufacturers (twisted-pair-cable transmitters such as the “XTP transmitter” of Extron Electronics) that use the same HDBaseT™ standard. For the devices of other manufacturers that the operation has been verified with this projector, visit the Panasonic website (<https://panasonic.net/cns/projector/>). Note that the verification for devices of other manufacturers has been made for the items set by Panasonic Corporation, and not all the operations have been verified. For operation or performance problems caused by the devices of other manufacturers, contact the respective manufacturers. This projector does not support audio transmission because it is not equipped with audio function.

Art-Net

“Art-Net” is an Ethernet communication protocol based on the TCP/IP protocol.

By using the DMX controller and the application software, illumination and stage system can be controlled. Art-Net is made based on DMX512 communication protocol.

Application software supported by the projector

The projector supports following application software. For details or downloading each application software, visit the Panasonic website (<https://panasonic.net/cns/projector/>).

- **Logo Transfer Software**

This software transfers the original image, such as company logo, which is projected at the start, to the projector.

- **Smart Projector Control**

This software sets and adjusts the projector connected via LAN using a smartphone or a tablet.

- **Multi Monitoring & Control Software**

This software monitors and controls the multiple display devices (projector and flat panel display) connected to the Intranet.

- **Early Warning Software**

This plug-in software monitors the status of the display devices and their peripherals within an intranet, and notifies of abnormality of such equipment and detects the signs of possible abnormality. “Early Warning Software” is pre-installed in the “Multi Monitoring & Control Software”. To use the early warning function of this plug-in software, install “Multi Monitoring & Control Software” in the PC to be used. By enabling the early warning function, it will notify of the approximate time to replace the consumables for the display devices, to clean each part of the display devices, and to replace the components of the display devices, allowing to execute maintenance in advance.

The early warning function can be used by registering maximum of 2048 display devices free of charge for 90 days after installing the “Multi Monitoring & Control Software” into a PC. To continuously use after the 90 days, it is necessary to purchase the license of “Early Warning Software” (ET-SWA100 Series) and perform the activation. Also, depending on the type of license, the number of display devices that can be registered for monitoring varies. For details, refer to the Operating Instructions of “Multi Monitoring & Control Software”.

Storing

To store the projector, store in a dry room.

Disposal

To dispose of the product, ask your local authorities or dealer for correct methods of disposal. Also, dispose of the product without disassembling.

Cautions on use

■ To get a good picture quality

In order to view a beautiful image in higher contrast, prepare an appropriate environment. Draw curtains or blinds over windows and turn off any lights near the screen to prevent outside light or light from indoor lamps from shining onto the screen.

■ **Do not touch the surface of the projection lens with your bare hands.**

If the surface of the projection lens becomes dirty from fingerprints or anything else, this will be magnified and projected onto the screen.

Attach the supplied lens cover to the optional projection lens when not using the projector.

■ **DLP chips**

- The DLP chips are precision-made. Note that in rare cases, pixels of high precision could be missing or always lit. Such a phenomenon does not indicate malfunction.
- Directing a high-power laser beam onto the projection lens surface can damage the DLP chips.

■ **Do not move the projector or subject it to vibration or impact while it is operating.**

Doing so may shorten the life of the built-in motor.

■ **Light source**

The light source of the projector uses lasers, and has the following characteristics.

- Depending on the operating environment temperature, the luminance of the light source will decrease.

The higher the temperature becomes, the more the luminance of the light source decreases.

- The luminance of the light source will decrease by duration of usage.

If brightness is noticeably reduced and the light source does not turn on, ask your dealer to clean inside the projector or replace the light source unit.

■ **Computer and external device connections**

- When connecting a computer or an external device, read this manual carefully regarding the use of power cords and shielded cables as well.

■ **Viewing 3D images**

The projector can display the 3D video signal input in various formats such as “frame packing”, “side by side”, etc. You are required to prepare external devices for viewing 3D images (such as 3D eyewear, video signal output devices) which are suitable for your 3D system. Connections of the projector and external devices vary depends on the 3D system to be used, see the operating instructions of external devices you use.

Refer to “List of 3D compatible signals” (➡ page 243) for the types of 3D video signals that can be used with the projector.

Accessories

Make sure that the following accessories are provided with your projector. Numbers enclosed in < > show the number of accessories.

Wireless/wired remote control unit <1> (N2QAYB001052 [N2QAYB001176])



(N2QAYB001176 is the same remote control unit as N2QAYB001052.)

Power cord

(K2CM3YY00007): for 200 V - 240 V

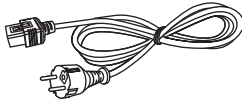

(K2CT3YY00053): for 200 V - 240 V



(K2CG3YY00035): for 200 V - 240 V

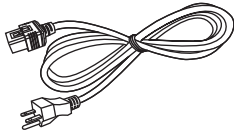

(K2CG3YY00189): for 110 V - 120 V

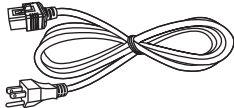

(K2CZ3YY00058): for 200 V - 240 V

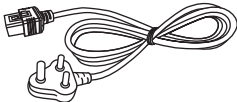

(K2CZ3YY00032): for 200 V - 240 V

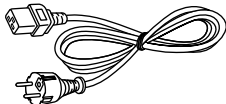

For Taiwan

(K2CZ3YY00081) <1>

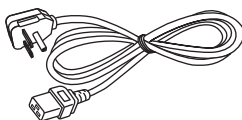

Lens hole cover <1> (1GE1RZ21K)

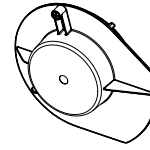

(Attached to the product at the time of purchase)

CD-ROM <1> (1JK1RZ21KE)

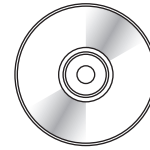

(Operating Instructions are included.)

AA/R6 or AA/LR6 battery <2>

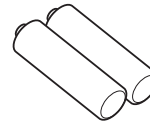

(For remote control unit)

Lens fixing screw <1> (XYN4+J18FJ)



Lens hood 1 <1> (7MHRZ31KU)

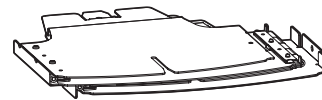

Lens hood 2 <1> (8MHRZ31KU)

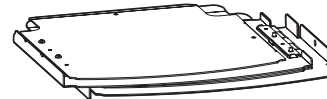

Lens hood mounting plate 1 <1> (DPMH1090ZA)

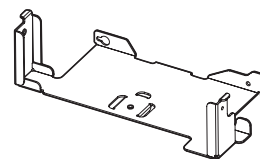

Lens hood mounting plate 2 <1>
(DPMH1089ZA)

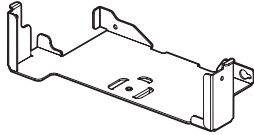

Lens hood screw <6>
(XYN4+F8FJK)



Knurled head screw <6>
(DPHD1026ZA)



Attention

- After unpacking the projector, discard the power cord cap and packaging material properly.
- Do not use the supplied power cord for devices other than this projector.
- For missing accessories, consult your dealer.
- Store small parts in an appropriate manner, and keep them away from small children.

Note

- The lens hood needs to be mounted to the projector when using the projector in combination with the projection lenses below in the North American region. Always ask a qualified technician or your dealer to attach these projection lenses or to mount the lens hood.
Projection lens: ET-D75LE8, ET-D75LE30, ET-D75LE40
The lens hood is assembled and mounted to the projector using the following supplied components.
Lens hood 1, Lens hood 2, Lens hood mounting plate 1, Lens hood mounting plate 2, Lens hood screws, Knurled head screws
For the assembly and attachment, refer to the separate document “Mounting the lens hood”. The components and document of the lens hood may not be supplied depending on the country or region where you purchased the product.
- The type and number of the supplied power cords vary depending on the country or region where you purchased the product.
- The model numbers of accessories are subject to change without prior notice.

Optional accessories

Optional accessories (product name)	Model No.	
Projection lens	Zoom Lens	ET-D75LE6, ET-D75LE8, ET-D75LE10, ET-D75LE20, ET-D75LE30, ET-D75LE40
	Fixed-focus Lens	ET-D75LE50, ET-D75LE95
Stepping Motor Kit	ET-D75MKS10	
Lens Fixed Attachment	ET-PLF10	
Ceiling Mount Bracket	ET-PKD520H (for High Ceilings), ET-PKD520S (for Low Ceilings), ET-PKD520B (Projector Mount Bracket)	
Frame	ET-PFD510	
Early Warning Software (Basic license/3-year license)	ET-SWA100 Series*1	
Upgrade Kit	ET-UK20	
Auto Screen Adjustment Upgrade Kit	ET-CUK10	
Auto Screen Adjustment Upgrade Kit (PC)	ET-CUK10P	
Digital Interface Box	ET-YFB100G	
DIGITAL LINK Switcher	ET-YFB200G	

*1 The suffix of the Model No. differs according to the license type.

Note

- The Fixed-focus Lens (Model No.: ET-D75LE90) (production discontinued) can also be used.
- The Stepping Motor Kit (Model No.: ET-D75MKS10) is a product to replace the standard DC motor unit installed in the Zoom Lens (Model No.: ET-D75LE6, ET-D75LE8, ET-D75LE10, ET-D75LE20, ET-D75LE30, ET-D75LE40) with the stepping motor unit. For how to replace the motor of the Zoom Lens, refer to the Operating Instructions of the Stepping Motor Kit.
- The model numbers of optional accessories are subject to change without prior notice.
- The optional accessories described in this document are as of September 2017. Optional accessories may be added or changed without prior notice.
For the latest information, visit the Panasonic website (<https://panasonic.net/cns/projector/>).

About your projector

Remote control

■ Front

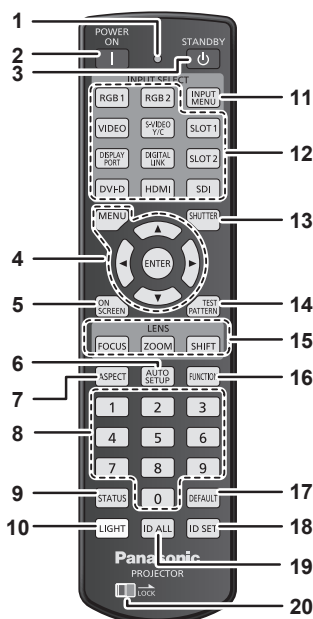

■ Top

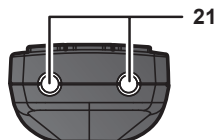

■ Bottom

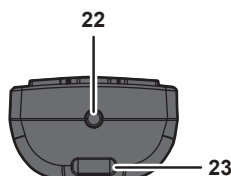

A strap can be attached depending on the usage.

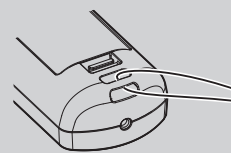

- 1 **Remote control indicator**
Blinks if any button in the remote control is pressed.
- 2 **Power on <|> button**
Sets the projector to projection mode when the <MAIN POWER> switch on the projector is set to <ON> and the power is turned off (standby mode).
- 3 **Power standby <⏻> button**
Sets the projector to the state where the projector is turned off (standby mode) when the <MAIN POWER> switch on the projector is set to <ON> and in projection mode.
- 4 **<MENU> button/<ENTER> button/▲▼◀▶ buttons**
Used to navigate through the menu screen. (➔ page 85)
- 5 **<ON SCREEN> button**
Switches the on-screen display function on (display) or off (hide). (➔ page 80)
- 6 **<AUTO SETUP> button**
Automatically adjusts the image display position while projecting the image.
[PROGRESS] is displayed while in automatic adjustment. (➔ page 81)
- 7 **<ASPECT> button**
Switches the aspect ratio of the image. (➔ page 81)
- 8 **Number (<0> - <9>) buttons**
Used for entering an ID number or a password in a multiple projector environment.
- 9 **<STATUS> button**
Displays the projector information.
- 10 **<LIGHT> button**
Pressing this button lights up the remote control buttons. The lights will go off when the remote control operation goes idle for 10 seconds.
- 11 **<INPUT MENU> button**
Displays the input selection screen. (➔ page 71)
- 12 **Input selection buttons (<RGB1>, <RGB2>, <VIDEO>, <S-VIDEO Y/C>, <DIGITAL LINK>, <DVI-D>, <HDMI>, <SDI>)**
Switches the input signal to project. (➔ page 70)
The <DISPLAY PORT> button, the <SLOT1> button, and the <SLOT2> button are not used with the projector.
- 13 **<SHUTTER> button**
Used to temporarily turn off the image. (➔ page 80)
- 14 **<TEST PATTERN> button**
Displays the test pattern. (➔ page 82)
- 15 **Lens buttons (<FOCUS>, <ZOOM>, <SHIFT>)**
Adjusts the focus, zoom, and lens shift. (➔ page 71)
- 16 **<FUNCTION> button**
Assigns a frequently used operation as a shortcut button. (➔ page 81)
- 17 **<DEFAULT> button**
Resets the content of the sub-menu to the factory default. (➔ page 86)
- 18 **<ID SET> button**
Sets the ID number of the remote control in a multiple projector environment. (➔ page 33)
- 19 **<ID ALL> button**
Used to simultaneously control all the projectors with a single remote control in a multiple projector environment. (➔ page 33)
- 20 **<LOCK> button**
Used to prevent unintended operation by careless pressing of the buttons and prevent draining the remote control batteries. Operation of each button on the remote control is disabled by sliding the <LOCK> button toward the arrow.
- 21 **Remote control signal transmitter**
- 22 **Remote control wired terminal**
This is a terminal used to connect to the projector via a cable when the remote control is used as a wired remote control. (➔ page 34)
- 23 **Strap hole**

Attention

- Do not drop the remote control.

- Avoid contact with liquids or moisture.
- Do not attempt to modify or disassemble the remote control.
- Do not swing the remote control holding onto the strap when a strap is attached.
- Observe the following instructions that are indicated on the caution label at the back of the remote control:
 - Do not use old battery with new one.
 - Do not use batteries other than the type specified.
 - Be sure the batteries are inserted properly.

For other instructions, read the instructions related to batteries that are described in "Read this first!".

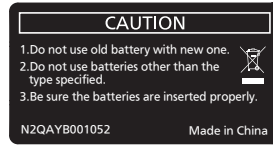

Caution label at the back of the remote control

Note

- When operating the remote control by directly pointing the remote control signal receiver of the projector, operate the remote control at a distance approx. 30 m (98'5") or shorter from the remote control signal receiver. The remote control can control at angles of up to $\pm 15^\circ$ vertically and $\pm 30^\circ$ horizontally, but the effective control range may be reduced.
- If there are any obstacles between the remote control and the remote control signal receiver, the remote control may not operate properly.
- The signal will be reflected off the screen. However, the operating range may be limited from light reflection loss due to the screen material.
- If the remote control signal receiver directly receives strong light, such as fluorescent light, the remote control may not operate properly. Use it in a place distant from the light source.
- The power indicator <ON (G)/STANDBY (R)> will blink if the projector receives a remote control signal.

Projector body

■ Front

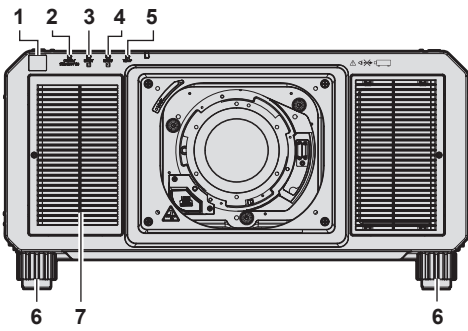

■ Side

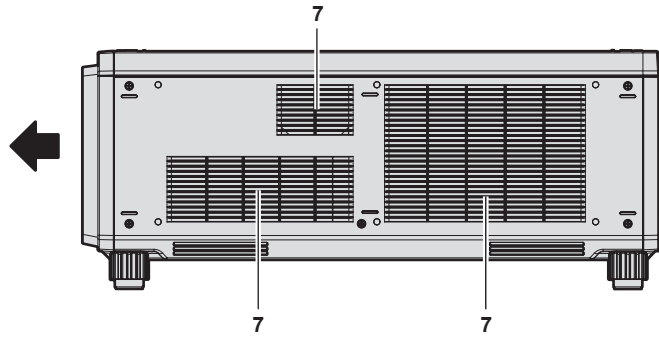

■ Rear

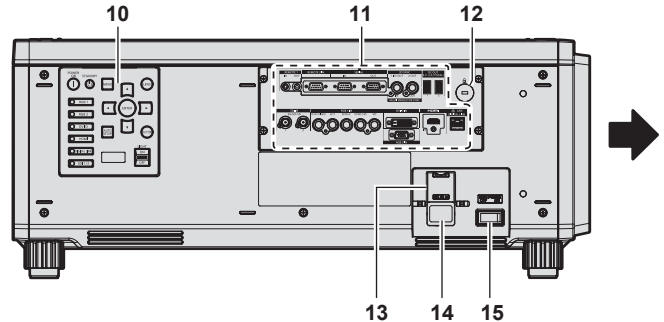
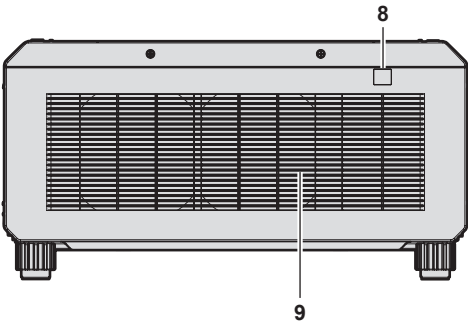

■ Bottom

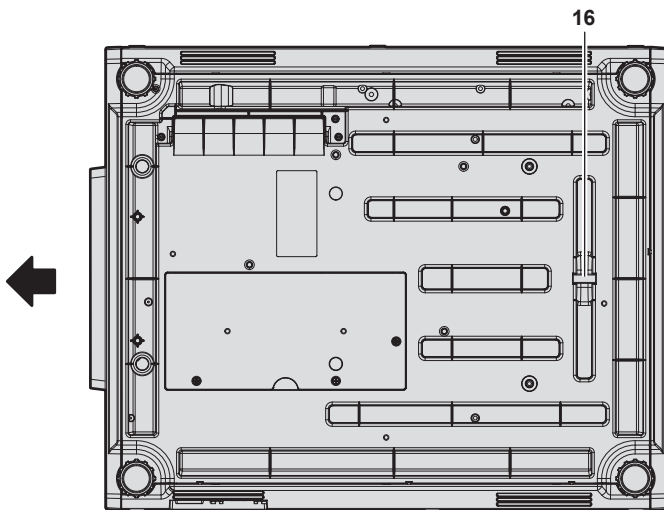

← : Projection direction

- 1 Remote control signal receiver (front)
- 2 Power indicator <ON (G)/STANDBY (R)>
Indicates the status of the power.

- 3 Light source indicator <LIGHT1>
Indicates the status of light source 1.
- 4 Light source indicator <LIGHT2>
Indicates the status of light source 2.
- 5 Temperature indicator <TEMP>
Indicates the internal temperature status.
- 6 Adjustable feet
Adjusts the projection angle.
- 7 Air intake port
- 8 Remote control signal receiver (rear)
- 9 Air exhaust port
- 10 Control panel (➔ page 31)
- 11 Connecting terminals (➔ page 32)
- 12 Security slot
This security slot is compatible with the Kensington security cables.
- 13 Power cord holder
(Except for PT-RZ21KD)
- 14 <AC IN> terminal
Connect the supplied power cord.
- 15 <MAIN POWER> switch
Turns on/off the main power.
- 16 Security bar
A wire, etc., can be attached to prevent theft.

Attention

- Do not block the ventilation ports (intake and exhaust) of the projector.

■ Control panel

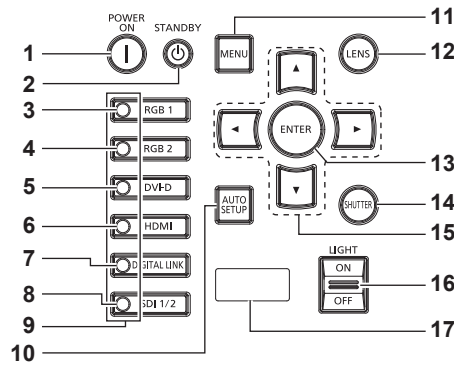

1 Power on <|> button

Sets the projector to projection mode when the <MAIN POWER> switch on the projector is set to <ON> and the power is turned off (standby mode).

2 Power standby <⏻> button

Sets the projector to the state where the projector is turned off (standby mode) when the <MAIN POWER> switch on the projector is set to <ON> and in projection mode.

3 <RGB1> button

Switches the input to RGB1.

4 <RGB2> button

Switches the input to RGB2.

5 <DVI-D> button

Switches the input to DVI-D.

6 <HDMI> button

Switches the input to HDMI.

7 <DIGITAL LINK> button

Switches the input to DIGITAL LINK.

8 <SDI 1/2> button

Switches the input to SDI.

9 Input selection terminal indicator

Indicator that shows the selected input terminal. This indicator lights up when a video signal is being input to the selected terminal, and blinks when there is no video signal being input.

10 <AUTO SETUP> button

Automatically adjusts the image display position while the image is projected. [PROGRESS] is displayed while in automatic adjustment. (➡ page 81)

11 <MENU> button

Displays or hides the main menu. (➡ page 85)

Returns to the previous menu when a sub-menu is displayed. If you press the <MENU> button on the control panel for at least three seconds while the on-screen display is off (hidden), the on-screen display is turned on.

12 <LENS> button

Adjusts the focus, zoom, and lens shift.

13 <ENTER> button

Determines and executes an item in the menu screen.

14 <SHUTTER> button

Used to temporarily turn off the image. (➡ page 80)

15 ▲▼◀▶ buttons

Used to select items in the menu screen, change settings, and adjust levels.

Also used to enter a password in [SECURITY] or enter characters.

16 <LIGHT> switch

This is a light switch for the connecting terminals and control panel.

17 Self-diagnosis display

Displays the value of the input supply voltage, automatically displays the symbol of error or warning when it occurs, or displays the IP address.

(➡ pages 83, 215, 233)

■ Connecting terminals

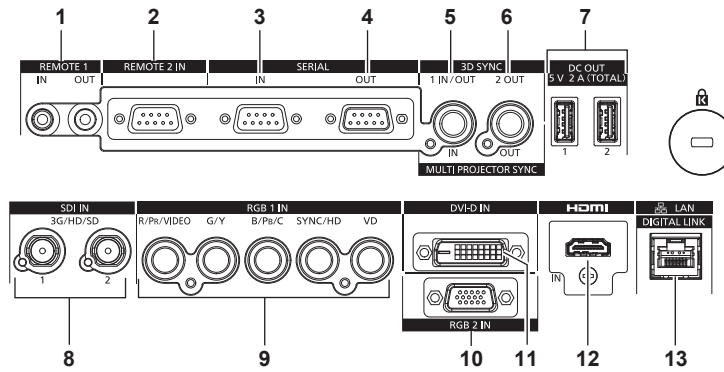

- 1 **<REMOTE 1 IN> terminal/<REMOTE 1 OUT> terminal**
These are terminals to connect the remote control for serial control in a multiple projector environment.
- 2 **<REMOTE 2 IN> terminal**
This is a terminal to remotely control the projector using the external control circuit.
- 3 **<SERIAL IN> terminal**
This is the RS-232C compatible terminal to externally control the projector by connecting a computer.
- 4 **<SERIAL OUT> terminal**
This is a terminal to output the signal connected to the <SERIAL IN> terminal.
- 5 **<MULTI PROJECTOR SYNC IN> terminal/<3D SYNC 1 IN/OUT> terminal (dual purpose)**
This terminal is used to connect multiple projectors when balancing the contrast as a combined screen or synchronizing the effects using the shutter function including the fade in/fade out with a system using multiple projectors.
This terminal is also used to input or output control signals when using the projector in 3D systems.
- 6 **<MULTI PROJECTOR SYNC OUT> terminal/<3D SYNC 2 OUT> terminal (dual purpose)**
This terminal is used to connect multiple projectors when balancing the contrast as a combined screen or synchronizing the effects using the shutter function including the fade in/fade out with a system using multiple projectors.
This terminal is also used to output control signals when using the projector in 3D systems.
- 7 **<DC OUT 1> terminal/<DC OUT 2> terminal**
This is the USB terminal dedicated for power supply. (DC 5 V, total 2 A)
Use this terminal when a power supply is required to wireless display adapters and wireless LAN Ethernet converters, etc.
- 8 **<SDI IN 1> terminal/<SDI IN 2> terminal**
These are terminals to input SDI signals.
- 9 **<RGB 1 IN> terminals (<R/P_R/VIDEO>, <G/Y>, <B/P_B/C>, <SYNC/HD>, <VD>)**
These are terminals to input RGB signals, YC_BC_R/YP_BP_R signals, Y/C signals, or video signals.
- 10 **<RGB 2 IN> terminal**
This is a terminal to input RGB signals or YC_BC_R/YP_BP_R signals.
- 11 **<DVI-D IN> terminal**
This is the terminal to input DVI-D signals.
- 12 **<HDMI IN> terminal**
This is the terminal to input HDMI signals.
- 13 **<DIGITAL LINK/LAN> terminal**
This is the LAN terminal to connect to the network. This is also used when connecting a video signal transmission device via the LAN terminal.

Attention

- When a LAN cable is directly connected to the projector, the network connection must be made indoors.
- When the [PROJECTOR SETUP] menu → [STANDBY MODE] is set to [NORMAL], power can be supplied by using the <DC OUT 1> terminal or the <DC OUT 2> terminal even while the projector is in standby mode. If [ECO] is set, power cannot be supplied in standby mode.

Preparing the remote control

Inserting and removing the batteries

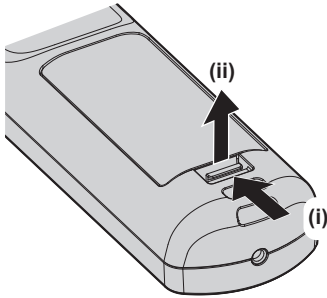

Fig. 1

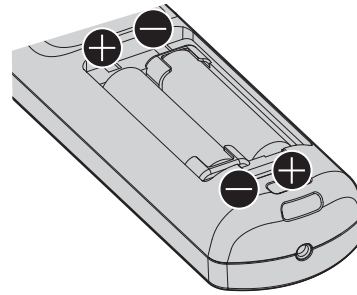

Fig. 2

- 1) Open the cover. (Fig. 1)
- 2) Insert the batteries and close the cover (insert the \ominus side first). (Fig. 2)
 - When removing the batteries, perform the steps in reverse order.

When using the multiple projectors

When you use the multiple projectors together, you can operate all the projectors simultaneously or each projector individually using single remote control, if a unique ID number is assigned to each projector.

When using the projectors by setting the ID numbers, set the ID number of the projector body after initial settings have been completed. Then, set the ID number of the remote control. For initial settings, refer to “When the initial setting screen is displayed” (➔ page 62).

The factory default ID number of the projector (projector body and remote control) is set to [ALL], so you can use it as it is. Set the ID numbers of the projector body and remote control as necessary.

For details on setting the ID number of the remote control, refer to “Setting ID number of the remote control” (➔ page 83).

Note

- Set the ID number of the projector body from the [PROJECTOR SETUP] menu → [PROJECTOR ID].

Connecting the remote control to the projector with a cable

If you control the multiple projectors with a single remote control, use commercially available M3 stereo mini jack cables to connect to the <REMOTE 1 IN>/<REMOTE 1 OUT> terminals of the projectors.

The remote control is effective even in places where an obstacle stands in the light path or where devices are susceptible to outside light.

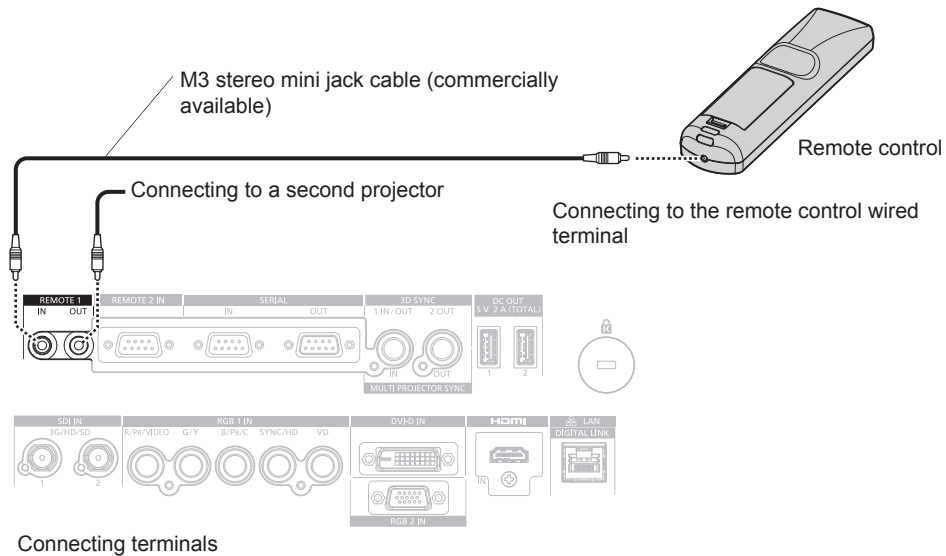

Attention

- Use a cable that is 15 m (49'3") or shorter, with 2 core shielded. The remote control may not operate when the length of the cable exceeds 15 m (49'3") or when the shielding of the cable is inadequate.

Chapter 2 **Getting Started**

This chapter describes things you need to do before using the projector such as the setup and connections.

Setting up

Usable outlet

This projector supports AC100 V to AC120 V, and AC 200 V to AC 240 V as the power supply. A grounding outlet supporting 15 A is required with either voltage.

The shape of the usable outlet differs depending on the power supply. Following illustrations are examples.



2P/3W 15 A 250 V

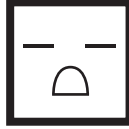

2P/3W 15 A 250 V

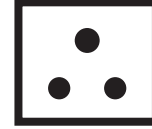

2P/3W 15 A 250 V



2P/3W 15 A 250 V



2P/3W 15 A 125 V

Attention

- Use the supplied power cord and ground at the outlet.
- Use the power cord matching the used power supply voltage and outlet shape.

Note

- The light output will decrease to approximately 1/2 when using the projector with AC 100 V to AC 120 V.
- The supplied power cords vary depending on the country or region where you purchased the product.

Installation mode

The installation modes of the projector are as follows. Set [FRONT/REAR]/[FLOOR/CEILING] in the [PROJECTOR SETUP] menu → [PROJECTION METHOD] (➔ page 139) depending on the installation mode.

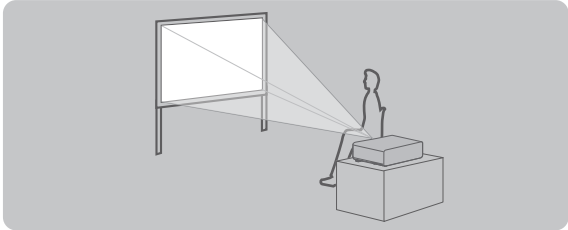
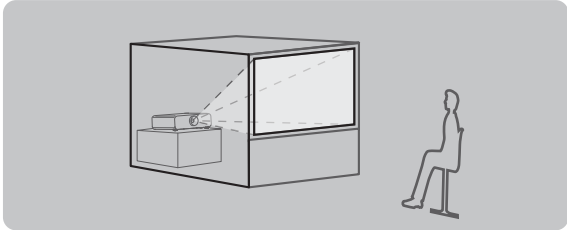
Setting on a desk/floor and projecting forward		Setting on a desk/floor and projecting from rear (Using the translucent screen)	
			
Menu item	Setting value	Menu item	Setting value
[FRONT/REAR]	[FRONT]	[FRONT/REAR]	[REAR]
[FLOOR/CEILING]	[AUTO] or [FLOOR]	[FLOOR/CEILING]	[AUTO] or [FLOOR]

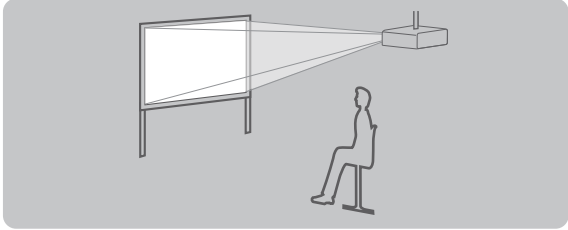
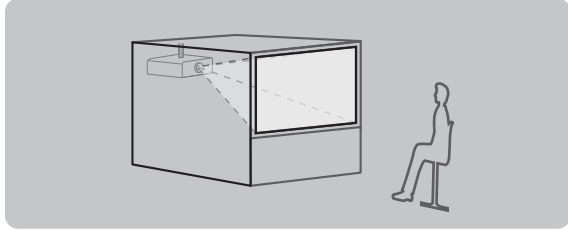
Mounting on the ceiling and projecting forward		Mounting on the ceiling and projecting from rear (Using the translucent screen)	
			
Menu item	Setting value	Menu item	Setting value
[FRONT/REAR]	[FRONT]	[FRONT/REAR]	[REAR]
[FLOOR/CEILING]	[AUTO] or [CEILING]	[FLOOR/CEILING]	[AUTO] or [CEILING]

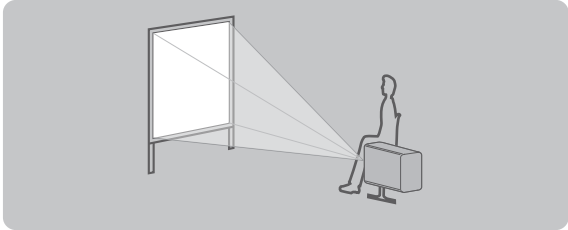
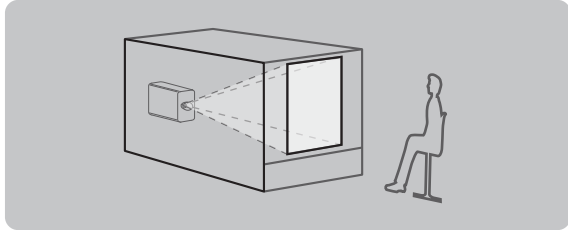
Portrait setting and projecting forward		Portrait setting and projecting from the rear (Using the translucent screen)	
			
Menu item	Setting value	Menu item	Setting value
[FRONT/REAR]	[FRONT]	[FRONT/REAR]	[REAR]
[FLOOR/CEILING]	Set in accordance with the image to project.	[FLOOR/CEILING]	Set in accordance with the image to project.

Note

- In the portrait setting, the on-screen menu is displayed sideways. To display the on-screen menu vertically, change the [OSD ROTATION] setting in the [DISPLAY OPTION] menu → [ON-SCREEN DISPLAY] (➔ page 130).
- The projector has a built-in angle sensor. The attitude of the projector is automatically detected by setting [FLOOR/CEILING] to [AUTO] in the [PROJECTOR SETUP] menu → [PROJECTION METHOD].

■ **Angle sensor**

The range of the installation attitude that is detected by the angle sensor built-in the projector is as follows.

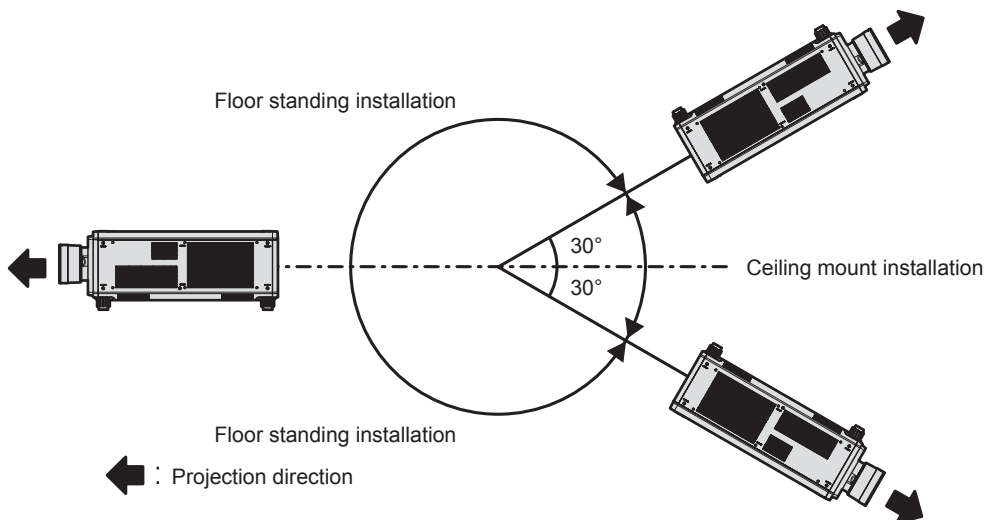

Parts for installation (optional)

The optional Ceiling Mount Bracket is required. The Ceiling Mount Bracket (Model No.: ET-PKD520H (for High Ceilings), ET-PKD520S (for Low Ceilings)) is used together with the Ceiling Mount Bracket (Model No.: ET-PKD520B (Projector Mount Bracket)).

Model No.: ET-PKD520H (for High Ceilings), ET-PKD520S (for Low Ceilings), ET-PKD520B (Projector Mount Bracket)

- Be sure to use the Ceiling Mount Bracket specified for this projector.
- Refer to the Installation Instructions of the Ceiling Mount Bracket when installing and setting up the projector. Two projectors can be used stacked on top of each other by using the optional Frame (Model No.: ET-PFD510).

Attention

- To ensure projector performance and security, installation of the Ceiling Mount Bracket must be carried out by your dealer or a qualified technician.

Projected image and throw distance

Install the projector referring to the projected image size and projection distance. Image size and image position can be adjusted in accordance with the screen size and screen position. When the Fixed-focus Lens (Model No.: ET-D75LE95, ET-D75LE90) is used, the projection relation between the screen and the projector differs from that of other lenses. For details, refer to “Fixed-focus Lens (Model No.: ET-D75LE95, ET-D75LE90)” (➡ page 39).

- Following illustration is prepared on the assumption that the projected image size and position have been aligned to fit full in the screen.

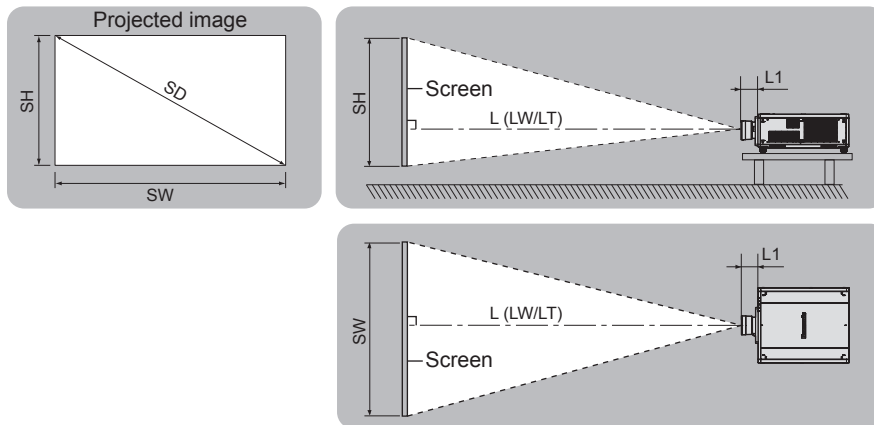

(Unit: m)

L (LW/LT)*1	Projection distance
L1	Lens protrusion dimension
SH	Projected image height
SW	Projected image width
SD	Projected image size

*1 LW: Minimum projection distance when the Zoom Lens is used
 LT: Maximum projection distance when the Zoom Lens is used

(Unit: m)

Projection lens Model No.	Dimension for L1 (approximate value)
ET-D75LE6	0.212
ET-D75LE8	0.254
ET-D75LE10	0.125
ET-D75LE20	0.121
ET-D75LE30	0.121
ET-D75LE40	0.124
ET-D75LE50	0.203

■ Fixed-focus Lens (Model No.: ET-D75LE95, ET-D75LE90)

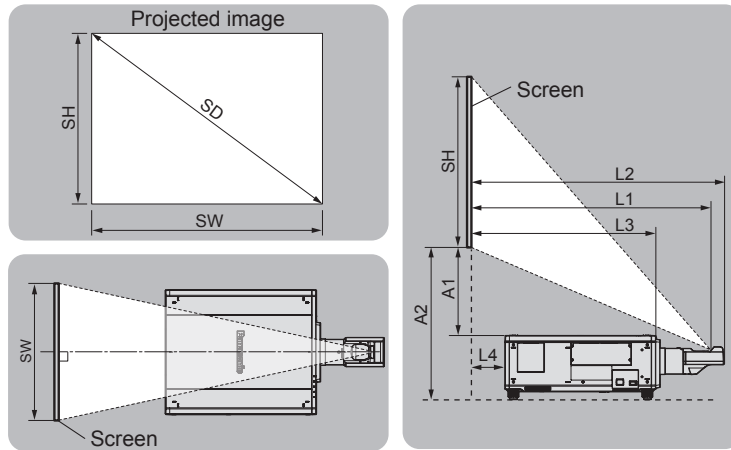

(Unit: m)

SH	Projected image height
SW	Projected image width
SD	Projected image size
L1	Projection distance (from the screen to the mirror reflection surface*1)
L2	Distance between the projector and the screen (from the screen to the tip of the lens)
L3	Distance between the projector and the screen (from the screen to the front surface of the projector)
L4	Distance between the projector and the screen (from the screen to the rear surface of the projector)
A1	Distance between the projector and the screen (from the screen bottom edge to the projector top)
A2	Distance between the projector and the screen (from the screen bottom edge to the projector bottom)

*1 The mirror reflection surface cannot be seen from the outside, because it is located inside the Fixed-focus Lens.

(Unit: m)

Distance between projector and screen	Formula	
	ET-D75LE95	ET-D75LE90
L2	$= L1^{*1} + 0.029$	$= L1^{*1} + 0.029$
L3	$= L1^{*1} - 0.292$	$= L1^{*1} - 0.277$
L4	$= L1^{*1} - 1.017$	$= L1^{*1} - 1.002$
A2	$= A1^{*1} + 0.324$	$= A1^{*1} + 0.324$

*1 For details of calculating values, refer to “Formula for calculating the projection distance per projection lens” (➡ page 47).

Attention

- Before setting up, read “Precautions for use” (➡ page 19).
Especially when the Fixed-focus Lens (Model No.:ET-D75LE95, ET-D75LE90) is used, install the projector so that its back plane is parallel to the screen, making the projected image rectangular.
The vertical keystone distortion in moderate range can be corrected with the [POSITION] menu → [GEOMETRY] → [KEystone] → [VERTICAL KEystone] (➡ page 102) even after the projector is installed. For the range that can be corrected, refer to “[GEOMETRY] projection range” (➡ page 40).
- Do not use the projector and the high-powered laser equipment in the same room. The DLP chips can be damaged if a laser beam hits the projection lens surface.
- The dimension of L4 is not the distance between the rear of the projector body and the wall, but the distance between the rear of the projector body and the screen surface. Install the projector with 500 mm (19-11/16”) or larger space between the rear of the projector body and the wall or any object so that the ventilation is not obstructed.
When installing the projector in a confined space, provide air conditioning or ventilation separately. Exhaust heat may accumulate when the ventilation is not enough, triggering the protection circuit of the projector.

[GEOMETRY] projection range

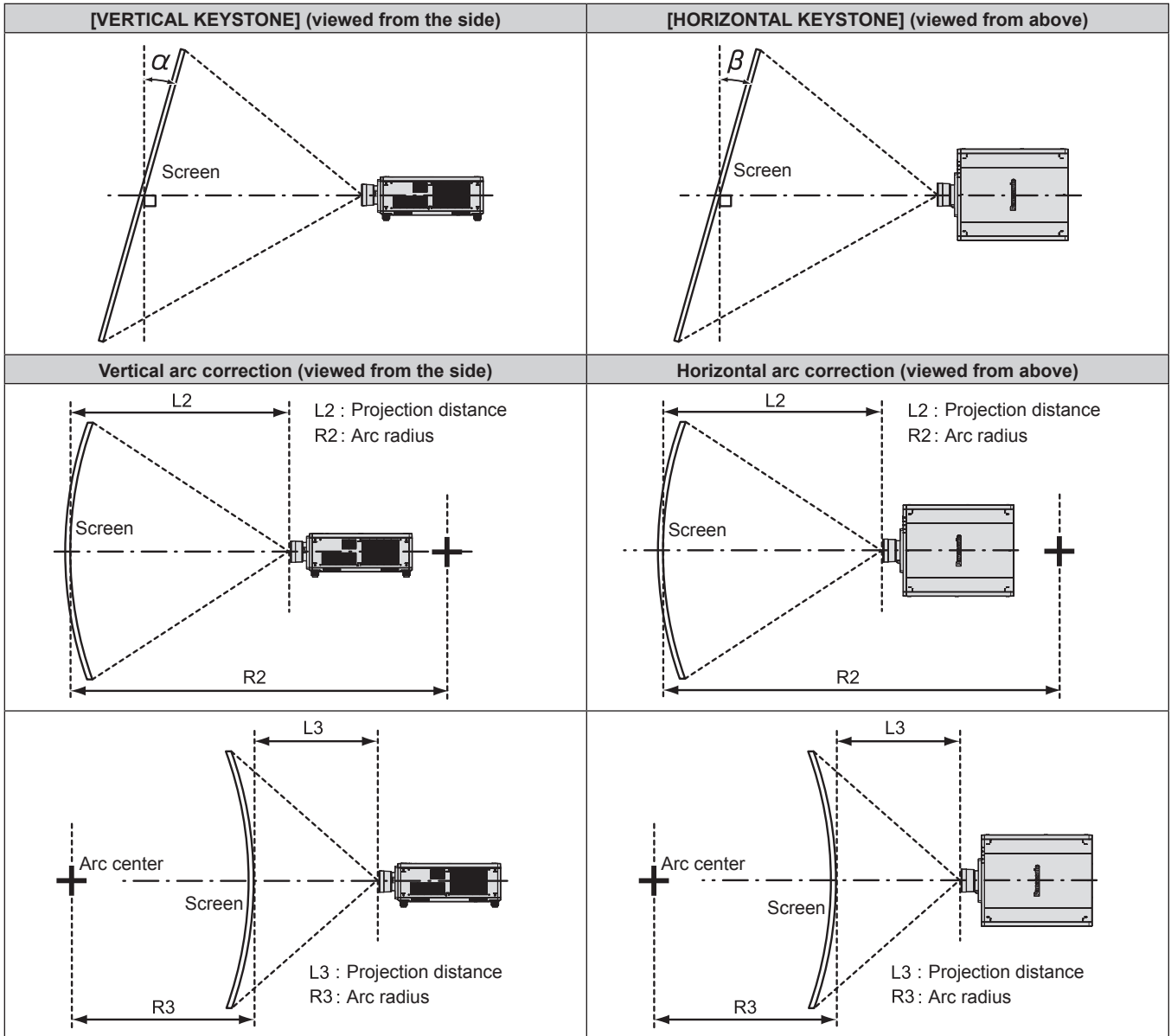

Standard status

Projection lens Model No.	Only [KEYSTONE] used		[KEYSTONE] and [CURVED CORRECTION] used together				Only [CURVED CORRECTION] used	
	Vertical keystone correction angle α (°)	Horizontal keystone correction angle β (°)	Vertical keystone correction angle α (°)	Horizontal keystone correction angle β (°)	Min. value of R2/L2	Min. value of R3/L3	Min. value of R2/L2	Min. value of R3/L3
ET-D75LE6	±28	±15	±10	±10	1.6	3.9	0.9	2.3
ET-D75LE8	±40	±15	±20	±15	0.2	0.4	0.2	0.3
ET-D75LE10	±40	±15	±20	±15	1.1	2.6	0.6	1.5
ET-D75LE20	±40	±15	±20	±15	0.9	1.7	0.5	1.0
ET-D75LE30	±40	±15	±20	±15	0.6	1.2	0.4	0.7
ET-D75LE40	±40	±15	±20	±15	0.4	0.7	0.2	0.4
ET-D75LE50	±22	±15	±8	±8	2.0	4.9	1.2	2.9
ET-D75LE95*1	+5 / -0	0	—	—	—	—	—	—
ET-D75LE90*1	+5 / -0	0	—	—	—	—	—	—

*1 Only the vertical keystone correction angle can be corrected in the direction in which the projector body moves away from the screen.

When using the optional Upgrade Kit (Model No.: ET-UK20)

Projection lens Model No.	Only [KEYSTONE] used*1		[KEYSTONE] and [CURVED CORRECTION] used together				Only [CURVED CORRECTION] used	
	Vertical keystone correction angle α (°)	Horizontal keystone correction angle β (°)	Vertical keystone correction angle α (°)	Horizontal keystone correction angle β (°)	Min. value of R2/L2	Min. value of R3/L3	Min. value of R2/L2	Min. value of R3/L3
ET-D75LE6	±28	±15	±10	±10	1.2	3.0	0.7	1.7
ET-D75LE8	±45	±40	±20	±15	0.2	0.3	0.1	0.2
ET-D75LE10	±40	±40	±20	±15	0.9	2.0	0.5	1.1
ET-D75LE20	±40	±40	±20	±15	0.7	1.3	0.4	0.7
ET-D75LE30	±45	±40	±20	±15	0.5	0.9	0.3	0.5
ET-D75LE40	±45	±40	±20	±15	0.3	0.5	0.2	0.3
ET-D75LE50	±22	±15	±8	±8	1.5	3.7	0.9	2.2
ET-D75LE95*2	+5 / -0	0	—	—	—	—	—	—
ET-D75LE90*2	+5 / -0	0	—	—	—	—	—	—

*1 When [VERTICAL KEYSTONE] and [HORIZONTAL KEYSTONE] are used simultaneously, correction cannot be made exceeding total of 55°.

*2 Only the vertical keystone correction angle can be corrected in the direction in which the projector body moves away from the screen.

Note

- When [GEOMETRY] is used, the focus of the entire screen may be lost as correction increases.
- Make the curved screen a circular arc shape with one part of a perfect circle removed.
- Adjustment range of the [GEOMETRY] items may not match the listed projection range depending on the projection lens. Use this projector within the projection range, otherwise the correction may not work.

Projection distance of each projection lens

A ±5 % error in listed projection distances may occur.

When [GEOMETRY] is used, distance is corrected to become smaller than the specified image size.

For PT-RZ21K

■ When the image aspect ratio is 16:10

(Unit: m)

Lens type			Zoom Lens											
Projection lens Model No.			ET-D75LE6		ET-D75LE10		ET-D75LE20		ET-D75LE30		ET-D75LE40		ET-D75LE8	
Throw ratio ^{*1}			0.924-1.10:1		1.30-1.67:1		1.67-2.41:1		2.40-4.66:1		4.62-7.38:1		7.34-13.8:1	
Projected image size			Projection distance (L)											
Diagonal (SD)	Height (SH)	Width (SW)	Min. (LW)	Max. (LT)	Min. (LW)	Max. (LT)	Min. (LW)	Max. (LT)	Min. (LW)	Max. (LT)	Min. (LW)	Max. (LT)	Min. (LW)	Max. (LT)
1.78 (70")	0.942	1.508	1.36	1.63	1.90	2.46	2.46	3.58	3.56	6.94	6.87	11.04	10.85	20.69
2.03 (80")	1.077	1.723	1.56	1.87	2.19	2.83	2.82	4.11	4.08	7.96	7.88	12.65	12.45	23.70
2.29 (90")	1.212	1.939	1.77	2.11	2.47	3.20	3.19	4.64	4.61	8.98	8.88	14.25	14.06	26.71
2.54 (100")	1.346	2.154	1.97	2.35	2.76	3.56	3.55	5.17	5.13	9.99	9.88	15.85	15.66	29.71
3.05 (120")	1.615	2.585	2.38	2.84	3.32	4.30	4.28	6.22	6.18	12.03	11.89	19.05	18.88	35.73
3.81 (150")	2.019	3.231	2.98	3.57	4.18	5.40	5.37	7.81	7.75	15.08	14.90	23.85	23.69	44.75
5.08 (200")	2.692	4.308	4.00	4.78	5.60	7.24	7.19	10.45	10.38	20.16	19.92	31.86	31.72	59.79
6.35 (250")	3.365	5.385	5.01	6.00	7.02	9.07	9.00	13.09	13.00	25.25	24.95	39.86	39.74	74.82
7.62 (300")	4.039	6.462	6.02	7.21	8.44	10.91	10.82	15.73	15.62	30.34	29.97	47.87	47.77	89.86
8.89 (350")	4.712	7.539	7.04	8.42	9.86	12.74	12.64	18.37	18.24	35.42	34.99	55.87	55.79	104.90
10.16 (400")	5.385	8.616	8.05	9.64	11.28	14.58	14.46	21.01	20.86	40.51	40.01	63.87	63.82	119.94
12.70 (500")	6.731	10.770	10.08	12.07	14.12	18.25	18.09	26.29	26.11	50.68	50.05	79.88	79.87	150.01
15.24 (600")	8.077	12.923	12.10	14.49	16.96	21.92	21.73	31.58	31.35	60.85	60.09	95.89	95.92	180.08
17.78 (700")	9.423	15.077	14.13	16.92	19.80	25.60	25.36	36.86	36.60	71.02	70.13	111.90	111.97	—
20.32 (800")	10.770	17.231	16.16	19.35	22.64	29.27	29.00	42.14	41.84	81.19	80.17	127.91	128.02	—
22.86 (900")	12.116	19.385	18.18	21.78	25.48	32.94	32.63	47.42	47.09	91.36	90.21	143.92	144.07	—
25.40 (1000")	13.462	21.539	20.21	24.21	28.33	36.61	36.27	52.70	52.33	101.53	100.25	159.93	160.13	—

Lens type			Fixed-focus Lens						
Projection lens Model No.			ET-D75LE95 ^{*2}			ET-D75LE90 ^{*2}			ET-D75LE50
Throw ratio ^{*1}			0.364:1			0.364:1			0.694:1
Projected image size			Projection distance (L1)	Distance between projector and screen		Projection distance (L1)	Distance between projector and screen		Projection distance (L)
Diagonal (SD)	Height (SH)	Width (SW)		(L4)	(A1)		(L4)	(A1)	
1.78 (70")	0.942	1.508	—	—	—	—	—	—	1.01
2.03 (80")	1.077	1.723	—	—	—	—	—	—	1.16
2.29 (90")	1.212	1.939	—	—	—	—	—	—	1.32
2.54 (100")	1.346	2.154	—	—	—	—	—	—	1.47
3.05 (120")	1.615	2.585	0.94	-0.07	0.17-0.33	0.94	-0.06	0.24-0.33	1.78
3.81 (150")	2.019	3.231	1.18	0.16	0.24-0.44	1.18	0.17	0.33-0.44	2.24
5.08 (200")	2.692	4.308	1.56	0.54	0.37-0.63	1.56	0.56	0.49-0.63	3.01
6.35 (250")	3.365	5.385	1.95	0.93	0.49-0.82	1.95	0.94	0.64-0.82	3.78
7.62 (300")	4.039	6.462	2.33	1.31	0.62-1.02	2.33	1.33	0.80-1.01	4.56
8.89 (350")	4.712	7.539	2.72	1.70	0.74-1.21	2.72	1.71	0.95-1.21	5.33
10.16 (400")	5.385	8.616	3.10	2.08	0.86-1.40	3.10	2.10	1.11-1.40	6.10
12.70 (500")	6.731	10.770	3.87	2.85	1.11-1.78	3.87	2.87	1.41-1.78	7.64
15.24 (600")	8.077	12.923	4.64	3.62	1.36-2.16	4.64	3.64	1.72-2.16	9.18
17.78 (700")	9.423	15.077	—	—	—	—	—	—	10.72
20.32 (800")	10.770	17.231	—	—	—	—	—	—	12.27
22.86 (900")	12.116	19.385	—	—	—	—	—	—	13.81
25.40 (1000")	13.462	21.539	—	—	—	—	—	—	15.35

*1 The throw ratio is based on the value during projection with the projected image size of 3.81 m (150").

*2 When the Fixed-focus Lens (Model No.: ET-D75LE95, ET-D75LE90) is used, the projection relation between the screen and the projector differs from that of other lenses. For details, refer to "Fixed-focus Lens (Model No.: ET-D75LE95, ET-D75LE90)" (▶ page 39).

■ When the image aspect ratio is 16:9

(Unit: m)

Lens type			Zoom Lens											
Projection lens Model No.			ET-D75LE6		ET-D75LE10		ET-D75LE20		ET-D75LE30		ET-D75LE40		ET-D75LE8	
Throw ratio*1			0.924-1.10:1		1.30-1.67:1		1.67-2.41:1		2.41-4.66:1		4.62-7.38:1		7.34-13.8:1	
Projected image size			Projection distance (L)											
Diagonal (SD)	Height (SH)	Width (SW)	Min. (LW)		Max. (LT)		Min. (LW)		Max. (LT)		Min. (LW)		Max. (LT)	
1.78 (70")	0.872	1.550	1.40	1.67	1.96	2.53	2.53	3.68	3.66	7.14	7.07	11.36	11.16	21.28
2.03 (80")	0.996	1.771	1.61	1.92	2.25	2.91	2.91	4.23	4.20	8.19	8.10	13.00	12.81	24.37
2.29 (90")	1.121	1.992	1.82	2.17	2.54	3.29	3.28	4.77	4.74	9.23	9.13	14.65	14.46	27.46
2.54 (100")	1.245	2.214	2.03	2.42	2.83	3.67	3.65	5.31	5.28	10.28	10.16	16.29	16.11	30.55
3.05 (120")	1.494	2.657	2.44	2.92	3.42	4.42	4.40	6.40	6.35	12.37	12.23	19.58	19.41	36.73
3.81 (150")	1.868	3.321	3.07	3.67	4.29	5.55	5.52	8.03	7.97	15.50	15.32	24.52	24.36	46.00
5.08 (200")	2.491	4.428	4.11	4.92	5.75	7.44	7.39	10.74	10.67	20.73	20.48	32.75	32.61	61.46
6.35 (250")	3.113	5.535	5.15	6.17	7.21	9.33	9.26	13.46	13.36	25.96	25.64	40.97	40.86	76.91
7.62 (300")	3.736	6.641	6.19	7.41	8.67	11.21	11.13	16.17	16.06	31.18	30.80	49.20	49.11	92.37
8.89 (350")	4.358	7.748	7.23	8.66	10.13	13.10	12.99	18.88	18.75	36.41	35.96	57.43	57.35	107.82
10.16 (400")	4.981	8.855	8.28	9.91	11.59	14.99	14.86	21.60	21.45	41.64	41.12	65.65	65.60	123.28
12.70 (500")	6.226	11.069	10.36	12.40	14.51	18.76	18.60	27.03	26.84	52.09	51.44	82.11	82.10	154.19
15.24 (600")	7.472	13.283	12.44	14.90	17.44	22.54	22.33	32.46	32.23	62.54	61.76	98.56	98.60	185.10
17.78 (700")	8.717	15.497	14.52	17.39	20.36	26.31	26.07	37.89	37.62	73.00	72.08	115.02	115.10	—
20.32 (800")	9.962	17.710	16.61	19.89	23.28	30.09	29.81	43.31	43.01	83.45	82.41	131.47	131.59	—
22.86 (900")	11.207	19.924	18.69	22.39	26.20	33.86	33.54	48.74	48.40	93.90	92.73	147.92	148.09	—
25.40 (1000")	12.453	22.138	20.77	24.88	29.12	37.63	37.28	54.17	53.79	104.36	103.05	164.38	164.59	—

Lens type			Fixed-focus Lens						
Projection lens Model No.			ET-D75LE95*2				ET-D75LE90*2		ET-D75LE50
Throw ratio*1			0.364:1				0.364:1		0.695:1
Projected image size			Projection distance (L1)	Distance between projector and screen		Projection distance (L1)	Distance between projector and screen		Projection distance (L)
Diagonal (SD)	Height (SH)	Width (SW)		(L4)	(A1)		(L4)	(A1)	
			1.78 (70")	0.872	1.550	—	—	—	—
2.03 (80")	0.996	1.771	—	—	—	—	—	1.20	
2.29 (90")	1.121	1.992	—	—	—	—	—	1.36	
2.54 (100")	1.245	2.214	—	—	—	—	—	1.51	
3.05 (120")	1.494	2.657	0.97	-0.05	0.18-0.43	0.97	-0.03	0.25-0.42	1.83
3.81 (150")	1.868	3.321	1.21	0.19	0.26-0.56	1.21	0.20	0.35-0.56	2.31
5.08 (200")	2.491	4.428	1.60	0.59	0.38-0.79	1.60	0.60	0.50-0.79	3.10
6.35 (250")	3.113	5.535	2.00	0.98	0.51-1.02	2.00	1.00	0.66-1.02	3.89
7.62 (300")	3.736	6.641	2.39	1.38	0.64-1.25	2.39	1.39	0.82-1.25	4.68
8.89 (350")	4.358	7.748	2.79	1.77	0.77-1.49	2.79	1.79	0.98-1.48	5.48
10.16 (400")	4.981	8.855	3.19	2.17	0.89-1.72	3.19	2.18	1.14-1.71	6.27
12.70 (500")	6.226	11.069	3.98	2.96	1.15-2.18	3.98	2.97	1.45-2.18	7.85
15.24 (600")	7.472	13.283	4.77	3.75	1.40-2.64	4.77	3.77	1.77-2.64	9.44
17.78 (700")	8.717	15.497	—	—	—	—	—	—	11.02
20.32 (800")	9.962	17.710	—	—	—	—	—	—	12.61
22.86 (900")	11.207	19.924	—	—	—	—	—	—	14.19
25.40 (1000")	12.453	22.138	—	—	—	—	—	—	15.78

*1 The throw ratio is based on the value during projection with the projected image size of 3.81 m (150").

*2 When the Fixed-focus Lens (Model No.: ET-D75LE95, ET-D75LE90) is used, the projection relation between the screen and the projector differs from that of other lenses. For details, refer to "Fixed-focus Lens (Model No.: ET-D75LE95, ET-D75LE90)" (➡ page 39).

■ When the image aspect ratio is 4:3

(Unit: m)

Lens type			Zoom Lens											
Projection lens Model No.			ET-D75LE6		ET-D75LE10		ET-D75LE20		ET-D75LE30		ET-D75LE40		ET-D75LE8	
Throw ratio ^{*1}			1.12-1.32:1		1.56-2.01:1		2.00-2.90:1		2.89-5.60:1		5.55-8.86:1		8.82-16.6:1	
Projected image size			Projection distance (L)											
Diagonal (SD)	Height (SH)	Width (SW)	Min. (LW)		Max. (LT)		Min. (LW)		Max. (LT)		Min. (LW)		Max. (LT)	
1.78 (70")	1.067	1.422	1.55	1.85	2.17	2.80	2.80	4.07	4.04	7.88	7.80	12.52	12.33	23.47
2.03 (80")	1.219	1.626	1.78	2.13	2.49	3.22	3.21	4.67	4.64	9.03	8.94	14.34	14.15	26.88
2.29 (90")	1.372	1.829	2.01	2.40	2.81	3.63	3.62	5.27	5.23	10.19	10.07	16.15	15.97	30.28
2.54 (100")	1.524	2.032	2.24	2.68	3.13	4.05	4.03	5.86	5.82	11.34	11.21	17.96	17.78	33.69
3.05 (120")	1.829	2.438	2.70	3.22	3.77	4.88	4.86	7.06	7.01	13.64	13.48	21.59	21.42	40.50
3.81 (150")	2.286	3.048	3.38	4.05	4.74	6.13	6.09	8.85	8.79	17.09	16.89	27.02	26.87	50.71
5.08 (200")	3.048	4.064	4.53	5.42	6.35	8.21	8.15	11.84	11.76	22.85	22.58	36.09	35.96	67.73
6.35 (250")	3.810	5.080	5.68	6.80	7.96	10.28	10.20	14.83	14.73	28.61	28.26	45.15	45.04	84.75
7.62 (300")	4.572	6.096	6.83	8.17	9.56	12.36	12.26	17.82	17.70	34.36	33.94	54.21	54.13	101.78
8.89 (350")	5.334	7.112	7.97	9.55	11.17	14.44	14.32	20.81	20.67	40.12	39.63	63.27	63.21	118.80
10.16 (400")	6.096	8.128	9.12	10.92	12.78	16.52	16.38	23.80	23.63	45.88	45.31	72.33	72.30	135.82
12.70 (500")	7.620	10.160	11.41	13.67	16.00	20.68	20.49	29.78	29.57	57.39	56.68	90.45	90.47	169.87
15.24 (600")	9.144	12.192	13.71	16.42	19.21	24.83	24.61	35.76	35.51	68.91	68.05	108.58	108.64	203.91
17.78 (700")	10.668	14.224	16.00	19.17	22.43	28.99	28.72	41.74	41.45	80.42	79.41	126.70	126.81	—
20.32 (800")	12.192	16.256	18.30	21.92	25.65	33.15	32.84	47.72	47.38	91.93	90.78	144.82	144.98	—
22.86 (900")	13.716	18.288	20.59	24.66	28.86	37.31	36.95	53.70	53.32	103.45	102.15	162.95	163.15	—
25.40 (1000")	15.240	20.320	22.89	27.41	32.08	41.46	41.07	59.68	59.26	114.96	113.52	181.07	181.33	—

Lens type			Fixed-focus Lens						
Projection lens Model No.			ET-D75LE95 ^{*2}			ET-D75LE90 ^{*2}			ET-D75LE50
Throw ratio ^{*1}			0.436:1			0.436:1			0.836:1
Projected image size			Projection distance (L1)	Distance between projector and screen		Projection distance (L1)	Distance between projector and screen		Projection distance (L)
Diagonal (SD)	Height (SH)	Width (SW)		(L4)	(A1)		(L4)	(A1)	
			1.78 (70")	1.067	1.422	—	—	—	—
2.03 (80")	1.219	1.626	—	—	—	—	—	1.33	
2.29 (90")	1.372	1.829	—	—	—	—	—	1.50	
2.54 (100")	1.524	2.032	—	—	—	—	—	1.67	
3.05 (120")	1.829	2.438	1.07	0.05	0.21-0.39	1.07	0.06	0.29-0.39	2.02
3.81 (150")	2.286	3.048	1.33	0.31	0.29-0.52	1.33	0.33	0.40-0.52	2.55
5.08 (200")	3.048	4.064	1.76	0.75	0.43-0.74	1.76	0.76	0.57-0.73	3.42
6.35 (250")	3.810	5.080	2.20	1.18	0.57-0.95	2.20	1.20	0.74-0.95	4.29
7.62 (300")	4.572	6.096	2.64	1.62	0.71-1.17	2.64	1.63	0.92-1.17	5.17
8.89 (350")	5.334	7.112	3.07	2.05	0.85-1.38	3.07	2.07	1.09-1.38	6.04
10.16 (400")	6.096	8.128	3.51	2.49	0.99-1.60	3.51	2.50	1.27-1.60	6.91
12.70 (500")	7.620	10.160	4.38	3.36	1.27-2.03	4.38	3.38	1.62-2.03	8.66
15.24 (600")	9.144	12.192	5.25	4.23	1.55-2.46	5.25	4.25	1.97-2.46	10.40
17.78 (700")	10.668	14.224	—	—	—	—	—	—	12.15
20.32 (800")	12.192	16.256	—	—	—	—	—	—	13.90
22.86 (900")	13.716	18.288	—	—	—	—	—	—	15.64
25.40 (1000")	15.240	20.320	—	—	—	—	—	—	17.39

*1 The throw ratio is based on the value during projection with the projected image size of 3.81 m (150").

*2 When the Fixed-focus Lens (Model No.: ET-D75LE95, ET-D75LE90) is used, the projection relation between the screen and the projector differs from that of other lenses. For details, refer to "Fixed-focus Lens (Model No.: ET-D75LE95, ET-D75LE90)" (➡ page 39).

For PT-RS20K

■ When the image aspect ratio is 4:3

(Unit: m)

Lens type			Zoom Lens											
Projection lens Model No.			ET-D75LE6		ET-D75LE10		ET-D75LE20		ET-D75LE30		ET-D75LE40		ET-D75LE8	
Throw ratio*1			1.01-1.19:1		1.41-1.81:1		1.80-2.61:1		2.60-5.05:1		5.00-7.99:1		7.95-14.9:1	
Projected image size			Projection distance (L)											
Diagonal (SD)	Height (SH)	Width (SW)	Min. (LW)		Max. (LT)		Min. (LW)		Max. (LT)		Min. (LW)		Max. (LT)	
			1.78 (70")	1.067	1.422	1.39	1.66	1.95	2.52	2.52	3.66	3.64	7.10	7.02
2.03 (80")	1.219	1.626	1.60	1.91	2.24	2.89	2.89	4.20	4.17	8.13	8.05	12.92	12.73	24.21
2.29 (90")	1.372	1.829	1.81	2.16	2.53	3.27	3.26	4.74	4.71	9.17	9.07	14.56	14.37	27.29
2.54 (100")	1.524	2.032	2.01	2.41	2.82	3.64	3.63	5.28	5.24	10.21	10.10	16.19	16.01	30.36
3.05 (120")	1.829	2.438	2.43	2.90	3.40	4.39	4.37	6.36	6.31	12.29	12.15	19.46	19.29	36.50
3.81 (150")	2.286	3.048	3.05	3.65	4.27	5.52	5.49	7.98	7.92	15.41	15.23	24.37	24.21	45.72
5.08 (200")	3.048	4.064	4.08	4.89	5.72	7.39	7.34	10.67	10.60	20.60	20.35	32.54	32.40	61.08
6.35 (250")	3.810	5.080	5.12	6.13	7.17	9.27	9.20	13.37	13.28	25.79	25.48	40.72	40.60	76.44
7.62 (300")	4.572	6.096	6.15	7.37	8.62	11.14	11.06	16.07	15.96	30.99	30.61	48.89	48.80	91.79
8.89 (350")	5.334	7.112	7.19	8.61	10.07	13.02	12.91	18.77	18.63	36.18	35.74	57.07	57.00	107.15
10.16 (400")	6.096	8.128	8.22	9.85	11.52	14.90	14.77	21.46	21.31	41.38	40.87	65.25	65.19	122.51
12.70 (500")	7.620	10.160	10.29	12.33	14.42	18.65	18.48	26.86	26.67	51.77	51.12	81.60	81.59	153.23
15.24 (600")	9.144	12.192	12.36	14.81	17.33	22.40	22.19	32.25	32.03	62.15	61.38	97.95	97.98	183.95
17.78 (700")	10.668	14.224	14.43	17.29	20.23	26.15	25.91	37.65	37.38	72.54	71.64	114.30	114.38	—
20.32 (800")	12.192	16.256	16.50	19.77	23.13	29.90	29.62	43.04	42.74	82.93	81.89	130.65	130.77	—
22.86 (900")	13.716	18.288	18.57	22.25	26.03	33.65	33.33	48.44	48.10	93.32	92.15	147.00	147.17	—
25.40 (1000")	15.240	20.320	20.64	24.73	28.93	37.40	37.05	53.83	53.45	103.71	102.41	163.36	163.56	—

Lens type			Fixed-focus Lens						
Projection lens Model No.			ET-D75LE95*2			ET-D75LE90*2			ET-D75LE50
Throw ratio*1			0.394:1			0.394:1			0.752:1
Projected image size			Projection distance (L1)	Distance between projector and screen		Projection distance (L1)	Distance between projector and screen		Projection distance (L)
Diagonal (SD)	Height (SH)	Width (SW)		(L4)	(A1)		(L4)	(A1)	
			1.78 (70")	1.067	1.422	—	—	—	—
2.03 (80")	1.219	1.626	—	—	—	—	—	—	1.19
2.29 (90")	1.372	1.829	—	—	—	—	—	—	1.35
2.54 (100")	1.524	2.032	—	—	—	—	—	—	1.50
3.05 (120")	1.829	2.438	0.96	-0.05	0.18-0.25	0.96	-0.04	0.25	1.82
3.81 (150")	2.286	3.048	1.20	0.18	0.25-0.34	1.20	0.20	0.34	2.29
5.08 (200")	3.048	4.064	1.59	0.58	0.38-0.50	1.59	0.59	0.50	3.08
6.35 (250")	3.810	5.080	1.99	0.97	0.50-0.66	1.99	0.98	0.66	3.87
7.62 (300")	4.572	6.096	2.38	1.36	0.63-0.81	2.38	1.38	0.81	4.65
8.89 (350")	5.334	7.112	2.77	1.76	0.76-0.97	2.77	1.77	0.97	5.44
10.16 (400")	6.096	8.128	3.17	2.15	0.88-1.13	3.17	2.16	1.13	6.23
12.70 (500")	7.620	10.160	3.95	2.94	1.14-1.44	3.95	2.95	1.44	7.80
15.24 (600")	9.144	12.192	4.74	3.72	1.39-1.76	4.74	3.74	1.76	9.38
17.78 (700")	10.668	14.224	—	—	—	—	—	—	10.96
20.32 (800")	12.192	16.256	—	—	—	—	—	—	12.53
22.86 (900")	13.716	18.288	—	—	—	—	—	—	14.11
25.40 (1000")	15.240	20.320	—	—	—	—	—	—	15.68

*1 The throw ratio is based on the value during projection with the projected image size of 3.81 m (150").

*2 When the Fixed-focus Lens (Model No.: ET-D75LE95, ET-D75LE90) is used, the projection relation between the screen and the projector differs from that of other lenses. For details, refer to "Fixed-focus Lens (Model No.: ET-D75LE95, ET-D75LE90)" (▶ page 39).

■ When the image aspect ratio is 16:9

(Unit: m)

Lens type			Zoom Lens											
Projection lens Model No.			ET-D75LE6		ET-D75LE10		ET-D75LE20		ET-D75LE30		ET-D75LE40		ET-D75LE8	
Throw ratio*1			1.01-1.19:1		1.41-1.81:1		1.81-2.61:1		2.61-5.05:1		5.00-7.99:1		7.96-15.0:1	
Projected image size			Projection distance (L)											
Diagonal (SD)	Height (SH)	Width (SW)	Min. (LW)	Max. (LT)	Min. (LW)	Max. (LT)	Min. (LW)	Max. (LT)	Min. (LW)	Max. (LT)	Min. (LW)	Max. (LT)	Min. (LW)	Max. (LT)
1.78 (70")	0.872	1.550	1.52	1.82	2.13	2.75	2.75	4.00	3.97	7.74	7.66	12.31	12.12	23.06
2.03 (80")	0.996	1.771	1.75	2.09	2.44	3.16	3.15	4.59	4.55	8.88	8.78	14.09	13.90	26.41
2.29 (90")	1.121	1.992	1.97	2.36	2.76	3.57	3.56	5.17	5.14	10.01	9.90	15.87	15.69	29.76
2.54 (100")	1.245	2.214	2.20	2.63	3.08	3.98	3.96	5.76	5.72	11.14	11.01	17.65	17.47	33.10
3.05 (120")	1.494	2.657	2.65	3.17	3.71	4.79	4.77	6.94	6.89	13.40	13.25	21.21	21.04	39.79
3.81 (150")	1.868	3.321	3.33	3.98	4.66	6.02	5.98	8.70	8.64	16.80	16.60	26.56	26.40	49.83
5.08 (200")	2.491	4.428	4.45	5.33	6.24	8.06	8.01	11.64	11.56	22.46	22.19	35.46	35.33	66.56
6.35 (250")	3.113	5.535	5.58	6.68	7.82	10.11	10.03	14.58	14.47	28.11	27.77	44.37	44.26	83.29
7.62 (300")	3.736	6.641	6.71	8.03	9.40	12.15	12.05	17.51	17.39	33.77	33.36	53.27	53.19	100.02
8.89 (350")	4.358	7.748	7.84	9.38	10.98	14.19	14.07	20.45	20.31	39.43	38.95	62.18	62.12	116.75
10.16 (400")	4.981	8.855	8.96	10.73	12.56	16.23	16.10	23.39	23.23	45.09	44.53	71.09	71.05	133.49
12.70 (500")	6.226	11.069	11.22	13.43	15.72	20.32	20.14	29.27	29.06	56.40	55.70	88.90	88.91	166.95
15.24 (600")	7.472	13.283	13.47	16.14	18.88	24.41	24.18	35.15	34.90	67.72	66.88	106.71	106.77	200.41
17.78 (700")	8.717	15.497	15.73	18.84	22.04	28.49	28.23	41.02	40.73	79.04	78.05	124.52	124.63	—
20.32 (800")	9.962	17.710	17.98	21.54	25.20	32.58	32.27	46.90	46.57	90.35	89.22	142.34	142.49	—
22.86 (900")	11.207	19.924	20.24	24.24	28.36	36.66	36.32	52.78	52.40	101.67	100.39	160.15	160.35	—
25.40 (1000")	12.453	22.138	22.49	26.94	31.53	40.75	40.36	58.65	58.24	112.98	111.56	177.96	178.21	—

Lens type			Fixed-focus Lens						
Projection lens Model No.			ET-D75LE95*2			ET-D75LE90*2			ET-D75LE50
Throw ratio*1			0.394:1			0.394:1			0.754:1
Projected image size			Projection distance (L1)	Distance between projector and screen		Projection distance (L1)	Distance between projector and screen		Projection distance (L)
Diagonal (SD)	Height (SH)	Width (SW)		(L4)	(A1)		(L4)	(A1)	
1.78 (70")	0.872	1.550	—	—	—	—	—	—	1.13
2.03 (80")	0.996	1.771	—	—	—	—	—	—	1.30
2.29 (90")	1.121	1.992	—	—	—	—	—	—	1.47
2.54 (100")	1.245	2.214	—	—	—	—	—	—	1.64
3.05 (120")	1.494	2.657	1.05	0.03	0.20-0.53	1.05	0.05	0.28-0.53	1.99
3.81 (150")	1.868	3.321	1.31	0.29	0.29-0.70	1.31	0.30	0.39-0.70	2.50
5.08 (200")	2.491	4.428	1.73	0.72	0.43-0.97	1.73	0.73	0.56-0.97	3.36
6.35 (250")	3.113	5.535	2.16	1.15	0.56-1.25	2.16	1.16	0.73-1.24	4.22
7.62 (300")	3.736	6.641	2.59	1.57	0.70-1.52	2.59	1.59	0.90-1.52	5.08
8.89 (350")	4.358	7.748	3.02	2.00	0.84-1.79	3.02	2.02	1.07-1.79	5.93
10.16 (400")	4.981	8.855	3.45	2.43	0.98-2.07	3.45	2.44	1.24-2.07	6.79
12.70 (500")	6.226	11.069	4.30	3.29	1.25-2.62	4.30	3.30	1.58-2.62	8.51
15.24 (600")	7.472	13.283	5.16	4.14	1.53-3.17	5.16	4.16	1.93-3.17	10.22
17.78 (700")	8.717	15.497	—	—	—	—	—	—	11.94
20.32 (800")	9.962	17.710	—	—	—	—	—	—	13.66
22.86 (900")	11.207	19.924	—	—	—	—	—	—	15.37
25.40 (1000")	12.453	22.138	—	—	—	—	—	—	17.09

*1 The throw ratio is based on the value during projection with the projected image size of 3.81 m (150").

*2 When the Fixed-focus Lens (Model No.: ET-D75LE95, ET-D75LE90) is used, the projection relation between the screen and the projector differs from that of other lenses. For details, refer to "Fixed-focus Lens (Model No.: ET-D75LE95, ET-D75LE90)" (➡ page 39).

Formula for calculating the projection distance per projection lens

To use a projected image size not listed in this manual, check the projected image size SD (m) and use the respective formula to calculate projection distance.

The unit of all the formulae is m. (Values obtained by the following calculation formulae contain a slight error.)

When calculating a projection distance using image size designation (value in inches), multiply the value in inches by 0.0254 and substitute it into SD in the formula for calculating the projection distance.

For PT-RZ21K

■ **Zoom Lens**

Projection lens Model No.	Throw ratio	Aspect ratio	Projection distance (L) formula	
			Min. (LW)	Max. (LT)
ET-D75LE6	0.924 - 1.10:1	16:10	= 0.7979 x SD - 0.0566	= 0.9559 x SD - 0.0736
	0.924 - 1.10:1	16:9	= 0.8201 x SD - 0.0566	= 0.9825 x SD - 0.0736
	1.12 - 1.32:1	4:3	= 0.9032 x SD - 0.0566	= 1.0822 x SD - 0.0736
ET-D75LE10	1.30 - 1.67:1	16:10	= 1.1186 x SD - 0.0857	= 1.4458 x SD - 0.1085
	1.30 - 1.67:1	16:9	= 1.1497 x SD - 0.0857	= 1.4860 x SD - 0.1085
	1.56 - 2.01:1	4:3	= 1.2663 x SD - 0.0857	= 1.6367 x SD - 0.1085
ET-D75LE20	1.67 - 2.41:1	16:10	= 1.4312 x SD - 0.0832	= 2.0795 x SD - 0.1162
	1.67 - 2.41:1	16:9	= 1.4709 x SD - 0.0832	= 2.1373 x SD - 0.1162
	2.00 - 2.90:1	4:3	= 1.6202 x SD - 0.0832	= 2.3542 x SD - 0.1162
ET-D75LE30	2.40 - 4.66:1	16:10	= 2.0647 x SD - 0.1131	= 4.0041 x SD - 0.1765
	2.41 - 4.66:1	16:9	= 2.1221 x SD - 0.1131	= 4.1155 x SD - 0.1765
	2.89 - 5.60:1	4:3	= 2.3374 x SD - 0.1131	= 4.5330 x SD - 0.1765
ET-D75LE40	4.62 - 7.38:1	16:10	= 3.9532 x SD - 0.1577	= 6.3027 x SD - 0.1615
	4.62 - 7.38:1	16:9	= 4.0631 x SD - 0.1577	= 6.4779 x SD - 0.1615
	5.55 - 8.86:1	4:3	= 4.4754 x SD - 0.1577	= 7.1351 x SD - 0.1615
ET-D75LE8	7.34 - 13.8:1	16:10	= 6.3193 x SD - 0.3862	= 11.8400 x SD - 0.3598
	7.34 - 13.8:1	16:9	= 6.4950 x SD - 0.3862	= 12.1692 x SD - 0.3598
	8.82 - 16.6:1	4:3	= 7.1540 x SD - 0.3862	= 13.4039 x SD - 0.3598

■ **Fixed-focus Lens**

Projection lens Model No.	Throw ratio	Aspect ratio	Projection distance (L1) formula	Formula for distance between projector and screen (A1)	
				Min.	Max.
ET-D75LE95	0.364:1	16:10	= 0.303 x SD + 0.020	= 0.184 x SH - 0.128	= 0.283 x SH - 0.128
	0.364:1	16:9	= 0.312 x SD + 0.020	= 0.205 x SH - 0.128	= 0.370 x SH - 0.128
	0.436:1	4:3	= 0.343 x SD + 0.020	= 0.184 x SH - 0.128	= 0.283 x SH - 0.128
ET-D75LE90	0.364:1	16:10	= 0.303 x SD + 0.020	= 0.229 x SH - 0.128	= 0.283 x SH - 0.128
	0.364:1	16:9	= 0.312 x SD + 0.020	= 0.254 x SH - 0.128	= 0.370 x SH - 0.128
	0.436:1	4:3	= 0.343 x SD + 0.020	= 0.229 x SH - 0.128	= 0.283 x SH - 0.128

Projection lens Model No.	Throw ratio	Aspect ratio	Projection distance (L) formula
ET-D75LE50	0.694:1	16:10	= 0.6072 x SD - 0.0713
	0.695:1	16:9	= 0.6240 x SD - 0.0713
	0.836:1	4:3	= 0.6873 x SD - 0.0713

For PT-RS20K

■ Zoom Lens

Projection lens Model No.	Throw ratio	Aspect ratio	Projection distance (L) formula	
			Min. (LW)	Max. (LT)
ET-D75LE6	1.01 - 1.19:1	4:3	= 0.8150 x SD - 0.0566	= 0.9764 x SD - 0.0736
	1.01 - 1.19:1	16:9	= 0.8877 x SD - 0.0566	= 1.0636 x SD - 0.0736
ET-D75LE10	1.41 - 1.81:1	4:3	= 1.1425 x SD - 0.0857	= 1.4767 x SD - 0.1085
	1.41 - 1.81:1	16:9	= 1.2446 x SD - 0.0857	= 1.6086 x SD - 0.1085
ET-D75LE20	1.80 - 2.61:1	4:3	= 1.4618 x SD - 0.0832	= 2.1241 x SD - 0.1162
	1.81 - 2.61:1	16:9	= 1.5924 x SD - 0.0832	= 2.3137 x SD - 0.1162
ET-D75LE30	2.60 - 5.05:1	4:3	= 2.1089 x SD - 0.1131	= 4.0899 x SD - 0.1765
	2.61 - 5.05:1	16:9	= 2.2972 x SD - 0.1131	= 4.4552 x SD - 0.1765
ET-D75LE40	5.00 - 7.99:1	4:3	= 4.0379 x SD - 0.1577	= 6.4377 x SD - 0.1615
	5.00 - 7.99:1	16:9	= 4.3985 x SD - 0.1577	= 7.0126 x SD - 0.1615
ET-D75LE8	7.95 - 14.9:1	4:3	= 6.4547 x SD - 0.3862	= 12.0937 x SD - 0.3598
	7.96 - 15.0:1	16:9	= 7.0312 x SD - 0.3862	= 13.1737 x SD - 0.3598

■ Fixed-focus Lens

Projection lens Model No.	Throw ratio	Aspect ratio	Projection distance (L1) formula	Formula for distance between projector and screen (A1)	
				Min.	Max.
ET-D75LE95	0.394:1	4:3	= 0.310 x SD + 0.020	= 0.166 x SH - 0.128	= 0.206 x SH - 0.128
	0.394:1	16:9	= 0.337 x SD + 0.020	= 0.222 x SH - 0.128	= 0.441 x SH - 0.128
ET-D75LE90	0.394:1	4:3	= 0.310 x SD + 0.020	= 0.206 x SH - 0.128	
	0.394:1	16:9	= 0.337 x SD + 0.020	= 0.275 x SH - 0.128	= 0.441 x SH - 0.128

Projection lens Model No.	Throw ratio	Aspect ratio	Projection distance (L) formula
ET-D75LE50	0.752:1	4:3	= 0.6202 x SD - 0.0713
	0.754:1	16:9	= 0.6755 x SD - 0.0713

Adjusting adjustable feet

Install the projector on a flat surface so that the front of the projector is parallel to the screen surface and the projection screen is rectangular.

If the screen is tilted downward, extend the front adjustable feet so that the projected image becomes rectangular. The adjustable feet can also be used to adjust the projector to be level when it is tilted in the horizontal direction.

Adjustable feet can be extended by turning them as shown in the figure. Turning them in the opposite direction will return them to the original position.

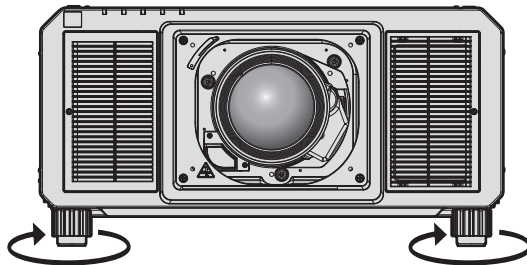

Maximum adjustable range
Adjustable feet: 20 mm (25/32") each

Attention

- Be careful not to block the intake/exhaust ports with your hands or any objects when adjusting the adjustable feet while the light source is on. (➔ page 30)

Attaching/removing the projection lens (optional)

Move the projection lens to the home position before replacing or removing the projection lens. (➔ page 75)

Attention

- Replace the projection lens after turning off the power of the projector.
- Do not touch the electric contacts of the projection lens. Dust or dirt may cause poor contact.
- Do not touch the surface of the projection lens with your bare hands.
- Before attaching the projection lens, remove the lens cover attached to the projection lens.
- Panasonic takes no responsibility for any damage or malfunction of the product resulting from the use of projection lenses which are not manufactured by Panasonic. Be sure to use the specified projection lenses.

Note

- The precautions for handling the lens are different for the Fixed-focus Lens (Model No.: ET-D75LE95, ET-D75LE90). For details, refer to the Operating Instructions of ET-D75LE95 or ET-D75LE90.

Attaching the projection lens

Attach the projection lens using the following procedure. Start from Step 3) when the lens hole cover is already removed.

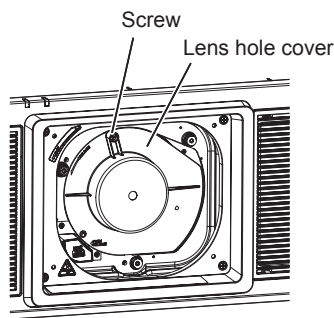

Fig. 1

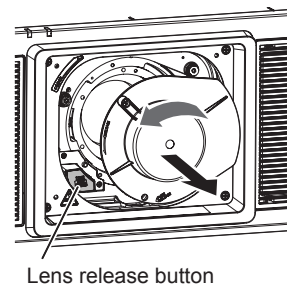

Fig. 2

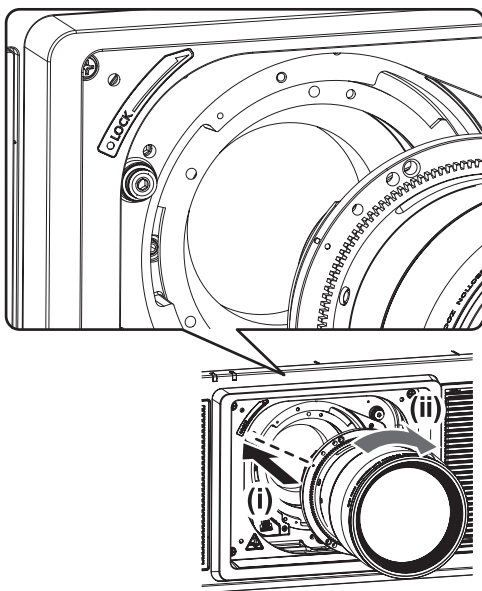

Fig. 3

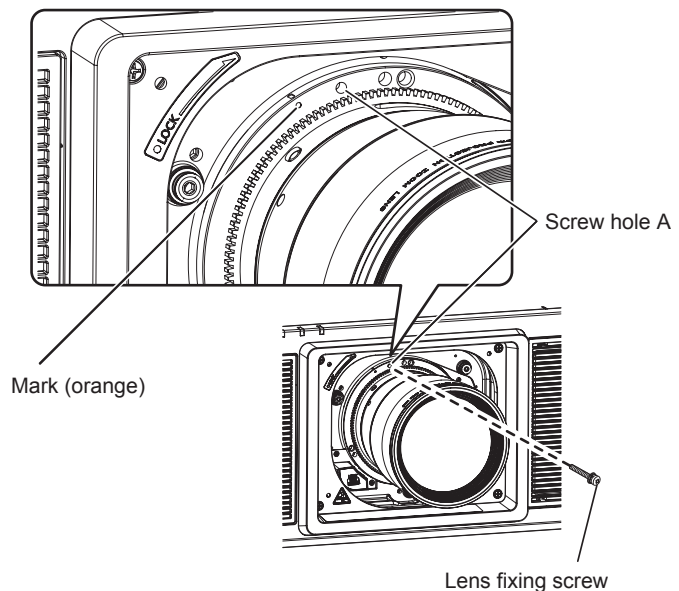

Fig. 4

- 1) **Loosen the screw fixing the lens hole cover. (Fig. 1)**
 - Use a Phillips screwdriver to turn the screw fixing the lens hole cover counterclockwise until it turns freely.
- 2) **Remove the lens hole cover. (Fig. 2)**
 - While pressing the lens release button, turn the lens hole cover counterclockwise until the mark on the lens hole cover (○) aligns with the mark on the projector (○ on the left side of LOCK).

- 3) Insert the projection lens by aligning the mark on the projection lens (orange) with the mark on the projector (○ on the left side of LOCK) and turn clockwise until it clicks. (Fig. 3)
- 4) Secure the projection lens with the supplied lens fixing screw. (Fig. 4)
 - Use a Phillips screwdriver to secure it in screw hole A located to the right of mark on the projection lens (orange).
 - Some lenses may not have a screw hole A for securing the projection lens.

Attention

- Turn the projection lens counterclockwise to confirm that it does not come out.
- Store the removed lens hole cover in a safe place.
- After attaching the projection lens, turn on the projector and confirm the [LENS TYPE] setting. Change the setting if the type is different from the projection lens attached to the projector. (➔ page 73)
Continue to execute the lens calibration after confirming the [LENS TYPE] setting. (➔ page 73)
- The lens hood needs to be mounted to the projector when using the projector in combination with the projection lenses below in the North American region. Mount the lens hood after attaching the projection lens. Always ask a qualified technician or your dealer to attach these projection lenses or to mount the lens hood.
Projection lens: ET-D75LE8, ET-D75LE30, ET-D75LE40
The lens hood is assembled and mounted to the projector using the following supplied components.
Lens hood 1, Lens hood 2, Lens hood mounting plate 1, Lens hood mounting plate 2, Lens hood screws, Knurled head screws
For the assembly and attachment, refer to the separate document “Mounting the lens hood”. The components and document of the lens hood may not be supplied depending on the country or region where you purchased the product.

Removing the projection lens

Remove the projection lens using the following procedure.

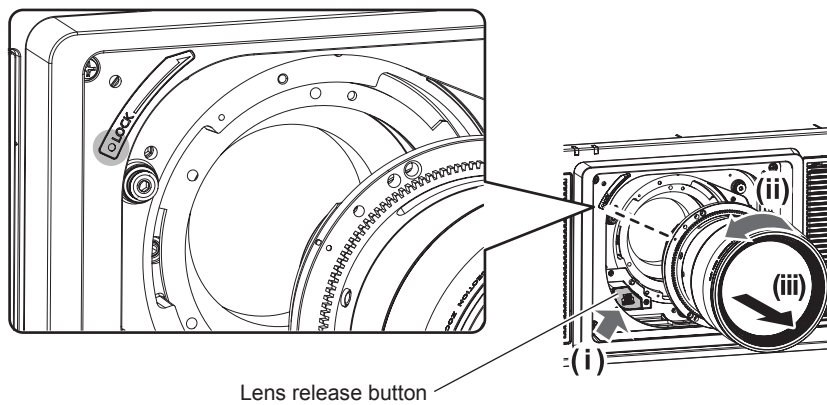

Fig. 1

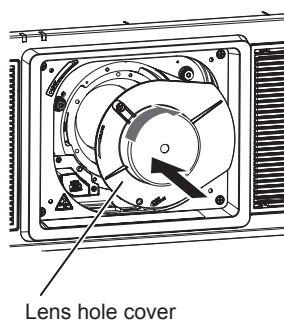

Fig. 2

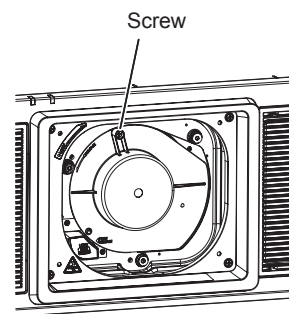

Fig. 3

- 1) Remove the lens fixing screw.
 - Use a Phillips screwdriver to remove the first screw to the right of the mark on the projection lens (orange).
- 2) Remove the projection lens by turning it counterclockwise while pressing the lens release button. (Fig. 1)
 - Turn the projection lens counterclockwise until the mark on the projection lens (orange) is aligned with the mark on the projector (○ on the left side of LOCK).
 - Proceed to Step 3) when carrying or storing the projector.

3) Attach the supplied lens hole cover. (Fig. 2)

- Insert the lens hole cover by aligning the mark on the lens hole cover (○) with the mark on the projector (○ on the left side of LOCK) and turn clockwise until it clicks.

4) Secure the lens hole cover. (Fig. 3)

- Use a Phillips screwdriver to tighten the screw fixing the lens hole cover.

Note

- Some lenses may not have a screw hole to use to secure the projection lens.

Attention

- Store the removed projection lens where it will be free from vibration and impact.
- Store the removed lens fixing screw in a safe place.

Connecting

Before connecting

- Before connecting, carefully read the operating instructions for the external device to be connected.
- Turn off the power of all devices before connecting cables.
- Take note of the following points before connecting the cables. Failure to do so may result in malfunctions.
 - When connecting a cable to a device connected to the projector or the projector itself, touch any nearby metallic objects to eliminate static electricity from your body before performing work.
 - Do not use unnecessarily long cables to connect a device to the projector or to the projector body. The longer the cable, the more susceptible to noise it becomes. Since using a cable while it is wound makes it act like an antenna, it is more susceptible to noise.
 - When connecting cables, connect GND first, then insert the connecting terminal of the connecting device in a straight manner.
- Acquire any connection cable necessary to connect the external device to the system that is neither supplied with the device nor available as an option.
- If video signals from video equipment contain too much jitter, the images on the screen may wobble. In this case, a time base corrector (TBC) must be connected.
- The projector accepts video signals, Y/C signals, YC_BC_R/YP_BP_R signals, analog RGB signals (synchronization signals are TTL level), and digital signals.
- Some computer models or graphic cards are not compatible with the projector.
- Use a cable compensator when you connect devices to the projector using long cables. Otherwise the image may not display properly.
- Refer to “List of compatible signals” (➔ page 238) for the types of video signals that can be used with the projector.

<RGB 2 IN> terminal pin assignments and signal names

Outside view	Pin No.	Signal name	Pin No.	Signal name
<p>(11) → (15)</p> <p>(6) → (10)</p> <p>(1) → (5)</p>	(1)	R/P _R	(9)	—
	(2)	G/Y	(10)	GND
	(3)	B/P _B	(11)	GND
	(4)	—	(12)	DDC data
	(5)	GND	(13)	SYNC/HD
	(6)	GND	(14)	VD
	(7)	GND	(15)	DDC clock
	(8)	GND		

<HDMI IN> terminal pin assignments and signal names

Outside view	Pin No.	Signal name	Pin No.	Signal name
<p>Even-numbered pins of (2) to (18)</p> <p>(2) → (18)</p> <p>(1) → (19)</p> <p>Odd-numbered pins of (1) to (19)</p>	(1)	T.M.D.S data 2+	(11)	T.M.D.S clock shield
	(2)	T.M.D.S data 2 shield	(12)	T.M.D.S clock-
	(3)	T.M.D.S data 2-	(13)	CEC
	(4)	T.M.D.S data 1+	(14)	—
	(5)	T.M.D.S data 1 shield	(15)	SCL
	(6)	T.M.D.S data 1-	(16)	SDA
	(7)	T.M.D.S data 0+	(17)	DDC/CEC GND
	(8)	T.M.D.S data 0 shield	(18)	+5 V
	(9)	T.M.D.S data 0-	(19)	Hot plug detection
	(10)	T.M.D.S clock+		

<DVI-D IN> terminal pin assignments and signal names

Outside view	Pin No.	Signal name	Pin No.	Signal name
	(1)	T.M.D.S data 2-	(13)	—
	(2)	T.M.D.S data 2+	(14)	+5 V
	(3)	T.M.D.S data 2/4 shield	(15)	GND
	(4)	—	(16)	Hot plug detection
	(5)	—	(17)	T.M.D.S data 0-
	(6)	DDC clock	(18)	T.M.D.S data 0+
	(7)	DDC data	(19)	T.M.D.S data 0/5 shield
	(8)	—	(20)	—
	(9)	T.M.D.S data 1-	(21)	—
	(10)	T.M.D.S data 1+	(22)	T.M.D.S clock shield
	(11)	T.M.D.S data 1/3 shield	(23)	T.M.D.S clock+
	(12)	—	(24)	T.M.D.S clock-

Connecting example: AV equipment

For <HDMI IN>/<DVI-D IN>/<RGB 1 IN> terminals

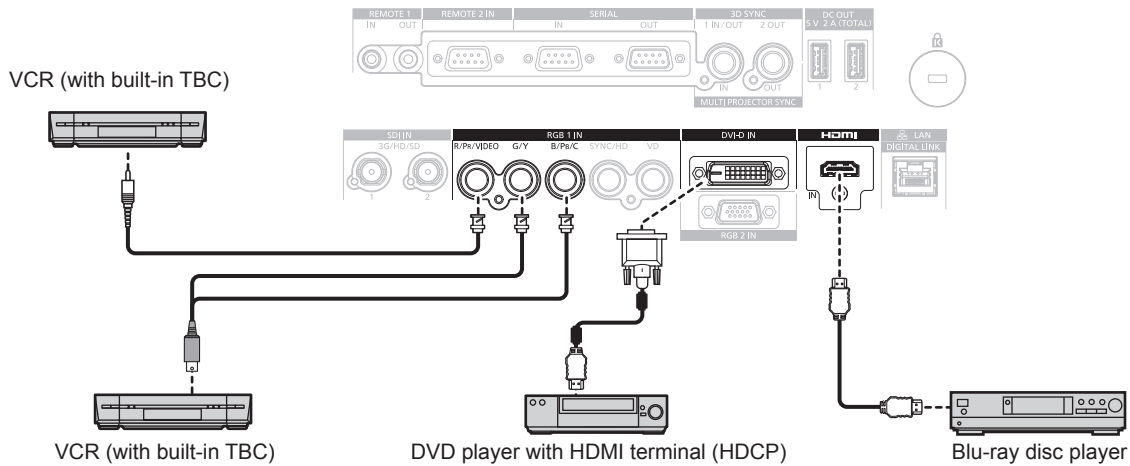

Attention

- Always use one of the following when connecting a VCR.
 - A VCR with built-in time base corrector (TBC)
 - A time base corrector (TBC) between the projector and the VCR
- If nonstandard burst signals are connected, the image may be distorted. In such a case, connect the time base corrector (TBC) between the projector and the external devices.

Note

- Switching of the setting in the [DISPLAY OPTION] menu → [DVI-D IN] → [EDID SELECT] may be required depending on the connected external device when DVI-D is input.
- The <DVI-D IN> terminal can be connected to HDMI- or DVI-D-compliant devices. However, images may not appear or may not be displayed properly on some devices.
- For the HDMI cable, use an HDMI High Speed cable that conforms to the HDMI standards. If a cable that does not conform to the HDMI standards is used, images may be interrupted or may not be displayed.
- The <HDMI IN> terminal of the projector can be connected to an external device equipped with a DVI-D terminal using an HDMI/DVI conversion cable. However, this may not function properly for some external devices, and images may not be displayed.
- The projector does not support VIERA Link (HDMI).
- It is necessary to switch the setting in the [DISPLAY OPTION] menu → [RGB IN] → [RGB1 INPUT SETTING] (➡ page 122) when inputting a video signal and the Y/C signal.

For <SDI IN 1>/<SDI IN 2> terminals

Digital VCR for commercial use

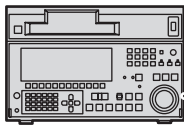

SD-SDI signal, HD-SDI signal, or 3G-SDI signal

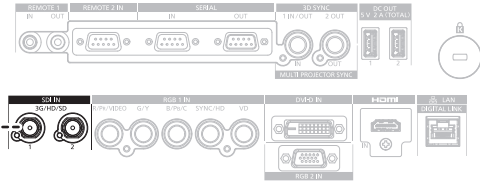

Note

- Use a 5C-FB or higher (such as 5C-FB, or 7C-FB) or a Belden 1694A or higher connection cable to properly transmit images. Use a connection cable of 100 m (328'1") length or less.
- Setting of the [DISPLAY OPTION] menu → [SDI IN] may be necessary depending on the connected external device.
- To input the dual link signals, setting the [DISPLAY OPTION] menu → [SDI IN] → [SDI LINK] is required.
- To input the dual link signals, the cables to connect to the <SDI IN 1>/<SDI IN 2> terminals should be the same length and the same type. The image may not be displayed correctly when the difference of the cable length is 4 m (13'1") or more.
- Directly connect the projector with the external device that will output the signal without going through a distributor, etc., when inputting dual link signals. A phase difference is generated between the Link A signal and the Link B signal, and the image may not be projected correctly.
- An error in signal detection may occur when an unsteady signal is connected. In such case, set the [DISPLAY OPTION] menu → [SDI IN] to the content corresponding to the input signal.

Connecting example: Computers

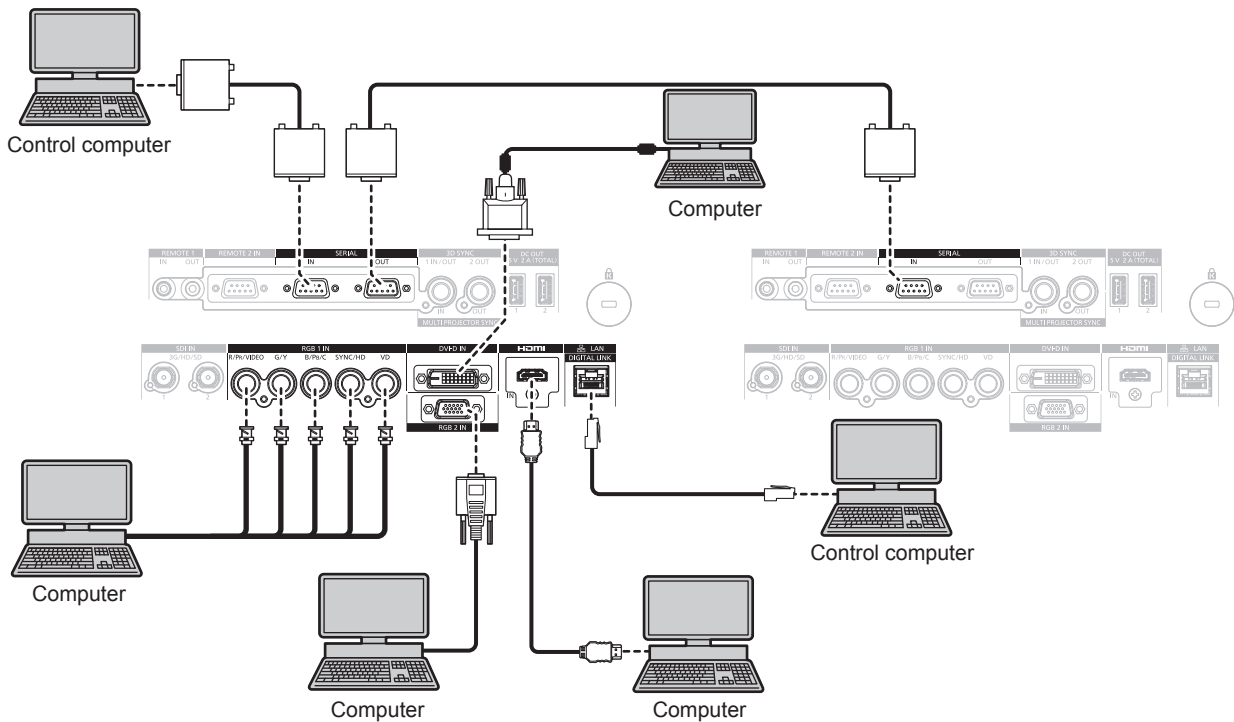

Attention

- When connecting the projector to a computer or an external device, use the power cord supplied with each device and commercially available shielded cables.

Note

- Switching of the setting in the [DISPLAY OPTION] menu → [DVI-D IN] → [EDID SELECT] may be required depending on the connected external device when DVI-D is input.
- For the HDMI cable, use an HDMI High Speed cable that conforms to the HDMI standards. If a cable that does not conform to the HDMI standards is used, images may be interrupted or may not be displayed.
- The <HDMI IN> terminal of the projector can be connected to an external device equipped with a DVI-D terminal using an HDMI/DVI conversion cable. However, this may not function properly for some external devices, and images may not be displayed.
- The <DVI-D IN> terminal supports single links only.
- When entering the SYNC ON GREEN signal, do not enter sync signals to the <SYNC/HD> terminal or the <VD> terminal.
- If you operate the projector using the computer with the resume feature (last memory), you may have to reset the resume feature to operate the projector.

Connecting example using DIGITAL LINK

Twisted-pair-cable transmitter based on the communication standard HDBaseT™ such as the optional DIGITAL LINK output supported device (Model No.: ET-YFB100G, ET-YFB200G) uses the twisted pair cable to transmit input images, Ethernet, and serial control signal, and the projector can input such digital signal to the <DIGITAL LINK/LAN> terminal.

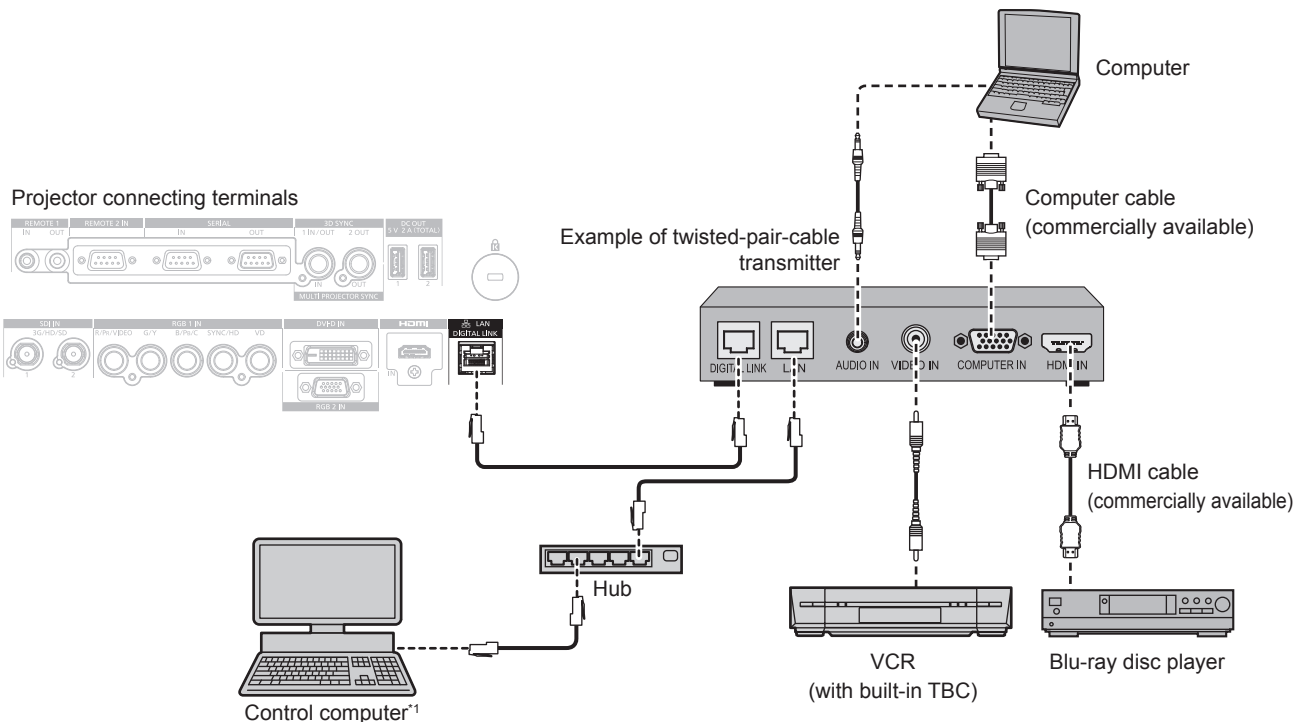

*1 Control target is the projector or the twisted-pair-cable transmitter. The control itself may not be possible depending on the twisted-pair-cable transmitter. Check the operating instructions of the device to be connected.

Attention

- Always use one of the following when connecting a VCR.
 - Use a VCR with built-in time base corrector (TBC).
 - Use a time base corrector (TBC) between the projector and the VCR.
- If nonstandard burst signals are connected, the image may be disrupted. In such a case, connect the time base corrector (TBC) between the projector and the external devices.
- Ask a qualified technician or your dealer to install the cable wiring between the twisted-pair-cable transmitter and the projector. Image may be disrupted if cable transmission characteristics cannot be obtained due to inadequate installation.
- For the LAN cable between the twisted-pair-cable transmitter and the projector, use a cable that meets the following criteria:
 - Conforming to CAT5e or higher standards
 - Shielded type (including connectors)
 - Straight-through
 - Single wire
- When laying cables between the twisted-pair-cable transmitter and the projector, confirm that cable characteristics are compatible with CAT5e or higher using tools such as a cable tester or cable analyzer. When a relay connector is used, include it in the measurement.
- Do not use a hub between the twisted-pair-cable transmitter and the projector.
- When connecting to the projector using a twisted-pair-cable transmitter (receiver) of other manufacturers, do not place another twisted-pair-cable transmitter between the twisted-pair-cable transmitter of other manufacturers and the projector. This may cause image to be disrupted.
- Do not pull cables forcefully. Also, do not bend or fold cables unnecessarily.
- To reduce the effects of noise as much as possible, stretch out the cables between the twisted-pair-cable transmitter and the projector without any loops.
- Lay the cables between the twisted-pair-cable transmitter and the projector away from other cables, particularly power cables.
- When laying multiple cables, run them side by side along the shortest distance possible without bundling them together.
- After laying the cables, go to the [NETWORK] menu → [DIGITAL LINK STATUS] and confirm that the value of [SIGNAL QUALITY] is displayed in green which indicates normal quality. (► page 182)

Note

- For the HDMI cable, use an HDMI High Speed cable that conforms to the HDMI standards. If a cable that does not conform to the HDMI standards is used, images may be interrupted or may not be displayed.
- The projector does not support VIERA Link (HDMI).
- The maximum transmission distance between the twisted-pair-cable transmitter and the projector is 100 m (328'1"). It is possible to transmit up to 150 m (492'2") if the twisted-pair-cable transmitter supports the long-reach communication method. If this distance is exceeded, image may be disrupted or a malfunction may occur in LAN communication. Please note that Panasonic does not support the use of the projector outside the maximum transmission distance. When connecting with the long reach, there may be a limitation to the video signal or distance which can be transmitted, depending on the specification of the twisted-pair-cable transmitter.

- For twisted-pair-cable transmitters of other manufacturers of which the operation has been verified with the projector, visit the Panasonic website (<https://panasonic.net/cns/projector/>). Note that the verification for devices of other manufacturers has been made for the items set by Panasonic Corporation, and not all the operations have been verified. For operation or performance problems caused by the devices of other manufacturers, contact the respective manufacturers.

Connecting example when using the contrast synchronization function/shutter synchronization function

In a case to construct a multi-display by linking projected images from multiple projectors, following functions can be used by synchronizing multiple projectors using the <MULTI PROJECTOR SYNC IN> terminal and the <MULTI PROJECTOR SYNC OUT> terminal.

• Contrast synchronization function

A linked screen with balanced contrast can be displayed by sharing the brightness level of the video signal being input to each projector.

To use this function, set the [PROJECTOR SETUP] menu → [MULTI PROJECTOR SYNC] for each synchronized projector as follows.

- Set [MULTI PROJECTOR SYNC] → [MODE] to anything other than [OFF].
 - Set [MODE] to [MASTER] only on one projector that is synchronized. Set [MODE] to [SLAVE] for all other projectors.
- Set [MULTI PROJECTOR SYNC] → [CONTRAST SYNC] to [ON].

• Shutter synchronization function

This is a function to synchronize the shutter operation of the specified projector to other projectors, and the effect using the shutter function including the fade in/fade out operation can be synchronized.

To use this function, set the [PROJECTOR SETUP] menu → [MULTI PROJECTOR SYNC] for each synchronized projector as follows.

- Set [MULTI PROJECTOR SYNC] → [MODE] to anything other than [OFF].
 - Set [MODE] to [MASTER] only on one projector that becomes the synchronization source within the linked projectors. Set [MODE] to [SLAVE] for all other projectors.
- Set [MULTI PROJECTOR SYNC] → [SHUTTER SYNC] to [ON].

■ Connecting example

Connect all the projectors to be linked in a loop by daisy chain connection when using the contrast synchronization function/shutter synchronization function. The number of linked projectors is limited to the maximum of 64 projectors.

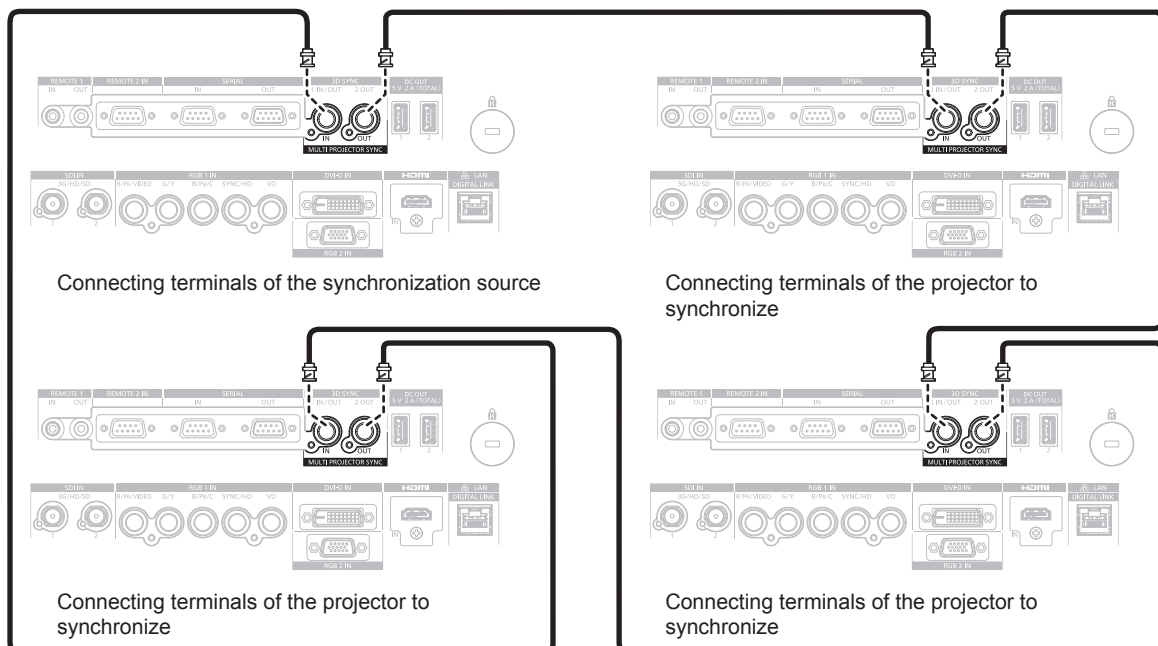

Note

- The contrast synchronization function and the shutter synchronization function can be used simultaneously.
- For details on the settings of the contrast synchronization function and the shutter synchronization function, refer to the [PROJECTOR SETUP] menu → [MULTI PROJECTOR SYNC] (➔ page 163).
- The menu items in the [PROJECTOR SETUP] menu → [MULTI PROJECTOR SYNC] is the same as the following setting items.
 - The [PICTURE] menu → [DYNAMIC CONTRAST] → [USER] → [MULTI PROJECTOR SYNC]
 - The [DISPLAY OPTION] menu → [SHUTTER SETTING] → [MULTI PROJECTOR SYNC]
- If there are any projectors which you do not want to synchronize within the linked projectors, set [CONTRAST SYNC] and [SHUTTER SYNC] to [OFF] individually.

Chapter 3 Basic Operations

This chapter describes basic operations to start with.

Switching on/off the projector

Connecting the power cord

To prevent disconnection of the power cord, use the supplied power cord and securely insert all the way in to fix it.

Confirm that the <MAIN POWER> switch is on the <OFF> side before connecting the supplied power cord.

Use the power cord matching with the power supply voltage and the shape of the outlet.

For details of power cord handling, refer to “Read this first!” (➔ page 5). For the shape of the outlet, refer to “Usable outlet” (➔ page 36).

Note

- The light output will decrease to approximately 1/2 when using the projector with AC 100 V to AC 120 V.
- The supplied power cords vary depending on the country or region where you purchased the product.

How to attach the power cord

For India

- 1) Check the shapes of the <AC IN> terminal on the side of the projector and the power cord connector, then insert the connector completely in the correct direction.

For other countries or regions

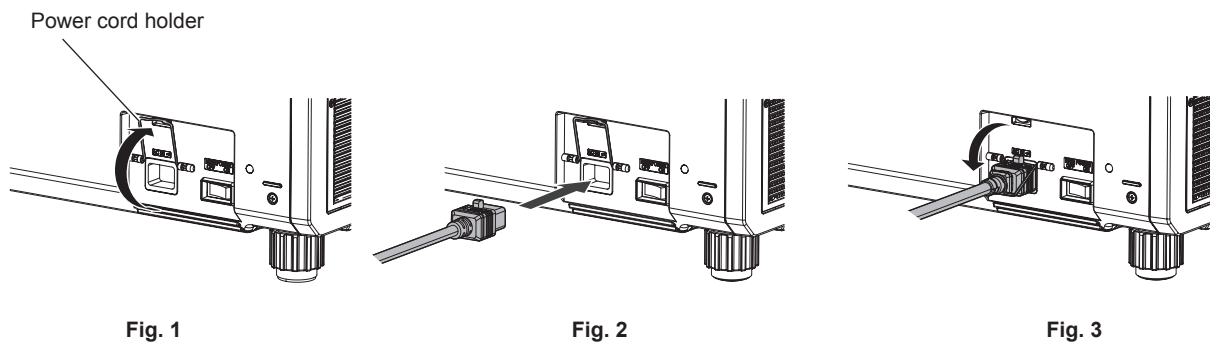

- 1) Confirm that the power cord holder is raised so that the power cord can be inserted. (Fig. 1)
- 2) Check the shapes of the <AC IN> terminal on the side of the projector and the power cord connector, then insert the connector completely in the correct direction. (Fig. 2)
- 3) Lower the power cord holder so it snaps onto the power cord, and fix the power cord. (Fig. 3)

How to remove the power cord

For India

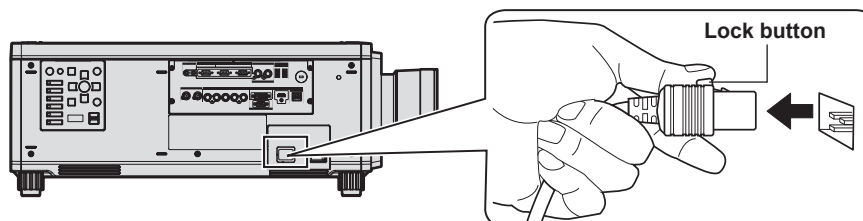

- 1) Confirm that the <MAIN POWER> switch on the side of the projector is on the <OFF> side, and remove the power plug from the outlet.
- 2) Remove the power cord connector from the <AC IN> terminal of the projector while pressing the lock button.

For other countries or regions (when using the power cord with the lock button)

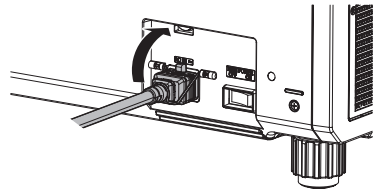

Fig. 1

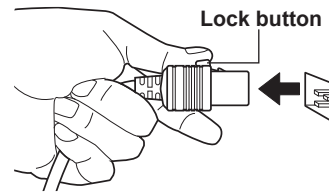

Fig. 2

- 1) Confirm that the <MAIN POWER> switch on the side of the projector is on the <OFF> side, and remove the power plug from the outlet.
- 2) Raise the power cord holder fixing the power cord upward. (Fig. 1)
 - Fix the power cord holder by snapping into the projector.
- 3) Remove the power cord connector from the <AC IN> terminal of the projector while pressing the lock button. (Fig. 2)

For other countries or regions (when using the power cord without the lock button)

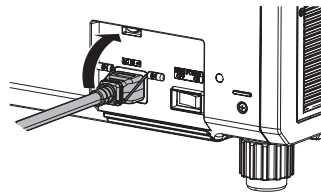

Fig. 1

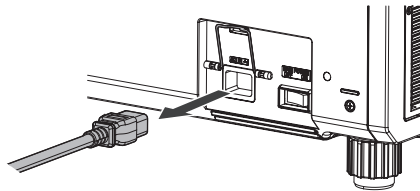
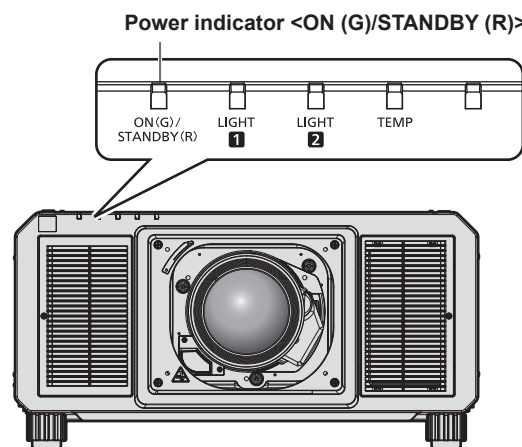

Fig. 2

- 1) Confirm that the <MAIN POWER> switch on the side of the projector is on the <OFF> side, and remove the power plug from the outlet.
- 2) Raise the power cord holder fixing the power cord upward. (Fig. 1)
 - Fix the power cord holder by snapping into the projector.
- 3) While holding the power cord connector, pull out the power cord from the <AC IN> terminal of the projector. (Fig. 2)

Power indicator

Indicate the status of the power. Check the status of the power indicator <ON (G)/STANDBY (R)> before operating the projector.



Indicator status	Projector status
Off	The main power is switched off.

Indicator status		Projector status
Red	Lit	The power is switched off. (standby mode) Projection will start when the power on < > button is pressed. • The projector may not operate when the light source indicators <LIGHT1>/<LIGHT2> or the temperature indicator <TEMP> are blinking. (➔ page 210)
Green	Lit	Projecting.
Orange	Lit	The projector is preparing to switch off the projector. The power is switched off after a while. (Changes to the standby mode.)

Note

- While the power indicator <ON (G)/STANDBY (R)> lights in orange, the fan is running to cool the projector.
- For approximately 15 seconds after the projector is switched off, the indicator does not light up even if the power is switched on. Turn on the power again after the power indicator <ON (G)/STANDBY (R)> lights in red.
- The projector consumes power even in standby mode (power indicator <ON (G)/STANDBY (R)> lit in red). Refer to “Power consumption” (➔ page 246) for the power consumption.
- When the projector receives the signal from the remote control, the power indicator <ON (G)/STANDBY (R)> will blink in the following color according to the status of the projector.
 - When the projector is in projection mode: Green
 - When the projector is in standby mode: Orange
 However, if the [PROJECTOR SETUP] menu → [STANDBY MODE] is set to [ECO], the indicator will stay lit in red and will not blink if the projector is in standby mode.
- The power indicator <ON (G)/STANDBY (R)> will blink slowly in green while the shutter function is in use (shutter: closed), or while the function of the [PROJECTOR SETUP] menu → [NO SIGNAL LIGHTS-OUT] (➔ page 159) is operating and the light source is turned off.
- If the power indicator <ON (G)/STANDBY (R)> is blinking in red, consult your dealer.

Switching on the projector

Install the projection lens before switching on the projector.

Remove the lens cover first.

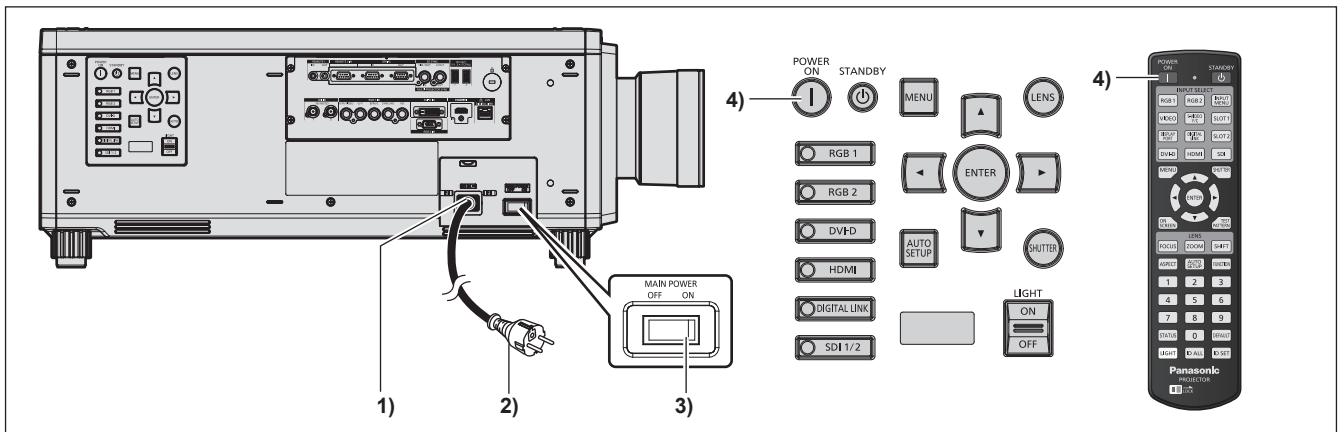

- 1) **Connect the power cord to the projector.**
- 2) **Connect the power plug to an outlet.**
- 3) **Press the <ON> side of the <MAIN POWER> switch to turn on the power.**
 - The power indicator <ON (G)/STANDBY (R)> lights in red, and the projector enters the standby mode.
- 4) **Press the power on <|> button.**
 - The power indicator <ON (G)/STANDBY (R)> lights in green and the image is soon projected on the screen.

Attention

- Always remove the lens cover before starting the projection. Projecting continuously while the lens cover is attached may cause the lens cover to heat up and result in a fire.

Note

- A warm-up period of up to approximately five minutes may be necessary until an image is displayed when the projector is switched on at around 0 °C (32 °F).
The temperature indicator <TEMP> lights during the warm-up period. When the warm-up is completed, the temperature indicator <TEMP> turns off and the projection starts. Refer to “When an indicator lights up” (➔ page 210) for the indicator status display.
- If the operating environment temperature is low and warm-up takes more than five minutes, the projector will judge that a problem has occurred and the power will automatically be set to standby mode. In such case, increase the operating environment temperature to 0 °C (32 °F) or higher, turn off the main power, and then turn on the power again.

- It may take longer to start the projection when the [PROJECTOR SETUP] menu → [STANDBY MODE] is set to [ECO] compared to the time when it is set to [NORMAL].
- If the power was turned off at the previous use by pressing the <OFF> side of the <MAIN POWER> switch or by using the breaker directly while projecting, the power indicator <ON (G)/STANDBY (R)> lights up in green and an image is projected after a while when the power is turned on by pressing the <ON> side of the <MAIN POWER> switch or by turning the breaker on with the power plug connected to the outlet. This applies only when the [PROJECTOR SETUP] menu → [INITIAL STARTUP] is set to [LAST MEMORY].
- The light output will decrease to approximately 1/2 when using the projector with AC 100 V to AC 120 V.

When the initial setting screen is displayed

When the projector is switched on for the first time after purchase, as well as when the [PROJECTOR SETUP] menu → [INITIALIZE] → [ALL USER DATA] is executed, the focus adjustment screen is displayed after projection starts, and then the **[INITIAL SETTING]** screen is displayed. Set them according to the circumstances.

In other occasions, you can change the settings by menu operations.

If you press the <MENU> button while the **[INITIAL SETTING]** screen is displayed, you can go back to the previous screen.

Focus adjustment

Adjust the focus to display the menu screen clearly.

You may also need to adjust the zoom and lens shift.

Refer to “Adjusting the focus, zoom, and lens shift” (➔ page 71) for details.

- 1) Press ▲▼◀▶ to adjust the focus.

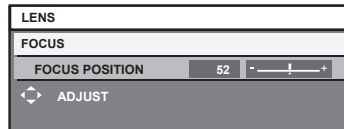

- 2) Press the <MENU> button to proceed to the initial setting.

Initial setting (display language)

Select the language to show on the screen.

After completed the initial setting, you can change the display language from the [DISPLAY LANGUAGE] menu.

- 1) Press ▲▼ to select the display language.

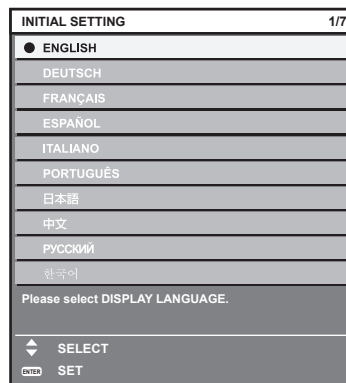

- 2) Press the <ENTER> button to proceed to the initial setting.

Initial setting (operation setting)

Set the items for the operating method depending on the projector's application and duration of usage.

After completed the initial setting, you can change the settings of each item from the [PROJECTOR SETUP] menu → [OPERATION SETTING]. If you change the settings while using the projector, the duration until the luminance of light source decreases by half may shorten or the luminance may decrease.

This initial setting (operation setting) is prepared to complete the settings at once during the installation when the operation of the projector is predetermined. When the [PROJECTOR SETUP] menu → [INITIALIZE] → [ALL USER DATA] is executed, do not change the setting in the initial setting (operation setting), but press the <ENTER> button and proceed to next initial setting (installation setting). If you need to change the setting, ask the person responsible for this projector (such as a person in charge of equipment or operation).

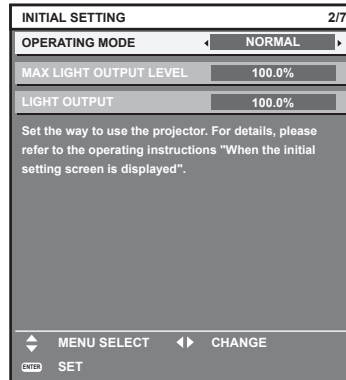

Note

- The preceding initial setting screen is displayed when the projector is switched on for the first time after purchase. If the [PROJECTOR SETUP] menu → [INITIALIZE] → [ALL USER DATA] is executed, the settings before execution are displayed in [OPERATING MODE] and [MAX LIGHT OUTPUT LEVEL].
- For the relationship between the luminance and the runtime, refer to "Interrelation of luminance and runtime" (➔ page 64).
- For details on each setting item, refer to the [PROJECTOR SETUP] menu → [OPERATION SETTING].

1) Press ▲▼ to select [OPERATING MODE].

2) Press ◀▶ to switch the item.

- The items will switch each time you press the button.

[NORMAL]*1	Set this item when high luminance is required. The estimated runtime is approximately 20 000 hours.
[ECO]*1	The luminance will decrease compared to [NORMAL], but set this item to increase the expected life of the light source. The estimated runtime is approximately 24 000 hours.
[USER1]	Set [MAX LIGHT OUTPUT LEVEL] and [LIGHT OUTPUT] individually.
[USER2]	
[USER3]	

*1 The runtime is an estimation when the [PICTURE] menu → [DYNAMIC CONTRAST] is set to [3].

- When [NORMAL] or [ECO] is selected, proceed to Step 5).

3) Press ▲▼ to select [MAX LIGHT OUTPUT LEVEL].

4) Press ◀▶ to adjust.

Operation	Adjustment	Range of adjustment
Press ▶.	Increases the maximum level of brightness correction.	8.0 % - 100.0 %
Press ◀.	Decreases the maximum level of brightness correction.	

5) Press ▲▼ to select [LIGHT OUTPUT].

6) Press ◀▶ to adjust.

Operation	Adjustment		Range of adjustment
	Brightness	Runtime	
Press ▶.	The screen becomes brighter.	The runtime becomes shorter.	8.0 % - 100.0 %
Press ◀.	The screen becomes darker.	The runtime becomes longer.	

7) Press the <ENTER> button to proceed to the initial setting.

Interrelation of luminance and runtime

The projector can be operated at arbitrary brightness and duration of use by combining the settings of [MAX LIGHT OUTPUT LEVEL] and [LIGHT OUTPUT].

Interrelation of luminance and runtime is as follows. Make the initial setting (operation setting) depending on your desired duration of use and brightness of the projected image.

Values of the luminance and runtime are rough estimations.

■ **To set the projector based on the duration of use**

Duration of use (hour)	[MAX LIGHT OUTPUT LEVEL] (%)	[LIGHT OUTPUT] (%)	Luminance (lm)
20 000	100.0	100.0	20 000
24 000	100.0	100.0	20 000
27 000	100.0	88.4	17 600
31 000	100.0	74.9	14 900
35 000	100.0	64.3	12 800
40 000	—	—	—

■ **To set the projector based on luminance**

Luminance (lm)	[MAX LIGHT OUTPUT LEVEL] (%)	[LIGHT OUTPUT] (%)	Runtime (hour)
20 000	100.0	100.0	24 290
18 000	100.0	90.0	26 600
16 000	100.0	80.0	29 370
14 000	100.0	70.0	32 730
12 000	100.0	60.0	36 900
10 000	—	—	—
8 000	—	—	—
6 000	—	—	—
4 000	—	—	—

Note

- Under influence of characteristics of each light source, conditions of use, installation environment, etc., the runtime may be shorter than the estimation.
- The duration of use is referred to as the runtime when you use the projector successively. The duration of use is an estimated duration and is not the warranty period.
- The estimated runtime is a time for the luminance to decrease to half.
- If the consolidated runtime of the projector exceeds 20 000 hours, replacement of the components inside the projector may be required. The consolidated runtime can be confirmed in the [STATUS] screen. Refer to the [PROJECTOR SETUP] menu → [STATUS] for details.
- After completed the initial setting, the wider the combination of luminance and runtime becomes by setting the [PROJECTOR SETUP] menu → [BRIGHTNESS CONTROL] → [BRIGHTNESS CONTROL SETUP] → [CONSTANT MODE] to [AUTO] or [PC]. Refer to the [PROJECTOR SETUP] menu → [BRIGHTNESS CONTROL] for details.

Initial setting (installation setting)

Set [FRONT/REAR] and [FLOOR/CEILING] in [PROJECTION METHOD] depending on the installation mode. Refer to “Installation mode” (➔ page 36) for details.

After completed the initial setting, you can change the setting from the [PROJECTOR SETUP] menu → [PROJECTION METHOD].

1) Press ◀▶ to switch the setting.

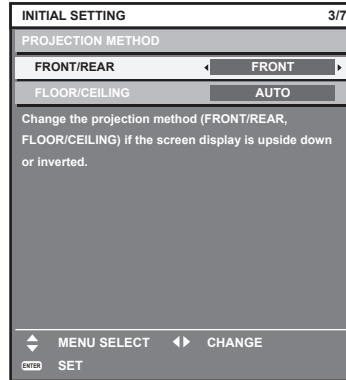

2) Press the <ENTER> button to proceed to the initial setting.

Initial setting (standby mode)

Set the operation mode during standby. The factory default setting is [NORMAL], which allows you to use the network function during standby. To keep power consumption low during standby, set this item to [ECO]. After completed the initial setting, you can change the setting from the [PROJECTOR SETUP] menu → [STANDBY MODE].

1) Press ◀▶ to switch the setting.

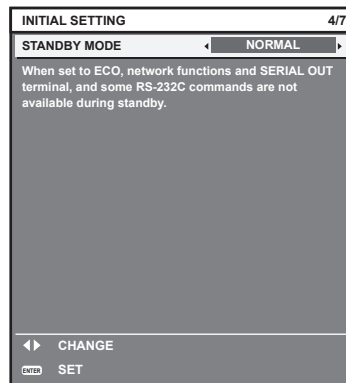

2) Press the <ENTER> button to proceed to the initial setting.

Note

- The preceding initial setting screen is displayed when the projector is switched on for the first time after purchase. When the [PROJECTOR SETUP] menu → [INITIALIZE] → [ALL USER DATA] is executed, the [STANDBY MODE] setting before execution is displayed.

Initial setting (screen setting)

Set the screen format (aspect ratio) and display position of the image. After completed the initial setting, you can change the settings of each item from the [DISPLAY OPTION] menu → [SCREEN SETTING].

1) Press ◀▶ to switch the setting.

- The setting will change each time you press the button.

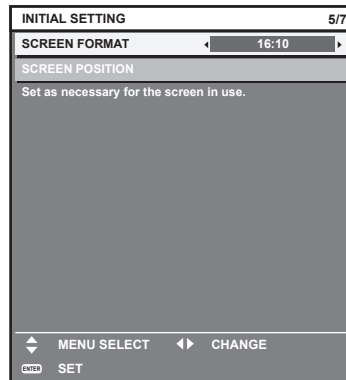

2) Press ▲▼ to select [SCREEN POSITION].

- [SCREEN POSITION] cannot be selected or adjusted when [SCREEN FORMAT] is set to the following item.

PT-RZ21K: [16:10]

PT-RS20K: [4:3]

3) Press ◀▶ to adjust.

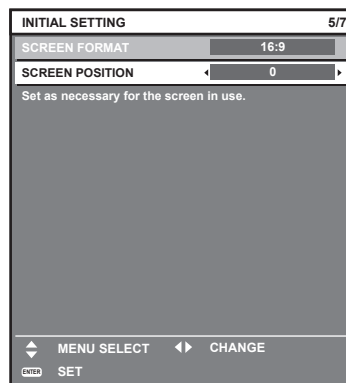

4) Press the <ENTER> button to proceed to the initial setting.

Initial setting (time zone)

Set [TIME ZONE] in accordance with the country or region where you use the projector.

After completed the initial setting, you can change the setting from the [PROJECTOR SETUP] menu → [DATE AND TIME]. The current settings are displayed in [LOCAL DATE] and [LOCAL TIME].

1) Press ◀▶ to switch the setting.

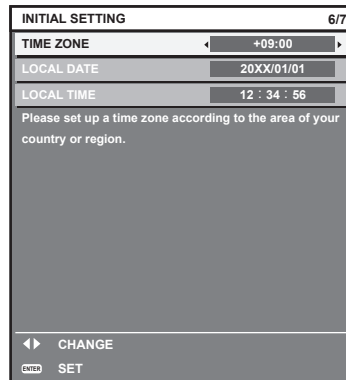

2) Press the <ENTER> button to proceed to the initial setting.

Note

- In the factory default setting, the time zone of the projector is set to +09:00 (Japan and Korea Standard Time). Change the setting of the [PROJECTOR SETUP] menu → [DATE AND TIME] → [TIME ZONE] to the time zone of the region where you use the projector.

Initial setting (date and time)

Set the local date and time. After completed the initial setting, you can change the setting from the [PROJECTOR SETUP] menu → [DATE AND TIME].

To set the date and time automatically, refer to “Setting the date and time automatically” (➔ page 161).

1) Press ▲▼ to select an item.

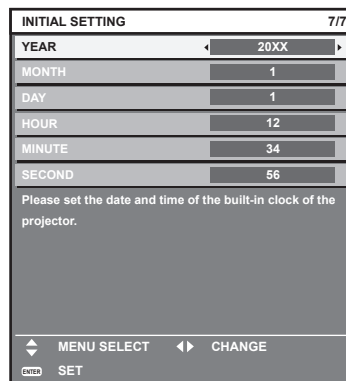

2) Press ◀▶ to switch the setting.

3) Press the <ENTER> button.

- Confirm the setting value and complete the initial setting.

Making adjustments and selections

It is recommended to perform the focus adjustment after 30 minutes have elapsed with the focus test pattern displayed. For details of the test pattern, refer to “[TEST PATTERN] menu” (➔ page 174). To use the active focus optimizer function, set the [PROJECTOR SETUP] menu → [LENS] → [ACTIVE FOCUS OPTIMIZER] → [ACTIVE FOCUS] to [ON], and then adjust the focus. (➔ page 145)

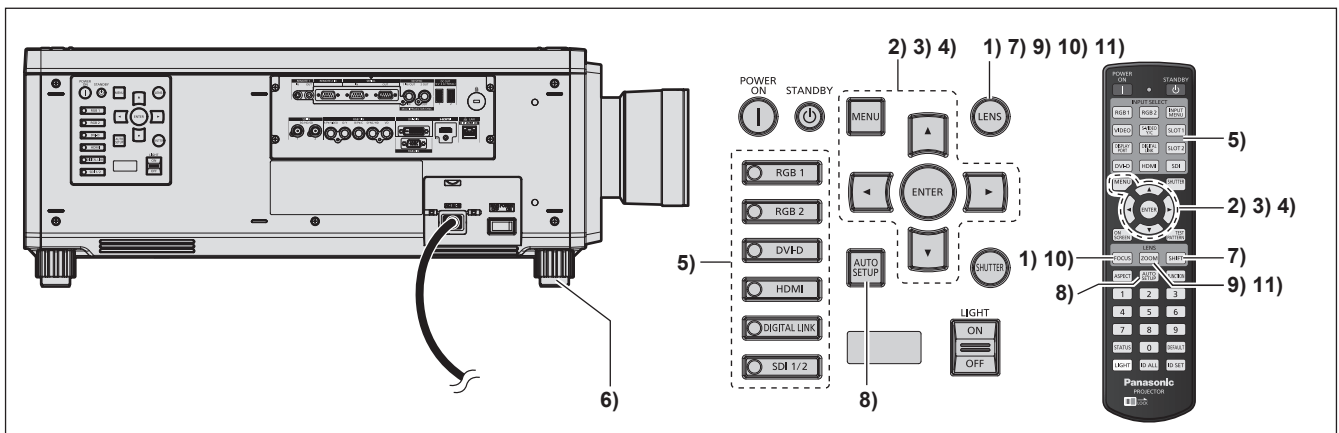

- 1) Press the <FOCUS> button to roughly adjust the focus of the projected image. (➔ page 71)
- 2) Change the setting of the [PROJECTOR SETUP] menu → [PROJECTION METHOD] depending on the installation mode. (➔ page 36)
 - Refer to “Navigating through the menu” (➔ page 85) for the operation of the menu screen.
- 3) Set [LENS TYPE].
 - Confirm the setting of the lens type when using the projector for the first time after attaching the projection lens. (➔ page 73)
- 4) Execute the lens calibration.
 - Execute the lens calibration when using the projector for the first time after attaching the projection lens. (➔ page 73)
- 5) Press the input selection button (<RGB1>, <RGB2>, <DIGITAL LINK>, <DVI-D>, <HDMI>, <SDI>, <SDI 1/2>) to select the input signal.
- 6) Adjust the front, back and sideways tilt of the projector with the adjustable feet. (➔ page 48)
- 7) Press the <SHIFT> button to adjust the position of the projected image.
- 8) If the input signal is the analog RGB signal or the DVI-D/HDMI signal, press the <AUTO SETUP> button.
- 9) Press the <ZOOM> button to match the projected image size to the screen.
- 10) Press the <FOCUS> button again to adjust the focus.
- 11) Press the <ZOOM> button again to adjust the zoom and match the projected image size to the screen.

Note

- When the projector is switched on for the first time after purchase, as well as when the [PROJECTOR SETUP] menu → [INITIALIZE] → [ALL USER DATA] is executed, the focus adjustment screen is displayed after projection starts, and then the [INITIAL SETTING] screen is displayed. For details, refer to “When the initial setting screen is displayed” (➔ page 62).

Switching off the projector

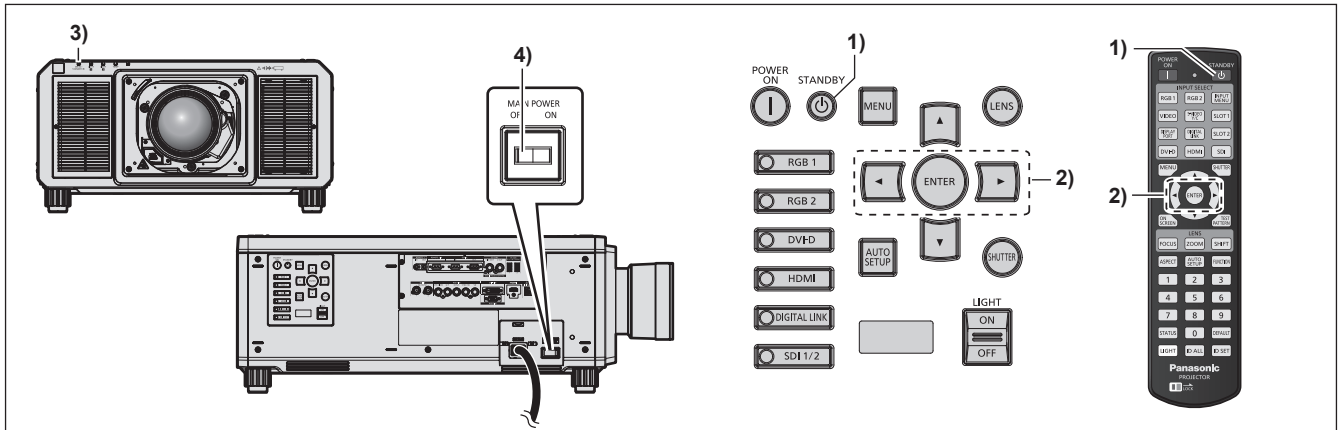

- 1) Press the power standby <⏻> button.
 - The [POWER OFF(STANDBY)] confirmation screen is displayed.
- 2) Press ◀▶ to select [OK], and press the <ENTER> button.
(Or press the power standby <⏻> button again.)
 - Projection of the image will stop, and the power indicator <ON (G)/STANDBY (R)> on the projector body lights in orange. (The fan keeps running.)
- 3) Wait for a few seconds until the power indicator <ON (G)/STANDBY (R)> of the projector body lights up in red (fan is stopped).
- 4) Press the <OFF> side of the <MAIN POWER> switch to turn off the power.

Attention

- When switching off the projector, make sure to follow the procedures described. Failure to do so may damage the internal components and result in malfunctions.

Note

- For approximately 15 seconds after the projector is switched off, the indicator does not light up even if the power is switched on.
- **Even when the power standby <⏻> button is pressed and the projector is switched off, the projector consumes power if the main power of the projector is on.**
When the [PROJECTOR SETUP] menu → [STANDBY MODE] is set to [ECO], use of some functions is restricted, but the power consumption during standby can be conserved.
- The <MAIN POWER> switch of the projector is equipped with an overcurrent protection function. When current exceeding 25 A is detected, the overcurrent is automatically disconnected and the projector will go into the state that the <OFF> side is pressed. Consult your dealer when the overcurrent protection function is operated.

Projecting

Check the projection lens attachment (➔ page 49), external device connection (➔ page 52), and power cord connection (➔ page 59), and then switch on the power (➔ page 61) to start projecting. Select the video for projection, and adjust appearance of the projected image.

Selecting the input signal

The input of the image to project can be switched. Method to switch the input is as follows.

- Press the input selection button and directly specify the input of the image to project.
- Display the input selection screen and select the input of the image to project from the list.

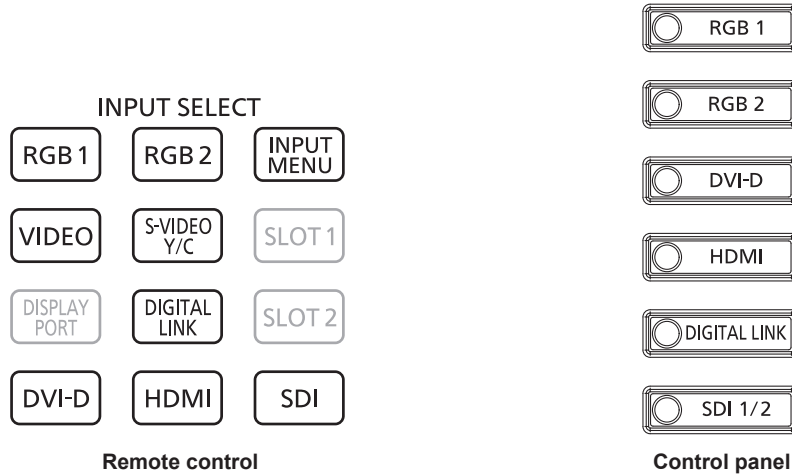

Switching the input directly

The input of the image for projection can be switched by directly specifying it with the input selection button on the remote control or the control panel.

- 1) Press the input selection button (<RGB1>, <RGB2>, <VIDEO>, <S-VIDEO Y/C>, <DIGITAL LINK>, <DVI-D>, <HDMI>, <SDI> or <SDI 1/2>).

<RGB1> <VIDEO> <S-VIDEO Y/C>	Switches the input to RGB1. The image of the signal input to the <RGB 1 IN> terminal (<R/P _R /VIDEO>, <G/Y>, <B/P _B /C>, <SYNC/HD>, <VD>) is projected.
<RGB2>	Switches the input to RGB2. The image of the signal input to the <RGB 2 IN> terminal is projected.
<DIGITAL LINK>	Switches the input to DIGITAL LINK. The image of the signal input to the <DIGITAL LINK/LAN> terminal is projected.
<DVI-D>	Switches the input to DVI-D. The image of the signal input to the <DVI-D IN> terminal is projected.
<HDMI>	Switches the input to HDMI. The image of the signal input to the <HDMI IN> terminal is projected.
<SDI> <SDI 1/2>	Switches the input to SDI1 or SDI2. The image of the signal input to the <SDI IN 1> terminal or the <SDI IN 2> terminal is projected. Switches to the other input when one input has already been selected. Input selection can be fixed to SDI1 or SDI2 using the [SECURITY] menu → [CONTROL DEVICE SETUP].

Attention

- Images may not be projected properly depending on the external device, or the Blu-ray disc or DVD disc, to be played back.
Set the [PICTURE] menu → [SYSTEM SELECTOR]. When the SDI signal is input, set the [DISPLAY OPTION] menu → [SDI IN].
- Confirm the aspect ratio of the projection screen and the image, and switch to an optimum aspect ratio from the [POSITION] menu → [ASPECT].

Note

- When the optional DIGITAL LINK output supported device (Model No.: ET-YFB100G, ET-YFB200G) is connected to the <DIGITAL LINK/LAN> terminal, the input on the DIGITAL LINK output supported device changes each time the <DIGITAL LINK> button is pressed. The input can also be changed using the RS-232C control command.
For twisted-pair-cable transmitters of other manufacturers, switch the input on the projector to DIGITAL LINK, and then switch the input on the twisted-pair-cable transmitter.

- Set the [DISPLAY OPTION] menu → [RGB IN] → [RGB1 INPUT SETTING] in accordance with the signal input to the <RGB 1 IN> terminal.

Switching the input by displaying the input selection screen

The input of the image for projection can be selected by displaying the input selection screen.

1) Press the <INPUT MENU> button on the remote control.

- The input selection screen is displayed.

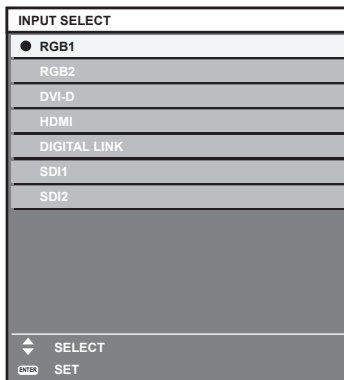

2) Press the <INPUT MENU> button again.

- The input will switch each time you press the <INPUT MENU> button.

Note

- Input can be switched by pressing ▲▼ to select the input of the image for projection and pressing the <ENTER> button while the input selection screen is displayed.
- The [P IN P MODE] screen is displayed when the <INPUT MENU> button is pressed while in the P IN P. (➔ page 172)
- If the optional DIGITAL LINK output supported device (Model No.: ET-YFB100G, ET-YFB200G) is connected to the projector, the input selection menu for the DIGITAL LINK output supported device is displayed when the <ENTER> button is pressed while the DIGITAL LINK input is selected in the input selection screen.
- If the optional DIGITAL LINK output supported device (Model No.: ET-YFB100G, ET-YFB200G) is connected to the projector, the DIGITAL LINK logo and the input name selected in the DIGITAL LINK output supported device are displayed in the display section of the [DIGITAL LINK] in the input selection screen.
- Set the [DISPLAY OPTION] menu → [RGB IN] → [RGB1 INPUT SETTING] in accordance with the signal input to the <RGB 1 IN> terminal.

Adjusting the focus, zoom, and lens shift

Adjust the focus, zoom, and lens shift if the image projected to the screen or its position is shifted even if the projector and the screen are set up in the correct positions.

This section describes the adjustment method when anything other than the Fixed-focus Lens (Model No.: ET-D75LE95, ET-D75LE90) is used. When the Fixed-focus Lens (Model No.: ET-D75LE95, ET-D75LE90) is used, refer to “Adjusting the focus when the Fixed-focus Lens (Model No.: ET-D75LE95, ET-D75LE90) is used” (➔ page 72).

Using the control panel

1) Press the <LENS> button on the control panel.

- Pressing the button changes the adjustment screen in the order of [FOCUS], [ZOOM], and [SHIFT].

2) Select each item and press ▲▼◀▶ to adjust it.

Using the remote control

1) Press the lens buttons (<FOCUS>, <ZOOM>, <SHIFT>) on the remote control.

- Pressing the <FOCUS> button: Adjusts the focus (adjustment of the lens focus position).
- Pressing the <ZOOM> button: Adjusts the zoom (adjustment of the lens zoom position).
- Pressing the <SHIFT> button: Adjusts the lens shift (vertical position and horizontal position of the lens).

2) Select each item and press ▲▼◀▶ to adjust it.

CAUTION

During the lens shift operation, do not insert your hand in any opening around the lens.
Your hand may be caught in between, resulting to injury.

Note

- When the projection lens without the zoom function is attached, the zoom adjustment screen is not displayed.
- When the Fixed-focus Lens (Model No.: ET-D75LE50) is used, do not adjust the lens shift, and use the projection lens in the home position. (➔ page 75)
- The adjustment can be performed faster by holding down ▲▼◀▶ for approximately six seconds or longer while adjusting the focus, or for approximately three seconds or longer while adjusting the lens shift.
- It is recommended to perform the focus adjustment after 30 minutes have elapsed with the focus test pattern displayed. For details of the test pattern, refer to “[TEST PATTERN] menu” (➔ page 174). To use the active focus optimizer function, set the [PROJECTOR SETUP] menu → [LENS] → [ACTIVE FOCUS OPTIMIZER] → [ACTIVE FOCUS] to [ON], and then adjust the focus. (➔ page 145)
- Only [FOCUS] is shown in yellow so that the displayed menu item can be recognized by color, even when the projector is not focused and displayed characters are unreadable. (Factory default)
The displayed color of [FOCUS] differs depending on the setting of the [DISPLAY OPTION] menu → [ON-SCREEN DISPLAY] → [OSD DESIGN].
- If the power is turned off during the focus adjustment, the zoom adjustment, or the lens shift adjustment, turn on the power again and execute the [PROJECTOR SETUP] menu → [LENS] → [LENS CALIBRATION].
- When the main power is switched off during focus adjustment, lens calibration is performed automatically during the next focus adjustment.
- If the main power is turned off during the lens shift adjustment, a lens calibration error screen is displayed during the next lens shift adjustment. Execute the [PROJECTOR SETUP] menu → [LENS] → [LENS CALIBRATION].
- Request a repair to your dealer if the lens calibration error screen is displayed even though the lens calibration is executed.

Adjusting the focus when the Fixed-focus Lens (Model No.: ET-D75LE95, ET-D75LE90) is used

After attaching the projection lens, adjust the focus with the projector correctly installed against the screen. The focus balance between the center and periphery of the projected image will differ depending on the size of the projected image when the Fixed-focus Lens (Model No.: ET-D75LE95, ET-D75LE90) is used. Adjust the focus balance of the periphery with the Fixed-focus Lens (Model No.: ET-D75LE95, ET-D75LE90) as necessary.

- 1) Move the projection lens to the home position.**
 - For details of operation method, refer to “Moving the projection lens to the home position” (➔ page 75).
- 2) Adjust the focus at the center of projected image.**
 - For the steps to adjust the focus, refer to “Adjusting the focus, zoom, and lens shift” (➔ page 71).
- 3) Loosen the lock screw and turn the periphery focus adjustment ring by hand to adjust the focus in the periphery of the screen.**

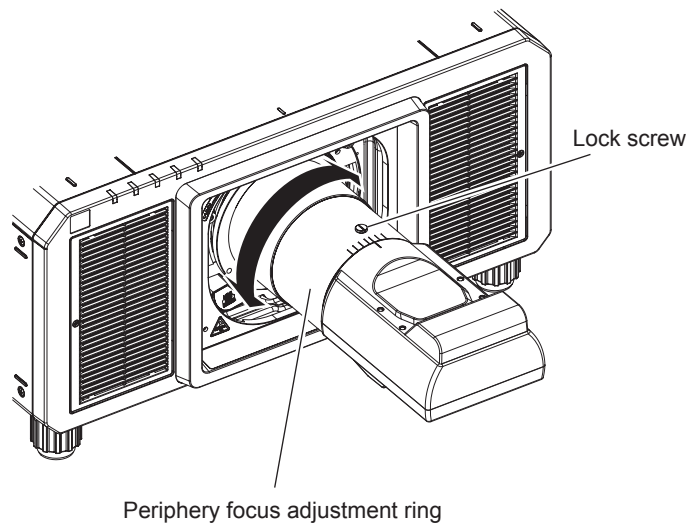

- 4) Check the focus at the center of the image again and make fine adjustments.**
- 5) Tighten the lock screw.**
 - Periphery focus adjustment ring is fixed.

Note

- When the projector is used for the first time or when the projection lens is replaced, confirm that the setting in the [PROJECTOR SETUP] menu → [LENS] → [LENS TYPE] is appropriate, and then execute the [PROJECTOR SETUP] menu → [LENS] → [LENS CALIBRATION].
- The projected image size and scale shown on the periphery focus adjustment ring are an approximate guide.

Setting the lens type

When the projector is used for the first time or when the projection lens is replaced, confirm the [LENS TYPE] setting. Change the setting if the type is different from the projection lens attached to the projector.

- 1) **Press the <MENU> button.**
 - The [MAIN MENU] screen is displayed.
- 2) **Press ▲▼ to select [PROJECTOR SETUP].**
- 3) **Press the <ENTER> button.**
 - The [PROJECTOR SETUP] screen is displayed.
- 4) **Press ▲▼ to select [LENS].**
- 5) **Press the <ENTER> button.**
 - The [LENS] screen is displayed, allowing to confirm the current setting in [LENS TYPE].
 - To change the setting, proceed to Step 6).
- 6) **Press ▲▼ to select [LENS TYPE].**
- 7) **Press the <ENTER> button.**
 - The [LENS TYPE] screen is displayed.
- 8) **Press ▲▼ to select the lens type.**
 - Select the type of projection lens attached to the projector.
- 9) **Press the <ENTER> button.**

Note

- For details of operation, refer to the [PROJECTOR SETUP] menu → [LENS] → [LENS TYPE] (► page 140).

Executing the lens calibration

Detect the lens adjustment limit value, and perform the calibration in the adjustment range. Execute the lens calibration after attaching the projection lens.

Zoom Lens with DC motor, the Fixed-focus Lens

This section describes the operating procedure when the Zoom Lens (Model No.: ET-D75LE6, ET-D75LE8, ET-D75LE10, ET-D75LE20, ET-D75LE30, ET-D75LE40, etc.) in which the DC motor has not been replaced with the stepping motor unit is attached, or when the Fixed-focus Lens (Model No.: ET-D75LE50, ET-D75LE95, ET-D75LE90, etc.) without the zoom function is attached.

- 1) **Press the <MENU> button.**
 - The [MAIN MENU] screen is displayed.
- 2) **Press ▲▼ to select [PROJECTOR SETUP].**
- 3) **Press the <ENTER> button.**
 - The [PROJECTOR SETUP] screen is displayed.
- 4) **Press ▲▼ to select [LENS].**
- 5) **Press the <ENTER> button.**
 - The [LENS] screen is displayed.
- 6) **Press ▲▼ to select [LENS CALIBRATION].**
- 7) **Press the <ENTER> button.**
 - The confirmation screen is displayed.

8) Press ◀▶ to select [OK], and press the <ENTER> button.

- The lens calibration is started.
- After completing the calibration in the adjustment range, the projection lens will move to the home position.

Note

- [LENS CALIBRATION] cannot be executed when the [PROJECTOR SETUP] menu → [LENS] → [LENS TYPE] is set to [NOT SELECTED].
- For details of operation, refer to the [PROJECTOR SETUP] menu → [LENS] → [LENS CALIBRATION] (▶ page 150).
- The origin position of the lens mounter and the home position of the projection lens are automatically updated when the lens shift calibration is performed. The home position is an origin position of the lens shift (vertical position and horizontal position of the lens) based on the calibration result. It does not match with the optical image center position.
- The home position varies depending on the projection lens type. For details, refer to “Lens shift range” (▶ page 76).

Zoom Lens with the stepping motor

This section describes the operating procedure when the standard DC motor unit installed in the Zoom Lens (Model No.: ET-D75LE6, ET-D75LE8, ET-D75LE10, ET-D75LE20, ET-D75LE30, ET-D75LE40, etc.) is replaced with the stepping motor unit using the Stepping Motor Kit (Model No.: ET-D75MKS10), or when a projection lens with the stepping motor is attached.

- 1) Press the <MENU> button.
 - The [MAIN MENU] screen is displayed.
- 2) Press ▲▼ to select [PROJECTOR SETUP].
- 3) Press the <ENTER> button.
 - The [PROJECTOR SETUP] screen is displayed.
- 4) Press ▲▼ to select [LENS].
- 5) Press the <ENTER> button.
 - The [LENS] screen is displayed.
- 6) Press ▲▼ to select [LENS CALIBRATION].
- 7) Press the <ENTER> button.
 - The [LENS CALIBRATION] screen is displayed.
- 8) Press ▲▼ to select an item.

[SHIFT/FOCUS/ZOOM]	Executes the calibrations for the lens shift, focus, and zoom. After completing the calibration in the adjustment range, the projection lens will move to the home position.
[SHIFT/FOCUS]	Executes the calibrations for the lens shift and focus. After completing the calibration in the adjustment range, the projection lens will move to the home position.
[ZOOM]	Executes the calibration of the zoom adjustment range.

- 9) Press the <ENTER> button.
 - The confirmation screen is displayed.
- 10) Press ◀▶ to select [OK], and press the <ENTER> button.
 - The lens calibration is started.

Note

- [LENS CALIBRATION] cannot be executed when the [PROJECTOR SETUP] menu → [LENS] → [LENS TYPE] is set to [NOT SELECTED].
- For details of operation, refer to the [PROJECTOR SETUP] menu → [LENS] → [LENS CALIBRATION] (▶ page 150).
- The origin position of the lens mounter and the home position of the projection lens are automatically updated when the lens shift calibration is performed. The home position is an origin position of the lens shift (vertical position and horizontal position of the lens) based on the calibration result. It does not match with the optical image center position.
- The home position varies depending on the projection lens type. For details, refer to “Lens shift range” (▶ page 76).

Moving the projection lens to the home position

Operate in following procedure to move the projection lens to the home position.

When operating from the main menu

- 1) **Press the <MENU> button.**
 - The [MAIN MENU] screen is displayed.
- 2) **Press ▲▼ to select [PROJECTOR SETUP].**
- 3) **Press the <ENTER> button.**
 - The [PROJECTOR SETUP] screen is displayed.
- 4) **Press ▲▼ to select [LENS].**
- 5) **Press the <ENTER> button.**
 - The [LENS] screen is displayed.
- 6) **Press ▲▼ to select [LENS HOME POSITION].**
- 7) **Press the <ENTER> button.**
 - The confirmation screen is displayed.
- 8) **Press ◀▶ to select [OK], and press the <ENTER> button.**
 - [PROGRESS] is displayed in the [HOME POSITION] screen, and the projection lens is moved to the origin position.

Note

- [LENS HOME POSITION] cannot be executed when the [PROJECTOR SETUP] menu → [LENS] → [LENS TYPE] is set to [NOT SELECTED].
- [LENS HOME POSITION] will not operate correctly when the [PROJECTOR SETUP] menu → [LENS] → [LENS TYPE] is set incorrectly. Change the setting if the type is different from the projection lens attached to the projector.
- The projection lens is not moved to the correct home position when the [PROJECTOR SETUP] menu → [LENS] → [LENS CALIBRATION] is not executed.
- The home position does not match with the optical image center position.
- The home position varies depending on the projection lens type. For details, refer to “Lens shift range” (► page 76).
- The home position of the Fixed-focus Lens (Model No.: ET-D75LE95, ET-D75LE90) may deviate from the designed position.

When operating from the lens shift adjustment screen

- 1) **Press the <DEFAULT> button on the remote control while displaying the lens shift adjustment screen.**
 - The confirmation screen is displayed.
- 2) **Press ◀▶ to select [OK], and press the <ENTER> button.**
 - [PROGRESS] is displayed in the [HOME POSITION] screen, and the projection lens is moved to the origin position.

Note

- The [HOME POSITION] screen is not displayed when the [PROJECTOR SETUP] menu → [LENS] → [LENS TYPE] is set to [NOT SELECTED].
- The projection lens is not moved to the correct home position when the [PROJECTOR SETUP] menu → [LENS] → [LENS TYPE] is set incorrectly. Change the setting if the type is different from the projection lens attached to the projector.
- The projection lens is not moved to the correct home position when the [PROJECTOR SETUP] menu → [LENS] → [LENS CALIBRATION] is not executed.
- The home position varies depending on the projection lens type. For details, refer to “Lens shift range” (► page 76).
- The home position of the Fixed-focus Lens (Model No.: ET-D75LE95, ET-D75LE90) may deviate from the designed position.
- The [HOME POSITION] screen can also be displayed by pressing the <LENS> button on the control panel or the <SHIFT> button on the remote control for three seconds or longer.

Lens shift range

The projector can adjust the position of the projected image within the lens shift range for each projection lens based on the position of the projected image in the home position (standard projection position). Perform the lens shift adjustment within the range indicated in the following illustration. Note that moving the lens outside the adjustment range may change the focus. This is because the shift of the lens is restricted to protect the optical parts.

Following illustration indicates the lens shift range when the projector is installed on desk/floor.

■ PT-RZ21K

Projection lens Model No.	ET-D75LE8, ET-D75LE10, ET-D75LE20, ET-D75LE30, ET-D75LE40	ET-D75LE6
<p>Lens shift range</p>	<p>Projected image width H</p> <p>0.2 H</p> <p>0.2 H</p> <p>0.12 V</p> <p>0.12 V</p> <p>0.55 V</p> <p>0.55 V</p> <p>Projected image height V</p> <p>Origin position of the lens mounter</p> <p>Standard projection position</p>	<p>Projected image width H</p> <p>0.15 H</p> <p>0.15 H</p> <p>0.12 V</p> <p>0.12 V</p> <p>0.44 V</p> <p>0.44 V</p> <p>Projected image height V</p> <p>Origin position of the lens mounter</p> <p>Standard projection position</p>
	<p>Lens shift range</p>	<p>Projected image width H</p> <p>0.12 H</p> <p>0.12 H</p> <p>0.73 V</p> <p>0.05 V</p> <p>0.05 V</p> <p>0.07 V</p> <p>0.07 V</p> <p>Projected image height V</p> <p>Origin position of the lens mounter</p> <p>Standard projection position</p>

■ PT-RS20K

Projection lens Model No.	ET-D75LE8, ET-D75LE10, ET-D75LE20, ET-D75LE30, ET-D75LE40	ET-D75LE6
Lens shift range	<p>Projected image width H</p> <p>0.3 H</p> <p>0.3 H</p> <p>0.1 V</p> <p>0.1 V</p> <p>0.5 V</p> <p>0.5 V</p> <p>Projected image height V</p> <p>Origin position of the lens mounter</p> <p>Standard projection position</p>	<p>Projected image width H</p> <p>0.2 H</p> <p>0.2 H</p> <p>0.12 V</p> <p>0.12 V</p> <p>0.4 V</p> <p>0.4 V</p> <p>Projected image height V</p> <p>Origin position of the lens mounter</p> <p>Standard projection position</p>

Projection lens Model No.	ET-D75LE95
Lens shift range	<p>Projected image width H</p> <p>0.08 H</p> <p>0.08 H</p> <p>0.71 V</p> <p>0.04 V</p> <p>0.07 V</p> <p>0.07 V</p> <p>Projected image height V</p> <p>Origin position of the lens mounter</p> <p>Standard projection position</p>

Note

- Use the projection lens in the standard projection position without adjusting the lens shift when the optional Fixed-focus Lens (Model No.: ET-D75LE50) is attached.
- Use the projection lens in the standard projection position without adjusting the lens shift when the optional Fixed-focus Lens (Model No.: ET-D75LE90) is attached to PT-RS20K.

Adjusting the lens mounter when the focus is unbalanced

Focus balance

Relationship between the tilt of the lens and the screen focus surface

When the projection lens is tilted in contrast with the image forming surface, tilting the front side (screen side) of the projection lens downwards (in the direction of the dotted arrow line), the upper side of the screen focus surface will tilt inwards and the lower side will tilt outwards as shown in the example.

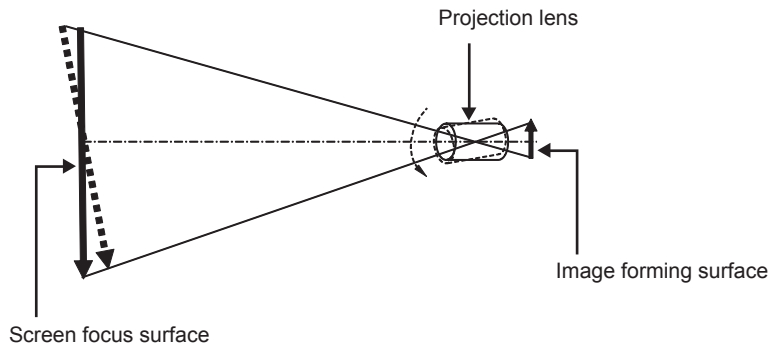

How to adjust the focus balance (adjustment by tilting the lens mounter)

When the entire screen surface is not uniform even if the focus has been adjusted, the lens mounter has focus adjustment screws in three locations.

- Tool used: Hex driver or Allen wrench (diagonal 4.0 mm (5/32"))
- The Allen wrench supplied with the projection lens ET-D75LE6 or ET-D75LE8 cannot be used.

Lens mounter structure

Focus adjustment screws (a), (b), and (c) can be turned to move the lens mount bracket back and forth. Also, tightening the fixed screws locks the lens mount bracket in place so it does not move.

When a projection lens with a large weight is installed, or when the projector is installed on an inclination, the lens may tilt and the focus may become unbalanced. In these cases, perform adjustment by referring to the relationship between the adjustment location and adjustment screws.

■ Front view diagram of the lens mounter (viewed from the screen side)

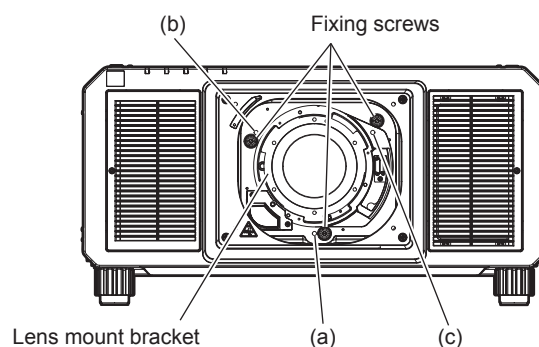

Note

- Focus adjustment screws (a), (b), and (c) are adjusted with the lens attached.

Adjustment procedure

■ Relationship between the adjustment location and adjustment screws

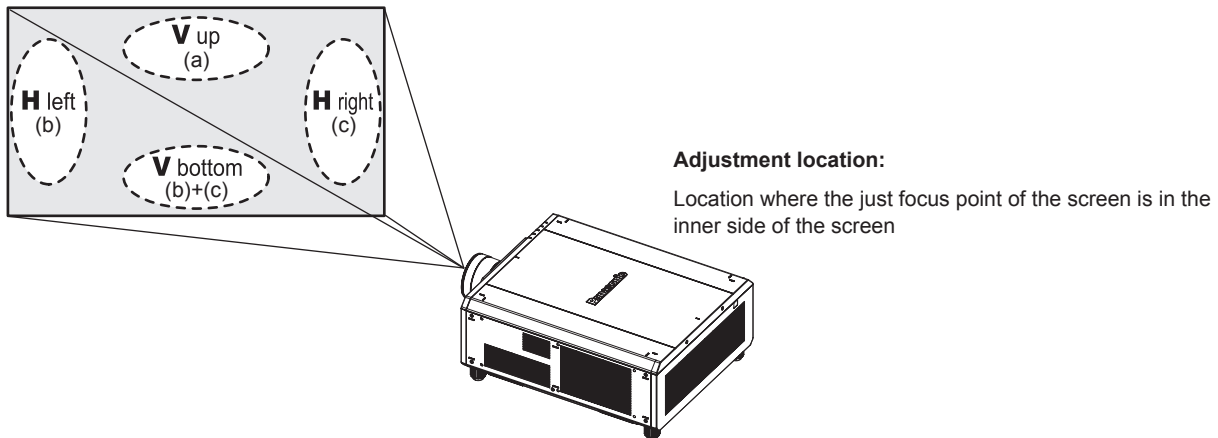

	When the just focus point of the screen in V up (top in the vertical direction) is in the inner side of the screen	When the just focus point of the screen in V bottom (bottom in the vertical direction) is in the inner side of the screen	When the just focus point of the screen in H left (left in the horizontal direction) is in the inner side of the screen	When the just focus point of the screen in H right (right in the horizontal direction) is in the inner side of the screen
(a)	Rotate counterclockwise	—	—	—
(b)	—	Rotate counterclockwise	Rotate counterclockwise	—
(c)	—	Rotate counterclockwise	—	Rotate counterclockwise

- 1) Press the <FOCUS> button on the remote control or the <LENS> button on the control panel to display the focus adjustment screen.
- 2) Press ▼ to shift the focus of the entire screen once.
- 3) Press ▲ to stop on any part of the screen to be the first just focus point.
 - For the location where focus is shifted in this state, the just focus point is on the inner side of the screen.
- 4) Loosen the fixed screws in the position relative to the location where the focus is shifted the most (the location where the just focus point is shifted the most towards the inner side in Step 2)) up to two rotations.
 - Turn screws clockwise in two locations, or at least in one location when making an adjustment.
- 5) Slowly turn the focus adjustment screws corresponding to the locations counterclockwise and stop where the image is in focus. (➡ page 78)
 - If the screws are turned counterclockwise, the tilt of the lens will change by moving the lens mount bracket of the lens mounter forward (screen side), and in the projected image on the screen, the focus point in the opposite direction of the adjustment screws will move from the inner side of the screen to the outside.
- 6) Press the <SHIFT> button on the remote control or the <LENS> button on the control panel to display the lens shift adjustment menu, and reset the screen position of the projected image on the screen surface back to an optimal state.
- 7) Perform focus adjustment again near the center of the screen and if it is still not enough, fine tune the amount of rotation of the adjustment screws.
- 8) When adjustments have been made, securely tighten the loosened fixing screws.
- 9) Adjust the focus again using the remote control.

Operating with the remote control



Using the shutter function

If the projector is not used for a certain period of time during the meeting intermission, for example, it is possible to turn off the image temporarily.

button

- 1) **Press the <SHUTTER> button.**
 - The image disappears.
 - This operation can be also performed using the <SHUTTER> button on the control panel.
- 2) **Press the <SHUTTER> button again.**
 - The image is displayed.

Note

- The power indicator <ON (G)/STANDBY (R)> will blink slowly in green while the shutter function is in use (shutter: closed).
- You can set whether to use the mechanical shutter or not and the time for the fade in/fade out of the image using the [DISPLAY OPTION] menu → [SHUTTER SETTING].
- If [MECHANICAL SHUTTER] in the [DISPLAY OPTION] menu → [SHUTTER SETTING] (➔ page 134) is set to [DISABLE], the light source may be lit dimly due to warm-up when the shutter function is used while the operating environment temperature is around 0 °C (32 °F).

Using the on-screen display function

Turn off the on-screen display function (no display) when you do not wish the viewers to see the on-screen display, such as the menu or the input terminal name.

button

- 1) **Press the <ON SCREEN> button.**
 - Turns off (hides) the on-screen display.
- 2) **Press the <ON SCREEN> button again.**
 - Cancels the hide condition of the on-screen display.

Note

- The hide condition of the on-screen display can also be canceled by pressing the <MENU> button on the control panel for at least three seconds while the on-screen display is off (hidden).

Using the automatic setup function

The image position when the DVI-D/HDMI signal is input, or the resolution, clock phase, and image position when the analog RGB signal is input can be adjusted automatically. (Analog RGB signal is a signal structured with dots just like the computer signal.) It is recommended to input an image with bright white borders at the edges and high-contrast black and white characters when the automatic adjustment is being performed.

Avoid using images that include halftones or gradation, such as photographs and computer graphics.

button

1) Press the <AUTO SETUP> button.

- [COMPLETE] is displayed when it has completed without any problem.
- This operation can be also performed using the <AUTO SETUP> button on the control panel.

Note

- The clock phase may shift even if it has completed without any incident. In such a case, adjust the [POSITION] menu → [CLOCK PHASE] (➔ page 101).
- If an image with blurred edges or a dark image is input, [INCOMPLETE] may appear or adjustment may not be performed properly even when [COMPLETE] appears. In such a case, adjust the following settings.
 - The [ADVANCED MENU] menu → [INPUT RESOLUTION] (➔ page 106)
 - The [POSITION] menu → [CLOCK PHASE] (➔ page 101)
 - The [POSITION] menu → [SHIFT] (➔ page 99)
- Adjust special signals according to the [DISPLAY OPTION] menu → [AUTO SETUP] (➔ page 119).
- Automatic adjustment may not work depending on the model of the computer.
- Automatic adjustment may not work for a synchronization signal of C-SY or SYNC ON GREEN.
- Images may be disrupted for a few seconds during automatic adjustment, but it is not a malfunction.
- Adjustment is required for each input signal.
- Automatic adjustment can be canceled by pressing the <MENU> button during the automatic adjustment operation.
- Even if a signal possible to perform the automatic setup is being input, it may not be able to adjust correctly if the automatic setup function is used while the moving image is being input. [INCOMPLETE] may be displayed, or the adjustment may not be completed correctly even if [COMPLETE] is displayed.

Switching the image aspect ratio

Switch the image aspect ratio according to the input.

button

1) Press the <ASPECT> button.

- The setting will change each time you press the button.

Note

- The aspect ratio of the image can also be switched using the menu operation. Refer to the [POSITION] menu → [ASPECT] (➔ page 99) for details.

Using the function button

By assigning the following functions to the <FUNCTION> button, it can be used as a simplified shortcut button. [P IN P], [SUB MEMORY], [SYSTEM SELECTOR], [SYSTEM DAYLIGHT VIEW], [FREEZE], [WAVEFORM MONITOR], [LENS MEMORY LOAD], [LEFT/RIGHT SWAP], [PROJECTION METHOD]

button

1) Press the <FUNCTION> button.

Note

- Assignment of the function is performed from the [PROJECTOR SETUP] menu → [FUNCTION BUTTON] (➔ page 167).

Using the AC voltage monitor function

The value of input supply voltage can be displayed on the self-diagnosis display at the side of the projector.

■ To display during projection

1) Press the power on <|> button.

- The value of the input supply voltage is displayed only as numeric value on the self-diagnosis display.
- The display will turn off automatically after approximately 3 seconds.

■ To display during standby mode

1) Press the power standby <⏻> button.

- The value of the input supply voltage is displayed only as numeric value on the self-diagnosis display.
- The display will turn off automatically after approximately 3 seconds.

Note

- The value of the input supply voltage can be always displayed in the self-diagnosis display by setting the [PROJECTOR SETUP] menu → [AC VOLTAGE MONITOR] (➔ page 169) to [ON].
- The value of input supply voltage cannot be displayed in the self-diagnosis display during standby when the [PROJECTOR SETUP] menu → [STANDBY MODE] (➔ page 159) is set to [ECO].
- Operation can also be performed by the power on <|> button or power standby <⏻> button on the control panel.

Setting ID number of the remote control

When you use the multiple projectors together, you can operate all the projectors simultaneously or each projector individually using a single remote control, if a unique ID number is assigned to each projector.

After setting the ID number of the projector, set same ID number on the remote control.

The factory default ID number of the projector is set to [ALL]. When using a single projector, press the <ID ALL> button on the remote control. Also, you can control a projector by pressing the <ID ALL> button on the remote control even if you do not know the projector ID.



1) Press the <ID SET> button on the remote control.

2) Within five seconds, press and set the one-digit or two-digit ID number set on the projector body using the number (<0> - <9>) buttons.

- If you press the <ID ALL> button, you can control the projectors regardless of the ID number setting of the projector body.

Attention

- Since the ID number of the remote control can be set without the projector body, do not press the <ID SET> button on the remote control carelessly. If the <ID SET> button is pressed and no number (<0> - <9>) buttons are pressed within five seconds, the ID number returns to its original value before the <ID SET> button was pressed.
- The ID number set on the remote control will be stored unless it is set again. However, it will be erased if the remote control is left with dead batteries. Set the same ID number again when the batteries are replaced.

Note

- When the ID number of the remote control is set to [0], you can control the projector regardless of the ID number setting of the projector body, as same as when [ALL] is set.
- Set the ID number of the projector body from the [PROJECTOR SETUP] menu → [PROJECTOR ID].

Chapter 4 Settings

This chapter describes the settings and adjustments you can make using the on-screen menu.

Menu navigation

The on-screen menu (Menu) is used to perform various settings and adjustments of the projector.

Navigating through the menu

Operating procedure



1) Press the <MENU> button on the remote control or control panel.

- The [MAIN MENU] screen is displayed.

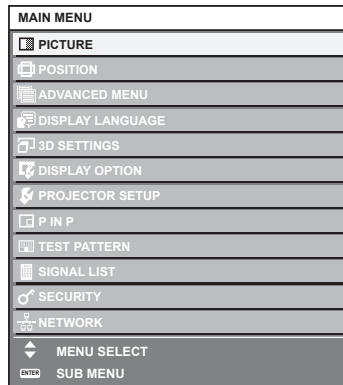

2) Press ▲▼ to select an item from the main menu.

- The selected item is highlighted in yellow.

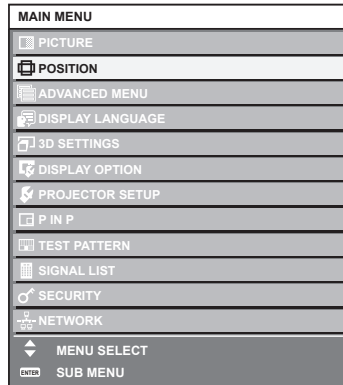

3) Press the <ENTER> button.

- The sub-menu items of the selected main menu are displayed.

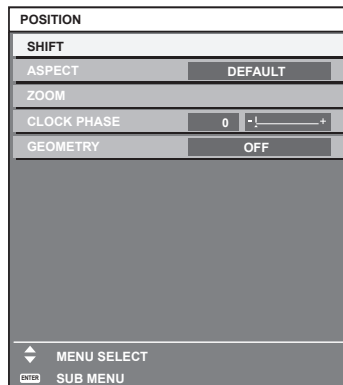

4) Press ▲▼ to select a sub-menu, and press ◀▶ or the <ENTER> button to change or adjust settings.

- Some items will switch in order as follows each time you press ◀▶.

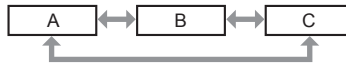

- For some items, press ◀▶ to display an individual adjustment screen with a bar scale as shown below.



Note

- Pressing the <MENU> button while the menu screen is displayed returns to the previous menu.
- Some items or functions may not be adjusted or used depending on the signals input to the projector. When the items cannot be adjusted or used, the items in the menu screen are shown in black characters, and they cannot be adjusted or set. [FRAME LOCK] may not be displayed depending on the input signal.
If the item in the menu screen is displayed in black characters and the item cannot be adjusted or set, the factor causing it is displayed by pressing the <ENTER> button while the corresponding menu is selected.
- Some items can be adjusted even if signals are not input.
- Individual adjustment screen is cleared automatically if no operation is performed for approximately five seconds.
- For menu items, refer to “Main menu” (➔ page 86) and “Sub-menu” (➔ page 87).
- The cursor color depends on the setting in the [DISPLAY OPTION] menu → [ON-SCREEN DISPLAY] → [OSD DESIGN]. The selected item is displayed with the yellow cursor by the factory default.
- In the portrait setting, the on-screen menu is displayed sideways.
To display the on-screen menu vertically, change the setting of the [DISPLAY OPTION] menu → [ON-SCREEN DISPLAY] → [OSD ROTATION].

Resetting adjustment values to the factory default

If the <DEFAULT> button on the remote control is pressed, the values adjusted in the menu items are restored to the factory default settings.



1) Press the <DEFAULT> button on the remote control.



Note

- You cannot reset all the settings to the factory default at a time.
- To reset all the settings adjusted in the sub-menu item to the factory default one at a time, execute the [PROJECTOR SETUP] menu → [INITIALIZE].
- Some items cannot be reset to the factory default settings even when the <DEFAULT> button on the remote control is pressed. Adjust those items individually.
- The triangular mark under the bar scale in the individual adjustment screen indicates the factory default setting. The position of the triangular mark varies according to the selected input signals.

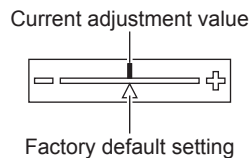











Main menu

The following items are in the main menu.

When a main menu item is selected, the screen changes to a sub-menu selection screen.

The menu item with ✓ in the [SIMPLE] mode column indicates that this is displayed in the menu screen (OSD) when the [DISPLAY OPTION] menu → [MENU MODE] is set to [SIMPLE].

Main menu item		[SIMPLE] mode	Page
	[PICTURE]	✓	91
	[POSITION]	✓	99

Main menu item		[SIMPLE] mode	Page
	[ADVANCED MENU]	—	105
	[DISPLAY LANGUAGE]	✓	111
	[3D SETTINGS]	—	112
	[DISPLAY OPTION]	✓	117
	[PROJECTOR SETUP]	✓	139
	[P IN P]	—	172
	[TEST PATTERN]	✓	174
	[SIGNAL LIST]	✓	175
	[SECURITY]	—	178
	[NETWORK]	✓	182

Sub-menu

The sub-menu of the selected main menu item is displayed, and you can set and adjust items in the sub-menu. The menu item with ✓ in the [SIMPLE] mode column indicates that this is displayed in the menu screen (OSD) when the [DISPLAY OPTION] menu → [MENU MODE] is set to [SIMPLE].

[PICTURE]

Sub-menu item	Factory default	[SIMPLE] mode	Page
[PICTURE MODE]	[GRAPHIC] ^{*1}	✓	91
[CONTRAST]	[0] ^{*2}	✓	91
[BRIGHTNESS]	[0] ^{*2}	✓	92
[COLOR]	[0] ^{*2}	✓	92
[TINT]	[0] ^{*2}	—	92
[COLOR TEMPERATURE]	[DEFAULT] ^{*2}	—	92
[GAMMA]	[DEFAULT] ^{*2}	—	94
[SYSTEM DAYLIGHT VIEW]	[OFF] ^{*2}	—	95
[SHARPNESS]	[+8] ^{*2}	—	95
[NOISE REDUCTION]	[2] ^{*2}	—	96
[DYNAMIC CONTRAST]	[2] ^{*2}	—	96
[COLOR SPACE]	[NATIVE]	—	97
[SYSTEM SELECTOR]	[Y_P_B_P_R] ^{*1}	—	98

*1 Depends on the signal input.

*2 Depends on the [PICTURE MODE].

[POSITION]

Sub-menu item	Factory default	[SIMPLE] mode	Page
[SHIFT]	—	—	99
[ASPECT]	[DEFAULT] ^{*1}	✓	99
[ZOOM]	—	—	100
[CLOCK PHASE]	[0] ^{*1}	—	101
[GEOMETRY]	[OFF]	✓	102

*1 Depends on the signal input.

[ADVANCED MENU]

Sub-menu item	Factory default	[SIMPLE] mode	Page
[DIGITAL CINEMA REALITY]	[AUTO] ^{*1}	—	105
[BLANKING]	—	—	105
[INPUT RESOLUTION]	—	—	106
[CLAMP POSITION]	[24] ^{*1}	—	106
[EDGE BLENDING]	[OFF]	—	107
[FRAME RESPONSE]	[NORMAL]	—	108
[FRAME DELAY]	[+0.00ms]	—	109
[FRAME CREATION]	—	—	109
[FRAME LOCK]	—	—	110
[RASTER POSITION]	—	—	110

*1 Depends on the signal input.

[DISPLAY LANGUAGE]

Details (➔ page 111)

[3D SETTINGS]

Sub-menu item	Factory default	[SIMPLE] mode	Page
[3D SYSTEM SETTING]	[SINGLE]	—	112
[3D SYNC SETTING]	—	—	112
[3D INPUT FORMAT]	[AUTO] ^{*1}	—	113
[LEFT/RIGHT SWAP]	[NORMAL]	—	113
[3D COLOR MATCHING]	[SHARED 2D/3D]	—	114
[3D PICTURE BALANCE]	—	—	114
[DARK TIME SETTING]	[1.5ms]	—	114
[3D TEST MODE]	[NORMAL]	—	115
[3D TEST PATTERN]	—	—	115
[SAFETY PRECAUTIONS MESSAGE]	[ON]	—	116
[3D SAFETY PRECAUTIONS]	—	—	116

*1 Varies depending on the selected input terminal.

[DISPLAY OPTION]

Sub-menu item	Factory default	[SIMPLE] mode	Page
[COLOR MATCHING]	[OFF]	✓	117
[LARGE SCREEN CORRECTION]	[OFF]	—	118
[SCREEN SETTING]	—	✓	118
[AUTO SIGNAL]	[OFF]	—	119
[AUTO SETUP]	—	—	119
[BACKUP INPUT SETTING]	—	—	120
[SIMUL INPUT SETTING]	—	—	121
[RGB IN]	—	—	122
[DVI-D IN]	—	—	123
[HDMI IN]	—	—	125
[DIGITAL LINK IN]	—	—	126
[SDI IN]	—	—	127
[ON-SCREEN DISPLAY]	—	✓	130
[MENU MODE]	[NORMAL]	✓	132
[IMAGE ROTATION]	[OFF]	—	132
[BACK COLOR]	[BLUE]	—	132
[STARTUP LOGO]	[DEFAULT LOGO]	✓	132

Sub-menu item	Factory default	[SIMPLE] mode	Page
[UNIFORMITY]	—	—	133
[SHUTTER SETTING]	—	—	134
[FREEZE]	—	—	136
[WAVEFORM MONITOR]	[OFF]	—	136
[CUT OFF]	—	—	138

[PROJECTOR SETUP]

Sub-menu item	Factory default	[SIMPLE] mode	Page
[PROJECTOR ID]	[ALL]	✓	139
[PROJECTION METHOD]	—	✓	139
[LENS]	—	✓	140
[OPERATION SETTING]	—	✓	152
[LIGHT OUTPUT]	[100.0%]	✓	154
[BRIGHTNESS CONTROL]	—	—	155
[STANDBY MODE]	[NORMAL]	—	159
[NO SIGNAL SHUT-OFF]	[DISABLE]	—	159
[NO SIGNAL LIGHTS-OUT]	[DISABLE]	—	159
[INITIAL STARTUP]	[LAST MEMORY]	—	160
[STARTUP INPUT SELECT]	[LAST USED]	—	160
[DATE AND TIME]	—	✓	160
[SCHEDULE]	[OFF]	—	161
[MULTI PROJECTOR SYNC]	—	—	163
[RS-232C]	—	✓	165
[REMOTE2 MODE]	[DEFAULT]	—	166
[FUNCTION BUTTON]	—	—	167
[STATUS]	—	✓	167
[AC VOLTAGE MONITOR]	[OFF]	—	169
[SAVE ALL USER DATA]	—	—	169
[LOAD ALL USER DATA]	—	—	170
[INITIALIZE]	—	✓	170
[SERVICE PASSWORD]	—	✓	171

[P IN P]

Details (➔ page 172)

[TEST PATTERN]

Details (➔ page 174)

[SIGNAL LIST]

Details (➔ page 175)

[SECURITY]

Sub-menu item	Factory default	[SIMPLE] mode	Page
[SECURITY PASSWORD]	[OFF]	—	178
[SECURITY PASSWORD CHANGE]	—	—	178
[DISPLAY SETTING]	[OFF]	—	178
[TEXT CHANGE]	—	—	179
[CONTROL DEVICE SETUP]	—	—	179
[CONTROL DEVICE PASSWORD CHANGE]	—	—	180

[NETWORK] 

Sub-menu item	Factory default	[SIMPLE] mode	Page
[DIGITAL LINK MODE]	[AUTO]	—	182
[DIGITAL LINK STATUS]	—	✓	182
[NETWORK SETUP]	—	✓	183
[NETWORK CONTROL]	—	✓	183
[NETWORK STATUS]	—	✓	184
[DIGITAL LINK MENU]	—	—	184
[Art-Net SETUP]	[OFF]	—	184
[Art-Net CHANNEL SETTING]	[2]	—	185
[Art-Net STATUS]	—	—	186

Note

- Some items may not be adjusted or used for certain signal formats to be input to the projector.
When the items cannot be adjusted or used, the items in the menu screen are shown in black characters, and they cannot be adjusted or set.
- Sub-menu items and factory default settings vary depending on the selected input terminal.

[PICTURE] menu

On the menu screen, select [PICTURE] from the main menu, and select an item from the sub-menu. Refer to “Navigating through the menu” (➔ page 85) for the operation of the menu screen.

[PICTURE MODE]

You can switch to the desired picture mode suitable for the image source and the environment in which the projector is used.

- 1) Press ▲▼ to select [PICTURE MODE].
- 2) Press ◀▶.
 - The [PICTURE MODE] individual adjustment screen is displayed.
- 3) Press ◀▶ to switch the item.
 - The items will switch each time you press the button.

[STANDARD]	The image becomes suitable for moving images in general.
[CINEMA]	The image becomes suitable for movie contents.
[NATURAL]	The image is sRGB compliant.
[DICOM SIM.]	The image becomes similar to that of DICOM Part 14 Grayscale Standard.
[DYNAMIC]	The light output is maximized for use in bright areas.
[GRAPHIC]	The image becomes suitable for input from the personal computer.
[USER]	Set any desired picture mode.

Note

- The factory default picture mode is [GRAPHIC] for still image input signals and [STANDARD] for movie-based input signals.
- DICOM is an abbreviation of “Digital Imaging and COmmunication in Medicine” and is a standard for medical imaging devices. Although the DICOM name is used, the projector is not a medical device, and should not be used for purposes such as diagnosis of display images.
- Press the <ENTER> button when each [PICTURE MODE] is selected to save as a specified value when a new signal is input. The data of all items except [SYSTEM SELECTOR] in the [PICTURE] menu is saved.
- In the factory default settings, [USER] is set to images that comply with the ITU-R BT.709 standard.

Changing the [USER] name

- 1) Press ▲▼ to select [PICTURE MODE].
- 2) Press ◀▶ to select [USER].
- 3) Press the <ENTER> button.
 - The [PICTURE MODE] detailed screen is displayed.
- 4) Press ▲▼ to select [PICTURE MODE NAME CHANGE], and press the <ENTER> button.
 - The [PICTURE MODE NAME CHANGE] screen is displayed.
- 5) Press ▲▼◀▶ to select the text, and press the <ENTER> button to enter the text.
- 6) Press ▲▼◀▶ to select [OK], and press the <ENTER> button.
 - The picture mode name is changed.

[CONTRAST]

You can adjust the contrast of the colors.

- 1) Press ▲▼ to select [CONTRAST].
- 2) Press ◀▶ or the <ENTER> button.
 - The [CONTRAST] individual adjustment screen is displayed.
- 3) Press ◀▶ to adjust the level.

Operation	Adjustment	Range of adjustment
Press ▶.	The screen becomes brighter.	-31 - +31
Press ◀.	The screen becomes darker.	

Attention

- Adjust [BRIGHTNESS] first when you need to adjust the black level.

[BRIGHTNESS]

You can adjust the dark (black) part of the projected image.

- 1) Press ▲▼ to select [BRIGHTNESS].
- 2) Press ◀▶ or the <ENTER> button.
 - The [BRIGHTNESS] individual adjustment screen is displayed.
- 3) Press ◀▶ to adjust the level.

Operation	Adjustment	Range of adjustment
Press ▶.	Increases the brightness of the dark (black) parts of the screen.	-31 - +31
Press ◀.	Reduces the brightness of the dark (black) parts of the screen.	

[COLOR]

You can adjust the color saturation of the projected image.

- 1) Press ▲▼ to select [COLOR].
- 2) Press ◀▶ or the <ENTER> button.
 - The [COLOR] individual adjustment screen is displayed.
- 3) Press ◀▶ to adjust the level.

Operation	Adjustment	Range of adjustment
Press ▶.	Deepens colors.	-31 - +31
Press ◀.	Weakens colors.	

[TINT]

You can adjust the skin tone in the projected image.

- 1) Press ▲▼ to select [TINT].
- 2) Press ◀▶ or the <ENTER> button.
 - The [TINT] individual adjustment screen is displayed.
- 3) Press ◀▶ to adjust the level.

Operation	Adjustment	Range of adjustment
Press ▶.	Adjusts skin tone toward greenish color.	-31 - +31
Press ◀.	Adjusts skin tone toward reddish purple.	

[COLOR TEMPERATURE]

You can switch the color temperature if the white areas of the projected image are bluish or reddish.

Adjusting with color temperature

- 1) Press ▲▼ to select [COLOR TEMPERATURE].
- 2) Press ◀▶ or the <ENTER> button.
 - The [COLOR TEMPERATURE] individual adjustment screen is displayed.
- 3) Press ◀▶ to switch the item.
 - The items will switch each time you press the button.

[DEFAULT]	Factory default setting.
-----------	--------------------------

[USER1]	Adjusts white balance as desired. Refer to “Adjusting desired white balance” (➔ page 93) for details.
[USER2]	
[3200K] - [9300K]	Allows you to set in increments of 100 K. Select so that images become natural.

Note

- When [PICTURE MODE] (➔ page 91) is set to [USER] or [DICOM SIM.], [DEFAULT] cannot be selected.
- When [COLOR MATCHING] (➔ page 117) adjustment is set to other than [OFF], [COLOR TEMPERATURE] is fixed to [USER1].
- The color temperature numerical values are guidelines.

Adjusting desired white balance

- 1) Press ▲▼ to select [COLOR TEMPERATURE].
- 2) Press ◀▶ or the <ENTER> button.
 - The [COLOR TEMPERATURE] individual adjustment screen is displayed.
- 3) Press ◀▶ to select [USER1] or [USER2].
- 4) Press the <ENTER> button.
 - The [COLOR TEMPERATURE] screen is displayed.
- 5) Press ▲▼ to select [WHITE BALANCE].
- 6) Press the <ENTER> button.
 - The [WHITE BALANCE] screen is displayed.
- 7) Press ▲▼ to select [WHITE BALANCE HIGH] or [WHITE BALANCE LOW].
- 8) Press the <ENTER> button.
 - The [WHITE BALANCE HIGH] screen or the [WHITE BALANCE LOW] screen is displayed.
- 9) Press ▲▼ to select [RED], [GREEN], or [BLUE].
- 10) Press ◀▶ to adjust the level.

Item	Operation	Adjustment	Range of adjustment
[RED]	Press ▶.	Deepens red.	[WHITE BALANCE HIGH]: 0 - +255 (factory default is +255) [WHITE BALANCE LOW]: -127 - +127 (factory default is 0)
	Press ◀.	Weakens red.	
[GREEN]	Press ▶.	Deepens green.	
	Press ◀.	Weakens green.	
[BLUE]	Press ▶.	Deepens blue.	
	Press ◀.	Weakens blue.	

Note

- Adjust [COLOR TEMPERATURE] correctly. All colors will not be displayed properly unless adequate adjustment is made. If the adjustment does not look suitable, you can press the <DEFAULT> button on the remote control to return the setting for the selected item only to the factory default setting.

Adjusting desired white balance based on existing color temperature settings

- 1) Press ▲▼ to select [COLOR TEMPERATURE].
- 2) Press ◀▶ or the <ENTER> button.
 - The [COLOR TEMPERATURE] individual adjustment screen is displayed.
- 3) Press ◀▶ to select an item other than [DEFAULT], [USER1], and [USER2].
- 4) Press the <ENTER> button.
 - The [CHANGE TO *****] screen is displayed.
- 5) Press ▲▼ to select [USER1] or [USER2].
 - The status of the color temperature changed is saved to the selected item.

- 6) Press the <ENTER> button.
 - The confirmation screen is displayed.
- 7) Press ◀▶ to select [OK], and press the <ENTER> button.
 - The [USER1] or [USER2] data is overwritten.
 - If you press ◀▶ to select [CANCEL] and then press the <ENTER> button, the data will not be overwritten.
 - The [WHITE BALANCE HIGH] screen is displayed.
- 8) Press ▲▼ to select [RED], [GREEN], or [BLUE].
- 9) Press ◀▶ to adjust the level.

Note

- Adjust [COLOR TEMPERATURE] correctly. All colors will not be displayed properly unless adequate adjustment is made. If the adjustment does not look suitable, you can press the <DEFAULT> button on the remote control to return the setting for the selected item only to the factory default setting.
- When color temperature has been changed, the colors before and after the change will differ slightly.

Changing the name of [USER1] or [USER2]

- 1) Press ▲▼ to select [COLOR TEMPERATURE].
- 2) Press ◀▶ or the <ENTER> button.
 - The [COLOR TEMPERATURE] individual adjustment screen is displayed.
- 3) Press ◀▶ to select [USER1] or [USER2].
- 4) Press the <ENTER> button.
 - The [COLOR TEMPERATURE] screen is displayed.
- 5) Press ▲▼ to select [COLOR TEMPERATURE NAME CHANGE].
- 6) Press the <ENTER> button.
 - The [COLOR TEMPERATURE NAME CHANGE] screen is displayed.
- 7) Press ▲▼◀▶ to select the text, and press the <ENTER> button to enter the text.
- 8) Press ▲▼◀▶ to select [OK], and press the <ENTER> button.
 - The name set to color temperature is changed.

Note

- When a name is changed, display of [USER1], [USER2] is also changed.

[GAMMA]

You can switch gamma mode.

- 1) Press ▲▼ to select [GAMMA].
- 2) Press ◀▶ or the <ENTER> button.
 - The [GAMMA] individual adjustment screen is displayed.
- 3) Press ◀▶ to switch the item.
 - The items will switch each time you press the button.

[DEFAULT] ^{*1}	Gamma mode unique to this projector.
[USER1]	Uses the gamma data registered by the user.
[USER2]	(Registration requires separate software. Consult your dealer.)
[HDR ST2084-500]	Gamma mode compliant with SMPTE ST 2084 that assumes a highest luminance of 500 nt and supports HDR (High Dynamic Range).
[HDR ST2084-1000]	Gamma mode compliant with SMPTE ST 2084 that assumes a highest luminance of 1 000 nt and supports HDR (High Dynamic Range).
[HDR HLG]	Gamma mode compliant with ARIB STD-B67 (HLG: Hybrid Log Gamma system) that supports HDR (High Dynamic Range).
[DICOM SIM.]	The picture becomes similar to that of DICOM standard.

[1.0]	Set so that images become as you like. [2.0] - [2.8] can be set in increments of 0.1.
[1.8]	
[2.0] - [2.8]	

*1 When [PICTURE MODE] is set to [DYNAMIC], [USER], or [DICOM SIM.], [DEFAULT] cannot be selected.

Note

- DICOM is an abbreviation of “Digital Imaging and COmmunication in Medicine” and is a standard for medical imaging devices. Although the DICOM name is used, the projector is not a medical device, and should not be used for purposes such as diagnosis of display images.

Changing the name of [USER1] or [USER2]

- 1) Press ▲▼ to select [GAMMA].
- 2) Press ◀▶ or the <ENTER> button.
 - The [GAMMA] individual adjustment screen is displayed.
- 3) Press ◀▶ to select [USER1] or [USER2].
- 4) Press the <ENTER> button.
 - The [GAMMA] screen is displayed.
- 5) Press the <ENTER> button.
 - The [GAMMA NAME CHANGE] screen is displayed.
- 6) Press ▲▼◀▶ to select the text, and press the <ENTER> button to enter the text.
- 7) Press ▲▼◀▶ to select [OK], and press the <ENTER> button.
 - The selected gamma name is changed.

Note

- When a name is changed, display of [USER1], [USER2] is also changed.

[SYSTEM DAYLIGHT VIEW]

You can correct the image to the optimal vividness even if it is projected under a bright light.

- 1) Press ▲▼ to select [SYSTEM DAYLIGHT VIEW].
- 2) Press ◀▶ or the <ENTER> button.
 - The [SYSTEM DAYLIGHT VIEW] individual adjustment screen is displayed.
- 3) Press ◀▶ to switch the item.
 - The items will switch each time you press the button.

[OFF]	No correction.
[1] - [6]	Corrects the vividness of the image. The larger the value, the stronger the correction.

[SHARPNESS]

You can adjust the sharpness of the projected image.

- 1) Press ▲▼ to select [SHARPNESS].
- 2) Press ◀▶ or the <ENTER> button.
 - The [SHARPNESS] individual adjustment screen is displayed.
- 3) Press ◀▶ to adjust the level.

Operation	Adjustment	Range of adjustment
Press ▶.	Contours become sharper.	0 - +15
Press ◀.	Contours become softer.	

Note

- If you press ► while the adjustment value is [+15], the value will become [0]. If you press ◀ while the adjustment value is [0], the value will become [+15].

[NOISE REDUCTION]

You can reduce noises when the input image is degraded and noise is occurring in the image signal.

- 1) Press ▲▼ to select [NOISE REDUCTION].
- 2) Press ◀▶ or the <ENTER> button.
 - The [NOISE REDUCTION] individual adjustment screen is displayed.
- 3) Press ◀▶ to switch the item.
 - The items will switch each time you press the button.

[OFF]	No correction.
[1] - [6]	Compensates the noise. The larger the value, the stronger the compensation of the noise.

Attention

- When this is set for an input signal with less noise, the image may look different from what it originally was. In such a case, set it to [OFF].

[DYNAMIC CONTRAST]

Light adjustment of the light source and signal compensation are performed automatically according to the image to make the contrast optimum for the image.

- 1) Press ▲▼ to select [DYNAMIC CONTRAST].
- 2) Press ◀▶ or the <ENTER> button.
 - The [DYNAMIC CONTRAST] individual adjustment screen is displayed.
- 3) Press ◀▶ to switch the item.
 - The items will switch each time you press the button.

[OFF]	Disables the dynamic contrast function.
[1]	Adjusts the light source and compensates signals to a small extent.
[2]	Adjusts the light source and compensates signals to a moderate extent.
[3]	Adjusts the light source and compensates signals to a large extent.
[USER]	Set any desired correction. Refer to "Performing desired correction" (➔ page 96) for details.

Performing desired correction

- 1) Press ▲▼ to select [DYNAMIC CONTRAST].
- 2) Press ◀▶ or the <ENTER> button.
 - The [DYNAMIC CONTRAST] individual adjustment screen is displayed.
- 3) Press ◀▶ to select [USER].
- 4) Press the <ENTER> button.
 - The [DYNAMIC CONTRAST] screen is displayed.
- 5) Press ▲▼ to select the item to set.
 - The items of the detailed settings will switch each time you press ◀▶.
 - Press the <ENTER> button when [MULTI PROJECTOR SYNC] is selected.

Setting item	Details	
[AUTO CONTRAST] (Automatic light source adjustment)	[OFF]	Does not adjust the light source.
	[1] - [255]	The higher the value, the stronger the light adjustment of the light source. Can be set in increments of 1.

Setting item		Details
[BRIGHT SIGNAL LEVEL] (Setting of the brightness level of the signal to start the light adjustment)	[6%] - [50%]	Adjusts the light source when the brightness level of the video signal being input gets lower than the set value. The higher the value, the larger the range to perform the light adjustment of the light source. Can be set in increments of 1 %. (Factory setting: 30 %)
[LIGHTS OUT TIMER] (Time setting until the light turns off)	[DISABLE]	Does not turn off the light source.
	[0.0s] - [10.0s]	Turns off the light source when the brightness level of the video signal being input goes under the value set in [LIGHTS OUT SIGNAL LEVEL]. Select an item from [0.0s] - [4.0s], [5.0s], [7.0s], or [10.0s]. [0.0s] - [4.0s] can be selected in increments of 0.5.
[LIGHTS OUT SIGNAL LEVEL] (Setting of the brightness level of the signal to turn off the light)	[0%] - [5%]	Set the level of the brightness of the video signal to turn off the light source with [LIGHTS OUT TIMER]. Can be set in increments of 1 %. (Factory setting: 0 %)
[MANUAL INTENSITY] (Manual light source adjustment)	[0] - [255]	The larger the value, the stronger the correction. Can be set in increments of 1. (Factory setting: 255)
[DYNAMIC GAMMA] (Adjustment of signal compensation)	[OFF]	Does not compensate the signal.
	[1]	Slightly compensates the signal.
	[2]	Moderately compensates the signal.
	[3]	Strongly compensates the signal.
[MULTI PROJECTOR SYNC]		Sets the contrast synchronization function. This setting item is common with the following menu item. • The [PROJECTOR SETUP] menu → [MULTI PROJECTOR SYNC] Refer to the [PROJECTOR SETUP] menu → [MULTI PROJECTOR SYNC] (➔ page 163) for details.

Note

- [LIGHTS OUT SIGNAL LEVEL] cannot be set when [LIGHTS OUT TIMER] is set to [DISABLE].
- When [LIGHTS OUT TIMER] is set to anything other than [DISABLE], the following are the conditions to turn the light source back on again from the state that the light source has turned off by this function.
 - When the brightness level of the video signal being input has exceeded the value set in [LIGHTS OUT SIGNAL LEVEL]
 - When the input signal is gone
 - When on-screen display such as menu screen (OSD) or input guide, a test pattern, or a warning message is displayed
 - When the operating environment temperature is around 0 °C (32 °F) and the light source is forced to turn on due to warm-up
- When the image of analog signal is projected, the image may be affected by the signal noise while the brightness level of the video signal is detected. In this case, even when the brightness level of the image falls below the value set in [LIGHTS OUT SIGNAL LEVEL], it is judged that the brightness level is not below the value as a signal.
- The contrast will be maximized when [DYNAMIC GAMMA] is set to [3].
- The contrast synchronization function is a function to display a combined screen with a balanced contrast by sharing the brightness level of the video signal input to each projector when a multi-display is constructed by combining the projected image of multiple projectors.
- The [3D SYNC SETTING] setting is disabled and fixed to [OFF] when [MULTI PROJECTOR SYNC] → [MODE] is set to anything other than [OFF].
- The following settings are disabled and the contrast synchronization function and shutter synchronization function cannot be used when [3D SYNC SETTING] is set to anything other than [OFF].
 - The [PICTURE] menu → [DYNAMIC CONTRAST] → [USER] → [MULTI PROJECTOR SYNC]
 - The [DISPLAY OPTION] menu → [SHUTTER SETTING] → [MULTI PROJECTOR SYNC]
 - The [PROJECTOR SETUP] menu → [MULTI PROJECTOR SYNC]

[COLOR SPACE]

Set the color space used for the color representation of the image.

- 1) Press ▲▼ to select [COLOR SPACE].
- 2) Press ◀▶ or the <ENTER> button.
 - The [COLOR SPACE] individual adjustment screen is displayed.
- 3) Press ◀▶ to switch the item.
 - The items will switch each time you press the button.

[NATIVE]	Displays the image with a color space unique to this projector.
[ITU-709]	Displays the image with a color space compliant with the ITU-R BT.709 standard.
[DCI-P3 emu.]	Displays the image with a color space close to DCI-P3.
[ITU-2020 emu.]	Displays the image with a color space close to the ITU-R BT.2020 standard.

Note

- DCI-P3 is the specifications of the digital cinema color region defined by the Digital Cinema Initiatives (DCI).

[SYSTEM SELECTOR]

The projector will automatically detect the input signal, but you can set the system method manually when an unstable signal is input. Set the system method matching the input signal.

- 1) Press ▲▼ to select [SYSTEM SELECTOR].
- 2) Press the <ENTER> button.
- 3) Press ▲▼ to select a system format.
 - Available system formats vary depending on the input signal.

Terminal	System format	
<R/P _R /VIDEO> terminal, <G/Y>/<B/P _B /C> terminal	Select [AUTO], [NTSC], [NTSC4.43], [PAL], [PAL-M], [PAL-N], [SECAM], or [PAL60]. Set it to [AUTO] normally. (Setting [AUTO] will automatically select [NTSC], [NTSC4.43], [PAL], [PAL-M], [PAL-N], [SECAM], or [PAL60].) Switch the setting to the signal method for the TV used.	
<RGB 1 IN> terminal, <RGB 2 IN> terminal	480/60i, 576/50i, or 576/50p signal	Select [RGB] or [Y _C B _C R _R].
	640 x 480/60 or 480/60p signal	Select [640x480/60], [480/60p Y _C B _C R _R], or [480/60p RGB].
	Other movie-based signals	Select [RGB] or [Y _P B _P R _R].
<DVI-D IN> terminal	480/60i, 576/50i, 480/60p, or 576/50p signal	Select [RGB] or [Y _C B _C R _R].
	Other movie-based signals	Select [RGB] or [Y _P B _P R _R].
<HDMI IN> terminal, <DIGITAL LINK/LAN> terminal	480/60i, 576/50i, 480/60p, or 576/50p signal	Select [AUTO], [RGB], or [Y _C B _C R _R].
	Other movie-based signals	Select [AUTO], [RGB], or [Y _P B _P R _R].

- 4) Press the <ENTER> button.

Note

- For details of the types of video signals that can be used with the projector, refer to “List of compatible signals” (➔ page 238).
- This may not function properly for some connected external devices.
- The system method can be set using the following menu items for the SDI input.
 - The [DISPLAY OPTION] menu → [SDI IN] → [SINGLE LINK SETTING] → [SDI1]/[SDI2] → [SYSTEM SELECTOR]
 - The [DISPLAY OPTION] menu → [SDI IN] → [DUAL LINK SETTING] → [SYSTEM SELECTOR]

sRGB-compliant video

sRGB is an international standard (IEC61966-2-1) for color reproduction defined by IEC (International Electrotechnical Commission).

Set according to the following steps to reproduce more faithful, sRGB compliant colors.

- 1) Set [COLOR MATCHING] to [OFF].
 - Refer to [COLOR MATCHING] (➔ page 117).
- 2) Display the [PICTURE] menu.
 - Refer to “[PICTURE] menu” (➔ page 91).
- 3) Press ▲▼ to select [PICTURE MODE].
- 4) Press ◀▶ to set [NATURAL].
- 5) Press ▲▼ to select [COLOR].
- 6) Press the <DEFAULT> button on the remote control to set the factory default setting.
- 7) Follow Steps 5) to 6) to set [TINT], [COLOR TEMPERATURE], [GAMMA], and [SYSTEM DAYLIGHT VIEW] to the factory default settings.

Note

- sRGB is available for RGB signal input only.

[POSITION] menu

On the menu screen, select [POSITION] from the main menu, and select an item from the sub-menu. Refer to “Navigating through the menu” (➔ page 85) for the operation of the menu screen.

Note

- When the optional DIGITAL LINK output supported device (Model No.: ET-YFB100G, ET-YFB200G) is connected to the <DIGITAL LINK/ LAN> terminal, adjust the shift, aspect, and clock phase from the menu of DIGITAL LINK output supported device at first.

[SHIFT]

Move the image position vertically or horizontally if the image projected on the screen is still out of position even when the positions of the projector and screen are correct.

- Press ▲▼ to select [SHIFT].
- Press the <ENTER> button.
 - The [SHIFT] screen is displayed.
- Press ▲▼◀▶ to adjust the position.

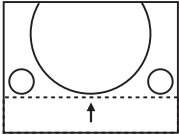
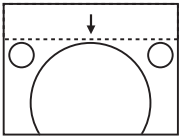
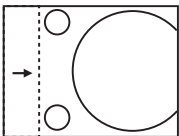
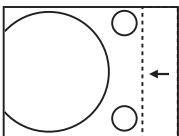
Orientation	Operation	Adjustment	
Vertical (up and down) adjustment	Press ▲.	The image position moves up.	
	Press ▼.	The image position moves down.	
Horizontal (right and left) adjustment	Press ▶.	The image position moves to the right.	
	Press ◀.	The image position moves to the left.	

Note

- For the portrait setting, image position is moved horizontally when “Vertical (up and down) adjustment” is made. Image position is moved vertically when “Horizontal (right and left) adjustment” is made.

[ASPECT]

You can switch the aspect ratio of the image.

The aspect ratio is switched within the screen range selected in the [DISPLAY OPTION] menu → [SCREEN SETTING] → [SCREEN FORMAT]. Set [SCREEN FORMAT] first. (➔ page 118)

- Press ▲▼ to select [ASPECT].
- Press ◀▶ or the <ENTER> button.
 - The [ASPECT] individual adjustment screen is displayed.
- Press ◀▶ to switch the item.
 - The items will switch each time you press the button.

[DEFAULT]	Displays images without changing the aspect ratio of the input signals.
-----------	---

[VID AUTO] ^{*1}	The projector identifies the video ID (VID) embedded in the video signals and displays the image by automatically switching the screen sizes between 4:3 and 16:9. This function is effective for NTSC signals.
[AUTO] ^{*2}	The projector identifies the video ID (VID) embedded in the video signals and displays the image by automatically switching the screen sizes between 4:3 and 16:9. This function is effective for 480/60i and 480/60p signals.
[THROUGH]	Displays images without changing the resolution of the input signals.
[16:9]	Displays images with the aspect ratio converted to 16:9 when standard signals are input ^{*3} . When wide-screen signals are input ^{*4} , the images are displayed without changing the aspect ratio.
[4:3]	Displays images without changing the aspect ratio when standard signals are input ^{*3} . When wide-screen signals are input ^{*4} , and [4:3] is selected in [SCREEN FORMAT], the images are displayed by converting the aspect ratio to 4:3. When anything other than [4:3] is selected in [SCREEN FORMAT], the images are reduced to be displayed without changing input aspect ratio so that the images will fit in the 4:3 screen.
[H FIT]	Displays images using the entire width of the screen range selected in [SCREEN FORMAT]. When signals have the aspect ratio vertically longer than the screen aspect ratio selected in [SCREEN FORMAT], the images are displayed with the top and bottom parts cut off.
[V FIT]	Displays images using the entire height of the screen range selected in [SCREEN FORMAT]. When signals have the aspect ratio horizontally longer than the aspect ratio of the screen selected in [SCREEN FORMAT], the images are displayed with the right and left parts cut off.
[HV FIT]	Displays images in the entire screen range selected in [SCREEN FORMAT]. When the aspect ratio of the input signals differs from that of the screen range, the images are displayed with the aspect ratio converted to that of the screen selected in [SCREEN FORMAT].

*1 During video signals and Y/C signal (NTSC) input only

*2 During RGB signal (480/60i, 480/60p) input only

*3 Standard signals are input signals with an aspect ratio of 4:3 or 5:4.

*4 Wide-screen signals are input signals with an aspect ratio of 16:10, 16:9, 15:9 or 15:10.

Note

- Some size modes are not available for certain types of input signals. [DEFAULT] cannot be selected for video signal, Y/C signal (NTSC), or analog RGB signal (480/60i, 480/60p).
- If an aspect ratio which is different from the aspect ratio for the input signals is selected, the images will appear differently from the originals. Be careful of this when selecting the aspect ratio.
- If using the projector in places such as cafes or hotels to display programs for a commercial purpose or for public presentation, note that adjusting the aspect ratio or using the zoom function to change the screen images may be an infringement of the rights of the original copyright owner for that program under copyright protection laws. Take care when using a function of the projector such as the aspect ratio adjustment and zoom function.
- If conventional (normal) 4:3 images which are not wide-screen images are displayed on a wide screen, the edges of the images may not be visible or they may become distorted. Such images should be viewed as with an aspect ratio of 4:3 in the original format intended by the creator of the images.

[ZOOM]

You can adjust the image size.

The adjustments in [ZOOM] will differ depending on the setting of the [POSITION] menu → [ASPECT].

When [ASPECT] is set to other than [DEFAULT] and [THROUGH]

- 1) Press ▲▼ to select [ZOOM].
- 2) Press the <ENTER> button.
 - The [ZOOM] screen is displayed.
- 3) Press ▲▼ to select [INTERLOCKED].
- 4) Press ◀▶ to switch the item.

[OFF]	Sets the [VERTICAL] and [HORIZONTAL] zoom ratio.
[ON]	Uses [BOTH] to set zoom ratio. Image can be enlarged or reduced vertically and horizontally at the same magnification.

- 5) Press ▲▼ to select [VERTICAL] or [HORIZONTAL].
 - If [ON] is selected, select [BOTH].
- 6) Press ◀▶ to adjust.

Note

- When [ASPECT] is set to [THROUGH], [ZOOM] cannot be adjusted.

When [ASPECT] is set to [DEFAULT]

- 1) Press ▲▼ to select [ZOOM].
- 2) Press the <ENTER> button.
 - The [ZOOM] screen is displayed.
- 3) Press ▲▼ to select [MODE].
- 4) Press ◀▶ to switch the item.

[INTERNAL]	Enlarges the size within the aspect range set with [SCREEN FORMAT].
[FULL]	Enlarges or reduces the size using the entire display area set with [SCREEN FORMAT].

- 5) Press ▲▼ to select [INTERLOCKED].
- 6) Press ◀▶ to switch the item.

[OFF]	Sets the [VERTICAL] and [HORIZONTAL] zoom ratio.
[ON]	Uses [BOTH] to set zoom ratio. Image can be enlarged or reduced vertically and horizontally at the same magnification.

- 7) Press ▲▼ to select [VERTICAL] or [HORIZONTAL].
 - If [ON] is selected, select [BOTH].
- 8) Press ◀▶ to adjust.

Note

- When [ASPECT] is not set to [DEFAULT], [MODE] is not displayed.

[CLOCK PHASE]

You can adjust to achieve an optimal image when there is a flickering image or smeared outlines.

- 1) Press ▲▼ to select [CLOCK PHASE].
- 2) Press ◀▶ or the <ENTER> button.
 - The [CLOCK PHASE] individual adjustment screen is displayed.
- 3) Press ◀▶ to adjust.
 - Adjustment value will change between [0] and [+31]. Adjust so that the amount of interference is at a minimum.

Note

- Some signals may not be adjusted.
- Optimal value may not be achieved if the output from the input computer is unstable.
- Optimal value may not be achieved when there is a shift in the total dot numbers.
- [CLOCK PHASE] can be adjusted only when $Y_{Cb}C_{Cr}/Y_{Pb}P_{Pr}$ signal or RGB signal is input to the <RGB 1 IN> terminal or the <RGB 2 IN> terminal.
- [CLOCK PHASE] cannot be adjusted when a digital signal is input.
- If you press ▶ while the adjustment value is [+31], the value will become [0]. If you press ◀ while the adjustment value is [0], the value will become [+31].

[GEOMETRY]

You can correct various types of distortion in a projected image.

Unique image processing technology enables projection of a square image on a special screen shape.



- 1) Press ▲▼ to select [GEOMETRY].
- 2) Press ◀▶ to switch the item.
 - The items will switch each time you press the button.

[OFF]	Does not perform geometric adjustment.
[KEYSTONE]	Adjusts any trapezoidal distortion in the projected image.
[CORNER/PINCUSHION]	Adjusts any distortion in the four corners of the projected image.
[CURVED CORRECTION]	Adjusts any curved distortion in the projected image.
[PC-1]*1	Performs geometric adjustment using a computer.
[PC-2]*1	
[PC-3]*1	

*1 Advanced skills are necessary to use a computer to control geometric adjustment. Consult your dealer. Up to three geometric adjustments performed using the computer can be saved.

Setting [KEYSTONE] or [CURVED CORRECTION]

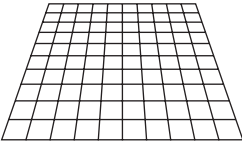
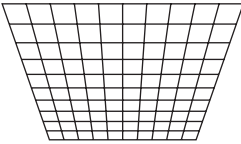
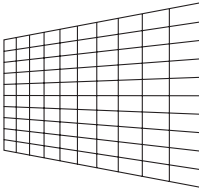
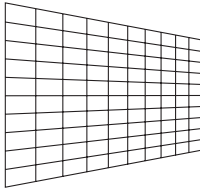
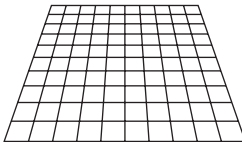
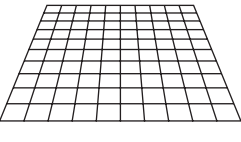
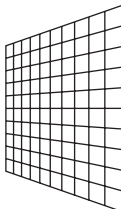
- 1) Press ▲▼ to select [GEOMETRY].
- 2) Press ◀▶ to select [KEYSTONE] or [CURVED CORRECTION].
- 3) Press the <ENTER> button.
 - The [GEOMETRY:KEYSTONE] or [GEOMETRY:CURVED CORRECTION] screen is displayed.
- 4) Press ▲▼ to select the item to adjust.
- 5) Press ◀▶ to adjust.

[KEYSTONE]	
<p>[LENS THROW RATIO] Set the throw ratio. Select the value close to the actual projection distance divided by projected image width here.</p>	
<p>[VERTICAL KEYSTONE]</p> <div style="display: flex; justify-content: space-around; align-items: center;">   </div>	<p>[HORIZONTAL KEYSTONE]</p> <div style="display: flex; justify-content: space-around; align-items: center;">   </div>
<p>[VERTICAL BALANCE]</p> <div style="display: flex; justify-content: space-around; align-items: center;">   </div> <p style="font-size: small; margin-top: 10px;">Adjust the setting according to the lens shift range in the vertical direction.</p>	<p>[HORIZONTAL BALANCE]</p> <div style="display: flex; justify-content: space-around; align-items: center;">   </div> <p style="font-size: small; margin-top: 10px;">Adjust the setting according to the lens shift range in the horizontal direction.</p>

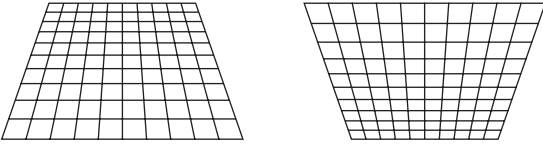
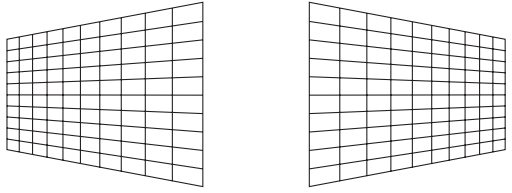
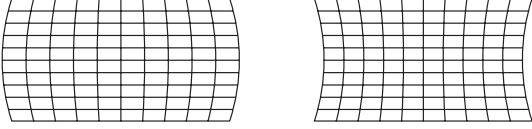
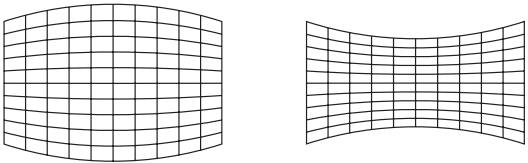
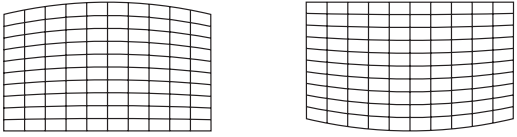
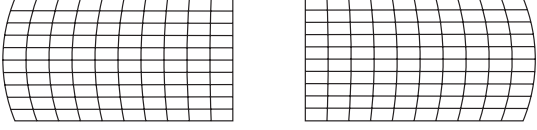
[CURVED CORRECTION]			
<p>[LENS THROW RATIO] Set the throw ratio. Select the value close to the actual projection distance divided by projected image width here.</p>			
<p>[VERTICAL KEYSTONE]</p> 		<p>[HORIZONTAL KEYSTONE]</p> 	
<p>[VERTICAL ARC]</p> 		<p>[HORIZONTAL ARC]</p> 	
<p>[VERTICAL BALANCE]</p> 		<p>[HORIZONTAL BALANCE]</p> 	
<p>[MAINTAIN ASPECT RATIO] Select [ON] to correct while keeping the aspect ratio.</p>			

Setting [CORNER/PINCUSHION]

- 1) Press ▲▼ to select [GEOMETRY].
- 2) Press ◀▶ to select [CORNER/PINCUSHION].
- 3) Press the <ENTER> button.
 - The [GEOMETRY:CORNER/PINCUSHION] screen is displayed.
- 4) Press ▲▼ to select the item to adjust, and press the <ENTER> button.
 - When [LINEARITY] is selected, press ◀▶ to select either adjustment method ([AUTO] or [MANUAL]).
 Select [AUTO] normally.
 For details of operation when [MANUAL] is selected, refer to “Adjusting to desired linearity” (➡ page 104).
- 5) Press ▲▼◀▶ to adjust.

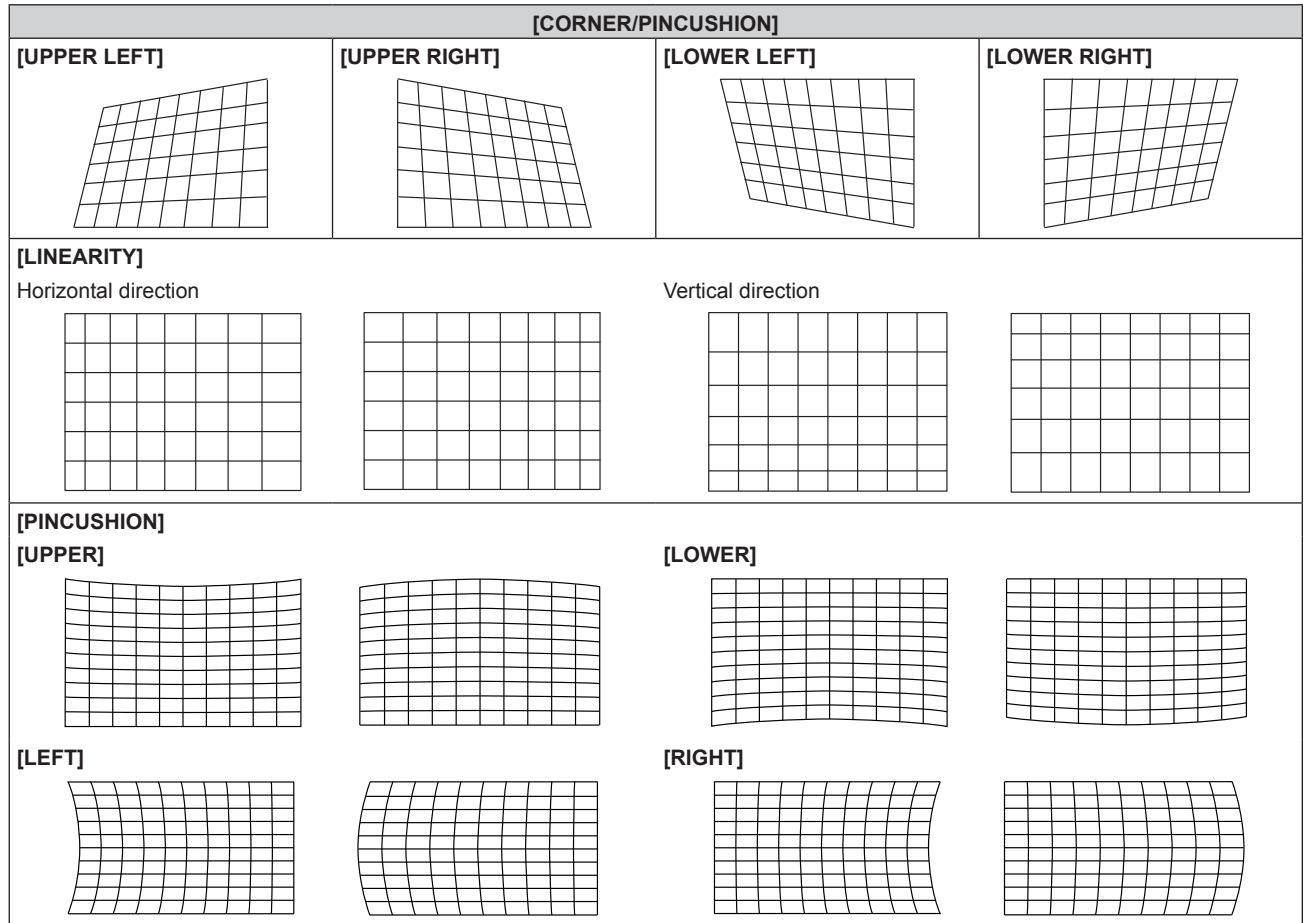

Adjusting to desired linearity

- 1) Press ▲▼ to select [GEOMETRY].
- 2) Press ◀▶ to select [CORNER/PINCUSHION].
- 3) Press the <ENTER> button.
 - The [GEOMETRY:CORNER/PINCUSHION] screen is displayed.
- 4) Press ▲▼ to select [LINEARITY].
- 5) Press ◀▶ to select [MANUAL].
- 6) Press the <ENTER> button.
 - The [LINEARITY] screen is displayed.
- 7) Press ▲▼◀▶ to adjust.

Note

- The menu, logo, or waveform monitor display may run off the screen when [GEOMETRY] is set.
- If [EDGE BLENDING] (▶ page 107) adjustment and [GEOMETRY] are used together, correct edge blending adjustment may not be possible in certain environments.
- The optional Upgrade Kit (Model No.: ET-UK20) can be used to expand the correctable range. To purchase the product, consult your dealer.
- The image may disappear for a moment or may be disrupted while performing adjustment, but it is not a malfunction.

[ADVANCED MENU] menu

On the menu screen, select [ADVANCED MENU] from the main menu, and select an item from the sub-menu.

Refer to “Navigating through the menu” (➔ page 85) for the operation of the menu screen.

[DIGITAL CINEMA REALITY]

The picture quality is enhanced by raising the vertical resolution higher performing the cinema processing when 576/50i signal for PAL (or SECAM), 480/60i signal for NTSC, and 1080/50i or 1080/60i signal is input.

1) Press ▲▼ to select [DIGITAL CINEMA REALITY].

2) Press ◀▶ to switch the item.

- The items will switch each time you press the button.

[AUTO]	Automatically detects the input signal and performs cinema processing.	
[OFF]	Does not perform cinema processing.	
[30p FIXED]	When 480/60i or 1080/60i signal is input	Performs forced cinema processing (2:2 pulldown).
[25p FIXED]	When 576/50i or 1080/50i signal is input	

Note

- In [DIGITAL CINEMA REALITY], the picture quality will degrade when a signal other than the 2:2 pulldown is set as [25p FIXED] or [30p FIXED]. (Vertical resolution will degrade.)
- [DIGITAL CINEMA REALITY] cannot be set when [FRAME RESPONSE] is set to [FAST].

[BLANKING]

Adjust the blanking width when there is a noise at the edge of the screen or the image is slightly running out from the screen while an image from the VCR, etc., is projected.

1) Press ▲▼ to select [BLANKING].

2) Press the <ENTER> button.

- The [BLANKING] adjustment screen is displayed.

3) Press ▲▼ to select [UPPER], [LOWER], [LEFT], or [RIGHT].

- When [CUSTOM MASKING] is set to anything other than [OFF] ([PC-1], [PC-2], or [PC-3]), the blanking width can be adjusted to any shape using the computer. Up to three blanking settings adjusted using the computer can be saved.

To use the [CUSTOM MASKING] function, the optional Upgrade Kit (Model No.: ET-UK20) is required. To purchase the product, consult your dealer.

4) Press ◀▶ to adjust the blanking width.

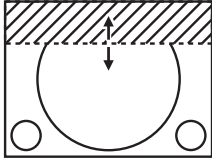
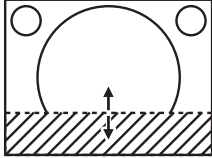
Blanking correction	Item	Operation	Adjustment		Range of adjustment
Top of the screen	[UPPER]	Press ◀.	The blanking zone moves upward.		PT-RZ21K: Top and bottom 0 - 1 198 PT-RS20K: Top and bottom 0 - 1 048
		Press ▶.	The blanking zone moves downward.		
Bottom of the screen	[LOWER]	Press ▶.	The blanking zone moves upward.		
		Press ◀.	The blanking zone moves downward.		

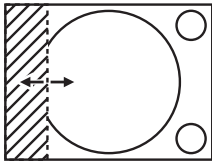
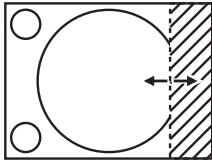
Blanking correction	Item	Operation	Adjustment	Range of adjustment	
Left side of the screen	[LEFT]	Press ▶.	The blanking zone moves to the right.		PT-RZ21K: Left and right 0 - 1 918 PT-RS20K: Left and right 0 - 1 398
		Press ◀.	The blanking zone moves to the left.		
Right side of the screen	[RIGHT]	Press ◀.	The blanking zone moves to the right.		
		Press ▶.	The blanking zone moves to the left.		

Note

- The upper limit of the adjustment range may be restricted so that the entire projected image is not covered by blanking width.

[INPUT RESOLUTION]

You can adjust to achieve an optimal image when there is a flickering image or smeared outlines.

- 1) Press ▲▼ to select [INPUT RESOLUTION].
- 2) Press the <ENTER> button.
 - The [INPUT RESOLUTION] screen is displayed.
- 3) Press ▲▼ to select [TOTAL DOTS], [DISPLAY DOTS], [TOTAL LINES], or [DISPLAY LINES], and press ◀▶ to adjust each item.
 - Values corresponding to the signal being input are displayed automatically for each item. Increase or decrease the displayed values and adjust to the optimal point viewing the screen when there are vertical stripes or sections are missing from the screen.

Note

- Previously mentioned vertical banding will not occur with all white signal input.
- The image may be disrupted while performing the adjustment, but it is not a malfunction.
- [INPUT RESOLUTION] can be adjusted only when RGB signal or YC_BC_R/YP_BP_R signal is input to the <RGB 1 IN> terminal or the <RGB 2 IN> terminal.
- Some signals may not be adjusted.

[CLAMP POSITION]

You can adjust the optimal point when the black part of the image is blunt or it has turned green.

- 1) Press ▲▼ to select [CLAMP POSITION].
- 2) Press ◀▶ to adjust.

Status	Rough guide for optimal value	Range of adjustment
The black part is blunt.	The point where bluntness of the black part improves the most is the optimal value.	1 - 255
The black part is green.	The point where the green part becomes black, and the bluntness has improved is the optimal value.	

Note

- [CLAMP POSITION] can be adjusted only when a signal is input to the <RGB 1 IN> terminal or the <RGB 2 IN> terminal.
- Adjustment is not available depending on the signal.

[EDGE BLENDING]

The edge blending function allows multiple projector images to be seamlessly overlapped by using the inclination of the brightness at the overlapped area.

- 1) Press ▲▼ to select [EDGE BLENDING].
- 2) Press ◀▶ to switch the item.
 - The items will switch each time you press the button.

[OFF]	Sets the edge blending function to off.
[ON]	Use the setting value preset in the projector for the inclination of the edge blending area.
[USER]	Use the user-setting value for the inclination of the edge blending area. (Configuration/registration requires separate software. Consult your dealer.)

- When anything other than [OFF] is selected, proceed to Step 3).
- 3) Press the <ENTER> button.
 - The [EDGE BLENDING] screen is displayed.
 - 4) Press ▲▼ to specify the location to be corrected.
 - When joining at top: Set [UPPER] to [ON]
 - When joining at bottom: Set [LOWER] to [ON]
 - When joining at left: Set [LEFT] to [ON]
 - When joining at right: Set [RIGHT] to [ON]
 - 5) Press ◀▶ to switch to [ON].
 - 6) Press ▲▼ to select [START] or [WIDTH].
 - 7) Press ◀▶ to adjust the starting position or correction width.
 - 8) Press ▲▼ to select [MARKER].
 - 9) Press ◀▶ to switch to [ON].
 - A marker for image position adjustment is displayed. The position where the red and green lines overlap for the projectors to be joined will be the optimal point. Make sure to set the correction width for the projectors to be joined with the same value. Optimal joining is not possible with projectors that have different correction widths.

The optimal point is the point at which these lines overlap.

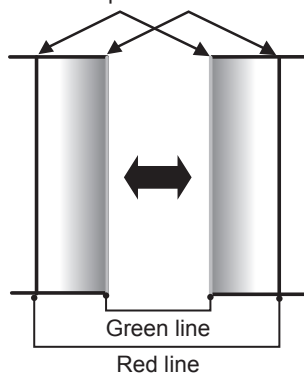

- 10) Press ▲▼ to select [BRIGHTNESS ADJUST].
- 11) Press the <ENTER> button.
 - The [BRIGHTNESS ADJUST] screen is displayed.
 - By setting [AUTO TESTPATTERN] to [ON] on the [EDGE BLENDING] screen, the black test pattern is displayed when you enter the [BRIGHTNESS ADJUST] screen.
- 12) Press ▲▼ to select [NON-OVERLAPPED BLACK LEVEL].
- 13) Press the <ENTER> button.
 - The [NON-OVERLAPPED BLACK LEVEL] screen is displayed.
 - [RED], [GREEN], and [BLUE] can be adjusted individually if [INTERLOCKED] is set to [OFF].

- 14) Press ▲▼ to select an item, and press ◀▶ to adjust the setting.
 - Once the adjustment is completed, press the <MENU> button to return to the [BRIGHTNESS ADJUST] screen.
- 15) Press ▲▼ to select [UPPER], [LOWER], [LEFT], or [RIGHT] in [BLACK BORDER WIDTH].
- 16) Press ◀▶ to set the region (width) of the [BLACK BORDER WIDTH] adjustment.
- 17) Press ▲▼ to select [UPPER KEYSTONE AREA], [LOWER KEYSTONE AREA], [LEFT KEYSTONE AREA], or [RIGHT KEYSTONE AREA].
- 18) Press ◀▶ to adjust the tilt of the border between [NON-OVERLAPPED BLACK LEVEL] and [BLACK BORDER LEVEL].
- 19) Press ▲▼ to select [BLACK BORDER LEVEL].
- 20) Press the <ENTER> button.
 - The [BLACK BORDER LEVEL] screen is displayed.
 - [RED], [GREEN], and [BLUE] can be adjusted individually if [INTERLOCKED] is set to [OFF].
- 21) Press ▲▼ to select an item, and press ◀▶ to adjust the setting.
 - Once the adjustment is completed, press the <MENU> button to return to the [BRIGHTNESS ADJUST] screen.
- 22) Press ▲▼ to select [UPPER], [LOWER], [LEFT], or [RIGHT] for [OVERLAPPED BLACK LEVEL].
- 23) Press the <ENTER> button.
 - The [OVERLAPPED BLACK LEVEL] screen is displayed.
 - [RED], [GREEN], and [BLUE] can be adjusted individually if [INTERLOCKED] is set to [OFF].
- 24) Press ▲▼ to select an item, and press ◀▶ to adjust the setting.

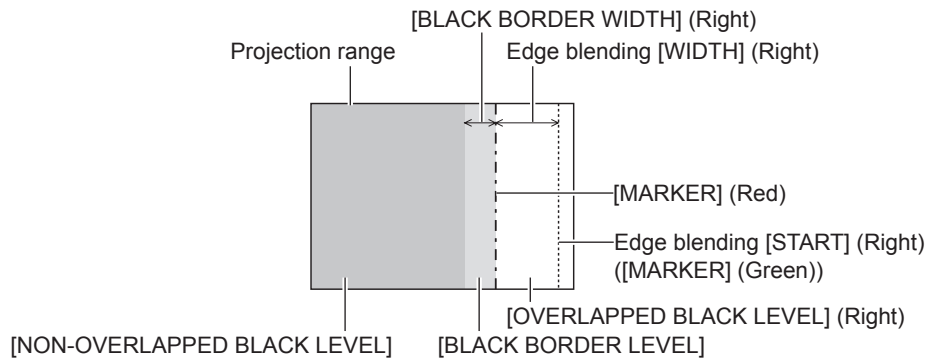

Note

- [BRIGHTNESS ADJUST] is a function that makes the increased brightness in black level of the overlapping image area difficult to notice when [EDGE BLENDING] is used to configure multiple screens. The optimal point of correction is set by adjusting [NON-OVERLAPPED BLACK LEVEL] so the black level of the overlapping image area will be the same level as the non-overlapping area. If the border area of the part where the image is overlapping and the non-overlapping part gets brighter after adjusting [NON-OVERLAPPED BLACK LEVEL], adjust the width of the top, bottom, left, or right. Adjust [BLACK BORDER LEVEL] when the width adjustment makes only the border area darker.
- The joining part may look discontinuous depending on the position you are looking from when a screen with high gain or rear screen is used.
- When configuring multiple screens using both horizontal and vertical edge blending, adjust [OVERLAPPED BLACK LEVEL] first before making adjustments in Step 12). Adjustment method is same as the procedure of [NON-OVERLAPPED BLACK LEVEL].
- If only horizontal or vertical edge blending is used, set all items in [OVERLAPPED BLACK LEVEL] to 0.
- The [AUTO TESTPATTERN] setting changes synchronizing with [AUTO TESTPATTERN] of [COLOR MATCHING].
- Adjustment of the tilt of the border between [NON-OVERLAPPED BLACK LEVEL] and [BLACK BORDER LEVEL] is a function to perform the adjustment of [GEOMETRY] (➔ page 102) together with the edge blending. If [NON-OVERLAPPED BLACK LEVEL] is tilted by correcting the keystone from [KEystone] in [GEOMETRY], perform Steps 17) and 18) to adjust the edge blending according to the shape of [NON-OVERLAPPED BLACK LEVEL].

[FRAME RESPONSE]

Set the processing method of the image frame delay.

- 1) Press ▲▼ to select [FRAME RESPONSE].

2) Press ◀▶ to switch the item.

- The items will switch each time you press the button.

[NORMAL]	Standard setting.
[FAST] ^{*1}	Simplifies the image processing to reduce image frame delay.
[FIXED] ^{*2}	Sets image frame delay to be constant regardless of the image position or magnification.

*1 When input signals are other than interlaced signals, [FAST] cannot be set.

*2 Only when moving image signals and still image signals with the vertical scanning frequency of 50 Hz or 60 Hz are input

Note

- [DIGITAL CINEMA REALITY] cannot be set when [FRAME RESPONSE] is set to [FAST].
- [FRAME RESPONSE] cannot be set during P IN P.

[FRAME DELAY]

Set the additional delay time against the frame delay status by the [FRAME RESPONSE] setting.

1) Press ▲▼ to select [FRAME DELAY].

2) Press the <ENTER> button.

- The [FRAME DELAY] screen is displayed.

3) Press ◀▶ to switch the item.

- The items will switch each time you press the button.

[+0.00ms] - [+100.00ms]	Sets the delay in 0.01 ms increments.
-------------------------	---------------------------------------

- The delay time (approximate) from the point the video signal is input until the image is projected is displayed in [ACTUAL DELAY] of the [FRAME DELAY] screen.

Note

- When the [PROJECTOR SETUP] menu → [MULTI PROJECTOR SYNC] → [MODE] is set to [SLAVE], [FRAME DELAY] cannot be set. In such case, the projector will operate according to the [FRAME DELAY] setting of the projector where the [PROJECTOR SETUP] menu → [MULTI PROJECTOR SYNC] → [MODE] is set to [MASTER].

[FRAME CREATION]

Set the amount of image frame interpolation.

The image with fast movement can be displayed more smoothly by automatically generating the intermediate frame from the previous and next frame.

1) Press ▲▼ to select [FRAME CREATION].

2) Press the <ENTER> button.

- The [FRAME CREATION] screen is displayed.

3) Press ▲▼ to select [FRAME CREATION MODE].

4) Press ◀▶ to switch the item.

- The items will switch each time you press the button.

[OFF]	Disables the frame creation function.
[1]	Sets the amount of interpolation weaker.
[2]	Sets the amount of interpolation midway.
[3]	Sets the amount of interpolation stronger.

Note

- The effect may not be easily visible depending on the image.
- Switch the setting when the image looks unnatural due to delay of image or generation of noise.
- [FRAME CREATION] is fixed to [OFF] in the following cases.
 - When [FRAME RESPONSE] is set to [FAST]
 - When the [DISPLAY OPTION] menu → [SIMUL INPUT SETTING] is set to [AUTO(3D)] or [AUTO(2D)] and displaying an image in simultaneous format
 - When the internal test patter is displayed.
- The [FRAME CREATION] setting is disabled and fixed to [OFF] when [FRAME CREATION] is set to anything other than [OFF] and the following setting or operation is performed.

- Set [FRAME RESPONSE] to [FAST].
- Set the [DISPLAY OPTION] menu → [SIMUL INPUT SETTING] to [AUTO(3D)] or [AUTO(2D)] to display an image in simultaneous format

Setting [FILM DETECTION]

Set the film detection function to enhance the video resolution by determining if it is a content that the telecine is performed on the input signal.

- 1) Press ▲▼ to select [FRAME CREATION].
- 2) Press the <ENTER> button.
 - The [FRAME CREATION] screen is displayed.
- 3) Press ▲▼ to select [FRAME CREATION MODE].
- 4) Press ◀▶ to select a mode from [1], [2], or [3].
- 5) Press ▲▼ to select [FILM DETECTION].
- 6) Press ◀▶ to switch the item.
 - The items will switch each time you press the button.

[OFF]	Disables the film detection function.
[ON]	Enables the film detection function. The video resolution is enhanced for the contents that telecine is performed on the input signal.

Note

- The video resolution is not changed even if [FILM DETECTION] is set to [ON] for the contents that the telecine is not performed on the input signal.
The contents which telecine is performed is the contents that the film image is converted to the video image.
- [FILM DETECTION] cannot be set when a signal for the content with vertical scanning frequency of 30 Hz, 25 Hz, or 24 Hz or a signal for the content with the signal format of 24sF is input.

[FRAME LOCK]

Set this function to display the image in 3D when the vertical scanning frequency of the signal is 25 Hz, 50 Hz, and 100 Hz.

- 1) Press ▲▼ to select [FRAME LOCK].
- 2) Press ◀▶ to switch the item.
 - The items will switch each time you press the button.

[OFF]	Decreases the flickering of the displayed image.
[ON]	Synchronizes the displayed image to the vertical scanning frequency of the input signal.

Note

- [FRAME LOCK] is not displayed when a signal with the vertical scanning frequency other than the above is input or 2D images are displayed.
- The image may flicker when [FRAME LOCK] is set to [ON].
- The displayed image may look discontinuous when [FRAME LOCK] is set to [OFF].

[RASTER POSITION]

This will allow the position of the image to move within the display area arbitrarily when the input image is not using the whole display area.

- 1) Press ▲▼ to select [RASTER POSITION].
- 2) Press the <ENTER> button.
 - The [RASTER POSITION] screen is displayed.
- 3) Press ▲▼◀▶ to adjust the position.

[DISPLAY LANGUAGE] menu

On the menu screen, select [DISPLAY LANGUAGE] from the main menu, and display the sub-menu. Refer to “Navigating through the menu” (➔ page 85) for the operation of the menu screen.

Changing the display language

You can select the language of the on-screen display.

- 1) Press ▲▼ to select the display language and press the <ENTER> button.

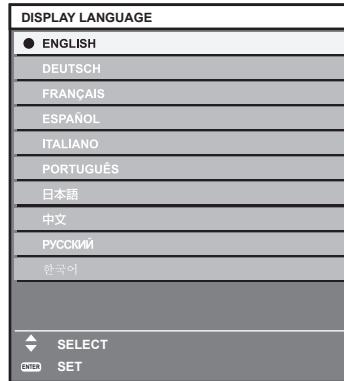

- Various menus, settings, adjustment screens, control button names, etc., are displayed in the selected language.
- The language can be changed to English, German, French, Spanish, Italian, Portuguese, Japanese, Chinese, Russian, or Korean.

Note

- The on-screen display language is set to English in the factory default setting as well as when the [PROJECTOR SETUP] menu → [INITIALIZE] → [ALL USER DATA] is executed.

[3D SETTINGS] menu

On the menu screen, select [3D SETTINGS] from the main menu, and select an item from the sub-menu. Refer to “Navigating through the menu” (➔ page 85) for the operation of the menu screen.

[3D SYSTEM SETTING]

Set the image display method to be used during 3D signal input, according to the 3D system in use.

- 1) Press ▲▼ to select [3D SYSTEM SETTING].
- 2) Press ◀▶ to switch the item.
 - The items will switch each time you press the button.

[SINGLE]	During 3D signal input, images for the left eye and right eye are alternately displayed using the frame sequential format.
[DUAL (LEFT)]	Only images for the left eye are displayed during 3D signal input.
[DUAL (RIGHT)]	Only images for the right eye are displayed during 3D signal input.

Note

- When 2D images are input, 2D images are displayed regardless of the [3D SYSTEM SETTING] settings.

[3D SYNC SETTING]

Set the way in which the <3D SYNC 1 IN/OUT> terminal and the <3D SYNC 2 OUT> terminal will be used.

Attention

- Before connecting external devices to the <3D SYNC 1 IN/OUT> terminal and the <3D SYNC 2 OUT> terminal using cables, complete the [3D SYNC MODE] setting and confirm that the external devices to be connected are turned off.
- Changing the [3D SYNC MODE] setting while the cables are connected may result in malfunctions of the projector or the connected external devices.

- 1) Press ▲▼ to select [3D SYNC SETTING].
- 2) Press the <ENTER> button.
 - The precaution message related to [3D SYNC SETTING] is displayed.
- 3) Press the <ENTER> button.
 - The [3D SYNC SETTING] screen is displayed.
- 4) Press ▲▼ to select [3D SYNC MODE].
- 5) Press ◀▶ to switch the item.

[3D SYNC MODE]	Details to be set in [3D SYNC1]	Details to be set in [3D SYNC2]
[OFF]	Not used.	Not used.
[1]	3D trigger output	Stereo synch output
[2]	3D trigger output	3D trigger output
[3]	Stereo synch input	Through 3D SYNC1
[4]	Stereo synch input	Stereo synch output
[5]	Stereo synch input	3D trigger output
[6]	Frame synch input	Through 3D SYNC1
[7]	Frame synch input	Stereo synch output
[8]	Frame synch input	3D trigger output
[9]	3D trigger output	Frame synch output
[10]	Stereo synch output	Frame synch output
[11]	3D IR TRANSMITTER (+) output	3D IR TRANSMITTER (-) output

- 6) When [1], [4], [7], or [10] is selected, press ▲▼ to select [STEREO SYNC OUTPUT DELAY], and press ◀▶ to set the amount of delay for output.

[0us] - [25000us]	Sets the amount in 10 us increments.
-------------------	--------------------------------------

- To synchronize multiple projectors to display 3D images, use a frame synch input and output. Select [9] or [10] for the first projector.

Select [6], [7], or [8] for the second and subsequent projectors.

- Stereo synchronization is a signal having a 50 % duty cycle where High is for the left eye and Low is for the right eye.
- “H” is output to the 3D image display and “L” is output to the 2D image display from the terminal for which 3D trigger output is selected.

Note

- [11] in [3D SYNC MODE] is the setting when the 3D IR transmitter TY-3DTRW of Panasonic (production discontinued) is used with the projector. Consult your dealer regarding the connection method.
- The following settings are disabled and the contrast synchronization function and shutter synchronization function cannot be used when [3D SYNC SETTING] is set to anything other than [OFF].
 - The [PICTURE] menu → [DYNAMIC CONTRAST] → [USER] → [MULTI PROJECTOR SYNC]
 - The [DISPLAY OPTION] menu → [SHUTTER SETTING] → [MULTI PROJECTOR SYNC]
 - The [PROJECTOR SETUP] menu → [MULTI PROJECTOR SYNC]
- The [3D SYNC SETTING] setting is disabled and fixed to [OFF] when the [PROJECTOR SETUP] menu → [MULTI PROJECTOR SYNC] → [MODE] is set to anything other than [OFF].

[3D INPUT FORMAT]

Set the 3D format for the image signals being input.
Set a 3D format that matches the input signal.

- 1) Press ▲▼ to select [3D INPUT FORMAT].
- 2) Press the <ENTER> button.
 - The [3D INPUT FORMAT] screen is displayed.
- 3) Press ▲▼ to select a 3D format.

[AUTO]*1	Automatically detects 3D format of input image signals to display images.
[NATIVE]	Forcibly displays 2D images regardless of input image signals.
[SIMULTANEOUS]*2	Forcibly displays 3D images in simultaneous format regardless of input video signals.
[SIDE BY SIDE]	Forcibly displays 3D images in side by side format regardless of input image signals.
[TOP AND BOTTOM]	Forcibly displays 3D images in top and bottom format regardless of input image signals.
[LINE BY LINE]*3	Forcibly displays 3D images in line by line format regardless of input video signals.
[FRAME SEQUENTIAL]*4	Forcibly displays 3D images in frame sequential format regardless of input image signals.

*1 Only during DVI-D or HDMI input
 *2 Only during 3G-SDI level B input
 *3 Only while signals other than interlaced signals are input
 *4 Only while progressive signals with the vertical scanning frequency of 100 Hz or 120 Hz are input to the <RGB1>/<RGB2>/<DVI-D> terminals

- 4) Press the <ENTER> button.

Note

- [3D INPUT FORMAT] cannot be set when the [DISPLAY OPTION] menu → [SIMUL INPUT SETTING] is set to anything other than [OFF] and displaying the image in simultaneous format.
- When [AUTO], [SIMULTANEOUS], [SIDE BY SIDE], [TOP AND BOTTOM], [LINE BY LINE], or [FRAME SEQUENTIAL] is set, 3D images are not displayed with the [DISPLAY OPTION] menu → [SIMUL INPUT SETTING]. In [AUTO], this only applies when 3D format can be recognized.
- This may not function properly for some connected external devices.

[LEFT/RIGHT SWAP]

Display images by inverting the timing when the left and right images are swapped. Change the setting when there is something wrong with the 3D image being viewed.

- 1) Press ▲▼ to select [LEFT/RIGHT SWAP].
- 2) Press ◀▶ to switch the item.
 - The items will switch each time you press the button.

[NORMAL]	Do not change the [NORMAL] setting if the 3D images are displayed correctly.
[SWAPPED]	Select this item when left and right 3D images are swapped to be displayed.

Note

- This function is disabled when [3D SYSTEM SETTING] is set to anything other than [SINGLE].

[3D COLOR MATCHING]

Switch the color matching correction data applied to displayed image.

- 1) Press ▲▼ to select [3D COLOR MATCHING].
- 2) Press ◀▶ to switch the item.
 - The items will switch each time you press the button.

[SHARED 2D/3D]	Uses same correction data for 2D signal and 3D signal.
[SEPARATE 2D/3D]	Uses different correction data for 2D signal and 3D signal.

Note

- Switch the setting of [COLOR MATCHING] (▶ page 117) while the signal to be adjusted is being input.

[3D PICTURE BALANCE]

Correct the difference when the images for left eye and right eye have different brightness or color.

- 1) Press ▲▼ to select [3D PICTURE BALANCE].
- 2) Press the <ENTER> button.
 - The [3D PICTURE BALANCE] screen is displayed.
- 3) Press ▲▼ to select an item, and press ◀▶ to adjust the setting.
 - Using the left eye image as a reference, the right eye image is corrected using the set value.
 - For [3D WAVEFORM MONITOR], the images for the left eye and right eye are split horizontally on the left and right, and waveforms are displayed.

[CONTRAST]	Adjusts the contrast of colors.	
[WHITE BALANCE HIGH RED]	Adjusts the red color of the white balance high.	
[WHITE BALANCE HIGH GREEN]	Adjusts the green color of the white balance high.	
[WHITE BALANCE HIGH BLUE]	Adjusts the blue color of the white balance high.	
[BRIGHTNESS]	Adjusts the dark (black) part of the projected image.	
[WHITE BALANCE LOW RED]	Adjusts the red color of the white balance low.	
[WHITE BALANCE LOW GREEN]	Adjusts the green color of the white balance low.	
[WHITE BALANCE LOW BLUE]	Adjusts the blue color of the white balance low.	
[COLOR]	Adjusts the color saturation.	
[TINT]	Adjusts the skin tone in the projected image.	
[CLOCK PHASE]	Adjusts the image when there is flickering in the image or blur of the outline.	
[3D WAVEFORM MONITOR]	[OFF]	Does not display the 3D waveform monitor.
	[ON]	Displays the 3D waveform monitor.

Note

- The [CLOCK PHASE] setting is enabled during simultaneous input of RGB1 and RGB2, and is adjusted against the right eye image.
- This function is disabled when [3D SYSTEM SETTING] is set to anything other than [SINGLE].
- This function is disabled when [3D TEST PATTERN] is displayed.
- This function is disabled when [3D TEST MODE] is set to anything other than [NORMAL].
- The 3D waveform monitor is displayed only when the [3D PICTURE BALANCE] screen is displayed.
- The normal waveform monitor cannot be displayed when the 3D image is displayed.

[DARK TIME SETTING]

Set the black display period that is displayed between the right eye image and the left eye image to match the 3D system in use.

- 1) Press ▲▼ to select [DARK TIME SETTING].
- 2) Press ◀▶ to switch the item.
 - The items will switch each time you press the button.

[0.5ms]	Sets an item so that 3D setting is made correctly.
[1.0ms]	
[1.5ms]	
[2.0ms]	
[2.5ms]	
[2.7ms]	

Note

- This function is disabled when [3D SYSTEM SETTING] is set to anything other than [SINGLE].
- The crosstalk may get larger or the displayed image may get darker when the setting does not match with the 3D system in use.

[3D TEST MODE]

Set the image display mode for use with 3D system adjustments.

- 1) Press ▲▼ to select [3D TEST MODE].
- 2) Press ◀▶ to switch the item.

[NORMAL]	Normal setting.
[LEFT/LEFT]	Displays the image of the left eye input signal for both the left and right eye image.
[RIGHT/RIGHT]	Displays the image of the right eye input signal for both the left and right eye images.
[LEFT/BLACK]	Displays the image of the left eye input signal for the left eye image, and all black images for the right eye image.
[BLACK/RIGHT]	Displays all black images for the left eye image, and the image of the right eye input signal for the right eye image.

Note

- The [3D TEST MODE] setting returns to [NORMAL] when the projector is switched off.
- This function is disabled when [3D SYSTEM SETTING] is set to anything other than [SINGLE].
- This function is disabled when [3D TEST PATTERN] is displayed.

[3D TEST PATTERN]

The 3D test pattern can be used to check operation and make adjustments even without a 3D signal.

- 1) Press ▲▼ to select [3D TEST PATTERN].
- 2) Press ◀▶ to switch the item.

Menu screen + input screen	Select a test pattern that is easy to check operation or make adjustment.
Menu screen + left: black/ right: white	
Menu screen + left: white/ right: black	
Menu screen + alternate display of left/right	
Menu screen + alternate display of right/left	

Note

- When the [DISPLAY OPTION] menu → [RGB IN] → [RGB1 INPUT SETTING] (➡ page 122) is set to [VIDEO] or [Y/C], the 3D test pattern cannot be displayed while the <RGB 1 IN> terminal is selected.
- This function is disabled when [3D SYSTEM SETTING] is set to anything other than [SINGLE].

[SAFETY PRECAUTIONS MESSAGE]

Set to show or hide the safety precautions message related to 3D viewing when the projector is switched on.

- 1) Press ▲▼ to select [SAFETY PRECAUTIONS MESSAGE].
- 2) Press ◀▶ to switch the item.
 - The items will switch each time you press the button.

[ON]	Shows the safety precautions message related to 3D viewing when the projector is switched on.
[OFF]	Hides the safety precautions message related to 3D viewing when the projector is switched on.

Note

- If [OFF] is set, the safety precautions message related to 3D viewing is not displayed when the projector is switched on.
- A confirmation screen is displayed when switched from [ON] to [OFF]. Press ◀▶ to select [OK], and press the <ENTER> button to change the setting to [OFF].

Attention

- If 3D images are viewed by unspecified number of people for commercial use, display the safety precautions message related to 3D viewing to notify viewers.

[3D SAFETY PRECAUTIONS]

Show the safety precautions message related to 3D viewing.

- 1) Press ▲▼ to select [3D SAFETY PRECAUTIONS].
- 2) Press the <ENTER> button.
 - The [3D SAFETY PRECAUTIONS] screen is displayed.
 - Press ◀▶ to switch the page.

3D SAFETY PRECAUTIONS 1/2	3D SAFETY PRECAUTIONS 2/2
<p>If you view 3D images, please note below. In addition, when 3D images will be viewed by unspecified number of people or used for commercial applications, someone in authority should convey the following precautions.</p> <p>To enjoy 3D images safely and comfortably, please refer to the Operating Instructions for in-depth description.</p>	<p>Please refrain from viewing 3D images if you do not feel well or are experiencing visual fatigue. Please use the contents which has been properly made for 3D. View from at least the recommended distance. (3 times the effective height of the screen)</p> <p>Refer to the Operating Instructions if this message is no longer needed.</p>
◀▶ CHANGE MENU EXIT	◀▶ CHANGE MENU EXIT

[DISPLAY OPTION] menu

On the menu screen, select [DISPLAY OPTION] from the main menu, and select an item from the sub-menu.

Refer to “Navigating through the menu” (➔ page 85) for the operation of the menu screen.

[COLOR MATCHING]

Correct the color difference between projectors when using multiple projectors simultaneously.

Adjusting the color matching as desired

- 1) Press ▲▼ to select [COLOR MATCHING].
- 2) Press ◀▶ to switch the item.
 - The items will switch each time you press the button.

[OFF]	Color matching adjustment is not carried out.
[3COLORS]	Adjusts the three colors [RED], [GREEN], or [BLUE].
[7COLORS]	Adjusts the seven colors [RED], [GREEN], [BLUE], [CYAN], [MAGENTA], [YELLOW], or [WHITE].
[MEASURED]	Refer to “Adjusting the color matching using a colorimeter” (➔ page 117) for details about this mode.

- 3) Select [3COLORS] or [7COLORS], and press the <ENTER> button.
 - The [3COLORS] or [7COLORS] screen is displayed.
- 4) Press ▲▼ to select [RED], [GREEN], or [BLUE] ([RED], [GREEN], [BLUE], [CYAN], [MAGENTA], [YELLOW], or [WHITE] when [7COLORS] is selected).
- 5) Press the <ENTER> button.
 - The [3COLORS:RED], [3COLORS:GREEN], or [3COLORS:BLUE] screen is displayed.
When [7COLORS] is selected, the [7COLORS:RED], [7COLORS:GREEN], [7COLORS:BLUE], [7COLORS:CYAN], [7COLORS:MAGENTA], [7COLORS:YELLOW], or [7COLORS:WHITE] screen is displayed.
 - By setting [AUTO TESTPATTERN] to [ON], the test pattern for the selected color is displayed.
- 6) Press ▲▼ to select [RED], [GREEN], or [BLUE].
- 7) Press ◀▶ to adjust.
 - The adjustment value changes between 0 and 2 048.

Note

- Operation when correcting the adjustment color
When the correction color same as the adjustment color is changed: The luminance of the adjustment color changes.
When correction color red is changed: Red is added to or subtracted from the adjustment color.
When correction color green is changed: Green is added to or subtracted from the adjustment color.
When correction color blue is changed: Blue is added to or subtracted from the adjustment color.
- Since advanced skills are necessary for the adjustment, this adjustment should be carried out by a person who is familiar with the projector or by a service person.
- Pressing the <DEFAULT> button on the remote control will restore the factory default settings for all items.
- When [COLOR MATCHING] is set to other than [OFF], [COLOR TEMPERATURE] is fixed to [USER1].
- By setting [3D COLOR MATCHING] (➔ page 114), you can set whether to configure separate settings for 2D signal and 3D signal, or to use common data.
- Either [NATIVE] or [3D] is displayed at the top right of the menu when separate settings are used for 2D signal and 3D signal.

Adjusting the color matching using a colorimeter

Use a colorimeter that can measure chromaticity coordinates and luminance to change the colors [RED], [GREEN], [BLUE], [CYAN], [MAGENTA], [YELLOW], or [WHITE] to desired colors.

- 1) Press ▲▼ to select [COLOR MATCHING].
- 2) Press ◀▶ to select [MEASURED].
- 3) Press the <ENTER> button.
 - The [MEASURED MODE] screen is displayed.

- 4) Press ▲▼ to select [MEASURED DATA].
- 5) Press the <ENTER> button.
 - The [MEASURED DATA] screen is displayed.
- 6) Measure the current luminance (Y) and the chromaticity coordinates (x, y) using the colorimeter.
- 7) Press ▲▼ to select a color, and press ◀▶ to adjust the setting.
 - Set [AUTO TESTPATTERN] to [ON] to display a test pattern of selected colors.
- 8) Once all the input is completed, press the <MENU> button.
 - The [MEASURED MODE] screen is displayed.
 - When [MEASURED] is selected in Step 2), proceed to Step 9) and enter the coordinates of desired colors.
- 9) Press ▲▼ to select [TARGET DATA].
- 10) Press the <ENTER> button.
 - The [TARGET DATA] screen is displayed.
- 11) Press ▲▼ to select a color and press ◀▶ to input coordinates for desired colors.
 - By setting [AUTO TESTPATTERN] to [ON], the test pattern for the selected color is displayed.
- 12) Once all the input is completed, press the <MENU> button.

Note

- Colors are not displayed properly when target data is a color outside the region of this projector.
- Set the [AUTO TESTPATTERN] to [ON] to automatically display a test pattern for use in adjusting the selected adjustment colors.
- [AUTO TESTPATTERN] settings change together with the [AUTO TESTPATTERN] of [EDGE BLENDING].
- Before using a colorimeter or similar instrument to measure measurement data, set [PICTURE MODE] to [DYNAMIC].
- A difference in the color coordinates of target data and measurement values obtained from an instrument may occur for certain instruments and measurement environments used.

[LARGE SCREEN CORRECTION]

Corrects the phenomenon in which colors that appear lighter when viewed on a large screen viewed from a close distance compared to when viewed on an average screen size so that colors appear the same.

- 1) Press ▲▼ to select [LARGE SCREEN CORRECTION].
- 2) Press ◀▶ to switch the item.

[OFF]	Performs no correction.
[1]	Performs weak correction.
[2]	Performs strong correction.

[SCREEN SETTING]

Set the screen size.

Correct to the optimum image position for the set screen when the aspect ratio of a projected image is changed. Set as necessary for the screen in use.

- 1) Press ▲▼ to select [SCREEN SETTING].
- 2) Press the <ENTER> button.
 - The [SCREEN SETTING] screen is displayed.
- 3) Press ◀▶ to switch the [SCREEN FORMAT] item.
 - The items will switch each time you press the button.

Model No.	[SCREEN FORMAT]	Range when [SCREEN POSITION] is selected
PT-RZ21K	[16:10]	Cannot be adjusted.
	[4:3]	Adjusts the horizontal position between -160 and 160.
	[16:9]	Adjusts the vertical position between -60 and 60.
PT-RS20K	[4:3]	Cannot be adjusted.
	[16:9]	Adjusts the vertical position between -132 and 131.

4) Press ▲▼ to select [SCREEN POSITION].

- [SCREEN POSITION] cannot be selected or adjusted when [SCREEN FORMAT] is set to the following item.

PT-RZ21K: [16:10]

PT-RS20K: [4:3]

5) Press ◀▶ to adjust [SCREEN POSITION].

[AUTO SIGNAL]

Set whether to execute automatic setup of signals automatically.

The screen display position or signal level can be adjusted automatically without pressing the <AUTO SETUP> button on the remote control on each occasion if you input unregistered signals frequently at meetings, etc.

1) Press ▲▼ to select [AUTO SIGNAL].

2) Press ◀▶ to switch the item.

- The items will switch each time you press the button.

[OFF]	Sets the auto signal function to off.
[ON]	Executes automatic setup automatically when images are changed to unregistered signals during projection.

[AUTO SETUP]

Set this when adjusting a special signal or horizontally long (such as 16:9) signal.

Setting with [MODE]

1) Press ▲▼ to select [AUTO SETUP].

2) Press the <ENTER> button.

- The [AUTO SETUP] screen is displayed.

3) Press ▲▼ to select [MODE].

4) Press ◀▶ to switch the item.

- The items will switch each time you press the button.

[DEFAULT]	Standard setting.
[WIDE]	Select this item when an image aspect ratio is a wide-screen signal, which does not meet the [DEFAULT] setting.
[USER]	Select this item when receiving a signal with a special horizontal resolution (number of display dots).

- When [DEFAULT] or [WIDE] is selected, proceed to Step 7).

- When [USER] is selected, proceed to Step 5).

5) Press ▲▼ to select [DISPLAY DOTS], and press ◀▶ to adjust [DISPLAY DOTS] to the horizontal resolution of the signal source.

6) Press ▲▼ to select [MODE].

7) Press the <ENTER> button.

- Automatic adjustment is executed. [PROGRESS] is displayed while in automatic adjustment. When completed, the screen returns to the [AUTO SETUP] screen.

Note

- Automatic setup of signal can be executed when analog RGB signal consisting of dots such as computer signal, or DVI-D/HDMI signal is being input.

Adjusting position automatically

1) Press ▲▼ to select [AUTO SETUP].

- 2) Press the <ENTER> button.
 - The [AUTO SETUP] screen is displayed.
- 3) Press ▲▼ to select [POSITION ADJUST].
- 4) Press ◀▶ to switch the item.

[ON]	Adjust the screen position and size when automatic setup is executed.
[OFF]	Does not perform automatic adjustment.

Adjusting signal level automatically

- 1) Press ▲▼ to select [AUTO SETUP].
- 2) Press the <ENTER> button.
 - The [AUTO SETUP] screen is displayed.
- 3) Press ▲▼ to select [SIGNAL LEVEL ADJUST].
- 4) Press ◀▶ to switch the item.

[OFF]	Does not perform automatic adjustment.
[ON]	Adjusts black level (the [PICTURE] menu → [BRIGHTNESS]) and white level (the [PICTURE] menu → [CONTRAST]) when automatic setup is executed.

Note

- [SIGNAL LEVEL ADJUST] may not function properly unless a still image containing clear blacks and whites is input.

[BACKUP INPUT SETTING]

Set the backup function that switches the signal to the backup input signal as seamless as possible when input signal is disrupted.

- 1) Press ▲▼ to select [BACKUP INPUT SETTING].
- 2) Press the <ENTER> button.
 - The [BACKUP INPUT SETTING] screen is displayed.
- 3) Press ▲▼ to select [BACKUP INPUT MODE].
- 4) Press the <ENTER> button.
 - The [BACKUP INPUT MODE] screen is displayed.
- 5) Press ▲▼ to select the combination of the input and press the <ENTER> button.

Primary input	Secondary input	Details
[OFF]		Disables the backup function.
[DVI-D]	[HDMI]	Enables the backup function.
[SDI1]	[SDI2]	
[SDI1]	[DVI-D]	
[SDI2]	[HDMI]	

- 6) Press the <MENU> button.
 - The [BACKUP INPUT SETTING] screen is displayed.
- 7) Press ▲▼ to select [AUTOMATIC SWITCHING].
 - When [BACKUP INPUT MODE] is set to [OFF], [AUTOMATIC SWITCHING] cannot be selected.
- 8) Press ◀▶ to switch the item.
 - The items will switch each time you press the button.

[ENABLE]	Switches to the secondary input (primary input) automatically when the input signal for primary input (secondary input) is disrupted.
[DISABLE]	Disables the automatic input switching function.

Note

- The backup function is enabled when [BACKUP INPUT MODE] is set to anything other than [OFF] and same signal is input to the primary input and the secondary input.
- To switch to the backup input signal using the backup function, make sure that the following three conditions are satisfied to be ready to use the function.
 - Set [BACKUP INPUT MODE] to anything other than [OFF].
 - Input the same signal to the primary and secondary inputs.
 - Display the image of the primary input or secondary input.
- If the input is switched to other than the primary or secondary input while the backup function is ready for use, the state of readiness to use the backup function is canceled. To switch to the backup input signal using the backup function again, switch to the primary input or secondary input.
- When [BACKUP INPUT MODE] is set to anything other than [OFF], the combination of that input is displayed in [PRIMARY INPUT] and [SECONDARY INPUT] of the [BACKUP INPUT SETTING] screen.
- [BACKUP INPUT STATUS] is displayed in the input guide (➔ page 131) and the [STATUS] screen (➔ pages 82, 167) when [BACKUP INPUT MODE] is set to anything other than [OFF].
 When the signal can be switched to the backup input signal using the backup function, [ACTIVE] is displayed in [BACKUP INPUT STATUS]. When it is not possible, [INACTIVE] is displayed instead.
 The secondary input will be the backup input when [BACKUP INPUT STATUS] is displaying [ACTIVE] while the image from the primary input is displayed.
 The primary input will be the backup input when [BACKUP INPUT STATUS] is displaying [ACTIVE] while the image from the secondary input is displayed.
- When [BACKUP INPUT MODE] is set to anything other than [OFF], the input is switched seamlessly if the input is switched between the primary input and the secondary input while it is possible to switch to the backup input signal.
- When [AUTOMATIC SWITCHING] is set to [ENABLE], and [BACKUP INPUT STATUS] shows [ACTIVE], the signal is switched to the backup input if a disruption occurs in the input signal.
- When [AUTOMATIC SWITCHING] is set to [ENABLE], the indication in [BACKUP INPUT STATUS] will change to [INACTIVE] if the input signal is disrupted and automatically switched to the backup input. In this case, it is not possible to switch to the backup input signal until the original input signal is restored. If the input has switched to the backup input automatically, it is possible to switch to the backup input signal when the original signal has restored. In this case, the current input is maintained.
- [BACKUP INPUT SETTING] cannot be set during P IN P. The backup operation is not performed either.
- When the [DISPLAY OPTION] menu → [SIMUL INPUT SETTING] → [HDMI/DVI-D] is set to anything other than [OFF], [BACKUP INPUT MODE] which includes the DVI-D input and HDMI input in the combination of inputs cannot be selected.
- When the [DISPLAY OPTION] menu → [SIMUL INPUT SETTING] → [SDI1/SDI2] is set to anything other than [OFF], [BACKUP INPUT MODE] which includes the SDI1 input and SDI2 input in the combination of inputs cannot be selected.
- When the [DISPLAY OPTION] menu → [SDI IN] → [SDI LINK] is set to [DUAL] or [AUTO], [BACKUP INPUT MODE] which includes the SDI1 input and SDI2 input in the combination of inputs cannot be selected.
- The primary input setting values are applied to image adjustment values such as the [PICTURE] menu → [PICTURE MODE], [GAMMA], and [COLOR TEMPERATURE].
- When the combination of inputs in [BACKUP INPUT MODE] is the SDI1 input and DVI-D input or the SDI2 input and HDMI input, the backup function is enabled only in the following combination of signals.

Primary input [SDI1]/[SDI2]	Secondary input [DVI-D]/[HDMI]
HD-SDI 720/60p YP _B P _R 4:2:2	720/60p YP _B P _R 4:4:4
HD-SDI 720/50p YP _B P _R 4:2:2	720/50p YP _B P _R 4:4:4
3G-SDI 1080/60i RGB	1080/60i RGB
3G-SDI 1080/50i RGB	1080/50i RGB
3G-SDI 1080/24p RGB	1080/24p RGB
3G-SDI 1080/25p RGB	1080/25p RGB
3G-SDI 1080/30p RGB	1080/30p RGB
3G-SDI 1080/60p YP _B P _R 4:2:2	1080/60p YP _B P _R 4:4:4
3G-SDI 1080/50p YP _B P _R 4:2:2	1080/50p YP _B P _R 4:4:4

[SIMUL INPUT SETTING]

Set this function when the video signal in simultaneous format is input and used.

- 1) Press ▲▼ to select [SIMUL INPUT SETTING].
- 2) Press the <ENTER> button.
 - The [SIMUL INPUT SETTING] screen is displayed.
- 3) Press ▲▼ button to select [RGB1/RGB2], [HDMI/DVI-D], or [SDI1/SDI2].
- 4) Press ◀▶ to switch the setting.
 - The items will switch each time you press the button.

[OFF]	This is not used for simultaneous input.
[AUTO(3D)]	Displays 3D images of the simultaneous format.

[AUTO(2D)]*1	Displays 2D image of the simultaneous format.
--------------	---

*1 This can be set only when [SIMUL INPUT SETTING] is set to [HDMI/DVI-D] or [SDI1/SDI2].

Note

- If [AUTO(2D)] is set, 2D images are displayed when the same 2D compatible signals are entered to each input.
- If [AUTO(3D)] is set, 3D images are displayed when the same 3D compatible signals are entered to each input.
- [SIMUL INPUT SETTING] cannot be set during P IN P.
- [HDMI/DVI-D] or [SDI1/SDI2] in [SIMUL INPUT SETTING] (including the input set as the primary input or the secondary input) is fixed to [OFF] when the [DISPLAY OPTION] menu → [BACKUP INPUT SETTING] → [BACKUP INPUT MODE] is set to anything other than [OFF].
- [SDI1/SDI2] in [SIMUL INPUT SETTING] is fixed to [OFF] when the [DISPLAY OPTION] menu → [SDI IN] → [SDI LINK] is set to anything other than [SINGLE].
- This may not function properly for some connected external devices.
- This may not function properly depending on the signal.
- Usage of each input signal is displayed in [RGB1] and [RGB2], in [HDMI] and [DVI-D], and in [SDI1] and [SDI2] of the [SIMUL INPUT SETTING] screen when [AUTO(3D)] or [AUTO(2D)] is set.

[SIMUL INPUT SETTING]	Usage of the input signal	Details
[AUTO(3D)]	[LEFT INPUT]	Uses the signal for the corresponding input as a signal for the left eye image.
	[RIGHT INPUT]	Uses the signal for the corresponding input as a signal for the right eye image.
[AUTO(2D)]*1	[1st FRAME INPUT]	Uses the signal for the corresponding input as a signal for the odd frame.
	[2nd FRAME INPUT]	Uses the signal for the corresponding input as a signal for the even frame.

*1 This can be set only when [SIMUL INPUT SETTING] is set to [HDMI/DVI-D] or [SDI1/SDI2].

[RGB IN]

Set to match the signal to input to the <RGB 1 IN> terminal.

Setting [RGB1 INPUT SETTING]

- 1) Press ▲▼ to select [RGB IN].
- 2) Press the <ENTER> button.
 - The [RGB IN] screen is displayed.
- 3) Press ▲▼ to select [RGB1 INPUT SETTING].
- 4) Press ◀▶ to switch the item.
 - The items will switch each time you press the button.

[RGB/YP _B P _R]	Select this item when an RGB signal or YC _B C _R /YP _B P _R signal is input to the <RGB 1 IN> terminal.
[VIDEO]	Select this item when a video signal is input to the <RGB 1 IN> (<R/P _R /VIDEO>) terminal.
[Y/C]	Select this item when a luminance signal and color signal are input to the <RGB 1 IN> (<G/Y>, <B/P _B /C>) terminal.

Switching the slice level of an input sync signal

- 1) Press ▲▼ to select [RGB IN].
- 2) Press the <ENTER> button.
 - The [RGB IN] screen is displayed.
- 3) Press ▲▼ to select [RGB1 SYNC SLICE LEVEL] or [RGB2 SYNC SLICE LEVEL].
- 4) Press ◀▶ to switch the item.

[LOW]	Sets the slice level to [LOW].
[HIGH]	Sets the slice level to [HIGH].

Setting [RGB2 EDID MODE]

- 1) Press ▲▼ to select [RGB IN].
- 2) Press the <ENTER> button.
 - The [RGB IN] screen is displayed.
- 3) Press ▲▼ to select [RGB2 EDID MODE].
- 4) Press the <ENTER> button.
 - The [RGB2 EDID MODE] screen is displayed.
- 5) Press ◀▶ to switch [EDID MODE].
 - The items will switch each time you press the button.

[DEFAULT]	Standard setting.
[SCREEN FIT]	Changes EDID data according to the [SCREEN FORMAT] setting.
[USER]	Sets the [RESOLUTION] and [VERTICAL SCAN FREQUENCY] items to EDID.

- When [DEFAULT] or [SCREEN FIT] is selected, proceed to Step 10).
- 6) Press the <ENTER> button.
 - The [RESOLUTION] screen is displayed.
 - 7) Press ▲▼◀▶ to select [RESOLUTION].
 - Select [1024x768p], [1280x720p], [1280x768p], [1280x800p], [1280x1024p], [1366x768p], [1400x1050p], [1440x900p], [1600x900p], [1600x1200p], [1680x1050p], [1920x1080p], [1920x1080i], or [1920x1200p].
 - 8) Press the <ENTER> button.
 - The [VERTICAL SCAN FREQUENCY] screen is displayed.
 - 9) Press ◀▶ to select [VERTICAL SCAN FREQUENCY].
 - Select [60Hz], [50Hz], [30Hz], [25Hz], or [24Hz] when [1920x1080p] is selected for [RESOLUTION].
 - Select [60Hz], [50Hz], or [48Hz] when [1920x1080i] is selected for [RESOLUTION].
 - Select [60Hz] or [50Hz] when anything other than following is selected for [RESOLUTION].
 - [1920x1080p], [1920x1080i]
 - 10) Press the <ENTER> button.
 - The confirmation screen is displayed.
 - 11) Press ◀▶ to select [OK], and press the <ENTER> button.

Note

- The setting details are displayed in [RESOLUTION] and [VERTICAL SCAN FREQUENCY] of [EDID STATUS].
- The resolution and vertical scanning frequency settings may also be required on your computer or video device.
- After configuring settings, your computer or video device or the projector may be required to be turned off and on.
- A signal may not be output with the resolution and vertical scanning frequency that have been set, depending on your computer or video device.

[DVI-D IN]

Set this item in accordance with the video signal input to the <DVI-D IN> terminal.

Setting [SIGNAL LEVEL] in [DVI-D IN]

- 1) Press ▲▼ to select [DVI-D IN].
- 2) Press the <ENTER> button.
 - The [DVI-D IN] screen is displayed.
- 3) Press ▲▼ to select [SIGNAL LEVEL].
- 4) Press ◀▶ to switch the item.
 - The items will switch each time you press the button.

[AUTO]	Automatically sets the signal level.
[0-255:PC]	Select this item when the signal output from the DVI-D terminal of the external device (such as a computer) is input to the <DVI-D IN> terminal.
[16-235]	Select this item when the signal output from the HDMI terminal of the external device (such as a Blu-ray disc player) is input to the <DVI-D IN> terminal using a conversion cable, etc.

Note

- The optimal setting varies depending on the output setting of the connected external device. Refer to the operating instructions of the external device regarding the output of the external device.

Setting [EDID SELECT] in [DVI-D IN]

- 1) Press ▲▼ to select [DVI-D IN].
- 2) Press the <ENTER> button.
 - The [DVI-D IN] screen is displayed.
- 3) Press ▲▼ to select [EDID SELECT].
- 4) Press ◀▶ to switch the item.
 - The items will switch each time you press the button.

[EDID3]	Recognizes movie-based video signals and still image signals automatically.
[EDID1]	Select this item mainly when an external device that outputs movie-based video signals (such as a Blu-ray disc player) is connected to the <DVI-D IN> terminal.
[EDID2:PC]	Select this item mainly when an external device that outputs still image-based video signals (such as a computer) is connected to the <DVI-D IN> terminal.

Note

- The data for Plug and play will change when the setting is changed. Refer to “List of compatible signals” (➡ page 238) for a resolution that supports plug and play.

Setting [EDID MODE] in [DVI-D IN]

- 1) Press ▲▼ to select [DVI-D IN].
- 2) Press the <ENTER> button.
 - The [DVI-D IN] screen is displayed.
- 3) Press ▲▼ to select [EDID MODE].
- 4) Press the <ENTER> button.
 - The [DVI-D EDID MODE] screen is displayed.
- 5) Press ◀▶ to switch [EDID MODE].
 - The items will switch each time you press the button.

[DEFAULT]	Standard setting.
[SCREEN FIT]	Changes EDID data according to the [SCREEN FORMAT] setting.
[USER]	Sets the [RESOLUTION] and [VERTICAL SCAN FREQUENCY] items to EDID.

- When [DEFAULT] or [SCREEN FIT] is selected, proceed to Step 10).
- 6) Press the <ENTER> button.
 - The [RESOLUTION] screen is displayed.
 - 7) Press ▲▼◀▶ to select [RESOLUTION].
 - Select [1024x768p], [1280x720p], [1280x768p], [1280x800p], [1280x1024p], [1366x768p], [1400x1050p], [1440x900p], [1600x900p], [1600x1200p], [1680x1050p], [1920x1080p], [1920x1080i], or [1920x1200p].
 - 8) Press the <ENTER> button.
 - The [VERTICAL SCAN FREQUENCY] screen is displayed.

- 9) Press ◀▶ to select [VERTICAL SCAN FREQUENCY].
 - Select [60Hz], [50Hz], [30Hz], [25Hz], or [24Hz] when [1920x1080p] is selected for [RESOLUTION].
 - Select [60Hz], [50Hz], or [48Hz] when [1920x1080i] is selected for [RESOLUTION].
 - Select [60Hz] or [50Hz] when anything other than following is selected for [RESOLUTION].
 - [1920x1080p], [1920x1080i]
- 10) Press the <ENTER> button.
 - The confirmation screen is displayed.
- 11) Press ◀▶ to select [OK], and press the <ENTER> button.

Note

- The setting details are displayed in [RESOLUTION] and [VERTICAL SCAN FREQUENCY] of [EDID STATUS].
- The resolution and vertical scanning frequency settings may also be required on your computer or video device.
- After configuring settings, your computer or video device or the projector may be required to be turned off and on.
- A signal may not be output with the resolution and vertical scanning frequency that have been set, depending on your computer or video device.

[HDMI IN]

Set this item in accordance with the video signal input to the <HDMI IN> terminal.

Setting [SIGNAL LEVEL] in [HDMI IN]

- 1) Press ▲▼ to select [HDMI IN].
- 2) Press the <ENTER> button.
 - The [HDMI IN] screen is displayed.
- 3) Press ▲▼ to select [SIGNAL LEVEL].
- 4) Press ◀▶ to switch the item.
 - The items will switch each time you press the button.

[AUTO]	Automatically sets the signal level.
[64-940]	Select this item when the signal output from the HDMI terminal of an external device (such as a Blu-ray disc player) is input to the <HDMI IN> terminal.
[0-1023]	Select this item when the signal output from the DVI-D terminal of an external device (such as a computer) is input to the <HDMI IN> terminal via a conversion cable or similar cable. Select this item also when the signal output from the HDMI terminal of a computer or other device is input to the <HDMI IN> terminal.

Note

- The optimal setting varies depending on the output setting of the connected external device. Refer to the operating instructions of the external device regarding the output of the external device.
- The HDMI signal level is displayed for 30 bits of input.

Setting [EDID MODE] in [HDMI IN]

- 1) Press ▲▼ to select [HDMI IN].
- 2) Press the <ENTER> button.
 - The [HDMI IN] screen is displayed.
- 3) Press ▲▼ to select [EDID MODE].
- 4) Press the <ENTER> button.
 - The [HDMI EDID MODE] screen is displayed.
- 5) Press ◀▶ to switch [EDID MODE].
 - The items will switch each time you press the button.

[DEFAULT]	Standard setting.
[SCREEN FIT]	Changes EDID data according to the [SCREEN FORMAT] setting.
[USER]	Sets the [RESOLUTION] and [VERTICAL SCAN FREQUENCY] items to EDID.

- When [DEFAULT] or [SCREEN FIT] is selected, proceed to Step 10).
- 6) **Press the <ENTER> button.**
 - The [RESOLUTION] screen is displayed.
 - 7) **Press ▲▼◀▶ to select [RESOLUTION].**
 - Select [1024x768p], [1280x720p], [1280x768p], [1280x800p], [1280x1024p], [1366x768p], [1400x1050p], [1440x900p], [1600x900p], [1600x1200p], [1680x1050p], [1920x1080p], [1920x1080i], or [1920x1200p].
 - 8) **Press the <ENTER> button.**
 - The [VERTICAL SCAN FREQUENCY] screen is displayed.
 - 9) **Press ◀▶ to select [VERTICAL SCAN FREQUENCY].**
 - Select [60Hz], [50Hz], [30Hz], [25Hz], or [24Hz] when [1920x1080p] is selected for [RESOLUTION].
 - Select [60Hz], [50Hz], or [48Hz] when [1920x1080i] is selected for [RESOLUTION].
 - Select [60Hz] or [50Hz] when anything other than following is selected for [RESOLUTION].
 - [1920x1080p], [1920x1080i]
 - 10) **Press the <ENTER> button.**
 - The confirmation screen is displayed.
 - 11) **Press ◀▶ to select [OK], and press the <ENTER> button.**

Note

- The setting details are displayed in [RESOLUTION] and [VERTICAL SCAN FREQUENCY] of [EDID STATUS].
- The resolution and vertical scanning frequency settings may also be required on your computer or video device.
- After configuring settings, your computer or video device or the projector may be required to be turned off and on.
- A signal may not be output with the resolution and vertical scanning frequency that have been set, depending on your computer or video device.

[DIGITAL LINK IN]

Set this item in accordance with the video signal input to the <DIGITAL LINK/LAN> terminal.

Setting [SIGNAL LEVEL] in [DIGITAL LINK IN]

- 1) **Press ▲▼ to select [DIGITAL LINK IN].**
- 2) **Press the <ENTER> button.**
 - The [DIGITAL LINK IN] screen is displayed.
- 3) **Press ▲▼ to select [SIGNAL LEVEL].**
- 4) **Press ◀▶ to switch the item.**
 - The items will switch each time you press the button.

[AUTO]	Automatically sets the signal level.
[64-940]	Select this item when the signal output from the HDMI terminal of an external device (Blu-ray disc player, etc.) is input to the <DIGITAL LINK/LAN> terminal via a twisted-pair-cable transmitter.
[0-1023]	Select this item when the signal output from the DVI-D terminal or HDMI terminal of an external device (such as a computer) is input to the <DIGITAL LINK/LAN> terminal via a twisted-pair-cable transmitter.

Note

- The optimal setting varies depending on the output setting of the connected external device. Refer to the operating instructions of the external device regarding the output of the external device.
- The signal level is displayed for 30 bits of input.

Setting [EDID MODE] in [DIGITAL LINK IN]

- 1) **Press ▲▼ to select [DIGITAL LINK IN].**
- 2) **Press the <ENTER> button.**
 - The [DIGITAL LINK IN] screen is displayed.

- 3) Press ▲▼ to select [EDID MODE].
- 4) Press the <ENTER> button.
 - The [DIGITAL LINK EDID MODE] screen is displayed.
- 5) Press ◀▶ to switch [EDID MODE].
 - The items will switch each time you press the button.

[DEFAULT]	Standard setting.
[SCREEN FIT]	Changes EDID data according to the [SCREEN FORMAT] setting.
[USER]	Sets the [RESOLUTION] and [VERTICAL SCAN FREQUENCY] items to EDID.

- When [DEFAULT] or [SCREEN FIT] is selected, proceed to Step 10).
- 6) Press the <ENTER> button.
 - The [RESOLUTION] screen is displayed.
 - 7) Press ▲▼◀▶ to select [RESOLUTION].
 - Select [1024x768p], [1280x720p], [1280x768p], [1280x800p], [1280x1024p], [1366x768p], [1400x1050p], [1440x900p], [1600x900p], [1600x1200p], [1680x1050p], [1920x1080p], [1920x1080i], or [1920x1200p].
 - 8) Press the <ENTER> button.
 - The [VERTICAL SCAN FREQUENCY] screen is displayed.
 - 9) Press ◀▶ to select [VERTICAL SCAN FREQUENCY].
 - Select [60Hz], [50Hz], [30Hz], [25Hz], or [24Hz] when [1920x1080p] is selected for [RESOLUTION].
 - Select [60Hz], [50Hz], or [48Hz] when [1920x1080i] is selected for [RESOLUTION].
 - Select [60Hz] or [50Hz] when anything other than following is selected for [RESOLUTION].
 - [1920x1080p], [1920x1080i]
 - 10) Press the <ENTER> button.
 - The confirmation screen is displayed.
 - 11) Press ◀▶ to select [OK], and press the <ENTER> button.

Note

- The setting details are displayed in [RESOLUTION] and [VERTICAL SCAN FREQUENCY] of [EDID STATUS].
- The resolution and vertical scanning frequency settings may also be required on your computer or video device.
- After configuring settings, your computer or video device or the projector may be required to be turned off and on.
- A signal may not be output with the resolution and vertical scanning frequency that have been set, depending on your computer or video device.

[SDI IN]

Set this function in accordance with the signal input to the <SDI IN 1>/<SDI IN 2> terminals.

Setting [SDI LINK] in [SDI IN]

- 1) Press ▲▼ to select [SDI IN].
- 2) Press the <ENTER> button.
 - The [SDI IN] screen is displayed.
- 3) Press ▲▼ to select [SDI LINK].
- 4) Press the <ENTER> button.
 - The [SDI LINK] screen is displayed.
- 5) Press ▲▼ to select the setting.

[SINGLE]	Sets the SDI1 input and the SDI2 input to single link.
[DUAL]	Sets the SDI1 input and the SDI2 input to dual link.
[AUTO]	Automatically selects the single link or the dual link. The single link or dual link is automatically distinguished by reading the payload ID attached to each input signal. Single link will be selected when a payload ID is not added to the input signal.

6) Press the <ENTER> button.

Note

- The single link is a setting to display one image with one input signal. The dual link is a setting to display one image with two input signals.
- When the [SIMUL INPUT SETTING] is set to anything other than [OFF], [SDI LINK] is fixed to [SINGLE].
- The [SDI LINK] setting cannot be changed when the [DISPLAY OPTION] menu → [BACKUP INPUT SETTING] → [BACKUP INPUT MODE] is set as the combination to include the SDI1 input or SDI2 input.
- The content set is displayed in [SDI LINK SETTINGS].
- [P IN P] cannot be set when [AUTO] is set.

Setting [RESOLUTION] in [SDI IN]

- 1) Press ▲▼ to select [SDI IN].
- 2) Press the <ENTER> button.
 - The [SDI IN] screen is displayed.
- 3) Press ▲▼ to select [SINGLE LINK SETTING] or [DUAL LINK SETTING], and press the <ENTER> button.
 - The [SINGLE LINK SETTING] or [DUAL LINK SETTING] screen is displayed.
 - When [DUAL LINK SETTING] is selected, proceed to Step 5).
- 4) Press ▲▼ to select [SDI1] or [SDI2], and press the <ENTER> button.
 - The [SINGLE LINK SETTING] or [DUAL LINK SETTING] screen of the selected item is displayed.
- 5) Press ▲▼ to select [RESOLUTION], and press the <ENTER> button.
 - The [RESOLUTION] screen is displayed.
- 6) Press ▲▼ to select the item, and press the <ENTER> button.
 - Select [AUTO], [720x480i], [720x576i], [1280x720p], [1920x1080i], [1920x1080p], [1920x1080sF], or [2048x1080p] when [SINGLE LINK SETTING] is selected.
 - Select [AUTO], [1920x1080i], [1920x1080p], [1920x1080sF], or [2048x1080p] when [DUAL LINK SETTING] is selected.

Setting [3G-SDI MAPPING] in [SDI IN]

- 1) Press ▲▼ to select [SDI IN].
- 2) Press the <ENTER> button.
 - The [SDI IN] screen is displayed.
- 3) Press ▲▼ to select [SINGLE LINK SETTING] or [DUAL LINK SETTING], and press the <ENTER> button.
 - The [SINGLE LINK SETTING] or [DUAL LINK SETTING] screen is displayed.
 - When [DUAL LINK SETTING] is selected, proceed to Step 5).
- 4) Press ▲▼ to select [SDI1] or [SDI2], and press the <ENTER> button.
 - The [SINGLE LINK SETTING] or [DUAL LINK SETTING] screen of the selected item is displayed.
- 5) Press ▲▼ to select [3G-SDI MAPPING].
- 6) Press ◀▶ to switch the item.
 - The items will switch each time you press the button.

[AUTO]	Automatically select [LEVEL A] or [LEVEL B].
[LEVEL A]	Fixes the mapping method to 3G-SDI Level-A.
[LEVEL B]	Fixes the mapping method to 3G-SDI Level-B.

Note

- This does not operate when the SD-SDI signal or the HD-SDI signal is input.

Setting [SYSTEM SELECTOR] in [SDI IN]

- 1) Press ▲▼ to select [SDI IN].
- 2) Press the <ENTER> button.
 - The [SDI IN] screen is displayed.
- 3) Press ▲▼ to select [SINGLE LINK SETTING] or [DUAL LINK SETTING], and press the <ENTER> button.
 - The [SINGLE LINK SETTING] or [DUAL LINK SETTING] screen is displayed.
 - When [DUAL LINK SETTING] is selected, proceed to Step 5).
- 4) Press ▲▼ to select [SDI1] or [SDI2], and press the <ENTER> button.
 - The [SINGLE LINK SETTING] or [DUAL LINK SETTING] screen of the selected item is displayed.
- 5) Press ▲▼ to select [SYSTEM SELECTOR].
- 6) Press ◀▶ to switch the item.
 - The items will switch each time you press the button.

[AUTO]	Automatically selects [RGB], [YP _B P _R 4:4:4], [YP _B P _R 4:2:2], or [XYZ]. [RGB], [YP _B P _R 4:4:4], [YP _B P _R 4:2:2], or [XYZ] is automatically selected by reading the payload ID attached to the input signal. [RGB] is selected when the payload ID is not attached to the input signal.
[RGB]	Fixes to [RGB].
[YP _B P _R 4:4:4]	Fixes to [YP _B P _R 4:4:4].
[YP _B P _R 4:2:2]	Fixes to [YP _B P _R 4:2:2].
[XYZ]	Fixes to [XYZ].

Setting [BIT DEPTH] in [SDI IN]

- 1) Press ▲▼ to select [SDI IN].
- 2) Press the <ENTER> button.
 - The [SDI IN] screen is displayed.
- 3) Press ▲▼ to select [SINGLE LINK SETTING] or [DUAL LINK SETTING], and press the <ENTER> button.
 - The [SINGLE LINK SETTING] or [DUAL LINK SETTING] screen is displayed.
 - When [DUAL LINK SETTING] is selected, proceed to Step 5).
- 4) Press ▲▼ to select [SDI1] or [SDI2], and press the <ENTER> button.
 - The [SINGLE LINK SETTING] or [DUAL LINK SETTING] screen of the selected item is displayed.
- 5) Press ▲▼ to select [BIT DEPTH].
- 6) Press ◀▶ to switch the item.
 - The items will switch each time you press the button.

[AUTO]	Automatically select [12-bit] or [10-bit].
[12-bit]	Fixes to [12-bit].
[10-bit]	Fixes to [10-bit].

Setting [SIGNAL LEVEL] in [SDI IN]

- 1) Press ▲▼ to select [SDI IN].
- 2) Press the <ENTER> button.
 - The [SDI IN] screen is displayed.
- 3) Press ▲▼ to select [SINGLE LINK SETTING] or [DUAL LINK SETTING], and press the <ENTER> button.
 - The [SINGLE LINK SETTING] or [DUAL LINK SETTING] screen is displayed.
 - When [DUAL LINK SETTING] is selected, proceed to Step 5).

- 4) Press ▲▼ to select [SDI1] or [SDI2], and press the <ENTER> button.
 - The [SINGLE LINK SETTING] or [DUAL LINK SETTING] screen of the selected item is displayed.
- 5) Press ▲▼ to select [SIGNAL LEVEL].
- 6) Press ◀▶ to switch the item.
 - The items will switch each time you press the button.

[64-940]	Normally use this setting.
[4-1019]	Select this item when gray is displayed as black.

[ON-SCREEN DISPLAY]

Set the on-screen display.

Setting [OSD POSITION]

Set the position of the menu screen (OSD).

- 1) Press ▲▼ to select [ON-SCREEN DISPLAY].
- 2) Press the <ENTER> button.
 - The [ON-SCREEN DISPLAY] screen is displayed.
- 3) Press ▲▼ to select [OSD POSITION].
- 4) Press ◀▶ to switch the item.
 - The items will switch each time you press the button.

[2]	Sets to the center left of the screen.
[3]	Sets to the bottom left of the screen.
[4]	Sets to the top center of the screen.
[5]	Sets to the center of the screen.
[6]	Sets to the bottom center of the screen.
[7]	Sets to the upper right of the screen.
[8]	Sets to the center right of the screen.
[9]	Sets to the bottom right of the screen.
[1]	Sets to the upper left of the screen.

Setting [OSD ROTATION]

Set the orientation of the menu screen (OSD).

- 1) Press ▲▼ to select [ON-SCREEN DISPLAY].
- 2) Press the <ENTER> button.
 - The [ON-SCREEN DISPLAY] screen is displayed.
- 3) Press ▲▼ to select [OSD ROTATION].
- 4) Press ◀▶ to switch the item.
 - The items will switch each time you press the button.

[OFF]	Does not rotate the screen.
[CLOCKWISE]	Rotates the screen by 90° clockwise.
[COUNTERCLOCKWISE]	Rotates the screen by 90° counterclockwise.

Setting [OSD DESIGN]

Set the color of the menu screen (OSD).

- 1) Press ▲▼ to select [ON-SCREEN DISPLAY].
- 2) Press the <ENTER> button.
 - The [ON-SCREEN DISPLAY] screen is displayed.

- 3) Press ▲▼ to select [OSD DESIGN].
- 4) Press ◀▶ to switch the item.
 - The items will switch each time you press the button.

[1]	Sets to yellow.
[2]	Sets to blue.
[3]	Sets to white.
[4]	Sets to green.
[5]	Sets to peach.
[6]	Sets to brown.

Setting [OSD MEMORY]

Set hold for the position of the menu screen (OSD) cursor.

- 1) Press ▲▼ to select [ON-SCREEN DISPLAY].
- 2) Press the <ENTER> button.
 - The [ON-SCREEN DISPLAY] screen is displayed.
- 3) Press ▲▼ to select [OSD MEMORY].
- 4) Press ◀▶ to switch the item.
 - The items will switch each time you press the button.

[ON]	Holds the cursor position.
[OFF]	Does not hold the cursor position.

Note

- The cursor position is not maintained even if [OSD MEMORY] is set to [ON].

Setting [INPUT GUIDE]

Set whether to display the input guide in the position set in [OSD POSITION].

The input guide is the screen to display the information such as currently selected input terminal name, signal name, memory number, the input terminal and signal structuring [P IN P], and [BACKUP INPUT STATUS].

- 1) Press ▲▼ to select [ON-SCREEN DISPLAY].
- 2) Press the <ENTER> button.
 - The [ON-SCREEN DISPLAY] screen is displayed.
- 3) Press ▲▼ to select [INPUT GUIDE].
- 4) Press ◀▶ to switch the item.
 - The items will switch each time you press the button.

[ON]	Displays the input guide.
[OFF]	Hides the input guide.

Setting [WARNING MESSAGE]

Set the display/hide of the warning message.

- 1) Press ▲▼ to select [ON-SCREEN DISPLAY].
- 2) Press the <ENTER> button.
 - The [ON-SCREEN DISPLAY] screen is displayed.
- 3) Press ▲▼ to select [WARNING MESSAGE].
- 4) Press ◀▶ to switch the item.
 - The items will switch each time you press the button.

[ON]	Displays the warning message.
[OFF]	Hides the warning message.

Note

- If [OFF] is set, the warning message will not be displayed on the projected image even when warning condition such as [TEMPERATURE WARNING] is detected while using the projector. Also, the following countdown message is not displayed: the message until the power is turned off after the no signal lights-out function is executed; the message until the light source is turned off after the no signal lights-out function is executed

[MENU MODE]

Set the display mode of the menu screen (OSD).

- 1) Press ▲▼ to select [MENU MODE].
- 2) Press ◀▶ to switch the item.
 - The items will switch each time you press the button.

[NORMAL]	Displays all menu items.
[SIMPLE]	Displays some of the menu items that are used for basic setting or adjustment.

Note

- For the menu items that are displayed when [SIMPLE] is set, refer to “Main menu” (➡ page 86), “Sub-menu” (➡ page 87).

[IMAGE ROTATION]

Set whether to rotate the input image when projecting.

- 1) Press ▲▼ to select [IMAGE ROTATION].
- 2) Press ◀▶ to select an item.
 - The items will switch each time you press the button.

[OFF]	Projects the input image without rotating.
[CLOCKWISE]	Rotates the input image by 90° clockwise and project it.
[COUNTERCLOCKWISE]	Rotates the input image by 90° counterclockwise and project it.

Note

- [IMAGE ROTATION] is disabled while displaying 3D image, displaying image in simultaneous format, and during P IN P.
- The on-screen display orientation does not change even when this item is set to anything other than [OFF]. Set the [DISPLAY OPTION] menu → [ON-SCREEN DISPLAY] → [OSD ROTATION] (➡ page 130) as required.

[BACK COLOR]

Set the display of the projected screen when there is no signal input.

- 1) Press ▲▼ to select [BACK COLOR].
- 2) Press ◀▶ to switch the item.
 - The items will switch each time you press the button.

[BLUE]	Displays the entire projection area in blue.
[BLACK]	Displays the entire projection area in black.
[DEFAULT LOGO]	Displays the Panasonic logo.
[USER LOGO]	Displays the image registered by the user.

Note

- To create and register the [USER LOGO] image, use “Logo Transfer Software”. The software can be downloaded from the Panasonic website (<https://panasonic.net/cns/projector/>).

[STARTUP LOGO]

Set the logo display when the power is turned on.

- 1) Press ▲▼ to select [STARTUP LOGO].

2) Press ◀▶ to switch the item.

- The items will switch each time you press the button.

[DEFAULT LOGO]	Displays the Panasonic logo.
[USER LOGO]	Displays the image registered by the user.
[NONE]	Disables the startup logo display.

Note

- When [USER LOGO] is selected, the display of the startup logo will be kept for approximately 15 seconds.
- To create and register the [USER LOGO] image, use "Logo Transfer Software". The software can be downloaded from the Panasonic website (<https://panasonic.net/cns/projector/>).

[UNIFORMITY]

Correct the brightness and color unevenness of the entire screen.

Setting each color

- 1) Press ▲▼ to select [UNIFORMITY].
- 2) Press the <ENTER> button.
 - The [UNIFORMITY] screen is displayed.
- 3) Press ▲▼ to select [WHITE], [RED], [GREEN], or [BLUE].
- 4) Press ◀▶ to adjust the level.

Item	Operation	Adjustment	Range of adjustment
[VERTICAL]	Press ▶.	The lower-side color becomes pale, or the upper-side color becomes dark.	-127 - +127
	Press ◀.	The upper-side color becomes pale, or the lower-side color becomes dark.	
[HORIZONTAL]	Press ▶.	The left-side color becomes pale, or the right-side color becomes dark.	
	Press ◀.	The right-side color becomes pale, or the left-side color becomes dark.	

Setting [PC CORRECTION]

Set the [PC CORRECTION] function to correct the brightness and the color unevenness of the entire screen using a computer.

To use the [PC CORRECTION] function, the optional Upgrade Kit (Model No.: ET-UK20) is required. To purchase the product, consult your dealer.

- 1) Press ▲▼ to select [UNIFORMITY].
- 2) Press the <ENTER> button.
 - The [UNIFORMITY] screen is displayed.
- 3) Press ▲▼ to select [PC CORRECTION].
- 4) Press ◀▶ to switch the item.

[OFF]	Does not perform correction using a computer.
[ON(PRE)]*1	Performs correction for the brightness and color unevenness of the entire screen using a computer. When the geometric adjustment is performed, the shape of the projected image and the compensation area of uniformity are linked. Select this item when projecting at an angle against the flat screen, or when projecting on a curved screen.

[ON(PST)]*1	Performs correction for the brightness and color unevenness of the entire screen using a computer. The shape of the projected image and the compensation area of uniformity are not linked. Select this item to compensate the unevenness of the brightness of the light irradiated from the projection lens.
--------------------	---

*1 Advanced skills are necessary to use computer control correction. Consult your dealer.

Note

- When [ON(PRE)] is selected, set the projection method and perform geometric adjustment, and then correct the uniformity.

[SHUTTER SETTING]

The operation of the shutter function is set.

Setting [MECHANICAL SHUTTER]

- 1) Press ▲▼ to select [SHUTTER SETTING].
- 2) Press the <ENTER> button.
 - The [SHUTTER SETTING] screen is displayed.
- 3) Press ▲▼ to select [MECHANICAL SHUTTER].
- 4) Press ◀▶ to switch the item.

[ENABLE]	Closes the mechanical shutter when the shutter function is enabled (shutter: closed).
[DISABLE]	Leaves the mechanical shutter open and turns off the light source when the shutter function is enabled (shutter: closed).

Note

- By closing the mechanical shutter, the malfunction of the DLP chip caused by high power laser ray entering the projection lens surface can be prevented. To close the mechanical shutter, set [MECHANICAL SHUTTER] to [ENABLE] and then set the shutter function to be enabled (shutter: closed).
- When [MECHANICAL SHUTTER] is set to [ENABLE], it will take approximately 0.5 seconds from when the shutter function is enabled (shutter: closed) to the shutter function is disabled (shutter: opened).
- The light source may turn on darker to warm up when the shutter function is used when the operating environment temperature is around 0 °C (32 °F) when [MECHANICAL SHUTTER] is set to [DISABLE].

Setting [FADE-IN] or [FADE-OUT]

Set the image fade-in and fade-out when the shutter function operates.

- 1) Press ▲▼ to select [SHUTTER SETTING].
- 2) Press the <ENTER> button.
 - The [SHUTTER SETTING] screen is displayed.
- 3) Press ▲▼ to select [FADE-IN] or [FADE-OUT].
- 4) Press ◀▶ to switch the item.

Item		Adjustment
[FADE-IN] [FADE-OUT]	[OFF]	Does not set fade-in or fade-out.
	[0.5s] - [10.0s]	Sets the fade-in or fade-out time. Select an item from [0.5s] - [4.0s], [5.0s], [7.0s], or [10.0s]. [0.5s] - [4.0s] can be selected in increments of 0.5.

Note

- Press the <SHUTTER> button on the remote control or the control panel during fade-in or fade-out to cancel the fade operation.

Setting [STARTUP]

Automatically enable/disable the shutter function (shutter: closed/open) when the power is turned on.

- 1) Press ▲▼ to select [SHUTTER SETTING].

- 2) Press the <ENTER> button.
 - The [SHUTTER SETTING] screen is displayed.
- 3) Press ▲▼ to select [STARTUP].
- 4) Press ◀▶ to switch the item.

[OPEN]	The projector goes into projection mode with the shutter function disabled (shutter: opened) when the power is turned on.
[CLOSE]	The projector goes into projection mode with the shutter function enabled (shutter: closed) when the power is turned on.

Setting [SHUT-OFF]

Automatically open/close the mechanical shutter when the power is turned off.

- 1) Press ▲▼ to select [SHUTTER SETTING].
- 2) Press the <ENTER> button.
 - The [SHUTTER SETTING] screen is displayed.
- 3) Press ▲▼ to select [SHUT-OFF].
- 4) Press ◀▶ to switch the item.

[LAST USED]	The projector goes into standby mode with the condition of the mechanical shutter maintained when the projector is switched off.
[OPEN]	The projector goes into standby mode with the mechanical shutter opened when the projector is switched off.
[CLOSE]	The projector goes into standby mode with the mechanical shutter closed when the projector is switched off.

Setting the shutter synchronization function

The shutter synchronization function is a function to synchronize the shutter operation of the specified projector to other projectors, and the effect using the shutter function including the fade in/fade out operation can be synchronized.

To use the shutter synchronization function, it is necessary to connect the projectors targeted for synchronization in a loop with daisy chain connection using the <MULTI PROJECTOR SYNC IN> terminal and the <MULTI PROJECTOR SYNC OUT> terminal. For details of how to connect the projectors, refer to “Connecting example when using the contrast synchronization function/shutter synchronization function” (➡ page 56).

- 1) Press ▲▼ to select [SHUTTER SETTING].
- 2) Press the <ENTER> button.
 - The [SHUTTER SETTING] screen is displayed.
- 3) Press ▲▼ to select [MULTI PROJECTOR SYNC].
- 4) Press the <ENTER> button.
 - The [MULTI PROJECTOR SYNC] screen is displayed.
- 5) Press ▲▼ to select [MODE].
- 6) Press ◀▶ to switch the item.
 - The items will switch each time you press the button.

[OFF]	Select this item when the contrast synchronization function and the shutter synchronization function are not used.
[MASTER]	Select this item when the contrast synchronization function or the shutter synchronization function is used. Set this item only on one of the linked projectors that becomes the synchronization source of the shutter operation.
[SLAVE]	Select this item when the contrast synchronization function or the shutter synchronization function is used. Set this item in all the linked projectors excluding the projector set as the [MASTER].

- When anything other than [OFF] is selected, the diagnostic result is displayed in [LINK STATUS], indicating if all the projectors including the projectors targeted for synchronization are correctly connected, and if [MODE] is correctly set.

[LINKED]	All the projectors are correctly connected, and correctly set. They are in the condition that the contrast synchronization function or the shutter synchronization function can be used.
[NO LINK]	The projectors are not correctly connected, or not correctly set. Check the cable connection status and the projector setting for each projector that is linked.

7) Press ▲▼ to select [SHUTTER SYNC].

8) Press ◀▶ to switch the item.

- The items will switch each time you press the button.

[OFF]	Select this item when the shutter synchronization function is not used.
[ON]	Select this item when the shutter synchronization function is used.

Note

- The [MULTI PROJECTOR SYNC] setting item is common with the following menu item.
 - The [PROJECTOR SETUP] menu → [MULTI PROJECTOR SYNC]
 For details on contrast synchronization function, refer to the [PROJECTOR SETUP] menu → [MULTI PROJECTOR SYNC] (▶ page 163).
- The shutter synchronization function will operate when all of the following conditions are fulfilled.
 - All the projectors to be linked are connected in a loop with the daisy chain connection. (Maximum 64 projectors)
 - [MODE] on only one projector that is linked is set to [MASTER], and [MODE] on all other projectors are set to [SLAVE].
 - [SHUTTER SYNC] on the projectors to perform the shutter synchronization is set to [ON].
- It is possible to set [SHUTTER SYNC] to [OFF] for the projectors that are linked but not to synchronize.
- The shutter operation by the shutter synchronization function will follow the setting of the [DISPLAY OPTION] menu → [SHUTTER SETTING] on the projector that [MODE] is set to [MASTER].
- The operation of the mechanical shutter is not included in the shutter synchronization function.
- When the input signal to each linked projector is not synchronized, the timing of the shutter operation between the projectors may shift up to 1 frame while using the shutter synchronization function.
- The shutter function of the projector with [MODE] set to [SLAVE] can be operated individually. The shutter operation at this time will follow the setting of the [DISPLAY OPTION] menu → [SHUTTER SETTING] set in that projector.
- The [3D SYNC SETTING] setting is disabled and fixed to [OFF] when [MULTI PROJECTOR SYNC] → [MODE] is set to anything other than [OFF].
- The following settings are disabled and the contrast synchronization function and shutter synchronization function cannot be used when [3D SYNC SETTING] is set to anything other than [OFF].
 - The [PICTURE] menu → [DYNAMIC CONTRAST] → [USER] → [MULTI PROJECTOR SYNC]
 - The [DISPLAY OPTION] menu → [SHUTTER SETTING] → [MULTI PROJECTOR SYNC]
 - The [PROJECTOR SETUP] menu → [MULTI PROJECTOR SYNC]

[FREEZE]

Pause the projected image temporarily regardless of the playback of the external device.

1) Press ▲▼ to select [FREEZE].

2) Press the <ENTER> button.

- Press the <MENU> button to release.

Note

- [FREEZE] is displayed on the screen when video is paused.

[WAVEFORM MONITOR]

Use the input signals from a connected external device to display in a waveform. Check whether video output (luminance) signal level is within the recommended range for the projector and adjust.

1) Press ▲▼ to select [WAVEFORM MONITOR].

2) Press ◀▶ to switch the item.

[OFF]	Does not display the waveform monitor.
[ON]	Displays the waveform monitor.

3) Press the <MENU> button two times to clear.

4) Press ▲▼ to select any horizontal line.

5) Press the <ENTER> button to switch the Select line to either luminance, red, green, or blue.

- Line selection items switch each time the <ENTER> button is pressed only when the waveform monitor is displayed.

“Select line (luminance)”	Displayed in white waveform.
“Select line (red)”	Displayed in red waveform.
“Select line (green)”	Displayed in green waveform.
“Select line (blue)”	Displayed in blue waveform.

Note

- Setting is also available from the [PROJECTOR SETUP] menu → [FUNCTION BUTTON].
- Waveform monitor cannot be displayed while in [P IN P].
- The waveform monitor turns off when the P IN P function is used while the waveform is being monitored.
- The waveform monitor is not displayed when on-screen display is hidden (off).
- Use [3D WAVEFORM MONITOR] to display the waveform monitor with the 3D image.

Adjusting the waveform

Project the luminance adjustment signal of a commercial test disk (0 % (0 IRE or 7.5 IRE) – 100 % (100 IRE)) and adjust.

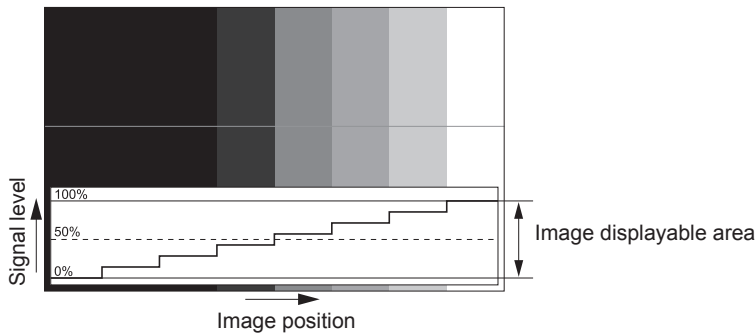

1) Select “Select line (luminance)” on the waveform monitor.

2) Adjust black level.

- Adjust the black level 0 % of the video signal to the 0 % position of the waveform monitor using the [PICTURE] menu → [BRIGHTNESS].

3) Adjust white level.

- Adjust the white level 100 % of the video signal to the 100 % position of the waveform monitor using the [PICTURE] menu → [CONTRAST].

Adjusting red, green, and blue

1) Set [COLOR TEMPERATURE] to [USER1] or [USER2] (⇒ page 92).

2) Select “Select line (red)” on the waveform monitor.

3) Adjust dark red areas.

- Use [RED] in [WHITE BALANCE LOW] to adjust the black level 0 % of the video signal to the 0 % position of the waveform monitor.

4) Adjust bright red areas.

- Use [RED] in [WHITE BALANCE HIGH] to adjust the white level 100 % of the video signal to the 100 % position of the waveform monitor.

5) Use the procedure for [RED] to adjust [GREEN] and [BLUE].

Note

- Confirm that the [SIGNAL LEVEL] setting of the input signal is correct before adjusting the black level. Check the [SIGNAL LEVEL] setting in the [DISPLAY OPTION] menu → [DVI-D IN]/[HDMI IN]/[DIGITAL LINK IN]/[SDI IN] → [SIGNAL LEVEL].

[CUT OFF]

Each red, green, and blue color component can be removed.

- 1) Press ▲▼ to select [CUT OFF].
- 2) Press the <ENTER> button.
 - The [CUT OFF] screen is displayed.
- 3) Press ▲▼ to select [RED], [GREEN], or [BLUE].
- 4) Press ◀▶ to switch the item.

[OFF]	Disables cutoff.
[ON]	Enables cutoff.

Note

- When input is switched or a signal is switched, the cutoff setting returns to its original setting (off).

[PROJECTOR SETUP] menu

On the menu screen, select [PROJECTOR SETUP] from the main menu, and select an item from the sub-menu.

Refer to “Navigating through the menu” (➔ page 85) for the operation of the menu screen.

[PROJECTOR ID]

The projector has an ID number setting function that can be used when multiple projectors are used side by side to enable simultaneous control or individual control via a single remote control.

- 1) Press ▲▼ to select [PROJECTOR ID].
- 2) Press ◀▶ to switch the item.
 - The items will switch each time you press the button.

[ALL]	Select this item when controlling projectors without specifying an ID number.
[1] - [64]	Select this item when specifying an ID number to control individual projector.

Note

- To specify an ID number for individual control, the ID number of a remote control must match the ID number of the projector.
- When the ID number is set to [ALL], the projector will operate regardless of the ID number specified during remote control or computer control.
If multiple projectors are set up side by side with IDs set to [ALL], they cannot be controlled separately from the projectors with other ID numbers.
- Refer to “Setting ID number of the remote control” (➔ page 83) for how to set the ID number on the remote control.

[PROJECTION METHOD]

Set the projection method in accordance with the installation status of the projector.

Change the [FRONT/REAR] setting when the screen display is inverted.

Change the [FLOOR/CEILING] setting when the screen display is upside down.

Setting [FRONT/REAR]

- 1) Press ▲▼ to select [PROJECTION METHOD].
- 2) Press the <ENTER> button.
 - The [PROJECTION METHOD] screen is displayed.
- 3) Press ▲▼ to select [FRONT/REAR].
- 4) Press ◀▶ to switch the item.
 - The items will switch each time you press the button.

[FRONT]	Select this item when installing the projector in front of the screen.
[REAR]	Select this item when installing behind the screen (using translucent screen).

Setting [FLOOR/CEILING]

- 1) Press ▲▼ to select [PROJECTION METHOD].
- 2) Press the <ENTER> button.
 - The [PROJECTION METHOD] screen is displayed.
- 3) Press ▲▼ to select [FLOOR/CEILING].
- 4) Press ◀▶ to switch the item.
 - The items will switch each time you press the button.

[AUTO]	Automatically detects the attitude of the projector by the built-in angle sensor. Set [AUTO] normally.
[FLOOR]	Select this item when installing the projector on a desk, etc.

[CEILING]	Select this item when installing the projector with the top surface of the projector facing down such as ceiling attachment. Projected image is inverted upside down.
------------------	--

Note

- Refer to “Angle sensor” (➔ page 37) for details on the range of the installation attitude that can be detected by the built-in angle sensor.

[LENS]

Perform the setting and operation regarding the projection lens.

[LENS TYPE]

When the projector is used for the first time or when the projection lens is replaced, confirm the [LENS TYPE] setting. Change the setting if the type is different from the projection lens attached to the projector.

If the [LENS TYPE] information is written into the EEPROM (Electrically Erasable Programmable Read-Only Memory) built in the projection lens, that information is automatically acquired as the setting value of the projector when the projector is turned on.

- 1) Press ▲▼ to select [LENS].
- 2) Press the <ENTER> button.
 - The [LENS] screen is displayed, allowing to confirm the current setting in [LENS TYPE].
 - To change the setting, proceed to Step 3).
- 3) Press ▲▼ to select [LENS TYPE].
- 4) Press the <ENTER> button.
 - The [LENS TYPE] screen is displayed.
- 5) Press ▲▼ to select an item.
 - Select the type of projection lens attached to the projector.

ET-D75LE95	Select this item when the Fixed-focus Lens (Model No.: ET-D75LE95) is attached to the projector.
ET-D75LE90	Select this item when the Fixed-focus Lens (Model No.: ET-D75LE90) is attached to the projector.
ET-D75LE50	Select this item when the Fixed-focus Lens (Model No.: ET-D75LE50) is attached to the projector.
ET-D75LE6	Select this item when the Zoom Lens (Model No.: ET-D75LE6) is attached to the projector.
ET-D75LE10	Select this item when the Zoom Lens (Model No.: ET-D75LE10) is attached to the projector.
ET-D75LE20	Select this item when the Zoom Lens (Model No.: ET-D75LE20) is attached to the projector. (Factory default setting)
ET-D75LE30	Select this item when the Zoom Lens (Model No.: ET-D75LE30) is attached to the projector.
ET-D75LE40	Select this item when the Zoom Lens (Model No.: ET-D75LE40) is attached to the projector.
ET-D75LE8	Select this item when the Zoom Lens (Model No.: ET-D75LE8) is attached to the projector.

- 6) Press the <ENTER> button.

Note

- If a projection lens equipped with EEPROM is attached, the [LENS TYPE] setting is written into the EEPROM of the projection lens. If a projection lens without built-in EEPROM is attached, the [LENS TYPE] setting is saved in the projector as user data.
- If the standard DC motor unit installed in the Zoom Lens (Model No.: ET-D75LE6, ET-D75LE8, ET-D75LE10, ET-D75LE20, ET-D75LE30, ET-D75LE40, etc.) is replaced with the stepping motor unit using the Stepping Motor Kit (Model No.: ET-D75MKS10), [LENS TYPE] is set to [NOT SELECTED] when it is used for the first time. By selecting the type of the projection lens and pressing the <ENTER> button, selected [LENS TYPE] information is written to the EEPROM installed in the stepping motor unit.
- [LENS HOME POSITION], [ACTIVE FOCUS OPTIMIZER], and [LENS CALIBRATION] cannot be executed when [LENS TYPE] is set to [NOT SELECTED].
- [LENS HOME POSITION], [ACTIVE FOCUS OPTIMIZER], and [LENS CALIBRATION] will not operate correctly when [LENS TYPE] is set incorrectly.
- When a projection lens equipped with EEPROM is attached, [LENS TYPE] will not return to factory default setting even if the [PROJECTOR SETUP] menu → [INITIALIZE] → [ALL USER DATA] is executed.

[LENS INFORMATION SETTING]**Confirming the projection lens information**

- 1) Press ▲▼ to select [LENS].
- 2) Press the <ENTER> button.
 - The [LENS] screen is displayed.
- 3) Press ▲▼ to select [LENS INFORMATION SETTING].
- 4) Press the <ENTER> button.
 - The [LENS INFORMATION SETTING] screen is displayed.

[LENS ID]	Displays the set ID.
[LENS NAME]	Displays the set name.
[LENS TYPE]	Displays the set projection lens type.
[LENS ZOOM TYPE]	Displays the drive method of the zoom motor.

Note

- [LENS INFORMATION SETTING] is not displayed when a projection lens without built-in EEPROM is attached.

Setting ID to the projection lens

Write the identification information unique to the projection lens into the EEPROM built in the projection lens. Set ID if required.

- 1) Press ▲▼ to select [LENS].
- 2) Press the <ENTER> button.
 - The [LENS] screen is displayed.
- 3) Press ▲▼ to select [LENS INFORMATION SETTING].
- 4) Press the <ENTER> button.
 - The [LENS INFORMATION SETTING] screen is displayed.
- 5) Press ▲▼ to select [LENS ID].
- 6) Press ◀▶ to switch the item.
 - The items will switch each time you press the button.

[ALL]	Select this item when the ID number is not to be specified.
[1] - [255]	Select this item when the ID number is to be set.

Note

- [LENS INFORMATION SETTING] is not displayed when a projection lens without built-in EEPROM is attached.
- If the standard DC motor unit installed in the Zoom Lens (Model No.: ET-D75LE6, ET-D75LE8, ET-D75LE10, ET-D75LE20, ET-D75LE30, ET-D75LE40, etc.) is replaced with the stepping motor unit using the Stepping Motor Kit (Model No.: ET-D75MKS10), the [LENS ID] information is written into the EEPROM built in the stepping motor unit every time the [LENS ID] item is switched.
- [LENS ID] will not return to factory default setting even when the [PROJECTOR SETUP] menu → [INITIALIZE] → [ALL USER DATA] is executed.

Setting name to the projection lens

A name for identifying individual projection lens can be written into the EEPROM built in the projection lens. Set the name if required.

- 1) Press ▲▼ to select [LENS].
- 2) Press the <ENTER> button.
 - The [LENS] screen is displayed.
- 3) Press ▲▼ to select [LENS INFORMATION SETTING].

- 4) Press the <ENTER> button.
 - The [LENS INFORMATION SETTING] screen is displayed.
- 5) Press ▲▼ to select [LENS NAME].
- 6) Press the <ENTER> button.
 - The [LENS NAME INPUT] screen is displayed.
- 7) Press ▲▼◀▶ to select the character, and press the <ENTER> button to enter the character.
- 8) Press ▲▼◀▶ to select [OK], and press the <ENTER> button.
 - Name of the projection lens is changed.

Note

- [LENS INFORMATION SETTING] is not displayed when a projection lens without built-in EEPROM is attached.
- Factory default name is [LENS01].
- If the standard DC motor unit installed in the Zoom Lens (Model No.: ET-D75LE6, ET-D75LE8, ET-D75LE10, ET-D75LE20, ET-D75LE30, ET-D75LE40, etc.) is replaced with the stepping motor unit using the Stepping Motor Kit (Model No.: ET-D75MKS10), the [LENS NAME] information is written into the EEPROM built in the stepping motor unit.
- [LENS NAME] will not return to factory default setting even when the [PROJECTOR SETUP] menu → [INITIALIZE] → [ALL USER DATA] is executed.

[LENS MEMORY]

The adjusted lens position (vertical position, horizontal position, focus position, and zoom position) can be saved and loaded.

Saving lens position

- 1) Press ▲▼ to select [LENS].
- 2) Press the <ENTER> button.
 - The [LENS] screen is displayed.
- 3) Press ▲▼ to select [LENS MEMORY].
- 4) Press the <ENTER> button.
 - The [LENS MEMORY] screen is displayed.
- 5) Press ▲▼ to select [LENS MEMORY SAVE].
- 6) Press the <ENTER> button.
 - The [LENS MEMORY SAVE] screen is displayed.
 - If the lens memory has already been saved, the name of the saved lens memory and its lens position information ([VERTICAL POSITION]/[HORIZONTAL POSITION]/[FOCUS POSITION]/[ZOOM POSITION]) are displayed in the [LENS MEMORY SAVE] screen.
- 7) Press ▲▼ to select the item to save, and press the <ENTER> button.
 - The confirmation screen is displayed.
 - Current lens position information ([VERTICAL POSITION]/[HORIZONTAL POSITION]/[FOCUS POSITION]/[ZOOM POSITION]) is displayed in the confirmation screen.
- 8) Press ◀▶ to select [OK], and press the <ENTER> button.
 - The [LENS MEMORY NAME INPUT] screen is displayed.
- 9) Press ▲▼◀▶ to select the text, and press the <ENTER> button to enter the text.
- 10) After the name is input, press ▲▼◀▶ to select [OK], and press the <ENTER> button.
 - Saving of the lens memory is completed, and returns to the [LENS MEMORY SAVE] screen.
 - If you press ▲▼◀▶ to select [CANCEL] and then press the <ENTER> button, the lens memory will not be saved.
 - If you press ▲▼◀▶ to select [DEFAULT] and press the <ENTER> button, the entered name will not be registered and the default name will be used.
 - If you select [OK] without entering any characters and press the <ENTER> button, the default name will be used.

Note

- The numeric value information of the zoom position is displayed only in following cases.
 - When the standard DC motor unit installed in the Zoom Lens (Model No.: ET-D75LE6, ET-D75LE8, ET-D75LE10, ET-D75LE20, ET-D75LE30, ET-D75LE40, etc.) is replaced with the stepping motor unit using the Stepping Motor Kit (Model No.: ET-D75MKS10)
 - When the projection lens with stepping motor is attached
-

Loading the lens position

- 1) Press ▲▼ to select [LENS].
- 2) Press the <ENTER> button.
 - The [LENS] screen is displayed.
- 3) Press ▲▼ to select [LENS MEMORY].
- 4) Press the <ENTER> button.
 - The [LENS MEMORY] screen is displayed.
- 5) Press ▲▼ to select [LENS MEMORY LOAD].
- 6) Press the <ENTER> button.
 - The [LENS MEMORY LOAD] screen is displayed.
 - The name of the saved lens memory and its lens position information ([VERTICAL POSITION]/[HORIZONTAL POSITION]/[FOCUS POSITION]/[ZOOM POSITION]) are displayed in the [LENS MEMORY LOAD] screen.
- 7) Press ▲▼ to select the item to load, and press the <ENTER> button.
 - The confirmation screen is displayed.
- 8) Press ◀▶ to select [OK], and press the <ENTER> button.
 - The lens will automatically move to the lens position (vertical position, horizontal position, focus position, and zoom position) of the loaded lens memory.

Note

- Lens memory is not guaranteed to be 100 % reproduced. Readjust the focus, zoom, and lens shift after loading the lens memory if required.
 - If the projection lens is replaced, execute the [PROJECTOR SETUP] menu → [LENS] → [LENS CALIBRATION], readjust the focus, zoom, and lens shift, and save the lens memory again.
 - The lens memory for the zoom position will not operate when a projection lens without the zoom function is used.
 - The numeric value information of the zoom position is displayed only in following cases.
 - When the standard DC motor unit installed in the Zoom Lens (Model No.: ET-D75LE6, ET-D75LE8, ET-D75LE10, ET-D75LE20, ET-D75LE30, ET-D75LE40, etc.) is replaced with the stepping motor unit using the Stepping Motor Kit (Model No.: ET-D75MKS10)
 - When the projection lens with stepping motor is attached
 - The saved lens memory is loaded in order every time the <FUNCTION> button is pressed when [LENS MEMORY LOAD] is assigned to the <FUNCTION> button.
-

Deleting a lens memory

- 1) Press ▲▼ to select [LENS].
- 2) Press the <ENTER> button.
 - The [LENS] screen is displayed.
- 3) Press ▲▼ to select [LENS MEMORY].
- 4) Press the <ENTER> button.
 - The [LENS MEMORY] screen is displayed.
- 5) Press ▲▼ to select [LENS MEMORY EDIT].
- 6) Press the <ENTER> button.
 - The [LENS MEMORY EDIT] screen is displayed.
- 7) Press ▲▼ to select [LENS MEMORY DELETE].
- 8) Press the <ENTER> button.
 - The [LENS MEMORY DELETE] screen is displayed.

- The name of the saved lens memory and its lens position information ([VERTICAL POSITION]/[HORIZONTAL POSITION]/[FOCUS POSITION]/[ZOOM POSITION]) are displayed in the **[LENS MEMORY DELETE]** screen.
- 9) Press **▲▼** to select the item to delete, and press the **<ENTER>** button.
 - The confirmation screen is displayed.
 - 10) Press **◀▶** to select **[OK]**, and press the **<ENTER>** button.

Note

- The numeric value information of the zoom position is displayed only in following cases.
 - When the standard DC motor unit installed in the Zoom Lens (Model No.: ET-D75LE6, ET-D75LE8, ET-D75LE10, ET-D75LE20, ET-D75LE30, ET-D75LE40, etc.) is replaced with the stepping motor unit using the Stepping Motor Kit (Model No.: ET-D75MKS10)
 - When the projection lens with stepping motor is attached

Changing the lens memory name

- 1) Press **▲▼** to select **[LENS]**.
- 2) Press the **<ENTER>** button.
 - The **[LENS]** screen is displayed.
- 3) Press **▲▼** to select **[LENS MEMORY]**.
- 4) Press the **<ENTER>** button.
 - The **[LENS MEMORY]** screen is displayed.
- 5) Press **▲▼** to select **[LENS MEMORY EDIT]**.
- 6) Press the **<ENTER>** button.
 - The **[LENS MEMORY EDIT]** screen is displayed.
- 7) Press **▲▼** to select **[LENS MEMORY NAME CHANGE]**.
- 8) Press the **<ENTER>** button.
 - The **[LENS MEMORY NAME CHANGE]** screen is displayed.
 - The name of the saved lens memory and its lens position information ([VERTICAL POSITION]/[HORIZONTAL POSITION]/[FOCUS POSITION]/[ZOOM POSITION]) are displayed in the **[LENS MEMORY NAME CHANGE]** screen.
- 9) Press **▲▼** to select the name to change, and press the **<ENTER>** button.
 - The **[LENS MEMORY NAME INPUT]** screen is displayed.
- 10) Press **▲▼◀▶** to select the text, and press the **<ENTER>** button to enter the text.
- 11) After the name is changed, press **▲▼◀▶** to select **[OK]**, and press the **<ENTER>** button.
 - Saving of the lens memory is completed, and returns to the **[LENS MEMORY NAME CHANGE]** screen.
 - If you press **▲▼◀▶** to select **[CANCEL]** and then press the **<ENTER>** button, the changed name will not be registered.
 - If you press **▲▼◀▶** to select **[DEFAULT]** and press the **<ENTER>** button, the changed name will not be registered and the default name will be used.
 - If you select **[OK]** without entering any characters and press the **<ENTER>** button, the default name will be used.

Note

- The numeric value information of the zoom position is displayed only in following cases.
 - When the standard DC motor unit installed in the Zoom Lens (Model No.: ET-D75LE6, ET-D75LE8, ET-D75LE10, ET-D75LE20, ET-D75LE30, ET-D75LE40, etc.) is replaced with the stepping motor unit using the Stepping Motor Kit (Model No.: ET-D75MKS10)
 - When the projection lens with stepping motor is attached

[LENS HOME POSITION]

Operate in following procedure to move the projection lens to the home position.

- 1) Press **▲▼** to select **[LENS]**.

- 2) Press the <ENTER> button.
 - The [LENS] screen is displayed.
- 3) Press ▲▼ to select [LENS HOME POSITION].
- 4) Press the <ENTER> button.
 - The confirmation screen is displayed.
- 5) Press ◀▶ to select [OK], and press the <ENTER> button.
 - [PROGRESS] is displayed in the [HOME POSITION] screen, and the projection lens is moved to the origin position.

Note

- [LENS HOME POSITION] cannot be executed when the [PROJECTOR SETUP] menu → [LENS] → [LENS TYPE] is set to [NOT SELECTED].
- [LENS HOME POSITION] can also be executed by pressing the <DEFAULT> button on the remote control while the lens shift adjustment screen is displayed.
- The home position varies depending on the projection lens type. For details, refer to “Lens shift range” (➡ page 76).

[ACTIVE FOCUS OPTIMIZER]

Enable/disable the active focus optimizer function. The shift in focus caused by the change of the image brightness can be reduced by enabling this function. It will also reduce the shift in focus for the focus right before enabling the shutter function (shutter: closed) and the focus right after disabling the shutter function (shutter: open).

- 1) Press ▲▼ to select [LENS].
- 2) Press the <ENTER> button.
 - The [LENS] screen is displayed.
- 3) Press ▲▼ to select [ACTIVE FOCUS OPTIMIZER].
- 4) Press the <ENTER> button.
 - The [ACTIVE FOCUS OPTIMIZER] screen is displayed.
- 5) Press ▲▼ to select [ACTIVE FOCUS].
- 6) Press ◀▶ to switch the item.
 - The items will switch each time you press the button.

[OFF]	Disables the active focus optimizer function.
[ON]	Enables the active focus optimizer function.

Note

- [ACTIVE FOCUS] cannot be set when the [PROJECTOR SETUP] menu → [LENS] → [LENS TYPE] is set to [NOT SELECTED].
- When this function is set to [ON], the focus adjustment (adjustment of the focus position of the lens) is automatically performed when the brightness of the image changes. Note following especially when constructing multi-display using multiple projectors such as using the edge blending function by setting the [ADVANCED MENU] menu → [EDGE BLENDING].
 - Position of the projected image may slightly shift due to the amount of focus adjustment.
 - The projected image may slightly undulate during the focus adjustment.
- When this function is set to [ON], driving sound of the focus adjustment motor may be audible when the brightness of the image changes.
- When this function is set to [ON], the setting status of [ACTIVE FOCUS OPTIMIZER] ([ON]) is displayed in the focus adjustment screen.
- The active focus optimizer function operates within the range of focus adjustment. It may not operate properly when used close to the limit value for the focus adjustment.
- The active focus optimizer function may not correctly operate when the optional Lens Fixed Attachment (Model No.: ET-PLF10) is attached. Do not press the lens fixing clasp of the Lens Fixed Attachment too strong against the projection lens.
- The value of the parameter used by the active focus optimizer function is displayed as [FOCUS OFFSET BRIGHT] and [FOCUS OFFSET DARK].
- Parameter for [FOCUS OFFSET BRIGHT] and [FOCUS OFFSET DARK] will be the factory default value set for each type of projection lens in following cases.
 - When the [PROJECTOR SETUP] menu → [LENS] → [FOCUS OFFSET SETUP] → [SETUP ASSISTANT] is not executed
 - When the [PROJECTOR SETUP] menu → [LENS] → [FOCUS OFFSET SETUP] → [INITIALIZE] is executed
 - When the <DEFAULT> button is pressed while [FOCUS OFFSET BRIGHT] or [FOCUS OFFSET DARK] is selected
- To reduce the shift in focus caused by the change in the brightness of the image, set [FOCUS OFFSET BRIGHT] and [FOCUS OFFSET DARK] following the guidance in [SETUP ASSISTANT]. For details, refer to “Performing simplified setting using the internal test pattern” (➡ page 146), “Performing simplified setting using the external input image” (➡ page 147).
- [ACTIVE FOCUS] will be set to [OFF] when the [PROJECTOR SETUP] menu → [INITIALIZE] → [ALL USER DATA] is executed.

Performing simplified setting using the internal test pattern

Set the parameters for [FOCUS OFFSET BRIGHT] and [FOCUS OFFSET DARK] using the test pattern built in the projector following the guidance of [SETUP ASSISTANT].

- 1) Press ▲▼ to select [LENS].
- 2) Press the <ENTER> button.
 - The [LENS] screen is displayed.
- 3) Press ▲▼ to select [ACTIVE FOCUS OPTIMIZER].
- 4) Press the <ENTER> button.
 - The [ACTIVE FOCUS OPTIMIZER] screen is displayed.
- 5) Press ▲▼ to select [FOCUS OFFSET SETUP].
- 6) Press the <ENTER> button.
 - The [FOCUS OFFSET SETUP] screen is displayed.
- 7) Press ▲▼ to select [SETUP ASSISTANT].
- 8) Press the <ENTER> button.
 - If the [PROJECTOR SETUP] menu → [LIGHT OUTPUT] is set to [100.0%], the internal focus test pattern of signal level approximately 50 % is projected, and the [SETUP ASSISTANT] screen (page 1/8) is displayed. Proceed to Step 10).
 - If the [PROJECTOR SETUP] menu → [LIGHT OUTPUT] is set to less than [100.0%], the confirmation screen is displayed. Proceed to Step 9).
- 9) Press ◀▶ to select [NEXT], and press the <ENTER> button.
 - Even if [PROJECTOR SETUP] menu → [LIGHT OUTPUT] is set to less than [100.0%], the projector will operate with the [100.0%] setting while [SETUP ASSISTANT] is executing. Once [SETUP ASSISTANT] is completed, it will return to the original [LIGHT OUTPUT] setting value.
 - After confirming the confirmation message, press ◀▶ to select [NEXT], and press the <ENTER> button. The internal focus test pattern of signal level approximately 50 % is projected, and the [SETUP ASSISTANT] screen (page 1/8) is displayed.
 - To cancel the setting by [SETUP ASSISTANT], press ◀▶ to select [CANCEL], and press the <ENTER> button. [SETUP ASSISTANT] is canceled, and the [FOCUS OFFSET SETUP] screen is displayed.
- 10) Wait until [Waiting time] turns [0s].
 - Wait until the focus is stabilized.
 - When the [Waiting time] turns [0s], the [Please wait...] message disappears, and [NEXT] becomes selectable.
- 11) Press ◀▶ to select [NEXT], and press the <ENTER> button.
 - The [SETUP ASSISTANT] screen (page 2/8) is displayed.
 - It will return to previous screen by selecting [BACK] and pressing the <ENTER> button.
- 12) Press ▲▼◀▶ to select [FOCUS POSITION].
- 13) Press the ◀▶ button to adjust the focus.
- 14) Press ▲▼◀▶ to select [NEXT], and press the <ENTER> button.
 - The [SETUP ASSISTANT] screen (page 3/8) is displayed.
- 15) Press ▲▼◀▶ to select [TEST PATTERN].
- 16) Press ◀▶ to select [INTERNAL].
 - The items will switch each time you press the button.

[INTERNAL]	Uses the internal focus test pattern of signal level approximately 100 % for focus adjustment.
[EXTERNAL]	Select this item when using the input image from an external device for focus adjustment.

- 17) Press ▲▼◀▶ to select [NEXT], and press the <ENTER> button.
 - The [SETUP ASSISTANT] screen (page 4/8) is displayed.

- It will return to previous screen by selecting [BACK] and pressing the <ENTER> button.

18) Wait until [Waiting time] turns [0s].

- Wait until the focus is stabilized.
- When the [Waiting time] turns [0s], the [Please wait...] message disappears, and [NEXT] becomes selectable.

19) Press ◀▶ to select [NEXT], and press the <ENTER> button.

- The [SETUP ASSISTANT] screen (page 5/8) is displayed.
- It will return to previous screen by selecting [BACK] and pressing the <ENTER> button.

20) Press ▲▼◀▶ to select [FOCUS POSITION].

21) Press the ◀▶ button to adjust the focus.

22) Press ▲▼◀▶ to select [NEXT], and press the <ENTER> button.

- The [SETUP ASSISTANT] screen (page 6/8) is displayed.

23) Press ▲▼◀▶ to select [TEST PATTERN].

24) Press ◀▶ to select [INTERNAL].

- The items will switch each time you press the button.

[INTERNAL]	Uses the internal focus test pattern of signal level approximately 0 % for focus adjustment.
[EXTERNAL]	Select this item when using the input image from an external device for focus adjustment.

25) Press ▲▼◀▶ to select [NEXT], and press the <ENTER> button.

- The [SETUP ASSISTANT] screen (page 7/8) is displayed.
- It will return to previous screen by selecting [BACK] and pressing the <ENTER> button.

26) Wait until [Waiting time] turns [0s].

- Wait until the focus is stabilized.
- When the [Waiting time] turns [0s], the [Please wait...] message disappears, and [NEXT] becomes selectable.

27) Press ◀▶ to select [NEXT], and press the <ENTER> button.

- The [SETUP ASSISTANT] screen (page 8/8) is displayed.
- It will return to previous screen by selecting [BACK] and pressing the <ENTER> button.

28) Press ▲▼◀▶ to select [FOCUS POSITION].

29) Press the ◀▶ button to adjust the focus.

30) Press ▲▼◀▶ to select [STORE], and press the <ENTER> button.

- [SETUP ASSISTANT] is completed, and the parameters for [FOCUS OFFSET BRIGHT] and [FOCUS OFFSET DARK] are updated.

Note

- When the parameters for [FOCUS OFFSET BRIGHT] and [FOCUS OFFSET DARK] are set by executing [SETUP ASSISTANT], the [PROJECTOR SETUP] menu → [LENS] → [ACTIVE FOCUS OPTIMIZER] → [ACTIVE FOCUS] will be set to [ON].
- When [FOCUS OFFSET BRIGHT] and [FOCUS OFFSET DARK] are set following the guidance of [SETUP ASSISTANT] with AC 100 V to AC 120 V, use the projector with AC 100 V to AC 120 V. When the power supply is changed to AC 200 V to AC 240 V, reset the settings using [SETUP ASSISTANT].

Performing simplified setting using the external input image

Input any focus adjustment still image from the external device connected to the projector, and set the parameters for [FOCUS OFFSET BRIGHT] and [FOCUS OFFSET DARK] following the guidance of [SETUP ASSISTANT].

1) Switch to the input to display the focus adjustment image.

2) Press ▲▼ to select [LENS].

3) Press the <ENTER> button.

- The [LENS] screen is displayed.

- 4) Press ▲▼ to select [ACTIVE FOCUS OPTIMIZER].
- 5) Press the <ENTER> button.
 - The [ACTIVE FOCUS OPTIMIZER] screen is displayed.
- 6) Press ▲▼ to select [FOCUS OFFSET SETUP].
- 7) Press the <ENTER> button.
 - The [FOCUS OFFSET SETUP] screen is displayed.
- 8) Press ▲▼ to select [SETUP ASSISTANT].
- 9) Press the <ENTER> button.
 - If the [PROJECTOR SETUP] menu → [LIGHT OUTPUT] is set to [100.0%], the internal focus test pattern of signal level approximately 50 % is projected, and the [SETUP ASSISTANT] screen (page 1/8) is displayed. Proceed to Step 11).
 - If the [PROJECTOR SETUP] menu → [LIGHT OUTPUT] is set to less than [100.0%], the confirmation screen is displayed. Proceed to Step 10).
- 10) Press ◀▶ to select [NEXT], and press the <ENTER> button.
 - Even if [PROJECTOR SETUP] menu → [LIGHT OUTPUT] is set to less than [100.0%], the projector will operate with the [100.0%] setting while [SETUP ASSISTANT] is executing. Once [SETUP ASSISTANT] is completed, it will return to the original [LIGHT OUTPUT] setting value.
 - After confirming the confirmation message, press ◀▶ to select [NEXT], and press the <ENTER> button. The internal focus test pattern of signal level approximately 50 % is projected, and the [SETUP ASSISTANT] screen (page 1/8) is displayed.
 - To cancel the setting by [SETUP ASSISTANT], press ◀▶ to select [CANCEL], and press the <ENTER> button. [SETUP ASSISTANT] is canceled, and the [FOCUS OFFSET SETUP] screen is displayed.
- 11) Wait until [Waiting time] turns [0s].
 - Wait until the focus is stabilized.
 - When the [Waiting time] turns [0s], the [Please wait...] message disappears, and [NEXT] becomes selectable.
- 12) Press ◀▶ to select [NEXT], and press the <ENTER> button.
 - The [SETUP ASSISTANT] screen (page 2/8) is displayed.
 - It will return to previous screen by selecting [BACK] and pressing the <ENTER> button.
- 13) Press ▲▼◀▶ to select [FOCUS POSITION].
- 14) Press the ◀▶ button to adjust the focus.
- 15) Press ▲▼◀▶ to select [NEXT], and press the <ENTER> button.
 - The [SETUP ASSISTANT] screen (page 3/8) is displayed.
- 16) Press ▲▼◀▶ to select [TEST PATTERN].
- 17) Press ◀▶ to select [EXTERNAL].
 - The items will switch each time you press the button.

[INTERNAL]	Select this item when using the internal test pattern for focus adjustment.
[EXTERNAL]	Uses the input image from the external device for focus adjustment. If the level of [Brightness of the image] falls below the specified value, [NEXT] cannot be selected. When the bright image with a brightness level indicated in the menu screen (OSD) or greater is input, [NEXT] can be selected.

- 18) Press ▲▼◀▶ to select [NEXT], and press the <ENTER> button.
 - The [SETUP ASSISTANT] screen (page 4/8) is displayed.
 - It will return to previous screen by selecting [BACK] and pressing the <ENTER> button.
- 19) Wait until [Waiting time] turns [0s].
 - Wait until the focus is stabilized.
 - When the [Waiting time] turns [0s], the [Please wait...] message disappears, and [NEXT] becomes selectable.

- 20) Press ◀▶ to select [NEXT], and press the <ENTER> button.
- The [SETUP ASSISTANT] screen (page 5/8) is displayed.
 - It will return to previous screen by selecting [BACK] and pressing the <ENTER> button.
- 21) Press ▲▼◀▶ to select [FOCUS POSITION].
- 22) Press the ◀▶ button to adjust the focus.
- 23) Press ▲▼◀▶ to select [NEXT], and press the <ENTER> button.
- The [SETUP ASSISTANT] screen (page 6/8) is displayed.
- 24) Press ▲▼◀▶ to select [TEST PATTERN].
- 25) Press ◀▶ to select [EXTERNAL].
- The items will switch each time you press the button.

[INTERNAL]	Select this item when using the internal test pattern for focus adjustment.
[EXTERNAL]	Uses the input image from the external device for focus adjustment. If the level of [Brightness of the image] exceeds the specified value, [NEXT] cannot be selected. When the dark image with a brightness level indicated in the menu screen (OSD) or lower is input, [NEXT] can be selected.

- 26) Press ▲▼◀▶ to select [NEXT], and press the <ENTER> button.
- The [SETUP ASSISTANT] screen (page 7/8) is displayed.
 - It will return to previous screen by selecting [BACK] and pressing the <ENTER> button.
- 27) Wait until [Waiting time] turns [0s].
- Wait until the focus is stabilized.
 - When the [Waiting time] turns [0s], the [Please wait...] message disappears, and [NEXT] becomes selectable.
- 28) Press ◀▶ to select [NEXT], and press the <ENTER> button.
- The [SETUP ASSISTANT] screen (page 8/8) is displayed.
 - It will return to previous screen by selecting [BACK] and pressing the <ENTER> button.
- 29) Press ▲▼◀▶ to select [FOCUS POSITION].
- 30) Press the ◀▶ button to adjust the focus.
- 31) Press ▲▼◀▶ to select [STORE], and press the <ENTER> button.
- [SETUP ASSISTANT] is completed, and the parameters for [FOCUS OFFSET BRIGHT] and [FOCUS OFFSET DARK] are updated.

Note

- When the parameters for [FOCUS OFFSET BRIGHT] and [FOCUS OFFSET DARK] are set by executing [SETUP ASSISTANT], the [PROJECTOR SETUP] menu → [LENS] → [ACTIVE FOCUS OPTIMIZER] → [ACTIVE FOCUS] will be set to [ON].
- When [FOCUS OFFSET BRIGHT] and [FOCUS OFFSET DARK] are set following the guidance of [SETUP ASSISTANT] with AC 100 V to AC 120 V, use the projector with AC 100 V to AC 120 V. When the power supply is changed to AC 200 V to AC 240 V, reset the settings using [SETUP ASSISTANT].

Directly setting the parameter

When using the projection lens where the optimal parameter at the time when combined with the projector is already known, [FOCUS OFFSET BRIGHT] and [FOCUS OFFSET DARK] parameters can be individually set without executing [SETUP ASSISTANT].

- 1) Press ▲▼ to select [LENS].
- 2) Press the <ENTER> button.
 - The [LENS] screen is displayed.
- 3) Press ▲▼ to select [ACTIVE FOCUS OPTIMIZER].
- 4) Press the <ENTER> button.
 - The [ACTIVE FOCUS OPTIMIZER] screen is displayed.
- 5) Press ▲▼ to select [FOCUS OFFSET SETUP].

- 6) Press the <ENTER> button.
 - The [FOCUS OFFSET SETUP] screen is displayed.
- 7) Press ▲▼ to select [FOCUS OFFSET BRIGHT] or [FOCUS OFFSET DARK].
- 8) Press ◀▶ to set the parameter.
 - Set the parameter in the range from [-99] to [+99].

Displaying the test pattern

The internal focus test pattern used with [SETUP ASSISTANT] is displayed.

- 1) Press ▲▼ to select [LENS].
- 2) Press the <ENTER> button.
 - The [LENS] screen is displayed.
- 3) Press ▲▼ to select [ACTIVE FOCUS OPTIMIZER].
- 4) Press the <ENTER> button.
 - The [ACTIVE FOCUS OPTIMIZER] screen is displayed.
- 5) Press ▲▼ to select [FOCUS OFFSET SETUP].
- 6) Press the <ENTER> button.
 - The [FOCUS OFFSET SETUP] screen is displayed.
- 7) Press ▲▼ to select [TEST PATTERN].
- 8) Press ◀▶ to select an item.
 - The items will switch each time you press the button.

[OFF]	Does not display the test pattern.
[0%]	Displays the focus test pattern of signal level approximately 0 %.
[50%]	Displays the focus test pattern of signal level approximately 50 %.
[100%]	Displays the focus test pattern of signal level approximately 100 %.

Initializing the parameter

Return all the parameters for [FOCUS OFFSET BRIGHT] and [FOCUS OFFSET DARK] saved by each setting in the [PROJECTOR SETUP] menu → [LENS] → [LENS TYPE] to factory default settings.

- 1) Press ▲▼ to select [LENS].
- 2) Press the <ENTER> button.
 - The [LENS] screen is displayed.
- 3) Press ▲▼ to select [ACTIVE FOCUS OPTIMIZER].
- 4) Press the <ENTER> button.
 - The [ACTIVE FOCUS OPTIMIZER] screen is displayed.
- 5) Press ▲▼ to select [FOCUS OFFSET SETUP].
- 6) Press the <ENTER> button.
 - The [FOCUS OFFSET SETUP] screen is displayed.
- 7) Press ▲▼ to select [INITIALIZE], and press the <ENTER> button.
 - The confirmation screen is displayed.
- 8) Press ◀▶ to select [OK], and press the <ENTER> button.

[LENS CALIBRATION]

Detect the lens adjustment limit value, and perform the calibration in the adjustment range. Execute the lens calibration after attaching the projection lens.

Zoom Lens with DC motor, the Fixed-focus Lens

This section describes the operating procedure when the Zoom Lens (Model No.: ET-D75LE6, ET-D75LE8, ET-D75LE10, ET-D75LE20, ET-D75LE30, ET-D75LE40, etc.) in which the DC motor has not been replaced with the stepping motor unit is attached, or when the Fixed-focus Lens (Model No.: ET-D75LE50, ET-D75LE95, ET-D75LE90, etc.) without the zoom function is attached. Refer to “Zoom Lens with the stepping motor” (► page 151) when a projection lens with stepping motor is attached.

- 1) Press ▲▼ to select [LENS].
- 2) Press the <ENTER> button.
 - The [LENS] screen is displayed.
- 3) Press ▲▼ to select [LENS CALIBRATION].
- 4) Press the <ENTER> button.
 - The confirmation screen is displayed.
- 5) Press ◀▶ to select [OK], and press the <ENTER> button.
 - The lens calibration is started. Perform the calibrations for the lens shift, focus, and zoom when the Zoom Lens is attached. Perform the calibrations for the lens shift and focus when the Fixed-focus Lens is attached.
 - After completing the calibration in the adjustment range, the projection lens will move to the home position.
 - To cancel, select [CANCEL].

Note

- [LENS CALIBRATION] cannot be executed when the [PROJECTOR SETUP] menu → [LENS] → [LENS TYPE] is set to [NOT SELECTED].
- [PROGRESS] is displayed in the menu during lens calibration. The operation cannot be canceled during calibration.
- [INCOMPLETE] is displayed when the lens calibration is not performed correctly.
- The origin position of the lens mounter and the home position of the projection lens are automatically updated when the lens shift calibration is performed. The home position is an origin position of the lens shift (vertical position and horizontal position of the lens) based on the calibration result. It does not match with the optical image center position.
- The home position varies depending on the projection lens type. For details, refer to “Lens shift range” (► page 76).

Zoom Lens with the stepping motor

This section describes the operating procedure when the standard DC motor unit installed in the Zoom Lens (Model No.: ET-D75LE6, ET-D75LE8, ET-D75LE10, ET-D75LE20, ET-D75LE30, ET-D75LE40, etc.) is replaced with the stepping motor unit using the Stepping Motor Kit (Model No.: ET-D75MKS10), or when a projection lens with the stepping motor is attached.

- 1) Press ▲▼ to select [LENS].
- 2) Press the <ENTER> button.
 - The [LENS] screen is displayed.
- 3) Press ▲▼ to select [LENS CALIBRATION].
- 4) Press the <ENTER> button.
 - The [LENS CALIBRATION] screen is displayed.
- 5) Press ▲▼ to select an item.

[SHIFT/FOCUS/ZOOM]	Executes the calibrations for the lens shift, focus, and zoom. After completing the calibration in the adjustment range, the projection lens will move to the home position.
[SHIFT/FOCUS]	Executes the calibrations for the lens shift and focus. After completing the calibration in the adjustment range, the projection lens will move to the home position.
[ZOOM]	Executes the calibration of the zoom adjustment range.

- 6) Press the <ENTER> button.
 - The confirmation screen is displayed.
- 7) Press ◀▶ to select [OK], and press the <ENTER> button.
 - The lens calibration is started.

- To cancel, select [CANCEL].

Note

- [LENS CALIBRATION] cannot be executed when the [PROJECTOR SETUP] menu → [LENS] → [LENS TYPE] is set to [NOT SELECTED].
- [PROGRESS] is displayed in the menu during lens calibration. The operation cannot be canceled during calibration.
- [INCOMPLETE] is displayed when the lens calibration is not performed correctly.
- The origin position of the lens mounter and the home position of the projection lens are automatically updated when the lens shift calibration is performed. The home position is an origin position of the lens shift (vertical position and horizontal position of the lens) based on the calibration result. It does not match with the optical image center position.
- The home position varies depending on the projection lens type. For details, refer to “Lens shift range” (► page 76).

[OPERATION SETTING]

Set the operation method of the projector.

The settings are reflected when “Initial setting (operation setting)” (► page 63) in the [INITIAL SETTING] screen is already set.

If you change the settings while using the projector, the duration until the luminance of light source decreases by half may shorten or the luminance may decrease.

Setting [OPERATING MODE]

- 1) Press ▲▼ to select [OPERATION SETTING].
- 2) Press the <ENTER> button.
 - The [OPERATION SETTING] screen is displayed.
- 3) Press ▲▼ to select [OPERATING MODE].
- 4) Press ◀▶ to switch the item.
 - The items will switch each time you press the button.

[NORMAL]*1	Set this item when high luminance is required. The estimated runtime is approximately 20 000 hours.
[ECO]*1	The luminance will decrease compared to [NORMAL], but set this item to increase the expected life of the light source. The estimated runtime is approximately 24 000 hours.
[USER1]	Set [MAX LIGHT OUTPUT LEVEL] and [LIGHT OUTPUT] individually.
[USER2]	
[USER3]	

*1 The runtime is an estimation when the [PICTURE] menu → [DYNAMIC CONTRAST] is set to [3].

- 5) Press ▲▼ to select [APPLY].
- 6) Press the <ENTER> button.
 - The confirmation screen is displayed.
- 7) Press ◀▶ to select [OK], and press the <ENTER> button.

Note

- The [OPERATING MODE] setting does not return to factory default setting even if the [PROJECTOR SETUP] menu → [INITIALIZE] → [ALL USER DATA] is executed.
- The estimated runtime is a time for the luminance to decrease to half.
- If the consolidated runtime of the projector exceeds 20 000 hours, replacement of the components inside the projector may be required. The consolidated runtime can be confirmed in the [STATUS] screen. Refer to the [PROJECTOR SETUP] menu → [STATUS] for details.

Setting [MAX LIGHT OUTPUT LEVEL]

Adjust the maximum level to correct screen brightness according to the changes in brightness of the light source.

- 1) Press ▲▼ to select [OPERATION SETTING].
- 2) Press the <ENTER> button.
 - The [OPERATION SETTING] screen is displayed.
- 3) Press ▲▼ to select [MAX LIGHT OUTPUT LEVEL].
- 4) Press ◀▶ to adjust.

Operation	Adjustment	Range of adjustment
Press ►.	Increases the maximum level of brightness correction.	8.0 % - 100.0 %
Press ◀.	Decreases the maximum level of brightness correction.	

- 5) Press ▲▼ to select [APPLY].
- 6) Press the <ENTER> button.
 - The confirmation screen is displayed.
- 7) Press ◀► to select [OK], and press the <ENTER> button.

Note

- When [OPERATING MODE] is set to [NORMAL] or [ECO], the item of [MAX LIGHT OUTPUT LEVEL] cannot be adjusted.
- The brightness is corrected using this setting when the [PROJECTOR SETUP] menu → [BRIGHTNESS CONTROL] → [BRIGHTNESS CONTROL SETUP] → [CONSTANT MODE] is set to [AUTO] or [PC].
- The [MAX LIGHT OUTPUT LEVEL] setting does not return to factory default setting even if the [PROJECTOR SETUP] menu → [INITIALIZE] → [ALL USER DATA] is executed.

Setting [LIGHT OUTPUT]

Adjust the brightness of light source.

The [LIGHT OUTPUT] setting is synchronized with the [PROJECTOR SETUP] menu → [LIGHT OUTPUT]. The most recent setting is reflected in both items.

- 1) Press ▲▼ to select [OPERATION SETTING].
- 2) Press the <ENTER> button.
 - The [OPERATION SETTING] screen is displayed.
- 3) Press ▲▼ to select [LIGHT OUTPUT].
- 4) Press ◀► to adjust.

Operation	Adjustment		Range of adjustment
	Brightness	Runtime	
Press ►.	The screen becomes brighter.	The runtime becomes shorter.	8.0 % - 100.0 %
Press ◀.	The screen becomes darker.	The runtime becomes longer.	

- 5) Press ▲▼ to select [APPLY].
- 6) Press the <ENTER> button.
 - The confirmation screen is displayed.
- 7) Press ◀► to select [OK], and press the <ENTER> button.

Note

- [LIGHT OUTPUT] can be adjusted individually for each setting item of [OPERATING MODE].
- In such a case when configuring multiple screens with multiple projectors, uniformity of brightness between multiple screens can be obtained by adjusting [LIGHT OUTPUT].

Interrelation of luminance and runtime

The projector can be operated at arbitrary brightness and duration of use by combining the settings of [MAX LIGHT OUTPUT LEVEL], [LIGHT OUTPUT], and [CONSTANT MODE] in [BRIGHTNESS CONTROL SETUP]. Interrelation of luminance and runtime is as follows. Make the settings depending on your desired duration of use and brightness of the projected image.

Values of the luminance and runtime are rough estimations.

■ To set the projector based on the duration of use

Duration of use (hour)	When [CONSTANT MODE] is set to [OFF]			When [CONSTANT MODE] is set to [AUTO] or [PC]		
	[MAX LIGHT OUTPUT LEVEL] (%)	[LIGHT OUTPUT] (%)	Luminance (lm)	[MAX LIGHT OUTPUT LEVEL] (%)	[LIGHT OUTPUT] (%)	Luminance (lm)
20 000	100.0	100.0	20 000	100.0	71.6	14 300
24 000	100.0	100.0	20 000	100.0	68.3	13 600
27 000	100.0	88.4	17 600	100.0	65.9	13 100
31 000	100.0	74.9	14 900	100.0	63.0	12 600
35 000	100.0	64.3	12 800	100.0	60.3	12 000
40 000	—	—	—	100.0	57.2	11 400

■ To set the projector based on luminance

Luminance (lm)	When [CONSTANT MODE] is set to [OFF]			When [CONSTANT MODE] is set to [AUTO] or [PC]		
	[MAX LIGHT OUTPUT LEVEL] (%)	[LIGHT OUTPUT] (%)	Runtime (hour)	[MAX LIGHT OUTPUT LEVEL] (%)	[LIGHT OUTPUT] (%)	Runtime (hour)
20 000	100.0	100.0	24 290	—	—	—
18 000	100.0	90.0	26 600	100.0	90.0	2 490
16 000	100.0	80.0	29 370	100.0	80.0	11 180
14 000	100.0	70.0	32 730	100.0	70.0	21 860
12 000	100.0	60.0	36 900	100.0	60.0	35 520
10 000	—	—	—	100.0	50.0	53 740
8 000	—	—	—	100.0	40.0	79 390
6 000	—	—	—	100.0	30.0	118 060
4 000	—	—	—	100.0	20.0	182 260

Note

- Under influence of characteristics of each light source, conditions of use, installation environment, etc., the runtime may be shorter than the estimation.
- The duration of use is referred to as the runtime when you use the projector successively. The duration of use is an estimated duration and is not the warranty period.
- If the consolidated runtime of the projector exceeds 20 000 hours, replacement of the components inside the projector may be required. The consolidated runtime can be confirmed in the [STATUS] screen. Refer to the [PROJECTOR SETUP] menu → [STATUS] for details.

[LIGHT OUTPUT]

Adjust the brightness of light source.

The setting is reflected when it is already set with “Initial setting (operation setting)” (➔ page 63) in the [INITIAL SETTING] screen or with the [PROJECTOR SETUP] menu → [OPERATION SETTING]. The [LIGHT OUTPUT] setting is synchronized with the [PROJECTOR SETUP] menu → [OPERATION SETTING] → [LIGHT OUTPUT]. The most recent setting is reflected in both items.

1) Press ▲▼ to select [LIGHT OUTPUT].

2) Press ◀▶ to adjust.

Operation	Adjustment		Range of adjustment
	Brightness	Runtime	
Press ▶.	The screen becomes brighter.	The runtime becomes shorter.	8.0 % - 100.0 %
Press ◀.	The screen becomes darker.	The runtime becomes longer.	

Note

- [LIGHT OUTPUT] can be adjusted individually for each setting item of [OPERATING MODE].
- In such a case when configuring multiple screens with multiple projectors, uniformity of brightness between multiple screens can be obtained by adjusting [LIGHT OUTPUT].

[BRIGHTNESS CONTROL]

The projector is equipped with a brightness sensor to measure brightness and color of the light source, and corrects brightness and white balance of the projected image according to the changes in brightness and color of the light source.

By using this function, in such a condition that multiple screens are configured using projected images of multiple projectors, you can reduce changes in overall brightness and white balance of the multiple screens due to aging of the light source and suppress variation in brightness and white balance to preserve uniformity.

Setting [BRIGHTNESS CONTROL SETUP]

Set the operation of the brightness control function.

- 1) Press ▲▼ to select [BRIGHTNESS CONTROL].
- 2) Press the <ENTER> button.
 - The [BRIGHTNESS CONTROL] screen is displayed.
- 3) Press ▲▼ to select [BRIGHTNESS CONTROL SETUP].
- 4) Press the <ENTER> button.
 - The [BRIGHTNESS CONTROL SETUP] screen is displayed.
- 5) Press ▲▼ to select [CONSTANT MODE].
- 6) Press ◀▶ to switch the item.
 - The items will switch each time you press the button.

[OFF]	Does not correct the brightness of the screen by the brightness sensor.
[AUTO]	Corrects the brightness of the screen by the brightness sensor. When the brightness of light source or white balance changes, the brightness of the projected image is automatically corrected.
[PC]	Synchronizes nine or more projectors using a computer and the dedicated software "Multi Monitoring & Control Software"*1.

*1 "Multi Monitoring & Control Software" can be downloaded from the Panasonic website (<https://panasonic.net/cns/projector/>).

- When [PC] is selected, proceed to Step 9).

- 7) Press ▲▼ to select [LINK].
- 8) Press ◀▶ to switch the item.
 - The items will switch each time you press the button.

[OFF]	Performs corrections by the brightness sensor on a single projector without synchronizing with the other projectors. The duration that the constant brightness is kept will become longer by setting the value of [LIGHT OUTPUT] smaller.
[GROUP A] [GROUP B] [GROUP C] [GROUP D]	Performs correction by the brightness sensor in multiple projectors in synchronization. Up to four groups (A to D) can be set within the same subnet by using the network function. You can register and synchronize up to eight projectors in one group.

- 9) Press ▲▼ to select [APPLY].
- 10) Press the <ENTER> button.
 - When [CONSTANT MODE] in [BRIGHTNESS CONTROL SETUP] is set to anything other than [OFF], the brightness and white balance of light source at the time when the <ENTER> button is pressed is recorded as the standard brightness and white balance.

- If the <ENTER> button is pressed when [LINK] is set from [GROUP A] to [GROUP D], the group name is displayed on the screens of projectors that have been set in the same group.



Note

- When [CONSTANT MODE] is set to [AUTO] or [PC], keep the shutter function disabled (shutter: open) for at least two minutes, since the brightness sensor calibration is performed after the [BRIGHTNESS CONTROL SETUP] setting has been completed.
- When the projector operates with [CONSTANT MODE] set to [AUTO] or [PC], the brightness and color of the light source do not stabilize for approximately eight minutes after the light source is turned on. Therefore, the brightness and color of the light source will be automatically measured after approximately eight minutes have elapsed after the light source is turned on.
- When the projector operates with [CONSTANT MODE] set to [AUTO], and [LINK] set to [OFF], the brightness will be corrected until it reaches the value set in [MAX LIGHT OUTPUT LEVEL].
- The variation in brightness may increase due to dust accumulating on the lens, screen, or inside the projector, depending on the installation environment of the projector.
- When the variation in brightness has increased due to aging of the light source, or when you replaced the light source, readjust the brightness control.

Displaying [BRIGHTNESS CONTROL STATUS]

Display the brightness control status.

- 1) Press ▲▼ to select [BRIGHTNESS CONTROL].
- 2) Press the <ENTER> button.
 - The [BRIGHTNESS CONTROL] screen is displayed.
- 3) Press ▲▼ to select [BRIGHTNESS CONTROL STATUS].
- 4) Press the <ENTER> button.
 - The [BRIGHTNESS CONTROL STATUS] screen is displayed.

[BRIGHTNESS CONTROL STATUS] screen display example

When [CONSTANT MODE] is set to [OFF]

The screen shows the status that the brightness control is disabled.

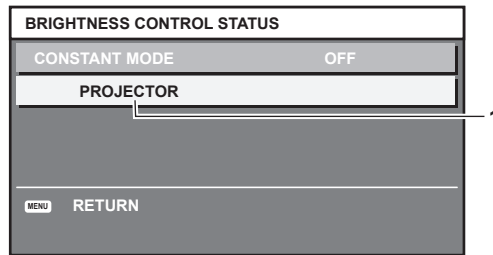

When [CONSTANT MODE] is set to [AUTO], and [LINK] is set to [OFF]

The screen shows the status of the brightness control in one projector.

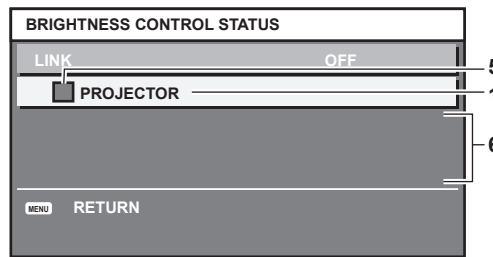

When [CONSTANT MODE] is set to [AUTO], and [LINK] is set to [GROUP A] through [GROUP D]

The screen shows the status of the brightness control of synchronized projectors (up to eight units), including the projector being controlled through the on-screen menu.

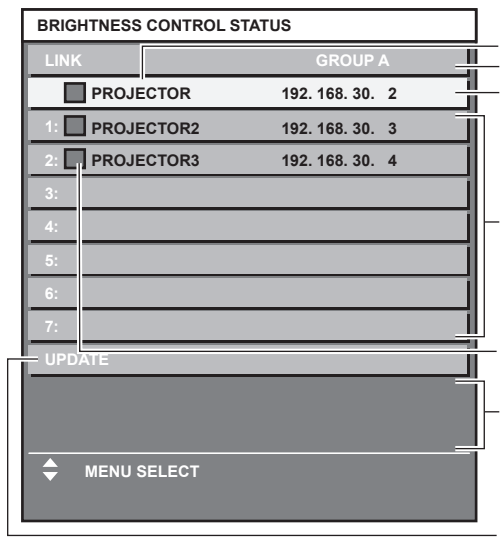

When [CONSTANT MODE] is set to [PC]

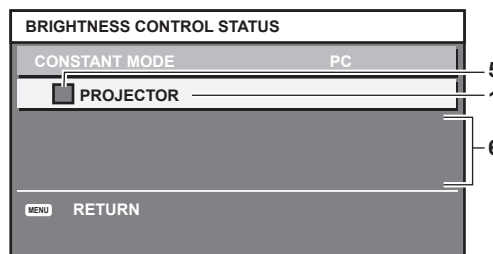

- 1 Display the name of the projector.
- 2 Display the synchronized group.
- 3 Display the IP address of the projector.
- 4 Display the names and IP addresses of projectors in same group detected over the network.

5 Display the status by color.

Green: There is an allowance for brightness correction.
 Yellow: There is little allowance for brightness correction.
 Red: There is a brightness control error.

6 Display error detailed messages.

7 Display error messages.

When the message [Failed to apply BRIGHTNESS CONTROL to some projectors.] appears, it means that synchronization with the projector displayed in red has failed.
 Press ▲▼ to select the projector displayed in red, and press the <ENTER> button to display the error details.

8 Update to the latest status information.

■ **Error details**

Error message	Measures to take
[Exceed maximum number of projectors.]	<ul style="list-style-type: none"> • Limit the number of projectors in one group to eight. • To synchronize nine or more projectors, use a PC and the dedicated software "Multi Monitoring & Control Software"^{*1}.
[Please check the COMMAND CONTROL setting.]	<ul style="list-style-type: none"> • Set [NETWORK CONTROL] → [COMMAND CONTROL] to [ON] for the projector in error. • Set [NETWORK CONTROL] → [COMMAND PORT] of all linked projectors to the same value.
[Please check the USER NAME and PASSWORD in the COMMAND CONTROL setting.]	<ul style="list-style-type: none"> • Assign same character strings for [User name] and [Password] as the web control administrator rights to all linked projectors.
[Cannot apply BRIGHTNESS CONTROL. Please check projector status.]	<ul style="list-style-type: none"> • The projector is in standby. Switch on the power.
[Brightness Sensor Error]	<ul style="list-style-type: none"> • There is a problem with the brightness sensor. If problems persist even after switching on the power, consult your dealer.

*1 "Multi Monitoring & Control Software" can be downloaded from the Panasonic website (<https://panasonic.net/cns/projector/>).

Note

- If the synchronized projectors are not displayed in the list, check the following:
 - Are there devices with the same IP address on the network?
 - Are the LAN cables connected correctly? (➡ page 188)
 - Are the subnets of the projectors the same?
 - Are the same [LINK] settings applied to a group?
- Refer to [NETWORK SETUP] (➡ page 183) or "[Network config] page" (➡ page 199) on how to change the projector name.

Brightness control adjustment procedure example

The steps exemplify an adjustment to link the brightness of eight projectors connected in a network.

- 1) Connect all projectors to the hub using LAN cables. (➡ page 188)**
- 2) Switch on all projectors and start projection.**
- 3) Set [CONSTANT MODE] of [BRIGHTNESS CONTROL SETUP] to [OFF], and select [APPLY], and then press the <ENTER> button.**
- 4) Set [OPERATING MODE] of each projector to the same setting. (➡ page 152)**
- 5) Set [SUBNET MASK] and [IP ADDRESS] in each projector.**
 - To be able to communicate over the network, set the same value in [SUBNET MASK] for all projectors and set a different value in [IP ADDRESS] for each projector.
- 6) Wait for at least eight minutes after projection has started until the light source brightness becomes steady.**
- 7) Set all items in the [PICTURE] menu of all projectors to the same values.**
- 8) Adjust [COLOR MATCHING] to match colors.**
- 9) Display the internal test pattern "All white" in all projectors.**
- 10) Set [LIGHT OUTPUT] of all projectors to 100 % or the maximum value that can be set.**
 - Depending on the [OPERATING MODE] settings, [LIGHT OUTPUT] may not be able to be set to 100 %.
- 11) Set [LIGHT OUTPUT] of the projector with the least brightness to 90 % or 10 % lower than the maximum value that can be set.**

12) Adjust [LIGHT OUTPUT] of each projector.

- Adjust [LIGHT OUTPUT] of all the other projectors so that the brightness will be the same as the projector with the least brightness.

13) Set [CONSTANT MODE] of [BRIGHTNESS CONTROL SETUP] to [AUTO], and [LINK] to [GROUP A] in all projectors.

14) Select [APPLY] of [BRIGHTNESS CONTROL SETUP] and press the <ENTER> button in all projectors.

- Brightness control starts.

Note

- Brightness is automatically corrected whenever the light source lights up by switching on/off the projector, etc.
- When the variation in brightness has increased due to aging of the light source, or when you replaced the light source, readjust the brightness control.

[STANDBY MODE]

Set the power consumption during the standby.

1) Press ▲▼ to select [STANDBY MODE].

2) Press ◀▶ to switch the item.

- The items will switch each time you press the button.

[NORMAL]	Select this item to use the network function during standby.
[ECO]	Select this item to reduce power consumption during standby.

Note

- The AC voltage monitor function, the network function, the <SERIAL OUT> terminal, and part of the RS-232C command cannot be used during the standby when set to [ECO].
When an error or warning occurs on the projector, the self-diagnosis display appears on the control panel regardless of the [STANDBY MODE] settings. (➔ page 215)
- When [ECO] is set, it may take approximately 10 seconds longer before the projector starts projecting after the power is turned on, compared with when [NORMAL] is set.
- When [NORMAL] is set, the network function and the <SERIAL OUT> terminal can be used during standby.
- When [NORMAL] is set, power can be supplied by using the <DC OUT 1> terminal or the <DC OUT 2> terminal even while the projector is in standby mode. If [ECO] is set, power cannot be supplied in standby mode.
- The [STANDBY MODE] setting does not return to factory default setting even if the [PROJECTOR SETUP] menu → [INITIALIZE] → [ALL USER DATA] is executed.

[NO SIGNAL SHUT-OFF]

A function that automatically switches the power source of the projector to standby if there is no input signal for a certain period of time. The time before switching to standby can be set.

1) Press ▲▼ to select [NO SIGNAL SHUT-OFF].

2) Press ◀▶ to switch the item.

- The items will switch each time you press the button.

[DISABLE]	Disables the No signal shut-off function.
[10MIN.] - [90MIN.]	Sets the time in increments of 10 minutes.

[NO SIGNAL LIGHTS-OUT]

This is a function to automatically turn off the light source of the projector when there is no input signal for specific period. The time until the light source is turned off can be set.

1) Press ▲▼ to select [NO SIGNAL LIGHTS-OUT].

2) Press ◀▶ to switch the item.

- The items will switch each time you press the button.

[DISABLE]	Disables the no signal lights-out function.
[10SEC.] - [5MIN.]	Turns off the light source when there is no input signal for the preset period. Select [10SEC.], [20SEC.], [30SEC.], [1MIN.], [2MIN.], [3MIN.], or [5MIN.].

Note

- The power indicator <ON (G)/STANDBY (R)> will blink slowly in green while the no signal lights-out function is operating and the light source is turned off.
- When [NO SIGNAL LIGHTS-OUT] is set to anything other than [DISABLE], the following are the conditions to turn the light source back on again from the condition that the light source has turned off by this function.
 - When the signal is input
 - When on-screen display such as menu screen (OSD) or input guide, a test pattern, or a warning message is displayed
 - When the power on <|> button is pressed
 - When the operation to disable the shutter function (shutter: open) is performed, such as pressing the <SHUTTER> button
 - When the operating environment temperature is around 0 °C (32 °F) and the light source is forced to turn on due to warm-up
- The no signal lights-out function is disabled in following cases.
 - When the [DISPLAY OPTION] menu → [BACK COLOR] is set to [DEFAULT LOGO] or [USER LOGO], and the Panasonic logo or the image registered by the user is displayed on the projected image
 - When the [SECURITY] menu → [DISPLAY SETTING] is set to [TEXT] or [USER LOGO], and the security message (text or image) registered by the user is displayed on the projected image

[INITIAL STARTUP]

Set the startup method when the <MAIN POWER> switch is set to <ON>.

- 1) Press ▲▼ to select [INITIAL STARTUP].
- 2) Press ◀▶ to switch the item.
 - The items will switch each time you press the button.

[LAST MEMORY]	Starts up the projector in the condition before the <MAIN POWER> switch is set to <OFF>.
[STANDBY]	Starts up the projector in standby.
[ON]	Starts projecting immediately.

[STARTUP INPUT SELECT]

Set the input when the projector is switched on to start projection.

- 1) Press ▲▼ to select [STARTUP INPUT SELECT].
- 2) Press the <ENTER> button.
 - The [STARTUP INPUT SELECT] screen is displayed.
- 3) Press ▲▼◀▶ to select the input, and press the <ENTER> button.

[LAST USED]	Keeps the input selected last.
[RGB1]	Sets the input to RGB1.
[RGB2]	Sets the input to RGB2.
[DVI-D]	Sets the input to DVI-D.
[HDMI]	Sets the input to HDMI.
[DIGITAL LINK]	Sets the input to DIGITAL LINK.
[SDI1]	Sets the input to SDI1.
[SDI2]	Sets the input to SDI2.
[INPUT1] - [INPUT10]*1	Sets the input to DIGITAL LINK, and switches the input of the Panasonic twisted-pair-cable transmitter to the specified input.

*1 When the optional DIGITAL LINK output supported device (Model No.: ET-YFB100G, ET-YFB200G) is connected to the projector, its input name is automatically reflected from [INPUT1] to [INPUT10]. When an item that does not reflect the input name is selected, it will be disabled.

[DATE AND TIME]

Set the time zone, date, and time of the built-in clock of the projector.

Setting the time zone

- 1) Press ▲▼ to select [DATE AND TIME].
- 2) Press the <ENTER> button.
 - The [DATE AND TIME] screen is displayed.
- 3) Press ▲▼ to select [TIME ZONE].
- 4) Press ◀▶ to switch [TIME ZONE].

Setting the date and time manually

- 1) Press ▲▼ to select [DATE AND TIME].
- 2) Press the <ENTER> button.
 - The [DATE AND TIME] screen is displayed.
- 3) Press ▲▼ to select [ADJUST CLOCK].
- 4) Press the <ENTER> button.
 - The [ADJUST CLOCK] screen is displayed.
- 5) Press ▲▼ to select an item, and press ◀▶ to set the local date and time.
- 6) Press ▲▼ to select [APPLY], and press the <ENTER> button.
 - The setting of the date and time will be completed.

Setting the date and time automatically

- 1) Press ▲▼ to select [DATE AND TIME].
- 2) Press the <ENTER> button.
 - The [DATE AND TIME] screen is displayed.
- 3) Press ▲▼ to select [ADJUST CLOCK].
- 4) Press the <ENTER> button.
 - The [ADJUST CLOCK] screen is displayed.
- 5) Press ▲▼ to select [NTP SYNCHRONIZATION], and press ◀▶ to change the setting to [ON].
- 6) Press ▲▼ to select [APPLY], and press the <ENTER> button.
 - The setting of the date and time will be completed.

Note

- To set the date and time automatically, the projector must be connected to the network.
- If synchronization with the NTP server fails just after [NTP SYNCHRONIZATION] is set to [ON], [NTP SYNCHRONIZATION] will return to [OFF]. If [NTP SYNCHRONIZATION] is set to [ON] while the NTP server is not set, [NTP SYNCHRONIZATION] will return to [OFF].
- Access the projector via a web browser to set the NTP server. Refer to “[Adjust clock] page” (➡ page 200) for details.
- The [TIME ZONE] setting is reset to the factory default when the [PROJECTOR SETUP] menu → [INITIALIZE] → [ALL USER DATA] is executed. However, the date and time based on the local date and time setting (Coordinated Universal Time, UTC, Universal Time, Coordinated) will be maintained without being initialized.
- The replacement of the battery inside the projector is required when the time goes out of alignment right after correcting the time. Consult your dealer.

[SCHEDULE]

Set the command execution schedule for each day of the week.

Enabling/disabling the schedule function

- 1) Press ▲▼ to select [SCHEDULE].
- 2) Press ◀▶ to switch the item.
 - The items will switch each time you press the button.

[OFF]	Disables the schedule function.
[ON]	Enables the schedule function. Refer to “How to assign a program” (➡ page 162) or “How to set a program” (➡ page 162) for how to set the schedule.

Note

- When [SCHEDULE] is set to [ON] while the [PROJECTOR SETUP] menu → [STANDBY MODE] is set to [ECO], the [STANDBY MODE] setting is forcibly switched to [NORMAL], and the setting cannot be changed to [ECO]. The [STANDBY MODE] setting will not return to original even if [SCHEDULE] is set to [OFF] in this condition.

How to assign a program

- 1) Press ▲▼ to select [SCHEDULE].
- 2) Press ◀▶ to select [ON], and press the <ENTER> button.
 - The [SCHEDULE] screen is displayed.
- 3) Select and assign a program to each day of week.
 - Press ▲▼ to select the day of week, and press ◀▶ to select a program number.
 - You can set the program from No.1 to No.7. “- - -” indicates that the program number has not been set.

How to set a program

Set up to 16 commands to each program.

- 1) Press ▲▼ to select [SCHEDULE].
- 2) Press ◀▶ to select [ON], and press the <ENTER> button.
 - The [SCHEDULE] screen is displayed.
- 3) Press ▲▼ to select [PROGRAM EDIT].
- 4) Press ◀▶ to select a program number, and press the <ENTER> button.
- 5) Press ▲▼ to select a command number, and press the <ENTER> button.
 - You can change the page using ◀▶.
- 6) Press ▲▼◀▶ to select [TIME], and press the <ENTER> button.
 - The projector is in the adjustment mode (the time is blinking).
- 7) Press ◀▶ to select “hour” or “minute”, and press ▲▼ or the number (<0> - <9>) buttons to set a time, and then press the <ENTER> button.
- 8) Press ▲▼◀▶ to select [COMMAND].
- 9) Press the <ENTER> button.
 - The [COMMAND] detailed screen is displayed.
- 10) Press ▲▼ to select a [COMMAND].
 - For [COMMAND] which requires detailed settings, the items of the detailed settings will switch each time you press ◀▶.
 - When [INPUT] is selected, press the <ENTER> button, and then press ▲▼◀▶ to select the input to be set.

[COMMAND]	Detailed settings of [COMMAND]	Description
[POWER ON]	—	Switches on the projector.
[STANDBY]	—	Enters standby.
[SHUTTER]	[OPEN]	Disables the shutter function (shutter: open).
	[CLOSE]	Enables the shutter function (shutter: closed).
[INPUT]	[RGB1]	Switches the input to RGB1.
	[RGB2]	Switches the input to RGB2.
	[DVI-D]	Switches the input to DVI-D.
	[HDMI]	Switches the input to HDMI.
	[DIGITAL LINK]	Switches the input to DIGITAL LINK.
	[SDI1]	Switches the input to SDI1.
	[SDI2]	Switches the input to SDI2.
	[INPUT1] - [INPUT10]*1	Switches the input to DIGITAL LINK, and switches the input of the Panasonic twisted-pair-cable transmitter to the specified input.

[COMMAND]	Detailed settings of [COMMAND]	Description
[OPERATING MODE] ^{*2}	[NORMAL]	Prioritizes luminance.
	[ECO]	Controls the power to increase the life of the light source with higher luminance.
	[USER1]	Controls the power with the setting set to [USER1].
	[USER2]	Controls the power with the setting set to [USER2].
	[USER3]	Controls the power with the setting set to [USER3].
[P IN P]	[OFF]	P IN P function is not used.
	[USER1]	Lays out the sub-screen with the settings of [USER1].
	[USER2]	Lays out the sub-screen with the settings of [USER2].
	[USER3]	Lays out the sub-screen with the settings of [USER3].

*1 When the optional DIGITAL LINK output supported device (Model No.: ET-YFB100G, ET-YFB200G) is connected to the projector, its input name is automatically reflected from [INPUT1] to [INPUT10]. When an item that does not reflect the input name is selected, it will be disabled.

*2 If you change the settings while using the projector, the duration until the light source luminance decreases by half may shorten or the luminance may decrease.

11) Press the <ENTER> button.

- The command is fixed and ● is displayed at the left of the selected command.
- After the command is fixed, press the <MENU> button to close the detailed setting screen.

12) Press ▲▼◀▶ to select [STORE], and press the <ENTER> button.

Note

- To delete a command that has been already set, press the <DEFAULT> button on the remote control while the screen in Step 5) is displayed, or select [DELETE] at the screen in Step 6) and press the <ENTER> button.
- If multiple commands have been set for the same time, they are executed in chronological order starting from the smallest command number.
- The operating time will be the local time. (➔ page 160)
- If an operation is executed with the remote control or control panel of the projector or with a control command before the command set in [SCHEDULE] is executed, the command set with the schedule function may not be executed.

[MULTI PROJECTOR SYNC]

Set the contrast synchronization function and the shutter synchronization function.

The contrast synchronization function is a function to display a combined screen with a balanced contrast by sharing the brightness level of the video signal input to each projector when a multi-display is constructed by combining the projected image of multiple projectors. The shutter synchronization function is a function to synchronize the shutter operation of the specified projector to other projectors, and the effect using the shutter function including the fade in/fade out operation can be synchronized.

To use the contrast synchronization function and the shutter synchronization function, it is necessary to connect the projectors targeted for synchronization in a loop with daisy chain connection using the <MULTI PROJECTOR SYNC IN> terminal and the <MULTI PROJECTOR SYNC OUT> terminal. For details of how to connect the projectors, refer to “Connecting example when using the contrast synchronization function/shutter synchronization function” (➔ page 56).

Note

- The contrast synchronization function and the shutter synchronization function can be used simultaneously.
- The operation of the mechanical shutter is not included in the shutter synchronization function.
- The menu items in the [PROJECTOR SETUP] menu → [MULTI PROJECTOR SYNC] are the same as the following setting items.
 - The [PICTURE] menu → [DYNAMIC CONTRAST] → [USER] → [MULTI PROJECTOR SYNC]
 - The [DISPLAY OPTION] menu → [SHUTTER SETTING] → [MULTI PROJECTOR SYNC]
- The [3D SYNC SETTING] setting is disabled and fixed to [OFF] when [MULTI PROJECTOR SYNC] → [MODE] is set to anything other than [OFF].
- The following settings are disabled and the contrast synchronization function and shutter synchronization function cannot be used when [3D SYNC SETTING] is set to anything other than [OFF].
 - The [PICTURE] menu → [DYNAMIC CONTRAST] → [USER] → [MULTI PROJECTOR SYNC]
 - The [DISPLAY OPTION] menu → [SHUTTER SETTING] → [MULTI PROJECTOR SYNC]
 - The [PROJECTOR SETUP] menu → [MULTI PROJECTOR SYNC]

Setting the contrast synchronization function

1) Press ▲▼ to select [MULTI PROJECTOR SYNC].

2) Press the <ENTER> button.

- The [MULTI PROJECTOR SYNC] screen is displayed.

3) Press ▲▼ to select [MODE].

4) Press ◀▶ to switch the item.

- The items will switch each time you press the button.

[OFF]	Select this item when the contrast synchronization function and the shutter synchronization function are not used.
[MASTER]	Select this item when the contrast synchronization function or the shutter synchronization function is used. Set this item only on one projector out of the projectors that are linked. The projector set as the [MASTER] will calculate the brightness level of the video signal to become optimum on the whole combined screen for each frame. All the projectors targeted for contrast synchronization will control the dynamic contrast function based on the calculation result.
[SLAVE]	Select this item when the contrast synchronization function or the shutter synchronization function is used. Set this item in all the linked projectors excluding the projector set as the [MASTER].

- When anything other than [OFF] is selected, the diagnostic result is displayed in [LINK STATUS], indicating if all the projectors including the projectors targeted for synchronization are correctly connected, and if [MODE] is correctly set.

[LINKED]	All the projectors are correctly connected, and correctly set. They are in the condition that the contrast synchronization function or the shutter synchronization function can be used.
[NO LINK]	The projectors are not correctly connected, or not correctly set. Check the cable connection status and the projector setting for each projector that is linked.

5) Press ▲▼ to select [CONTRAST SYNC].

6) Press ◀▶ to switch the item.

- The items will switch each time you press the button.

[OFF]	Select this item when the contrast synchronization function is not used.
[ON]	Select this item when the contrast synchronization function is used.

Note

- The contrast synchronization function will operate when all of the following conditions are fulfilled.
 - All the projectors to be linked are connected in a loop with the daisy chain connection. (Maximum 64 projectors)
 - [MODE] on only one projector that is linked is set to [MASTER], and [MODE] on all other projectors are set to [SLAVE].
 - [CONTRAST SYNC] on the projectors to perform the contrast synchronization is set to [ON].
- It is possible to set [CONTRAST SYNC] to [OFF] for the projectors that are linked but not to synchronize.

Setting the shutter synchronization function

1) Press ▲▼ to select [MULTI PROJECTOR SYNC].

2) Press the <ENTER> button.

- The [MULTI PROJECTOR SYNC] screen is displayed.

3) Press ▲▼ to select [MODE].

4) Press ◀▶ to switch the item.

- The items will switch each time you press the button.

[OFF]	Select this item when the contrast synchronization function and the shutter synchronization function are not used.
[MASTER]	Select this item when the contrast synchronization function or the shutter synchronization function is used. Set this item only on one of the linked projectors that becomes the synchronization source of the shutter operation.
[SLAVE]	Select this item when the contrast synchronization function or the shutter synchronization function is used. Set this item in all the linked projectors excluding the projector set as the [MASTER].

- When anything other than [OFF] is selected, the diagnostic result is displayed in [LINK STATUS], indicating if all the projectors including the projectors targeted for synchronization are correctly connected, and if [MODE] is correctly set.

[LINKED]	All the projectors are correctly connected, and correctly set. They are in the condition that the contrast synchronization function or the shutter synchronization function can be used.
[NO LINK]	The projectors are not correctly connected, or not correctly set. Check the cable connection status and the projector setting for each projector that is linked.

5) Press ▲▼ to select [SHUTTER SYNC].

6) Press ◀▶ to switch the item.

- The items will switch each time you press the button.

[OFF]	Select this item when the shutter synchronization function is not used.
[ON]	Select this item when the shutter synchronization function is used.

Note

- The shutter synchronization function will operate when all of the following conditions are fulfilled.
 - All the projectors to be linked are connected in a loop with the daisy chain connection. (Maximum 64 projectors)
 - [MODE] on only one projector that is linked is set to [MASTER], and [MODE] on all other projectors are set to [SLAVE].
 - [SHUTTER SYNC] on the projectors to perform the shutter synchronization is set to [ON].
- It is possible to set [SHUTTER SYNC] to [OFF] for the projectors that are linked but not to synchronize.
- The shutter operation by the shutter synchronization function will follow the setting of the [DISPLAY OPTION] menu → [SHUTTER SETTING] on the projector that [MODE] is set to [MASTER].
- When the input signal to each linked projector is not synchronized, the timing of the shutter operation between the projectors may shift up to 1 frame while using the shutter synchronization function.
- The shutter function of the projector with [MODE] set to [SLAVE] can be operated individually. The shutter operation at this time will follow the setting of the [DISPLAY OPTION] menu → [SHUTTER SETTING] set in that projector.

[RS-232C]

Set the communication conditions of the <SERIAL IN>/<SERIAL OUT> terminals. For details on the connection method for RS-232C communication, refer to “<SERIAL IN>/<SERIAL OUT> terminal” (► page 229).

Setting the communication condition of the <SERIAL IN> terminal

1) Press ▲▼ to select [RS-232C].

2) Press the <ENTER> button.

- The [RS-232C] screen is displayed.

3) Press ▲▼ to select [INPUT SELECT].

4) Press ◀▶ to switch the item.

[PROJECTOR]	Performs the RS-232C communication with the <SERIAL IN> terminal of the projector.
[DIGITAL LINK]	Performs the RS-232C communication via the optional DIGITAL LINK output supported device (Model No.: ET-YFB100G, ET-YFB200G) and the <DIGITAL LINK/LAN> terminal.

5) Press ▲▼ to select [(IN) BAUDRATE].

6) Press ◀▶ to switch the item.

- The items will switch each time you press the button.

[9600]	Select the proper speed.
[19200]	
[38400]	

7) Press ▲▼ to select [(IN) PARITY].

8) Press ◀▶ to switch the item.

- The items will switch each time you press the button.

[NONE]	Select the parity condition.
[EVEN]	
[ODD]	

Setting the communication condition of the <SERIAL OUT> terminal

- 1) Press ▲▼ to select [RS-232C].
- 2) Press the <ENTER> button.
 - The [RS-232C] screen is displayed.
- 3) Press ▲▼ to select [(OUT) BAUDRATE].
- 4) Press ◀▶ to switch the item.
 - The items will switch each time you press the button.

[9600]	Select the proper speed.
[19200]	
[38400]	

- 5) Press ▲▼ to select [(OUT) PARITY].
- 6) Press ◀▶ to switch the item.
 - The items will switch each time you press the button.

[NONE]	Select the parity condition.
[EVEN]	
[ODD]	

Setting the response

- 1) Press ▲▼ to select [RS-232C].
- 2) Press the <ENTER> button.
 - The [RS-232C] screen is displayed.
- 3) Press ▲▼ to select [RESPONSE(ID ALL)].
- 4) Press ◀▶ to switch the item.

[ON]	Returns the response when an ID is designated as ALL.
[OFF]	Does not return the response when an ID is designated as ALL.

- 5) Press ▲▼ to select [GROUP].
- 6) Press ◀▶ to switch the item.

[A] - [Z]	Controls multiple projectors simultaneously by sending the ID of RS-232C. You can set groups from [A] to [Z]. The projector responds when the ID of RS-232C matches the setting.
-----------	--

- 7) Press ▲▼ to select [RESPONSE(ID GROUP)].
- 8) Press ◀▶ to switch the item.

[ON]	Returns the response when an ID is designated as GROUP.
[OFF]	Does not return the response when an ID is designated as GROUP.

Note

- When [INPUT SELECT] is set to [DIGITAL LINK], communication using that serial terminal can be used only when the corresponding device (such as the optional DIGITAL LINK output supported device (Model No.: ET-YFB100G, ET-YFB200G)) is connected to the <DIGITAL LINK/LAN> terminal.
- When transferring logos via the optional DIGITAL LINK output supported device (Model No.: ET-YFB100G, ET-YFB200G), setting for "NO SIGNAL SLEEP" of the DIGITAL LINK output supported device should be set to "OFF" to avoid interruption of communication.
- When [INPUT SELECT] is set to [DIGITAL LINK], communication speed for input is fixed to 9 600 bps and the parity is fixed to "NONE".

[REMOTE2 MODE]

You can set the <REMOTE 2 IN> terminal.

- 1) Press ▲▼ to select [REMOTE2 MODE].
- 2) Press ◀▶ to switch the item.
 - The items will switch each time you press the button.

[DEFAULT]	Uses pin assignment of the <REMOTE 2 IN> terminal in standard setting. (➡ page 233)
[USER]	Changes the setting of the <REMOTE 2 IN> terminal.

- When [USER] is selected, proceed to Step 3).

- 3) Press the <ENTER> button.
- 4) Press ▲▼ to select one from [PIN2] to [PIN8], and press ◀▶ to switch the setting.

[FUNCTION BUTTON]

Set the function of the <FUNCTION> button on the remote control.

- 1) Press ▲▼ to select [FUNCTION BUTTON].
- 2) Press the <ENTER> button.
 - The [FUNCTION BUTTON] screen is displayed.
- 3) Press ▲▼ to select a function.

[DISABLE]	Disables the <FUNCTION> button.
[P IN P]	Switches the [P IN P] setting ([OFF], [USER1], [USER2], or [USER3]). (➡ page 172)
[SUB MEMORY]	Displays the sub memory list. (➡ page 177)
[SYSTEM SELECTOR]	Switches the [SYSTEM SELECTOR] setting according to the input signal of the image being projected. <ul style="list-style-type: none"> • When the input signal is anything other than SDI1 input or SDI2 input The [PICTURE] menu → [SYSTEM SELECTOR] (➡ page 98) • When the input signal is SDI1 input or SDI2 input <ul style="list-style-type: none"> - The [DISPLAY OPTION] menu → [SDI IN] → [SINGLE LINK SETTING] → [SDI1]/[SDI2] → [SYSTEM SELECTOR] (➡ page 129) - The [DISPLAY OPTION] menu → [SDI IN] → [DUAL LINK SETTING] → [SYSTEM SELECTOR] (➡ page 129)
[SYSTEM DAYLIGHT VIEW]	Switches the [SYSTEM DAYLIGHT VIEW] setting. (➡ page 95)
[FREEZE]	Temporarily pauses the image. (➡ page 136)
[WAVEFORM MONITOR]	Displays the waveform of the input signal. (➡ page 136)
[LENS MEMORY LOAD]	Loads the registered lens memory. (➡ page 142)
[LEFT/RIGHT SWAP]	Switches the [LEFT/RIGHT SWAP] setting. (➡ page 113)
[PROJECTION METHOD]	Switches the [PROJECTION METHOD] setting. (➡ page 139)

- 4) Press the <ENTER> button.

[STATUS]

Display the status of the projector.

- 1) Press ▲▼ to select [STATUS].
- 2) Press the <ENTER> button.
 - The [STATUS] screen is displayed.
- 3) Press ◀▶ to switch the pages.
 - The page will change each time you press the button.

[PROJECTOR TYPE]	Displays the type of the projector.
[SERIAL NUMBER]	Displays the serial number of the projector.
[PROJECTOR RUNTIME]	Displays the runtime of the projector.
[LIGHT RUNTIME]	Displays the runtime of the light source 1 and the light source 2.
[CONTINUOUS LIGHTING TIME]	Displays the elapsed time from when the light source is illuminated. The elapsed time after the illumination of the light source can be confirmed when adjusting the focus. The elapsed time is reset when the light source is temporarily turned off such as using the shutter function.

Chapter 4 Settings — [PROJECTOR SETUP] menu

[MAIN/SUB VERSION]	Displays the main and sub versions of the firmware of the projector.	
[INTAKE AIR TEMP.] ^{*1}	Displays the status of the intake air temperature of the projector.	
[OPTICS MODULE TEMP.] ^{*1}	Displays the status of the internal temperature of the projector.	
[EXHAUST AIR TEMP.] ^{*1}	Displays the status of the exhaust air temperature of the projector.	
[LIGHT1 TEMP.] ^{*1}	Displays the light source 1 temperature status of the projector.	
[LIGHT2 TEMP.] ^{*1}	Displays the light source 2 temperature status of the projector.	
[SELF TEST]	Displays the status of the projector.	
[INPUT]	Displays the input terminal currently selected. Displays the representative input terminal when one image is displayed with multiple input signals.	
[SIGNAL NAME]	Displays the input signal name.	
[MEMORY NO.]	Displays the memory number of the input signal.	
[BACKUP INPUT STATUS]	Displays whether switching to the backup input signal is possible or not when [BACKUP INPUT MODE] is set to [OFF]. (➔ page 120)	
[NUMBER OF REGISTERED SIGNAL]	Displays the number of registered signals.	
[COOLING CONDITION]	Displays the set cooling conditions.	
[ATMOSPHERIC PRESSURE]	Displays the atmospheric pressure.	
[REMOTE2 STATUS]	Displays the control status of the REMOTE2.	
[AC VOLTAGE]	Displays the input supply voltage.	
[LENS TYPE] ^{*2}	Displays the type name (type of the projection lens) set to the projection lens.	
[LENS ID] ^{*2}	Displays the ID set to the projection lens.	
[LENS NAME] ^{*2}	Displays the name set to the projection lens.	
[LENS THROW RATIO] ^{*2}	Displays the range of throw ratio supported by the projection lens in accordance with the [LENS TYPE] setting.	
[LENS ZOOM TYPE] ^{*2}	Displays the drive method of the zoom motor attached to the projection lens.	
[ZOOM CALIBRATION] ^{*2}	Displays the zoom calibration result ([OK]/[FAILED]) and the calibration date.	
[ON COUNT]	[POWER ON TIMES]	Displays the number of times the power is turned on.
	[MECHANICAL SHUTTER]	Displays the number of times the mechanical shutter is closed. It is counted when [MECHANICAL SHUTTER] is set to [ENABLE].
[OPERATING MODE]	Displays the setting value of the [PROJECTOR SETUP] menu → [OPERATION SETTING] → [OPERATING MODE].	
[NORMAL]	Displays the runtime of the light source with [OPERATING MODE] set to [NORMAL].	
[ECO]	Displays the runtime of the light source with [OPERATING MODE] set to [ECO].	
[USER1]	Displays the runtime of the light source with [OPERATING MODE] set to [USER1].	
[USER2]	Displays the runtime of the light source with [OPERATING MODE] set to [USER2].	
[USER3]	Displays the runtime of the light source with [OPERATING MODE] set to [USER3].	
[CONSOLIDATED RUNTIME] ^{*3}	Converts the total runtime of the light sources with [OPERATING MODE] set to each item into the time used with the [NORMAL] setting. The converted runtime is used for a rough indication about when to perform maintenance when the projector is used in combination of each item in [OPERATING MODE].	
[UPGRADE KIT]	[ET-UK20]	Displays the activation status by the Upgrade Kit (Model No.: ET-UK20).
	[ET-CUK10]	Displays the activation status by the Auto Screen Adjustment Upgrade Kit (Model No.: ET-CUK10).
[SIGNAL INFORMATION]	[INPUT]	Displays the input terminal used for the projected image. Displays the representative input terminal when one image is displayed with multiple input signals.
	[SIGNAL FORMAT]	Displays the format of the input signal.
	[LINK]	Displays the [SDI LINK] setting. Displays the determination result of the signal when set to [AUTO].
	[2D/3D]	Displays the determination results of the 2D/3D display
	[SIMUL]	Displays the [SIMUL INPUT SETTING] setting. Displays the determination result of the signal when set to [AUTO(3D)] or [AUTO(2D)].
	[COLOR FORMAT]	Displays the color format of the input signal.
	[SAMPLING]	Displays the sampling information of the input signal.
	[BIT DEPTH]	Displays the gradation of the input signal.
	[SIGNAL LEVEL]	Displays the signal level of the input signal.

[DETAILED INFORMATION]	[INPUT]	Displays the input terminal used for the projected image.
	[SIGNAL FORMAT]	Displays the format of the input signal.
	[SIGNAL FREQUENCY]	Displays the frequency of the input signal.
	[SCAN TYPE]	Displays the scan type of the input signal.
	[TOTAL DOTS]	Displays the total dot count of the input signal.
	[DISPLAY DOTS]	Displays the number of input signal display dots.
	[TOTAL LINES]	Displays the total line count of the input signal.
	[DISPLAY LINES]	Displays the number of input signal display lines.
	[COLOR FORMAT]	Displays the color format of the input signal.
	[SAMPLING]	Displays the sampling information of the input signal.
	[BIT DEPTH]	Displays the gradation of the input signal.
	[SIGNAL LEVEL]	Displays the signal level of the input signal.
	[HDCP STATUS]	Displays the HDCP status of the input signal. The content of display is as follows. [PROTECTED]: When protected with HDCP [NONE]: When not protected with HDCP [—]: When there is no signal

- *1 The temperature status is indicated with text color (green/yellow/red) and bar scale. Use the projector within the range that the indication is green.
- *2 This is displayed only when the standard DC motor unit installed in the Zoom Lens (Model No.: ET-D75LE6, ET-D75LE8, ET-D75LE10, ET-D75LE20, ET-D75LE30, ET-D75LE40, etc.) is replaced with the stepping motor unit using the Stepping Motor Kit (Model No.: ET-D75MKS10), or when a projection lens with the stepping motor is attached.
- *3 [CONSOLIDATED RUNTIME] can be obtained with the following calculation formula. Values obtained by the calculation formula contain a slight error.

Conversion formula for [CONSOLIDATED RUNTIME]
A x 1.0 + B x 0.8
<ul style="list-style-type: none"> • A: Runtime of the light source with [OPERATING MODE] set to [NORMAL], [USER1], [USER2], or [USER3] • B: Runtime of the light source with [OPERATING MODE] set to [ECO]

Note

- The content of the status can be sent to the E-mail address (up to two addresses) set in “[E-mail set up] page” (➔ page 201) when the <ENTER> button is pressed while displaying the pages 1/6 to 5/6 of the [STATUS] screen.
- The detailed information of the input signal is displayed when the <ENTER> button is pressed while displaying the page 6/6 of the [STATUS] screen. Information for multiple input signals may be displayed depending on the projected image. Press ◀▶ to switch pages.
- There are items that are displayed or not displayed in [SIGNAL INFORMATION] and [DETAILED INFORMATION] depending on the setting or the input signal.
- If any abnormality has occurred on the projector, press the <DEFAULT> button while the [STATUS] screen is displayed to display the detail screen of the error information.
- For details on the contents displayed in [SELF TEST], refer to “Self-diagnosis display” (➔ page 215).

[AC VOLTAGE MONITOR]

Enable or disable the AC voltage monitor function. The value of input supply voltage is displayed on the self-diagnosis display at the side of the projector when enabled.

- 1) Press ▲▼ to select [AC VOLTAGE MONITOR].
- 2) Press ◀▶ to switch the item.
 - The items will switch each time you press the button.

[OFF]	Disables the AC voltage monitor function.
[ON]	Enables the AC voltage monitor function.

Note

- When [ON] is set, the value of the input supply voltage is always displayed in the self-diagnosis display while the main power of the projector is turned on.
- Even when [OFF] is set, the value of input supply voltage can be displayed temporarily in the self-diagnosis display by operating the button on the remote control. (➔ page 83)
- The value of input supply voltage cannot be displayed in the self-diagnosis display during standby when the [PROJECTOR SETUP] menu → [STANDBY MODE] (➔ page 159) is set to [ECO].

[SAVE ALL USER DATA]

Save the various setting values as a backup in the built-in memory of the projector.

- 1) Press ▲▼ to select [SAVE ALL USER DATA].

- 2) Press the <ENTER> button.
 - The [SECURITY PASSWORD] screen is displayed.
- 3) Enter a security password and press the <ENTER> button.
 - The confirmation screen is displayed.
- 4) Press ◀▶ to select [OK], and press the <ENTER> button.
 - [PROGRESS] is displayed while saving data.

Note

- Data set from the computer application is not included in [ALL USER DATA].
- The data saved by executing [SAVE ALL USER DATA] is not deleted even if the [PROJECTOR SETUP] menu → [INITIALIZE] → [ALL USER DATA] is executed.

[LOAD ALL USER DATA]

Load the various setting values saved as a backup in the built-in memory of the projector.

- 1) Press ▲▼ to select [LOAD ALL USER DATA].
- 2) Press the <ENTER> button.
 - The [SECURITY PASSWORD] screen is displayed.
- 3) Enter a security password and press the <ENTER> button.
 - The confirmation screen is displayed.
- 4) Press ◀▶ to select [OK], and press the <ENTER> button.

Note

- The projector enters the standby mode to reflect the setting values when [LOAD ALL USER DATA] is executed.
- Data registered from a computer is not included in [ALL USER DATA].

[INITIALIZE]

Return various setting values to their factory default settings.

- 1) Press ▲▼ to select [INITIALIZE].
- 2) Press the <ENTER> button.
 - The [SECURITY PASSWORD] screen is displayed.
- 3) Enter a security password and press the <ENTER> button.
 - The [INITIALIZE] screen is displayed.
- 4) Press ▲▼ to select an item to initialize.

[ALL USER DATA]	Returns all setting values including [REGISTERED SIGNAL], [NETWORK/E-MAIL], [LOGO IMAGE], and [UNIFORMITY] to the factory default settings. The projector enters the standby mode to reflect the setting values.
[REGISTERED SIGNAL]	Deletes all the setting values saved for each input signal. To delete only a part of a registered signal, perform the procedure described in “Deleting the registered signal” (▶ page 175).
[NETWORK/E-MAIL]	Returns [NETWORK SETUP] and [E-mail set up] to factory default settings.
[LOGO IMAGE]	Deletes the image registered in [USER LOGO].
[UNIFORMITY]	Returns [UNIFORMITY] to factory default setting.

- 5) Press the <ENTER> button.
 - The confirmation screen is displayed.
- 6) Press ◀▶ to select [OK], and press the <ENTER> button.

Note

- The security password is the password set in the [SECURITY] menu → [SECURITY PASSWORD CHANGE].
Initial password of the factory default setting: ▲▶▼◀▲▶▼◀
- The following settings are not initialized even if [ALL USER DATA] is executed.
 - The [PROJECTOR SETUP] menu → [OPERATION SETTING] → [OPERATING MODE]
 - The [PROJECTOR SETUP] menu → [OPERATION SETTING] → [MAX LIGHT OUTPUT LEVEL]

- The [PROJECTOR SETUP] menu → [STANDBY MODE]
- The [PROJECTOR SETUP] menu → [LENS] → [ACTIVE FOCUS OPTIMIZER] → [FOCUS OFFSET BRIGHT] and [FOCUS OFFSET DARK]
- When a projection lens equipped with EEPROM is attached, following setting will not return to factory default setting even if [ALL USER DATA] is executed.
 - The [PROJECTOR SETUP] menu → [LENS] → [LENS TYPE]
 - The [PROJECTOR SETUP] menu → [LENS] → [LENS INFORMATION SETTING] → [LENS ID] and [LENS NAME]
- To initialize the setting values of [FOCUS OFFSET BRIGHT] and [FOCUS OFFSET DARK] in the [PROJECTOR SETUP] menu → [LENS] → [ACTIVE FOCUS OPTIMIZER], execute the [PROJECTOR SETUP] menu → [LENS] → [FOCUS OFFSET SETUP] → [INITIALIZE].
- If [ALL USER DATA] is executed, the **[INITIAL SETTING]** screen is displayed when the projection is started the next time.

[SERVICE PASSWORD]

This function is used by a service person.

[P IN P] menu

On the menu screen, select [P IN P] from the main menu, and select an item from the sub-menu. Refer to “Navigating through the menu” (➔ page 85) for the operation of the menu screen.

Using P IN P function

Locate a separate, small sub screen in the main screen to project two images simultaneously.

- 1) Press ▲▼ to select [P IN P MODE].
- 2) Press the <ENTER> button.
 - The [P IN P MODE] screen is displayed.
- 3) Press ▲▼ to select a function.

[OFF]	P IN P function is not used.
[USER1]	The items set in “Setting P IN P function” (➔ page 172) are used in P IN P function.
[USER2]	
[USER3]	

- 4) Press the <ENTER> button.

Setting P IN P function

P IN P function settings can be saved to [USER1], [USER2], and [USER3].

- 1) Press ▲▼ to select [P IN P MODE].
- 2) Press the <ENTER> button.
 - The [P IN P MODE] screen is displayed.
- 3) Press ▲▼ to select the desired mode from [USER1], [USER2], and [USER3], and press the <ENTER> button.
- 4) Press ▲▼ to select [MAIN WINDOW] or [SUB WINDOW], and press the <ENTER> button.
- 5) Press ▲▼ to select the input terminal to be displayed in the window, and press the <ENTER> button.
- 6) Press ▲▼ to select an item.

[SIZE]	Set the window display size between 10 % and 100 %.
[POSITION]	Set the display position of the window within the screen.
[CLOCK PHASE]	When the sub window is input from the <RGB 1 IN> terminal or the <RGB 2 IN> terminal and a flickering image or smeared outline appears, set between 0 and +31.

- 7) If [SIZE] is selected in Step 6), press the <ENTER> button.
 - The sub-menu is displayed.
- 8) Press ▲▼ to select an item.
- 9) Press ◀▶ to make adjustment, and press the <MENU> button.
- 10) If [POSITION] is selected in Step 6), press the <ENTER> button.
- 11) Press ▲▼◀▶ to adjust the position, and press the <MENU> button.
- 12) If [CLOCK PHASE] is selected in Step 6), press ◀▶ to make adjustment.
- 13) Press ▲▼ to select [FRAME LOCK].
- 14) Press ◀▶ to switch the item.

[MAIN WINDOW]	Set frame lock to the input signal set in the main window.
[SUB WINDOW]	Set frame lock to the input signal set in the sub window.

- 15) Press ▲▼ to select [TYPE].

16) Press ◀▶ to switch the item.

[MAIN WINDOW]	The main window has display priority.
[SUB WINDOW]	The sub window has display priority.

Note

- The P IN P function may not be available for some signals being input or terminals being selected. Refer to “Two-window display combination list” (➔ page 236) for details.
- Images in combination of DIGITAL LINK and other inputs cannot be displayed in P IN P.
- The main window setting values are applied as image adjustment values such as the [PICTURE] menu → [PICTURE MODE]/[GAMMA]/[COLOR TEMPERATURE].
- While in the normal screen (where no menu is displayed), press ◀▶ to switch the sizes and positions of the main window and sub window while P IN P is operating.
- [P IN P] cannot be set when the [ADVANCED MENU] menu → [FRAME RESPONSE] is set to anything other than [NORMAL].
- [P IN P] cannot be set when the [DISPLAY OPTION] menu → [BACKUP INPUT SETTING] → [BACKUP INPUT MODE] is set to anything other than [OFF].
- [P IN P] cannot be set when the [DISPLAY OPTION] menu → [IMAGE ROTATION] is set to anything other than [OFF].
- 3D images cannot be displayed while in P IN P.
- [P IN P] cannot be set when the [DISPLAY OPTION] menu → [SIMUL INPUT SETTING] is set to anything other than [OFF].
- [P IN P] cannot be set when the [DISPLAY OPTION] menu → [SDI IN] → [SDI LINK] is set to [AUTO].

[TEST PATTERN] menu

On the menu screen, select [TEST PATTERN] from the main menu.

Refer to “Navigating through the menu” (➔ page 85) for the operation of the menu screen.

[TEST PATTERN]

Display the test pattern built-in to the projector.

Settings of position, size, and other factors will not be reflected in test patterns. Make sure to display the input signal before performing various adjustments.

1) Press ◀▶ to switch the [TEST PATTERN] item.

- The items will switch each time you press the button.

Menu screen + All white	Displays a test pattern with the menu screen. Select a desired test pattern.
Menu screen + All black	
Menu screen + Window	
Menu screen + Window (inversion)	
Menu screen + Color bar (vertical)	
Menu screen + Color bar (horizontal)	
Menu screen + 16:9/4:3 aspect frame	
Menu screen + Cross hatch	
Menu screen + Focus	
Menu screen + Input screen	Displays the menu screen and input signal. Built-in test patterns are not displayed.

Note

- Press the <ON SCREEN> button on the remote control while the test pattern is displayed to hide the menu screen.
- It is recommended to perform the focus adjustment after 30 minutes have elapsed with the focus test pattern displayed. To use the active focus optimizer function, set the [PROJECTOR SETUP] menu → [LENS] → [ACTIVE FOCUS OPTIMIZER] → [ACTIVE FOCUS] to [ON], and then adjust the focus. (➔ page 145)

Changing the color of the cross hatch test pattern

The color can be changed when the “Menu screen + Cross hatch” test pattern is displayed.

1) Press ◀▶ to select the “Menu screen + Cross hatch” test pattern.

2) Press the <ENTER> button.

- The [TEST PATTERN COLOR] screen is displayed.

3) Press ▲▼ to select a color, and press the <ENTER> button.

- The color of the cross hatch test pattern is changed to the selected color.

Note

- The test pattern color settings return to [WHITE] when the projector is switched off.
- Colors of the test patterns other than cross hatch test patterns cannot be changed.

[SIGNAL LIST] menu

On the menu screen, select [SIGNAL LIST] from the main menu.

Refer to “Navigating through the menu” (➔ page 85) for the operation of the menu screen.

■ Registered signal details

Memory number: A1 (1-2)



When the address number (A1, A2, ... L7, L8) signal is registered

- A name can be set for each sub memory (➔ page 177).

Registering new signals

After a new signal is input and the <MENU> button on the remote control or the control panel is pressed, the registration is completed and the [MAIN MENU] screen is displayed.

- A 3D icon is displayed at the right of the [REGISTERED SIGNAL LIST] screen when a signal is registered as 3D signal.



Note

- Up to 96 signals, including sub memories, can be registered to the projector.
- There are 12 pages (eight memories of A through L, with eight memories possible on each page) for memory numbers, and the signal is registered to the lowest number that is available. If there is no available memory number it will be overwritten from the oldest signal.
- The name to be registered is automatically determined by the input signal.
- If a menu is being displayed, the new signals will be registered at the instant they are input.

Renaming the registered signal

Registered signals can be renamed.

- 1) Press ▲▼◀▶ to select the signal of which name is to be changed.
- 2) Press the <ENTER> button.
 - The [REGISTERED SIGNAL STATUS] screen is displayed.
 - The memory number, input terminal, input signal name, frequency, synch polarity, etc., are displayed.
 - Press the <MENU> button to return to the [REGISTERED SIGNAL LIST] screen.
- 3) Press the <ENTER> button.
 - The [REGISTERED SIGNAL SETUP] screen is displayed.
- 4) Press ▲▼ to select [SIGNAL NAME CHANGE].
- 5) Press the <ENTER> button.
 - The [SIGNAL NAME CHANGE] screen is displayed.
- 6) Press ▲▼◀▶ to select the text, and press the <ENTER> button to enter the text.
- 7) After the name is changed, press ▲▼◀▶ to select [OK], and press the <ENTER> button.
 - The registration is completed and the [REGISTERED SIGNAL SETUP] screen returns.
 - When pressing ▲▼◀▶ to select [CANCEL] and pressing the <ENTER> button, the changed signal name will not be registered and an automatically registered signal name will be used.

Deleting the registered signal

Registered signals can be deleted.

- 1) Press ▲▼◀▶ to select the signal to delete.
- 2) Press the <DEFAULT> button on the remote control.
 - The [REGISTERED SIGNAL DELETE] screen is displayed.

- To cancel the deletion, press the <MENU> button to return to the [REGISTERED SIGNAL LIST] screen.

3) Press the <ENTER> button.

- The selected signal will be deleted.

Note

- A registered signal can also be deleted from [REGISTERED SIGNAL DELETE] on the [REGISTERED SIGNAL SETUP] screen.

Protecting the registered signal

1) Press ▲▼◀▶ to select the signal to protect.

2) Press the <ENTER> button.

- The [REGISTERED SIGNAL STATUS] screen is displayed.

3) Press the <ENTER> button.

- The [REGISTERED SIGNAL SETUP] screen is displayed.

4) Press ▲▼ to select [LOCK].

5) Press ◀▶ to switch the item.

- The items will switch each time you press the button.

[OFF]	The signal is not protected.
[ON]	The signal is protected.

- A lock icon is displayed at the right of the [REGISTERED SIGNAL LIST] screen when [LOCK] is set to [ON].



Note

- When [LOCK] is set to [ON], signal deletion, image adjustment, and automatic setup are not available. To perform these operations, set [LOCK] to [OFF].
- A signal can be registered to the sub memory even if it is protected.
- Even a protected signal will be deleted if [INITIALIZE] is executed.

Expanding signal lock-in range

1) Press ▲▼◀▶ to select the signal to set.

2) Press the <ENTER> button.

- The [REGISTERED SIGNAL STATUS] screen is displayed.

3) Press the <ENTER> button.

- The [REGISTERED SIGNAL SETUP] screen is displayed.

4) Press ▲▼ to select [LOCK-IN RANGE].

5) Press ◀▶ to switch the item.

- The items will switch each time you press the button.

[NARROW]	Select in most cases.
[WIDE]	Widens the lock-in range.

- An expansion icon is displayed at the right of the [REGISTERED SIGNAL LIST] screen when [LOCK-IN RANGE] is set to [WIDE].



Note

- Switch the range where the signal to be input is determined to be the same signal as the already registered signal.
- To prioritize the determination that a signal is the same as the already registered signal, set this function to [WIDE].
Use in cases such as when the synchronizing frequency of a signal to be input has changed slightly, or multiple signal lists are registered.

- This function can be used only when a signal is input from the <RGB 1 IN> terminal, the <RGB 2 IN> terminal, <DVI-D IN> terminal, the <HDMI IN> terminal, or the <DIGITAL LINK/LAN> terminal.
- When [WIDE] is set, the image may be distorted because a signal is recognized as the same even if its synchronizing frequency varies slightly.
- When a signal to be input corresponds to multiple signals set in [WIDE], a registered signal with a high memory number receives priority. Example: a signal to be input that corresponds to memory numbers A2, A4 and B1 will be determined to be B1.
- When a registration signal is deleted, the settings are also deleted.
- In an environment where multiple types of signals are input to the same terminal, signals are sometimes not determined correctly when the setting is set to [WIDE].

Sub memory

The projector has a sub memory function that can register the multiple image adjustment data, even if it is recognized as the same signal by the frequency or format of the synchronization signal source.

Use this function when you need to switch the aspect or adjust the picture quality such as the white balance while using the same signal source. The sub memory includes all the data that can be adjusted for each signal, such as the screen aspect ratio and data adjusted in the [PICTURE] item (such as [CONTRAST], [BRIGHTNESS]).

Registering to the sub memory

- 1) **While in the normal screen (where no menu is displayed), press ◀▶.**
 - The sub memory registration screen is displayed if the sub memory is not registered. Proceed to Step 3).
 - A list of sub memories registered to the signal currently input is displayed.
 - The <FUNCTION> button on the remote control can be used instead of the ◀▶ button when [SUB MEMORY] is selected from the [PROJECTOR SETUP] menu → [FUNCTION BUTTON].
- 2) **Press ▲▼◀▶ to select the sub memory number to register in [SUB MEMORY LIST].**
- 3) **Press the <ENTER> button.**
 - The [SIGNAL NAME CHANGE] screen is displayed.
- 4) **Press ▲▼◀▶ to select [OK], and press the <ENTER> button.**
 - To rename the registered signal, follow the procedure in Steps 6) and 7) in “Renaming the registered signal” (➔ page 175).

Switching to the sub memory

- 1) **While in the normal screen (where no menu is displayed), press ◀▶.**
 - A list of sub memories registered to the signal currently input is displayed.
- 2) **Press ▲▼◀▶ to select the signal to switch in [SUB MEMORY LIST].**
- 3) **Press the <ENTER> button.**
 - This switches to the signal selected in Step 2).

Deleting the sub memory

- 1) **While in the normal screen (where no menu is displayed), press ◀▶.**
 - The [SUB MEMORY LIST] screen is displayed.
- 2) **Press ▲▼◀▶ to select the sub memory to be deleted, and press the <DEFAULT> button on the remote control.**
 - The [REGISTERED SIGNAL DELETE] screen is displayed.
 - To cancel the deletion, press the <MENU> button to return to the [SUB MEMORY LIST] screen.
- 3) **Press the <ENTER> button.**
 - The selected sub memory will be deleted.

[SECURITY] menu

On the menu screen, select [SECURITY] from the main menu, and select an item from the sub-menu. Refer to “Navigating through the menu” (➔ page 85) for the operation of the menu screen.

- When the projector is used for the first time
Initial password: Press ▲▶▼◀▲▶▼◀ in order, and press the <ENTER> button.

Attention

- When you select the [SECURITY] menu and press the <ENTER> button, entering a password is prompted. Enter the preset password and then continue operations of the [SECURITY] menu.
- When the password has been changed previously, enter the changed password, and press the <ENTER> button.

Note

- The entered password is displayed with * marks on the screen.
- An error message is displayed on the screen when the entered password is incorrect. Re-enter the correct password.

[SECURITY PASSWORD]

Display the [SECURITY PASSWORD] screen when the power is turned on with the <MAIN POWER> switch set to the <OFF> side. When the entered password is incorrect, the operation will be restricted to the power standby <⏻> button, the <SHUTTER> button, and the <LENS> buttons (<FOCUS>, <ZOOM>, <SHIFT>).

- 1) Press ▲▼ to select [SECURITY PASSWORD].
- 2) Press ◀▶ to switch the item.
 - The items will switch each time you press the button.

[OFF]	Disables the security password entry.
[ON]	Enables the security password entry.

Note

- [SECURITY PASSWORD] is set to [OFF] as the factory default setting or when the [PROJECTOR SETUP] menu → [INITIALIZE] → [ALL USER DATA] is executed.
- Change the password periodically that is hard to guess.
- The security password is enabled after setting [SECURITY PASSWORD] to [ON] and turning the <MAIN POWER> switch to <OFF>.

[SECURITY PASSWORD CHANGE]

Change the security password.

- 1) Press ▲▼ to select [SECURITY PASSWORD CHANGE].
- 2) Press the <ENTER> button.
 - The [SECURITY PASSWORD CHANGE] screen is displayed.
- 3) Press ▲▼◀▶ and the number (<0> - <9>) buttons to set the password.
 - Up to eight button operations can be set.
- 4) Press the <ENTER> button.
- 5) Re-enter the password for the confirmation.
- 6) Press the <ENTER> button.

Note

- The entered password is displayed with * marks on the screen.
- When numerical values are used for the security password, the security password is required to be initialized if the remote control is lost. Consult your dealer for the method of initialization.

[DISPLAY SETTING]

Overlap the security message (text or image) over the projecting image.

- 1) Press ▲▼ to select [DISPLAY SETTING].

2) Press ◀▶ to switch the item.

- The items will switch each time you press the button.

[OFF]	Hides the security message.
[TEXT]	Displays the text set in the [SECURITY] menu → [TEXT CHANGE].
[USER LOGO]	Displays the image registered by the user.

Note

- To create and register the [USER LOGO] image, use “Logo Transfer Software”. The software can be downloaded from the Panasonic website (<https://panasonic.net/cns/projector/>).

[TEXT CHANGE]

Edit the text to be displayed when [TEXT] is selected in [DISPLAY SETTING].

- 1) Press ▲▼ to select [TEXT CHANGE].
- 2) Press the <ENTER> button.
 - The [TEXT CHANGE] screen is displayed.
- 3) Press ▲▼◀▶ to select the text, and press the <ENTER> button to enter the text.
- 4) Press ▲▼◀▶ to select [OK], and press the <ENTER> button.
 - The text is changed.

[CONTROL DEVICE SETUP]

Enable/disable the button operations on the control panel and the remote control.

- 1) Press ▲▼ to select [CONTROL DEVICE SETUP].
- 2) Press the <ENTER> button.
 - The [CONTROL DEVICE SETUP] screen is displayed.
- 3) Press ▲▼ to select [CONTROL PANEL] or [REMOTE CONTROL].

[CONTROL PANEL]	You can set the limitation on the control from the control panel.
[REMOTE CONTROL]	You can set the limitation on the control from the remote control.

- 4) Press the <ENTER> button.
 - The [CONTROL PANEL] screen or the [REMOTE CONTROL] screen is displayed.
- 5) Press ▲▼ to select [CONTROL PANEL] or [REMOTE CONTROL].
- 6) Press ◀▶ to switch the item.
 - You can set the operation restriction from the control panel or the remote control.

[ENABLE]	Enables all button operations.
[DISABLE]	Disables all button operations.
[USER]	Operation of all buttons can be enabled/disabled separately. Refer to “Enabling/disabling any button” (➡ page 179) for details.

- 7) Press ▲▼ to select [APPLY], and press the <ENTER> button.
 - The confirmation screen is displayed.
- 8) Press ◀▶ to select [OK], and press the <ENTER> button.

Enabling/disabling any button

- 1) Press ▲▼ to select [CONTROL DEVICE SETUP].
- 2) Press the <ENTER> button.
 - The [CONTROL DEVICE SETUP] screen is displayed.
- 3) Press ▲▼ to select [CONTROL PANEL] or [REMOTE CONTROL].

- 4) Press the <ENTER> button.
 - The [CONTROL PANEL] screen or the [REMOTE CONTROL] screen is displayed.
- 5) Press ▲▼ to select [CONTROL PANEL] or [REMOTE CONTROL].
- 6) Press ◀▶ to switch [USER].
- 7) Press ▲▼ to select the button item to set.
 - When [INPUT SELECT BUTTON] is selected, press the <ENTER> button, and then press ▲▼ to select the button to set.

	Buttons that can be set	
	[CONTROL PANEL]	[REMOTE CONTROL]
[POWER BUTTON]	Power standby <⏻> button, power on < > button	
[INPUT SELECT BUTTON]	<RGB1> button, <RGB2> button, <DVI-D> button, <HDMI> button, <DIGITAL LINK> button, <SDI 1/2> button	<RGB1> button, <RGB2> button, <VIDEO> button, <S-VIDEO Y/C> button, <DVI-D> button, <HDMI> button, <DIGITAL LINK> button, <SDI> button, <INPUT MENU> button
[MENU BUTTON]	<MENU> button	
[LENS BUTTON]	<LENS> button	Lens buttons (<FOCUS>, <ZOOM>, <SHIFT>)
[AUTO SETUP BUTTON]	<AUTO SETUP> button	
[SHUTTER BUTTON]	<SHUTTER> button	
[ASPECT BUTTON]	—	<ASPECT> button
[ON SCREEN BUTTON]	—	<ON SCREEN> button
[OTHER BUTTON]	▲▼◀▶, <ENTER> button	Buttons not listed above

- 8) Press ◀▶ to switch the item.

[ENABLE]	Enables button operations.
[DISABLE]	Disables button operations.

- Following items can be selected only when [SDI1/2 BUTTON] or [SDI BUTTON] in [INPUT SELECT BUTTON] is selected.

[TOGGLE]	Switches between [SDI1] and [SDI2] when the button is operated.
[SDI1]	Fixes to [SDI1].
[SDI2]	Fixes to [SDI2].
[DISABLE]	Disables button operations.

- Press the <MENU> button to return to the [CONTROL PANEL] screen or the [REMOTE CONTROL] screen when [INPUT SELECT BUTTON] is selected in Step 7).

- 9) Press ▲▼ to select [APPLY], and press the <ENTER> button.
 - The confirmation screen is displayed.
- 10) Press ◀▶ to select [OK], and press the <ENTER> button.

Note

- When a button operation is performed on the device set to [DISABLE], the [CONTROL DEVICE PASSWORD] screen is displayed. Enter the control device password.
- The [CONTROL DEVICE PASSWORD] screen will disappear when there is no operation for approximately 10 seconds.
- If the operations of both [CONTROL PANEL] and [REMOTE CONTROL] are set to [DISABLE], the projector cannot be turned off (cannot enter standby).
- When the setting has completed, the menu screen will disappear. To operate continuously, press the <MENU> button to display the main menu.
- Even when you set button operations on the remote control disabled, operations of the <ID SET> and <ID ALL> buttons on the remote control are kept enabled.

[CONTROL DEVICE PASSWORD CHANGE]

The control device password can be changed.

- 1) Press ▲▼ to select [CONTROL DEVICE PASSWORD CHANGE].
- 2) Press the <ENTER> button.
 - The [CONTROL DEVICE PASSWORD CHANGE] screen is displayed.

- 3) Press ▲▼◀▶ to select the text, and press the <ENTER> button to enter the text.
- 4) Press ▲▼◀▶ to select [OK], and press the <ENTER> button.
 - To cancel, select [CANCEL].

Attention

- The initial password is "AAAA" as the factory default setting or when the [PROJECTOR SETUP] menu → [INITIALIZE] → [ALL USER DATA] is executed.
- Change the password periodically that is hard to guess.

[NETWORK] menu

On the menu screen, select [NETWORK] from the main menu, and select an item from the sub-menu. Refer to “Navigating through the menu” (➔ page 85) for the operation of the menu screen.

[DIGITAL LINK MODE]

Switch the communication method of the <DIGITAL LINK/LAN> terminal of the projector.

- 1) Press ▲▼ to select [DIGITAL LINK MODE].
- 2) Press ◀▶ to switch the item.
 - The items will switch each time you press the button.

[AUTO]	Switches the communication method automatically to DIGITAL LINK, long reach, or Ethernet.
[DIGITAL LINK]	Fixes the communication method to DIGITAL LINK.
[LONG REACH]	Fixes the communication method to long reach.
[ETHERNET]	Fixes the communication method to Ethernet.

Possible communication modes

- ✓: Communication possible
—: Communication not possible

Setting		Communication possible			
		Video transfer (100 m (328'1"))	Video transfer (150 m (492'2"))	Ethernet	RS-232C
[AUTO]	For DIGITAL LINK	✓	—	✓	✓
	For long reach	—	✓	✓	✓
	For Ethernet	—	—	✓*1	—
[DIGITAL LINK]		✓	—	✓	✓
[LONG REACH]		—	✓	✓	✓
[ETHERNET]		—	—	✓*1	—

*1 Communication via a twisted-pair-cable transmitter is not available. Connect the projector to the network directly.

Note

- The maximum transmission distance when connected with the long-reach communication method is 150 m (492'2"). In this case, the signal that the projector can receive is only up to 1080/60p (1 920 x 1 080 dots, dot clock frequency 148.5 MHz).
- When the communication method of the twist-pair-cable transmitter is set to long reach, the projector will connect with long-reach communication method when [DIGITAL LINK MODE] is set to [AUTO]. To connect with the optional DIGITAL LINK Switcher (Model No.: ET-YFB200G) with the long-reach communication method, set [DIGITAL LINK MODE] to [LONG REACH].
- Connection will not be made correctly if the twist-pair-cable transmitter is not supporting the long-reach communication method even if [DIGITAL LINK MODE] is set to [LONG REACH].

[DIGITAL LINK STATUS]

Display the DIGITAL LINK connection environment.

- 1) Press ▲▼ to select [DIGITAL LINK STATUS].
- 2) Press the <ENTER> button.
 - The [DIGITAL LINK STATUS] screen is displayed.

[LINK STATUS]	Either [NO LINK], [DIGITAL LINK], [LONG REACH], or [ETHERNET] is displayed.
[HDCP STATUS]	Either [PROTECTED], [NONE], or [—] is displayed.
[SIGNAL QUALITY]	<p>[SIGNAL QUALITY] is a numerical value of the amount of error, and the display color changes to green, yellow, or red depending on that value. Check the signal quality level while receiving a signal from the twisted-pair-cable transmitter.</p> <ul style="list-style-type: none"> • [MAX]/[MIN]: Maximum/minimum value of the amount of error • Green (–12 dB or lower) → normal signal quality level. • Yellow (–11 to –8 dB) → caution level that noise may appear on the screen. • Red (–7 dB or higher) → abnormal level with interrupted synchronization and receiving not possible.

[NETWORK SETUP]

Perform the initial setting of the network before using the network function.

- 1) Press ▲▼ to select [NETWORK SETUP].
- 2) Press the <ENTER> button.
 - The [NETWORK SETUP] screen is displayed.
- 3) Press ▲▼ to select an item, and change the settings according to the operation instructions of the menu.

[PROJECTOR NAME]	Allows to change the projector name. Enter the host name if it is required to use a DHCP server.	
[DHCP]	[ON]	If a DHCP server exists in the network where the projector is to be connected, obtains the IP address automatically.
	[OFF]	If a DHCP server does not exist in the network where the projector is to be connected, set [IP ADDRESS], [SUBNET MASK], and [DEFAULT GATEWAY].
[IP ADDRESS]	Enter the IP address when a DHCP server is not used.	
[SUBNET MASK]	Enter the subnet mask when a DHCP server is not used.	
[DEFAULT GATEWAY]	Enter the default gateway address when a DHCP server is not used.	

- 4) Press ▲▼ to select [STORE], and press the <ENTER> button.
 - The confirmation screen is displayed.
- 5) Press ◀▶ to select [OK], and press the <ENTER> button.

Note

- When using a DHCP server, confirm that the DHCP server is running.
- Consult your network administrator regarding the IP address, subnet mask, and default gateway.
- When [Art-Net SETUP] is set to [ON(2.X.X.X)] or [ON(10.X.X.X)], [NETWORK SETUP] cannot be selected.

[NETWORK CONTROL]

Set up the control method of the network.

- 1) Press ▲▼ to select [NETWORK CONTROL].
- 2) Press the <ENTER> button.
 - The [NETWORK CONTROL] screen is displayed.
- 3) Press ▲▼ to select an item, and press ◀▶ to change the setting.

[WEB CONTROL]	Set to [ON] to control with the web browser.
[PJLink CONTROL]	Set to [ON] to control with the PJLink protocol.
[PJLink NOTIFICATION]	Set to [ON] to use the PJLink notification function. <ul style="list-style-type: none"> • The [PJLink NOTIFICATION] screen is displayed when set to [ON] and the <ENTER> button is pressed. Set the IP address of the computer to notify the status of the projector in [NOTIFIED IP ADDRESS 1], [NOTIFIED IP ADDRESS 2].
[COMMAND CONTROL]	Set to [ON] to control with the <SERIAL IN>/<SERIAL OUT> terminal control command format (➡ page 232). Refer to “Control commands via LAN” (➡ page 226).
[COMMAND PORT]	Set the port number used for command control.
[Crestron Connected(TM)]	Set to [ON] to control with Crestron Connected™ of Crestron Electronics, Inc.
[AMX D.D.]	Set to [ON] to control with the controller of AMX Corporation. Setting this function to [ON] enables detection through “AMX Device Discovery”. For details, visit the website of AMX Corporation. URL http://www.amx.com/
[EXTRON XTP]	Set to [ON] when connecting the “XTP transmitter” of Extron Electronics to the <DIGITAL LINK/LAN> terminal. The [EXTRON XTP] setting must be set to [OFF] when connecting the optional DIGITAL LINK output supported device (Model No.: ET-YFB100G, ET-YFB200G). For details of the “XTP transmitter”, visit the website of Extron Electronics. URL http://www.extron.com/

- 4) Press ▲▼ to select [STORE], and press the <ENTER> button.
 - The confirmation screen is displayed.

- 5) Press ◀▶ to select [OK], and press the <ENTER> button.

[NETWORK STATUS]

Display the status of the projector network.

- 1) Press ▲▼ to select [NETWORK STATUS].
- 2) Press the <ENTER> button.
 - The [NETWORK STATUS] screen is displayed.

[DHCP]	Displays the status of use of the DHCP server.
[IP ADDRESS]	Displays the [IP ADDRESS].
[SUBNET MASK]	Displays the [SUBNET MASK].
[DEFAULT GATEWAY]	Displays the [DEFAULT GATEWAY].
[DNS1]	Displays the address of the preferred DNS server.
[DNS2]	Displays the address of the alternate DNS server.
[MAC ADDRESS]	Displays the [MAC ADDRESS].

[DIGITAL LINK MENU]

When the optional DIGITAL LINK output supported device (Model No.: ET-YFB100G, ET-YFB200G) is connected to the <DIGITAL LINK/LAN> terminal, the main menu of the connected DIGITAL LINK output supported device is displayed. Refer to the Operating Instructions of the DIGITAL LINK output supported device for details.

Note

- [DIGITAL LINK MENU] cannot be selected when [EXTRON XTP] is set to [ON].
- The operation guidance for the "RETURN" button is in the menu screen of the Digital Interface Box and DIGITAL LINK Switcher. The projector does not have the "RETURN" button, but the same operation is available with the <MENU> button.

[Art-Net SETUP]

Make settings to use the Art-Net function.

- 1) Press ▲▼ to select [Art-Net SETUP].
- 2) Press ◀▶ to switch the item.
 - The items will switch each time you press the button.

[OFF]	Disables the Art-Net function.
[ON(2.X.X.X)]	Enables the Art-Net function and sets the IP address to 2.X.X.X.
[ON(10.X.X.X)]	Enables the Art-Net function and sets the IP address to 10.X.X.X.
[ON(MANUAL)]	Enables the Art-Net function and uses the IP address set in [NETWORK SETUP].

- When other than [OFF] is selected, proceed to Step 3).

- 3) Press the <ENTER> button.
 - The [Art-Net SETUP] screen is displayed.
- 4) Press ▲▼ to select an item, and press ◀▶ to switch the setting.

[NET]	Enter [NET] to be used when the projector processes Art-Net.
[SUB NET]	Enter [SUB NET] to be used when the projector processes Art-Net.
[UNIVERSE]	Enter [UNIVERSE] to be used when the projector processes Art-Net.
[START ADDRESS]	Enter [START ADDRESS] to be used when the projector processes Art-Net.

- 5) Press ▲▼ to select [STORE], and press the <ENTER> button.
 - The confirmation screen is displayed.
- 6) Press ◀▶ to select [OK], and press the <ENTER> button.

Note

- If [ON(2.X.X.X)] or [ON(10.X.X.X)] is selected, IP address is calculated and set automatically.

[Art-Net CHANNEL SETTING]

Set the assignment of the channel.

For the channel definitions used for controlling the projector with the Art-Net function, refer to “Using Art-Net function” (➔ page 221).

1) Press ▲▼ to select [Art-Net CHANNEL SETTING].

2) Press ◀▶ to switch the item.

- The items will switch each time you press the button.

[2]	Uses the channel assignment in standard setting.
[3]*1	Uses the channel assignment with the setting that can numerically control the lens position.
[USER]	Changes the channel assignment.
[1]	Uses the channel assignment with DZ21K series compatible. DZ21K series: DZ21K series, DS20K series, DW17K series, DZ16K series

*1 This item can be set in following cases.

When the standard DC motor unit installed in the Zoom Lens (Model No.: ET-D75LE6, ET-D75LE8, ET-D75LE10, ET-D75LE20, ET-D75LE30, ET-D75LE40, etc.) is replaced with the stepping motor unit using the Stepping Motor Kit (Model No.: ET-D75MKS10), or when a projection lens with the stepping motor is attached.

- When anything other than [USER] is selected, the function assigned to the channel is displayed by pressing the <ENTER> button.
- When [USER] is selected, proceed to Step 3).

3) Press the <ENTER> button.

- The [Art-Net CHANNEL SETTING] screen is displayed.

4) Press ▲▼ to select the channel to set, and press ◀▶ to switch the item.

[LIGHT OUTPUT]	Adjusts the amount of light.
[INPUT SELECT]	Switches the input.
[LENS POSITION]	Moves the lens position.
[LENS H SHIFT]	Adjusts the lens shift in the horizontal direction.
[LENS V SHIFT]	Adjusts the lens shift in the vertical direction.
[LENS FOCUS]	Adjusts the focus.
[LENS ZOOM]	Adjusts the zoom.
[POWER]	Controls the power status.
[SHUTTER]	Controls the shutter.
[FADE-IN]	Sets the fade-in time.
[FADE-OUT]	Sets the fade-out time.
[GEOMETRY]	Performs geometric adjustment.
[CUSTOM MASKING]	Performs geometric adjustment using a computer. To use PC-1, PC-2, and PC-3, the optional Upgrade Kit (Model No.: ET-UK20) is required.
[FREEZE]	Freezes the projected image.
[COLOR]	Adjusts the color saturation.
[TINT]	Adjusts the tint.
[RASTER PATTERN]	Displays the raster pattern.
[LENS H SHIFT MSB]*1	Coarsely adjusts the horizontal position of the lens.
[LENS H SHIFT LSB]*1	Finely adjusts the horizontal position of the lens.
[LENS V SHIFT MSB]*1	Coarsely adjusts the vertical position of the lens.
[LENS V SHIFT LSB]*1	Finely adjusts the vertical position of the lens.
[LENS FOCUS MSB]*1	Coarsely adjusts the focus position of the lens.
[LENS FOCUS LSB]*1	Finely adjusts the focus position of the lens.
[LENS ZOOM MSB]*1	Coarsely adjusts the zoom position of the lens.
[LENS ZOOM LSB]*1	Finely adjusts the zoom position of the lens.
[ENABLE/DISABLE]	Enables/disables the control of the projector with the Art-Net function.
[NONE]	No definition

*1 These items can be selected in following case.

When the standard DC motor unit installed in the Zoom Lens (Model No.: ET-D75LE6, ET-D75LE8, ET-D75LE10, ET-D75LE20, ET-D75LE30, ET-D75LE40, etc.) is replaced with the stepping motor unit using the Stepping Motor Kit (Model No.: ET-D75MKS10), or when a projection lens with the stepping motor is attached.

- The setting can be also made by pressing ▲▼ to select the channel, pressing the <ENTER> button to display the item list, pressing ▲▼◀▶ to select the item, and pressing the <ENTER> button.

- Same item cannot be set for multiple channels, except for [NONE].

Note

- Assign each item of [LENS H SHIFT MSB], [LENS V SHIFT MSB], [LENS FOCUS MSB], and [LENS ZOOM MSB] to a channel together with [LENS H SHIFT LSB], [LENS V SHIFT LSB], [LENS FOCUS LSB], and [LENS ZOOM LSB]. These cannot be used when assigned to a channel by itself.
- Assign each item of [LENS H SHIFT LSB], [LENS V SHIFT LSB], [LENS FOCUS LSB], and [LENS ZOOM LSB] to a channel together with [LENS H SHIFT MSB], [LENS V SHIFT MSB], [LENS FOCUS MSB], and [LENS ZOOM MSB]. These cannot be used when assigned to a channel by itself.
- **MSB:** Most Significant Byte
- **LSB:** Least Significant Byte

[Art-Net STATUS]

Display the content of control assigned to each channel and the received data of that channel.

- 1) Press ▲▼ to select [Art-Net STATUS].
- 2) Press the <ENTER> button.
 - The [Art-Net STATUS] screen is displayed.

Chapter 5 Operations

This chapter describes how to use each function.

Network connection

The projector is equipped with the network function, and following is possible by connecting to a computer.

- **Web control**

Setting, adjustment, and displaying status of the projector are possible by accessing the projector from a computer.

Refer to “Web control function” (➔ page 191) for details.

- **Smart Projector Control**

You can use the application software “Smart Projector Control” to set and adjust projectors connected to a LAN using a smartphone or tablet.

Visit the Panasonic website (<https://panasonic.net/cns/projector/>) for details.

- **Multi Monitoring & Control Software**

“Multi Monitoring & Control Software”, a software application to monitor and control multiple display devices (projector or flat panel display) connected to intranet, can be used.

Plug-in software “Early Warning Software”, which monitors the status of the display devices and their peripherals within an intranet, and notifies of abnormality of such equipment and detects the signs of possible abnormality, can also be used.

For details, visit the Panasonic website (<https://panasonic.net/cns/projector/>).

- **PJLink**

Operation or status query of the projector can be performed from a computer using the PJLink protocol.

Refer to “PJLink protocol” (➔ page 219) for details.

- **Art-Net**

Setting of the projector can be operated by the DMX controller or application software using the Art-Net protocol.

Refer to “Using Art-Net function” (➔ page 221) for details.

- **Command control**

Operation or status query of the projector can be performed from a computer using the control command.

Refer to “Control commands via LAN” (➔ page 226) for details.

Connecting to the network

This projector can receive the Ethernet signal from the twisted-pair-cable transmitter together with the video and serial control signal via the LAN cable.

Example of a normal network connection

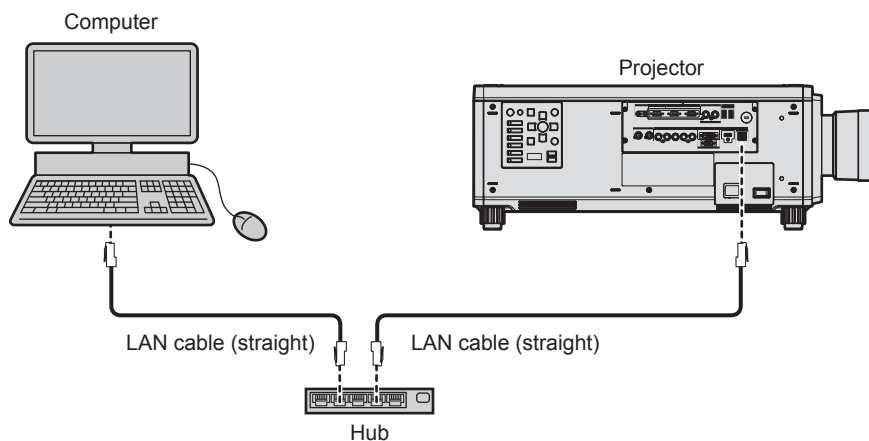

Attention

- When a LAN cable is directly connected to the projector, the network connection must be made indoors.

Note

- A LAN cable is required to use the network function.
- Use a straight or crossover LAN cable that is compatible with CAT5 or higher. Either the straight or the crossover cable, or both cables can be used depending on the system configuration. Consult your network administrator. The projector will determine the type of the cable (straight or crossover) automatically.
- Use a LAN cable of 100 m (328'1") or shorter.

Example of network connections via a twisted-pair-cable transmitter

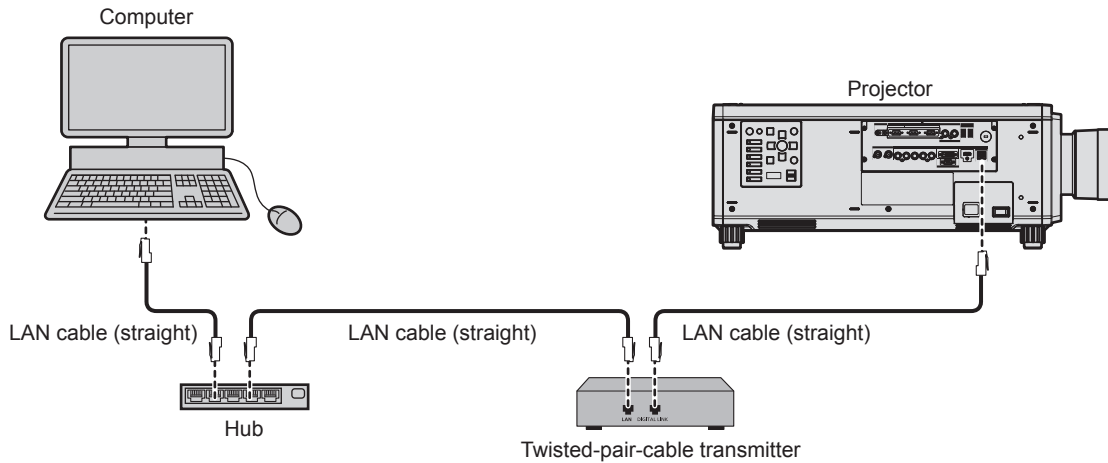

Attention

- When a LAN cable is directly connected to the projector, the network connection must be made indoors.

Note

- For the LAN cable between the twisted-pair-cable transmitter and the projector, use a cable that meets the following criteria:
 - Conforming to CAT5e or higher standards
 - Shielded type (including connectors)
 - Straight-through
 - Single wire
- The maximum transmission distance between the twisted-pair-cable transmitter and the projector is 100 m (328'1"). It is possible to transmit up to 150 m (492'2") if the twisted-pair-cable transmitter supports the long-reach communication method. However, the signal that the projector can receive is only up to 1080/60p (1 920 x 1 080 dots, dot clock frequency 148.5 MHz) for the long-reach communication method. If this distance is exceeded, image may be disrupted or a malfunction may occur in LAN communication.
- When laying cables between the twisted-pair-cable transmitter and the projector, confirm that cable characteristics are compatible with CAT5e or higher using tools such as a cable tester or cable analyzer. When a relay connector is used, include it in the measurement.
- Do not use a hub between the twisted-pair-cable transmitter and the projector.
- Do not pull cables forcefully. Also, do not bend or fold cables unnecessarily.
- To reduce the effects of noise as much as possible, stretch out the cables between the twisted-pair-cable transmitter and the projector without any loops.
- Lay the cables between the twisted-pair-cable transmitter and the projector away from other cables, particularly power cables.
- When laying multiple cables, run them side by side along the shortest distance possible without bundling them together.
- After laying the cables, go to the [NETWORK] menu → [DIGITAL LINK STATUS] and confirm that the value of [SIGNAL QUALITY] is displayed in green which indicates normal quality.
- For twisted-pair-cable transmitters of other manufacturers of which the operation has been verified with the projector, visit the Panasonic website (<https://panasonic.net/cns/projector/>). Note that the verification for devices of other manufacturers has been made for the items set by Panasonic Corporation, and not all the operations have been verified. For operation or performance problems caused by the devices of other manufacturers, contact the respective manufacturers.

Setting the projector

- 1) Connect the projector to a computer using a LAN cable.
- 2) Turn on the power of the projector.
- 3) Press the <MENU> button to open the [NETWORK] menu, select [NETWORK SETUP], and press the <ENTER> button.
- 4) Perform the [NETWORK SETUP] setting.
 - Refer to [NETWORK SETUP] (➡ page 183) for details.

Note

- To connect to an existing network, perform after consulting your network administrator.

■ Factory default setting

- Following setting has been made as a factory default.

[DHCP]	OFF
[IP ADDRESS]	192.168.0.8

[SUBNET MASK]	255.255.255.0
[DEFAULT GATEWAY]	192.168.0.1
[DNS1]/[DNS2]	None

Operating the computer

- 1) Turn on the power of the computer.
- 2) Perform the network setting following the instruction of your network administrator.
 - Operation from the computer is possible by configuring the network setting of the computer as follows if the projector is in the factory default setting.

[IP ADDRESS]	192.168.0.10
[SUBNET MASK]	255.255.255.0
[DEFAULT GATEWAY]	192.168.0.1

Web control function

Following operation is possible from a computer using the web control function.

- Setting and adjustment of the projector
- Display of the projector status
- Sending E-mail messages when there is a problem with the projector

The projector supports “Crestron Connected™”, and the following application software of Crestron Electronics, Inc. can be used.

- RoomView Express
- Fusion RV
- RoomView Server Edition

Note

- Communication with an E-mail server is required to use the E-mail function. Confirm that the E-mail can be used beforehand.
- “Crestron Connected™” is a system of Crestron Electronics, Inc. that collectively manages and controls devices on multiple systems connected to a network using a computer.
- For details of the “Crestron Connected™”, visit the website of Crestron Electronics, Inc. (English only.)
URL <http://www.crestron.com>
Download “RoomView Express” from the Crestron Electronics, Inc. website. (English only.)
URL <http://www.crestron.com/getroomview>

Computer that can be used for setting

To use the web control function, a web browser is required. Confirm that the web browser can be used in advance.

OS	Compatible browser
Windows	Internet Explorer 11.0
Mac OS	Safari 6.0/7.0/8.0/9.0/10.0
iOS	Safari (version equipped with iOS 9 and iOS 10)
Android	Google Chrome (version equipped with Android 4.4/5.0/5.1/6.0/7.0)

Accessing from the web browser

- 1) Start up the web browser on the computer.
- 2) Enter the IP address set on the projector into the URL entry field of the web browser.
- 3) Enter the user name and the password.
 - The factory default settings are User name: dispuser (user rights)/dispadmin (administer rights); Password: @Panasonic.
 - Change of password is prompted when using the web control function for the first time. Proceed to Step 4). If the web control function is used already, proceed to Step 7).

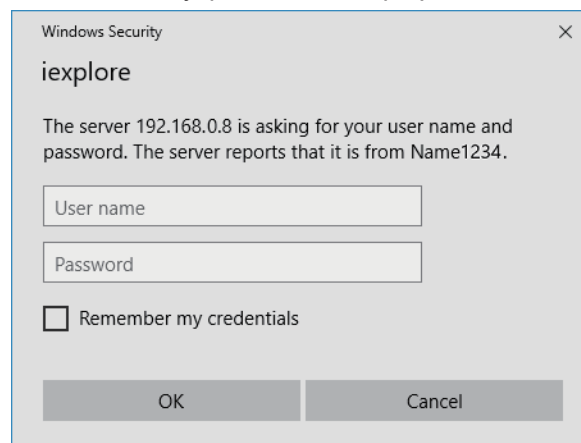

4) Click OK.

- The [Change password] page is displayed.

For user rights



For administrator rights



5) Enter the new user name and password, and click [Change].

- The screen in Step 3) is displayed again.

6) Enter the new user name and password.

- Enter the new user name and password set in Step 5).

7) Click OK.

Attention

- The entry screen for the user name and password may be hidden by other window that is already opened. In such case, minimize the window in front to display the entry screen.

Note

- If you use a web browser to control the projector, set the [NETWORK] menu → [NETWORK CONTROL] → [WEB CONTROL] to [ON].
- Do not perform setting or control simultaneously by starting up multiple web browsers. Do not set or control the projector from multiple computers.
- Access will be locked for few minutes when an incorrect password is entered three times consecutively.
- Some items on the projector setting page use the Javascript function of the web browser. Correct control may not be possible when the web browser is set not to use this function.
- If the screen for the web control is not displayed, consult your network administrator.
- While updating the screen for the web control, the screen may appear white for a moment, but it is not a malfunction.
- When the projector is already registered in application software (such as “Multi Monitoring & Control Software” and “Smart Projector Control”) which uses the communication control via LAN, communication with the projector will become impossible if a user name or password for [Administrator] is changed. If a user name or password for [Administrator] is changed, update the registration information of the application software in use.
- Screenshot of a computer
The size or the display of the screen may be different from this manual depending on the OS or the web browser, or the type of computer in use.

Rights for each account

The administrator rights allow use of all functions. There is a limitation in the rights that can be used with the user rights. Select the rights depending on the purpose.

The function that has ✓ in the administrator rights/user rights column indicates that it can be operated with that rights.

Item	Function	Administrator rights	User rights	Page
[Status]	[Projector status]	✓	✓	194
	Error information page	✓	✓	195
	[Network status]	✓	✓	195
	[Access error log]	✓	—	195
	[Mail error log]	✓	—	196
[Projector control]	[Basic control]	✓	✓	196
	[Detail control]	✓	—	197
[Detailed set up]	[Network config]	✓	—	199
	[Adjust clock]	✓	—	200
	[Ping test]	✓	—	200
	[E-mail set up]	✓	—	201
	[Authentication set up]	✓	—	202
[Change password]	User name of [Administrator]	✓	—	205
	User name of [User]	✓	—	206
	Password of [Administrator]	✓	—	205
	Password of [User]	✓	✓	206, 206
[Crestron Connected(TM)]	Operation page	✓	—	207
	[Tools]	✓	—	207
	[Info]	✓	—	208
	[Help]	✓	—	208

Descriptions of items



- | | |
|--|--|
| <p>1 Page tab
Switches pages by clicking this item.</p> <p>2 [Status]
The status of the projector is displayed by clicking this item.</p> <p>3 [Projector control]
The [Projector control] page is displayed by clicking this item.</p> | <p>4 [Detailed set up]
The [Detailed set up] page is displayed by clicking this item.</p> <p>5 [Change password]
The [Change password] page is displayed by clicking this item.</p> <p>6 [Crestron Connected(TM)]
The operation page of Crestron Connected™ is displayed by clicking this item.</p> |
|--|--|

[Projector status] page

Click [Status] → [Projector status].

Display the status of the projector for the following items.

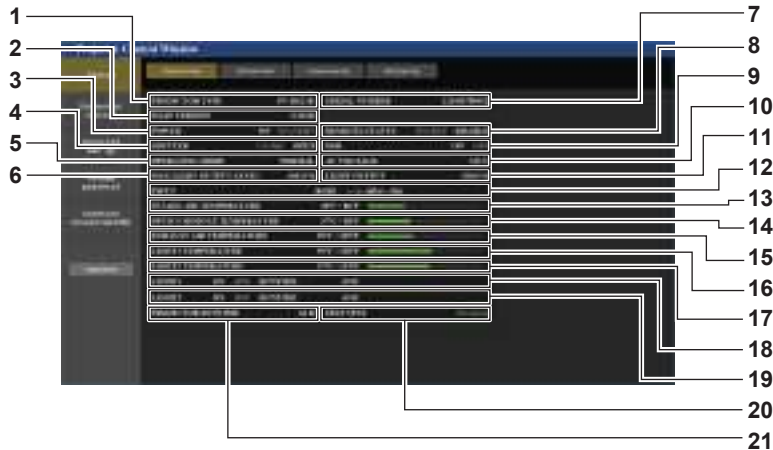

- | | |
|--|---|
| <p>1 [PROJECTOR TYPE]
Displays the type of the projector.</p> <p>2 [MAIN VERSION]
Displays the firmware version of the projector.</p> <p>3 [POWER]
Displays the status of the power.</p> <p>4 [SHUTTER]
Displays the status of the shutter. ([CLOSE]: Shutter function enabled; [OPEN]: Shutter function disabled)</p> <p>5 [OPERATING MODE]
Displays the setting status of [OPERATING MODE].</p> <p>6 [MAX LIGHT OUTPUT LEVEL]
Displays the setting status of [MAX LIGHT OUTPUT LEVEL].</p> <p>7 [SERIAL NUMBER]
Displays the serial number of the projector.</p> <p>8 [REMOTE2 STATUS]
Displays the control status of the <REMOTE 2 IN> terminal.</p> <p>9 [OSD]
Displays the status of on-screen display function. ([ON]: Display; [OFF]: Hide)</p> <p>10 [AC VOLTAGE]
Displays the input supply voltage.</p> | <p>11 [LIGHT OUTPUT]
Displays the setting status of [LIGHT OUTPUT].</p> <p>12 [INPUT]
Displays the status of the selected input.</p> <p>13 [INTAKE AIR TEMPERATURE]
Displays the status of the intake air temperature of the projector.</p> <p>14 [OPTICS MODULE TEMPERATURE]
Displays the status of the internal temperature of the projector.</p> <p>15 [EXHAUST AIR TEMPERATURE]
Displays the status of the exhaust air temperature of the projector.</p> <p>16 [LIGHT1 TEMPERATURE]
Displays the temperature status of light source 1.</p> <p>17 [LIGHT2 TEMPERATURE]
Displays the temperature status of light source 2.</p> <p>18 [LIGHT1]
Displays the lighting status and runtime of light source 1.</p> <p>19 [LIGHT2]
Displays the lighting status and runtime of light source 2.</p> <p>20 [SELF TEST]
Displays the self-diagnosis information.</p> <p>21 [PROJECTOR RUNTIME]
Displays the runtime of the projector.</p> |
|--|---|

Error information page

When [Error (Detail)] or [Warning (Detail)] is displayed in the [SELF TEST] display field of the **[Projector status]** screen, click it to display the content of the error/warning.

- The projector may go into the standby status to protect the projector depending on the contents of the error.

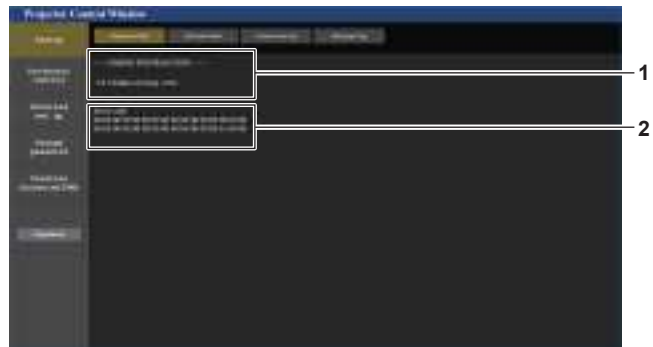

1 Display of error information

Displays the alphanumeric symbols and content of errors/warnings that occur.

Refer to “Self-diagnosis display” (➔ page 215) for the display details.

2 Error code

[Network status] page

Click [Status] → [Network status].

The current network setting status is displayed.



[Access error log] page

Click [Status] → [Access error log].

The error log on the web server is displayed such as access to the pages that do not exist or access with unauthorized user names or passwords.



[Mail error log] page

Click [Status] → [Mail error log].

E-mail error log is displayed if periodic E-mail sending has failed.



Note

- [Access error log] and [Mail error log] display the recent few thousand accesses/requests. All information may not be displayed when many accesses/requests are made at once.
- Logs in [Access error log] and [Mail error log] are deleted from the oldest when exceeding a certain amount.
- Check [Access error log] and [Mail error log] periodically.

[Basic control] page

Click [Projector control] → [Basic control].

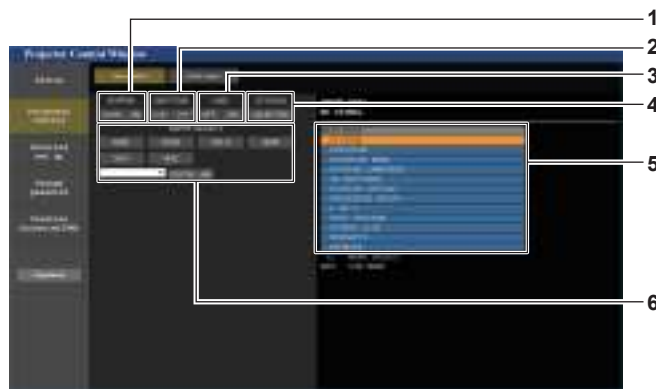

- | | |
|--|--|
| <p>1 [POWER]
Turns off/on the power.</p> <p>2 [SHUTTER]
Switches the status of the shutter. ([CLOSE]: Shutter function enabled; [OPEN]: Shutter function disabled)</p> <p>3 [OSD]
Switches the status of the on-screen display function. ([OFF]: Hide; [ON]: Display)</p> | <p>4 [SYSTEM]
Switches the system method.</p> <p>5 On-screen display of the projector
Displays the same items as shown on the on-screen display of the projector. You can check or change the settings of the menus. It is displayed even if the on-screen display function is set to off (hide).</p> <p>6 [INPUT SELECT]
Switches the input of the image to project.</p> |
|--|--|

[Detail control] page

Click [Projector control] → [Detail control].

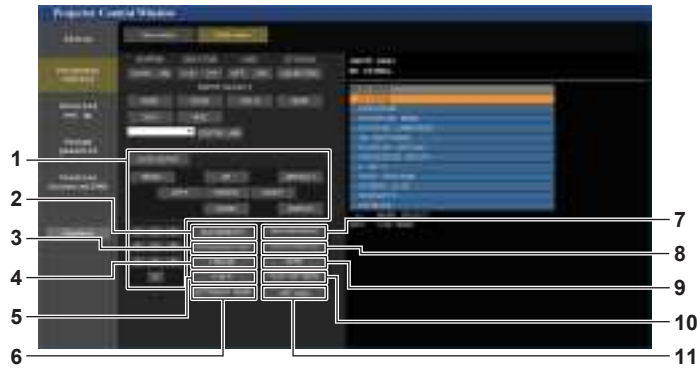

- | | |
|---|--|
| <p>1 Control of the projector
The projector is controlled by clicking the buttons in the same way as the buttons on the remote control. After control, the on-screen display of the projector at the right of the control page is updated.</p> <p>2 [SUB MEMORY]
Switches the sub memory.</p> <p>3 [SYSTEM DAYLIGHT VIEW]
Switches to system daylight view settings.</p> <p>4 [FREEZE]
Temporarily pauses the image.</p> <p>5 [P IN P]
Switches the P IN P setting.</p> <p>6 [LEFT/RIGHT SWAP]
Switches the flip horizontal settings.</p> | <p>7 [WAVEFORM MONITOR]
Displays the waveform of the input signal.</p> <p>8 [PROJECTION METHOD]
Switches the setting of the projection method.</p> <p>9 [LENS]
Displays the [LENS] page.</p> <p>10 [TEST PATTERN]
Displays the test pattern.
Click the test pattern to display in the projected image from the patters displayed on the right side of the control page.
The display of the test pattern disappears if [Exit] is clicked.</p> <p>11 [GET OSD]
Updates the on-screen display of the projector at the right of the control page.</p> |
|---|--|

[LENS] page

Click [Projector control] → [Detail control] → [LENS].

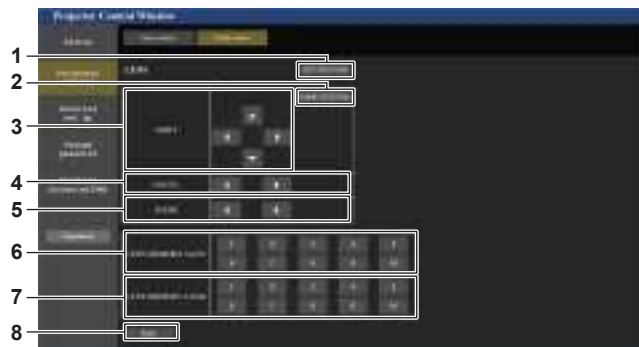

- | | |
|--|--|
| <p>1 [SET POSITION]
The lens position setting page is displayed.</p> <p>2 [HOME POSITION]
Moves the projection lens to the home position.</p> <p>3 [SHIFT]
Click ▲▼◀▶ to adjust the lens shift (vertical position and horizontal position).
The adjustment can be performed faster by holding down the button for approximately three seconds or longer.</p> <p>4 [FOCUS]
Click ◀▶ to adjust the focus.
The adjustment can be performed faster by holding down the button for approximately six seconds or longer.</p> | <p>5 [ZOOM]
Click ◀▶ to adjust the zoom.</p> <p>6 [LENS MEMORY SAVE]
Saves the current lens position (vertical position, horizontal position, focus position, and zoom position). Click the number of the lens memory to save.</p> <p>7 [LENS MEMORY LOAD]
Loads the lens position (vertical position, horizontal position, focus position, and zoom position). Click the number of the lens memory to load.</p> <p>8 [Back]
Returns to the [Detail control] page.</p> |
|--|--|

Lens position setting page

Click [Projector control] → [Detail control] → [LENS] → [SET POSITION].



1 [Get]

Acquires the current lens position and displays the acquired values in the lens position information field.

2 Lens position information field

Enter the lens position (vertical position, horizontal position, focus position, and zoom position).

3 [Back]

Returns to the [LENS] page.

4 [Apply]

Moves to the lens position displayed in the lens position information field.

Note

- The zoom position is displayed in the lens position information field only in following case.
 - When the standard DC motor unit installed in the Zoom Lens (Model No.: ET-D75LE6, ET-D75LE8, ET-D75LE10, ET-D75LE20, ET-D75LE30, ET-D75LE40, etc.) is replaced with the stepping motor unit using the Stepping Motor Kit (Model No.: ET-D75MKS10), or when a projection lens with the stepping motor is attached.

[Network config] page

Click [Detailed set up] → [Network config].

- Click [Network config] to display the **[CAUTION!]** screen.
- Click the [Next] button to display the current settings.
- Click the [Change] button to display the setting change screen.

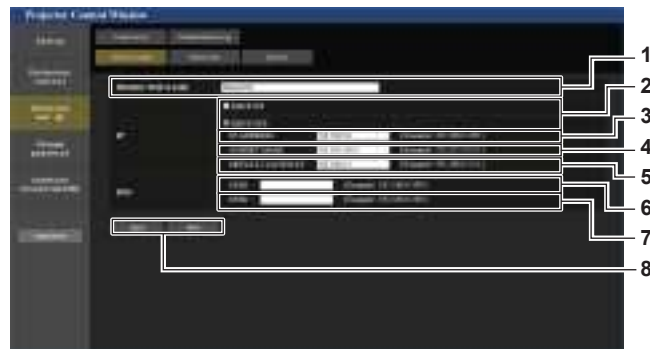

- | | |
|---|---|
| <p>1 [PROJECTOR NAME]
Enter the name of the projector. Enter the host name if it is required when using a DHCP server etc.</p> <p>2 [DHCP ON], [DHCP OFF]
To enable the DHCP client function, set to [DHCP ON].</p> <p>3 [IP ADDRESS]
Enter the IP address when not using a DHCP server.</p> <p>4 [SUBNET MASK]
Enter the subnet mask when not using a DHCP server.</p> <p>5 [DEFAULT GATEWAY]
Enter the default gateway address when not using a DHCP server.</p> | <p>6 [DNS1]
Enter the DNS1 server address.
Permissible characters for the entry of DNS1 server address (primary):
Numbers (0 - 9), period (.)
(Example: 192.168.0.253)</p> <p>7 [DNS2]
Enter the DNS2 server address.
Available characters for the entry of DNS2 server address (secondary):
Numbers (0 - 9), period (.)
(Example: 192.168.0.254)</p> <p>8 [Back], [Next]
Click the [Back] button to return to the original screen. Click the [Next] button to display the setting confirmation screen. Click the [Submit] button to update the setting.</p> |
|---|---|

Note

- When you use the “Forward” and “Back” functions of your browser, a warning message “Page has Expired” may appear. In that case, click [Network config] again since the following operation will not be guaranteed.
- Changing LAN settings while connected to the LAN may cause the connection to cut out.

[Adjust clock] page

Click [Detailed set up] → [Adjust clock].

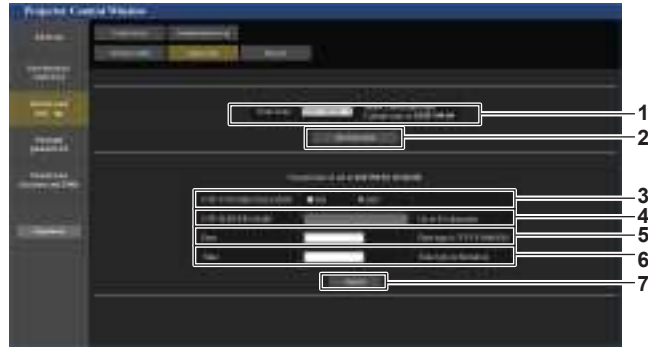

- | | |
|--|--|
| <p>1 [Time Zone]
Select the time zone.</p> <p>2 [Set time zone]
Updates the time zone setting.</p> <p>3 [NTP SYNCHRONIZATION]
Set to [ON] when setting the date and time automatically.</p> <p>4 [NTP SERVER NAME]
Enter the IP address or server name of the NTP server when you set to adjust the date and time manually.
(To enter the server name, the DNS server needs to be set up.)</p> | <p>5 [Date]
Enter the date to be changed.</p> <p>6 [Time]
Enter the time to be changed.</p> <p>7 [Submit]
Updates the date and time settings.</p> |
|--|--|

Note

- The replacement of the battery inside the projector is required when the time goes out of alignment right after correcting the time. Consult your dealer.

[Ping test] page

Check whether the network is connected to the E-mail server, POP server, DNS server, etc.

Click [Detailed set up] → [Ping test].

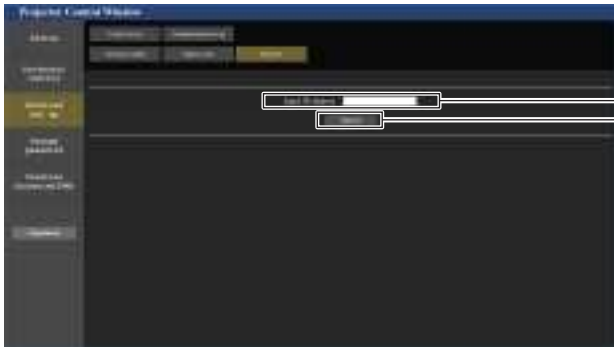

```

PING 192.168.0.8 (192.168.0.8): 56 data bytes
64 bytes from 192.168.0.8: seq=0 ttl=128 time=1 ms
64 bytes from 192.168.0.8: seq=1 ttl=128 time=1 ms
64 bytes from 192.168.0.8: seq=2 ttl=128 time=1 ms
64 bytes from 192.168.0.8: seq=3 ttl=128 time=1 ms

--- 192.168.0.8 ping statistics ---
4 packets transmitted, 4 packets received, 0% packet loss
round-trip min/avg/max = 1/1/1 ms
    
```

```

PING 192.168.0.101 (192.168.0.101): 56 data bytes

--- 192.168.0.101 ping statistics ---
4 packets transmitted, 0 packets received, 100% packet loss
    
```

- | | |
|--|--|
| <p>1 [Input IP address]
Enter the IP address of the server to be tested.</p> <p>2 [Submit]
Executes the connection test.</p> | <p>3 Example of display when the connection has succeeded</p> <p>4 Example of display when the connection has failed</p> |
|--|--|

[E-mail set up] page

Send an E-mail to preset E-mail addresses (up to two addresses) when a problem has occurred.
 Click [Detailed set up] → [E-mail set up].

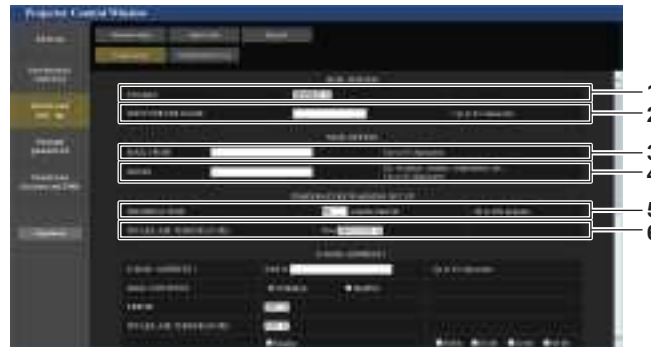

- 1 **[ENABLE]**
Select [ENABLE] to use the E-mail function.
- 2 **[SMTP SERVER NAME]**
Enter the IP address or the server name of the E-mail server (SMTP). To enter the server name, the DNS server needs to be set up.
- 3 **[MAIL FROM]**
Enter the E-mail address of the projector. (Up to 63 characters in single byte)
- 4 **[MEMO]**
Enter information such as the location of the projector that notifies the sender of the E-mail. (Up to 63 characters in single byte)

- 5 **[MINIMUM TIME]**
Change the minimum interval for the temperature warning E-mail. The default value is 60 minutes. In this case, another E-mail will not be sent for 60 minutes after sending the temperature warning E-mail even if it reaches the warning temperature.
- 6 **[INTAKE AIR TEMPERATURE]**
Change the temperature setting for the temperature warning mail. A temperature warning E-mail is sent when the temperature exceeds this value.



- 7 **[E-MAIL ADDRESS 1], [E-MAIL ADDRESS 2]**
Enter the E-mail address to be sent. Leave [E-MAIL ADDRESS 2] blank when two E-mail addresses are not to be used.



- 8 **Settings of the conditions to send E-mail**
Select the conditions to send E-mail.
[MAIL CONTENTS]:
Select either [NORMAL] or [SIMPLE].
[ERROR]:
Send an E-mail when an error occurred in the self-diagnosis.
[INTAKE AIR TEMPERATURE]:
Send an E-mail when the intake air temperature has reached the value set at the above field.
[PERIODIC REPORT]:
Place a check mark on this to send an E-mail periodically. An E-mail will be sent on the day and time with the check mark.
- 9 **[Submit]**
Updates the settings and sends the details by E-mail.

[Authentication set up] page

Set the authentication items when POP authentication or SMTP authentication is necessary to send an E-mail. Click [Detailed set up] → [Authentication set up].

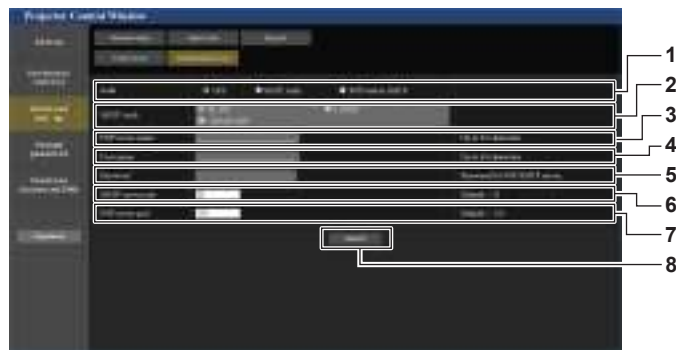

- | | |
|--|---|
| <p>1 [Auth]
Select the authentication method specified by your Internet service provider.</p> <p>2 [SMTP Auth]
Set when the SMTP authentication is selected.</p> <p>3 [POP server name]
Enter the POP server name.
Allowed characters:
Alphanumerics (A - Z, a - z, 0 - 9)
Minus sign (-) and period (.)</p> <p>4 [User name]
Enter the user name for the POP server or the SMTP server.</p> | <p>5 [Password]
Enter the password for the POP server or the SMTP server.</p> <p>6 [SMTP server port]
Enter the port number of the SMTP server.
(Normally 25)</p> <p>7 [POP server port]
Enter the port number of the POP server.
(Normally 110)</p> <p>8 [Submit]
Update the settings.</p> |
|--|---|

Contents of E-mail sent

Example of the E-mail sent when E-mail is set

The following E-mail is sent when the E-mail settings have been established.

```

=== Panasonic projector report(CONFIGURE) ===
Projector Type      : PT-RZ21K
Serial No          : 123456789012

---- E-mail setup data ----
TEMPERATURE WARNING SETUP
MINIMUM TIME       at [ 60] minutes interval
INTAKE AIR TEMPERATURE Over [ 46 degC / 114 degF ]

ERROR              [ OFF ]
INTAKE AIR TEMPERATURE [ OFF ]
PERIODIC REPORT
Sunday [ ON ] Monday [ ON ] Tuesday [ ON ] Wednesday [ ON ]
Thursday [ ON ] Friday [ ON ] Saturday [ ON ]

00:00 [ ON ] 01:00 [ ON ] 02:00 [ ON ] 03:00 [ ON ]
04:00 [ ON ] 05:00 [ ON ] 06:00 [ ON ] 07:00 [ ON ]
08:00 [ ON ] 09:00 [ ON ] 10:00 [ ON ] 11:00 [ ON ]
12:00 [ ON ] 13:00 [ ON ] 14:00 [ ON ] 15:00 [ ON ]
16:00 [ ON ] 17:00 [ ON ] 18:00 [ ON ] 19:00 [ ON ]
20:00 [ ON ] 21:00 [ ON ] 22:00 [ ON ] 23:00 [ ON ]

---- ERROR INFORMATION ----

Error code
00 00 00 00 00 00 00 00 00 00 00 00 00 00 00 00
00 00 00 00 00 00 00 00 00 00 00 00 00 00 00 00

Intake air temperature      : 25 degC / 77 degF
Optics module temperature  : 28 degC / 82 degF
Exhaust air temperature    : 28 degC / 82 degF
Light1 temperature        : 28 degC / 82 degF
Light2 temperature        : 29 degC / 84 degF
PROJECTOR RUNTIME         : 7 H
POWER ON                  : 132 times
LIGHT1 RUNTIME            : 7 H
LIGHT1 ON                 : 174 times
LIGHT2 RUNTIME            : 7 H
LIGHT2 ON                 : 177 times

----- Current status -----
MAIN VERSION              1.00
SUB VERSION               1.00
LIGHT STATUS              LIGHT1=ON LIGHT2=ON
INPUT                     SDI1
SIGNAL NAME               ---
SIGNAL FREQUENCY          ---kHz / ---Hz
REMOTE2 STATUS            DISABLE

---- Wired Network configuration ----
DHCP Client               OFF
IP address                 192.168.0.8
MAC address                12:34:56:78:90:12

Mon Jan 01 12:34:56 20XX

---- Memo ----

```

Example of the E-mail sent for an error

The following E-mail is sent when an error has occurred.

```
=== Panasonic projector report(ERROR) ===
Projector Type      : PT-RZ21K
Serial No          : 123456789012

----- ERROR INFORMATION -----
U21 Intake air temp. error

Error code
00 00 00 00 00 00 00 00 00 00 00 00 00 00 00
00 00 00 00 00 00 00 00 00 00 00 00 01 00 00

Intake air temperature      : 25 degC / 77 degF
Optics module temperature   : 28 degC / 82 degF
Exhaust air temperature    : 28 degC / 82 degF
Light1 temperature         : 28 degC / 82 degF
Light2 temperature         : 29 degC / 84 degF
PROJECTOR RUNTIME          : 7 H
POWER ON                   : 132 times
LIGHT1 RUNTIME             : 7 H
LIGHT1 ON                  : 174 times
LIGHT2 RUNTIME             : 7 H
LIGHT2 ON                  : 177 times

----- Current status -----
MAIN VERSION                1.00
SUB VERSION                 1.00
LIGHT STATUS                LIGHT1=ON LIGHT2=ON
INPUT                      SDI1
SIGNAL NAME                 ---
SIGNAL FREQUENCY            --kHz / --Hz
REMOTE2 STATUS              DISABLE

----- Wired Network configuration -----
DHCP Client                 OFF
IP address                  192.168.0.8
MAC address                 12:34:56:78:90:12

Mon Jan 01 12:34:56 20XX

----- Memo -----
```

[Change password] page

Click [Change password].

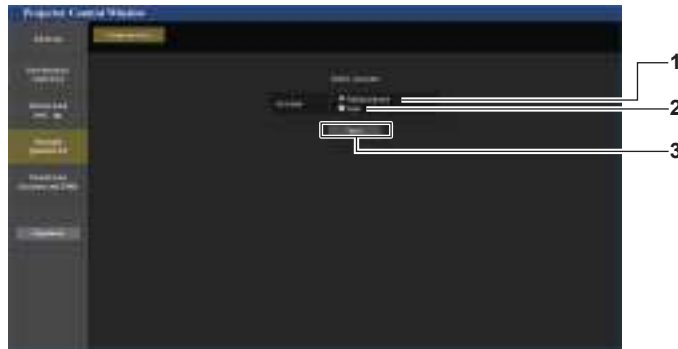

- | | |
|---|--|
| <p>1 [Administrator]
Used to change the setting of the [Administrator].</p> <p>2 [User]
Used to change the setting of the [User].</p> | <p>3 [Next]
Used to change the setting of the password.</p> |
|---|--|

[Administrator] account

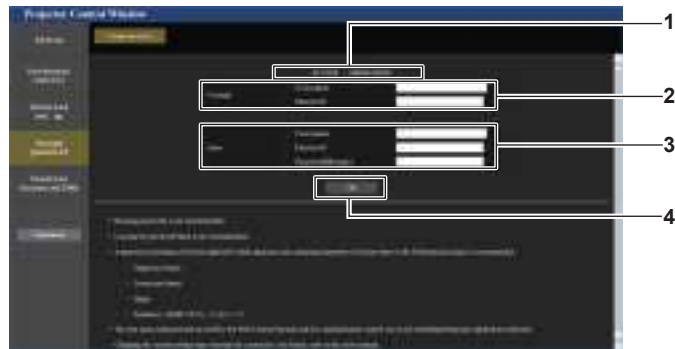

- | | |
|---|--|
| <p>1 [Account]
Displays the account to change.</p> <p>2 [Current]
[User name]:
Enter the user name before the change.
[Password]:
Enter the current password.</p> | <p>3 [New]
[User name]:
Enter the desired new user name. (Up to 16 characters in single byte)
[Password]:
Enter the desired new password. (Up to 16 characters in single byte)
[Password(Retype)]:
Enter the desired new password again.</p> <p>4 [OK]
Determines the change of password.</p> |
|---|--|

Note

- When the projector is already registered in application software (such as “Multi Monitoring & Control Software” and “Smart Projector Control”) which uses the communication control via LAN, communication with the projector will become impossible if a user name or password for [Administrator] is changed. If a user name or password for [Administrator] is changed, update the registration information of the application software in use.

[User] account

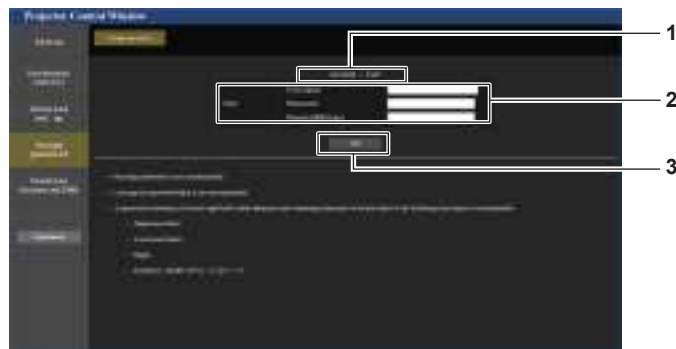

- | | |
|--|---|
| <p>1 [Account]
Displays the account to change.</p> <p>2 [New]
[User name]:
Enter the desired new user name. (Up to 16 characters in single byte)
[Password]:
Enter the desired new password. (Up to 16 characters in single byte)
[Password(Retyping)]:
Enter the desired new password again.</p> | <p>3 [OK]
Determines the change of password.</p> |
|--|---|

[Change password] (For user rights)

Only the change of password is enabled under the user rights.

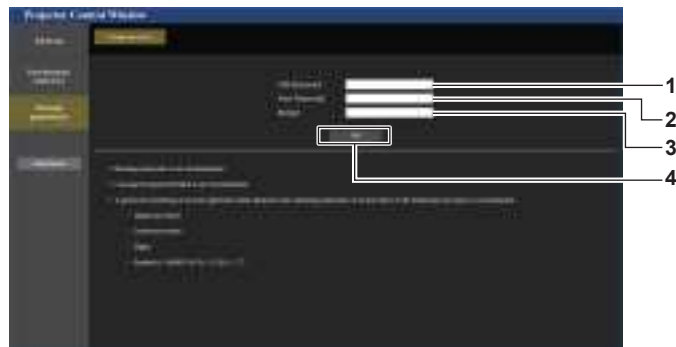

- | | |
|--|--|
| <p>1 [Old Password]
Enter the current password.</p> <p>2 [New Password]
Enter the desired new password. (Up to 16 characters in single byte)</p> | <p>3 [Retype]
Enter the desired new password again.</p> <p>4 [OK]
Determines the change of password.</p> |
|--|--|

Note

- To change the account of the [Administrator], entry of [User name] and [Password] in [Current] is required.

[Crestron Connected(TM)] page

The projector can be monitored/controlled with Crestron Connected™. It is necessary to access with the administrator rights to start the operation screen of Crestron Connected™ from the web control screen. (The [Crestron Connected(TM)] button is not displayed in the web control screen with the user rights.) The operation page of Crestron Connected™ is displayed by clicking [Crestron Connected(TM)]. It is not displayed if Adobe® Flash® Player is not installed on your computer, or the browser you use does not support Flash. In such a case, click [Back] in the operation page to go back to the previous page.

Operation page

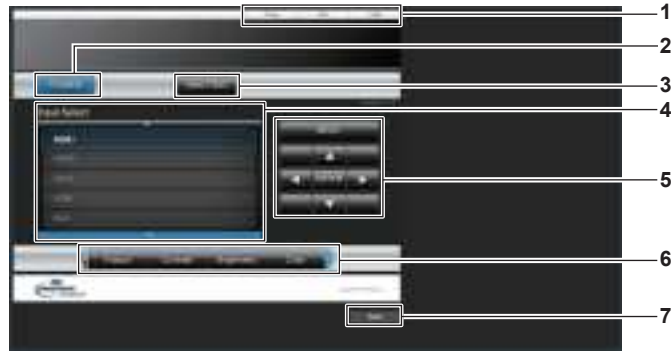

- 1 **[Tools], [Info], [Help]**
Tabs for selecting the setting, information, or help page of the projector.
- 2 **[POWER]**
Turns off/on the power.
- 3 **[SHUTTER]**
Switches the status of the shutter. ([CLOSE]: Shutter function enabled; [OPEN]: Shutter function disabled)

- 4 **[Input Select]**
Controls input selection.
Not available when the power of the projector is turned off.
- 5 **Menu screen control buttons**
Navigates the menu screen.
- 6 **Freeze/image quality adjustment**
Controls items related to freeze/image quality.
- 7 **[Back]**
Returns to the previous page.

[Tools] page

Click [Tools] in the operation page.

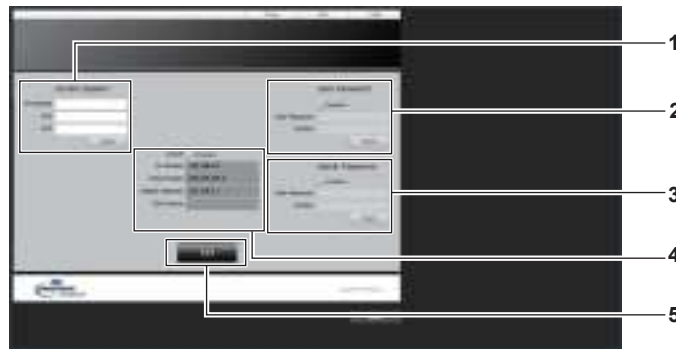

- 1 **[Control System]**
Set the information required for communicating with the controller to be connected with the projector.
- 2 **[User Password]**
Set the user rights password for the operation page of Crestron Connected™.
- 3 **[Admin Password]**
Set the administrator rights password for the operation page of Crestron Connected™.

- 4 **Network status**
Displays the settings of wired LAN.
[DHCP]
Displays the current setting.
[Ip Address]
Displays the current setting.
[Subnet Mask]
Displays the current setting.
[Default Gateway]
Displays the current setting.
[DNS Server]
Displays the current setting.
- 5 **[Exit]**
Returns to the operation page.

[Info] page

Click [Info] in the operation page.



1 [Projector Name]
Displays the projector name.

2 [Mac Address]
Displays the MAC address.

3 [Lamp1 Hours], [Lamp2 Hours]
Displays the runtime of the light source 1 and the light source 2.

4 [Power Status]
Displays the status of the power.

5 [Source]
Displays the selected input.

6 [Error Status]
Displays the error status.

7 [Exit]
Returns to the operation page.

[Help] page

Click [Help] in the operation page.

The [Help Desk] window is displayed.



1 [Help Desk]
A message can be sent/received with the administrator using the Crestron Connected™.

Chapter 6 Maintenance

This chapter describes inspection methods when there are problems, and maintenance methods.

Light source/temperature indicators

When an indicator lights up

If a problem occurs inside the projector, the light source indicators <LIGHT1>/<LIGHT2> or temperature indicator <TEMP> will inform you by lighting or blinking in red. Check the status of the indicators and take following measures.

Attention

- When switching off the projector to deal with problems, make sure to follow the procedure in “Switching off the projector” (➔ page 69).

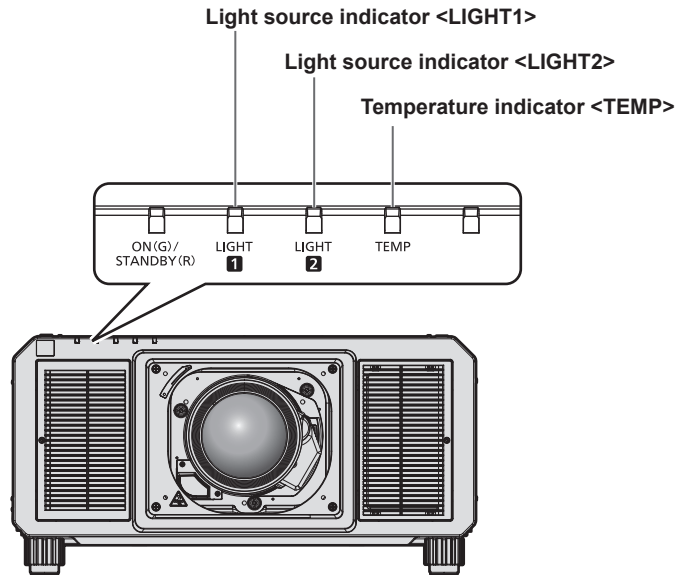

Light source indicators <LIGHT1>/<LIGHT2>

Indicator status	Status	Solution
Lighting in red	<ul style="list-style-type: none"> Some of the elements of the light source are defective and the light output has decreased. 	<ul style="list-style-type: none"> Turn the <MAIN POWER> switch to <OFF> (➔ page 69), and turn on the power again.
Blinking in red (1 time)	<ul style="list-style-type: none"> The light source is turned off since the projection lens cannot be detected. 	<ul style="list-style-type: none"> Turn off the power and mount the projection lens again. (➔ page 49) Turn the <MAIN POWER> switch to <OFF> (➔ page 69), and turn on the power again.
Blinking in red (2 times)	<ul style="list-style-type: none"> The light source does not light up, or the light source turns off while the projector is in use. 	<ul style="list-style-type: none"> Turn the <MAIN POWER> switch to <OFF> (➔ page 69), and turn on the power again.
Blinking in red (3 times)		

Note

- If the light source indicators <LIGHT1>/<LIGHT2> are still lit or blinking after taking the measures, set the <MAIN POWER> switch to <OFF>, and ask your dealer for repairs.
- The light source indicator corresponding to the light source being lit will light up in green if the projector is in projection mode and there is no indication of problem by lighting or blinking in red.

Temperature indicator <TEMP>

Indicator status	Status	Solution
Lighting in red	<ul style="list-style-type: none"> • Warm-up status 	<ul style="list-style-type: none"> • Wait five minutes when the power is turned on while the temperature is low (approximately 0 °C (32 °F)). • Install the projector in a location with the operating environment temperature between 0 °C (32 °F) and 50 °C (122 °F)*1.
	<ul style="list-style-type: none"> • Internal temperature is high (warning). 	<ul style="list-style-type: none"> • Remove any objects if they are blocking the air intake/exhaust port. • Install the projector in a location with the operating environment temperature between 0 °C (32 °F) and 50 °C (122 °F)*1, and ambient humidity between 10 % and 80 % (no condensation).
Blinking in red (2 times)	<ul style="list-style-type: none"> • Internal temperature is high (standby status). 	
Blinking in red (3 times)	<ul style="list-style-type: none"> • The cooling fan has stopped. 	<ul style="list-style-type: none"> • Turn the <MAIN POWER> switch to <OFF> (➔ page 69), and consult your dealer.

*1 The operating environment temperature should be between 0 °C (32 °F) and 45 °C (113 °F) if the projector is used at an altitude between 1 400 m (4 593') and 4 200 m (13 780') above sea level.

Note

- If the temperature indicator <TEMP> is still lit or blinking after taking the measures, ask your dealer for repair.

Maintenance

Before maintenance

- Make sure to turn off the power before performing the maintenance of the projector.
- When switching off the projector, make sure to follow the procedures in “Switching off the projector” (➔ page 69).

Maintenance

Outer case

Wipe off dirt and dust with a soft, dry cloth.

- If the dirt is persistent, soak the cloth with water and wring it thoroughly before wiping. Dry off the projector with a dry cloth.
- Do not use benzene, thinner, or rubbing alcohol, other solvents, or household cleaners. Doing so may deteriorate the outer case.
- When using chemically treated dust cloths, follow the instructions written on its packaging.

Lens front surface

Wipe off dirt and dust from the front surface of the lens with a soft clean cloth.

- Do not use a cloth that is fluffy, dusty, or soaked with oil/water.
- Since the lens is fragile, do not use excessive force when wiping the lens.

Attention

- The lens is made of glass. Impacts or excessive force when wiping may scratch its surface. Handle with care.

Note

- Dust may accumulate around the air intake port depending on the environment or usage conditions such as when using the projector in a dusty place. If the projector is used in such environment, the circulation of ventilation, cooling, and heat exhaust may weaken, causing the luminance to dimmer.

Troubleshooting

Review the following points. For details, see the corresponding pages.

Problems	Points to be checked	Page
Power does not turn on.	• Is the power plug firmly inserted into the outlet?	—
	• Is the <MAIN POWER> switch set to <OFF>?	69
	• Is the wall outlet supplying electricity?	—
	• Have the circuit breakers tripped?	—
	• Are the light source indicators <LIGHT1>/<LIGHT2> or the temperature indicator <TEMP> lighting or blinking?	210
No image appears.	• Are connections to external devices correctly performed?	52
	• Is the image input selected correctly?	70
	• Is the [BRIGHTNESS] adjustment setting at a minimum?	92
	• Is the external device that is connected to the projector working properly?	—
	• Is the shutter function in use?	80
	• Is the projection lens attached correctly?	49
	• If the power indicator <ON (G)/STANDBY (R)> is blinking in red, consult your dealer.	—
	• Is the lens cover still attached to the lens?	61
Image is fuzzy.	• Is the lens focus set correctly?	71
	• Is the projection distance appropriate?	38
	• Is the lens dirty?	24
	• Is the projector installed perpendicular to the screen?	—
Color is pale or grayish.	• Are [COLOR] and [TINT] adjusted correctly?	92
	• Is the external device connected to the projector adjusted correctly?	—
	• Is the RGB cable damaged?	—
Remote control does not respond.	• Are the batteries depleted?	—
	• Is the polarity of the batteries set correctly?	33
	• Is the button operation disabled by sliding the <LOCK> button on the remote control?	28
	• Are there any obstructions between the remote control and the remote control signal receiver of the projector?	29
	• Is the remote control being used beyond its effective operation range?	29
	• Are other forms of light, such as fluorescent light, affecting the projection?	29
	• Is the [REMOTE CONTROL] setting in [CONTROL DEVICE SETUP] set to [DISABLE]?	179
	• Is the <REMOTE 2 IN> terminal used for contact control?	233
• Is the ID number setting operation correct?	83	
Menu screen does not appear.	• Is the on-screen display function turned off (hidden)?	130
Buttons on the control panel do not operate.	• Is the [CONTROL PANEL] setting in [CONTROL DEVICE SETUP] set to [DISABLE]?	179
	• Is the <REMOTE 2 IN> terminal used for contact control?	233
Image does not display correctly.	• Is the [SYSTEM SELECTOR] selection set correctly?	98, 129
	• Is the [RGB1 INPUT SETTING] setting made correctly?	122
	• Is there a problem with the external device to output images?	—
	• Is a signal which is not compatible with the projector being input?	238
Image from a computer does not appear.	• Is the cable too long? (For D-Sub cables, the cable length should be 10 m (32'10") or shorter.)	—
	• Is the external video output on the laptop computer set correctly? (Ex.: The external output settings may be switched by pressing the "Fn" + "F3" or "Fn" + "F10" simultaneously. Since the method varies depending on the computer type, refer to the user manual provided with your computer.)	—
Image output from DVI-D of the computer does not appear.	• Is [EDID SELECT] in [DVI-D IN] set to [EDID3] or [EDID2:PC]?	123
	• The graphics accelerator driver of the computer may need to be updated to the latest version.	—
	• The condition may be improved by making the [EDID SELECT] setting in [DVI-D IN] and then restarting the computer.	123
Image from HDMI compatible device does not appear or is disrupted.	• Is the HDMI cable connected securely?	52
	• Turn the power of the projector and the external device off and on.	—
	• Is a signal which is not compatible with the projector being input?	238

Chapter 6 Maintenance — Troubleshooting

Problems	Points to be checked	Page
Lens shift cannot be adjusted.	<ul style="list-style-type: none"> • Perform [LENS CALIBRATION]. • Is the Fixed-focus Lens (Model No.: ET-D75LE50) attached? 	73 —
Cannot control the projector with Art-Net.	<ul style="list-style-type: none"> • Are the connections between the twisted-pair-cable transmitter and an external device, and between the twisted-pair-cable transmitter and projector correctly done? • Is [Art-Net SETUP] set to other than [OFF]? • Are [NET], [SUB NET], [UNIVERSE], and [START ADDRESS] set correctly? 	— 184 184
The DIGITAL LINK input image is not displayed.	<ul style="list-style-type: none"> • Is the cable compatible to the condition of the projector used? • Are the connections between the twisted-pair-cable transmitter and the projector or an external device correctly done? • Is [DIGITAL LINK MODE] set to [AUTO], [DIGITAL LINK], or [LONG REACH]? Is it set to [ETHERNET]? • Is a signal which is not compatible with a twisted-pair-cable transmitter being input? 	55 — 182 —
3D function is not working.	<ul style="list-style-type: none"> • Is the [3D INPUT FORMAT] setting of [3D SETTINGS] correct? • Check the 3D eyewear settings. • Is a signal which is supported by the projector being input? 	113 — 243
Left and right images are reversed (not showing properly).	<ul style="list-style-type: none"> • Is it synchronized? Check the 3D eyewear settings. • Change the [LEFT/RIGHT SWAP] setting of [3D SETTINGS]. 	— 113
Image in the 3D eyewear flickers.	<ul style="list-style-type: none"> • Are you within the reception range? 	—
3D eyewear is not functioning.	<ul style="list-style-type: none"> • Is the battery for 3D eyewear dead? Charge the battery for the rechargeable 3D eyewear. Change the battery for the battery type. • Is the [3D SETTINGS] setting correct? 	— 112

Attention

- If problems persist even after checking the preceding points, consult your dealer.

Self-diagnosis display

There is a self-diagnosis display on the side of the projector. Self-diagnosis display will automatically display the value of the input supply voltage, or details of errors or warnings when they occur. (➔ page 31)

The following list shows the alphanumeric symbol that is displayed when an error or a warning has occurred and its details. Confirm “Action number”, and follow the measure in “Measure for error and warning” (➔ page 217).

The input supply voltage is displayed only with the numeric value.

Error/warning alphanumeric symbol	Error/warning alphanumeric symbol content	Action number
U11	Intake temperature warning	1
U12	Optical module temperature warning	1
U13	Exhaust air temperature warning	2
U14	Low temperature warning	3
U16	Light source 1 temperature warning	1
U17	Light source 2 temperature warning	1
U21	Intake temperature error	1
U22	Optical module temperature error	1
U23	Exhaust air temperature error	2
U24	Low temperature error	3
U25	Light source 1 temperature error	1
U26	Light source 2 temperature error	1
U81	Low AC voltage warning (below 90 V)	4
U84	<DC OUT 1>/<DC OUT 2> terminal power supply error	5
U90	Projection lens not attached	6
UA0	Power supply temperature warning	1
UA1	FPGA temperature warning	1
UA4	Power supply temperature error	1
UA5	FPGA temperature error	1
H01	Battery replacement for the internal clock	7
H11	Intake air temperature sensor error	8
H12	Optical module temperature sensor error	8
H13	Exhaust air temperature sensor error	8
H14	Light source 1 temperature sensor error	8
H15	Light source 2 temperature sensor error	8
F00	Liquid cooling pump R warning	8
F01	Liquid cooling pump G warning	8
F02	Liquid cooling pump B warning	8
F03	Liquid cooling pump light source 1 warning	8
F04	Liquid cooling pump light source 2 warning	8
F11	Shutter error	8
F15	Luminance sensor error	8
F50	Radiator fan 1 warning	8
F51	Radiator fan 2 warning	8
F52	Radiator fan 3 warning	8
F53	Radiator fan 4 warning	8
F54	Radiator fan 5 warning	8
F55	Radiator fan 6 warning	8
F56	Exhaust fan 1 warning	8
F57	Exhaust fan 2 warning	8
F58	DMD fan 1 warning	8
F59	DMD fan 2 warning	8
F70	Heat pipe fan warning	8
F71	Circulation fan 1 warning	8
F72	Circulation fan 2 warning	8
F73	Color prism fan 1 warning	8
F74	Color prism fan 2 warning	8
F75	Color prism fan 3 warning	8
F76	Color prism fan 4 warning	8
F77	Circuit intake fan 1 warning	8

Chapter 6 Maintenance — Self-diagnosis display

Error/warning alphanumeric symbol	Error/warning alphanumeric symbol content	Action number
F78	Circuit intake fan 2 warning	8
F79	Light source driver fan warning	8
F61	Light source 1 driver communication error	8
F62	Light source 2 driver communication error	8
F96	Lens mounter error	8
FA8	Light source 1 error	8
FC8	Light source 2 error	8
FE0	Light source driver fan error	8
FE1	Radiator fan 1 error	8
FE2	Radiator fan 2 error	8
FE3	Radiator fan 3 error	8
FE4	Radiator fan 4 error	8
FE5	Radiator fan 5 error	8
FE6	Radiator fan 6 error	8
FE7	Exhaust fan 1 error	8
FE8	Exhaust fan 2 error	8
FE9	DMD fan 1 error	8
FF0	DMD fan 2 error	8
FF1	Heat pipe fan error	8
FF2	Circulation fan 1 error	8
FF3	Circulation fan 2 error	8
FF4	Color prism fan 1 error	8
FF5	Color prism fan 2 error	8
FF6	Color prism fan 3 error	8
FF7	Color prism fan 4 error	8
FF8	Circuit intake fan 1 error	8
FF9	Circuit intake fan 2 error	8
FH0	Phosphor wheel 1 error SUB	8
FH1	Phosphor wheel 1 error FPGA	8
FH2	Phosphor wheel 2 error SUB	8
FH3	Phosphor wheel 2 error FPGA	8
FJ0	Liquid cooling pump R error	8
FJ1	Liquid cooling pump G error	8
FJ2	Liquid cooling pump B error	8
FJ3	Liquid cooling pump light source 1 error	8
FJ4	Liquid cooling pump light source 2 error	8
FL1	Light source 1 unit error	8
FL2	Light source 2 unit error	8

Note

- The self-diagnosis display and the details of the malfunction may vary.
- For errors and warnings that are not described in the table, consult your dealer.

■ Measure for error and warning

Action number	Measure
1	The operating environment temperature is too high. Use the projector in an appropriate operating environment temperature*1.
2	The operating environment temperature is too high, or the air exhaust port may be blocked. Use the projector in an appropriate operating environment temperature*1. Or remove any objects that are blocking the air exhaust port.
3	The operating environment temperature is too low. Use the projector in an appropriate operating environment temperature*1.
4	The input supply voltage is low. Use electric wiring that can sufficiently withstand the power consumption of the projector.
5	The output total value for the <DC OUT 1> terminal/<DC OUT 2> terminals is too high. The total value of the power supply required for the connected device may be exceeding DC 5 V/2 000 mA. If the display does not clear after the device is removed, consult your dealer.
6	The projection lens cannot be detected. Turn off the power and attach the projection lens again. If the display does not clear after switching the power off and on, consult your dealer.
7	Battery replacement is required. Consult your dealer.
8	If the display does not clear after switching the main power off and on, consult your dealer.

*1 Refer to "Operating environment temperature" (➡ page 246) for the operating environment temperature of the projector.

Chapter 7 Appendix

This chapter describes specifications and after-sales service for the projector.

Technical information

PJLink protocol

The network function of this projector supports the PJLink class 1 and class 2, and setting of the projector or querying of the projector status can be performed from the computer using the PJLink protocol.

Control commands

The following table lists the PJLink protocol commands that can be used to control the projector.

• x characters in tables are non-specific characters.

Class	Command	Control details	Parameter/response string	Remark		
1	POWR	Power supply control	0 1	Standby Power on		
1	POWR ?	Power supply status query	0 1 2	Standby Power on Preparing for switching off the projector		
1, 2	INPT	Input selection	11 12	RGB1 RGB2		
	INPT ?	Input selection query	31 32 33 34 35	DVI-D HDMI DIGITAL LINK SDI1 SDI2		
1	AVMT	Shutter control	30	Shutter function disabled (shutter: open)		
	AVMT ?	Shutter status query	31	Shutter function enabled (shutter: closed)		
1	ERST ?	Error status query	xxxxxx	1st byte	Indicates fan errors, and returns 0 - 2.	<ul style="list-style-type: none"> • 0 = No error is detected • 1 = Warning • 2 = Error
				2nd byte	Indicates light source errors, and returns 0 or 2.	
				3rd byte	Indicates temperature errors, and returns 0 - 2.	
				4th byte	Returns 0.	
				5th byte	Returns 0.	
				6th byte	Indicates other errors, and returns 0 - 2.	
1	LAMP ?	Light source status query	AAAA X BBBB Y	AAAA: Light source 1 runtime X: 0 = Light source 1 off, 1 = Light source 1 on BBBB: Light source 2 runtime Y: 0 = Light source 2 off, 1 = Light source 2 on		
1, 2	INST ?	Input selection list query	11 12 31 32 33 34 35	—		
1	NAME ?	Projector name query	xxxxx	Returns the name set in [PROJECTOR NAME] of [NETWORK SETUP].		
1	INF1 ?	Manufacturer name query	Panasonic	Returns manufacturer name.		
1	INF2 ?	Model name query	PT-RZ21K PT-RS20K	Returns model name.		
1	INF0 ?	Other information queries	xxxxx	Returns information such as version number.		
1	CLSS ?	Class information query	2	Returns class for PJLink.		
2	SNUM ?	Serial number query	xxxxxxxxx	Returns serial number.		
2	SVER ?	Software version query	xxxxxxxxx	Returns version number.		
2	INNM ?	Input terminal name query	11 / RGB1 12 / RGB2 31 / DVI-D 32 / HDMI 33 / DIGITAL LINK 34 / SDI1 35 / SDI2	Returns input terminal name.		

Class	Command	Control details	Parameter/response string	Remark
2	IRES ?	Input signal resolution query	AAAAxBBBB	AAAA: Horizontal resolution BBBB: Vertical resolution
2	RRES ?	Recommended resolution query	1920x1200 1400x1050	Returns the number of pixels.
2	FREZ	Freeze control	0	Freeze clear
	FREZ ?	Freeze status query	1	Freeze (stop)
2	POWR	Cooling notification	0	Notifies when the power is turned off.
		Warmup notification	1	Notifies when the power is turned on.
2	ERST	Error notification	xxxxxx	Notifies when an error occurs.
2	LKUP	Link up notification	xx:xx:xx:xx:xx:xx	Notifies the MAC address when the PJLink communication becomes possible.
2	INPT	Input switch completion notification	11 12 31 32 33 34 35	RGB1 RGB2 DVI-D HDMI DIGITAL LINK SDI1 SDI2
2	SRCH	Projector search	ACKN=xx:xx:xx:xx:xx:xx	The projector connected to the same network that can communicate with PJLink will respond with its MAC address.

PJLink security authentication

The password used for PJLink is the same as that of the password set for web control.

When using the projector without security authentication, do not set a password for web control.

- For specifications related to PJLink, visit the website of Japan Business Machine and Information System Industries Association.

URL <http://pjlink.jbmia.or.jp/english/>

Using Art-Net function

Since the network function of the projector supports the Art-Net function, you can control the projector settings with the DMX controller and application software using the Art-Net protocol.

Channel definition

The following table lists the channel definitions used for controlling the projector with the Art-Net function. Channel settings can be switched using the [NETWORK] menu → [Art-Net CHANNEL SETTING] (➡ page 185).

The control details assigned to each channel are listed in the following table.

- Channel assignment for [USER] is in factory default setting. Assignment can be changed.

Channel	Control details			
	[1]	[2]	[3]	[USER]
CHANNEL1	SHUTTER	LIGHT OUTPUT	LIGHT OUTPUT	LIGHT OUTPUT
CHANNEL2	INPUT SELECT	INPUT SELECT	INPUT SELECT	INPUT SELECT
CHANNEL3	LENS FUNCTION SELECT	LENS POSITION	LENS POSITION	LENS POSITION
CHANNEL4	LENS CONTROL	LENS H SHIFT	LENS H SHIFT	LENS H SHIFT
CHANNEL5	POWER	LENS V SHIFT	LENS V SHIFT	LENS V SHIFT
CHANNEL6	LIGHT OUTPUT	LENS FOCUS	LENS FOCUS MSB	LENS FOCUS
CHANNEL7	ENABLE/DISABLE	LENS ZOOM	LENS FOCUS LSB	LENS ZOOM
CHANNEL8	FADE-IN	POWER	LENS ZOOM MSB	POWER
CHANNEL9	FADE-OUT	GEOMETRY	LENS ZOOM LSB	GEOMETRY
CHANNEL10	CUSTOM MASKING	CUSTOM MASKING	SHUTTER	CUSTOM MASKING
CHANNEL11	GEOMETRY	ENABLE/DISABLE	ENABLE/DISABLE	ENABLE/DISABLE
CHANNEL12	NONE	NONE	NONE	NONE

Content that can be controlled by each Art-Net channel setting

✓: Can be controlled

Control details	Art-Net channel setting			
	[1]	[2]	[3]	[USER]
LIGHT OUTPUT	✓	✓	✓	✓
INPUT SELECT	✓	✓	✓	✓
LENS FUNCTION SELECT	✓	—	—	—
LENS CONTROL	✓	—	—	—
LENS POSITION	—	✓	✓	✓
LENS H SHIFT	—	✓	✓	✓
LENS V SHIFT	—	✓	✓	✓
LENS FOCUS	—	✓	—	✓
LENS ZOOM	—	✓	—	✓
POWER	✓	✓	—	✓
SHUTTER	✓	—	✓	✓
FADE-IN	✓	—	—	✓
FADE-OUT	✓	—	—	✓
GEOMETRY	✓	✓	—	✓
CUSTOM MASKING	✓	✓	—	✓
FREEZE	—	—	—	✓
COLOR	—	—	—	✓
TINT	—	—	—	✓
RASTER PATTERN	—	—	—	✓
LENS H SHIFT MSB	—	—	—	✓*1
LENS H SHIFT LSB	—	—	—	✓*1
LENS V SHIFT MSB	—	—	—	✓*1
LENS V SHIFT LSB	—	—	—	✓*1
LENS FOCUS MSB	—	—	✓	✓*1
LENS FOCUS LSB	—	—	✓	✓*1

Control details	Art-Net channel setting			
	[1]	[2]	[3]	[USER]
LENS ZOOM MSB	—	—	✓	✓*1
LENS ZOOM LSB	—	—	✓	✓*1
ENABLE/DISABLE	✓	✓	✓	✓

*1 These items can be controlled in following case.
 When the standard DC motor unit installed in the Zoom Lens (Model No.: ET-D75LE6, ET-D75LE8, ET-D75LE10, ET-D75LE20, ET-D75LE30, ET-D75LE40, etc.) is replaced with the stepping motor unit using the Stepping Motor Kit (Model No.: ET-D75MKS10), or when a projection lens with the stepping motor is attached.

Control details

■ LIGHT OUTPUT

This can be set in 256 steps between 100 % and 0 %.

Performance	Parameter	Default value
100 %	0	0
...	...	
0 %	255	

■ INPUT SELECT (when [Art-Net CHANNEL SETTING] is set to [1])

Performance	Parameter	Default value
No operation	0-7	0
RGB1	8-15	
RGB2	16-23	
No operation	24-31	
DVI-D	32-39	
HDMI	40-47	
SDI1	48-55	
SDI2	56-63	
No operation	64-127	
Execute P IN P, USER1	128-135	
Execute P IN P, USER2	136-143	
Execute P IN P, USER3	144-151	
No operation	152-255	

■ INPUT SELECT (when [Art-Net CHANNEL SETTING] is set to anything other than [1])

Performance	Parameter	Default value
No operation	0-7	0
RGB1	8-15	
RGB2	16-23	
DVI-D	24-31	
HDMI	32-39	
DIGITAL LINK	40-47	
SDI1	48-55	
SDI2	56-63	
No operation	64-119	
P IN P OFF	120-127	
Execute P IN P, USER1	128-135	
Execute P IN P, USER2	136-143	
Execute P IN P, USER3	144-151	
No operation	152-255	

■ LENS FUNCTION SELECT

Operate together with LENS CONTROL.

Performance	Parameter	Default value
No operation	0-15	0
LENS H SHIFT	16-31	
LENS V SHIFT	32-47	
LENS FOCUS	48-63	
LENS ZOOM	64-79	
Move to the home position	80-95	
Load LENS MEMORY 1	96-111	
Load LENS MEMORY 2	112-127	
Load LENS MEMORY 3	128-143	
No operation	144-255	

■ LENS CONTROL

Operate together with LENS FUNCTION SELECT.

Performance	Parameter	Default value		
Lens adjustment	(-) High speed	0-31	100	
	(-) Low speed	32-63		
	(-) Fine adjustment	64-95		
Operation stop	96-127			
Lens adjustment	(+) Fine adjustment	128-159		
	(+) Low speed	160-191		
	(+) High speed	192-223		
Execute command action	224-255			

■ LENS POSITION

Performance	Parameter	Default value
No operation	0-31	0
Move to the home position	32-63	
Load LENS MEMORY 1	64-79	
Load LENS MEMORY 2	80-95	
Load LENS MEMORY 3	96-111	
Load LENS MEMORY 4	112-127	
Load LENS MEMORY 5	128-143	
Load LENS MEMORY 6	144-159	
Load LENS MEMORY 7	160-175	
Load LENS MEMORY 8	176-191	
Load LENS MEMORY 9	192-207	
Load LENS MEMORY 10	208-223	
No operation	224-255	

■ LENS H SHIFT, LENS V SHIFT, LENS FOCUS, LENS ZOOM

Performance	Parameter	Default value		
Lens adjustment	(-) High speed	0-31	128	
	(-) Low speed	32-63		
	(-) Fine adjustment	64-95		
Operation stop	96-159			
Lens adjustment	(+) Fine adjustment	160-191		
	(+) Low speed	192-223		
	(+) High speed	224-255		

■ POWER

Performance	Parameter	Default value
Standby	0-63	128
No operation	64-191	
Power on	192-255	

■ SHUTTER

Performance	Parameter	Default value
SHUTTER: Open	0-63	128
No operation	64-191	
SHUTTER: Closed	192-255	

■ FADE-IN, FADE-OUT

Operate together with SHUTTER.

Performance	Parameter	Default value
OFF	0-15	255
0.5s	16-31	
1.0s	32-47	
1.5s	48-63	
2.0s	64-79	
2.5s	80-95	
3.0s	96-111	
3.5s	112-127	
4.0s	128-143	
5.0s	144-159	
7.0s	160-175	
10.0s	176-191	
No operation	192-255	

■ GEOMETRY

Performance	Parameter	Default value
OFF	0-15	255
KEYSTONE	16-31	
CURVED CORRECTION	32-47	
PC-1	48-63	
PC-2	64-79	
PC-3	80-95	
CORNER/PINCUSHION	96-111	
No operation	112-255	

■ CUSTOM MASKING

To use PC-1, PC-2, or PC-3, the optional Upgrade Kit (Model No.: ET-UK20) is required.

Performance	Parameter	Default value
OFF	0-31	255
PC-1	32-63	
PC-2	64-95	
PC-3	96-127	
No operation	128-255	

■ FREEZE

Performance	Parameter	Default value
No operation	0-31	128
OFF	32-95	
No operation	96-159	
ON	160-223	
No operation	224-255	

■ COLOR, TINT

Performance	Parameter	Default value
No operation	0-31	0
Factory default setting	32-63	
-31	64	
...	...	
0	128-129	
...	...	
+31	191	
No operation	192-255	

■ RASTER PATTERN

Performance	Parameter	Default value
No operation	0-15	0
OFF	16-31	
WHITE	32-47	
YELLOW	48-63	
CYAN	64-79	
GREEN	80-95	
MAGENTA	96-111	
RED	112-127	
BLUE	128-143	
BLACK	144-159	
USER LOGO	160-175	
No operation	176-255	

■ LENS H SHIFT MSB, LENS V SHIFT MSB, LENS FOCUS MSB, LENS ZOOM MSB

Operate LENS H SHIFT MSB together with LENS H SHIFT LSB.

Operate LENS V SHIFT MSB together with LENS V SHIFT LSB.

Operate LENS FOCUS MSB together with LENS FOCUS LSB.

Operate LENS ZOOM MSB together with LENS ZOOM LSB.

Performance	Parameter	Default value
No operation	0-15	0
Coarse adjustment	16-255	

■ LENS H SHIFT LSB, LENS V SHIFT LSB, LENS FOCUS LSB, LENS ZOOM LSB

Operate LENS H SHIFT LSB together with LENS H SHIFT MSB.

Operate LENS V SHIFT LSB together with LENS V SHIFT MSB.

Operate LENS FOCUS LSB together with LENS FOCUS MSB.

Operate LENS ZOOM LSB together with LENS ZOOM MSB.

Performance	Parameter	Default value
No operation	0-15	0
Fine adjustment	16-255	

■ ENABLE/DISABLE

Operation for all channels is not accepted when set to “Disable”.

Performance	Parameter	Default value
Disable	0-127	0
Enable	128-255	

Note

- If the projector is operated using the remote control or the control panel, or by the control command while controlling the projector using the Art-Net function, the setting of the DMX controller or computer application may be different from the projector status. To reflect the controls of all channels to the projector, set “ENABLE/DISABLE” of channel 11 to “Disable” and then back to “Enable”.
- To create and register the USER LOGO image, use “Logo Transfer Software”. The software can be downloaded from the Panasonic website (<https://panasonic.net/cns/projector/>).

Control commands via LAN

When web control administrator rights password is set (Protect mode)

Connecting

- 1) Obtain the IP address and port number (Initial set value = 1024) of the projector and request a connection to the projector.

- You can obtain both the IP address and the port number from the menu screen of the projector.

IP address	Obtain from the [NETWORK] menu → [NETWORK STATUS].
Port number	Obtain from the [NETWORK] menu → [NETWORK CONTROL] → [COMMAND PORT].

- 2) Check the response from the projector.

	Data section	Blank	Mode	Blank	Random number section	Termination symbol
Command example	“NTCONTROL” (ASCII string)	‘ ’ 0x20	‘1’ 0x31	‘ ’ 0x20	“zzzzzzzz” (ASCII code hex number)	(CR) 0x0d
Data length	9 bytes	1 byte	1 byte	1 byte	8 bytes	1 byte

- Mode: 1 = Protect mode
- Example: Response during protect mode (random number section is undefined value)
“NTCONTROL 1 23181e1e” (CR)

- 3) Generate a 32-byte hash value from the following data using MD5 algorithm.

- “xxxxxx:yyyy:zzzzzzzz”

xxxxxx	Administrator rights user name for the web control (default user name is “dispadmin”)
yyyyy	Password of above administrator rights user (default password is “@Panasonic”)
zzzzzzzz	8-byte random number obtained in Step 2)

Command transmission method

Transmit using the following command formats.

■ Transmitted data

	Header			Data section	Termination symbol
Command example	Hash value “Connecting” (➔ page 226)	‘0’ 0x30	‘0’ 0x30	Control command (ASCII string)	(CR) 0x0d
Data length	32 bytes	1 byte	1 byte	Undefined length	1 byte

- Example: Transmission of power supply status acquisition command (hash value is calculated from default user name, password, and acquired random number)
“dbdd2dabd3d4d68c5dd970ec0c29fa6400QPW” (CR)

■ Received data

	Header		Data section	Termination symbol
Command example	'0' 0x30	'0' 0x30	Control command (ASCII string)	(CR) 0x0d
Data length	1 byte	1 byte	Undefined length	1 byte

- Example: The projector is powered on "00001" (CR)

■ Error response

	String	Details	Termination symbol
Message	"ERR1"	Undefined control command	(CR) 0x0d
	"ERR2"	Out of parameter range	
	"ERR3"	Busy state or no-acceptable period	
	"ERR4"	Timeout or no-acceptable period	
	"ERR5"	Wrong data length	
	"ERRA"	Password mismatch	
Data length	4 bytes	—	1 byte

Note

- The projector will automatically disconnect the connection with the network right after sending the command. This is the specification based on the security view point to prevent unauthorized operation of this product by a malicious third party. To send commands continuously, execute the network connection request every time the command is to be sent. For details, refer to "Communication flow between server and client" (➔ page 228).

When web control administrator rights password is not set (Non-protect mode)

Connecting

- 1) Obtain the IP address and port number (Initial set value = 1024) of the projector and request a connection to the projector.

- You can obtain both the IP address and the port number from the menu screen of the projector.

IP address	Obtain from the [NETWORK] menu → [NETWORK STATUS].
Port number	Obtain from the [NETWORK] menu → [NETWORK CONTROL] → [COMMAND PORT].

- 2) Check the response from the projector.

	Data section	Blank	Mode	Termination symbol
Command example	"NTCONTROL" (ASCII string)	' ' 0x20	'0' 0x30	(CR) 0x0d
Data length	9 bytes	1 byte	1 byte	1 byte

- Mode: 0 = Non-protect mode
- Example: Response during non-protect mode "NTCONTROL 0" (CR)

Command transmission method

Transmit using the following command formats.

■ Transmitted data

	Header		Data section	Termination symbol
Command example	'0' 0x30	'0' 0x30	Control command (ASCII string)	(CR) 0x0d

	Header		Data section	Termination symbol
Data length	1 byte	1 byte	Undefined length	1 byte

- Example: Transmission of power supply status acquisition command
"00QPW" (CR)

■ Received data

	Header		Data section	Termination symbol
Command example	'0' 0x30	'0' 0x30	Control command (ASCII string)	(CR) 0x0d
Data length	1 byte	1 byte	Undefined length	1 byte

- Example: The power of the projector is in standby status
"00000" (CR)

■ Error response

	String	Details	Termination symbol
Message	"ERR1"	Undefined control command	(CR) 0x0d
	"ERR2"	Out of parameter range	
	"ERR3"	Busy state or no-acceptable period	
	"ERR4"	Timeout or no-acceptable period	
	"ERR5"	Wrong data length	
	"ERRA"	Password mismatch	
Data length	4 bytes	—	1 byte

Note

- The projector will automatically disconnect the connection with the network right after sending the command. This is the specification based on the security view point to prevent unauthorized operation of this product by a malicious third party. To send commands continuously, execute the network connection request every time the command is to be sent. For details, refer to "Communication flow between server and client" (➔ page 228).

Communication flow between server and client

To send/receive a command via LAN, refer to the communication flow indicated below.

Server: Projector

Client: Control device such as a computer

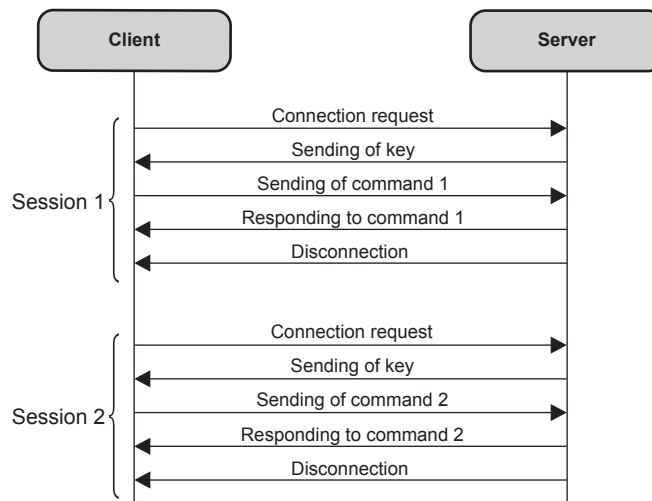

<SERIAL IN>/<SERIAL OUT> terminal

The <SERIAL IN>/<SERIAL OUT> terminal of the projector conforms with RS-232C so that the projector can be connected to and controlled from a computer.

Connection

Single projector

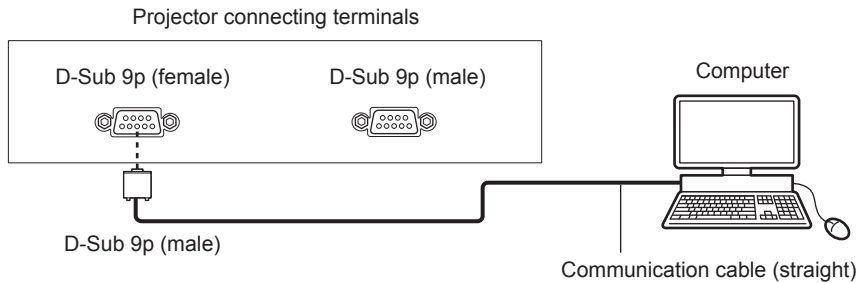

Multiple projectors

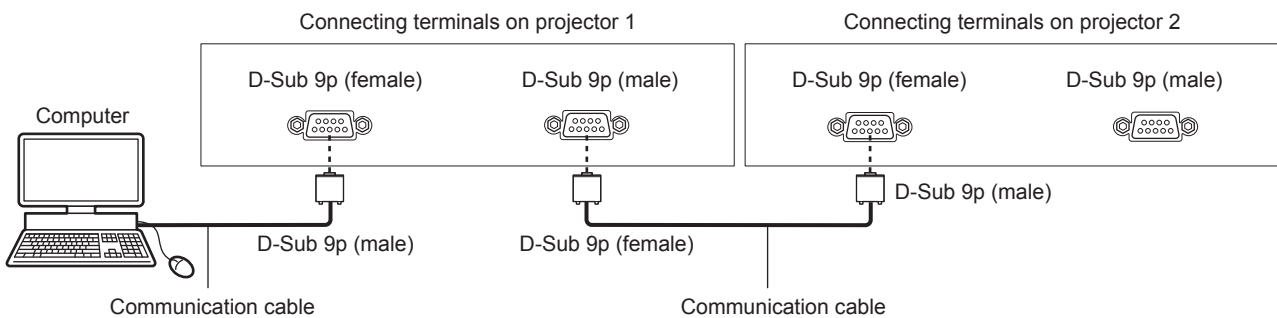

When connecting using DIGITAL LINK compatible device

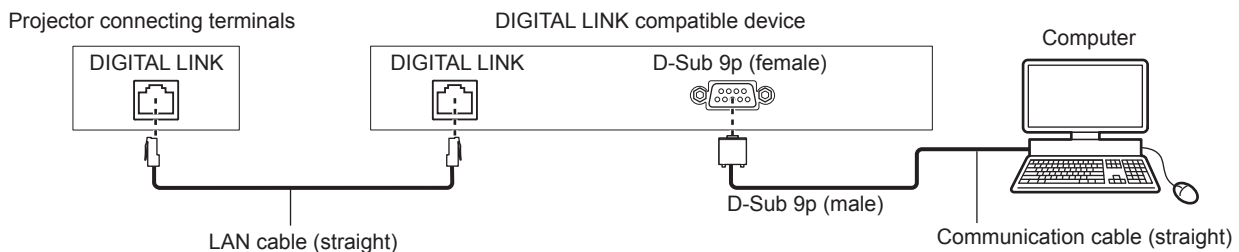

Note

- The destination of [RS-232C] (➔ page 165) must be set according to the connection method.
- To control the projector with standby mode when connecting utilizing the DIGITAL LINK compatible device, set the [PROJECTOR SETUP] menu → [STANDBY MODE] (➔ page 159) to [NORMAL].
When [STANDBY MODE] is set to [ECO], the projector cannot be control during standby.

Pin assignments and signal names

D-Sub 9-pin (female) Outside view	Pin No.	Signal name	Details
	(1)	—	NC
	(2)	TXD	Transmitted data
	(3)	RXD	Received data
	(4)	—	NC
	(5)	GND	Earth
	(6)	—	NC
	(7)	CTS	Connected internally
	(8)	RTS	
	(9)	—	NC

D-Sub 9-pin (male) Outside view	Pin No.	Signal name	Details
	(1)	—	NC
	(2)	RXD	Received data
	(3)	TXD	Transmitted data
	(4)	—	NC
	(5)	GND	Earth
	(6)	—	NC
	(7)	RTS	Connected internally
	(8)	CTS	
	(9)	—	NC

Communication conditions (Factory default)

Signal level	RS-232C-compliant
Sync. method	Asynchronous
Baud rate	9 600 bps
Parity	None
Character length	8 bits
Stop bit	1 bit
X parameter	None
S parameter	None

Basic format

Transmission from the computer starts with STX, then the ID, command, parameter, and ETX are sent in this order. Add parameters according to the details of control.

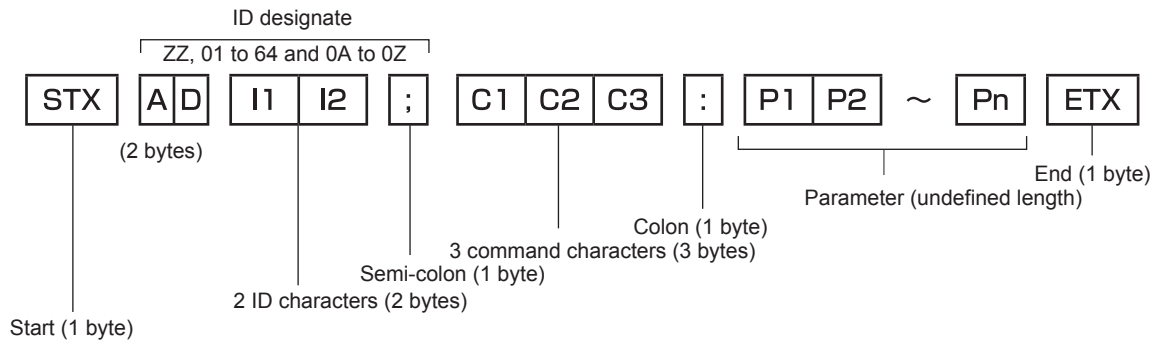

Basic format (has subcommands)

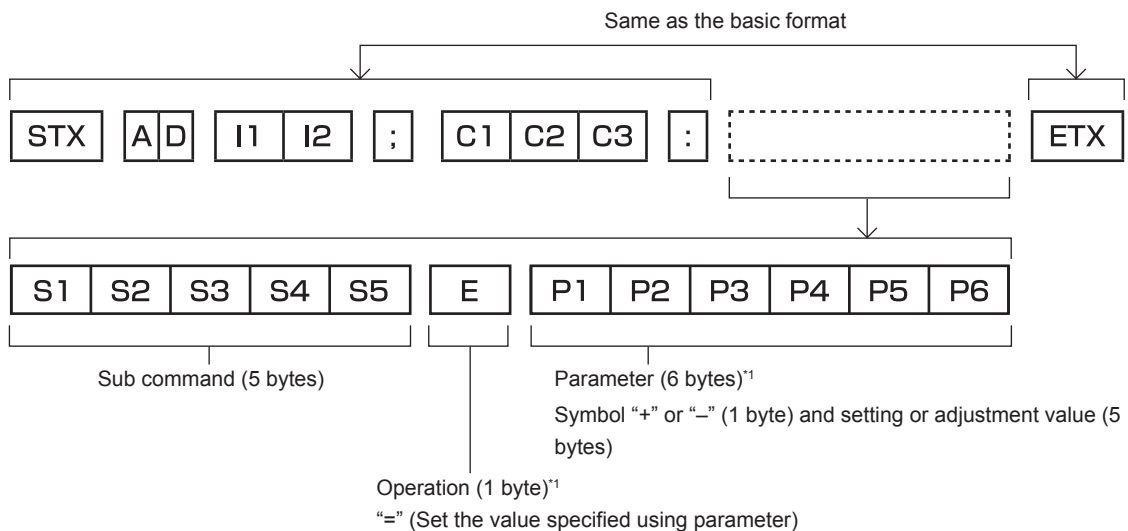

*1 When transmitting a command which does not need a parameter, an operation (E) and parameter are not necessary.

Attention

- If a command is sent after the light source starts lighting, there may be a delay in response or the command may not be executed. Try sending or receiving any command after 60 seconds.
- When transmitting multiple commands, be sure to wait until 0.5 seconds has elapsed after receiving the response from the projector before sending the next command. When transmitting a command which does not need a parameter, a colon (:) is not necessary.

Note

- If a command cannot be executed, the “ER401” response is sent from the projector to the computer.
- If an invalid parameter is sent, the “ER402” response is sent from the projector to the computer.
- ID transmission in RS-232C supports ZZ (ALL) and 01 to 64, as well as 0A to 0Z groups.
- If a command is sent with an ID designated, a response will be sent to the computer only in the following cases.
 - It matches the projector ID
 - ID is designated as ALL and [RESPONSE(ID ALL)] is set to [ON]
 - ID is designated as GROUP and [RESPONSE(ID GROUP)] is set to [ON]
- STX and ETX are character codes. STX shown in hexadecimal is 02, and ETX shown in hexadecimal is 03.

When multiple projectors are controlled

When multiple projectors are all controlled

When controlling multiple projectors together via RS-232C, perform the following settings.

- 1) Set a different ID for each projector.
- 2) Set [RESPONSE(ID ALL)] to [ON] in only one projector.
- 3) Set [RESPONSE(ID ALL)] to [OFF] for all other projectors set in Step 2).

When multiple projectors are all controlled by group unit

When controlling multiple projectors by group unit via RS-232C, perform the following settings.

- 1) Set a different ID for each projector.
- 2) Set the same setting for [GROUP] in each group.
- 3) Set [RESPONSE(ID GROUP)] to [ON] in only one projector.
- 4) Set [RESPONSE(ID GROUP)] to [OFF] for all other projectors set in Step 3).

Note

- Response is not made correctly if [RESPONSE(ID ALL)] is set to [ON] in two or more projectors.
- When setting multiple groups, set [RESPONSE(ID GROUP)] to [ON] in only one projector in each group. Response is not made correctly if [RESPONSE(ID GROUP)] is set to [ON] in two or more projectors of the same group.

Cable specification

When connected to a computer

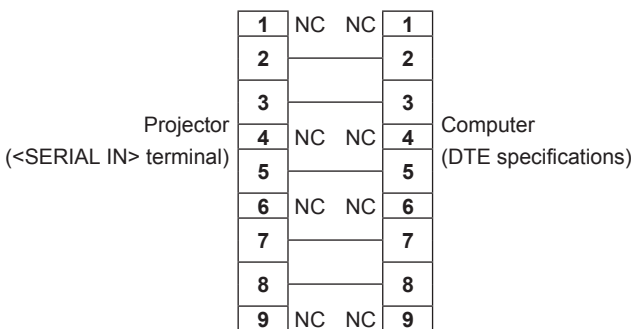

When multiple projectors are connected

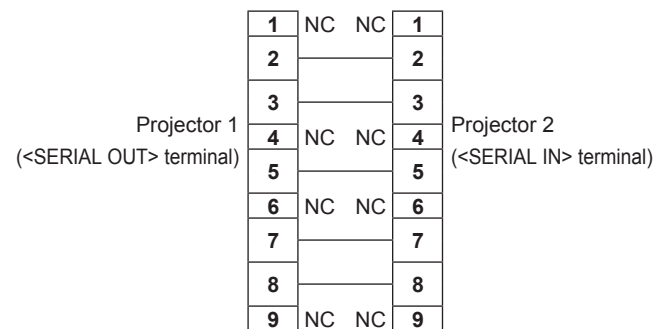

Control command

The following table lists the commands that can be used to control the projector using a computer.

■ Projector control command

Command	Details	Parameter/response string	Remark (parameter)
PON	Power on	—	To check if the power is on, use the "Power query" command.
POF	Power standby		
QPW	Power query	000 001	STANDBY Power on
IIS	Switching the input signal	RG1 RG2 DVI HD1 DL1 SD1 SD2	RGB1 RGB2 DVI-D HDMI DIGITAL LINK SDI1 SDI2
OSH	Shutter control	0	OPEN
QSH	Shutter status query	1	CLOSE
VSE	Aspect ratio switch	0 1 2 5	DEFAULT/VID AUTO/AUTO 4:3 16:9 THROUGH
QSE	Aspect ratio settings query	6 9 10	HV FIT H FIT V FIT
OPP	P IN P execution	0 1	OFF USER1
QPP	P IN P setting query	2 3	USER2 USER3
OCS	Sub memory switch	01 - 96	Sub memory number
QSB	Sub memory status query		

■ Projector control command (with sub command)

Command	Sub command	Details	Remark
VXX	RYCI1	RGB1 input setting	+00000 = RGB/YP _B P _R , +00001 = Y/C, +00002 = VIDEO

■ Lens control command

Command	Sub command	Details	Remark
VXX	LNSI2	Lens H shift	+00000 = Fine adjustment 1+, +00001 = Fine adjustment 1-, +00100 = Fine adjustment 2+, +00101 = Fine adjustment 2-, +00200 = Coarse adjustment+, +00201 = Coarse adjustment-
VXX	LNSI3	Lens V shift	
VXX	LNSI4	Lens focus	
VXX	LNSI5	Lens zoom	

<REMOTE 2 IN> terminal

It is possible to control the projector remotely (by external contact) from a control panel located away from the projector where remote control signals cannot reach.

Use the <REMOTE 2 IN> terminal on the connecting terminals of the projector to connect to the control panel.

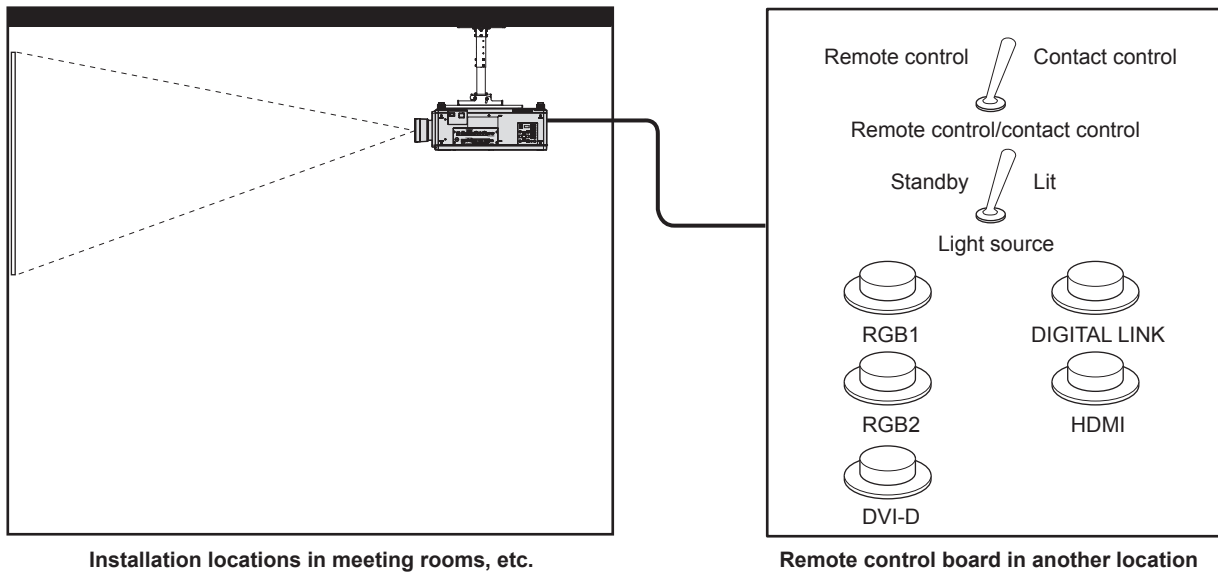

Installation locations in meeting rooms, etc.

Remote control board in another location

Pin assignments and signal names

D-Sub 9-pin Outside view	Pin No.	Signal name	Open (H)	Short (L)
	(1)	GND	—	GND
	(2)	POWER	OFF	ON
	(3)	RGB1	Other	RGB1
	(4)	RGB2	Other	RGB2
	(5)	DIGITAL LINK	Other	DIGITAL LINK
	(6)	HDMI	Other	HDMI
	(7)	DVI-D	Other	DVI-D
	(8)	SHUTTER	OFF	ON
	(9)	ENABLE / DISABLE	Controlled by remote control	Controlled by external contact

Attention

- When controlling, make sure to short-circuit pins (1) and (9).
- When pins (1) and (9) are short-circuited, the following buttons on the control panel and the remote control are disabled. Commands for RS-232C and network functions corresponding to these functions are also disabled.
 - Power on <|> button, power standby <⏻> button, <SHUTTER> button
- When pins (1) and (9) are short-circuited, and then any pins from (3) to (7) and the pin (1) are short-circuited, the following buttons on the control panel and the remote control are disabled. Commands for RS-232C and network functions corresponding to these functions are also disabled.
 - Power on <|> button, power standby <⏻> button, <RGB1> button, <RGB2> button, <DIGITAL LINK> button, <DVI-D> button, <HDMI> button, <SDI 1/2> button or <SDI> button, <INPUT MENU> button, <SHUTTER> button

Note

- For pin (2) to pin (8) settings, you can make changes if you set [REMOTE2 MODE] to [USER]. (➡ page 166)

Setting the IP address in standby status

The projector can set or confirm the IP address used to connect to the network in the standby status not projecting. Even at the stage before the installation (where the projection lens is not attached), the IP address can be set if the main power is turned on.

Note

- Setting or confirming of the IP address is not possible in following cases.
 - When the main power is turned off
 - When the power is turned on (in projecting status)

- When the [PROJECTOR SETUP] menu → [STANDBY MODE] is set to [ECO]
- Only confirmation of the IP address is possible in following case. Setting is not possible.
 - When the [NETWORK] menu → [Art-Net SETUP] is set to [ON(2.X.X.X)], [ON(10.X.X.X)]
- Setting and confirming of the subnet mask and default gateway are not possible. They are preset as follows as the factory default settings. If it is necessary to change from the current settings, turn on the projector, and set the [NETWORK] menu → [NETWORK SETUP].

[SUBNET MASK]	255.255.255.0
[DEFAULT GATEWAY]	192.168.0.1

Confirming the IP address

- 1) **Press the <ON> side of the <MAIN POWER> switch to turn on the power.**
 - The power indicator <ON (G)/STANDBY (R)> lights in red, and the projector enters the standby mode.
- 2) **Press and hold the <STATUS> button on the remote control for three seconds or more.**
 - Currently set IP address is displayed in the self-diagnosis display at the side of the projector.
 - For details on displaying of the IP address in the self-diagnosis display, refer to “IP address display transition” (➔ page 234).

Note

- [IP ADDRESS] can be confirmed in the [NETWORK] menu → [NETWORK STATUS] when the projector is turned on.

IP address display transition

The indication in the self-diagnosis display at the side of the projector will transition as follows in two second intervals when the IP address is displayed.

■ When [DHCP] is set to [OFF]

This is an example when the [NETWORK] menu → [NETWORK SETUP] → [DHCP] is set to [OFF], and [IP ADDRESS] is set to 192.168.0.8.

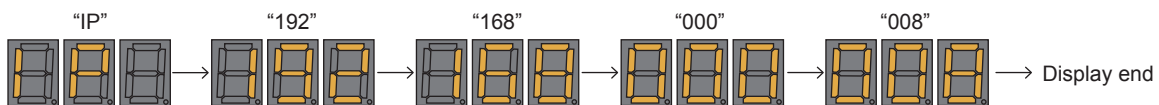

■ When [DHCP] is set to [ON]

This is an example when the [NETWORK] menu → [NETWORK SETUP] → [DHCP] is set to [ON], and [IP ADDRESS] is set to 192.168.0.8.

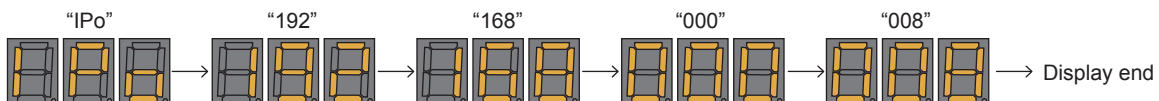

■ When the IP address cannot be acquired

This is when the IP address cannot be acquired from the DHCP server.

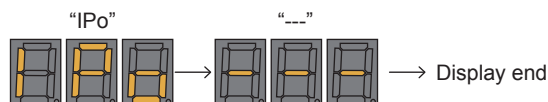

Setting the IP address

When using the DHCP server

IP address can be acquired automatically when there is a DHCP server in the network where the projector is to be connected.

- 1) **Press the <ON> side of the <MAIN POWER> switch to turn on the power.**
 - The power indicator <ON (G)/STANDBY (R)> lights in red, and the projector enters the standby mode.
- 2) **Press and hold the <STATUS> button on the remote control for three seconds or more.**
 - Currently set IP address is displayed in the self-diagnosis display at the side of the projector.

3) Press the <ENTER> button on the control panel.

- It will go into an IP address setting mode (where the self-diagnosis display is blinking in 0.5 second intervals).
- It will not go into the IP address setting mode even if the <ENTER> button on the remote control is pressed.

4) Press the <AUTO SETUP> button on the remote control or control panel.

- [DHCP] is set to [ON].
- The setting is reflected to the [NETWORK] menu → [NETWORK SETUP] → [DHCP].
- The IP address setting mode is canceled when the <AUTO SETUP> button is pressed, and the setting is displayed in the self-diagnosis display for approximately two seconds.

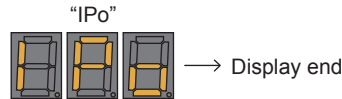

Note

- The IP address setting mode is canceled when no setting operation is performed for 10 seconds or longer in the IP address setting mode.
- The IP address will be set to the following factory default setting when the <DEFAULT> button on the remote control is pressed while in the IP address setting mode.

[DHCP]	OFF
[IP ADDRESS]	192.168.0.8

Specifying the IP address

Enter the IP address when there is no DHCP server in the network where the projector is to be connected.

1) Press the <ON> side of the <MAIN POWER> switch to turn on the power.

- The power indicator <ON (G)/STANDBY (R)> lights in red, and the projector enters the standby mode.

2) Press and hold the <STATUS> button on the remote control for three seconds or more.

- Currently set IP address is displayed in the self-diagnosis display at the side of the projector.

3) Press the <ENTER> button on the control panel.

- It will go into an IP address setting mode (where the self-diagnosis display is blinking in 0.5 second intervals).
- It will not go into the IP address setting mode even if the <ENTER> button on the remote control is pressed.

4) Press ▲▼◀▶ to enter the IP address.

- Press ◀▶ to switch the display of the IP address in the self-diagnosis display. Press ▲▼ to display the address to change, and then press ▲▼ or the number (<0> - <9>) buttons to set the address.
- Once all the addresses are entered, proceed to Step 5).

5) Press the <ENTER> button on the remote control or control panel.

- [IP ADDRESS] is set to the entered IP address.
- The setting is reflected to the [NETWORK] menu → [NETWORK SETUP] → [IP ADDRESS].
- The IP address setting mode is canceled when the <ENTER> button is pressed, and the settings are displayed in the self-diagnosis display in two second intervals as follows. Next display is an example when [IP ADDRESS] is set to 192.168.0.10.

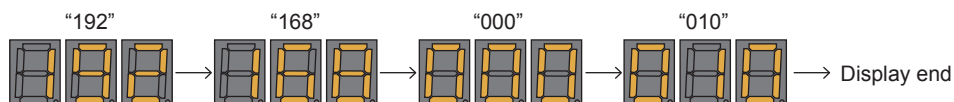

Note

- The IP address setting mode is canceled when no setting operation is performed for 10 seconds or longer in the IP address setting mode.
- The IP address will be set to the following factory default setting when the <DEFAULT> button on the remote control is pressed while in the IP address setting mode.

[DHCP]	OFF
[IP ADDRESS]	192.168.0.8

Two-window display combination list

✓: P IN P (picture in picture) combination is possible

▲: P IN P (picture in picture) combination is possible through the same frequency

—: P IN P (picture in picture) combination is not possible

Main window		Sub window					
		RGB1				RGB2	
		Still image	Movie ^{*1}	Y/C	Video	Still image	Movie ^{*1}
RGB1 input	Still image signal	—	—	—	—	✓	✓
	Movie signal ^{*1}	—	—	—	—	✓	▲
	Y/C signal	—	—	—	—	✓	▲
	Video signal	—	—	—	—	✓	▲
RGB2 input	Still image signal	✓	✓	✓	✓	—	—
	Movie signal ^{*1}	✓	▲	▲	▲	—	—
DVI-D input	Still image signal ^{*2}	✓	✓	✓	✓	✓	✓
	Movie signal ^{*3}	✓	▲	▲	▲	✓	▲
HDMI input	Still image signal ^{*2}	✓	✓	✓	✓	✓	✓
	Movie signal ^{*3}	✓	▲	▲	▲	✓	▲
SDI1 input		✓	▲	▲	▲	✓	▲
SDI2 input		✓	▲	▲	▲	✓	▲
Dual link SDI ^{*4}		—	—	▲	▲	—	—

Main window		Sub window						
		DVI-D		HDMI		SDI1	SDI2	Dual link SDI ^{*4}
		Still image ^{*2}	Movie ^{*3}	Still image ^{*2}	Movie ^{*3}			
RGB1 input	Still image signal	✓	✓	✓	✓	✓	✓	—
	Movie signal ^{*1}	✓	▲	✓	▲	▲	▲	—
	Y/C signal	✓	▲	✓	▲	▲	▲	▲
	Video signal	✓	▲	✓	▲	▲	▲	▲
RGB2 input	Still image signal	✓	✓	✓	✓	✓	✓	—
	Movie signal ^{*1}	✓	▲	✓	▲	▲	▲	—
DVI-D input	Still image signal ^{*2}	—	—	✓	✓	✓	—	—
	Movie signal ^{*3}	—	—	✓	▲	▲	—	—
HDMI input	Still image signal ^{*2}	✓	✓	—	—	—	✓	—
	Movie signal ^{*3}	✓	▲	—	—	—	▲	—
SDI1 input		✓	▲	—	—	—	▲	—
SDI2 input		—	—	✓	▲	▲	—	—
Dual link SDI ^{*4}		—	—	—	—	—	—	—

*1 480i, 480p, 576i, 576p, 720/60p, 720/50p, 1080/60i, 1080/50i, 1080/24sF, 1080/24p, 1080/25p, 1080/30p, 1080/50p, 1080/60p

*2 640 x 480 - 1 920 x 1 200

Non-interlaced signal, dot clock frequency: 25 MHz - 162 MHz

*3 Only supports 480p, 576p, 720/60p, 720/50p, 1080/60i, 1080/50i, 1080/24sF, 1080/24p, 1080/25p, 1080/30p, 1080/50p, and 1080/60p

*4 Dual link HD-SDI, dual link 3G-SDI

Note

- In the combination of ▲, if P IN P function is used with the signals of a different frequency, images in the sub window will not be displayed.
- Images in combination of DIGITAL LINK and other inputs cannot be displayed in P IN P.

Control device password

To initialize your password, consult your distributor.

Upgrade Kit

If the optional Upgrade Kit (Model No.: ET-UK20) is applied, the following functions are extended.

Function	Standard status	When the Upgrade Kit is applied
Adjustment range of [VERTICAL KEYSTONE]	Maximum of $\pm 40^{\circ*1}$	Maximum of $\pm 45^{\circ*1}$
Adjustment range of [HORIZONTAL KEYSTONE]	Maximum of $\pm 15^{\circ*1}$	Maximum of $\pm 40^{\circ*1}$
Adjustment range of [CURVED CORRECTION]	Vertical arc, Maximum $\pm 50^{\circ*1}$ Horizontal arc, Maximum $\pm 50^{\circ*1}$	Vertical arc, Maximum $\pm 100^{\circ*1}$ Horizontal arc, Maximum $\pm 100^{\circ*1}$
Adjustment range of [PINCUSHION]	Maximum of $\pm 50^{\circ*1}$	Maximum of $\pm 100^{\circ*1}$
[CUSTOM MASKING]	Cannot be used.	The image is masked in optional form.
[PC CORRECTION] of [UNIFORMITY]	Cannot be used.	Correct the brightness and color unevenness of the entire screen.

*1 The adjustment range of the menu. Refer to "[GEOMETRY] projection range" (➔ page 40) for the possible projection range.

List of compatible signals

The following table specifies the video signals that the projector can project. For details of SDI signal, refer to “List of single link SDI compatible signals” (➔ page 240) and “List of dual link SDI compatible signals” (➔ page 241).

- Symbols that indicate formats are as follows.
 - V: VIDEO, Y/C
 - R: RGB (analog)
 - Y: YC_BC_R/YP_BP_R (analog)
 - D: DVI-D
 - H: HDMI
- Input corresponding to each item in the plug and play column is as follows.
 - RGB2: RGB2 input
 - DVI-D: DVI-D input
 - HDMI/DL: HDMI input, DIGITAL LINK input

Signal name (SIGNAL FORMAT)	Resolution (Dots)	Scanning freq.		Dot clock freq. (MHz)	Format	Plug and play ¹				
		Horizontal (kHz)	Vertical (Hz)			RGB2	DVI-D			HDMI/ DL
							EDID1	EDID2	EDID3	
NTSC/NTSC4.43/ PAL-M/PAL60	720 x 480i	15.7	59.9	—	V	—	—	—	—	—
PAL/PAL-N/SECAM	720 x 576i	15.6	50.0	—	V	—	—	—	—	—
480/60i	720 x 480i	15.7	59.9	13.5	R/Y	—	—	—	—	—
576/50i	720 x 576i	15.6	50.0	13.5	R/Y	—	—	—	—	—
480/60i	720 (1 440) x 480i ²	15.7	59.9	27.0	D/H	—	—	—	—	—
576/50i	720 (1 440) x 576i ²	15.6	50.0	27.0	D/H	—	—	—	—	—
480/60p	720 x 480	31.5	59.9	27.0	R/Y/D/H	—	✓	—	✓	✓
576/50p	720 x 576	31.3	50.0	27.0	R/Y/D/H	—	✓	—	✓	✓
720/60p	1 280 x 720	45.0	60.0	74.3	R/Y/D/H	—	✓	—	✓	✓
720/50p	1 280 x 720	37.5	50.0	74.3	R/Y/D/H	—	✓	—	✓	✓
1080/60i	1 920 x 1 080i	33.8	60.0	74.3	R/Y/D/H	—	✓	—	✓	✓
1080/50i	1 920 x 1 080i	28.1	50.0	74.3	R/Y/D/H	—	✓	—	✓	✓
1080/24p	1 920 x 1 080	27.0	24.0	74.3	R/Y/D/H	—	✓	—	✓	✓
1080/24sF	1 920 x 1 080i	27.0	48.0	74.3	R/Y/D/H	—	—	—	—	—
1080/25p	1 920 x 1 080	28.1	25.0	74.3	R/Y/D/H	—	✓	—	✓	—
1080/30p	1 920 x 1 080	33.8	30.0	74.3	R/Y/D/H	—	—	—	—	—
1080/60p	1 920 x 1 080	67.5	60.0	148.5	R/Y/D/H	—	✓	—	✓	✓
1080/50p	1 920 x 1 080	56.3	50.0	148.5	R/Y/D/H	—	✓	—	✓	✓
640 x 400/70	640 x 400	31.5	70.1	25.2	R/D/H	—	—	—	—	—
640 x 400/85	640 x 400	37.9	85.1	31.5	R/D/H	—	—	—	—	—
640 x 480/60	640 x 480	31.5	59.9	25.2	R/D/H	✓	✓	✓	✓	✓
640 x 480/67	640 x 480	35.0	66.7	30.2	R/D/H	—	—	—	—	—
640 x 480/73	640 x 480	37.9	72.8	31.5	R/D/H	✓	—	✓	✓	✓
640 x 480/75	640 x 480	37.5	75.0	31.5	R/D/H	✓	—	✓	✓	✓
640 x 480/85	640 x 480	43.3	85.0	36.0	R/D/H	—	—	—	—	—
800 x 600/56	800 x 600	35.2	56.3	36.0	R/D/H	✓	—	✓	✓	✓
800 x 600/60	800 x 600	37.9	60.3	40.0	R/D/H	✓	—	✓	✓	✓
800 x 600/72	800 x 600	48.1	72.2	50.0	R/D/H	✓	—	✓	✓	✓
800 x 600/75	800 x 600	46.9	75.0	49.5	R/D/H	✓	—	✓	✓	✓
800 x 600/85	800 x 600	53.7	85.1	56.3	R/D/H	—	—	—	—	—
832 x 624/75	832 x 624	49.7	74.6	57.3	R/D/H	✓	—	✓	✓	✓
1024 x 768/50	1 024 x 768	39.6	50.0	51.9	R/D/H	—	—	—	—	—
1024 x 768/60	1 024 x 768	48.4	60.0	65.0	R/D/H	✓	—	✓	✓	✓
1024 x 768/70	1 024 x 768	56.5	70.1	75.0	R/D/H	✓	—	✓	✓	✓
1024 x 768/75	1 024 x 768	60.0	75.0	78.8	R/D/H	✓	—	✓	✓	✓
1024 x 768/82	1 024 x 768	65.5	81.6	86.0	R/D/H	—	—	—	—	—
1024 x 768/85	1 024 x 768	68.7	85.0	94.5	R/D/H	—	—	—	—	—
1024 x 768/100	1 024 x 768 ³	81.4	100.0	113.3	R/D/H	—	—	—	—	—

Chapter 7 Appendix — Technical information

Signal name (SIGNAL FORMAT)	Resolution (Dots)	Scanning freq.		Dot clock freq. (MHz)	Format	Plug and play ¹				
		Horizontal (kHz)	Vertical (Hz)			RGB2	DVI-D			HDMI/ DL
							EDID1	EDID2	EDID3	
1024 x 768/120	1 024 x 768 ³	98.8	120.0	139.1	R/D/H	✓	—	✓	✓	✓
1152 x 864/60	1 152 x 864	53.7	60.0	81.6	R/D/H	—	—	—	—	—
1152 x 864/70	1 152 x 864	64.0	70.0	94.2	R/D/H	—	—	—	—	—
1152 x 864/75	1 152 x 864	67.5	75.0	108.0	R/D/H	—	—	—	—	—
1152 x 864/85	1 152 x 864	77.1	85.0	119.7	R/D/H	—	—	—	—	—
1152 x 870/75	1 152 x 870	68.7	75.1	100.0	R/D/H	✓	—	✓	✓	✓
1280 x 720/50	1 280 x 720	37.1	49.8	60.5	R/D/H	—	—	—	—	—
1280 x 720/60	1 280 x 720	44.8	59.9	74.5	R/D/H	—	—	—	—	—
1280 x 720/100	1 280 x 720 ³	76.3	100.0	131.8	R/D/H	—	—	—	—	—
1280 x 720/120	1 280 x 720 ³	92.6	120.0	161.6	R/D/H	—	—	—	—	—
1280 x 768/50	1 280 x 768	39.6	49.9	65.3	R/D/H	—	—	—	—	—
1280 x 768/60	1 280 x 768	47.8	59.9	79.5	R/D/H	—	—	—	—	—
	1 280 x 768 ⁴	47.4	60.0	68.3	R/D/H	—	—	—	—	—
1280 x 768/75	1 280 x 768	60.3	74.9	102.3	R/D/H	—	—	—	—	—
1280 x 768/85	1 280 x 768	68.6	84.8	117.5	R/D/H	—	—	—	—	—
1280 x 800/50	1 280 x 800	41.3	50.0	68.0	R/D/H	—	—	—	—	—
1280 x 800/60	1 280 x 800	49.7	59.8	83.5	R/D/H	—	—	—	—	—
	1 280 x 800 ⁴	49.3	59.9	71.0	R/D/H	—	—	—	—	—
1280 x 800/75	1 280 x 800	62.8	74.9	106.5	R/D/H	—	—	—	—	—
1280 x 800/85	1 280 x 800	71.6	84.9	122.5	R/D/H	—	—	—	—	—
1280 x 960/60	1 280 x 960	60.0	60.0	108.0	R/D/H	—	—	—	—	—
1280 x 1024/50	1 280 x 1 024	52.4	50.0	88.0	R/D/H	—	—	—	—	—
1280 x 1024/60	1 280 x 1 024	64.0	60.0	108.0	R/D/H	—	—	—	—	—
1280 x 1024/66	1 280 x 1 024	72.3	66.3	125.0	R/D/H	—	—	—	—	—
1280 x 1024/72	1 280 x 1 024	78.2	72.0	135.1	R/D/H	—	—	—	—	—
1280 x 1024/75	1 280 x 1 024	80.0	75.0	135.0	R/D/H	✓	—	✓	✓	✓
1280 x 1024/85	1 280 x 1 024	91.1	85.0	157.5	R/D/H	—	—	—	—	—
1366 x 768/50	1 366 x 768	39.6	49.9	69.0	R/D/H	—	—	—	—	—
1366 x 768/60	1 366 x 768	47.7	59.8	85.5	R/D/H	—	—	—	—	—
1400 x 1050/50	1 400 x 1 050	54.1	50.0	99.9	R/D/H	—	—	—	—	—
1400 x 1050/60	1 400 x 1 050	64.0	60.0	108.0	R/D/H	—	—	—	—	—
	1 400 x 1 050	65.2	60.0	122.6	R/D/H	✓	—	✓	✓	✓
	1 400 x 1 050	65.3	60.0	121.8	R/D/H	—	—	—	—	—
1400 x 1050/72	1 400 x 1 050	78.8	72.0	149.3	R/D/H	—	—	—	—	—
1400 x 1050/75	1 400 x 1 050	82.2	75.0	155.9	R/D/H	—	—	—	—	—
1440 x 900/50	1 440 x 900	46.3	49.9	86.8	R/D/H	—	—	—	—	—
1440 x 900/60	1 440 x 900	55.9	59.9	106.5	R/D/H	—	—	—	—	—
1600 x 900/50	1 600 x 900	46.4	49.9	96.5	R/D/H	—	—	—	—	—
1600 x 900/60	1 600 x 900	55.9	60.0	119.0	R/D/H	✓	—	✓	✓	✓
1600 x 1200/50	1 600 x 1 200	61.8	49.9	131.5	R/D/H	—	—	—	—	—
1600 x 1200/60	1 600 x 1 200	75.0	60.0	162.0	R/D/H	✓	—	✓	✓	✓
1680 x 1050/50	1 680 x 1 050	54.1	50.0	119.5	R/D/H	—	—	—	—	—
1680 x 1050/60	1 680 x 1 050	65.3	60.0	146.3	R/D/H	—	—	—	—	—
1920 x 1080/50	1 920 x 1 080	55.6	49.9	141.5	R/D/H	—	—	—	—	—
1920 x 1080/60	1 920 x 1 080 ⁴	66.6	59.9	138.5	R/D/H	—	—	—	—	—
	1 920 x 1 080 ⁵	67.2	60.0	173.0	R	—	—	—	—	—
1920 x 1200/50	1 920 x 1 200	61.8	49.9	158.3	R/D/H	—	—	—	—	—
1920 x 1200/60	1 920 x 1 200 ⁵	74.6	59.9	193.3	R	—	—	—	—	—
1920 x 1200/60RB	1 920 x 1 200 ⁴	74.0	60.0	154.0	R/D/H	✓	—	✓	✓ ⁶	✓ ⁶

*1 Signal with ✓ in the plug and play column is a signal described in the EDID (extended display identification data) of the projector. The signal that does not have ✓ in the plug and play column can also be input if it is described in the format column. The resolution may not be selected in the computer even if the projector is compatible for the signal that does not have ✓ in the plug and play column.

*2 Pixel-Repetition signal (dot clock frequency 27.0 MHz) only

*3 Image is displayed as 3D image in the frame sequential format when [3D INPUT FORMAT] is set to [AUTO]. To display images in 2D, set [3D INPUT FORMAT] to [NATIVE].

*4 VESA CVT-RB (Reduced Blanking)-compliant

*5 Samples the pixels in the image processing circuit and projects the image.

*6 Only for PT-RZ21K

Note

- A signal with a different resolution is converted to the number of display dots. The number of display dots is as follows.
 - PT-RZ21K: 1 920 x 1 200
 - PT-RS20K: 1 400 x 1 050
- The “i” at the end of the resolution indicates an interlaced signal.
- When interlaced signals are connected, flickering may occur on the projected image.
- DIGITAL LINK input compatible signal is the same as HDMI input compatible signal.

List of single link SDI compatible signals

The following table specifies the single link SDI signals that the projector can project.

Signal name (SIGNAL FORMAT)	Resolution (Dots)	Scanning freq.		Dot clock freq. (MHz)	Format	Color format	Sampling
		Horizontal (kHz)	Vertical (Hz)				
480/60i	720 x 480i	15.7	59.9	27.0	SD-SDI	Y _C B _C R	4:2:2 10bit
576/50i	720 x 576i	15.6	50.0	27.0	SD-SDI	Y _C B _C R	4:2:2 10bit
720/60p	1 280 x 720	45.0	60.0*1	74.3	HD-SDI	Y _P B _P R	4:2:2 10bit
720/50p	1 280 x 720	37.5	50.0	74.3	HD-SDI	Y _P B _P R	4:2:2 10bit
1080/60i	1 920 x 1 080i	33.8	60.0*1	74.3	HD-SDI	Y _P B _P R	4:2:2 10bit
	1 920 x 1 080i	33.8	60.0*1	74.3	3G-SDI Level-A	RGB	4:4:4 10bit
	1 920 x 1 080i	33.8	60.0*1	74.3	3G-SDI Level-B	RGB	4:4:4 10bit
	1 920 x 1 080i	33.8	60.0*1	74.3	3G-SDI Level-A	RGB	4:4:4 12bit
	1 920 x 1 080i	33.8	60.0*1	74.3	3G-SDI Level-B	RGB	4:4:4 12bit
1080/50i	1 920 x 1 080i	28.1	50.0	74.3	HD-SDI	Y _P B _P R	4:2:2 10bit
	1 920 x 1 080i	28.1	50.0	74.3	3G-SDI Level-A	RGB	4:4:4 10bit
	1 920 x 1 080i	28.1	50.0	74.3	3G-SDI Level-B	RGB	4:4:4 10bit
	1 920 x 1 080i	28.1	50.0	74.3	3G-SDI Level-A	RGB	4:4:4 12bit
	1 920 x 1 080i	28.1	50.0	74.3	3G-SDI Level-B	RGB	4:4:4 12bit
1080/24p	1 920 x 1 080	27.0	24.0*1	74.3	HD-SDI	Y _P B _P R	4:2:2 10bit
	1 920 x 1 080	27.0	24.0*1	74.3	3G-SDI Level-A	RGB	4:4:4 10bit
	1 920 x 1 080	27.0	24.0*1	74.3	3G-SDI Level-B	RGB	4:4:4 10bit
	1 920 x 1 080	27.0	24.0*1	74.3	3G-SDI Level-A	RGB	4:4:4 12bit
	1 920 x 1 080	27.0	24.0*1	74.3	3G-SDI Level-B	RGB	4:4:4 12bit
1080/24sF	1 920 x 1 080i	27.0	48.0*1	74.3	HD-SDI	Y _P B _P R	4:2:2 10bit
	1 920 x 1 080i	27.0	48.0*1	74.3	3G-SDI Level-A	RGB	4:4:4 10bit
	1 920 x 1 080i	27.0	48.0*1	74.3	3G-SDI Level-B	RGB	4:4:4 10bit
	1 920 x 1 080i	27.0	48.0*1	74.3	3G-SDI Level-A	RGB	4:4:4 12bit
	1 920 x 1 080i	27.0	48.0*1	74.3	3G-SDI Level-B	RGB	4:4:4 12bit
1080/25p	1 920 x 1 080	28.1	25.0	74.3	HD-SDI	Y _P B _P R	4:2:2 10bit
	1 920 x 1 080	28.1	25.0	74.3	3G-SDI Level-A	RGB	4:4:4 10bit
	1 920 x 1 080	28.1	25.0	74.3	3G-SDI Level-B	RGB	4:4:4 10bit
	1 920 x 1 080	28.1	25.0	74.3	3G-SDI Level-A	RGB	4:4:4 12bit
	1 920 x 1 080	28.1	25.0	74.3	3G-SDI Level-B	RGB	4:4:4 12bit
1080/30p	1 920 x 1 080	33.8	30.0*1	74.3	HD-SDI	Y _P B _P R	4:2:2 10bit
	1 920 x 1 080	33.8	30.0*1	74.3	3G-SDI Level-A	RGB	4:4:4 10bit
	1 920 x 1 080	33.8	30.0*1	74.3	3G-SDI Level-B	RGB	4:4:4 10bit
	1 920 x 1 080	33.8	30.0*1	74.3	3G-SDI Level-A	RGB	4:4:4 12bit
	1 920 x 1 080	33.8	30.0*1	74.3	3G-SDI Level-B	RGB	4:4:4 12bit
1080/60p	1 920 x 1 080	67.5	60.0*1	148.5	3G-SDI Level-A	Y _P B _P R	4:2:2 10bit
	1 920 x 1 080	67.5	60.0*1	148.5	3G-SDI Level-B	Y _P B _P R	4:2:2 10bit
1080/50p	1 920 x 1 080	56.3	50.0	148.5	3G-SDI Level-A	Y _P B _P R	4:2:2 10bit
	1 920 x 1 080	56.3	50.0	148.5	3G-SDI Level-B	Y _P B _P R	4:2:2 10bit
2K/24p	2 048 x 1 080	27.0	24.0*1	74.3	3G-SDI Level-A	RGB	4:4:4 10bit
	2 048 x 1 080	27.0	24.0*1	74.3	3G-SDI Level-B	RGB	4:4:4 10bit
	2 048 x 1 080	27.0	24.0*1	74.3	3G-SDI Level-A	RGB	4:4:4 12bit
	2 048 x 1 080	27.0	24.0*1	74.3	3G-SDI Level-B	RGB	4:4:4 12bit
	2 048 x 1 080	27.0	24.0*1	74.3	3G-SDI Level-A	XYZ	4:4:4 12bit
	2 048 x 1 080	27.0	24.0*1	74.3	3G-SDI Level-B	XYZ	4:4:4 12bit

Chapter 7 Appendix — Technical information

Signal name (SIGNAL FORMAT)	Resolution (Dots)	Scanning freq.		Dot clock freq. (MHz)	Format	Color format	Sampling
		Horizontal (kHz)	Vertical (Hz)				
2K/25p	2 048 x 1 080	28.1	25.0	74.3	3G-SDI Level-A	RGB	4:4:4 10bit
	2 048 x 1 080	28.1	25.0	74.3	3G-SDI Level-B	RGB	4:4:4 10bit
	2 048 x 1 080	28.1	25.0	74.3	3G-SDI Level-A	RGB	4:4:4 12bit
	2 048 x 1 080	28.1	25.0	74.3	3G-SDI Level-B	RGB	4:4:4 12bit
	2 048 x 1 080	28.1	25.0	74.3	3G-SDI Level-A	XYZ	4:4:4 12bit
	2 048 x 1 080	28.1	25.0	74.3	3G-SDI Level-B	XYZ	4:4:4 12bit
2K/30p	2 048 x 1 080	33.8	30.0*1	74.3	3G-SDI Level-A	RGB	4:4:4 10bit
	2 048 x 1 080	33.8	30.0*1	74.3	3G-SDI Level-B	RGB	4:4:4 10bit
	2 048 x 1 080	33.8	30.0*1	74.3	3G-SDI Level-A	RGB	4:4:4 12bit
	2 048 x 1 080	33.8	30.0*1	74.3	3G-SDI Level-B	RGB	4:4:4 12bit
	2 048 x 1 080	33.8	30.0*1	74.3	3G-SDI Level-A	XYZ	4:4:4 12bit
	2 048 x 1 080	33.8	30.0*1	74.3	3G-SDI Level-B	XYZ	4:4:4 12bit
2K/48p	2 048 x 1 080	54.0	48.0*1	148.5	3G-SDI Level-A	YP _B P _R	4:2:2 10bit
	2 048 x 1 080	54.0	48.0*1	148.5	3G-SDI Level-B	YP _B P _R	4:2:2 10bit
2K/50p	2 048 x 1 080	56.3	50.0	148.5	3G-SDI Level-A	YP _B P _R	4:2:2 10bit
	2 048 x 1 080	56.3	50.0	148.5	3G-SDI Level-B	YP _B P _R	4:2:2 10bit
2K/60p	2 048 x 1 080	67.5	60.0*1	148.5	3G-SDI Level-A	YP _B P _R	4:2:2 10bit
	2 048 x 1 080	67.5	60.0*1	148.5	3G-SDI Level-B	YP _B P _R	4:2:2 10bit

*1 The signal with 1/1.001x vertical scanning frequency is also supported.

List of dual link SDI compatible signals

The following table specifies the dual link SDI signals that the projector can project.

Signal name (SIGNAL FORMAT)	Resolution (Dots)	Scanning freq.		Dot clock freq. (MHz)	Format	Color format	Sampling
		Horizontal (kHz)	Vertical (Hz)				
1080/60i	1 920 x 1 080i	33.8	60.0*1	74.3	HD-SDI	RGB	4:4:4 10bit
	1 920 x 1 080i	33.8	60.0*1	74.3	HD-SDI	RGB	4:4:4 12bit
1080/50i	1 920 x 1 080i	28.1	50.0	74.3	HD-SDI	RGB	4:4:4 10bit
	1 920 x 1 080i	28.1	50.0	74.3	HD-SDI	RGB	4:4:4 12bit
1080/24p	1 920 x 1 080	27.0	24.0*1	74.3	HD-SDI	RGB	4:4:4 10bit
	1 920 x 1 080	27.0	24.0*1	74.3	HD-SDI	RGB	4:4:4 12bit
1080/24sF	1 920 x 1 080i	27.0	48.0*1	74.3	HD-SDI	RGB	4:4:4 10bit
	1 920 x 1 080i	27.0	48.0*1	74.3	HD-SDI	RGB	4:4:4 12bit
1080/25p	1 920 x 1 080	28.1	25.0	74.3	HD-SDI	RGB	4:4:4 10bit
	1 920 x 1 080	28.1	25.0	74.3	HD-SDI	RGB	4:4:4 12bit
1080/30p	1 920 x 1 080	33.8	30.0*1	74.3	HD-SDI	RGB	4:4:4 10bit
	1 920 x 1 080	33.8	30.0*1	74.3	HD-SDI	RGB	4:4:4 12bit
1080/60p	1 920 x 1 080	67.5	60.0*1	148.5	3G-SDI Level-A	YP _B P _R	4:4:4 10bit
	1 920 x 1 080	67.5	60.0*1	148.5	3G-SDI Level-B	YP _B P _R	4:4:4 10bit
	1 920 x 1 080	67.5	60.0*1	148.5	3G-SDI Level-A	YP _B P _R	4:4:4 12bit
	1 920 x 1 080	67.5	60.0*1	148.5	3G-SDI Level-B	YP _B P _R	4:4:4 12bit
	1 920 x 1 080	67.5	60.0*1	148.5	3G-SDI Level-A	RGB	4:4:4 10bit
	1 920 x 1 080	67.5	60.0*1	148.5	3G-SDI Level-B	RGB	4:4:4 10bit
	1 920 x 1 080	67.5	60.0*1	148.5	3G-SDI Level-A	RGB	4:4:4 12bit
	1 920 x 1 080	67.5	60.0*1	148.5	3G-SDI Level-B	RGB	4:4:4 12bit
1080/50p	1 920 x 1 080	56.3	50.0	148.5	3G-SDI Level-A	YP _B P _R	4:4:4 10bit
	1 920 x 1 080	56.3	50.0	148.5	3G-SDI Level-B	YP _B P _R	4:4:4 10bit
	1 920 x 1 080	56.3	50.0	148.5	3G-SDI Level-A	YP _B P _R	4:4:4 12bit
	1 920 x 1 080	56.3	50.0	148.5	3G-SDI Level-B	YP _B P _R	4:4:4 12bit
	1 920 x 1 080	56.3	50.0	148.5	3G-SDI Level-A	RGB	4:4:4 10bit
	1 920 x 1 080	56.3	50.0	148.5	3G-SDI Level-B	RGB	4:4:4 10bit
	1 920 x 1 080	56.3	50.0	148.5	3G-SDI Level-A	RGB	4:4:4 12bit
	1 920 x 1 080	56.3	50.0	148.5	3G-SDI Level-B	RGB	4:4:4 12bit

Chapter 7 Appendix — Technical information

Signal name (SIGNAL FORMAT)	Resolution (Dots)	Scanning freq.		Dot clock freq. (MHz)	Format	Color format	Sampling
		Horizontal (kHz)	Vertical (Hz)				
2K/24p	2 048 x 1 080	27.0	24.0*1	74.3	HD-SDI	RGB	4:4:4 10bit
	2 048 x 1 080	27.0	24.0*1	74.3	HD-SDI	RGB	4:4:4 12bit
	2 048 x 1 080	27.0	24.0*1	74.3	HD-SDI	XYZ	4:4:4 12bit
2K/48p	2 048 x 1 080	54.0	48.0*1	148.5	3G-SDI Level-A	YP _B P _R	4:4:4 10bit
	2 048 x 1 080	54.0	48.0*1	148.5	3G-SDI Level-B	YP _B P _R	4:4:4 10bit
	2 048 x 1 080	54.0	48.0*1	148.5	3G-SDI Level-A	YP _B P _R	4:4:4 12bit
	2 048 x 1 080	54.0	48.0*1	148.5	3G-SDI Level-B	YP _B P _R	4:4:4 12bit
	2 048 x 1 080	54.0	48.0*1	148.5	3G-SDI Level-A	RGB	4:4:4 10bit
	2 048 x 1 080	54.0	48.0*1	148.5	3G-SDI Level-B	RGB	4:4:4 10bit
	2 048 x 1 080	54.0	48.0*1	148.5	3G-SDI Level-A	RGB	4:4:4 12bit
	2 048 x 1 080	54.0	48.0*1	148.5	3G-SDI Level-B	RGB	4:4:4 12bit
2K/50p	2 048 x 1 080	56.3	50.0	148.5	3G-SDI Level-A	YP _B P _R	4:4:4 10bit
	2 048 x 1 080	56.3	50.0	148.5	3G-SDI Level-B	YP _B P _R	4:4:4 10bit
	2 048 x 1 080	56.3	50.0	148.5	3G-SDI Level-A	YP _B P _R	4:4:4 12bit
	2 048 x 1 080	56.3	50.0	148.5	3G-SDI Level-B	YP _B P _R	4:4:4 12bit
	2 048 x 1 080	56.3	50.0	148.5	3G-SDI Level-A	RGB	4:4:4 10bit
	2 048 x 1 080	56.3	50.0	148.5	3G-SDI Level-B	RGB	4:4:4 10bit
	2 048 x 1 080	56.3	50.0	148.5	3G-SDI Level-A	RGB	4:4:4 12bit
	2 048 x 1 080	56.3	50.0	148.5	3G-SDI Level-B	RGB	4:4:4 12bit
2K/60p	2 048 x 1 080	67.5	60.0*1	148.5	3G-SDI Level-A	YP _B P _R	4:4:4 10bit
	2 048 x 1 080	67.5	60.0*1	148.5	3G-SDI Level-B	YP _B P _R	4:4:4 10bit
	2 048 x 1 080	67.5	60.0*1	148.5	3G-SDI Level-A	YP _B P _R	4:4:4 12bit
	2 048 x 1 080	67.5	60.0*1	148.5	3G-SDI Level-B	YP _B P _R	4:4:4 12bit
	2 048 x 1 080	67.5	60.0*1	148.5	3G-SDI Level-A	RGB	4:4:4 10bit
	2 048 x 1 080	67.5	60.0*1	148.5	3G-SDI Level-B	RGB	4:4:4 10bit
	2 048 x 1 080	67.5	60.0*1	148.5	3G-SDI Level-A	RGB	4:4:4 12bit
	2 048 x 1 080	67.5	60.0*1	148.5	3G-SDI Level-B	RGB	4:4:4 12bit

*1 The signal with 1/1.001x vertical scanning frequency is also supported.

List of simultaneous input 2D compatible signals

The following table specifies the simultaneous input (2D) compatible video signals that the projector can project.

Signal name (SIGNAL FORMAT)	Resolution (Dots)	Scanning freq.		Dot clock freq. (MHz)	HDMI/DVI	SDI1/SDI2
		Horizontal (kHz)	Vertical (Hz)			
1080/60p	1 920 x 1 080	67.5	60.0	148.5	✓	✓
1080/50p	1 920 x 1 080	56.3	50.0	148.5	✓	✓
1366 x 768/50	1 366 x 768	39.6	49.9	69.0	✓	—
1366 x 768/60	1 366 x 768	47.7	59.8	85.5	✓	—
1400 x 1050/50	1 400 x 1 050	54.1	50.0	99.9	✓	—
1400 x 1050/60	1 400 x 1 050	65.3	60.0	121.8	✓	—
1920 x 1080/50	1 920 x 1 080	55.6	49.9	141.5	✓	—
1920 x 1080/60	1 920 x 1 080	66.6	59.9	138.5	✓	—
1920 x 1200/50	1 920 x 1 200	61.8	49.9	158.3	✓	—
1920 x 1200/60	1 920 x 1 200	74.0	60.0	154.0	✓	—

List of 3D compatible signals

The following table specifies the 3D compatible video signals that the projector can project.

- Abbreviations for input formats and 3D formats in the table have the following meanings.
 - FP: Frame packing format
 - SBS: Side by side format
 - TB: Top and bottom format
 - LBL: Line by line format
 - FS: Frame sequential format
 - 3G: 3G-SDI Level B simultaneous format
 - H-D: HDMI & DVI-D input simultaneous format
 - R1-2: RGB1 & RGB2 input simultaneous format
 - S1-2: SDI1 & SDI2 input simultaneous format

Signal name (SIGNAL FORMAT)	Resolution (Dots)	Scanning freq.		Dot clock freq. (MHz)	HDMI				DVI-D			
		Horizontal (kHz)	Vertical (Hz)		FP	SBS*1	TB	FS	SBS*1	TB	LBL	FS
720/60p	1 280 x 720	45.0	60.0	74.3	✓	✓	✓	—	✓	✓	✓	—
720/50p	1 280 x 720	37.5	50.0	74.3	✓	✓	✓	—	✓	✓	✓	—
1080/60i	1 920 x 1 080i	33.8	60.0	74.3	✓	✓	—	—	✓	✓	—	—
1080/50i	1 920 x 1 080i	28.1	50.0	74.3	✓	✓	—	—	✓	✓	—	—
1080/24p	1 920 x 1 080	27.0	24.0	74.3	✓	✓	✓	—	✓	✓	—	—
1080/24sF	1 920 x 1 080i	27.0	24.0	74.3	—	—	—	—	✓	✓	—	—
1080/25p	1 920 x 1 080	28.1	25.0	74.3	—	—	—	—	✓	✓	—	—
1080/30p	1 920 x 1 080	33.8	30.0	74.3	—	—	—	—	✓	✓	—	—
1080/60p	1 920 x 1 080	67.5	60.0	148.5	—	✓	✓	—	✓	✓	—	—
1080/50p	1 920 x 1 080	56.3	50.0	148.5	—	✓	✓	—	✓	✓	—	—
640 x 480	640 x 480	31.5	59.9	25.2	—	—	—	—	✓	—	—	—
800 x 600	800 x 600	37.9	60.3	40.0	—	—	—	—	✓	—	—	—
1024 x 768	1 024 x 768	39.6	50.0	51.9	—	—	—	—	✓	—	—	—
	1 024 x 768	48.4	60.0	65.0	—	—	—	—	✓	—	—	—
	1 024 x 768	81.4	100.0	113.3	—	—	—	✓	—	—	—	✓
	1 024 x 768	98.8	120.0	139.1	—	—	—	✓	—	—	—	✓
1152 x 864	1 152 x 864	53.7	60.0	81.6	—	—	—	—	✓	—	—	—
1280 x 720	1 280 x 720	37.1	49.8	60.5	—	—	—	—	✓	—	—	—
	1 280 x 720	44.8	59.9	74.5	—	—	—	—	✓	—	—	—
	1 280 x 720	76.3	100.0	131.8	—	—	—	✓	—	—	—	✓
	1 280 x 720	92.6	120.0	161.6	—	—	—	✓	—	—	—	✓
1280 x 768	1 280 x 768	39.6	49.9	65.3	—	—	—	—	✓	—	—	—
	1 280 x 768	47.8	59.9	79.5	—	—	—	—	✓	—	—	—
	1 280 x 768 ²	47.4	60.0	68.3	—	—	—	—	✓	—	—	—
1280 x 800	1 280 x 800	41.3	50.0	68.0	—	—	—	—	✓	—	—	—
	1 280 x 800	49.7	59.8	83.5	—	—	—	—	✓	—	—	—
	1 280 x 800 ²	49.3	59.9	71.0	—	—	—	—	✓	—	—	—
1280 x 960	1 280 x 960	60.0	60.0	108.0	—	—	—	—	✓	—	—	—
1280 x 1024	1 280 x 1 024	52.4	50.0	88.0	—	—	—	—	✓	—	—	—
	1 280 x 1 024	64.0	60.0	108.0	—	—	—	—	✓	—	—	—
1366 x 768	1 366 x 768	47.7	59.8	85.5	—	—	—	—	✓	—	—	—
	1 366 x 768	39.6	49.9	69.0	—	—	—	—	✓	—	—	—
1400 x 1050	1 400 x 1 050	54.1	50.0	99.9	—	—	—	—	✓	—	—	—
	1 400 x 1 050	64.0	60.0	108.0	—	—	—	—	✓	—	—	—
	1 400 x 1 050	65.2	60.0	122.6	—	—	—	—	✓	—	—	—
	1 400 x 1 050	65.3	60.0	121.8	—	—	—	—	✓	—	—	—
1440 x 900	1 440 x 900	55.9	59.9	106.5	—	—	—	—	✓	—	—	—
	1 440 x 900	46.3	49.9	86.8	—	—	—	—	✓	—	—	—
1600 x 900	1 600 x 900	46.4	49.9	96.5	—	—	—	—	✓	—	—	—
	1 600 x 900	55.9	60.0	119.0	—	—	—	—	✓	—	—	—

Chapter 7 Appendix — Technical information

Signal name (SIGNAL FORMAT)	Resolution (Dots)	Scanning freq.		Dot clock freq. (MHz)	HDMI				DVI-D			
		Horizontal (kHz)	Vertical (Hz)		FP	SBS*1	TB	FS	SBS*1	TB	LBL	FS
1600 x 1200	1 600 x 1 200	75.0	60.0	162.0	—	—	—	—	✓	—	—	—
	1 600 x 1 200	61.8	49.9	131.5	—	—	—	—	✓	—	—	—
1680 x 1050	1 680 x 1 050	65.3	60.0	146.3	—	—	—	—	✓	—	—	—
	1 680 x 1 050	54.1	50.0	119.5	—	—	—	—	✓	—	—	—
1920 x 1080	1 920 x 1 080	55.6	49.9	141.5	—	—	—	—	✓	—	—	—
	1 920 x 1 080*2	66.6	59.9	138.5	—	—	—	—	✓	—	—	—
1920 x 1200	1 920 x 1 200	61.8	49.9	158.3	—	—	—	—	✓	—	—	—
	1 920 x 1 200*2	74.0	60.0	154.0	—	—	—	—	✓	—	✓	—

*1 Supports half.

*2 VESA CVT RB (Reduced Blanking) compliant

Signal name (SIGNAL FORMAT)	Resolution (Dots)	Scanning freq.		Dot clock freq. (MHz)	RGB1/RGB2				SDI1/SDI2				H-D	R1-2	S1-2
		Horizontal (kHz)	Vertical (Hz)		SBS*1	TB	LBL	FS	SBS*1	TB	LBL	3G			
720/60p	1 280 x 720	45.0	60.0	74.3	✓	✓	✓	—	✓	✓	✓	✓	✓	✓	✓
720/50p	1 280 x 720	37.5	50.0	74.3	✓	✓	✓	—	✓	✓	✓	✓	✓	✓	✓
1080/60i	1 920 x 1 080i	33.8	60.0	74.3	✓	✓	—	—	✓	✓	—	✓	✓	✓	✓
1080/50i	1 920 x 1 080i	28.1	50.0	74.3	✓	✓	—	—	✓	✓	—	✓	✓	✓	✓
1080/24p	1 920 x 1 080	27.0	24.0	74.3	✓	✓	—	—	✓	✓	—	✓	✓	✓	✓
1080/24sF	1 920 x 1 080i	27.0	24.0	74.3	✓	✓	—	—	✓	✓	—	✓	✓	✓	✓
1080/25p	1 920 x 1 080	28.1	25.0	74.3	✓	✓	—	—	✓	✓	—	✓	✓	✓	✓
1080/30p	1 920 x 1 080	33.8	30.0	74.3	✓	✓	—	—	✓	✓	—	✓	✓	✓	✓
1080/60p	1 920 x 1 080	67.5	60.0	148.5	✓	✓	—	—	✓	✓	—	—	✓	✓	✓
1080/50p	1 920 x 1 080	56.3	50.0	148.5	✓	✓	—	—	✓	✓	—	—	✓	✓	✓
640 x 480	640 x 480	31.5	59.9	25.2	✓	—	—	—	—	—	—	—	—	—	—
800 x 600	800 x 600	37.9	60.3	40.0	✓	—	—	—	—	—	—	—	—	—	—
1024 x 768	1 024 x 768	39.6	50.0	51.9	✓	—	—	—	—	—	—	—	—	—	—
	1 024 x 768	48.4	60.0	65.0	✓	—	—	—	—	—	—	—	—	—	—
	1 024 x 768	81.4	100.0	113.3	—	—	—	✓	—	—	—	—	—	—	—
	1 024 x 768	98.8	120.0	139.1	—	—	—	✓	—	—	—	—	—	—	—
1152 x 864	1 152 x 864	53.7	60.0	81.6	✓	—	—	—	—	—	—	—	—	—	—
1280 x 720	1 280 x 720	37.1	49.8	60.5	✓	—	—	—	—	—	—	—	—	—	—
	1 280 x 720	44.8	59.9	74.5	✓	—	—	—	—	—	—	—	—	—	—
	1 280 x 720	76.3	100.0	131.8	—	—	—	✓	—	—	—	—	—	—	—
	1 280 x 720	92.6	120.0	161.6	—	—	—	✓	—	—	—	—	—	—	—
1280 x 768	1 280 x 768	39.6	49.9	65.3	✓	—	—	—	—	—	—	—	—	—	—
	1 280 x 768	47.8	59.9	79.5	✓	—	—	—	—	—	—	—	—	—	—
	1 280 x 768*2	47.4	60.0	68.3	✓	—	—	—	—	—	—	—	—	—	—
1280 x 800	1 280 x 800	41.3	50.0	68.0	✓	—	—	—	—	—	—	—	—	—	—
	1 280 x 800	49.7	59.8	83.5	✓	—	—	—	—	—	—	—	—	—	—
	1 280 x 800*2	49.3	59.9	71.0	✓	—	—	—	—	—	—	—	—	—	—
1280 x 960	1 280 x 960	60.0	60.0	108.0	✓	—	—	—	—	—	—	—	—	—	—
1280 x 1024	1 280 x 1 024	52.4	50.0	88.0	✓	—	—	—	—	—	—	—	—	—	—
	1 280 x 1 024	64.0	60.0	108.0	✓	—	—	—	—	—	—	—	—	—	—
1366 x 768	1 366 x 768	47.7	59.8	85.5	✓	—	—	—	—	—	—	—	—	—	—
	1 366 x 768	39.6	49.9	69.0	✓	—	—	—	—	—	—	—	—	—	—
1400 x 1050	1 400 x 1 050	54.1	50.0	99.9	✓	—	—	—	—	—	—	—	✓	✓	—
	1 400 x 1 050	64.0	60.0	108.0	✓	—	—	—	—	—	—	—	✓	✓	—
	1 400 x 1 050	65.2	60.0	122.6	✓	—	—	—	—	—	—	—	✓	✓	—
	1 400 x 1 050	65.3	60.0	121.8	✓	—	—	—	—	—	—	—	✓	✓	—
1440 x 900	1 440 x 900	55.9	59.9	106.5	✓	—	—	—	—	—	—	—	—	—	—
	1 440 x 900	46.3	49.9	86.8	✓	—	—	—	—	—	—	—	—	—	—
1600 x 900	1 600 x 900	46.4	49.9	96.5	✓	—	—	—	—	—	—	—	—	—	—
	1 600 x 900	55.9	60.0	119.0	✓	—	—	—	—	—	—	—	—	—	—

Chapter 7 Appendix — Technical information

Signal name (SIGNAL FORMAT)	Resolution (Dots)	Scanning freq.		Dot clock freq. (MHz)	RGB1/RGB2				SDI1/SDI2				H-D	R1-2	S1-2	
		Horizontal (kHz)	Vertical (Hz)		SBS ^{*1}	TB	LBL	FS	SBS ^{*1}	TB	LBL	3G				
1600 x 1200	1 600 x 1 200	75.0	60.0	162.0	✓	—	—	—	—	—	—	—	—	—	—	—
	1 600 x 1 200	61.8	49.9	131.5	✓	—	—	—	—	—	—	—	—	—	—	—
1680 x 1050	1 680 x 1 050	65.3	60.0	146.3	✓	—	—	—	—	—	—	—	—	—	—	—
	1 680 x 1 050	54.1	50.0	119.5	✓	—	—	—	—	—	—	—	—	—	—	—
1920 x 1080	1 920 x 1 080	55.6	49.9	141.5	✓	—	—	—	—	—	—	—	—	—	—	—
	1 920 x 1 080 ^{*2}	66.6	59.9	138.5	✓	—	—	—	—	—	—	—	—	—	—	—
1920 x 1200	1 920 x 1 200	61.8	49.9	158.3	✓	—	—	—	—	—	—	—	✓	✓	—	—
	1 920 x 1 200 ^{*2}	74.0	60.0	154.0	✓	—	✓	—	—	—	—	—	✓	✓	—	—

*1 Supports half.

*2 VESA CVT RB (Reduced Blanking) compliant

Note

- DIGITAL LINK input compatible signal is the same as HDMI input compatible signal.

Specifications

The specifications of the projector are as follows.

Power supply		100 V - 120 V / 200 V - 240 V ~ (100 V - 120 V / 200 V - 240 V alternating current), 50 Hz/60 Hz	
Power consumption		940 W (9.6 A) / 1 510 W (7.7 A)	
Power consumption (during standby)		When [STANDBY MODE] is set to [ECO]: 0.3 W	
		When [STANDBY MODE] is set to [NORMAL]: 4 W	
DLP chip	Size	PT-RZ21K	24.4 mm (0.96") (aspect ratio 16:10)
		PT-RS20K	24.1 mm (0.95") (aspect ratio 4:3)
	Display system	DLP chip x 3, DLP projection system	
	Number of pixels	PT-RZ21K	2 304 000 pixels (1 920 x 1 200 dots)
PT-RS20K		1 470 000 pixels (1 400 x 1 050 dots)	
Lens		Optional	
Light source		Laser x 2	
Light output		20 000 lm ^{*1} *3, 21 000 lm (center) ^{*2} *3 (When [OPERATING MODE] is set to [NORMAL])	
Center to corner zone ratio^{*1}		90 %	
Contrast ratio^{*1}		20 000:1 (when [DYNAMIC CONTRAST] is set to [3])	
Color system		7 standards (NTSC/NTSC4.43/PAL/PAL-N/PAL-M/SECAM/PAL60)	
Projected image size		1.78 m (70") to 25.40 m (1 000") ^{*4}	
Image aspect ratio		PT-RZ21K	16:10
		PT-RS20K	4:3
Projection method		[FRONT/CEILING], [FRONT/FLOOR], [REAR/CEILING], [REAR/FLOOR]	
Power cord length		3.0 m (118-1/8")	
Outer case		Molded plastic	
Outer color		Black	
Dimensions	Width	598 mm (23-17/32") (excluding protrusions)	
	Height	307 mm (12-3/32") (with the feet at shortest position)	
		270 mm (10-5/8") (excluding the feet and protrusion)	
Depth	725 mm (28-17/32") (excluding the protrusion)		
Weight		Approx. 49.0 kg (108.0 lbs.) ^{*5}	
Noise level^{*1}		46 dB	
Operating environment	Operating environment temperature	0 °C (32 °F) to 50 °C (122 °F) ^{*6} *7	
	Operating environment humidity	10 % to 80 % (no condensation)	
Remote control	Power supply	DC 3 V (AA/R6/LR6 battery x 2)	
	Operating range	Within approx. 30 m (98'5") (when operated directly in front of signal receiver)	
	Weight	150 g (5.3 ozs.) (including batteries)	
	Dimensions	Width: 47.5 mm (1-7/8"), Height: 181.5 mm (7-5/32"), Depth: 27.5 mm (1-3/32")	

*1 Measurement, measuring conditions, and method of notation all comply with ISO/IEC 21118:2012 international standards.

*2 The value of the light output at the center region of the projected image is extracted based on the light output measurement method defined by the ISO/IEC 21118:2012 international standards.

*3 When a projection lens other than ET-D75LE95, ET-D75LE90 is used with the power supply voltage of AC 200 V.

*4 When the Zoom Lens (Model No.: ET-D75LE8) is used, the projected image size for the maximum projection distance will be 1.78 m (70") to 15.24 m (600"). When the Fixed-focus Lens (Model No.: ET-D75LE95, ET-D75LE90) is used, the projected image size for the maximum projection distance will be 3.05 m (120") to 15.24 m (600").

*5 Average value. Weight varies for each product.

*6 The operating environment temperature should be between 0 °C (32 °F) and 45 °C (113 °F) if the projector is used at an altitude between 1 400 m (4 593') and 4 200 m (13 780') above sea level.

*7 When the [PROJECTOR SETUP] menu → [OPERATION SETTING] → [OPERATING MODE] is set to [NORMAL] or [ECO], the light output may be reduced to protect the projector.

- When using the projector at an altitude lower than 2 700 m (8 858') above sea level: 35 °C (95 °F)

- When using the projector at an altitude between 2 700 m (8 858') and 4 200 m (13 780') above sea level: 25 °C (77 °F)

Note

- The light output will decrease to approximately 1/2 when using the projector with AC 100 V to AC 120 V.
- The model numbers of accessories and optional accessories are subject to change without prior notice.

■ Terminal

<p><RGB 1 IN> terminal</p>	<p>1 set (BNC x 5 (RGB/YP_BP_R/YC_BC_R/YC/VIDEO x 1))</p> <p>RGB signal 0.7 V [p-p] 75 Ω (SYNC ON GREEN: 1.0 V [p-p] 75 Ω) SYNC/HD TTL high impedance, automatic positive/negative polarity compatible VD TTL high impedance, automatic positive/negative polarity compatible</p> <p>YP_BP_R signal Y: 1.0 V [p-p] including synchronization signal, P_BP_R: 0.7 V [p-p] 75 Ω</p> <p>Y/C signal Y: 1.0 V [p-p], C: 0.286 V [p-p] 75 Ω</p> <p>VIDEO signal 1.0 V [p-p] 75 Ω</p>
<p><RGB 2 IN> terminal</p>	<p>1 set, high-density D-Sub 15 p (female)</p> <p>RGB signal 0.7 V [p-p] 75 Ω (SYNC ON GREEN: 1.0 V [p-p] 75 Ω) SYNC/HD TTL high impedance, automatic positive/negative polarity compatible VD TTL high impedance, automatic positive/negative polarity compatible</p> <p>YP_BP_R signal Y: 1.0 V [p-p] including synchronization signal, P_BP_R: 0.7 V [p-p] 75 Ω</p>
<p><DVI-D IN> terminal</p>	<p>1 set, DVI-D 24 p, single link, DVI 1.0 compliant, HDCP compatible</p>
<p><HDMI IN> terminal</p>	<p>1 set, HDMI 19 p, HDCP compatible, Deep Color compatible</p>
<p><SDI IN 1> terminal</p>	<p>1 set (BNC)</p> <p>Single link SD-SDI signal SMPTE ST 259 compliant</p> <p>Single link HD-SDI signal SMPTE ST 292 compliant</p> <p>Single link 3G-SDI signal SMPTE ST 424, 425-2 compliant</p> <p>Dual link HD-SDI signal (Link A signal) SMPTE ST 372 compliant</p> <p>Dual link 3G-SDI signal (Link 1 signal) SMPTE ST 425-3 compliant</p>
<p><SDI IN 2> terminal</p>	<p>1 set (BNC)</p> <p>Single link SD-SDI signal SMPTE ST 259 compliant</p> <p>Single link HD-SDI signal SMPTE ST 292 compliant</p> <p>Single link 3G-SDI signal SMPTE ST 424, 425-2 compliant</p> <p>Dual link HD-SDI signal (Link B signal) SMPTE ST 372 compliant</p> <p>Dual link 3G-SDI signal (Link 2 signal) SMPTE ST 425-3 compliant</p>
<p><MULTI PROJECTOR SYNC IN> terminal/<3D SYNC 1 IN/OUT> terminal (dual purpose)</p>	<p>1 set (BNC)</p> <p>TTL high impedance</p> <p>When [3D SYNC MODE] is set to output, TTL output: Maximum 10 mA</p>
<p><MULTI PROJECTOR SYNC OUT> terminal/<3D SYNC 2 OUT> terminal (dual purpose)</p>	<p>1 set (BNC)</p> <p>TTL output: Maximum 10 mA</p>
<p><SERIAL IN>/ <SERIAL OUT> terminal</p>	<p>D-Sub 9 p, 1 set each, RS-232C compliant, for computer control</p>
<p><REMOTE 1 IN>/ <REMOTE 1 OUT> terminal</p>	<p>M3 stereo mini jack, 1 set each, for remote control (wired)/for projector connection control</p>
<p><REMOTE 2 IN> terminal</p>	<p>1 set, D-Sub 9 p, for contact control</p>
<p><DIGITAL LINK/LAN> terminal</p>	<p>1 set, RJ-45, for network and DIGITAL LINK connections (HDBaseT™ compliant), PLink (class 2) compatible, 100Base-TX, Art-Net compatible, HDCP compatible, Deep Color compatible</p>
<p><DC OUT 1> terminal/<DC OUT 2> terminal</p>	<p>2 sets, USB connector (type A), for power supply only (DC 5 V, 2 A total for two sets)</p>

■ Compatible signal

For details of the types of video signals that can be used with the projector, refer to “List of compatible signals” (➔ page 238).

Video signal input, Y/C signal input
Horizontal: 15.73 kHz, Vertical: 59.94 Hz; Horizontal: 15.63 kHz, Vertical: 50 Hz
RGB signal input
<ul style="list-style-type: none"> • Resolution: 640 x 400 to 1 920 x 1 200 • Dot clock frequency: 162 MHz or less • PIAS (Panasonic Intelligent Auto Scanning) system
Y_CC_R/Y_PP_R signal input
<ul style="list-style-type: none"> • Resolution: 480i/576i to 1 920 x 1 080 • Dot clock frequency: 148.5 MHz or less • The SYNC/HD and VD terminals do not support 3 value SYNC.
DVI-D signal input
<ul style="list-style-type: none"> • Moving image signal resolution: 480i^{*1}/576i^{*1} to 1 920 x 1 080 • Still image signal resolution: 640 x 400 to 1 920 x 1 200 (non-interlace) • Dot clock frequency: 25 MHz to 162 MHz
HDMI signal input
<ul style="list-style-type: none"> • Moving image signal resolution: 480i^{*1}/576i^{*1} to 1 920 x 1 080 • Still image signal resolution: 640 x 400 to 1 920 x 1 200 (non-interlace) • Dot clock frequency: 25 MHz to 162 MHz
SDI signal input
SD-SDI signal
HD-SDI signal
3G-SDI signal

*1 Pixel-Repetition signal (dot clock frequency 27.0 MHz) only

Note

- DIGITAL LINK input compatible signal is the same as HDMI input compatible signal.