

SANYO

PLC-WXU10N / WXU10E / WXU10B

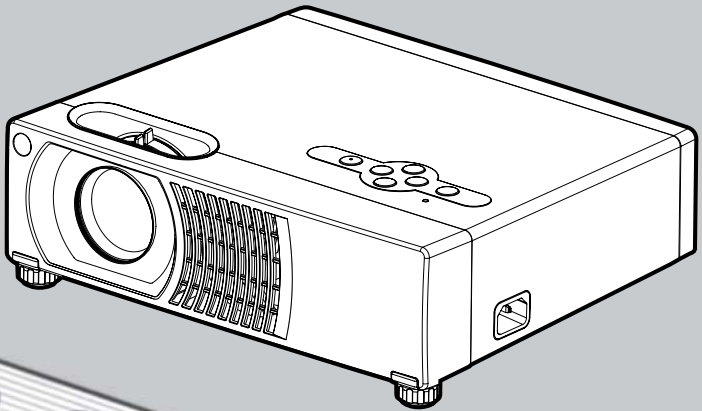

PROJECTOR

ProSelecta

View :: Compare :: Select - www.ProSelecta.com





To the Owner

Before operating this projector, read this manual thoroughly and operate the projector properly.

This projector provides many convenient features and functions. Operating the projector properly enables you to manage those features and maintains it in better condition for a considerable time.

Improper operation may result in not only shortening the product-life, but also malfunctions, fire hazard, or other accidents.

If your projector seems to operate improperly, read this manual again, check operations and cable connections and try the solutions in the "Troubleshooting" section in the end of this booklet. If the problem still persists, contact the dealer where you purchased the projector or the service center.

	CAUTION RISK OF ELECTRIC SHOCK DO NOT OPEN	
CAUTION: TO REDUCE THE RISK OF ELECTRIC SHOCK, DO NOT REMOVE COVER (OR BACK). NO USER-SERVICEABLE PARTS INSIDE EXCEPT LAMP REPLACEMENT. REFER SERVICING TO QUALIFIED SERVICE PERSONNEL.		
	THIS SYMBOL INDICATES THAT DANGEROUS VOLTAGE CONSTITUTING A RISK OF ELECTRIC SHOCK IS PRESENT WITHIN THIS UNIT.	
	THIS SYMBOL INDICATES THAT THERE ARE IMPORTANT OPERATING AND MAINTENANCE INSTRUCTIONS IN THE OWNER'S MANUAL WITH THIS UNIT.	

READ AND KEEP THIS OWNER'S MANUAL FOR LATER USE.

Safety Precaution

WARNING: TO REDUCE THE RISK OF FIRE OR ELECTRIC SHOCK, DO NOT EXPOSE THIS APPLIANCE TO RAIN OR MOISTURE.

- This projector produces intense light from the projection lens. Do not stare directly into the lens, otherwise, eye damage could result. Be especially careful that children do not stare directly into the beam.
- Install the projector in a proper position. If not, it may result in a fire hazard.
- Provide appropriate space on the top, sides and rear of the projector cabinet for allowing air circulation and cooling the projector. Minimum clearance must be maintained. If the projector is to be built into a compartment or similarly enclosed, the minimum distances must be maintained. Do not cover the ventilation slot on the projector. Heat build-up can reduce the service life of your projector, and can also be dangerous.

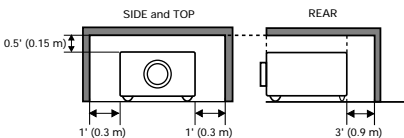

- If the projector is not to be used for an extended time, unplug the projector from the power outlet.

CAUTION

DO NOT SET THE PROJECTOR IN GREASY, WET, OR SMOKY CONDITIONS SUCH AS IN A KITCHEN TO PREVENT A BREAKDOWN OR A DISASTER. IF THE PROJECTOR COMES IN CONTACT WITH OIL OR CHEMICALS, IT MAY BECOME DETERIORATED.



NOTE: This symbol and recycle system are applied to EU countries only and not applied to the countries in the other area of the world.



Your SANYO product is designed and manufactured with high quality materials and components which can be recycled and reused.

This symbol means that electrical and electronic equipment, at their end-of-life, should be disposed of separately from your household waste.

Please dispose of this equipment at your local community waste collection/recycling centre. In the European Union there are separate collection systems for used electrical and electronic products.

Please help us to conserve the environment we live in!

CAUTION

Not for use in a computer room as defined in the Standard for the Protection of Electronic Computer/Data Processing Equipment, ANSI/NFPA 75.

Ne peut être utilisé dans une salle d'ordinateurs telle que définie dans la norme ANSI/NFPA 75 Standard for Protection of Electronic Computer/Data Processing Electronic.



Voor de klanten in Nederland

Bij dit produkt zijn batterijen geleverd.

Wanneer deze leeg zijn, moet u ze niet weggooien maar inleveren als KCA.



SANYO FISHER Sales (Europe) GmbH

Stahlgruberring 4, D-81829 München, Germany

SANYO Electric Co., Ltd.

1-1, Sanyo-cho, Daito City, Osaka 574-8534, Japan

Safety Instructions

All the safety and operating instructions should be read before the product is operated.

Read all of the instructions given here and retain them for later use. Unplug this projector from AC power supply before cleaning. Do not use liquid or aerosol cleaners. Use a damp cloth for cleaning.

Follow all warnings and instructions marked on the projector.

For added protection to the projector during a lightning storm, or when it is left unattended and unused for long periods of time, unplug it from the wall outlet. This will prevent damage due to lightning and power line surges.

Do not expose this unit to rain or use near water... for example, in a wet basement, near a swimming pool, etc...

Do not use attachments not recommended by the manufacturer as they may cause hazards.

Do not place this projector on an unstable cart, stand, or table. The projector may fall, causing serious injury to a child or adult, and serious damage to the projector. Use only with a cart or stand recommended by the manufacturer, or sold with the projector. Wall or shelf mounting should follow the manufacturer's instructions, and should use a mounting kit approved by the manufacturers.

An appliance and cart combination should be moved with care. Quick stops, excessive force, and uneven surfaces may cause the appliance and cart combination to overturn.



Slots and openings in the back and bottom of the cabinet are provided for ventilation, to ensure reliable operation of the equipment and to protect it from overheating.

The openings should never be covered with cloth or other materials, and the bottom opening should not be blocked by placing the projector on a bed, sofa, rug, or other similar surface. This projector should never be placed near or over a radiator or heat register.

This projector should not be placed in a built-in installation such as a book case unless proper ventilation is provided.

Never push objects of any kind into this projector through cabinet slots as they may touch dangerous voltage points or short out parts that could result in a fire or electric shock. Never spill liquid of any kind on the projector. Do not install the projector near the ventilation duct of air-conditioning equipment.

This projector should be operated only from the type of power source indicated on the marking label. If you are not sure of the type of power supplied, consult your authorized dealer or local power company.

Do not overload wall outlets and extension cords as this can result in fire or electric shock. Do not allow anything to rest on the power cord. Do not locate this projector where the cord may be damaged by persons walking on it.

Do not attempt to service this projector yourself as opening or removing covers may expose you to dangerous voltage or other hazards. Refer all servicing to qualified service personnel.

Unplug this projector from wall outlet and refer servicing to qualified service personnel under the following conditions:

- a. When the power cord or plug is damaged or frayed.
- b. If liquid has been spilled into the projector.
- c. If the projector has been exposed to rain or water.
- d. If the projector does not operate normally by following the operating instructions. Adjust only those controls that are covered by the operating instructions as improper adjustment of other controls may result in damage and will often require extensive work by a qualified technician to restore the projector to normal operation.
- e. If the projector has been dropped or the cabinet has been damaged.
- f. When the projector exhibits a distinct change in performance-this indicates a need for service.

When replacement parts are required, be sure the service technician has used replacement parts specified by the manufacturer that have the same characteristics as the original part. Unauthorized substitutions may result in fire, electric shock, or injury to persons.

Upon completion of any service or repairs to this projector, ask the service technician to perform routine safety checks to determine that the projector is in safe operating condition.



Air Circulation

Openings in the cabinet are provided for ventilation and to ensure reliable operation of the product and to protect it from overheating, and these openings must not be blocked or covered.

CAUTION

Hot air is exhausted from the exhaust vent. When using or installing the projector, the following precautions should be taken.

- Do not put any flammable object or spray can near the projector, hot air is exhausted from the ventilation holes.
- Keep the exhaust vent at least 90 cm away from any objects.
- Do not touch a peripheral part of the exhaust vent, especially screws and metallic part. This area will become hot while the projector is being used.
- Do not put anything on the cabinet. Objects put on the cabinet will not only get damaged but also cause fire hazard by heat.

Cooling fans are provided to cool down the projector. The fans' running speed is changed according to the temperature inside the projector.

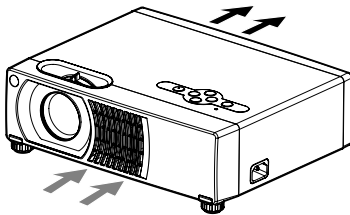

Moving the Projector

When moving the projector, replace the lens cap and retract the elevator feet to prevent damage to the lens and cabinet. When the projector is not in use for an extended period, put it into a suitable case with the lens side up to protect the projector.

When handling the projector, do not drop, bump, subject it to strong forces, or put other things on the cabinet.

Installing the Projector in Proper Position

Install the projector properly. Improper installation may reduce the lamp life and cause a fire hazard.



Do not tilt the projector sideways.



Do not point the projector up to project an image.



Do not point the projector down to project an image.



Do not put the projector on either side to project an image.

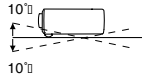

Do not pitch the projector more than 10 degrees backward and forward.

USE CAUTION IN CARRYING OR TRANSPORTING THE PROJECTOR

- Do not drop or bump the projector, otherwise damages or malfunctions may result.
- When carrying the projector, use a suitable carrying case.
- Do not transport the projector by using a courier or transport service in an unsuitable transport case. This may cause damage to the projector. To transport the projector through a courier or transport service, consult your dealer for their information.
- Do not put the projector in a case before the projector is cooled enough.

Compliance

Federal Communications Commission Notice

Note: This equipment has been tested and found to comply with the limits for a Class B digital device, pursuant to Part 15 of the FCC Rules. These limits are designed to provide reasonable protection against harmful interference in a residential installation. This equipment generates, uses, and can radiate radio frequency energy, and if not installed and used in accordance with the instructions, may cause harmful interference to radio communications. However, there is no guarantee that interference will not occur in a particular installation. If this equipment does cause harmful interference to radio or television reception, which can be determined by turning the equipment off and on, the user is encouraged to try to correct the interference by one or more of the following measures:

- Reorient or relocate the receiving antenna.
- Increase the separation between the equipment and receiver.
- Connect the equipment into an outlet on a circuit different from that to which the receiver is connected.
- Consult the dealer or an experienced radio/TV technician for help.

Use of shielded cable is required to comply with class B limits in Subpart B of Part 15 of FCC Rules. Do not make any changes or modifications to the equipment unless otherwise specified in the instructions.

If such changes or modifications should be made, you could be required to stop operation of the equipment.

Model Number : PLC-WXU10N
Trade Name : Sanyo
Responsible party : SANYO FISHER COMPANY
Address : 21605 Plummer Street, Chatsworth, California 91311
Telephone No. : (818)998-7322

AC Power Cord Requirement

The AC Power Cord supplied with this projector meets the requirement for use in the country you purchased it.

AC Power Cord for the United States and Canada:

AC Power Cord used in the United States and Canada is listed by the Underwriters Laboratories (UL) and certified by the Canadian Standard Association (CSA). AC Power Cord has a grounding-type AC line plug. This is a safety feature to be sure that the plug will fit into the power outlet. Do not try to defeat this safety feature. Should you be unable to insert the plug into the outlet, contact your electrician.

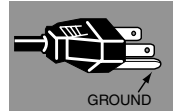

AC Power Cord for the United Kingdom:

This cord is already fitted with a moulded plug incorporating a fuse, the value of which is indicated on the pin face of the plug. Should the fuse need to be replaced, an ASTA approved BS 1362 fuse must be used of the same rating, marked thus . If the fuse cover is detachable, never use the plug with the cover omitted. If a replacement fuse cover is required, ensure it is of the same colour as that visible on the pin face of the plug (i.e. red or orange). Fuse covers are available from the Parts Department indicated in your User Instructions.

If the plug supplied is not suitable for your socket outlet, it should be cut off and destroyed.

The end of the flexible cord should be suitably prepared and the correct plug fitted.

WARNING : A PLUG WITH BARED FLEXIBLE CORD IS HAZARDOUS IF ENGAGED IN A LIVE SOCKET OUTLET.

The Wires in this mains lead are coloured in accordance with the following code:

Green-and-yellowEarth
Blue.....Neutral
BrownLive

As the colours of the wires in the mains lead of this apparatus may not correspond with the coloured markings identifying the terminals in your plug proceed as follows:

The wire which is coloured green-and-yellow must be connected to the terminal in the plug which is marked by the letter E or by the safety earth symbol  or coloured green or green-and-yellow. The wire which is coloured blue must be connected to the terminal which is marked with the letter N or coloured black.

The wire which is coloured brown must be connected to the terminal which is marked with the letter L or coloured red.

WARNING: THIS APPARATUS MUST BE EARTHED.

THE SOCKET-OUTLET SHOULD BE INSTALLED NEAR THE EQUIPMENT AND EASILY ACCESSIBLE.



Notes on AC Power Cord

AC Power Cord must meet requirement of country where you use a projector. Confirm an AC plug type with graphics below and proper AC Power Cord must be used. If supplied AC Power Cord does not match your AC outlet, contact your sales dealer. This projector is equipped with a grounding type AC line plug. Make sure that your outlet fits the plug. Do not defeat the safety purpose of this grounding type plug. We highly recommend using a video source device also equipped with a grounding type AC line plug to prevent from signal interference due to voltage fluctuation.

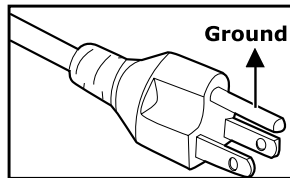

For the U.S.A. and Canada

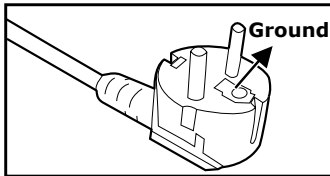

For Continental Europe

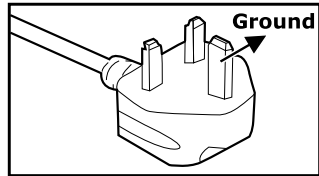

For the U.K.

CAUTION

The socket-outlet should be installed near the equipment and easily accessible.

CONTENTS

Introduction	8
Projector Features	8
Package Contents	9
Projector Overview	10
Using the Product	12
Control Panel	12
Connection Ports	13
Remote Control	14
Installing the Batteries	15
Remote Control Operation	16
Installation	17
Connecting the Projector	17
Powering On/Off the Projector	18
Adjusting the Projected Image	19
Menu Operation	22
Picture (Computer Mode)	24
Picture (Video Mode)	25
Image (Computer Mode)	26
Image (Video Mode)	28
Setting (Computer / Video Mode)	29
Sound (Computer / Video Mode)	30
Advanced (Computer / Video Mode)	30
Language (Computer / Video Mode)	30
Maintenance	31
Cleaning the Lens	31
Cleaning the Projector Housing	31
Cleaning the Air Filter	32
Replacing the Lamp	33
Specifications	35
Appendix	36
LED Indicator Messages	36
Optional Parts	36
Compatibility Modes	37
Troubleshooting	38
Serial Control Interface	40



Introduction

Projector Features

The projector integrates high-performance optical engine projection and a user-friendly design to deliver high reliability and ease of use.

The projector offers the following features:

- 3 panel 0.56 inch LCD projector
- WXGA (1280 x 800 pixels)
- 1.2X manual zoom lens
- Auto image re-sizing (Auto-Sync.) to 1280 x 800 full screen with scaling compression compatibility for VGA, SVGA, XGA and SXGA*
- Compatibility with Macintosh® computers
- Compatibility with NTSC, PAL, SECAM, and HDTV
- Multi-function remote control
- D-Sub 15-pin terminal for input / output signal
- DVI 24-pin terminal for connecting DVI output from a computer
- User-friendly, multi-language on-screen display (OSD)
- Advanced electronic keystone correction



* means compressed.

Package Contents

When you unpack the projector, make sure you have all these components:

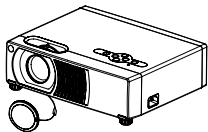

Projector with Lens Cap

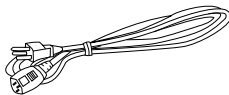

AC Power Cord
(USA: J2552-0109-00)
(UK: J2552-0108-00)
(Europe: J2552-0107-00)

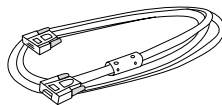

VGA Cable (D-Sub to D-Sub)
(J2552-0072-03)

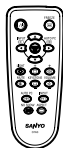

Remote Control (IR)

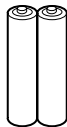

AAA size batteries
for remote control



Owner's Manual



Projector Carrying Case



Quick Start Guide



NOTE

- Save the original shipping carton and packing material; they will come in handy if you ever to ship your unit. For maximum protection, repack your unit as it was originally packed at the factory.
- Accessories and components may vary by retailer and region.



Projector Overview

Front View

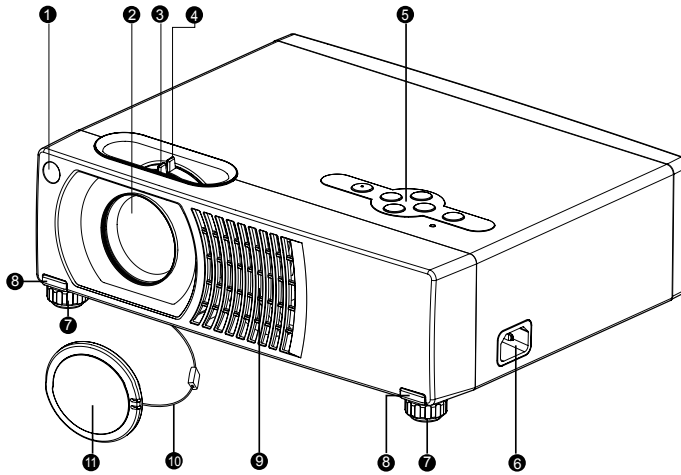

- ① Front IR remote control sensor
- ② Projection lens
- ③ Focus ring
- ④ Zoom ring
- ⑤ Control panel

- ⑥ AC power socket
- ⑦ Elevator foot
- ⑧ Elevator button
- ⑨ Ventilation holes
- ⑩ Lens cap strap
- ⑪ Lens cap

Rear View

- ❶ Ventilation holes
- ❷ Connection ports
- ❸ Kensington lock
- ❹ Rear IR remote control sensor
- ❺ Speaker

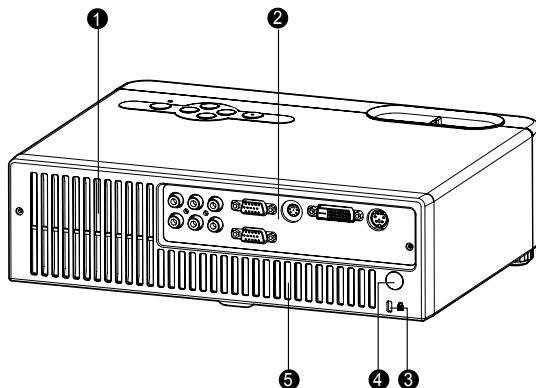

Bottom View

- ❶ Air filter cover
- ❷ Lamp cover
- ❸ Ceiling mount (3-M4*6)

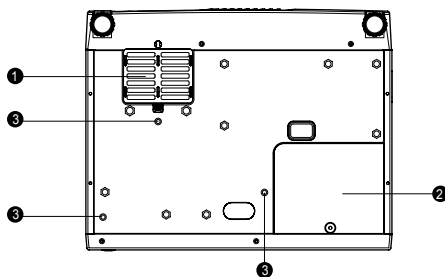

- *This projector can be used with a ceiling mount for support. The ceiling mount is not included in the package.*



Using the Product

Control Panel

LED

- ❶ Lamp LED indicator
Refer to “LED Indicator Messages”.
- ❷ Power LED indicator
Refer to “LED Indicator Messages”.

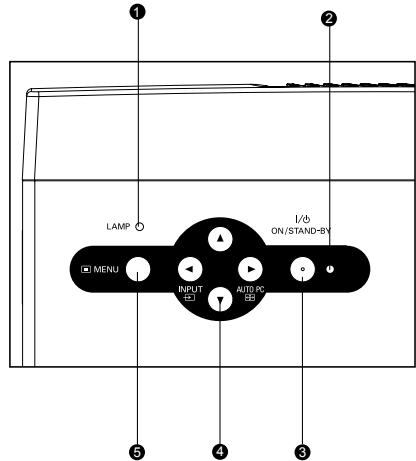

Button Function

- ❸ **ON / STAND-BY**
Refer to “Powering On/Off the Projector”.
- ❹ **Four directional (INPUT/AUTO PC) buttons**
 - Use four directional buttons to select items or make adjustments to your selection.
 - Manually selects an input source. (Left button)
 - Automatically adjusts Fine Sync and Total Dots. This function is available for computer mode only. (Right button)
- ❺ **MENU**
Displays or exits the on-screen display menus.

Connection Ports

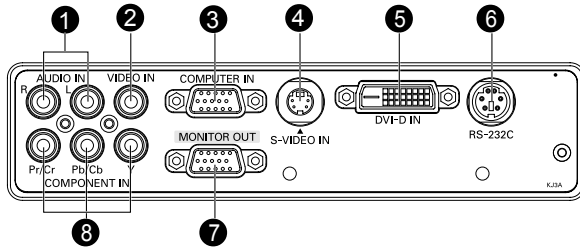

1 AUDIO IN (R/L)

Connects an audio output from video equipment or computer to this jack.

2 VIDEO IN

Connects composite video output from video equipment to this jack.

3 COMPUTER IN

Connects analog RGB output signal from a computer to this jack.

4 S-VIDEO IN

Connects S-Video output from video equipment to this jack.

5 DVI-D IN

Connects DVI output from a computer to this jack.

6 RS-232C

When operating the projector via a computer, connect this to the controlling computer's RS-232C port.

7 MONITOR OUT

This terminal can be used to output the incoming signal from COMPUTER IN terminal to the other monitor.

8 COMPONENT IN (Y Cb/Pb Cr/Pr)

Connects Y Cb/Pb Cr/Pr output from video equipment to this jack.



Remote Control

- 1 ON / STAND-BY**
Refer to "Powering On/Off the Projector".
- 2 Four directional (INPUT/AUTO PC) buttons**
 - Use four directional buttons to select items or make adjustments to your selection.
 - Manually selects an input source. (Left button)
 - Automatically adjusts Fine Sync and Total Dots. This function is available for computer mode only. (Right button)
- 3 MENU**
Displays or exits the on-screen display menus.
- 4 LIGHT**
Press and hold this button to activate the LED light. If you press and hold the LIGHT button continuously or frequently, the batteries may terminate the life in a shorter period.
- 5 MUTE**
Cuts off the sound temporarily. Press again to cancel the MUTE function.
- 6 AUTO PC**
Automatically adjusts Fine Sync and Total Dots. This function is available for computer mode only.
- 7 NO SHOW**
Cuts off the screen temporarily. Press again to cancel the NO SHOW function.
- 8 ASPECT**
Switch the image aspect ratio.
- 9 INPUT**
Manually selects an input source.
- 10 KEYSTONE + / -**
Adjusts image distortion caused by tilting the projector.
- 11 VOLUME + / -**
Press Volume + button to increase the volume.
Press Volume - button to reduce the volume.
- 12 FREEZE**
Press "FREEZE" to pause the screen image.
Press again to cancel the FREEZE function.

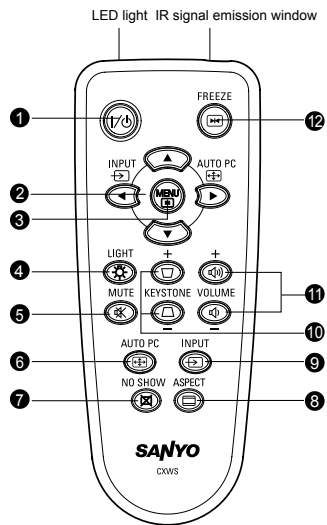

Installing the Batteries

1. Open the battery cover in the direction shown.

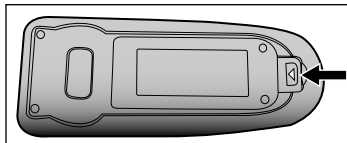

2. Install batteries as indicated by the diagram inside the compartment.

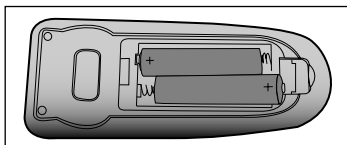

3. Close the battery cover into position.

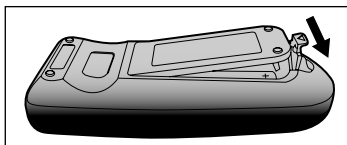

NOTE

- *Keep the batteries out of the reach of children. There is a danger of death by accidentally swallowing the battery.*
- *Remove batteries from remote control when not using for extended periods.*
- *Do not dispose of the used battery along with household waste. Dispose of used batteries according to local regulations.*
- *Danger of explosion may happen if batteries are incorrectly replaced. Replace all the batteries with new ones.*



Remote Control Operation

Point the remote control at the infrared remote sensor and press a button.

■ Operating the projector from the front

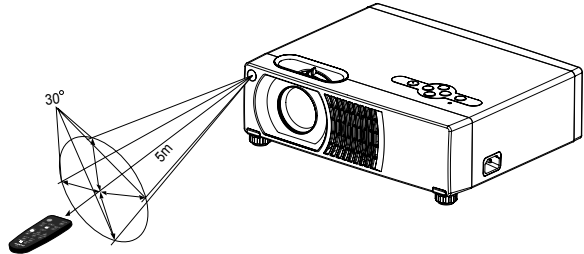

■ Operating the projector from the rear

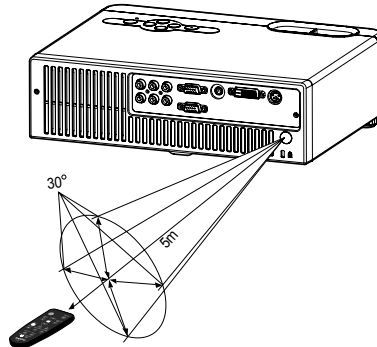

- Do not point the LED light pointer directly to the people's eyes (especially small children). There is a danger of injury to the eyes.
- The remote control may not operate when there is sunlight or other strong light such as a fluorescent lamp shining on the remote sensor.
- Operate the remote control from a position where the remote sensor is visible.
- Do not drop the remote control or jolt it.
- Keep the remote control out of locations with excessively high temperature or humidity.
- Do not get water on the remote control or place wet objects on it.
- Do not disassemble the remote control.

Installation

Connecting the Projector

- ❶ Audio Cable
- ❷ VGA Cable (D-Sub to D-Sub)*
- ❸ DVI Cable
- ❹ RS232C Cable
- ❺ YCbCr Cable
- ❻ Composite Video Cable
- ❼ VGA (D-Sub) to HDTV (RCA) Cable
- ❽ S-Video Cable

* One cable is supplied. Other cables are not supplied with the projector.

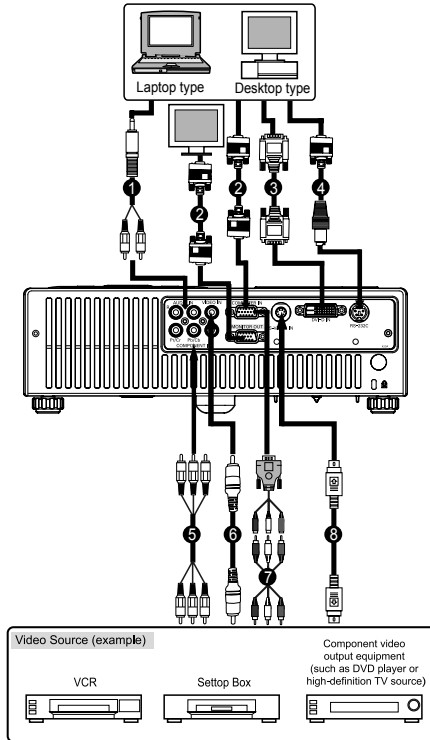

- When connecting cable, power cords of both a projector and external equipment should be disconnected from AC outlet.
- The figure above is a sample connection. This does not mean that all of these devices can or must be connected simultaneously.
- The cables that come with the projector may differ from the above illustration. The included cables are based on actual shipment delivery. See page 36 for ordering optional cables.



Powering On/Off the Projector

Powering on the projector:

1. Remove the projector lens cap.
2. Complete the AC power cord and peripheral signal cable(s) connections.
3. Press **ON / STAND-BY** button to turn on the projector.
4. Turn on your source (computer, notebook, DVD, etc.). The projector automatically detects your source.
 - When searching message appears on the screen, ensure that the appropriate signal cable(s) are securely connected.
 - The signal message will appear on the screen when the source is detected.
 - If you are connecting multiple sources to the projector simultaneously, press **INPUT** button.

Warning:

- Remove the lens cap first before powering on.
- Never look into the lens when the lamp is on. This can damage your eyes. It is especially important that children are not allowed to look into the lens.
- To avoid image sticking, it is not recommended that you project the same still image for more than 15 minutes.
- Faster on-off-cycles will damage the lamp and reduce lamp life. Wait at least for 7 minutes to turn off the projector after powering on.

Powering Off the Projector:

1. Press **ON / STAND-BY** button to turn off the projector lamp. You will see a message "Power Off? Press Power again" appear on the screen.
2. Press **ON / STAND-BY** button again to confirm.
3. The cooling fans continue to operate for cooling cycle and the Lamp LED goes out. When the Power LED begins flashing, the projector has entered standby mode. If you wish to turn the projector back on, you must wait until the projector has completed the cooling cycle and has entered standby mode. Once in standby mode, simply press **ON / STAND-BY** button to restart the projector.
4. Disconnect the power cord from the electrical outlet and the projector.



- *Please wait until the fan motor and the Lamp LED turn off before removing the AC power cord from the projector.*
- *Faster on-off-cycles will damage the lamp and reduce lamp life. Wait at least for 7 minutes to turn off the projector after powering on.*

Adjusting the Projected Image

Adjusting the Projector Height

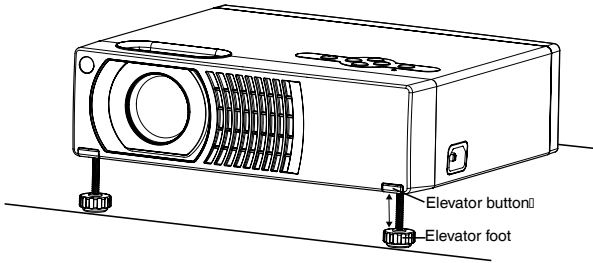

The projector is equipped with two elevator feet to adjust the image height up to 9.0 degrees.

To raise the image:

1. Press the elevator button.
2. Raise the image to the desired height angle, then release the button to lock the elevator feet into position.

To lower the image:

1. Press the elevator button.
2. Lower the image, then release the button to lock the elevator feet into position.



- *To avoid damaging the projector, make sure that the elevator feet are fully retracted before placing the projector in its carrying case (supplied).*



Adjusting the Projector Zoom and Focus

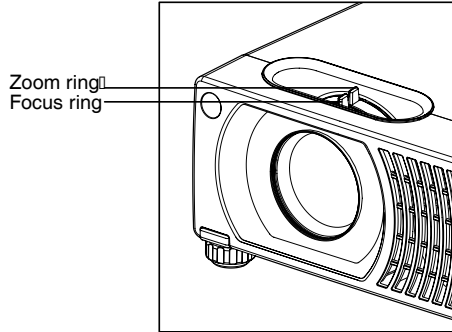

1. Adjust the image by rotating the zoom ring. Rotate to the right to reduce the image. Rotate to the left to enlarge the image.
2. Focus the image by rotating the focus ring. A still image is recommended for focusing.

Adjusting Projection Image Size

Refer to the graphic and table below to determine the screen size and projection distance.

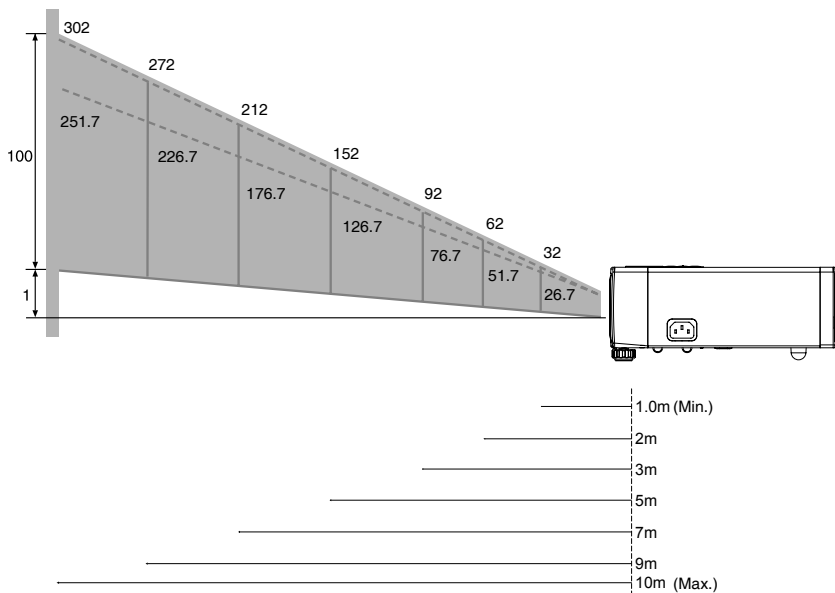

PROJECTION DISTANCE (METER)		1.0	2.0	3.0	5.0	7.0	9.0	10.0
16:10 SCREEN SIZE-DIAGONAL (INCH)	Wide	32	62	92	152	212	272	302
	Tele	26.7	51.7	76.7	126.7	176.7	226.7	251.7



- Position the projector in a horizontal position; other positions can cause heat build-up and damage to the projector.
- Make sure the heat ventilation holes are not blocked.
- Do not use the projector in a smoky environment. Smoke residue may cause buildup on critical parts.



Menu Operation

The projector has multilingual On Screen Display menus that allow you to make image adjustments and change a variety of settings.

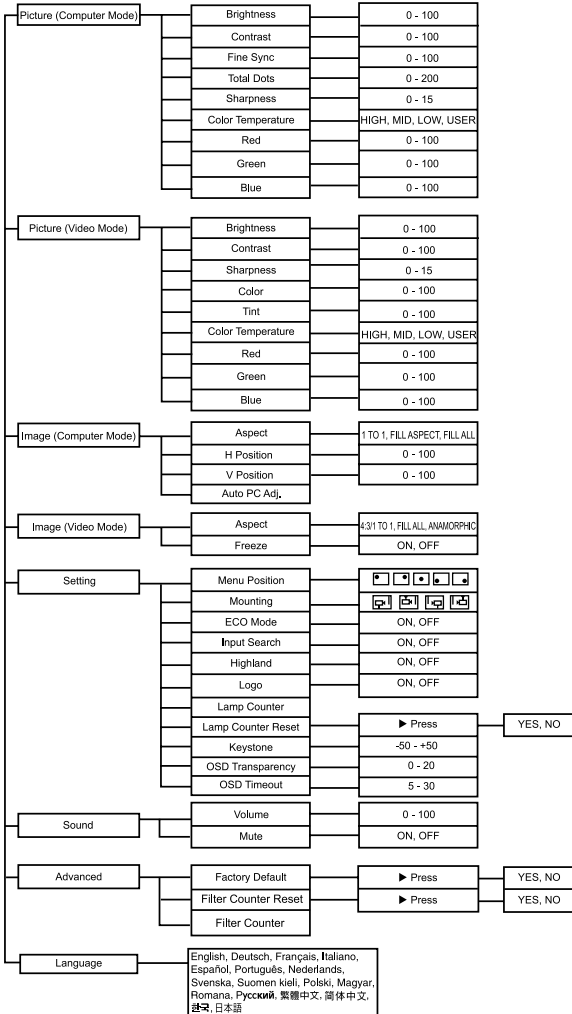

How to operate

1. Press **MENU** button to open the OSD menu.
2. When OSD is displayed, use ▲ / ▼ buttons to select any feature in the main menu. After selecting the desired main menu feature, press ► button to enter sub-menu for feature setting.
3. Adjust the settings with ◀ / ▶ buttons.
4. Press **MENU** button, the screen will return to the main menu.
5. To exit OSD, press **MENU** button again. The OSD menu will close and the projector will automatically save the new settings.



Picture (Computer Mode)

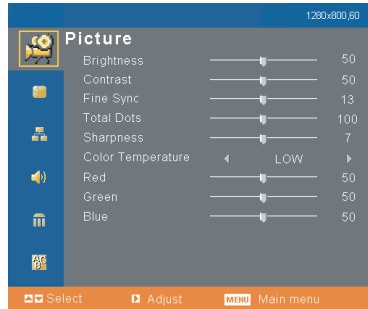

Brightness

Adjusts brightness of the image.

- Press ◀ to darken the image.
- Press ▶ to lighten the image.

Contrast

Adjusts contrast of the image.

- Press ◀ to decrease the contrast.
- Press ▶ to increase the contrast.

Fine Sync

“Fine Sync” synchronizes the signal timing of the display with that of the graphic card. If you experience an unstable or flickering image, use the fine sync function to correct it.

Total Dots

“Total Dots” changes the display data frequency to match the frequency of your computer’s graphic card. If you experience a vertical flickering bar, use this function to make an adjustment.

Sharpness

Adjusts the sharpness of the image.

- Press ◀ to decrease the sharpness.
- Press ▶ to increase the sharpness.

Color Temperature

Adjusts color temperature. At higher temperature, the screen looks colder; at lower temperature, the screen looks warmer. If you select “USER”, “Red”, “Green” and “Blue” can be adjusted.

Red

Manually adjusts red.

Green

Manually adjusts green.

Blue

Manually adjusts blue.

Picture (Video Mode)



Brightness

Adjusts the brightness of the image.

Contrast

Adjusts contrast of the image.

Sharpness

Adjusts the sharpness of the image.

Color

Adjusts the color saturation of the image.

Tint

Adjusts the color balance of red and green.

Color Temperature

Adjusts color temperature. At higher temperature, the screen looks colder; at lower temperature, the screen looks warmer. If you select "USER", "Red", "Green" and "Blue" can be adjusted.

Red

Manually adjusts red.

Green

Manually adjusts green.

Blue

Manually adjusts blue.



Image (Computer Mode)

Aspect

Use this function to choose your desired image size.

- **1 TO 1** : Keep the image with original width-height ratio.
- **FILL ASPECT** : Maintain the original aspect ration of the input signal while enlarging to fill as much of the output display as possible. 16:9 input on a 4:3 output will result in black bars on the top and bottom.
- **FILL ALL** : The input source will be scaled to fit the projection screen.



1 TO 1

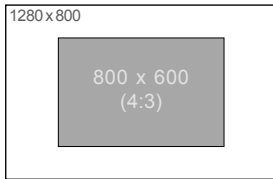

If input signal is smaller than LCD resolution, it will keep the original size and aspect ratio.

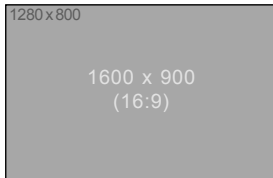

If input signal is bigger than LCD resolution, it will full all the whole screen and ignore the aspect ratio. ex. 1600x960 is 16:9 signal, but the actual image is 16:10.

FILL ASPECT (PC only)

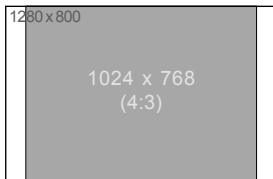

If the aspect ratio is different with the LCD, it will keep the input signal aspect and fit the maximum size.

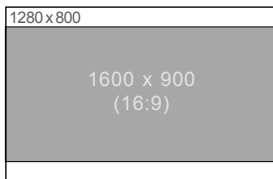

FILL ALL



Always fill the whole LCD.

H Position (Horizontal Position)

- Press ◀ to move the image left.
- Press ▶ to move the image right.

V Position (Vertical Position)

- Press ▲ to move the image down.
- Press ▼ to move the image up.

Auto PC Adj.

Automatically scans the input source.



Image (Video Mode)

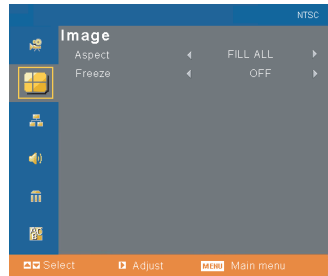

Aspect

Use this function to choose your desired image size.

- 4 : 3 : Change the original aspect 1:1 to 4:3 at the composite video input or S-video input.
- 1 TO 1 : Keep the image with original width-height ratio at the component input.
- FILL ALL : The input source will be scaled to fit the projection screen.
- ANAMORPHIC : Maintain the original aspect ratio in the center of the output image and place the majority of the distortion towards the horizontal edges of the image.

ANAMORPHIC (Video only)

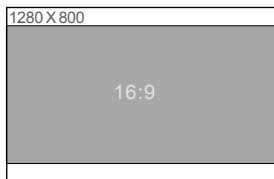

No matter what input signal is, output aspect ratio is 16:9 and fit to the whole screen.

Freeze

- Choose "ON" to freeze the screen image.
- Choose "OFF" to unfreeze the screen image.

Setting (Computer / Video Mode)

Menu Position

Choose the menu location on the display screen.

Mounting

-  **Front-Desktop**

The factory default setting.

-  **Front-Ceiling**

When you select this function, the projector turns the image upside down for ceiling-mounted projection.

-  **Rear-Desktop**

When you select this function, the projector reverses the image so you can project behind a translucent screen.

-  **Rear-Ceiling**

When you select this function, the projector reverses and turns the image upside down at same time. You can project from behind a translucent screen with ceiling mounted projection.

ECO Mode

Use this function to dim the projector lamp light output which will lower power consumption and increase lamp life.

Input Search

Use to automatically search input signal.

Highland

Turn on Highland mode operates the fans at full speed continuously to allow for proper high altitude cooling of the projector.

Logo

Choose to display the logo or not.

Lamp Counter

Displays Hour the lamp's elapsed operating time (in hours).

Lamp Counter Reset

Press **▶** to enter its sub-menu. Press **MENU** button to turn the lamp hour counter to 0 hours.

Keystone

Adjusts image distortion caused by tilting the projector.

OSD Transparency

Use to adjust OSD's transparency.

OSD Timeout

Duration OSD menu stays active (at idle state by second).





Sound (Computer / Video Mode)

Volume

- Press ◀ to decrease the volume.
- Press ▶ to increase the volume.

Mute

- Choose "ON" to turn mute on.
- Choose "OFF" to turn mute off.

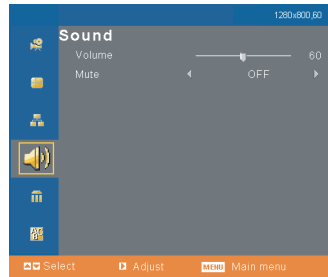

Advanced (Computer / Video Mode)



Factory Default

Press ▶ to enter its menu. Press **MENU** button to return the display parameters on all menus to the factory default settings.

Filter Counter Reset

Press ▶ to enter its sub-menu. Press **MENU** button to set the filter counter to 0.

Filter Counter

Displays Hour the filter's elapsed operating time (in hours).

Language (Computer / Video Mode)



Choose the multilingual OSD menu. Use ▲ / ▼ to select your preferred language. Press ▶ to finalize the selection.

Maintenance

The projector needs proper maintenance. You should keep the lens clean as dust, dirt or spots will project on the screen and diminish image quality. If any other parts need replacing, contact your dealer or qualified service personnel. When cleaning any part of the projector, always switch off and unplug the projector first.

Warning:

Never open any of the covers on the projector. Dangerous electrical voltages inside the projector can cause severe injury. Do not attempt to service this product yourself. Refer all servicing to qualified service personnel.

Cleaning the Lens

Gently wipe the lens with lens cleaning paper. Do not touch the lens with your hands.

Cleaning the Projector Housing

Gently wipe with a soft cloth. If dirt and stains are not easily removed, use a soft cloth dampened with water, or water and neutral detergent, and wipe dry with a soft, dry cloth.



Cleaning the Air Filter

The air filter, which is located at the bottom of the projector, should be cleaned after every 100 hours of use. If it is not cleaned periodically, it can become clogged with dust and prevent the projector from being ventilated properly. This can cause over heating and damage the projector.

When the projector reached a specified time, the filter warning message "Please clean up filter" appears on the screen, notifying the cleaning is necessary.

To clean the air filter:

1. Switch the projector off and unplug the AC power cord from the wall socket.
2. Place a protective sheet (cloth) beneath the projector. Turn the projector over so you can see its underside.
 - Be sure that the projector is stable after turning it over.
3. Remove the air filter by pushing the filter tab.
4. Clean the air filter.
 - To clean the filter, you are advised to use a small vacuum cleaner designed for computers and other office equipment.
 - If the dirt is difficult to remove or if the filter is torn, replace it. Consult your dealer for details.
Replacement Filter Part No. : 610 337 9623
5. Replace the filter.
6. Plug the power back into the projector.
7. Be sure to reset the filter counter after cleaning or replacing the filter. See "Filter Counter Reset" on page 30.

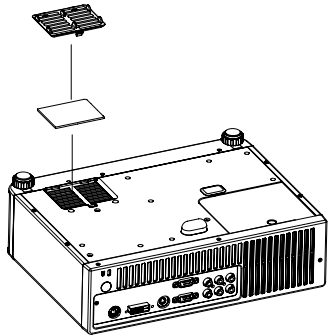

- Turn off the projector and remove the AC power cord from the power outlet before beginning maintenance work.
- Make sure the lens is cool before cleaning.
- Do not use detergents or chemicals other than those noted above. Do not use benzene or thinners.
- Do not use chemical sprays.
- Use a soft cloth or lens paper only.
- Be sure to reset the filter counter only after cleaning or replacing the air filter.
- The filter warning message also appears at turning on.
- The filter warning message will not turn off until the filter counter is reset.
- Do not operate the projector with the filter removed. Dust may accumulate on the optical elements degrading picture quality.

Replacing the Lamp

Projector lamps have a finite life. Replace the lamp when:

- A warning message “Lamp is approaching the end of its useful life in full power operation. Replacement suggested!” appears on the screen.
- The image becomes darker and hues become weaker after a lamp has been for a long period of time.
- Refer to section titled “**LED Indicator Messages**” for further details.



- *The lamp becomes high temperature after turning off the projector with the ON/STAND-BY button. If you touch the lamp, you may scald your finger. When you replace the lamp, wait for at least 45 minutes for the lamp to cool down.*
- *Do not touch the lamp glass at any time. The lamp may explode due to improper handling, including the touching of the lamp glass.*
- *Lamp lifetime may differ from lamp to lamp and according to the environment of use. There is no guarantee of the same lifetime for each lamp. Some lamps may fail or terminate their lifetime in a shorter period of time than other similar lamps.*
- *A lamp may explode as a result of vibration, shock or degradation as a result of hours of use as its lifetime draws to an end. Risk of explosion may differ according to the environment or conditions in which the projector and lamp are being used.*
- *Wear protective gloves and eyeglasses when fixing or detaching the lamp.*
- *Faster on-off-cycles will damage the lamp and reduce lamp life. Wait at least for 7 minutes to turn off the projector after powering on.*
- *Do not operate the lamp in proximity to paper, cloth, or other combustible material nor cover it with such materials. Otherwise it could cause a fire.*
- *Do not operate the lamp in an atmosphere containing an inflammable substance, such as thinner. Otherwise it could cause a fire or explosion.*
- *Thoroughly ventilate the area or the room when operating the lamp in an oxygen atmosphere (in the air). If ozone is inhaled, it could cause headaches, nausea, dizziness, etc.*
- *The inorganic mercury is involved in the lamp. If the lamp bursts, the mercury inside the lamp will go out of the projector. Leave the area immediately if the lamp shatters while being operated and ventilate the area for at least 30 minutes in order to avoid the inhalation of mercury fumes. Otherwise it could be harmful to user's health.*



1. Turn off the projector and unplug the AC power cord.
2. Place a protective sheet (cloth) beneath the projector. Turn the projector over so you can access the lamp cover.
3. Loosen the access panel screw and open the panel.
4. Loosen the screws on the bottom of the lamp assembly.
5. Grasp the lamp handle and pull the lamp assembly directly out of the projector.
6. Replace with the new lamp.
7. Tighten the screws on the bottom of lamp assembly.
8. Tighten the screw on the lamp cover.
9. Reset the lamp hour. Refer to the "Setting (Computer/Video Mode)" menu.

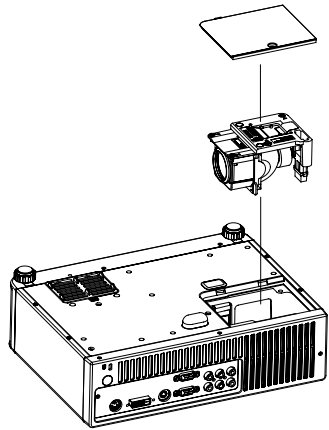

- *Dispose of the used lamp according to local regulations.*
- *Ensure that screws are tightened properly. Screws not tightened fully may result in injury or accidents.*
- *Since the lamp is made of glass, do not drop the unit and do not scratch the glass.*
- *Do not reuse the old lamp. This could cause the lamp to explode.*
- *Be sure to turn off the projector and unplug the AC power cord before replacing the lamp.*
- *Do not use the projector with the lamp cover removed.*

ORDER REPLACEMENT LAMP

Replacement lamp can be ordered through your dealer. When ordering a projection lamp, give the following information to the dealer.

- Model No. of your projector: PLC-WXU10N/ WXU10E/ WXU10B
- Replacement Lamp Type No.: POA-LMP113
(Service Parts No. 610 336 0362)

Specifications

Display Type	3 panel 0.56 inch LCD projector
Resolution (Pixels)	1280 x 800 (1,024,000 dot x 3)
Lens	Manual Zoom (1.2X)
Aspect Ratio	16:10 (Default)
Screen Size	26.7" - 302"
Lamp	210W
Video Compatibility	NTSC3.58, NTSC4.43 PAL-60, PAL-M,N SECAM HDTV (480i/p, 576i/p, 720p, 1080i)
Input Source	D-Sub 15 pin, S-Video, Composite Video, YCbCr, DVI, RCA type x 2, RS232
Output Source	D-Sub 15 pin
Scanning Frequency	
Horizontal Frequency	15K - 80 KHz
Vertical Frequency	50 - 85 Hz
Integrated Speaker	1 x 2W
Storage Temperature	-20 - + 60°C
Operation Temperature	0 - + 35°C
Power Requirement	AC 100 – 240V, 50 / 60 Hz
Power Consumption	280W
Dimension (W x D x H)	298 x 237 x 98mm
Weight	3.2kg (7.0lb)

* Design and Specifications are subject to change without prior notice.

* LCD panels are manufactured to the highest possible standards. Even though 99.99% of the pixels are effective, a tiny fraction of the pixels (0.01% or less) may be ineffective by the characteristics of the LCD panels.

Remote Control

Batteries	AAA size batteries x 2
Operating Range	5m
Dimensions	108 x 42 x 20mm
Net Weight	40g (without batteries)



Appendix

LED Indicator Messages

Projector Status	LED Type				Meaning
	Power LED		Lamp LED		
	Color	Status	Color	Status	
Standby	Green	Flashing	-	Off	The projector is powered and ready.
Lamp waiting	Green	On	-	Off	Preparing lamp ignition.
Lamp on	Green	On	Green	On	The lamp is in good condition.
Lamp ignition failure	Green	On	Red	Flashing	The lamp ignition failed at turning on. The lamp ignition failed during normal operation.
Fan lock	Amber	On	Green	On	Fan locked. The lamp will turn off.
Over Temperature	Green	On	Green / Amber	Flashing	Temperature is too high. The lamp will turn off and the fan will spend a while to cool the system.
Over temperature (Filter)	-	-	-	-	Temperature is too high. Please clean up the filter. OSD shows "Please clean up filter".
	Green	On	Green / Amber	Flashing	Temperature is too high. Please clean up the filter. System will power down and spend a while to cool the system. OSD shows "Warning! PJ temperature is too high."
Cooling	Green	On	Green	Flashing	Cooling the system.
Lamp Replacement	Green	On	Green / Red	Flashing	The lamp draws to an end. Please replace the lamp with a new one promptly.

Optional Parts

The parts listed below are optionally available. When ordering those parts, give the item name and Model No. to the sales dealer.

- COMPONENT-VGA Cable : POA-CA-COMPVGA
- RS232C cable : POA-MCSRL02

Compatibility Modes

Computer (COMPUTER IN / DVI-D IN terminal):

Mode	Resolution	fH (kHz)	fV (Hz)
VGA mode 3	640 x 480	31.469	59.940
VGA VESA 72 Hz		37.861	72.809
VGA VESA 75 Hz		37.500	75.000
VGA VESA 85 Hz		43.269	85.008
SVGA VESA 56 Hz	800 x 600	35.156	56.250
SVGA VESA 60 Hz		37.879	60.317
SVGA VESA 72 Hz		48.077	72.188
SVGA VESA 75 Hz		46.875	75.000
SVGA VESA 85 Hz		53.674	85.061
XGA VESA 60 Hz	1024 x 768	48.363	60.004
XGA VESA 70 Hz		56.476	70.069
XGA VESA 75 Hz		60.023	75.029
XGA VESA 85 Hz		68.677	84.997
SXGA VESA 70 Hz	1152 x 864	63.995	70.016
SXGA VESA 75 Hz		67.500	75.000
SXGA VESA 85 Hz		77.487	85.057
SXGA VESA 60 Hz	1280 x 960	60.000	60.000
SXGA VESA 75 Hz		75.000	75.000
SXGA VESA 60 Hz	1280 x 1024	63.981	60.020
WXGA VESA 60Hz	1280 x 768	47.776	59.870
WXGA VESA 75Hz		60.289	74.893
WXGA VESA 85Hz		68.633	84.837
WXGA VESA 60Hz	1280 x 800	49.306	59.910
WXGA VESA 60Hz		49.702	59.810
WXGA VESA 75Hz		62.795	74.934
WXGA VESA 85Hz		71.554	84.880

Video (COMPONENT terminal)

Signals	Horizontal Frequency (kHz)	Vertical Frequency (Hz)
480i	15.8	60
480p	31.5	60
576i	15.6	50
576p	31.3	50
720p	45.0	60
1080i	33.8	60
1080i	28.1	50



Troubleshooting

Refer to the symptoms and measures listed below before sending the projector for repairs. If the problem persists, contact your local reseller or service center. Please refer to “LED Indicator Messages” (p.36) as well.

Symptom	Cause	Solution
No power.	The AC power cord is not plugged in.	Plug in the AC power cord.
	The AC power cord is not connected to the projector.	Connect the AC power cord to the projector correctly.
	The lamp cover is loose.	Tighten the screw on the lamp cover.
Power goes out during use.	The temperature is too high.	Unplug the AC power cord and wait for a short while, then turn the power back on.
	The ventilation holes are blocked.	Place the projector so that the ventilation holes are not blocked.
No image appears on screen.	The projector is not turned on.	Turn the projector on.
	The connections setup is not correctly.	Check that all connections are setup correctly.
	The connected devices are not functioning properly.	Check that all connected devices are functioning properly.
	Lens cap is not removed.	Remove the lens cap and turn the projector on.
	“NO SHOW” function is activated.	Cancel “NO SHOW” function. (p. 14)
Partial, scrolling or incorrectly displayed image.	The input signal is not supported by the projector.	Press remote control's “AUTO PC” button. (p. 12, 14, 27)
Image is unstable or flickering.	The signal timing of the display does not synchronize with the graphic card.	Use “Fine Sync” to correct it. Refer to Picture section. (p. 12, 14, 24) Change the monitor color setting from your computer.
Image has vertical flickering bar.	The display data frequency does not match the frequency of your computer's graphic card.	Use “Total Dots” to make an adjustment. Refer to Picture section. (p. 12, 14, 24)
		Check and reconfigure the display mode of your graphic card to make it compatible with the product.
Image is out of focus.	The lens focus is not adjusted optimally.	Adjust the focus with the focus ring. (p. 20)
	The projection distance is not within the projector's supported range.	Place the projector within the supported range.

Symptom	Cause	Solution
Remote control doesn't work.	The batteries could be weak.	Replace with a new set of batteries. (p. 15)
	The polarity is not correct.	Install the batteries with correct polarities. (p. 15)
	The remote control is not being used within the effective range.	Use the remote control within the effective range. (p. 16)
	There are some obstructions between the remote control and projector.	Check that there are not obstructions between the remote control and projector.
	There are some fluorescent or other bright lights shining at the projector's infrared remote sensor.	Check that there are not any fluorescent or other bright lights shining at the projector's infrared remote sensor.



Serial Control Interface

This projector provides a function to control the projector's operations by using the RS-232C serial port.

■ Connection and Operation

- 1 Connect a RS-232C serial cross cable to RS-232C PORT on the projector and serial port on the PC.
- 2 Launch a communication software provided with PC and setup the communication condition as follows:
- 3 Send the command strings by the HEX key (HEX is in the range of 0-9 and a-f) for controlling the projector.

Baud rate	: 19200 bps
Parity check	: none
Stop bit	: 1
Flow control	: none
Data bit	: 8

■ Command Format

The command is sent from PC to the projector with the format as below table. The projector decodes the command and returns the confirmation 'ACK' = '06'.

The below table shows the typical command lists for controlling the projector. Please consult your local dealer for further information of another commands.

Command	Command Strings (HEX)												
Power ON	BE	EF	10	05	00	C6	FF	11	11	01	00	01	00
Power OFF	BE	EF	02	06	00	57	D0	2E	00	00	00	00	00
Menu	BE	EF	02	06	00	C8	D7	01	00	00	00	00	00
▲ UP	BE	EF	02	06	00	FB	D7	02	00	00	00	00	00
▼ DOWN	BE	EF	02	06	00	2A	D6	03	00	00	00	00	00
◀ Left	BE	EF	02	06	00	9D	D7	04	00	00	00	00	00
▶ Right	BE	EF	02	06	00	4C	D6	05	00	00	00	00	00
Input	BE	EF	02	06	00	7F	D6	06	00	00	00	00	00
Auto PC Adj.	BE	EF	02	06	00	58	D5	11	00	00	00	00	00
Mute	BE	EF	02	06	00	51	D7	08	00	00	00	00	00
Keystone UP	BE	EF	02	06	00	E0	D1	29	00	00	00	00	00
Keystone DOWN	BE	EF	02	06	00	D3	D1	2A	00	00	00	00	00
Volume UP	BE	EF	02	06	00	62	D7	0B	00	00	00	00	00
Volume DOWN	BE	EF	02	06	00	D5	D6	0C	00	00	00	00	00
NO Show	BE	EF	02	06	00	CE	D0	27	00	00	00	00	00
Freeze	BE	EF	02	06	00	02	D0	2B	00	00	00	00	00
Aspect	BE	EF	02	06	00	31	D0	28	00	00	00	00	00
Select Computer (Analog)	BE	EF	02	06	00	0B	D2	32	00	00	00	00	00
Select Component	BE	EF	02	06	00	DA	D3	33	00	00	00	00	00
Select S-Video	BE	EF	02	06	00	6D	D2	34	00	00	00	00	00
Select Video	BE	EF	02	06	00	BC	D3	35	00	00	00	00	00
Select Computer (Digital)	BE	EF	02	06	00	8F	D3	36	00	00	00	00	00

Printed in China
Part No. 1AA6P1P5446--
(KJ3A)

SANYO

SANYO Electric Co., Ltd.