



MITSUBISHI ELECTRIC

MULTIMEDIA DATA/VIDEO PROJECTORS



Input and Output Terminals

- ① REMOTE IN and OUT terminals
- ② LAN terminal
- ③ SERIAL terminal (D-SUB 9-pin)
- ④ USB (COMPUTER) terminal
- ⑤ COMPUTER/COMPONENT VIDEO DVI-D (HDCP) terminal (DVI-D 24-pin)
- ⑥ COMPUTER / COMPONENT VIDEO IN 1 terminals (R/Ps, G/Y, B/Ps, H/HV, V) (BNC)
- ⑦ Main power switch O : OFF I : ON
- ⑧ Power jack
- ⑨ AUDIO IN 1 terminal (Mini jack)
— The AUDIO IN 1 terminal is used for both COMPUTER 1 and DVI input.
- ⑩ AUDIO IN 2 terminal (Mini jack)
- ⑪ COMPUTER/COMPONENT VIDEO IN 2 terminal (Mini D-SUB 15-pin)
- ⑫ MONITOR OUT terminal (Mini D-SUB 15-pin)
- ⑬ AUDIO OUT terminal (Mini jack)
- ⑭ VIDEO IN and audio input terminals
- ⑮ S-VIDEO IN and audio input terminals

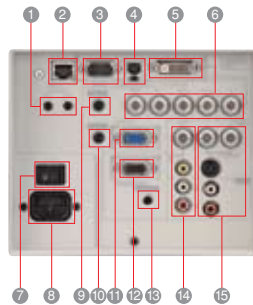

Specifications

Model	FL7000U
Display technology	11" 3-LCD (with micro lens)
Resolution	1920 x 1080 (Total 2,073,600 pixels)
Brightness	5000 ANSI lumens
Contrast ratio	1000:1 (on/off)
Projection lens	f=51-64mm, F1.8-2.1
Throw Ratio	2.1 ~ 2.75
Zoom / focus	Motorized Zoom & Focus
Picture size	60" - 250"
Source lamp	220W (Shut Off Time 4000Hrs) with Low mode, 275W (Shut Off Time 2000Hrs) with Standard mode
Computer compatibility	Resolution ; 640 x 400 (Expand) - 1920 x 1080 (Real) - 1600 x 1200 (Compress) Sync on Green available
Video compatibility	NTSC / NTSC 4.43 / PAL (including PAL-M, N) / SECAM / PAL-60, Component Video ; 480i/p (525i/p), 576i/p (625i/p), 720p (750p 50/60Hz), 1080i (1125i 50/60Hz), 1080p (1125p 50/60Hz), (1080i (1250i 50Hz) is not available) SCART (RGB + 1V sync, only Mini D-Sub 15pin Terminal)
Input terminals	PC ; 5 BNC x 1, Mini D-Sub 15pin x 1, DVI-D(with HDCP) x 1, PC Audio ; Stereo mini jack (φ3.5mm) x 2 Video ; RCA x 1 or BNC x 1, S-VIDEO (4pin) x 1 or S-VIDEO Y/C (BNC), Video Audio ; RCA (L/R) x 2
Output terminals	RGB ; Min D-Sub 15 pin x 1, Audio ; Stereo mini jack (φ3.5mm) x 1 (Variable Out)
Communication terminals	LAN (RJ-45) ; x 1 (Projector control), RS-232C ; D-Sub 9pin x 1 (Direct command is available), USB ; x 1 (for Mouse Cursor Control) Wired remote (IN) ; x 1 (φ3.5mm Stereo mini jack), Wired remote (OUT) : x 1 (φ3.5mm Stereo mini jack)
Scanning Rate	H: 15-100kHz V: 50-120Hz, Dot clock: 162MHz (Max)
Audio speaker	10 W Mono
Dimensions (W x H x D)	443 x 207 x 434 mm / 17.4 x 8.1 x 17.1 inch (Including detachable Terminal Cover)
Weight	9.8kg / 21.6lbs (Exclude detachable Terminal Cover)
Power supply	AC100 - 240V, 50/60 Hz

* SXGA, XGA and SVGA are registered trademarks of IBM Corporation.
* All brand names and product names are trademarks, registered trademarks or trade names of their respective holders.

Projector View (Diagnostic System)

To monitor projectors and facilitate maintenance, incorporated diagnostic system provides control over key projector functions such as power on/off as well as warnings for operating temperature and filter clogging. Controlled via a master PC, this system is ideal for a Local Area Network (LAN) for both academic and business environments.



Dimensions (unit: mm, inch)

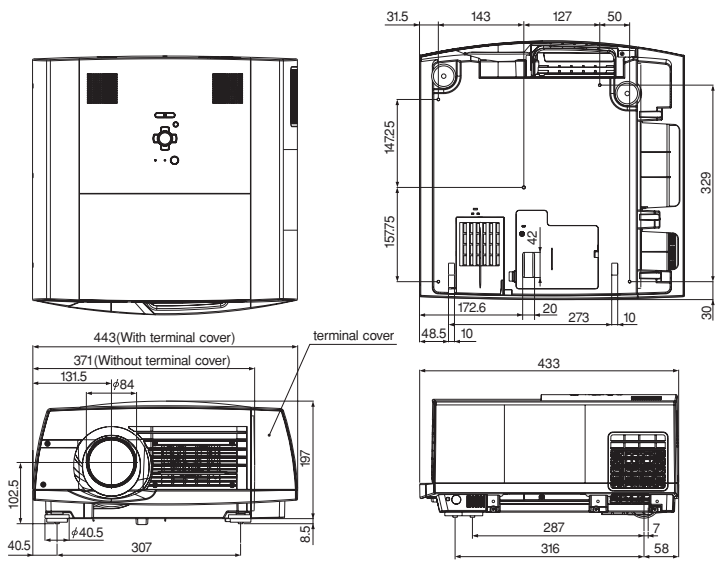

Screen size and projection distance

Refer to the following table to determine the screen size and projection distance.

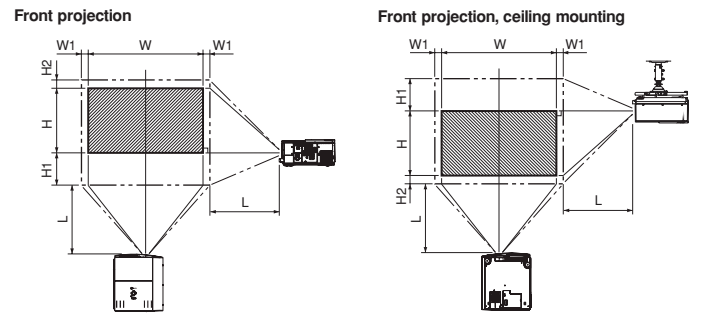

Diagonal size (inch) (cm)	Screen Size				Projection distance (L)				Lens movable range						
	Height (H) (inch) (cm)	Width (W) (inch) (cm)	Shortest (Wide) (m) (inch)	Longest (Tele) (m) (inch)	H1 (cm) (inch)	H2 (cm) (inch)	W1 (cm) (inch)	W2 (cm) (inch)	W3 (cm) (inch)						
60	152	29	75	52	133	104	2.6	133	3.4	15	38	4	10	3	7
80	203	39	100	70	177	140	3.5	178	4.5	20	51	5	13	4	9
100	254	49	125	87	221	175	4.5	223	5.7	25	63	7	17	4	11
150	381	74	187	131	332	264	6.7	336	8.5	37	94	10	25	7	17
200	508	98	249	174	443	354	9.0	449	11.4	49	125	13	34	9	22
250	635	123	311	218	553	443	11.2	-	-	62	156	17	42	11	28

* The above figures are approximate and may be slightly different from the actual measurements.

MITSUBISHI DIGITAL ELECTRONICS AMERICA, INC.
 Presentation Products Division
 Phone: 888.307.0349
 Email: ppdinfo@mdea.com
 www.mitsubishi-presentations.com

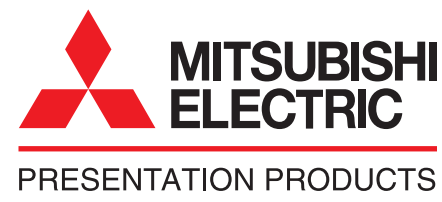

MITSUBISHI ELECTRIC SALES CANADA INC.
 Information Technologies Group
 Phone: 905.475.7728
 www.mitsubishielectric.ca

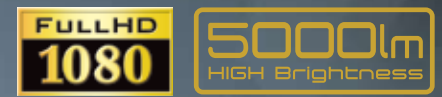

New FL7000U

Present in impressive full1080p high-definition, complete with split (side-by-side) screen display.

Vividly reproduce your presentation and video images in brilliant 5000lm for videoconferences, seminars, lectures and meetings.

With the FL7000U your power of expression is a cut above the rest and is a key to persuasive presentations every time.



For Science

For Entertainment

For Education

For Business

Choose the projector that's ideal for you.

Visual communications that's a step ahead

New **FL7000U** **FULLHD 1080** **5000lm HIGH BRIGHTNESS**



Full 1080p dramatically expands your image

Large capacity visual images are impossible to reproduce in full with conventional XGA projectors. The FL7000U is compatible with HDTV broadcasts and high-definition DVDs to project impressive and full 1080p images in all their original digital glory.

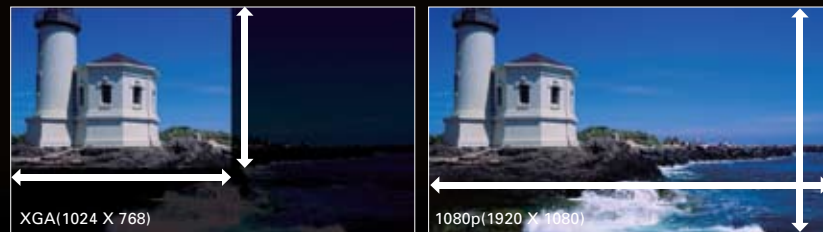

Split (side-by-side) window function brings expression to the next level

The split-screen function of conventional XGA projectors overlap, with the sub-screen in front of the main screen. Our full high-definition panels present perfectly parallel split windows, placing two screens side-by-side. When displays are simultaneous and identical in scale, comparative viewing is clear and effective.

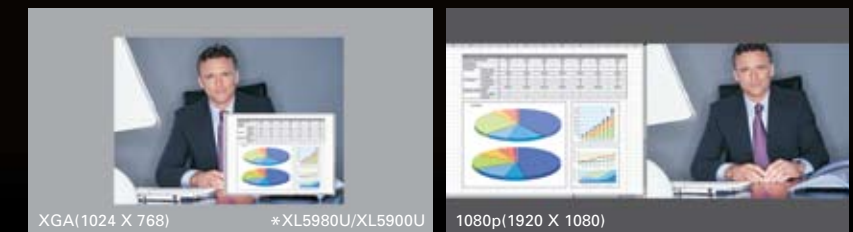

Super bright 5000lm

The FL7000U delivers super bright 5000 lumen images. A high brightness level for presenting in large meeting rooms and conference halls.

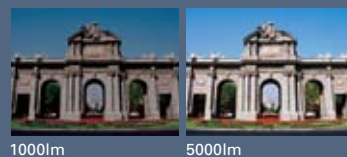

Ultra Quiet 29dBA Operation

Fan noise emanating from a projector can get annoying during a presentation or videoconference, but now that's a thing of the past. The FL7000U offers a significantly low noise level of only 29dBA (low lamp mode). As a result, your audience can enjoy the presentation or conference without noisy distractions from the projector.

Long 4000hrs Lamp Life

Designed with a lamp temperature controlling system, the FL7000U can support a lamp life of up to 4000 hours*1. The long life lamp makes dramatic reductions in overall cost of ownership by decreasing the frequency of lamp replacements.

Lamp Replacement Frequency*2



(*1): When used in Lamp Low mode. Maximum lamp life at standard mode use is 2,000 hours. (*2): Lamp life refers to the average time required for brightness to be reduced by half, and not the time specified in the warranty. Use time may vary widely by the environment and conditions, and whether or not cleaning and other maintenance procedures are followed.

Enhanced Connectivity with RJ45

A RJ45 connector provides an audio-visual manager with the ease of LAN control. Using the included software, you can manage the projectors on your network. An automatic alert can be sent via email to notify you if a projector needs attention.

sRGB

Developed to ensure standard, uniform color reproduction regardless of the type of display used, sRGB color profile technology uses independent color coordinates common to all display technologies. As a result, it helps to eliminate hue variations that occur between different display systems and more accurately matches the way colors look in real life.

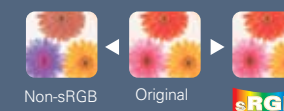

To find out the details of sRGB, visit us at: <http://global.mitsubishielectric.com/bu/projectors/technology/>

Versatile Input Terminals

Offering more operating convenience for system installations, the FL7000U is equipped with BNC terminals that allows for a variety of audio-visual and PC equipment to be connected easily.

Anti-Theft Features (password security, motion alarm, screen capture)

Through software, password menus helps lock out access to operation and a customized splash or logo screen can appear when powering on the projector to thwart would-be burglars. From a hardware standpoint, a motion alarm is built into the cable cover; if an outsider attempts to forcibly remove the projector from its mount, a loud alarm will help drive off the potential thief.