

# Projector

# HDPJ52

## User's Manual – Operating Guide

Thank you for purchasing this projector.

**⚠ WARNING** ► Before using this product, please read the "User's Manual - Safety Guide" and related manuals to ensure the proper use of this product. After reading them, store them in a safe place for future reference.

**NOTE** • The information in this manual is subject to change without notice.  
• The manufacturer assumes no responsibility for any errors that may appear in this manual.  
• The reproduction, transfer or copy of all or any part of this document is not permitted without express written consent.

### Trademark acknowledgment

- VGA and XGA are registered trademarks of International Business Machines Corporation.
  - Mac is registered trademarks of Apple Computer, Inc.
  - VESA and SVGA are trademarks of Video Electronics Standard Association.
  - Windows is a registered trademark of Microsoft Corporation.
  - HDMI, the HDMI logo and High-Definition Multimedia Interface are trademarks or registered trademarks of HDMI Licensing LLC.
- All other trademarks are the properties of their respective owners.

**ProSelecta**

View :: Compare :: Select - [www.ProSelecta.com](http://www.ProSelecta.com)

Content



|  |           |
|--|-----------|
| <b>Before use</b> .....                        | <b>4</b>  |
| Projector features.....                        | 4         |
| About this manual.....                         | 4         |
| About contents of package.....                 | 5         |
| Part names.....                                | 6         |
| Projector.....                                 | 6         |
| Controls buttons.....                          | 7         |
| Ports.....                                     | 7         |
| Remote control.....                            | 8         |
| <b>Preparations</b> .....                      | <b>9</b>  |
| Fastening the lens cover.....                  | 9         |
| Arrangement.....                               | 10        |
| Adjusting the projector's elevation.....       | 12        |
| Connecting your devices.....                   | 13        |
| With a VCR/DVD player.....                     | 13        |
| For HDMI signal source.....                    | 14        |
| For DVI signal source.....                     | 14        |
| For a SCART RGB input.....                     | 14        |
| With a computer.....                           | 15        |
| Example of computer signal.....                | 16        |
| Connecting a power supply.....                 | 17        |
| Using the cable cover.....                     | 17        |
| Loading batteries into the remote control..... | 18        |
| Using the remote control.....                  | 19        |
| Using the remote control button lights.....    | 19        |
| <b>Projection</b> .....                        | <b>20</b> |
| Turning the power on.....                      | 20        |
| Selecting an input signal.....                 | 21        |
| Automatically adjusting the picture.....       | 21        |
| Adjusting the display position.....            | 22        |
| Adjusting the zoom.....                        | 22        |
| Adjusting the focus.....                       | 22        |
| Turning the power off.....                     | 23        |
| <b>Basic operation</b> .....                   | <b>24</b> |
| ASPECT.....                                    | 24        |
| IRIS.....                                      | 25        |
| MODE.....                                      | 26        |
| BLACK.....                                     | 27        |
| BRIGHTNESS, CONTRAST, COLOR.....               | 27        |
| MY MEMORY.....                                 | 28        |
| <b>EASY MENU</b> .....                         | <b>30</b> |
| EASY MENU operation.....                       | 30        |



|  |           |
|--|-----------|
| <b>(EASY MENU)</b> .....                                       | <b>30</b> |
| EASY MENU functions .....                                      | 31        |
| ASPECT .....   | 31        |
| MODE, BLACK .....  | 32        |
| BRIGHTNESS, CONTRAST, COLOR, TINT, SHARPNESS, MIRROR .....     | 33        |
| RESET, LANGUAGE, Go To Advance Menu .....                      | 34        |
| <b>Advanced Menu</b> .....                                     | <b>35</b> |
| Advanced Menu operation .....                                  | 35        |
| PICTURE menu .....   | 37        |
| BRIGHTNESS, CONTRAST, GAMMA .....                              | 37        |
| COLOR TEMP .....   | 39        |
| COLOR, TINT, SHARPNESS .....                                   | 40        |
| IRIS, BLACK, MY MEMORY .....                                   | 41        |
| IMAGE menu .....   | 43        |
| ASPECT, OVER SCAN .....  | 43        |
| V POSITION, H POSITION, H PHASE, H SIZE, AUTO ADJUST .....     | 44        |
| INPUT menu .....   | 45        |
| PROGRESSIVE, COLOR SPACE .....                                 | 45        |
| COMPONENT, VIDEO FORMAT, HDMI, FRAME LOCK .....                | 46        |
| S-ASPECT, INFORMATION .....                                    | 47        |
| SETUP menu .....   | 48        |
| KEYSTONE, WHISPER, MIRROR .....                                | 48        |
| SCREEN menu .....  | 49        |
| LANGUAGE, MENU POSITION, OSD BRIGHT .....                      | 49        |
| START UP, MyScreen .....                                       | 50        |
| MyScreen Lock, MESSAGE .....                                   | 51        |
| DIGITAL SHUTTER .....  | 52        |
| OPTION menu .....  | 53        |
| AUTO OFF, LAMP TIME, FILTER TIME .....                         | 53        |
| SERVICE (FAN SPEED, GHOST, STRIPE) .....                       | 54        |
| SERVICE (FILTER MESSAGE, FACTORY RESET) .....                  | 55        |
| <b>Maintenance</b> .....                                       | <b>56</b> |
| Lamp .....   | 56        |
| Air filter .....   | 58        |
| Inside of the projector .....                                  | 60        |
| Lens .....   | 60        |
| Cabinet and remote control .....                               | 60        |
| <b>Troubleshooting</b> .....                                   | <b>61</b> |
| Related message .....  | 61        |
| Regarding the indicator lamps .....                            | 62        |
| Phenomena that may be easily mistaken as machine defects ..... | 64        |
| <b>Warranty and after-service</b> .....                        | <b>67</b> |
| <b>Specifications</b> .....                                    | <b>67</b> |
| Dimension diagram .....  | 68        |
| <b>Glossary</b> .....  | <b>69</b> |

## Before use

### Projector features

This projector is used to project computer and NTSC/PAL/SECAM video signals onto a screen. It requires only a small amount of space for installation and projects a large image from even a short distance.

The following features will turn any room into a High Definition Theater.

- Super Focus ED (Extra-low dispersion) lenses are used for the highest possible image quality.
- 720P wide LCD panels are used for faithful reproduction of high definition images.
- Motorized iris control provides film-like images with a darker black.
- The 1.6x zoom lens and optical lens shift feature allow for flexibility of installation and viewing position.

### About this manual

Various symbols are used throughout this manual. The meanings of these symbols are described below.

 **WARNING** This symbol indicates information that, if ignored, could possibly result in personal injury or even death due to incorrect handling.

 **CAUTION** This symbol indicates information that, if ignored, could possibly result in personal injury or physical damage due to incorrect handling.

**NOTE** To ensure proper use, please take special notice of information provided following this symbol.

 See the pages noted after this symbol for more information about the current topic.

## About contents of package

Your projector should come with the items shown below. Check to make sure that all the items are included. Contact your dealer immediately if anything is missing.

(1) Projector.....

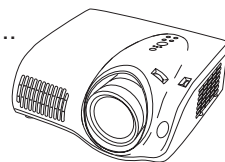

(2) Lens cover, rivet and strap.....



(3) Power cord.....

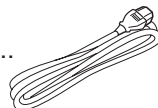

(4) Component video cable.....

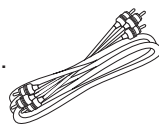

(5) Remote control and 2 AAA batteries.....

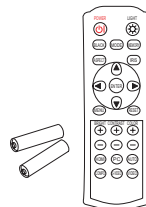

(6) User's manuals.....



(7) Cable cover.....

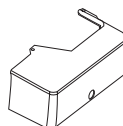

ENGLISH

**⚠ WARNING** ► Do not place the projector on an unstable surface.

**NOTE** • Keep the original packing materials for future reshipment.

Be sure to use the original packing material when moving the projector. Use special caution for the lens.  
Use the original cushion for the lens.

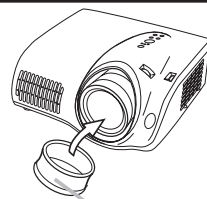

Cushion for the lens

## Part names

### Projector

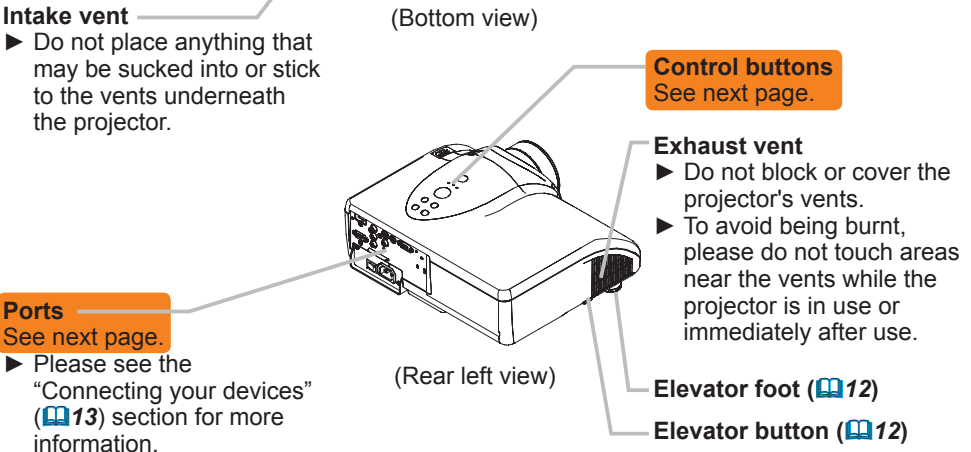
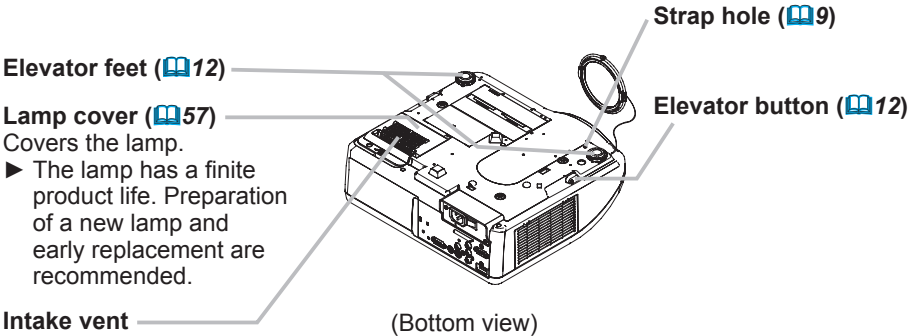
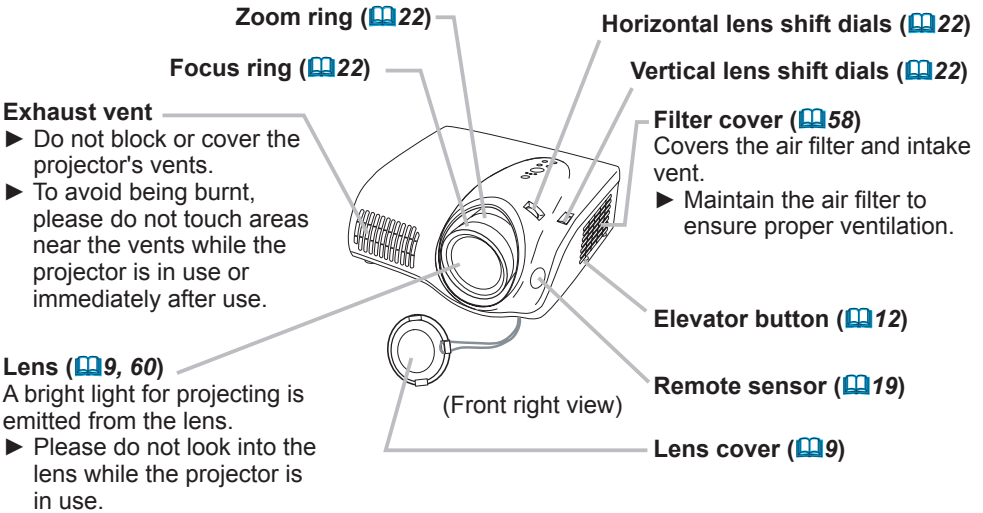

## Control buttons

### POWER indicator (📖20, 23, 62)

This indicator blinks while the projector is cooling down or warming up

- ▶ Note that a lit or blinking red indicator denotes a problem.

### TEMP indicator (📖62)

- ▶ Note that a lit or blinking red indicator indicates a problem.

### MENU button (📖30, 35)

Used to begin or end a menu operation.

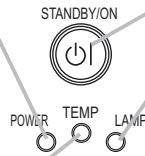

### STANDBY/ON button (📖20, 23)

Used to turn the power on and off.

### LAMP indicator (📖62)

- ▶ Note that a lit or blinking red indicator indicates a problem.

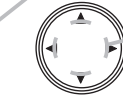

### Cursor buttons ▲, ▼, ◀, ▶

Used to make adjustments and operate menus.

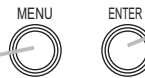

### ENTER button (📖30, 35)

Used to proceed to the next stage in a menu operation.

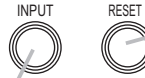

### RESET button (📖31, 36)

Used to cancel an adjustment.

### INPUT button (📖21)

Used to select an input signal. Pressing this button toggles between input ports.

## Ports

### HDMI port (📖14)

### COMPONENT VIDEO ports (📖13, 14)

This is a set of input ports composed of Y, C<sub>B</sub>/P<sub>B</sub> and C<sub>R</sub>/P<sub>R</sub> ports.

### CONTROL port (📖15)

### S-VIDEO port (📖13)

### TRIGGER port

### Restart switch (📖23, 64)

### COMPUTER port (📖15)

### Kensington lock slot

### VIDEO port (📖13, 14)

### AC inlet (📖17)

### Power switch (📖20, 23)

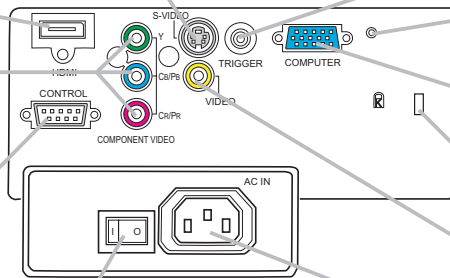

**NOTE** • Use only an HDMI cable marked with the HDMI logo for HDMI connections.

• The TRIGGER port (12V/25mA) is used to connect to a screen that can be controlled via a trigger signal from display equipment.

## Remote control

### POWER button (120, 23)

Used to turn the power on and off.

### MODE button (126)

Used to select a mode. Each mode is a combination of settings for gamma, color temperature and iris.

### LIGHT button (119)

Used to make the buttons on the remote control light up for a short time.

### MEMORY button (128)

Used to save and load user adjustment settings.

### IRIS button (125)

Used to adjust the iris.

### ENTER button (130, 35)

Used to proceed to the next stage in a menu operation.

### RESET button (131, 36)

Used to cancel an adjustment.

### AUTO button (121)

Used to enable the automatic adjustment function.

### Battery cover (118)

The battery cover is on the back of the remote control.

### BLACK button (127)

Used to select a BLACK mode. Each mode adjusts the black setting to suit different conditions.

### ASPECT button (124)

Used to select an aspect ratio.

### Cursor buttons ▲, ▼, ◀, ▶

Used to make adjustments and operate menus.

### MENU button (130, 35)

Used to begin or end a menu operation.

### CONTRAST, BRIGHT, COLOR buttons (127)

Used to adjust the contrast, brightness and color tone.

### PC, HDMI, COMPO, S-VIDEO, VIDEO buttons (121)

Used to select an input port.  
 PC button ⇒ COMPUTER port  
 HDMI button ⇒ HDMI port  
 COMPO button ⇒ COMPONENT VIDEO ports  
 S-VIDEO button ⇒ S-VIDEO port  
 VIDEO button ⇒ VIDEO port

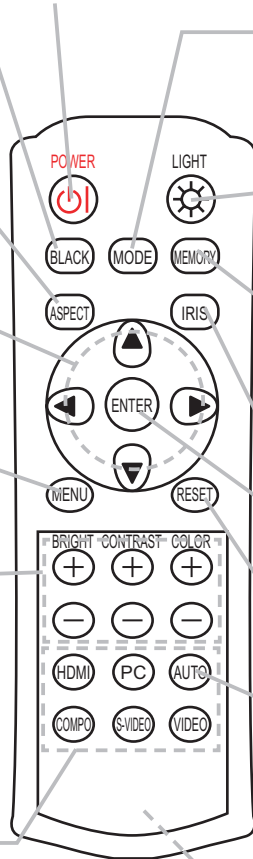



## Preparations

**Fastening the lens cover**

Fasten the lens cover to the projector using the included strap to prevent it from becoming lost.

1. Fix the strap to the lens cover strap ring.

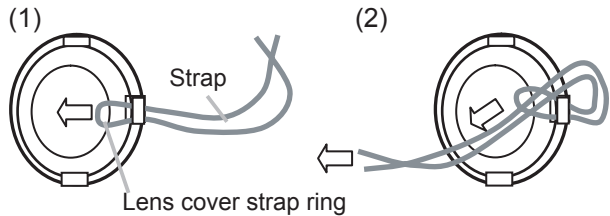

2. Put the strap into the groove on the rivet.

3. Press the rivet into the strap hole.

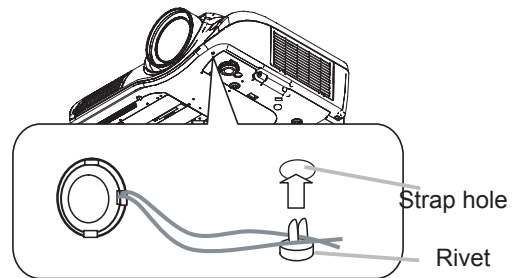

4. Put the lens cover on the lens of the projector.

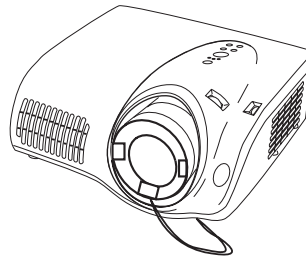

**⚠ WARNING** ► Do not fasten the lens cover during or immediately after use. Handling while the projector is hot could cause burn and/or projector malfunction.

**⚠ CAUTION** ► When the projector is not in use, be sure to close the lens cover to prevent the lens surface being scratched.

## Arrangement

Arrange the projector according to the manner in which you will use the projector and the environment the projector will be used in.

### On a horizontal surface

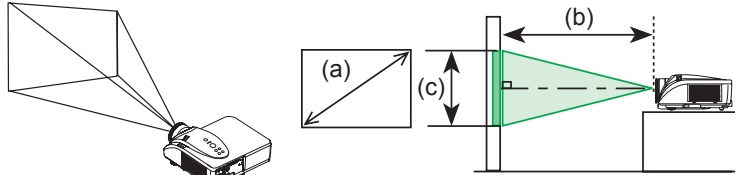

### Suspended from the ceiling

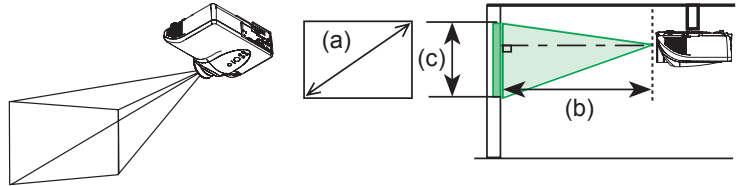

- ⚠ WARNING** ► Place the projector in a stable, horizontal position. If the projector falls or is knocked over it could result in injury and/or damage to the projector. Using a damaged projector could result in fire and/or electric shock.
- Do not place the projector on an unstable, slant or vibratory surface such as a wobbly or inclined stand.
  - Do not stand the projector on its side, front or rear faces.
  - Contact your dealer before ceiling installations and similar.
  - Place the projector in a cool place, with adequate ventilation. The high operating temperature of the projector could cause burns, fire and/or projector malfunction if not properly placed.
  - Do not block or cover the projector's vents.
  - Maintain a space of at least 30 cm between the sides of the projector and other objects such as walls.
  - Do not place the projector on metallic objects or objects susceptible to heat.
  - Do not place the projector on carpets, cushions or bedding.
  - Do not place the projector in direct sunlight or near heat sources, such as heaters.
  - Do not place anything on or near the projectors lens or vents. Do not place anything on top of the projector.
  - The projector also has intake vents on the bottom. Do not place anything that may be sucked into or stick to the vents underneath the projector.
  - Do not place the projector any place where it may get wet. Placing the projector in a humid place or inserting liquid in the projector could cause fire, an electric shock and/or malfunction to the projector.
  - Do not place the projector in a bathroom or outdoors.
  - Do not place anything containing liquid near the projector.

Refer to the illustrations and tables below to determine the screen size and projection distance.

The values shown in the table are calculated ( $\pm 10\%$ ) for a full size screen at 1280x720.

**For 16:9 screens**

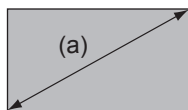

| (a) Screen size |       | (b) Projection distance |        |      |        | (c) Screen height |        |
|-----------------|-------|-------------------------|--------|------|--------|-------------------|--------|
| inch            | (m)   | min.                    |        | max. |        | cm                | (inch) |
|                 |       | m                       | (inch) | m    | (inch) |                   |        |
| 30              | (0.8) | 0.8                     | (32)   | 1.3  | (52)   | 37                | (15)   |
| 40              | (1.0) | 1.1                     | (43)   | 1.8  | (70)   | 50                | (20)   |
| 50              | (1.3) | 1.4                     | (54)   | 2.3  | (89)   | 62                | (25)   |
| 60              | (1.5) | 1.7                     | (66)   | 2.7  | (107)  | 75                | (29)   |
| 70              | (1.8) | 2.0                     | (77)   | 3.2  | (125)  | 87                | (34)   |
| 80              | (2.0) | 2.2                     | (89)   | 3.6  | (143)  | 100               | (39)   |
| 90              | (2.3) | 2.5                     | (100)  | 4.1  | (161)  | 112               | (44)   |
| 100             | (2.5) | 2.8                     | (111)  | 4.6  | (179)  | 125               | (49)   |
| 120             | (3.0) | 3.4                     | (134)  | 5.5  | (215)  | 149               | (59)   |
| 150             | (3.8) | 4.3                     | (168)  | 6.9  | (270)  | 187               | (74)   |
| 200             | (5.1) | 5.7                     | (224)  | 9.2  | (360)  | 249               | (98)   |
| 250             | (6.4) | 7.1                     | (281)  | 11.5 | (451)  | 311               | (122)  |
| 300             | (7.6) | 8.6                     | (337)  | 13.8 | (541)  | 374               | (147)  |

**For 4:3 screens**

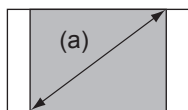

| (a) Screen size |       | (b) Projection distance |        |      |        | (c) Screen height |        |
|-----------------|-------|-------------------------|--------|------|--------|-------------------|--------|
| inch            | (m)   | min.                    |        | max. |        | cm                | (inch) |
|                 |       | m                       | (inch) | m    | (inch) |                   |        |
| 30              | (0.8) | 1.0                     | (39)   | 1.6  | (65)   | 46                | (18)   |
| 40              | (1.0) | 1.4                     | (53)   | 2.2  | (87)   | 61                | (24)   |
| 50              | (1.3) | 1.7                     | (67)   | 2.8  | (109)  | 76                | (30)   |
| 60              | (1.5) | 2.1                     | (81)   | 3.3  | (131)  | 91                | (36)   |
| 70              | (1.8) | 2.4                     | (95)   | 3.9  | (153)  | 107               | (42)   |
| 80              | (2.0) | 2.8                     | (109)  | 4.5  | (175)  | 122               | (48)   |
| 90              | (2.3) | 3.1                     | (122)  | 5.0  | (198)  | 137               | (54)   |
| 100             | (2.5) | 3.5                     | (136)  | 5.6  | (220)  | 152               | (60)   |
| 120             | (3.0) | 4.2                     | (164)  | 6.7  | (264)  | 183               | (72)   |
| 150             | (3.8) | 5.2                     | (206)  | 8.4  | (330)  | 229               | (90)   |
| 200             | (5.1) | 7.0                     | (275)  | 11.2 | (441)  | 305               | (120)  |
| 250             | (6.4) | 8.7                     | (344)  | 14.0 | (552)  | 381               | (150)  |
| 300             | (7.6) | 10.5                    | (413)  | 16.8 | (663)  | 457               | (180)  |

**⚠ CAUTION** ► Avoid smoky, humid and dusty places (e.g. near a humidifier, a smoking area, a kitchen etc.) Placing the projector in such a place could cause fire, electric shock and/or projector malfunction.

► Adjust the position of the projector so that light does not shine directly on the projector's remote sensor.

► The manufacturer strongly recommends avoiding any magnetic contact that is not shielded or protected on or near the projector itself. (e.g. Magnetic Security Devices, or other projector accessories that contain magnetic material that has not been provided by the manufacture etc.) Magnetic objects may cause interruption of the projector's internal mechanisms which may interfere with cooling fan speed or cause the fans to stop, and may cause the projector to shut down completely.

## Adjusting the projector's elevation

The elevator feet can be used to make adjustments if the surface on which the projector is set is uneven or if the projection angle needs to be otherwise adjusted. The adjustment range of the elevator feet is 0 to 7 degrees.

1. Press and hold in the elevator buttons while holding the projector. There are elevator buttons and feet on the both sides of the projector.
2. Raise or lower the projector to the desired height and release the elevator buttons. When the elevator buttons are released, the elevator feet will lock into position.
3. If necessary, the elevator feet can be manually twisted to make more precise adjustments.

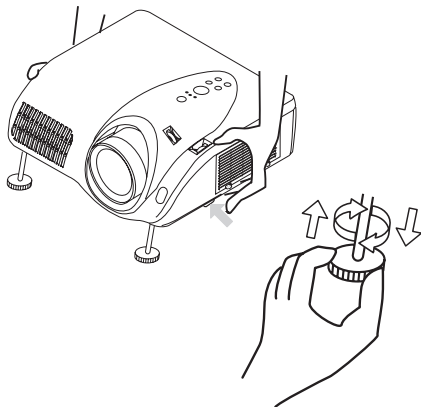
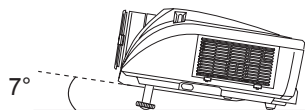

**⚠ WARNING** ► Do not adjust the elevation of the projector during or immediately after use. Handling while the projector is hot could cause burn and/or projector malfunction. Before adjusting the elevation, make sure that the power switch is off, that the power cord is unplugged, and that the projector is adequately cool.

**⚠ CAUTION** ► Using the elevator buttons without holding the projector could cause the projector to fall, overturn, or strike your fingers and possibly cause projector malfunction. To prevent damaging the projector and injuring yourself, always hold the projector whenever using the elevator buttons to adjust the elevator feet.

► Do not tilt the projector to the right or left. Also be sure not to raise the front or rear of the projector more than 7 degrees. Raising the projector more than 7 degrees could cause projector malfunction or shorten the lifetime of consumables.

► Other than raising the projector using the elevator feet, place the projector horizontally.

## Connecting your devices

### With a VCR/DVD player

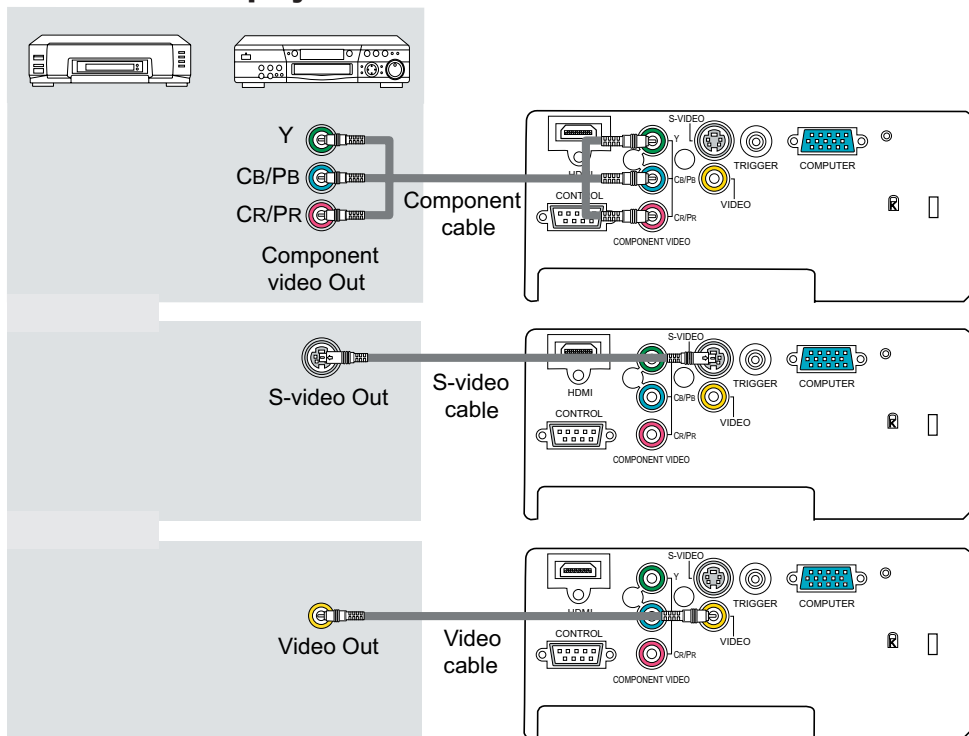

**⚠ CAUTION** ▶ Turn off all devices prior to connecting them to the projector. Attempting to connect a live device to the projector may generate extremely loud noises or other abnormalities that may result in malfunction and/or damage to the device and/or projector.

▶ Use the accessory cables or a designated cable type to make connections. Some cables have to be used with a core. A cable that is too long may cause picture degradation. Please consult with your dealer for more information. For cables that have a core only at one end, connect the end with the core to the projector.

▶ Make sure that devices are connected to the correct port. An incorrect connection may result in malfunction and/or damage to the device and/or projector.

**NOTE** • Be sure to tighten the screws on connectors to secure.  
• Automatic adjustment may not function correctly with some input signals.

**For an HDMI signal source**

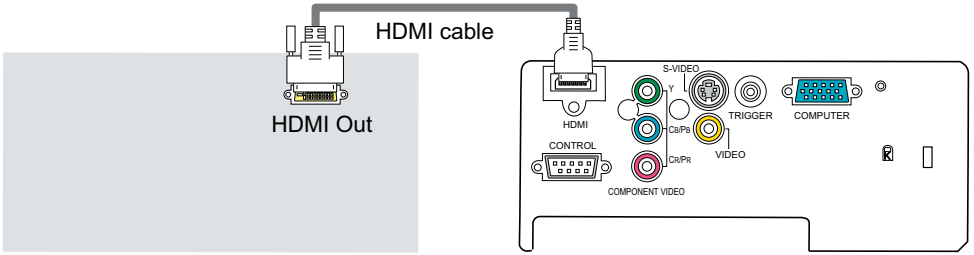

**For a DVI signal source**

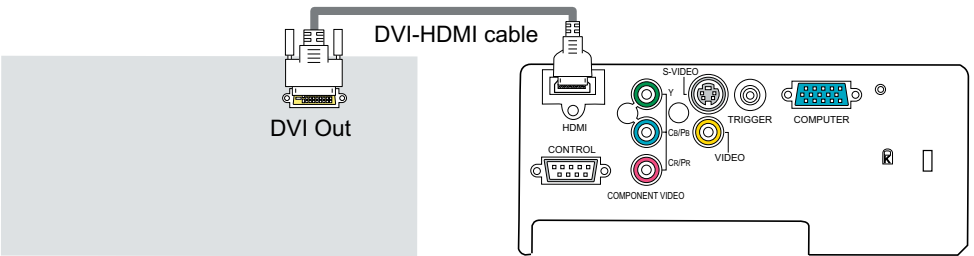

**For an SCART RGB input**

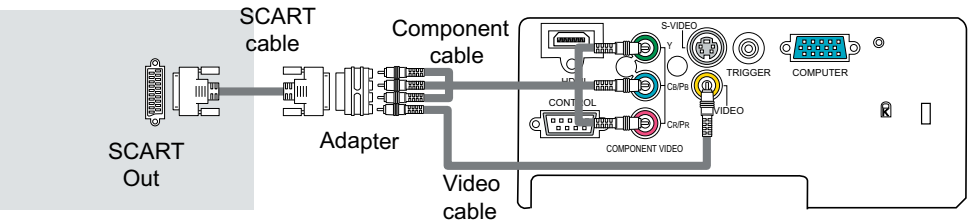

**⚠ CAUTION** ▶ Turn off all devices prior to connecting them to the projector. Attempting to connect a live device to the projector may generate extremely loud noises or other abnormalities that may result in malfunction and/or damage to the device and/or projector.

▶ Use the accessory cables or a designated cable type to make connections. Some cables have to be used with a core. A cable that is too long may cause picture degradation. Please consult with your dealer for more information. For cables that have a core only at one end, connect the end with the core to the projector.

▶ Make sure that devices are connected to the correct port. An incorrect connection may result in malfunction and/or damage to the device and/or projector.

## With a computer

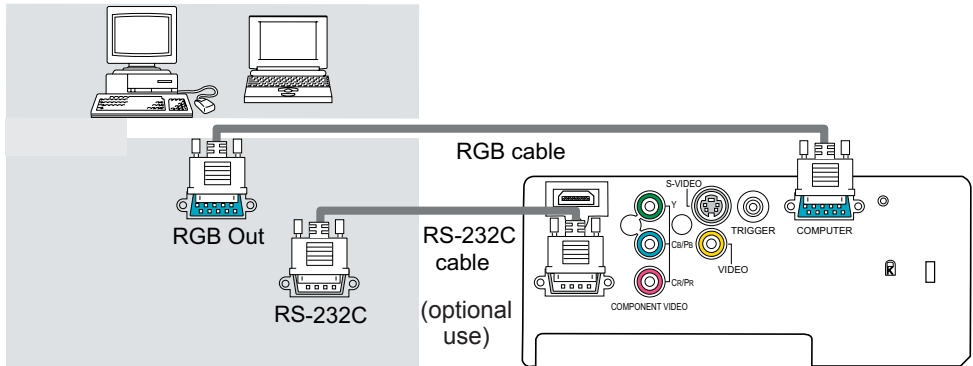

**NOTE** • Be sure to tighten the screws on connectors to secure.

- Use only an HDMI cable marked with the HDMI logo for HDMI connections.
- Use a DVI-HDMI cable or adapter when connecting to a DVI output device. In some cases however, a DVI input to the HDMI port may not work properly.
- Whenever attempting to connect a laptop computer to the projector, be sure to activate the laptop's external RGB output (set the laptop to CRT display or to simultaneous LCD and CRT display). For more information please refer to the instruction manual of the laptop computer.
- Be sure to check jack type, signal level, timing and resolution before connecting this projector to a computer.
- Some computers may have multiple screen display modes. Some of these modes cannot be used with this projector.
- The image may not be displayed correctly when the input signal is a composite sync or a sync on G signal.
- For some computer signals the optional Mac adapter is necessary.
- Automatic adjustment may not function correctly with some input signals.

## Computer signal examples

| Resolution (HxV) | H. frequency (kHz) | V. frequency (Hz) | Rating | Signal mode |
|------------------|--------------------|-------------------|--------|-------------|
| 720 x 400        | 37.9               | 85.0              | VESA   | TEXT        |
| 640 x 480        | 31.5               | 59.9              | VESA   | VGA (60Hz)  |
| 640 x 480        | 37.9               | 72.8              | VESA   | VGA (72Hz)  |
| 640 x 480        | 37.5               | 75.0              | VESA   | VGA (75Hz)  |
| 640 x 480        | 43.3               | 85.0              | VESA   | VGA (85Hz)  |
| 800 x 600        | 35.2               | 56.3              | VESA   | SVGA (56Hz) |
| 800 x 600        | 37.9               | 60.3              | VESA   | SVGA (60Hz) |
| 800 x 600        | 48.1               | 72.2              | VESA   | SVGA (72Hz) |
| 800 x 600        | 46.9               | 75.0              | VESA   | SVGA (75Hz) |
| 800 x 600        | 53.7               | 85.1              | VESA   | SVGA (85Hz) |
| 1024 x 768       | 48.4               | 60.0              | VESA   | XGA (60Hz)  |
| 1024 x 768       | 56.5               | 70.1              | VESA   | XGA (70Hz)  |
| 1024 x 768       | 60.0               | 75.0              | VESA   | XGA (75Hz)  |
| 1280 x 720       | 44.7               | 60.0              | VESA   | -           |
| 1280 x 1024      | 64.0               | 60.0              | VESA   | SXGA (60Hz) |

**NOTE** • Full-size display may not be possible with some input signals. Refer to the resolutions above.

- Although the projector can display signals with resolution up to SXGA (1280x1024), signals will be converted to the projector's panel resolution before being displayed. The best display performance is achieved when the resolutions of the input signal and projector panel are identical.
- For some input types when the screen resolution is changed on a computer, the automatic adjustment function may take a long time or may not complete. If this happens, you may not be able to see the "Yes/No" check box to confirm the resolution change in Windows. The screen resolution will then be reset to the previous resolution. It is recommended to use a CRT or LCD monitor to change the resolution if this occurs.

## About Plug-and-Play capability

Plug-and-Play is a system composed of a computer, its operating system and peripheral equipment (i.e. display devices). This projector is VESA DDC 2B compatible. Plug-and-Play can be used by connecting this projector to a computer that is VESA DDC (display data channel) compatible.

- Take advantage of this feature by connecting an RGB cable to the COMPUTER port (DDC 2B compatible). Plug-and-Play may not work properly if any other type of connection is attempted.
- This projector behaves as a standard Plug-and-Play monitor and uses the standard monitor drivers provided with your operating system.



## Connecting the power supply

Before connecting the power, make sure that the power switch is in the OFF position (the side marked "O").

1. Connect the power cord connector to the projector's AC inlet.
2. Plug the power cord's plug firmly into a power outlet.

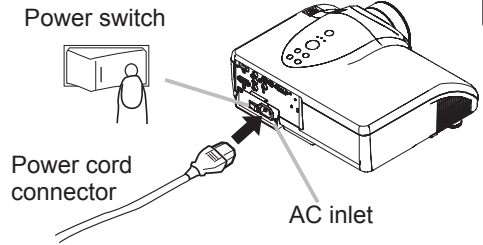

**⚠ WARNING** ▶ Use extra caution when connecting the power cord as incorrect or faulty connections may result in fire and/or electrical shock.

- Use only the power cord that came with the projector. If it becomes damaged, contact your dealer for a new one.
- Only plug the power cord into an outlet rated for use with the power cord's specified voltage range.
- Never modify the power cord. Never attempt to defeat the ground connection of the three-pronged plug.
- The power outlet should be close to the projector and easily accessible.
- Do not touch the power cord with wet hands.
- Check that the power cord connector is clean (no dust) before using. Use a soft, dry cloth to clean the power cord.
- Insert the power plug into the power outlet firmly. Avoid using loose, unsound outlets and contact failures.

## Using the cable cover

Use of the accessory cable cover is recommended when the projector is suspended from the ceiling. The cable cover collects the cables together and prevents slack cables from hanging down from the ceiling.

To attach the cable cover to the projector, please use the following procedure.

1. Loosen the 2 screws on the cable cover and also the screw for the cable cover on the rear of the projector.
2. Attach the cable cover to the projector, bundling the connected cables and running them through the window of the cable cover.
3. Retighten the screws that were loosened in the previous step to lock the cover in place.

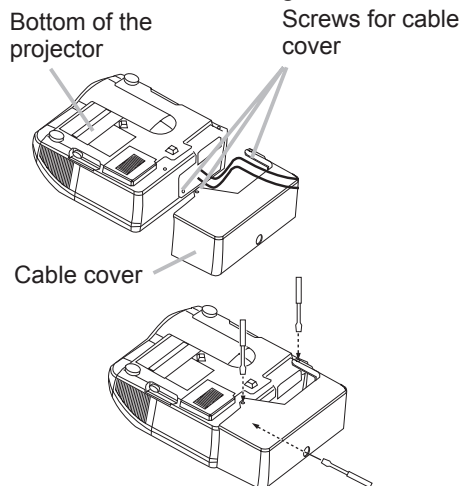

## Loading batteries into the remote control

Please load the batteries before using the remote control. If the remote control starts to malfunction, replace the batteries. If you will not use the remote control for an extended period, remove the batteries from the remote control and store them in a safe place.

1. Remove the battery cover. Slide the battery cover back in the direction of the arrow and remove.
2. Take old batteries out and/or put new batteries in. When putting batteries in, insert the two AAA batteries according to their plus and minus terminals as indicated on the remote control.
3. Close the battery cover. Replace the battery cover in the direction of the arrow and snap it back into place.



**⚠ WARNING** ► Always handle batteries with care and use them only as directed. Batteries may explode if mishandled. Mishandling may also result in cracking or leakage, which could in turn result in fire, injury and/or pollution of the surrounding environment.

- Do not recharge, short circuit, solder, disassemble or dispose of batteries in fire or water.
- Be sure to use only the batteries specified. Do not use different types of batteries together. Do not mix new and old batteries.
- Make sure the plus and minus terminals are correctly aligned when loading batteries.
- Keep batteries away from children and pets.
- Keep batteries in a dark, cool and dry place.
- Do not drop, hit or otherwise jar the battery in anyway.
- If you notice battery leakage, clean out the liquid and then replace the battery. If any of the liquid gets on your body or clothes, immediately rinse well with water.
- Obey local laws on battery disposal.

## Using the remote control

The remote control works with the projector's remote sensor.

- The range of the remote sensor is 60-degrees (30-degrees to the left and right of the remote sensor) within 3 meters.
- The remote signal may also be able to be reflected off the screen etc. If it is difficult to send the remote signal to the sensor directly, try to reflect the signal.
- The remote control uses infrared light to send signals to the projector (Class 1 LED), so be sure to use the remote control in an area free from obstacles that could block the remote control's signal to the projector.

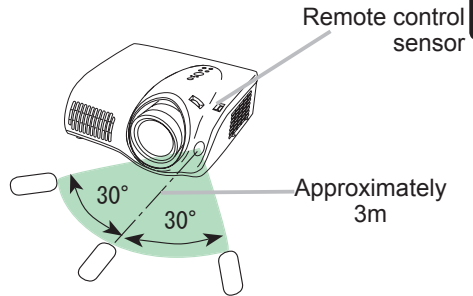

## Using the remote control button lights

When using the remote control in the dark, the buttons of the remote control can light up.

1. Pressing the LIGHT button turns the remote control button lights on. The lights will automatically turn off after a short time.

LIGHT button

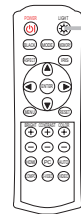

**⚠ CAUTION** ► Be careful when handling the remote control. Incorrect handling could cause damage and/or malfunction.

- Do not drop, hit or otherwise jar the remote control in anyway.
- Do not get the remote control wet or place it on wet objects.
- If you will not use the remote control for an extended period, remove the batteries from the remote control and store them in a safe place.

**NOTE** • If the remote control starts to malfunction, replace the batteries.

- The remote control may not function correctly if strong light (such as direct sunlight) or light from an extremely close range (such as from an inverter fluorescent lamp) shines on the projector's remote sensor. Adjust the position of the projector so that light does not shine directly on the projector's remote sensor.

## Projection

### Turning the power on

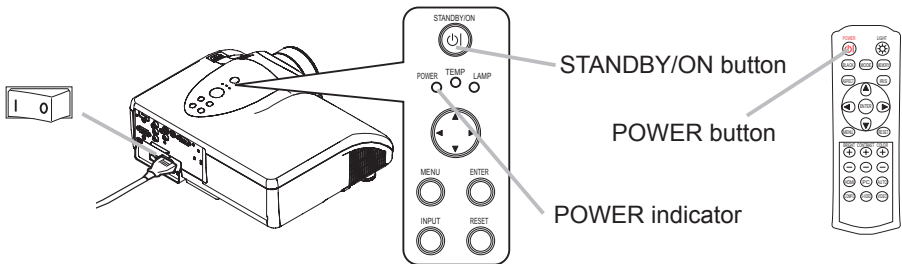

1. Make sure that the power cord is firmly and correctly connected to both the projector and power outlet.
2. Open the lens cover, and set the power switch to the ON position.  
The power indicator will light a steady orange. Then wait several seconds because buttons may not function for the first several seconds the projector is turned on.
3. Press the STANDBY/ON button on the projector or the POWER button on the remote control.  
The projector lamp will light up and the POWER indicator will begin blinking in green. When the power is completely on, the indicator will stop blinking and light a steady green.

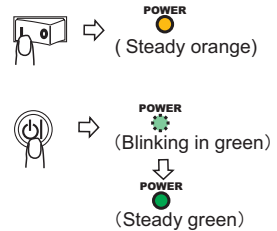

**⚠ WARNING** ► When the power is on, a strong light is emitted. Do not look into the projector lens or openings.

**NOTE** • Turn the power on in the correct order. Turn on the projector before the connected devices.



## Adjusting the display position

The lens of this projector can be shifted horizontally and vertically to adjust the display position using the lens shift dials.

1. Use the vertical lens shift dial to shift the picture upward or downward.
2. Use the horizontal lens shift dial to shift the picture left or right.

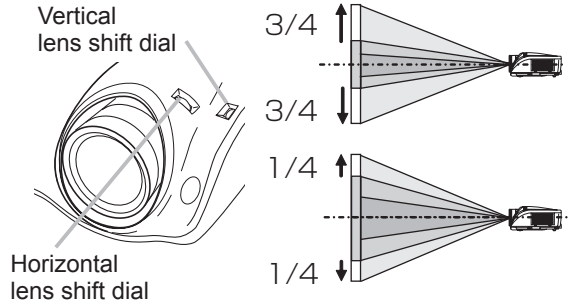

**NOTE** • The best picture quality is generally achieved when the lens shift is set to the center. Each lens shift dial clicks into place when set to the center.

## Adjusting the zoom

Use the zoom ring on the projector to adjust the magnification of the picture.

1. Hold the knob of the zoom ring while turning the zoom ring.

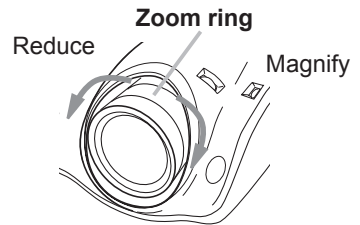

## Adjusting the focus

Use the focus ring on the projector to focus the picture.

1. Hold the knob of the focus ring while turning the focus ring.

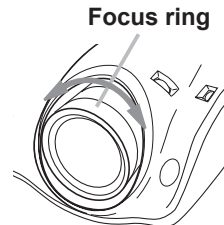

## Turning the power off

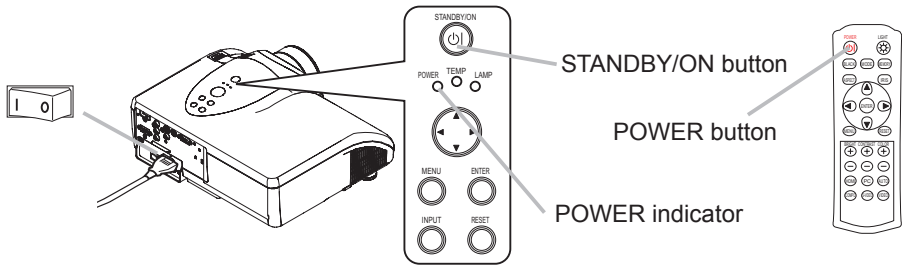

1. Press the STANDBY/ON button on the projector or the POWER button on the remote control. The message "Power off?" will appear on the screen for approximately 5 seconds.
2. Press the STANDBY/ON button on the projector or the POWER button on the remote control again when the "Power off?" message appears. The projector lamp will go off, and the POWER indicator will begin blinking in orange. Then the POWER indicator will stop blinking and light steady orange when the lamp is finished cooling down.
3. Make sure that the power indicator is lit a steady orange, and set the power switch to the OFF position. The POWER indicator will go off. Do not set the power switch to the OFF position while the POWER indicator is green or blinking.
4. Close the lens cover. For safety purposes, disconnect the power cord if the projector is not to be used for prolonged periods of time.

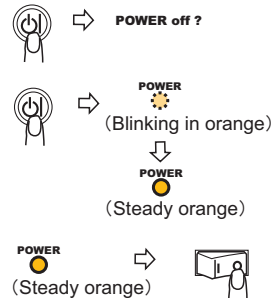

- NOTE** • Turn the power off in right order. Turn off the connected devices first and the projector last.
- Except for emergencies, whenever you turn the projector off be sure to follow the procedure explained in "Turning off the power", and do not disconnect the power cord until the procedure is complete. Neglect can cause damage to the electrode and/or prevent the lamp from lighting.
  - This projector is controlled by an internal microprocessor. Under certain exceptional circumstances, the projector may not operate correctly even when turning off the power. If this occurs, please push the restart switch ( [7](#), [64](#) ) using a pin or similar object. Make sure that the power indicator is lit a steady orange, and set the power switch to the OFF position. Only use the restart switch in exceptional circumstances.
  - If there is a power failure, or the restart switch is used, allow the projector to cool down for at least 10 minutes before turning on again.

## Basic operation

The following functions are basic and useful. They can also be easily accessed using the remote control.

Some functions display dialogs to aid you. Although the dialogs automatically close after several seconds, the dialogs can be deactivated using the MESSAGE function in the SCREEN menu (📖49).

### ASPECT

ASPECT refers to the aspect ratio modes. The following aspect ratio modes are available. Select a mode corresponding to the input signal to be used.

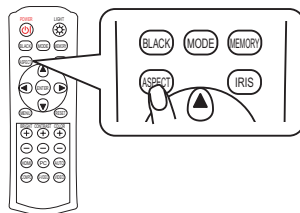

1. Press the ASPECT button.
  - Each time the button is pressed the mode will change and a dialog indicating the selected mode will be displayed.

#### ■ For a computer (RGB) signal

**NORMAL** → 4:3 → 16:9



#### ■ For an HDMI signal

**NORMAL** → 4:3 → 16:9 → WIDE → MOVIE1 → MOVIE2 → 14:9



#### ■ For a video, s-video or component video signal

**4:3** → 16:9 → WIDE → MOVIE1 → MOVIE2 → 14:9



#### ■ For no signal or an unrecognized signal

**16:9** (fixed)

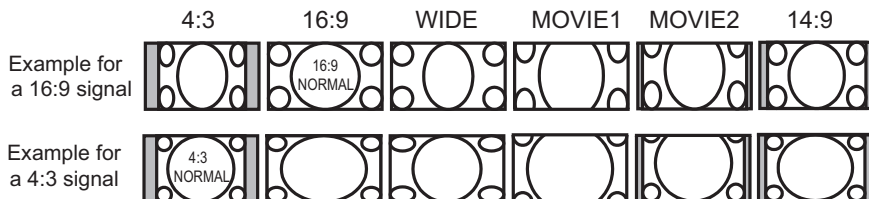

**NOTE** • The NORMAL mode uses the signal's original aspect ratio.  
 • Performing an automatic adjustment initializes the aspect ratio setting.  
 • The ASPECT function can also be accessed via the EASY MENU (📖31) or the IMAGE menu in the Advanced Menu (📖43).



## IRIS

The iris can be adjusted to suit the brightness of the surroundings and other conditions.

1. Press the IRIS button.  
The projector will display a dialog to aid you in adjusting the iris.
2. Use the ▲/▼ cursor buttons to adjust the iris.

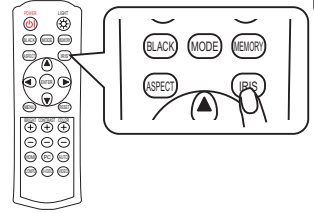

ENGLISH

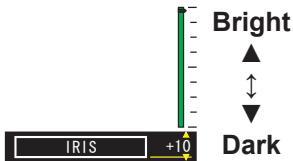

3. To close the dialog and end the operation press the IRIS button again. The dialog will automatically close after several seconds without user input.

**NOTE** • Pressing the RESET button while the dialog is displayed resets the adjustment.

• The IRIS function can also be accessed via the PICTURE menu in the Advanced Menu (📖41).

## MODE

MODE refers to modes that are a combination of the GAMMA (📖37), COLOR TEMP (📖39), and IRIS (📖41) settings as shown in the table below. Select a mode corresponding to the input signal to be used.

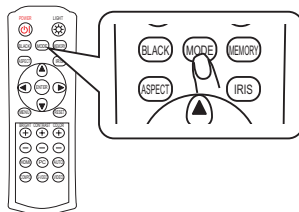

1. Press the MODE button.
  - Each time the button is pressed the mode will change and a dialog indicating the selected mode will be displayed.

**NORMAL → CINEMA LOW → CINEMA HIGH → MUSIC → SPORTS**



| MODE        | GAMMA       | COLOR TEMP | IRIS | Recommended source   |
|-------------|-------------|------------|------|--|
| NORMAL      | STANDARD    | 7500K      | 7    | For a wide range of sources at standard picture quality.   |
| CINEMA LOW  | LOW         | 6500K      | 5    | Suitable for appreciating movies with film-like video.   |
| CINEMA HIGH | HIGH        | 6500K      | 5    | Suitable for appreciating movies with sharp, realistic video.  |
| MUSIC       | HIGH        | 7500K      | 7    | Suitable for live concerts, music videos.  |
| SPORTS      | Hi-CONTRAST | 9300K      | 10   | Suitable for video that emphasizes a feeling of contrast: high definition broadcasts, sports broadcasts. |

**NOTE** • When the combination of the settings does not correspond with any pre-set modes, the dialog will display the mode as “CUSTOM”.  
 • The MODE function can also be accessed via the EASY MENU (📖32).

## BLACK

BLACK refers to the auto iris control modes as shown in the table below. The auto iris is automatically controlled to adjust the black level according to the mode selected.

- Press the BLACK button.
  - Each time the button is pressed the mode will change and a dialog indicating the selected mode will be displayed.

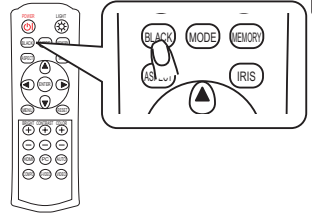

ENGLISH

**TURN OFF → AUTO1 → AUTO2**



| BLACK    | Mode characteristics                                   |
|----------|--|
| TURN OFF | The auto iris is always open.                          |
| AUTO1    | The auto iris displays a better black for dark images. |
| AUTO2    | The auto iris displays the best black for dark images. |

**NOTE** • The screen may flicker when the AUTO1 or AUTO2 modes are selected.  
 • The BLACK function can also be accessed via the EASY MENU (📖 32) or the PICTURE menu in the Advanced Menu (📖 41).

## BRIGHTNESS, CONTRAST, COLOR

The brightness, contrast and color can be easily adjusted to suit your preferences.

- On the remote control press either the ⊕ or ⊖ buttons under the item you want to adjust. The projector will then display a dialog to aid you in adjusting the item.
- Use the ⊕ and ⊖ cursor buttons to adjust the item.

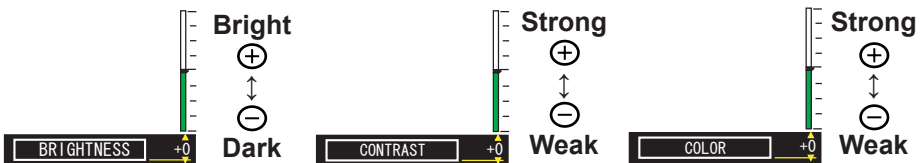
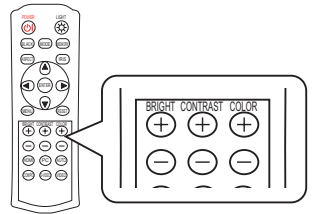

**NOTE** • Pressing the RESET button while the dialog is displayed resets the adjustment.

• The BRIGHTNESS, CONTRAST and COLOR functions can also be accessed via the EASY MENU (📖 33) or the PICTURE menu in the Advanced Menu (📖 37, 40).

• The COLOR function can only be used for video, s-video, component video or HDMI signals.

## MY MEMORY

This projector provides 4 memories to save user adjustment settings. The brightness, contrast, color, tint, sharpness and iris adjustment settings, and selected modes for gamma, color temperature, black, whisper and digital shutter can be saved to each memory.

You can name and save a maximum of 4 sets of adjustment settings, and the saved adjustment settings can be named and reloaded later.

### To load saved adjustment settings

Note that if the MESSAGE function (📖 51) is inactive, step 1 in the following procedure is skipped. The projector will not display any dialog, and will load saved adjustment settings as soon as the MEMORY button is pressed. Please see step 2.

1. Press the MEMORY button once.
  - The projector will display a dialog to indicate the current adjustment settings.
  - When the current adjustment settings are from one of the saved memories a dialog shows which memory is being used.

#### 1. CUSTOM-1

- When the current settings are not saved to memory the following dialog is displayed.

|                     |                           |
|---------------------|---------------------------|
| Temporary condition |                           |
| ENTER               | : Save these parameters   |
| MEMORY              | : Recall saved parameters |
| ←                   | : Quit                    |

2. To load saved adjustment settings press the MEMORY button.
  - Each time you press the button, one of the saved adjustments is loaded, in the following order. Memories in which no data is saved are skipped.

1. CUSTOM-1 → 2. CUSTOM-2 → 3. CUSTOM-3 → 4. CUSTOM-4



- When there are no saved adjustment settings the following dialog is displayed.

#### No saved data

**NOTE** • Adjustment settings cannot be loaded when there are no saved adjustment settings.

- The numbers to the left of each memory cannot be changed but the name to the right can be changed.

- The MY MEMORY function can also be accessed via the PICTURE menu in the Advanced Menu (📖 41).

## To save adjustment settings

Note that if the MESSAGE function (📖 51) is inactive, the following procedure cannot be performed and the projector will load saved adjustment settings as soon as the MEMORY button is pressed.

When the MESSAGE function is inactive please use the MY MEMORY function in the PICTURE menu (📖 42) to save adjustment settings.

When the MESSAGE function is active, the MY MEMORY menu can be displayed using the following procedure. The MY MEMORY menu displayed is the same as in the PICTURE menu. You cannot only save adjustment settings but also change and rename previously saved adjustment settings via this menu.

1. Press the MEMORY button once.
  - The projector will display a dialog to indicate the current adjustment settings.
- When the current adjustment settings are from one of the saved memories a dialog shows which memory is being used.

### 1. CUSTOM-1

- When the current settings are not saved to memory the following dialog is displayed.

```

Temporary condition
ENTER : Save these parameters
MEMORY : Recall saved parameters
← : Quit
  
```

2. Press the ENTER button while the dialog is displayed to open the MY MEMORY menu and save to the currently selected memory.
3. Please refer to the MY MEMORY item under PICTURE menu (📖 42) for more information on using the MY MEMORY menu.

| MY MEMORY       |          | ⊙ : SELECT |
|-----------------|----------|------------|
| NAME            | CUSTOM-1 | ▶          |
| BRIGHTNESS      | +0       |            |
| CONTRAST        | +0       |            |
| GAMMA           | STANDARD |            |
| COLOR TEMP      | 6500K    |            |
| COLOR           | +0       |            |
| TINT            | +0       |            |
| SHARPNESS       | +3       |            |
| IRIS            | 10       |            |
| BLACK           | TURN OFF |            |
| WHISPER         | NORMAL   |            |
| DIGITAL SHUTTER | TURN OFF |            |
| SAVE            |          |            |
| MENU : QUIT     |          |            |

**NOTE** • The numbers to the left of each memory cannot be changed but the name to the right can be changed.

• The MY MEMORY function can also be accessed via the PICTURE menu in the Advanced Menu (📖 42).

## EASY MENU

This projector has various functions intended to improve picture quality. The EASY MENU provides quick and easy access to the most useful of these functions.

### EASY MENU operation

Follow the procedure below to use the EASY MENU.

#### 1. To display a menu when no menu is currently displayed

Press the MENU button and a menu will be displayed. Alternatively, pressing one of the ▲/▼/◀/▶ cursor buttons will also display a menu.

The tall menu is the EASY MENU. The wide menu is the Advanced Menu.

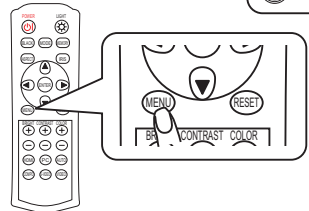
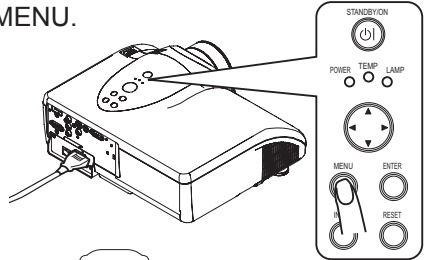

#### 2. To switch from the Advanced Menu to the EASY MENU

- (1) If the yellow highlight bar is in the right column of the Advanced Menu, press the ◀ cursor button to move the yellow highlight bar to the left column.
- (2) Move the yellow highlight bar onto the “EASY MENU” item using the ▲/▼ cursor buttons, then press the ▶ cursor button or the ENTER button.

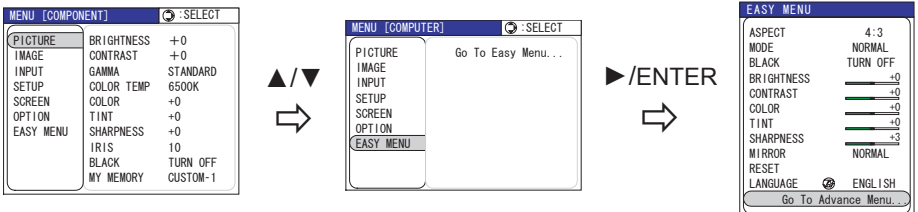

The EASY MENU item is always the bottom item in the left column of the Advanced Menu. Even if the menu is displayed in another language, choosing the bottom item in the left column will switch to the EASY MENU.

#### 3. To change the display language

The display language can be changed using the LANGUAGE item in the EASY MENU (📖 34).

Even if the menu is displayed in another language, the LANGUAGE item will always be the 2nd item from the bottom in the EASY MENU.

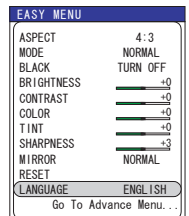







#### 4. To select an item

Move the yellow highlight bar onto the item you want to select using the ▼/▲ cursor buttons.

5. **To operate the selected item**  
Use the ◀/▶ cursor buttons to operate the item. For details please see the following descriptions.
6. **To reset the operation**  
Press the RESET button while the item is selected.  
(Does not reset the LANGUAGE item.)
7. **To close the menu**  
Press the MENU button to close the menu. The menu will automatically close after several seconds without user input.

## EASY MENU functions



The following functions are accessible via the EASY MENU. After selecting an item according to the procedure described in the preceding “EASY MENU operation” section, refer to the following table for details on operating the selected item.

| Item   | Description  |
|--------|--|
| ASPECT | <p>Using the ◀/▶ cursor buttons changes the aspect ratio.</p> <ul style="list-style-type: none"> <li>■ For a computer (RGB) signal<br/><b>NORMAL ↔ 4:3 ↔ 16:9</b><br/> </li> <li>■ For an HDMI signal<br/><b>NORMAL ↔ 4:3 ↔ 16:9 ↔ WIDE ↔ MOVIE1 ↔ MOVIE2 ↔ 14:9</b><br/> </li> <li>■ For a video, s-video or component video signal<br/><b>4:3 ↔ 16:9 ↔ WIDE ↔ MOVIE1 ↔ MOVIE2 ↔ 14:9</b><br/> </li> <li>■ For no signal or an unrecognized signal<br/><b>16:9 (fixed)</b></li> </ul> <p>  </p> <p>  </p> <p><b>- NOTE -</b></p> <ul style="list-style-type: none"> <li>• The NORMAL mode uses the signal's original aspect ratio.</li> <li>• Performing an automatic adjustment initializes the aspect ratio setting.</li> <li>• The ASPECT function can also be accessed using the ASPECT button on the remote control (  24) or via the IMAGE menu in the Advanced Menu (  43).</li> </ul> |

(Continued on next page)





| Item       | Description   |
|------------|---|
| BRIGHTNESS | Using the ◀/▶ cursor buttons adjusts the picture.<br><b>Darker ⇄ Brighter</b><br><b>- NOTE -</b><br>• The BRIGHTNESS function can also be accessed using the BRIGHT buttons on the remote control (📖27) or via the PICTURE menu in the Advanced Menu (📖37).   |
| CONTRAST   | Using the ◀/▶ cursor buttons adjusts the picture.<br><b>Weaker ⇄ Stronger</b><br><b>- NOTE -</b><br>• The CONTRAST function can also be accessed using the CONTRAST buttons on the remote control (📖27) or via the PICTURE menu in the Advanced Menu (📖37).   |
| COLOR      | Using the ◀/▶ cursor buttons adjusts the picture.<br><b>Weaker ⇄ Stronger</b><br><b>- NOTE -</b><br>• The COLOR function can only be used for video, s-video, component video or HDMI signals.<br>• The COLOR function can also be accessed using the COLOR buttons on the remote control (📖27) or via the PICTURE menu in the Advanced Menu (📖40).   |
| TINT       | Using the ◀/▶ cursor buttons adjusts the picture.<br><b>Reddish ⇄ Greenish</b><br><b>- NOTE -</b><br>• The TINT function can only be used for video, s-video, component video or HDMI signals.<br>• The TINT function can also be accessed via the PICTURE menu in the Advanced Menu (📖40).   |
| SHARPNESS  | Using the ◀/▶ cursor buttons adjusts the picture.<br><b>Weaker ⇄ Stronger</b><br><b>- NOTE -</b><br>• The SHARPNESS function can also be accessed via the PICTURE menu in the Advanced Menu (📖40).  |
| MIRROR     | Using the ◀/▶ cursor buttons changes the mirror mode.<br><br><b>NORMAL ⇄ H:INVERT ⇄ V:INVERT ⇄ H&amp;V:INVERT</b><br><br><b>- NOTE -</b><br>• The MIRROR function can also be accessed via the SETUP menu in the Advanced Menu (📖48). |

(Continued on next page)

| Item               | Description  |
|--------------------|--|
| RESET              | Using this function resets all items in the EASY MENU except the LANGUAGE item.<br>Pressing the ► cursor button displays a confirmation dialog.<br>To reset press the ▼ cursor button.   |
| LANGUAGE           | Using the ◀/▶ cursor buttons changes the display language.<br><b>ENGLISH ⇔ FRANÇAIS ⇔ DEUTSCH ⇔ ESPAÑOL</b><br><br><b>ITALIANO ⇔ NORSK ⇔ NEDERLANDS ⇔ PORTUGUÊS</b><br><b>日本語 ⇔ 简体中文 ⇔ 繁體中文 ⇔ 한글</b><br><b>SVENSKA ⇔ РУССКИЙ ⇔ SUOMI ⇔ POLSKI ⇔ TÜRKÇE</b><br><br><b>- NOTE -</b><br>• The LANGUAGE function can also be accessed via the SCREEN menu in the Advanced Menu (49). |
| Go To Advance Menu | Pressing the ► cursor button switches to the Advanced Menu.  |

## Advanced Menu

The Advanced Menu provides access to advanced features, grouped into 6 sub-menus (PICTURE, IMAGE, INPUT, SETUP, SCREEN and OPTION) for more precise picture control.

### Advanced Menu operation

Follow the procedure below to use the Advanced Menu.

#### 1. To display a menu when no menu is currently displayed

Press the MENU button and a menu will be displayed. Alternatively, pressing one of the ▲/▼/◀/▶ cursor buttons will also display a menu.

The tall menu is the EASY MENU. The wide menu is the Advanced Menu.

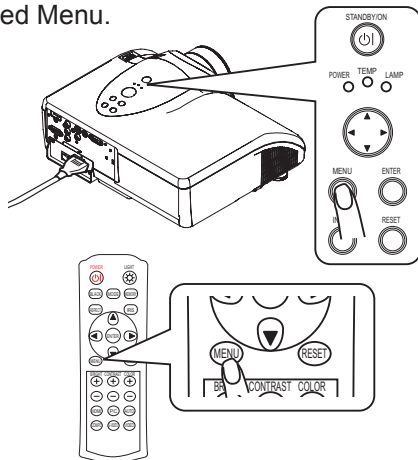

#### 2. To switch from the EASY MENU to the Advanced Menu

Move the yellow highlight bar onto the “Go To Advanced Menu...” item using the ▲/▼ cursor buttons, then press the ▶ cursor button or the ENTER button.

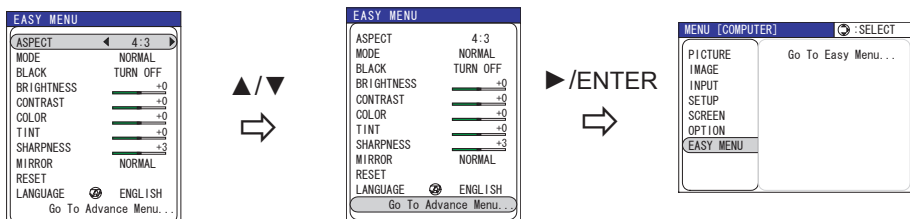

The “Go To Advance Menu...” item is always the bottom item in the EASY MENU. Even if the menu is displayed in another language, choosing the bottom item in the left column will switch to the Advanced Menu.

#### 3. To change the display language

The display language can be changed using the LANGUAGE item on the SCREEN menu in the Advanced Menu (49).

Even if the menu is displayed in another language, the SCREEN menu will always be the 5th item from the top in the left column of the Advanced Menu and the LANGUAGE item will always be the top item in the SCREEN menu.

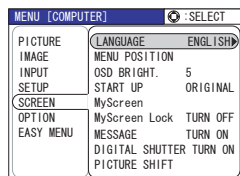

- 4. To select a menu**
  - (1) If the yellow highlight bar is in the right column of the Advanced Menu, press the ◀ cursor button to move the yellow highlight bar to the left column.
  - (2) Move the yellow highlight bar onto the title of the menu you want to select using the ▼/▲ cursor buttons. The menu items will be shown in the right column of the Advanced Menu.  
Then press the ▶ cursor button or ENTER button.
- 5. To reset the menu settings**

All the settings of the selected menu can be initialized at the same time, except settings where the current setting is always considered the default setting. (MY MEMORY, LANGUAGE, MyScreen Lock, LAMP TIME, FILTER TIME etc.)

  - (1) Press the RESET button while yellow highlight bar is on the title of the menu and a confirmation dialog will be displayed.
  - (2) To reset press the ▲ cursor button.
- 6. To select an item**

Move the yellow highlight bar onto the item you want to select using the ▼ /▲ cursor buttons. Then press the cursor ▶ button or ENTER button, and a dialog or sub-menu will appear.
- 7. To operate the selected item**

Use the ▲/▼/◀/▶ cursor buttons according to the dialog or sub-menu. For more details please see the following descriptions of each item.
- 8. To reset the operation**

Press the RESET button while the dialog or sub-menu is displayed. (Except for MY MEMORY, AUTO ADJUST, INFORMATION, LANGUAGE, MyScreen Lock, LAMP TIME, FILTER TIME and SERVICE.)
- 9. To close the menu**

Press the MENU button to close the menu. The menu will automatically close after several seconds without user input.

## PICTURE menu

The following functions are accessible via the PICTURE menu. After selecting an item according to the procedure described in the preceding “Advanced Menu operation” section (35), refer to the following table for details on operating the selected item.

| MENU [COMPONENT] |            | :SELECT  |
|------------------|------------|----------|
| PICTURE          | BRIGHTNESS | +0       |
| IMAGE            | CONTRAST   | +0       |
| INPUT            | GAMMA      | STANDARD |
| SETUP            | COLOR TEMP | 6500K    |
| SCREEN           | COLOR      | +0       |
| OPTION           | TINT       | +0       |
| EASY MENU        | SHARPNESS  | +0       |
|                  | IRIS       | 10       |
|                  | BLACK      | TURN OFF |
|                  | MY MEMORY  | CUSTOM-1 |

| Item       | Description   |
|------------|---|
| BRIGHTNESS | <p>Using the ▲/▼ cursor buttons adjusts the picture.</p> <p><b>Brighter ⇄ Darker</b></p> <p><b>- NOTE -</b></p> <ul style="list-style-type: none"> <li>The BRIGHTNESS function can also be accessed using the BRIGHT buttons on the remote control (27) or via the EASY MENU (33).</li> </ul>   |
| CONTRAST   | <p>Using the ▲/▼ cursor buttons adjusts the picture.</p> <p><b>Stronger ⇄ Weaker</b></p> <p><b>- NOTE -</b></p> <ul style="list-style-type: none"> <li>The CONTRAST function can also be accessed using the CONTRAST buttons on the remote control (27) or via the EASY MENU (33).</li> </ul>   |
| GAMMA      | <p>This projector provides 4 pre-set modes and 4 custom gamma modes.</p> <p><b>To select a mode</b></p> <p>Using the ▲/▼ cursor buttons in the GAMMA menu changes the gamma mode. The mode that the yellow highlight bar is on is the currently selected mode.</p> <p><b>STANDARD ⇄ LOW ⇄ HIGH ⇄ Hi-CONTRAST</b></p> <p><b>CUSTOM-1 ⇄ CUSTOM-2 ⇄ CUSTOM-3 ⇄ CUSTOM-4</b></p> <p> </p> <ul style="list-style-type: none"> <li> <b>■ STANDARD</b><br/>                     Suitable for a wide range of sources.                 </li> <li> <b>■ LOW</b><br/>                     This mode emphasizes the reproducibility of lower tones.                 </li> <li> <b>■ HIGH</b><br/>                     This mode emphasizes the reality of the image.                 </li> <li> <b>■ Hi-CONTRAST</b><br/>                     This mode emphasizes the contrast of the image.                 </li> <li> <b>■ CUSTOM-1, CUSTOM-2, CUSTOM-3, CUSTOM-4</b><br/>                     These modes can be customized based on one of the pre-set modes.                 </li> </ul> <div style="text-align: right;"> </div> |

(Continued on next page)

| Item                           | Description  |
|--------------------------------|--|
| <p>Continuation of "GAMMA"</p> | <p><b>To adjust a CUSTOM mode</b></p> <p>(1) Select one of the CUSTOM modes to adjust using the ▲/▼ cursor buttons. Then press the ► cursor button to display the CUSTOM dialog.</p> <p>(2) Select the base mode to be adjusted using the ▲/▼ cursor buttons.</p> <p>Note that changing the base mode and pressing the ► cursor button in the CUSTOM dialog will erase the current settings of the selected mode. If you want to keep the settings, please press the ◀ cursor button to return to the preceding menu, and select a different CUSTOM mode.</p> <p>Then press the ► cursor button to display a dialog with 9 adjustment bars. Each bar corresponds to the tone of each of 9 gamma steps. The names of selected mode and the base mode are shown at the bottom of the dialog.</p> |
|                                | <p>(3) Pressing the ENTER button while the dialog is displayed displays a test pattern to aid in adjusting.</p> <p>This projector has 3 types of test pattern. Each time you press the ENTER button, the test pattern is changed.</p> <p>Each part of the 9 step gray scale is linked to the corresponding adjustment bar in the dialog.</p> <p>(4) Select the adjustment bar for the step to adjust using the ◀/► cursor buttons.</p> <p>Note that pressing the cursor ◀ button while the number 1 adjustment bar is selected closes the dialog and returns to the GAMMA menu.</p> <p>(5) Adjust the tone of the selected step using the ▲/▼ cursor buttons.</p>  |

(Continued on next page)

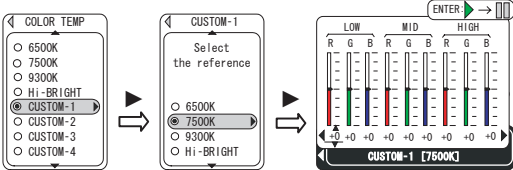
| Item              | Description  |
|-------------------|--|
| <p>COLOR TEMP</p> | <p>This projector provides 4 pre-set modes and 4 custom color temperature modes.</p> <p><b>To select a mode</b><br/>Using the ▲/▼ cursor buttons in the COLOR TEMP menu changes the color temperature mode. The mode that the yellow highlight bar is on is the currently selected mode.</p> <p style="text-align: center;"><b>6500K ⇄ 7500K ⇄ 9300K ⇄ Hi-BRIGHT</b></p> <p style="text-align: center;"><b>CUSTOM-1 ⇄ CUSTOM-2 ⇄ CUSTOM-3 ⇄ CUSTOM-4</b></p> <p>■ <b>6500K, 7500K, 9300K</b><br/>These modes set the same color temperature as the mode name.</p> <p>■ <b>Hi-BRIGHT</b><br/>The mode is prepared thinking much of the brightness of the image with the maximum gains of all colors.</p> <p>■ <b>CUSTOM-1, CUSTOM-2, CUSTOM-3, CUSTOM-4</b><br/>These modes can be customized based on one of the pre-set modes.</p> <p><b>To adjust a CUSTOM mode</b></p> <p>(1) Select one of the CUSTOM modes to adjust using the ▲/▼ cursor buttons. Then press the ► cursor button to display the CUSTOM dialog.<br/>Note that pressing the ▲/▼/► cursor buttons or the ENTER button in the CUSTOM dialog will erase the current settings of the selected mode. If you want to keep the settings, please press the ◀ cursor button to return to the preceding menu, and select a different CUSTOM mode.</p> <p>(2) Select the base mode to be adjusted using the ▲/▼ cursor buttons. Then press the ► cursor button to display a dialog with 3 sets of 3 adjustment bars. Each set corresponds to a step of the color temperature, and every set has 3 adjustment bars for red, green and blue. The names of selected mode and the base mode are shown at the bottom of the dialog.</p> <div style="text-align: center;">  </div> |

(Continued on next page)

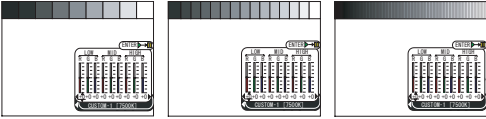

| Item                         | Description   |
|------------------------------|---|
| Continuation of "COLOR TEMP" | <p>(3) Pressing the ENTER button while the dialog is displayed displays a test pattern to aid in adjusting.<br/>           This projector has 3 types of test pattern. Each time you press the ENTER button, the test pattern is changed.<br/>           Each part of the 9 step gray scale is linked to the corresponding adjustment bar in the dialog.</p> <div style="text-align: center;">  <p>(no display) ⇒ <b>9 step gray scale</b> ⇒ <b>15 step gray scale</b> ⇒ <b>Ramp</b></p> </div> <p>(4) Select the adjustment bar for the color element to adjust using the ◀/▶ cursor buttons.<br/>           Note that pressing the cursor ◀ button while the adjustment bar of the LOW step's R is selected closes the dialog and turns it into the COLOR TEMP menu.</p> <p>(5) Adjust the tone of the selected step using the ▲/▼ cursor buttons.</p> |
| COLOR                        | <p>Using the ▲/▼ cursor buttons adjusts the picture.<br/> <b>Stronger ⇔ Weaker</b></p> <p>- NOTE -</p> <ul style="list-style-type: none"> <li>• The COLOR function can only be used for video, s-video, component video or HDMI signals.</li> <li>• The COLOR function can also be accessed using the COLOR buttons on the remote control (📄27) or via the EASY MENU (📄33).</li> </ul>  |
| TINT                         | <p>Using the ▲/▼ cursor buttons adjusts the picture.<br/> <b>Greenish ⇔ Reddish</b></p> <p>- NOTE -</p> <ul style="list-style-type: none"> <li>• The TINT function can only be used for video, s-video, component video or HDMI signals.</li> <li>• The TINT function can also be accessed via the EASY MENU (📄33).</li> </ul>  |
| SHARPNESS                    | <p>Using the ▲/▼ cursor buttons adjusts the picture.<br/> <b>Stronger ⇔ Weaker</b></p> <p>- NOTE -</p> <ul style="list-style-type: none"> <li>• The SHARPNESS function can also be accessed via the EASY MENU (📄33).</li> </ul>   |

(Continued on next page)



| Item      | Description  |
|-----------|--|
| IRIS      | <p>Using the ▲/▼ cursor buttons adjusts the picture.</p> <p><b>Bright ⇄ Dark</b></p> <p><b>- NOTE -</b></p> <ul style="list-style-type: none"> <li>The IRIS function can also be accessed using the IRIS button and ▲/▼ cursor buttons on the remote control (📖25).</li> </ul>   |
| BLACK     | <p>Using the ▲/▼ cursor buttons changes the auto iris control mode as follows.</p> <p><b>TURN OFF ⇄ AUTO1 ⇄ AUTO2</b></p> <p style="text-align: center;">↑—————↑</p> <p>■ <b>TURN OFF</b><br/>The auto iris is always open.</p> <p>■ <b>AUTO1</b><br/>The auto iris displays a better black for dark images.</p> <p>■ <b>AUTO2</b><br/>The auto iris displays the best black for dark images.</p> <p><b>- NOTE -</b></p> <ul style="list-style-type: none"> <li>The screen may flicker when the AUTO1 or AUTO2 modes are selected. If this occurs, select TURN OFF.</li> <li>The BLACK function can also be accessed using the BLACK button and the ▲/▼ cursor buttons on the remote control (📖27) or via the EASY MENU (📖32).</li> </ul>  |
| MY MEMORY | <p>This projector provides 4 memories to save user adjustment settings. The brightness, contrast, color, tint, sharpness and iris adjustment settings, and selected modes for gamma, color temperature, black, whisper and digital shutter can be saved to each memory.</p> <p><b>To load saved adjustment settings</b></p> <p>Using the ▲/▼ cursor buttons in the MY MEMORY menu changes the memory to be adjusted, memories in which no data is saved are skipped. The mode that the yellow highlight bar is on is the currently selected mode. Then press the ► cursor button to load the selected mode.</p> <div style="text-align: right;">  <p>MY MEMORY menu (small)</p> </div> <p style="text-align: center;">1. CUSTOM-1 ⇄ 2. CUSTOM-2 ⇄ 3. CUSTOM-3 ⇄ 4. CUSTOM-4 ⇄ <b>SAVE</b></p> <p style="text-align: center;">↑—————↑</p> <p><b>- NOTE -</b></p> <ul style="list-style-type: none"> <li>The numbers to the left of each memory cannot be changed but the name to the right can be changed.</li> <li>The SAVE item is not a memory but an item to display the MY MEMORY menu and save to the currently selected memory. Please refer to the following description about save.</li> <li>When a signal other than the signal used when the adjustment settings were registered is input, the saved adjustment settings may not display the signal image correctly.</li> </ul> |

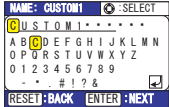
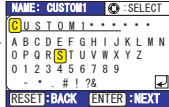

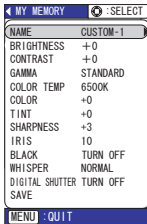

(Continued on next page)

| Item                               | Description   |
|------------------------------------|---|
| <p>Continuation of "MY MEMORY"</p> | <p><b>To save adjustment settings</b></p> <p>(1) Load a base memory using the ▲/▼ cursor buttons in the MY MEMORY menu (small). When you want to use the current adjustment, do not load any other memories. Then press the ► cursor button to display the MY MEMORY menu (large).</p> <p>(2) The MY MEMORY menu (large) shows the name of the current memory and the adjustment settings to be saved. Check the adjustment settings, and go to step (5) to save if no adjustments are necessary.</p> <p>(3) If you want to adjust some of the items, please select an item to adjust using the ▲/▼ cursor buttons. Then press the ► cursor button to display the menu or dialog for adjusting the item. Make adjustments according to the description of each item. After making adjustments, press the ◀ cursor button to return to the MY MEMORY menu (large).</p> <p>(4) If you want to change the name of the memory, select the NAME item using the ▲/▼ cursor buttons. Then press the ► cursor button to display the NAME dialog. The current name is displayed on the 1st line in the menu. The letter in the name that the cursor is on can be changed using the ▲/▼/◀/► cursor buttons to move the cursor in the lower part of the menu. Press the ENTER button to move the cursor onto the next letter in the name, and press the RESET button to move the cursor onto the previous letter in the name.</p> <div style="display: flex; justify-content: space-around; align-items: center;">    </div> <p>Press the ENTER button while the cursor is on the last letter of the name to select the <input checked="" type="checkbox"/> mark. Press the ENTER button again to return to the MY MEMORY menu (large).</p> <p>(5) Select the SAVE item in the MY MEMORY (large) menu using the ▲/▼ cursor buttons. Then press the ► cursor button to display the SAVE dialog.</p> <p>Confirm that the memory you want to save the adjustment settings to is selected. Use the ▲/▼ cursor buttons to change the selected memory. Press the ENTER button to save the current adjustment settings to the selected memory.</p> |
|                                    | <div style="text-align: right;">  <p>MY MEMORY menu (small)</p>  <p>MY MEMORY menu (large)</p> </div>  |

## IMAGE menu

The following functions are accessible via the IMAGE menu. After selecting an item according to the procedure described in the preceding "Advanced Menu operation" section (35), refer to the following table for details on operating the selected item.

| MENU [COMPUTER] |             | :SELECT |
|-----------------|-------------|---------|
| PICTURE         | ASPECT      | 4:3     |
| IMAGE           | OVER SCAN   | 5       |
| INPUT           | V POSITION  | 25      |
| SETUP           | H POSITION  | 142     |
| SCREEN          | H PHASE     | 16      |
| OPTION          | H SIZE      | 1344    |
| EASY MENU       | AUTO ADJUST |         |

| Item      | Description  |
|-----------|--|
| ASPECT    | <p>Using the ▲/▼ cursors buttons changes the aspect ratio.</p> <ul style="list-style-type: none"> <li>■ For a computer (RGB) signal<br/> <b>NORMAL ↔ 4:3 ↔ 16:9</b><br/> </li> <li>■ For an HDMI signal<br/> <b>NORMAL ↔ 4:3 ↔ 16:9 ↔ WIDE ↔ MOVIE1 ↔ MOVIE2 ↔ 14:9</b><br/> </li> <li>■ For a video, s-video or component video signal<br/> <b>4:3 ↔ 16:9 ↔ WIDE ↔ MOVIE1 ↔ MOVIE2 ↔ 14:9</b><br/> </li> <li>■ For no signal or an unrecognized signal<br/> <b>16:9 (fixed)</b></li> </ul> <div style="display: flex; justify-content: space-around; margin-top: 10px;"> <span>4:3</span> <span>16:9</span> <span>WIDE</span> <span>MOVIE1</span> <span>MOVIE2</span> <span>14:9</span> </div> <div style="margin-top: 5px;"> <p>Example for a 16:9 signal</p>  </div> <div style="margin-top: 5px;"> <p>Example for a 4:3 signal</p>  </div> <p><b>- NOTE -</b></p> <ul style="list-style-type: none"> <li>• The NORMAL mode uses the signal's original aspect ratio.</li> <li>• Performing an automatic adjustment initializes the aspect ratio setting.</li> <li>• The ASPECT function can also be accessed using the ASPECT button on the remote control (24) or via the EASY MENU (31).</li> </ul> |
| OVER SCAN | <p>Using the ▲/▼ cursor buttons adjusts the over-scan ratio.</p> <p><b>Large</b> (Reduces the picture) ↔ <b>Small</b> (Magnifies the picture)</p> <p><b>- NOTE -</b></p> <ul style="list-style-type: none"> <li>• The OVER SCAN function can only be used for video, s-video, component video or HDMI signals.</li> <li>• When this adjustment is too large, certain degradation may appear on the border of the picture. If this occurs, readjust.</li> <li>• The numbers displayed in the dialog and the IMAGE menu, are just for your reference, and might not be the exact display ratio.</li> </ul>   |

(Continued on next page)

| Item        | Description   |
|-------------|---|
| V POSITION  | Using the ▲/▼ cursor buttons adjusts the vertical position of the picture.<br><b>Up ⇔ Down</b><br>- NOTE -<br>• The V POSITION cannot be adjusted for signals from the HDMI port.   |
| H POSITION  | Using the ▲/▼ cursor buttons adjusts the horizontal position of the picture.<br><b>Left ⇔ Right</b><br>- NOTE -<br>• The H POSITION cannot be adjusted for signals from the HDMI port.  |
| H PHASE     | Using the ▲/▼ cursor buttons adjusts the horizontal phase to eliminate flicker.<br><b>Right ⇔ Left</b><br>- NOTE -<br>• The H PHASE can be adjusted only for computer (RGB) signals excluding SCART RGB signals, or component video signals excluding 525i (480i) and 625i (576i) signals.  |
| H SIZE      | Using the ▲/▼ cursor buttons adjusts the horizontal size of the picture.<br><b>Large ⇔ Small</b><br>- NOTE -<br>• The H SIZE can be adjusted only for computer (RGB) signals excluding SCART RGB signals.<br>• When this adjustment is excessive, the picture may not be displayed correctly. If this occurs, please reset the adjustment by pressing the RESET button while using this item.   |
| AUTO ADJUST | This function is performed as soon as the ► cursor button is pressed to select this item.<br><b>■ For a signal from the COMPUTER port</b><br>The vertical position, the horizontal position, the horizontal phase, horizontal size and the aspect ratio are automatically adjusted. Make sure that the application window is set to its maximum size before attempting to use this feature. A dark picture may be incorrectly adjusted. Use a bright picture when adjusting.<br><b>■ For a signal from the HDMI port</b><br>The aspect ratio is automatically adjusted.<br><b>■ For a signal from the COMPONENT VIDEO ports</b><br>The vertical position, horizontal position and aspect ratio are automatically adjusted. The horizontal phase is also automatically adjusted except for 525i (480i), 625i (576i) and SCART RGB signals.<br><b>■ For a signal from the S-VIDEO or VIDEO port</b><br>The video format best suited for the respective input signal is automatically selected. This function is available only when the VIDEO FORMAT item in the INPUT menu (46) is set to AUTO. The vertical position, horizontal position and aspect ratio are automatically adjusted.<br>- NOTE -<br>• The automatic adjustment operation takes approximately 10 seconds. Automatic adjustment may not function correctly with some input signals. |

## INPUT menu

The following functions are accessible via the INPUT menu. After selecting an item according to the procedure described in the preceding "Advanced Menu operation" section (35), refer to the following table for details on operating the selected item.

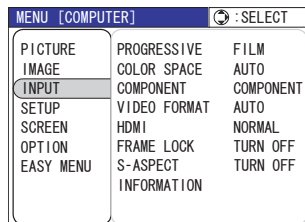

| Item        | Description   |
|-------------|---|
| PROGRESSIVE | <p>Using the ▲/▼ cursor buttons in the PROGRESSIVE menu changes the interpolation mode of an interlaced signal.</p> <p><b>TV ⇄ FILM ⇄ TURN OFF</b></p> <p>↑</p> <ul style="list-style-type: none"> <li>■ <b>TV</b><br/>This mode makes the screen image crisper.</li> <li>■ <b>FILM</b><br/>This mode makes the screen image crisper, and this mode can also be adapted to the 3-2 Pull-Down system.</li> </ul> <p><b>- NOTE -</b></p> <ul style="list-style-type: none"> <li>• The PROGRESSIVE function can only be used for interlaced video, s-video, or component video 525i (480i) or 625i (576i) 1125i (1080i) signals.</li> <li>• The TV and FILM modes may cause certain picture defects (ex., jagged lines). If this occurs, select TURN OFF, although the screen image may lose its crispness.</li> </ul> |
| COLOR SPACE | <p>Using the ▲/▼ cursor buttons changes the color space mode.</p> <p><b>AUTO ⇄ RGB ⇄ SMPTE240 ⇄ REC709 ⇄ REC601</b></p> <p>↑</p> <ul style="list-style-type: none"> <li>■ <b>AUTO</b><br/>Automatically selects an optimum mode.</li> <li>■ <b>RGB, SMPTE240, REC709, REC601</b><br/>The selected color space is used.</li> </ul> <p><b>- NOTE -</b></p> <ul style="list-style-type: none"> <li>• The COLOR SPACE function can only be used for signals from the COMPUTER, HDMI or COMPONENT VIDEO ports excluding component video 525i (480i) or 625i (576i), or SCART RGB signals.</li> <li>• The AUTO mode may not work well for some signals. In this situation select a suitable mode other than AUTO.</li> </ul>  |

(Continued on next page)



| Item        | Description   |
|-------------|---|
| S-ASPECT    | <p>Using the ▲/▼ cursor buttons turns the S-ASPECT function on and off.</p> <p><b>TURN ON ⇔ TURN OFF</b></p> <p>When the S-ASPECT function is enabled S2-video signals can be detected and an optimum aspect ratio automatically selected.</p> <p><b>- NOTE -</b></p> <ul style="list-style-type: none"> <li>• When the ASPECT button on the remote control is used or the ASPECT item in the IMAGE menu (  43 ) is used, this item is automatically disabled.</li> </ul>  |
| INFORMATION | <p>This function is performed as soon as the ► cursor button is pressed to select this item. It displays the INFORMATION dialog that shows the currently selected signal input.</p> <p><b>Example for computer (RGB) signals</b></p> <div style="display: flex; justify-content: space-around;"> <div style="border: 1px solid black; padding: 5px; width: 30%;">◀ INPUT - INFORMATION<br/>COMPUTER<br/>1024x768 @85</div> <div style="border: 1px solid black; padding: 5px; width: 30%;">◀ INPUT - INFORMATION<br/>COMPUTER<br/>1024x768 @60<br/>FRAME LOCK</div> <div style="border: 1px solid black; padding: 5px; width: 30%;">◀ INPUT - INFORMATION<br/>COMPUTER<br/>1080i @60</div> </div> <p><b>Example for an HDMI signal</b></p> <div style="display: flex; justify-content: space-around;"> <div style="border: 1px solid black; padding: 5px; width: 45%;">◀ INPUT - INFORMATION<br/>HDMI<br/>1920x1080i @60</div> <div style="border: 1px solid black; padding: 5px; width: 45%;">◀ INPUT - INFORMATION<br/>HDMI<br/>1920x1080i @60<br/>FRAME LOCK</div> </div> <p><b>Example for a video, s-video and component video signal</b></p> <div style="display: flex; justify-content: space-around;"> <div style="border: 1px solid black; padding: 5px; width: 30%;">◀ INPUT - INFORMATION<br/>VIDEO<br/>NTSC<br/>AUTO</div> <div style="border: 1px solid black; padding: 5px; width: 30%;">◀ INPUT - INFORMATION<br/>S-VIDEO<br/>PAL<br/>AUTO</div> <div style="border: 1px solid black; padding: 5px; width: 30%;">◀ INPUT - INFORMATION<br/>COMPONENT<br/>1080i @60</div> </div> <p><b>Example for a SCART RGB signal</b></p> <div style="border: 1px solid black; padding: 5px; width: 30%; margin-left: auto; margin-right: auto;">◀ INPUT - INFORMATION<br/>COMPONENT<br/>576i @50<br/>SCART RGB</div> <p><b>- NOTE -</b></p> <ul style="list-style-type: none"> <li>• The INFORMATION function cannot be used when there is no signal.</li> </ul> |

## SETUP menu

The following functions are accessible via the SETUP menu. After selecting an item according to the procedure described in the preceding "Advanced Menu operation" section (35), refer to the following table for details on operating the selected item.

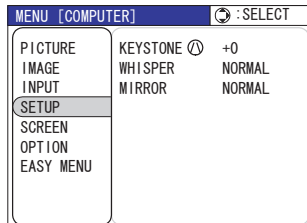

| Item     | Description  |
|----------|--|
| KEYSTONE | <p>Using the ▲/▼ cursor buttons adjusts the vertical keystone. Please make adjustments while checking the picture.</p> <p><b>Reduce top of the image ⇔ Reduce bottom of the image</b></p> <p><b>- NOTE -</b></p> <ul style="list-style-type: none"> <li>The adjustable correction range will vary among different inputs. This function may not work well for some types of input.</li> <li>This function may not work well if the projector screen is angled up or down and the MIRROR item (33 Below) in the SETUP sub-menu is set to V:INVERT or H&amp;V:INVERT.</li> </ul> |
| WHISPER  | <p>Using the ▲/▼ cursor buttons turns the WHISPER function on and off.</p> <p><b>NORMAL ⇔ WHISPER</b></p> <p>When WHISPER is selected, acoustic noise and screen brightness are reduced. It may take several minutes for the change in brightness to occur.</p> <p><b>- NOTE -</b></p> <ul style="list-style-type: none"> <li>The WHISPER function cannot be used for several minutes after the projector lamp first lights up.</li> </ul>   |
| MIRROR   | <p>Using the ▲/▼ cursor buttons changes the mirror mode.</p> <div style="text-align: center;"> <p><b>NORMAL ⇔ H:INVERT ⇔ V:INVERT ⇔ H&amp;V:INVERT</b></p> <p style="text-align: center;">↑—————↑</p> </div> <p><b>- NOTE -</b></p> <ul style="list-style-type: none"> <li>The MIRROR function can also be accessed via the EASY MENU (33).</li> </ul>   |



## SCREEN menu

The following functions are accessible via the SCREEN menu. After selecting an item according to the procedure described in the preceding "Advanced Menu operation" section (☐35), refer to the following table for details on operating the selected item.

| MENU [COMPUTER] |                 | :SELECT  |
|-----------------|-----------------|----------|
| PICTURE         | LANGUAGE        | ENGLISH  |
| IMAGE           | MENU POSITION   |          |
| INPUT           | OSD BRIGHT.     | 5        |
| SETUP           | START UP        | ORIGINAL |
| <b>SCREEN</b>   | MyScreen        |          |
| OPTION          | MyScreen Lock   | TURN OFF |
| EASY MENU       | MESSAGE         | TURN ON  |
|                 | DIGITAL SHUTTER | TURN ON  |

ENGLISH

| Item          | Description   |
|---------------|---|
| LANGUAGE      | <p>Using the ▲/▼ cursor buttons changes the display language.</p> <p><b>ENGLISH ⇔ FRANÇAIS ⇔ DEUTSCH ⇔ ESPAÑOL</b></p> <p><b>ITALIANO ⇔ NORSK ⇔ NEDERLANDS ⇔ PORTUGUÊS</b></p> <p><b>日本語 ⇔ 简体中文 ⇔ 繁體中文 ⇔ 한글</b></p> <p><b>SVENSKA ⇔ РУССКИЙ ⇔ SUOMI ⇔ POLSKI ⇔ TÜRKÇE</b></p> <p>- NOTE -</p> <ul style="list-style-type: none"> <li>The LANGUAGE function can also be accessed via the EASY MENU (☐34).</li> </ul> |
| MENU POSITION | <p>Using the ▲/▼/◀/▶ cursor buttons adjusts the menu position. Please make adjustments while checking the picture.</p> <p>- NOTE -</p> <ul style="list-style-type: none"> <li>Pressing the MENU button closes the dialog and returns to the SCREEN menu. Not operating the menu for about 50 seconds closes merely the dialog.</li> </ul>   |
| OSD BRIGHT.   | <p>Using the ▲/▼ cursor buttons adjusts the brightness of the OSD. (OSD = On-Screen Display and refers to menus and dialogs.)</p> <p><b>Bright ⇔ Dark</b></p>   |

(Continued on next page)



| Item          | Description  |
|---------------|--|
| MyScreen Lock | <p>Using the ▲/▼ cursor buttons turns the MyScreen Lock function on and off.</p> <p style="text-align: center;"><b>TURN ON ⇔ TURN OFF</b></p> <p>When TURN ON is selected the MyScreen function is locked. Use this feature to protect the current MyScreen image.</p>   |
| MESSAGE       | <p>Using the ▲/▼ cursor buttons turns the MESSAGE function on and off.</p> <p style="text-align: center;"><b>TURN ON ⇔ TURN OFF</b></p> <p>When TURN ON is selected, the following messages will be displayed. When you want to hide messages, select TURN OFF.</p> <ul style="list-style-type: none"> <li>■ The adjustment dialog that is displayed when the BRIGHTNESS, CONTRAST or COLOR is adjusted using the BRIGHTNESS, CONTRAST or COLOR buttons on the remote control</li> <li>■ The dialogue that is displayed when the BLACK mode is changed using the BLACK button on the remote control</li> <li>■ The dialogue that is displayed when the MODE is changed using the MODE button on the remote control</li> <li>■ The "AUTO IN PROGRESS" message displayed during automatic adjustment</li> <li>■ The "NO INPUT IS DETECTED" message displayed when no input is detected</li> <li>■ The "SYNC IS OUT OF RANGE" message displayed when an improper input is detected</li> <li>■ The "Detecting..." message displayed when the projector is detecting an input signal</li> <li>■ The dialogue that is displayed when the input signal has been changed</li> <li>■ The dialogue that is displayed when the aspect ratio has been changed</li> </ul> |



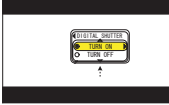
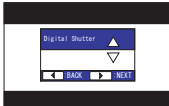
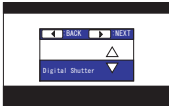

(Continued on next page)

| Item            | Description   |
|-----------------|---|
| DIGITAL SHUTTER | <p>Using the ▲/▼ cursor buttons turns the DIGITAL SHUTTER function on and off.</p> <p><b>TURN ON ⇔ TURN OFF</b></p> <p>When TURN ON is selected, the black bars displayed mask the top and bottom of the screen, like a shutter. Use this function when you want to mask the top and bottom of the screen. Follow the procedure below to move the bars up and down.</p> <p><b>To move the black bars up and down</b></p> <ol style="list-style-type: none"> <li>(1) Select TURN ON in the DIGITAL SHUTTER menu, then press the ► cursor button. The DIGITAL SHUTTER dialog will appear.</li> <li>(2) Using the ◀/▶ cursor buttons switches between the dialogs</li> </ol> <div style="text-align: center;">  <p>↵ <b>DIGITAL SHUTTER menu</b> ↵ (one way)<br/> <b>Dialog for the top bar</b> ⇔ <b>Dialog for the bottom bar</b></p> <div style="display: flex; justify-content: space-around;"> <div style="text-align: center;">  </div> <div style="text-align: center;">  </div> </div> <ol style="list-style-type: none"> <li>(3) Using the ▲/▼ cursor buttons in the dialogs moves the corresponding bar up or down. Note that the total height of the bars is limited.</li> </ol> </div> |

## OPTION menu

The following functions are accessible via the OPTION menu. After selecting an item according to the procedure described in the preceding "Advanced Menu operation" section (☞35), refer to the following table for details on operating the selected item.

| MENU [COMPUTER] |             | :SELECT |
|-----------------|-------------|---------|
| PICTURE         | AUTO OFF    | 0 min   |
| IMAGE           | LAMP TIME   | 0 h     |
| INPUT           | FILTER TIME | 0 h     |
| SETUP           | SERVICE     |         |
| SCREEN          |             |         |
| <b>OPTION</b>   |             |         |
| EASY MENU       |             |         |

| Item        | Description  |
|-------------|--|
| AUTO OFF    | <p>Using the ▲/▼ cursor buttons adjusts the amount of time after which the projector off is automatically turned off.</p> <p><b>Long (max. 99 min.) ⇔ Short (min. 0 min.)</b></p> <div style="display: flex; justify-content: space-around;">   </div> <p>If no signal or an unsuitable signal is detected for the time set on this menu, the projector lamp will turn off and the power indicator will blink orange.</p> <p>Please see "Turning the power off" (☞23) to complete the process.</p>   |
| LAMP TIME   | <p>LAMP TIME is displayed in the OPTION menu as a reference value of the usage time of the lamp. The time displayed is the total time the lamp has been used since the LAMP TIME was last reset.</p> <p>Only reset the LAMP TIME item when you have replaced the lamp so that the LAMP TIME remains accurate.</p> <p>Pressing the ▲ cursor button in the LAMP TIME menu resets the LAMP TIME.</p> <div style="text-align: right;">  </div> <p><b>RESET ⇔ CANCEL</b></p> <p><b>- NOTE -</b></p> <ul style="list-style-type: none"> <li>• Please see "Lamp" (☞57) for information on lamp replacement.</li> </ul>  |
| FILTER TIME | <p>FILTER TIME is displayed in the OPTION menu as a reference value of the usage time of the air filter. The time displayed is the total time the filter has been used since the FILTER TIME was last reset.</p> <p>Only reset the FILTER TIME item when you have cleaned or replaced the air filter so that the FILTER TIME remains accurate.</p> <p>Pressing the ▲ cursor button in the FILTER TIME menu resets the FILTER TIME.</p> <div style="text-align: right;">  </div> <p><b>RESET ⇔ CANCEL</b></p> <p><b>- NOTE -</b></p> <ul style="list-style-type: none"> <li>• Please see "Air filter" (☞58) for information on cleaning and replacing the air filter.</li> <li>• The FILTER MESSAGE that prompts you to clean the air filter "REMINDER..." is displayed based on the FILTER TIME value. Please reset the FILTER TIME when the filter is cleaned or changed so that the message displays correctly.</li> </ul> |

(Continued on next page)



| Item                             | Description   |
|----------------------------------|---|
| <p>Continuation of "SERVICE"</p> | <p>(Continuation of "STRIPE".)</p> <p><b>- NOTE -</b></p> <ul style="list-style-type: none"> <li>• KEYSTONE cannot be adjusted while using the STRIPE .function.</li> </ul> <p><b>FILTER MESSAGE</b></p> <p>Using the ▲/▼ cursor buttons changes the amount of time til the projector will display the filter message ("REMINDER...") (🔑61) that prompts you to clean the air filter.</p> <div data-bbox="938 280 1031 389" style="border: 1px solid black; padding: 2px;"> <p>ⓧ FILTER MESSAGE</p> <p><input type="radio"/> 50h</p> <p><input checked="" type="radio"/> 100h</p> <p><input type="radio"/> 200h</p> <p><input type="radio"/> 300h</p> <p><input type="radio"/> TURN OFF</p> </div> <p style="text-align: center;"><b>50h ⇔ 100h ⇔ 200h ⇔ 300h ⇔ TURN OFF</b></p> <p>When 50h, 100h, 200h or 300h is selected, the filter message will appear after the FILTER TIME (🔑53) has reached the selected time.</p> <p>Choosing TURN OFF in the FILTER MESSAGE menu displays a confirmation dialog. Note that the filter message will not appear when TURN OFF is selected.</p> <div data-bbox="863 528 1020 635" style="border: 1px solid black; padding: 2px;"> <p><b>FILTER MESSAGE</b></p> <p>ARE YOU SURE YOU WISH TO DISABLE WARNING?<br/>FAILURE TO CLEAN THE FILTER MAY RESULT IN<br/>DAMAGE TO THE PROJECTOR</p> <p>SEE MANUAL FURTHER INFO</p> <p>RESET : NO    EXECUTE : YES</p> </div> <p>Pressing the ENTER button selects TURN OFF.</p> <p>If you want to change the selection, press the RESET button while the dialog is displayed to return to the FILTER MESSAGE menu.</p> <p><b>- NOTE -</b></p> <ul style="list-style-type: none"> <li>• Check and clean the air filter periodically, even if no message is displayed. If the air filter becomes blocked by dust or other debris, the internal temperature will rise, which could cause projector malfunction, or reduce the lifetime of the projector.</li> <li>• Please be careful of the operating environment of the projector and the condition of the air filter, especially when the 200h, 300h or TURN OFF options are selected.</li> </ul> <p><b>FACTORY RESET</b></p> <p>This projector has a FACTORY RESET function to re-initialize all user settings simultaneously. Except where the current setting is always considered the default setting (LANGUAGE, MyScreen Lock, LAMP TIME, FILTER TIME etc.)</p> <p>Pressing the ▲ cursor button in the FACTORY RESET menu performs a FACTORY RESET.</p> <div data-bbox="871 938 1023 1050" style="border: 1px solid black; padding: 2px;"> <p><b>SERVICE</b></p> <p>FANSPEED    NORMAL</p> <p>AUTO ADJUST    ENABLE</p> <p>GHOST</p> <p>STRIPE</p> <p>FILTER MESSAGE 100h</p> <p>FACTORY RESET    EXECUTE ▶</p> </div> <p style="text-align: center;">↓</p> <div data-bbox="897 1110 992 1171" style="border: 1px solid black; padding: 2px;"> <p>FACTORY RESET</p> <p>RESET</p> <p>CANCEL</p> </div> <p style="text-align: center;"><b>RESET ⇔ CANCEL</b></p> |

## Maintenance

## Lamp

**WARNING**

HIGH VOLTAGE



HIGH TEMPERATURE



HIGH PRESSURE

► The projector uses a high-pressure mercury glass lamp. The lamp can break with a loud bang, or burn out, if jolted or scratched, handled while hot, or worn over time. Note that each lamp has a different lifetime, and some may burst or burn out soon after you start using them. In addition, when the bulb bursts, it is possible for shards of glass to fly into the lamp housing, and for gas containing mercury to escape from the projector's vent holes.

► **About disposal of a lamp** • This product contains a mercury lamp; do not put it in a trash. Dispose of it in accordance with environmental laws.

For lamp recycling, go to [www.lamprecycle.org](http://www.lamprecycle.org). (in the US)

For product disposal, contact your local government agency or [www.eiae.org](http://www.eiae.org) (in the US) or [www.epsc.ca](http://www.epsc.ca) (in Canada).

For more information, call your dealer.



Disconnect  
the plug  
from the  
power  
outlet

- If the lamp should break (it will make a loud bang when it does), unplug the power cord from the outlet, and make sure to request a replacement lamp from your local dealer. Note that shards of glass could damage the projector's internals, or cause injury during handling, so please do not try to clean the projector or replace the lamp yourself.

- If the lamp should break (it will make a loud bang when it does), ventilate the room well, and make sure not to breathe the gas that comes out of the projector vents, or get it in your eyes or mouth.

- Before replacing the lamp, turn the projector off and unplug the power cord, then wait at least 45 minutes for the lamp to cool sufficiently. Handling the lamp while hot can cause burns, as well as damaging the lamp.



- Never unscrew except the appointed (marked by an arrow) screws.
- Do not open the lamp cover while the projector is suspended from above. This is dangerous, since if the lamp's bulb has broken, the shards will fall out when the cover is opened. In addition, working in high places is dangerous, so ask your local dealer to have the lamp replaced even if the bulb is not broken.

- Do not use the projector with the lamp cover removed. At the lamp replacing, make sure that the screws are screwed in firmly. Loose screws could result in damage or injury.



- Use only the lamp of the specified type.
- If the lamp breaks soon after the first time it is used, it is possible that there are electrical problems elsewhere besides the lamp. If this happens, contact your local dealer or a service representative.

- Handle with care: jolting or scratching could cause the lamp bulb to burst during use.

- Using the lamp for long periods of time, could cause it dark, not to light up or to burst. When the pictures appear dark, or when the color tone is poor, please replace the lamp as soon as possible. Do not use old (used) lamps; this is a cause of breakage.



A lamp has a finite product life. Using the lamp for long periods of the time could cause the picture to become darker or the color tone to become poor. Note that each lamp has a different lifetime, and some may burst or burn out soon after you start using them.

Preparation of a new lamp and early replacement are recommended. To purchase a new lamp, contact your dealer and tell the lamp type number = **DT00665**.

1. Turn the projector off, and unplug the power cord. Allow the projector to cool for at least 45 minutes.
2. Prepare a new lamp. If the projector is mounted on the ceiling, or if the lamp has broken, ask the dealer to replace the lamp.

### Replacing the lamp by yourself

3. After making sure that the projector has adequately cooled, slowly turn the projector over so that the bottom is facing up.
4. Loosen the lamp cover screw (marked by the arrow), then slide and lift the lamp cover.
5. Loosen the 2 lamp screws (marked by the arrow), and slowly lift the lamp by the handles. Be careful when handling the lamp. Breaking the lamp could cause injury and the release of gas containing mercury.
6. Insert the new lamp, and retighten the screws that were loosened in the previous step to lock it in place.
7. Slide the lamp cover into place, and retighten the lamp cover screw loosened in step 4.
8. Please reposition and reconnect the projector (📖 12-17). Then turn the projector on (📖 20).
9. Reset the LAMP TIME in the OPTION menu (📖 53).
  - (1) Press the MENU button to display a menu. If you are using the Advanced Menu skip the next step (2).
  - (2) To switch from the EASY MENU to the Advanced Menu, select the “Go To the Advanced Menu ...” item in the EASY MENU using the ▲/▼ cursor buttons, then press the ► cursor button. The Advanced Menu will appear.
  - (3) Select the “OPTION” item in the left column of the Advanced Menu using the ▲/▼ cursor buttons then press the ► cursor button.

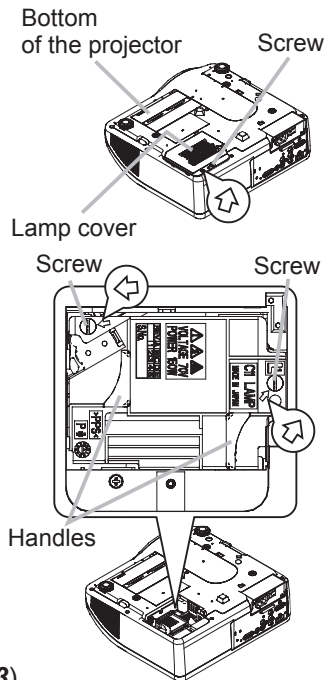

- (4) Select the “LAMP TIME” item in the right column of the Advanced Menu using the ▲/▼ cursor buttons, then press the ► cursor button and the LAMP TIME menu will appear.
- (5) Pressing the ▲ cursor button in the menu resets the LAMP TIME.

**NOTE** • Only reset the LAMP TIME item when you have replaced the lamp so that the LAMP TIME remains accurate.

## Air filter

If the air filter becomes clogged by dust or the like, internal temperatures will rise and could cause fire, burn and/or projector malfunction. When the indicators or a message prompts you to clean the air filter, make sure to clean it as soon as possible. Check and clean the air filter periodically, even if no message is displayed.

Please replace the air filter when it is damaged or too dirty to be cleaned.

Preparation of a new air filter is recommended. To purchase a new air filter, contact your dealer and tell the air filter type number = **NJ22632**.

Replace the air filter when the lamp is replaced. An air filter of the specified type will be included with replacement lamps for this projector.

1. Turn the projector off, and unplug the power cord. Allow the projector to sufficiently cool down.
2. After making sure that the projector has cooled adequately, remove the filter cover and air filter. Hold the knobs while lifting.
3. Use a vacuum cleaner to clean the air filter vent, the air filter and filter cover. Please replace the air filter when it is damaged or too dirty to be cleaned.

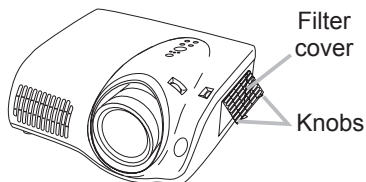

3. Use a vacuum cleaner to clean the air filter vent, the air filter and filter cover. Please replace the air filter when it is damaged or too dirty to be cleaned.

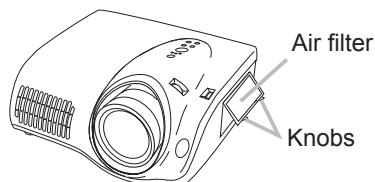

4. Set the cleaned or new air filter into place, and press the point between the 2 knobs.
5. Turn the projector on (📖 20).

6. Reset the FILTER TIME in the OPTION menu (📄53).
- (1) Press the MENU button to display a menu.  
If you are using the Advanced Menu skip the next step (2).
  - (2) To switch from the EASY MENU to the Advanced Menu, select the “Go To the Advanced Menu ...” item in the EASY MENU using the ▲/▼ cursor buttons, then press the ► cursor button. The Advanced Menu will appear.
  - (3) Select the “OPTION” item in the left column of the Advanced Menu using the ▲/▼ cursor buttons then press the ► cursor button.
  - (4) Select the “FILTER TIME” item in the right column of the Advanced Menu using the ▲/▼ cursor buttons, then press the ► cursor button and the FILTER TIME menu will appear.
  - (5) Pressing the ▲ cursor button in the menu resets the FILTER TIME.

**⚠ WARNING** ► Do not maintain the projector during or immediately after use. Handling while the projector is hot could cause burn and/or projector malfunction. Before maintaining, make sure that the power switch is off, that the power cord is unplugged, and that the projector is adequately cool.

► Use only the specified air filter type. Do not use the projector with the air filter or the filter cover removed. Doing so could cause fire and/or projector malfunction.

► The air filter should be cleaned periodically. If the air filter becomes blocked by dust or other debris, the internal temperature will rise, which could cause burns, fire and/or projector malfunction, or reduce the lifetime of the projector.

**NOTE** • Please replace the air filter when it is damaged or too dirty to be cleaned, and also when the lamp is replaced.

• Only reset the FILTER TIME item when you have cleaned or replaced the air filter so that the FILTER TIME remains accurate (📄53).

• The projector may display the message “CHECK THE AIR FLOW” or automatically turn the power off in order to prevent the internal heat level from rising.

## Inside of the projector

In order to ensure the safety of your projector, please have it cleaned and inspected by your dealer about once a year.

### Lens

In order to ensure the safety of your projector, please have it cleaned and inspected by your dealer about once a year.

If the lens is flawed, dirty or fogged, it could cause deterioration of display quality. Take special care of the lens and handle it carefully.

1. Turn the projector off, and unplug the power cord. Allow the projector to sufficiently cool down.
2. After making sure that the projector has adequately cooled, lightly wipe the lens with a commercially available lens-cleaning wipe. Do not touch the lens directly with your hand.

### Cabinet and Remote control

Incorrect care could cause discoloration, peeling, etc.

1. Turn the projector off, and unplug the power cord. Allow the projector to sufficiently cool down.
2. After making sure that the projector has adequately cooled, lightly wipe with gauze or a soft cloth. If the projector is extremely dirty, dip a soft cloth in water or a neutral cleaner diluted in water, wring well, and wipe the projector lightly. Then, wipe lightly with a soft, dry cloth.

**⚠ WARNING** ► Do not maintain the projector during or immediately after use. Handling while the projector is hot could cause burn and/or projector malfunction. Before maintaining, make sure that the power switch is off, that the power cord is unplugged, and that the projector is adequately cool.

► Never try to maintain the inside of the projector yourself. Doing is so dangerous.

► Do not get the projector wet or insert liquids into the projector. It could result in fire, electric shock, and/or projector malfunction.

- Do not place anything containing liquid near the projector.
- Do not use aerosols or sprays on the projector.

**⚠ CAUTION** ► Properly maintain the projector according to the following. Incorrect care could cause injury, and/or discoloration, peeling, etc.

- Do not use cleaners or chemicals other than those specified in this manual.
- Do not polish or wipe the projector with hard objects.

## Troubleshooting

### Related messages

When the projector is turned on, the following messages may be displayed. When any such message is displayed on the screen, please follow the instructions described below. If the same message is displayed after trying the solutions below, or if a message other than the following appears, please contact your dealer or service company.

Although these messages will be automatically disappear after several minutes, they will reappear every time the power is turned on.

| Message   | Description   |
|---|---|
| <p><b>NO INPUT IS DETECTED</b><br/>ON ***</p>   | <p><b>There is no input signal.</b><br/>Please confirm the input signal connection, and the status of the signal source.</p>  |
| <p><b>SYNC IS OUT OF RANGE</b><br/>ON *** [fH] *****kHz [fV] *****Hz</p>  | <p><b>The horizontal or vertical wavelength of the input signal is out of the response parameter range of this projector.</b><br/>Please confirm the specs for the projector and the signal source specs.</p>   |
| <p><b>CHECK THE AIR FLOW</b></p>  | <p><b>The internal temperature is high.</b><br/>Please turn the power off, and allow the projector to cool down for at least 20 minutes. After confirming the following items, please turn the power on again.</p> <ul style="list-style-type: none"> <li>• Is there blockage of the air passage aperture?</li> <li>• Is the air filter dirty?</li> <li>• Does the peripheral temperature exceed 35°C?</li> </ul> <p>If the same indication is displayed after trying the solutions above, please set the FAN SPEED of the SERVICE item in the OPTION menu to HIGH (🔗54).</p> |
| <p><b>REMINDER</b><br/><b>*** HRS PASSED AFTER THE LAST FILTER CHECK. FILTER MAINTENANCE IS ESSENTIAL TO REMOVE WARNING MESSAGE, RESET FILTER TIMER.</b><br/><b>SEE MANUAL FURTHER INFO</b></p> | <p><b>A note of precaution when cleaning the air filter.</b><br/>Please immediately turn the power off, and clean or change the air filter, according to the directions in “Air filter” (🔗58). After you have cleaned or changed the air filter, please be sure to reset the FILTER TIME (🔗53).</p>   |

## Regarding the indicator lamps

The meanings of the lighting patterns of the POWER indicator, the LAMP indicator, and the TEMP indicator are described in the table below. Please follow the instructions within the table. If the same indication is displayed after trying the solutions below, or if an indication other than the following appears, please contact your dealer or service company.

| POWER indicator   | LAMP indicator       | TEMP indicator       | Description   |
|---|----------------------|----------------------|---|
| Lit In<br><b>Orange</b>                                       | Turned<br><b>off</b> | Turned<br><b>off</b> | <b>The projector is in a standby state.</b><br>Please refer to the “Turning the power on” (📖20) and “Turning the power off” (📖23).  |
| <i>Blinking</i><br><b>Green</b>                               | Turned<br><b>off</b> | Turned<br><b>off</b> | <b>The projector is warming up.</b><br>Please wait.   |
| Lit In<br><b>Green</b>  | Turned<br><b>off</b> | Turned<br><b>off</b> | <b>The projector is on and ready.</b><br>Ordinary operations may be performed.  |
| <i>Blinking</i><br><b>Orange</b>                              | Turned<br><b>off</b> | Turned<br><b>off</b> | <b>The projector is cooling down.</b><br>Please wait.   |
| <i>Blinking</i><br><b>Red</b>                                 | (varies)             | (varies)             | <b>The projector is cooling down. An error has been detected.</b><br>Please wait until the POWER indicator finishes blinking, and then try the suggested solution, referring to the following error descriptions.   |
| <i>Blinking</i><br><b>Red</b><br>or<br>Lit In<br><b>Green</b> | Lit In <b>Red</b>    | Turned<br><b>off</b> | <b>The lamp will not light, and there is a possibility that interior of the projector has overheated.</b><br>Please turn the power off, and allow the projector to cool down for at least 20 minutes. After the projector has cooled down sufficiently, please confirm the following items, and then turn the power on again.<br><ul style="list-style-type: none"> <li>• Is there blockage of the air passage aperture?</li> <li>• Is the air filter dirty?</li> <li>• Does the peripheral temperature exceed 35°C?</li> </ul> If the same indication is displayed after trying the solutions above, please change the lamp according to the directions in “Lamp” (📖56, 57). |

(Continued on next page)

Regarding the indicator lamps (continued)

| POWER indicator                  | LAMP indicator                 | TEMP indicator | Description   |
|----------------------------------|--------------------------------|----------------|---|
| Blinking Red<br>or<br>Lit In Red | Turned off                     | Blinking Red   | <p><b>The cooling fan is not operating.</b><br/>Please turn the power off, and allow the projector to cool down for at least 20 minutes. After the projector has cooled down sufficiently, please confirm the following items, and then turn the power on again.</p> <ul style="list-style-type: none"> <li>• Are any foreign objects caught in the fan?</li> <li>• Are there any magnetic objects on or near the projector?</li> </ul> <p>Please ensure that installation configuration/usage of the projector does not allow any foreign materials to be caught, or disrupt the rotation of the cooling fans.</p>   |
| Blinking Red<br>or<br>Lit In Red | Turned off                     | Lit In Red     | <p><b>There is a possibility that the interior of the projector has overheated.</b><br/>Please turn the power off, and allow the projector to cool down for at least 20 minutes. After the projector has cooled down sufficiently, please confirm the following items, and then turn the power on again.</p> <ul style="list-style-type: none"> <li>• Is there blockage of the air passage aperture?</li> <li>• Is the air filter dirty?</li> <li>• Does the peripheral temperature exceed 35°C?</li> </ul> <p>If the same indication is displayed after trying the solutions above, please set the FAN SPEED of the SERVICE item in the OPTION menu to HIGH (📖54).</p> |
| Lit In Green                     | Alternative blinking Red       |                | <p><b>There is a possibility that the interior of the projector has become too cool.</b><br/>Please use the projector within the usage temperature parameters (5°C to 35°C). After applying the solution set the power switch to ON.</p>  |
| Lit In Green                     | Simultaneously blinking in Red |                | <p><b>It is time to clean the air filter.</b><br/>Please turn the power off immediately, and clean or change the air filter referring to the “Air Filter” (📖58) section. After cleaning or changing the air filter, please be sure to reset the filter timer. After applying the solution set the power switch to ON.</p>   |

**NOTE** • When the interior of the projector overheats, the power source is automatically turned off for safety purposes, and the indicator lamps may also be turned off. If this occurs, set the power switch to the “O” (OFF) position, and wait at least 45 minutes. After the projector has cooled down sufficiently, please confirm that the lamp and lamp cover are properly fastened, and then turn the power on again.

## Phenomena that may be easily mistaken as machine defects

Before requesting repair, please check the following chart. This will sometimes provide a solution to your problem.

If a situation cannot be resolved, the projector's microprocessor may need to be reset, or settings may be incorrect.

- To reset the microprocessor, turn the projector off once, and turn it on again (☞20). If the projector cannot be turned off, use the restart switch.

Pressing the restart switch using a pin or similar object will restart the projector (☞7, 23).

- To reset all settings to the factory default, please use the FACTORY RESET item in the SERVICE menu which is in the OPTION menu (☞55).

If the problem is not solved after performing maintenance, please contact your dealer or service company.

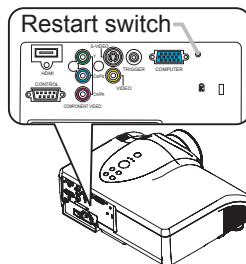

**⚠ WARNING** ► Never use the projector if there is any abnormality such as smoke, strange odor, excessive noise, damaged casing, elements or cables, penetration of liquids or foreign matter, etc. In such cases, immediately turn the power off and then disconnect the power plug from the power outlet. After making sure that the smoke or odor has stopped, contact your dealer or service company.

| Phenomenon              | Cases not involving a machine defect  |
|-------------------------|---|
| Power does not come on. | <b>The electrical power cord is not plugged in.</b><br>Correctly connect the power cord (☞17).  |
|                         | <b>The power switch is not set to the on position.</b><br>Set the power switch to [   ] (On position) (☞20).  |
|                         | <b>The main power source has been interrupted during operation by a power outage (blackout), etc.</b><br>Please turn the power off (☞23), and allow the projector to cool down for at least 20 minutes.<br>After the projector has cooled down sufficiently, please turn the power on again (☞20).                                |
|                         | <b>Either the lamp or lamp cover has not been properly fastened.</b><br>Please turn the power off (☞23), and allow the projector to cool down for at least 45 minutes.<br>After the projector has sufficiently cooled down, confirm that the lamp and lamp cover are properly fastened (☞58). Then turn the power on again (☞20). |
| No pictures are output  | <b>The lens cover is closed.</b><br>Remove the lens cover (☞6).   |
|                         | <b>The signal cables are not correctly connected.</b><br>Correctly connect the connection cables (☞13-16).  |

(Continued on next page)



**Phenomena that may be easily mistaken for machine defects (continued)**

| Phenomenon   | Cases not involving a machine defect   |
|--|--|
| No pictures are output.                                    | <p><b>Signal source does not work correctly.</b><br/>Correctly set up the signal source device by referring to the manual for the source device.</p>   |
|  | <p><b>The brightness is adjusted to an extremely low level.</b><br/>Adjust the BRIGHTNESS (🔗27, 33, 37) to a higher level using the menu function or the remote control.</p>                   |
|  | <p><b>The computer cannot detect the projector as a plug and play monitor.</b><br/>Confirm that the computer can detect a plug and play monitor using another plug and play monitor (🔗16).</p> |
|  | <p><b>If the connected PC has a HDMI output, the driver software of the HDMI board is too old.</b><br/>Consult with your PC dealer to install new software.</p>                                |
|  | <p><b>The signal source cannot output both a HDMI signal and a VGA signal simultaneously.</b><br/>Disconnect the VGA connection when you use the HDMI input (🔗14, 15).</p>                     |
|  | <p><b>If the output signal can be selected on the PC, it is not selected properly.</b><br/>Check the settings. Select the digital output for HDMI connection.</p>                              |
| Colors have a faded-out appearance, or Color tone is poor. | <p><b>Color settings are not correctly adjusted.</b><br/>Perform picture adjustments by changing the COLOR TEMP (🔗39), COLOR (🔗27, 33, 40), TINT (🔗33, 40) and COLOR SPACE (🔗45).</p>          |
|  | <p><b>COLOR SPACE setting is not suitable.</b><br/>Change the COLOR SPACE (🔗45).</p>   |
| Pictures appear dark.                                      | <p><b>The brightness or contrast is adjusted to an extremely low level.</b><br/>Adjust the BRIGHTNESS (🔗27, 33, 37) and CONTRAST (🔗27, 33, 37) to a higher level.</p>                          |
|  | <p><b>The WHISPER function is enabled.</b><br/>Set the WHISPER item (🔗48) in the SETUP menu to normal.</p>   |
|  | <p><b>The lamp is approaching the end of its product lifetime.</b><br/>Replace the lamp (🔗53, 57).</p>   |
| Pictures appear blurry.                                    | <p><b>Either the focus or horizontal phase setting is not properly adjusted.</b><br/>Check and adjust the focus (🔗22), and H PHASE (🔗44).</p>  |
|  | <p><b>The lens is dirty or fogged.</b><br/>Clean the lens according to the directions in "Lens" (🔗60).</p>   |

(Continued on next page)

| Phenomenon                     | Cases not involving a machine defect   |
|--------------------------------|--|
| Flicker appears on the screen. | <p><b>AUTO1 or AUTO2 is selected for the BLACK mode.</b><br/>Please set the BLACK mode to TURN OFF using the BLACK button (🔵27) or the BLACK item in the PICTURE menu (🔵41).</p>   |
|                                | <p><b>The WHISPER function is working.</b><br/>The WHISPER function may cause screen flicker.<br/>Set the WHISPER item (🔵48) in the SETUP menu to NORMAL.</p>  |
| Projector is very noisy.       | <p><b>The fan speed has been automatically changed.</b><br/>When the ambient temperature is, the projector will automatically raise the cooling fan speed to keep the internal temperature stable.<br/>Lower the ambient temperature.<br/>If you want to reduce noise more, set the WHISPER item (🔵48) in the SETUP menu to WHISPER.</p> |

**NOTE** • Although bright spots, dark spots, uneven color or misconvergence may appear on the screen, these are common characteristics of liquid crystal displays, and do not constitute or imply a machine defect.

## Warranty and after-service

When a problem occurs with the equipment, first refer to “Troubleshooting” (62-66) and run through the suggested checks. If this does not resolve the problem, please contact your dealer or service company. They will tell you what warranty condition is applied.

## Specifications

| Item                 |              | Specification   |
|----------------------|--------------|---|
| Product name         |              | Liquid crystal projector  |
| Liquid crystal panel | Panel size   | 1.8 cm (0.7 Type)   |
|                      | Drive system | TFT active matrix   |
|                      | Pixels       | 921,600 pixels (1280 horizontal x 720 vertical)   |
| Lens                 |              | Zoom lens F=1.7 ~ 2.4 f = 20.0 ~ 31.9 mm  |
| Lamp                 |              | 150W UHB  |
| Power Supply         |              | AC100-120V/2.4A, AC220-240V/1.3A  |
| Power Consumption    |              | 220W  |
| Temperature range    |              | 5 ~ 35°C (Operating)  |
| Size                 |              | 340 (W) x 113 (H) x 299 (D) mm<br>(Not including protruding parts)  |
| Weight (mass)        |              | 4.7 kg  |
| Ports                |              | <b>RGB input port:</b><br>COMPUTER..... D-sub 15pin mini shrink jack x 1<br><b>Digital input port:</b><br>HDMI ..... HDMI connector x 1<br><b>Communication port:</b><br>CONTROL..... D-sub 9pin plug x 1<br><b>Video input port:</b><br>VIDEO ..... RCA jack x 1<br>S-VIDEO ..... Mini DIN 4pin jack x 1<br>COMPONENT VIDEO..... RCA jack x 3<br><b>Other port:</b><br>TRIGGER (12V/25mA)..... x 1 |
| Optional parts       | Lamp         | DT00665   |
|                      | Air filter   | NJ22632   |
|                      | Others       | • Please consult your dealer.   |

**NOTE** • These specifications are subject to change without notice.

## Dimension diagram

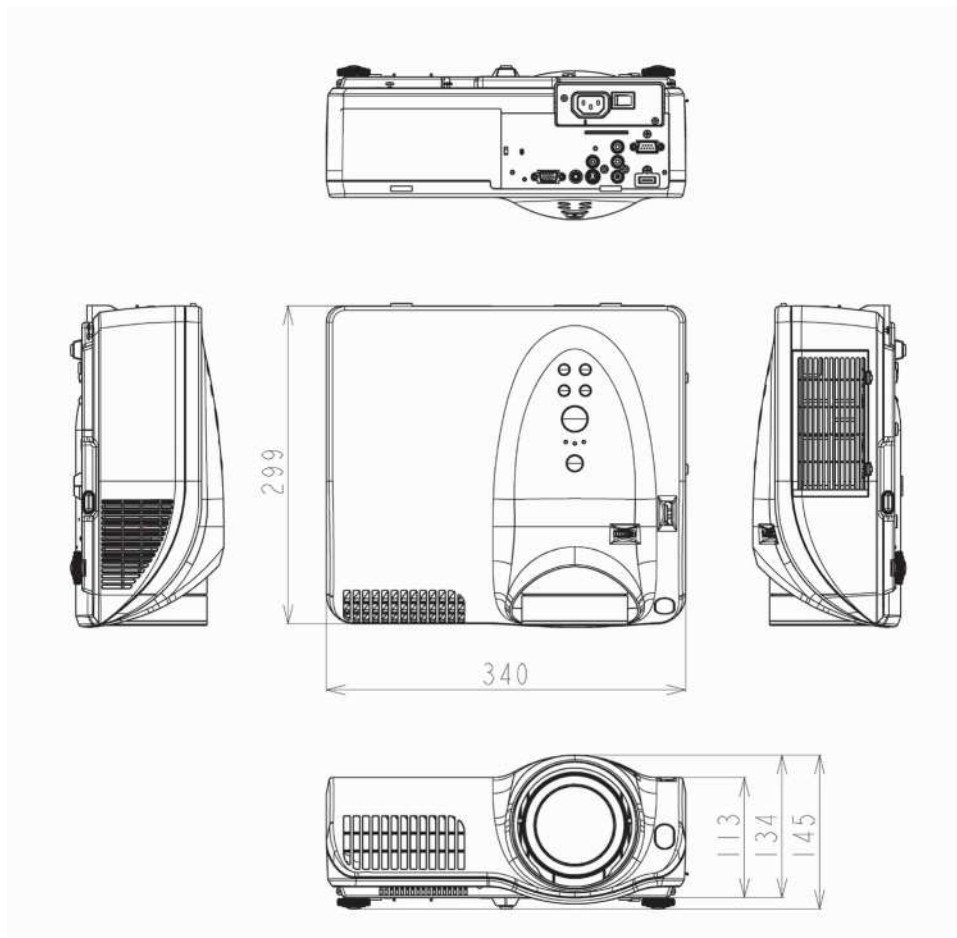

[unit: mm]

## Glossary

| Entry             | Explanation   | Page(s) in which the entry appears                |
|-------------------|---|---|
| 3-2 Pull-Down     | A system for converting a film source such as a movie into a video signal.  | 45  |
| Color space       | A standard for determining color value.   | 45  |
| Color temperature | A system for expressing a color of light<br>Refers to the luminance of white which a display device radiates. A higher color temperature expresses a more bluish color. A lower color temperature expresses a more reddish color. | 28, 39, 41  |
| Gamma             | In this manual, "Gamma" refers to a gamma characteristic that is the state of brightness and darkness between the white level and the black level.  | 28, 37, 41  |
| Ghost             | A phenomenon where a double image is displayed.<br>Generally caused by an RGB signal problem.   | 54  |
| HDMI              | HDMI stands for High Definition Multi-Media Interface which is an interface standard for transmission of digital images and audio signals.  | 1, 14, 15, 21, 24, 27, 31, 33, 40, 43, 44, 46, 47 |
| Interlaced        | Refers to interlaced scanning which is a system to scan twice alternately for one picture<br>↔ Progressive.   | 45  |
| Iris              | Refers to an iris diaphragm that is a mechanism to adjust the amount of light projected.  | 25, 27, 28, 41                                    |
| Keystone          | Trapezoidal image distortion. This manual refers to Keystone adjustment for the correction of trapezoidal image distortion caused by image projected onto a screen or wall which is not perpendicular to the projector lens.      | 48  |
| NTSC              | A standard for terrestrial analog broadcasting. Mainly adopted in Japan, North America, and South Korea.  | 46  |

(Continued on next page)

## Glossary

| Entry        | Explanation   | Page(s) in which the entry appears |
|--------------|---|------------------------------------|
| PAL          | A standard for terrestrial analog broadcasting. Mainly adopted in UK, Germany, China, Australia, et al.   | 46                                 |
| Progressive  | Refers to progressive scanning which is a system to scan in order.<br>↔ Interlaced  | 45                                 |
| RGB (signal) | Output image signaling that displays image based on three primary colors, Red, Green, and Blue. It is also called Analog RGB. Both D-sub 15 pin and BNC are connection types for RGB signals. | 15, 16, 24, 31, 43, 44, 46, 47     |
| S2-video     | A standard for signal interface. S2-video signals can include a signal of a 4:3 image, squeezed 16:9 image or letterbox 4:3 image.  | 47                                 |
| SCART        | A type of audio-video equipment connector. 21pin trapezoidal connector which is connected with an RGB signal, Video signal, or 2ch audio signal. Widespread in Europe.                        | 14, 21, 44, 45, 46, 47             |
| SECAM        | A standard for terrestrial analog broadcasting. Mainly adopted in France, Russia, et al.  | 40, 46                             |