



Please read this manual carefully before operating your set.

Retain it for future reference.

Record model number and serial number of the set. See the label attached on the bottom of the set and quote this information to your dealer when you require service.

Model number :

Serial number :

LG DLP PROJECTOR

HS102 HS102G OWNER'S MANUAL

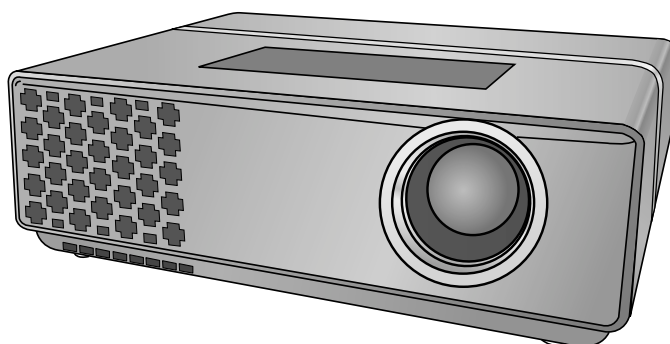

DLP PROJECTOR

Warning

This is a class A product. In a domestic environment this product may cause radio interference, in which case the user may be required to take adequate measures.

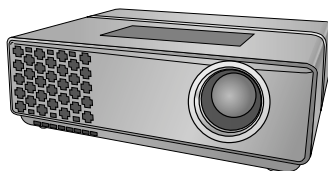

Contents

Safety Instructions	4
Names of parts	
Main Body	7
Connecting Part	7
Control Panel	8
Remote Control	9
Installing Batteries.....	9
Accessories	10
Optional Extras	10
Installing and Composition	
Installation Instructions	11
How to install the projector using the tripod ...	12
Basic Operation of the Projector.....	13
Using Kensington Security System.....	14
Turning on the Projector	15
Turning off the Projector	15
Focus and Position of the Screen Image.....	16
Selecting source mode	16
Connection	
Connecting to a Desktop PC	17
Connecting to a Notebook PC	17
Connecting to a Video Source	17
Connecting to a DVD	18
Connecting to a D-TV Set-Top Box	18
Function	
Video Menu Options	
Adjusting Video	19
Picture mode	20
Color Temperature Control.....	20
Smart picture Function.....	21
Black level Function	21
Keypad Sound Function.....	22
Keypad LED Function	22
Screen Capture Function	23
Special Menu Options	
Selecting Language	24
Using RATIO Function	24
Overscan Function	24
Flip horizontal Function.....	25
Flip vertical Function	25
Sleep time Function	26
Auto sleep Function	26
Presentation timer Function	27
Using Keystone Function	27
Using Blank Function	28
Selecting Blank image	28
LED mode Function	29
Screen Menu Options	
Auto configure Function	30
Using Phase Function	30
Using Clock Function	30
Using Horizontal Function.....	31
Using Vertical Function	31
USB	
To use the USB device	32
Photo List	33
Music List	35
Movie List.....	37
DivX Audio Language & Subtitle Language....	38
Information	
Supported Monitor Display.....	39
Maintenance.....	40
Specifications	41



Disposal of your old appliance

1. When this crossed-out wheeled bin symbol is attached to a product it means the product is covered by the European Directive 2002/96/EC.
2. All electrical and electronic products should be disposed of separately from the municipal waste stream via designated collection facilities appointed by the government or the local authorities.
3. The correct disposal of your old appliance will help prevent potential negative consequences for the environment and human health.
4. For more detailed information about disposal of your old appliance, please contact your city office, waste disposal service or the shop where you purchased the product.

Safety Instructions

Please take note of the safety instructions to prevent any potential accident or misuse of the projector.

→ Safety Instructions are given in two forms as detailed below.

 **WARNING** : The violation of this instruction may cause serious injuries and even death.

 **NOTES** : The violation of this instruction may cause light injuries or damage to the projector.

→ After reading this manual, keep it in the place that the user always can contact easily.

Indoor Installation

WARNING

Do not place the Projector in direct sunlight or near heat sources such as radiators, fires and stove etc.

This may cause a fire hazard !

Do not place inflammable materials beside the projector

This may cause a fire hazard !

Do not allow children to hang on the installed projector.

It may cause the projector to fall, causing injury or death.

Indoor Installation

NOTES

Disconnect from the mains and remove all connections before moving.

Do not place the projector close to sources of steam or oil such as a humidifier.

This may create a fire hazard or an electric shock hazard !

Do not place the projector where it might be exposed to dust.

This may cause a fire hazard or damage to the unit!

When installing the projector on a table, be careful not to place it near the edge.

This may cause the projector to fall causing serious injury to a child or adult and serious damage to the projector.

Only use a suitable stand.

Only use the projector on a level and stable surface.

It may fall and cause injury and/or damage to the unit.

Ensure good ventilation around the projector. The distance between the projector and the wall should be more than 30cm/12 inches.

An excessive increase in its internal temperature may cause a fire hazard or damage to the unit!

Do not block the vents of the projector or restrict air-flow in any way.

This would cause the internal temperature to increase and could cause a fire hazard or damage to the unit!

Do not place the projector directly on a carpet, rug or place where ventilation is restricted.

This would cause its internal temperature to increase and might create a fire hazard or damage the unit.

Outdoor Installation

WARNING

Do not use the projector in a damp place such as a bathroom where it is likely to get wet.

This may cause a fire or an electric shock hazard !

Power

WARNING

Earth wire should be connected.

If the earth wire is not connected, there is a possible danger of electric shock caused by the current leakage.

If grounding methods are not possible, a separate circuit breaker should be installed by a qualified electrician.

Do not connect ground to telephone wires, lightning rods or gas pipe.

The mains plug should be inserted fully into the power outlet to avoid a fire hazard !

This may cause a fire hazard or damage the unit.

Do not place heavy objects on the power cord.

This may cause a fire or an electric shock hazard !

Power

 WARNING

Do not use too many plugs on the Mains multi-outlet.
It may result in overheating of the outlet and causes a fire hazard !

Power

 NOTES

Never touch the power plug with a wet hand
This may cause an electric shock hazard !

Hold the plug firmly when unplugging. If you pull the cord, it may be damaged.
This may cause a fire hazard !

Prevent dust collecting on the power plug pins or outlet.
This may cause a fire hazard !

Do not plug when the power cord or the plug is damaged or any part of the power outlet is loose.
This may cause a fire or an electric shock hazard or damage to the unit!

Ensure the power cord does not come into contact with sharp or hot objects such as a heater.
This may cause a fire or an electric shock hazard or damage to the unit!

Place the projector where people will not trip or tread on the power lead.
This may cause a fire or an electric shock hazard or damage to the unit!

Do not turn the projector On/Off by plugging-in or unplugging the power plug to the wall outlet.
(Do not use the power plug for switch.)
It may cause mechanical failure or could cause an electric shock.

Using

 WARNING

Do not place anything containing liquid on top of the projector such as flowerpot, cup, cosmetics or candle.
This may cause a fire hazard or damage to the unit!

In case of impact shock or damage to the projector switch it off and unplug it from the mains outlet and contact your service center.
This may cause a fire or an electric shock hazard or damage to the unit!

Do not allow any objects to fall into the projector.
This may cause an electric shock hazard or damage to the unit!

If water is spilt into the projector unplug it from the mains supply outlet immediately and consult your Service Agent.
This may cause an electric shock hazard or damage to the unit!

Dispose of used batteries carefully and safely.
In the case of a battery being swallowed by a child please consult a doctor immediately.

In the event that an image does not appear on the screen please switch it off and unplug it from the mains supply and contact your Service Agent.
This may cause a fire or an electric shock hazard or damage to the unit!

Do not remove any covers. High risk of Electric Shock!

Don't look directly onto the lens when the projector is in use. Eye damage may occur!

Do not touch metal parts during or soon after operation since the vents will remain very hot!

CAUTION concerning the Power Cord

Most appliances recommend they be placed upon a dedicated circuit; that is, a single outlet circuit which powers only that appliance and has no additional outlets or branch circuits. Check the specification page of this owner's manual to be certain.

Do not overload wall outlets. Overloaded wall outlets, loose or damaged wall outlets, extension cords, frayed power cords, or damaged or cracked wire insulation are dangerous. Any of these conditions could result in electric shock or fire. Periodically examine the cord of your appliance, and if its appearance indicates damage or deterioration, unplug it, discontinue use of the appliance, and have the cord replaced with an exact replacement part by an authorized service personnel.

Protect the power cord from physical or mechanical abuse, such as being twisted, kinked, pinched, closed in a door, or walked upon. Pay particular attention to plugs, wall outlets, and the point where the cord exits the appliance.

Using

 WARNING

Never touch the wall outlet when there is leakage of gas, open the windows and ventilate.

It can cause a fire or a burn by a spark.

Do not drop the projector or allow impact shock.

This may cause mechanical failure or personal injury !

Don't look at laser beam directly as it can cause eye damage!

Using

 NOTES

Do not place heavy objects on top of projector.

This may cause mechanical failure or personal injury!

Take care not to impact the lens particularly when moving the projector.

Do not touch the lens of the projector. It is delicate and easily damaged.

Do not use any sharp tools on the projector as this will damage the casing.

Cleaning

 WARNING

Do not use water while cleaning the projector

This may cause damage to the projector or an electric shock hazard.

In the unlikely event of smoke or a strange smell from the projector, switch it off, unplug it from the wall outlet and contact your dealer or service centre.

This may cause a fire or an electric shock hazard or damage to the unit!

Use an air spray or soft cloth that is moist with a neutral detergent and water for removing dust or stains on the projection lens.

Cleaning

 NOTES

Contact the Service Center once a year to clean the internal parts of the projector.

Accumulated dust can cause mechanical failure.

When cleaning the plastic parts such as projector case, unplug the power and wipe it with a soft cloth. Do not use cleanser, spray water or wipe with a wet cloth. Especially, never use cleanser (glass cleaner), automobile or industrial shiner, abrasive or wax, benzene, alcohol etc., which can damage the product. Use an air spray or soft cloth that is moist with a neutral detergent and water for removing dust or stains on the projection lens.

It can cause fire, electric shock or product damage (deformation, corrosion and damage).

Others

 WARNING

Do not attempt to service the projector yourself. Contact your dealer or service centre.

This may cause damage to the projector and could give an electric Shock as well as invalidating the warranty !

Others

 NOTES

Be sure to unplug if the projector is not to be used for a long period.

Accumulated dust may cause a fire hazard or damage to the unit!

Do not mix new batteries with old batteries.

This may cause the batteries to over-heat and leak.

Only use the specified type of battery.

This could cause damage to the remote control.

Names of parts

Main Body

* The projector is manufactured using high-precision technology. You may, however, see on the Projector screen tiny black points and/or bright points (red, blue, or green). This can be a normal result of the manufacturing process and does not always indicate a malfunction.

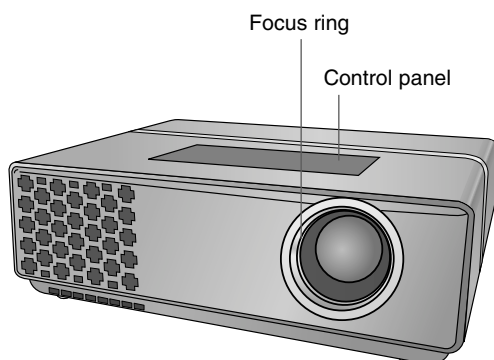

Connecting Part

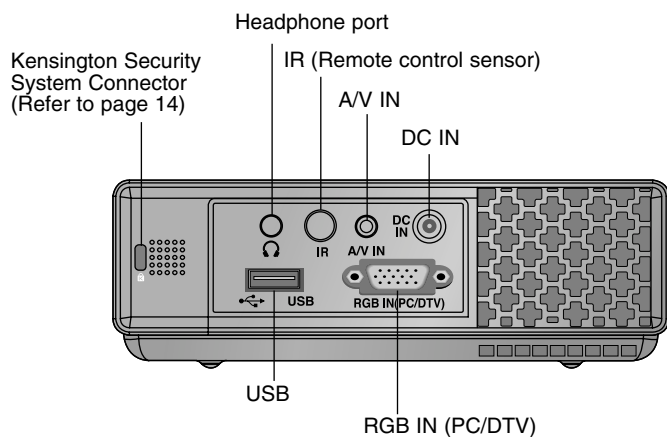

* Do not block the IR port for normal operation of remote control.

Control Panel

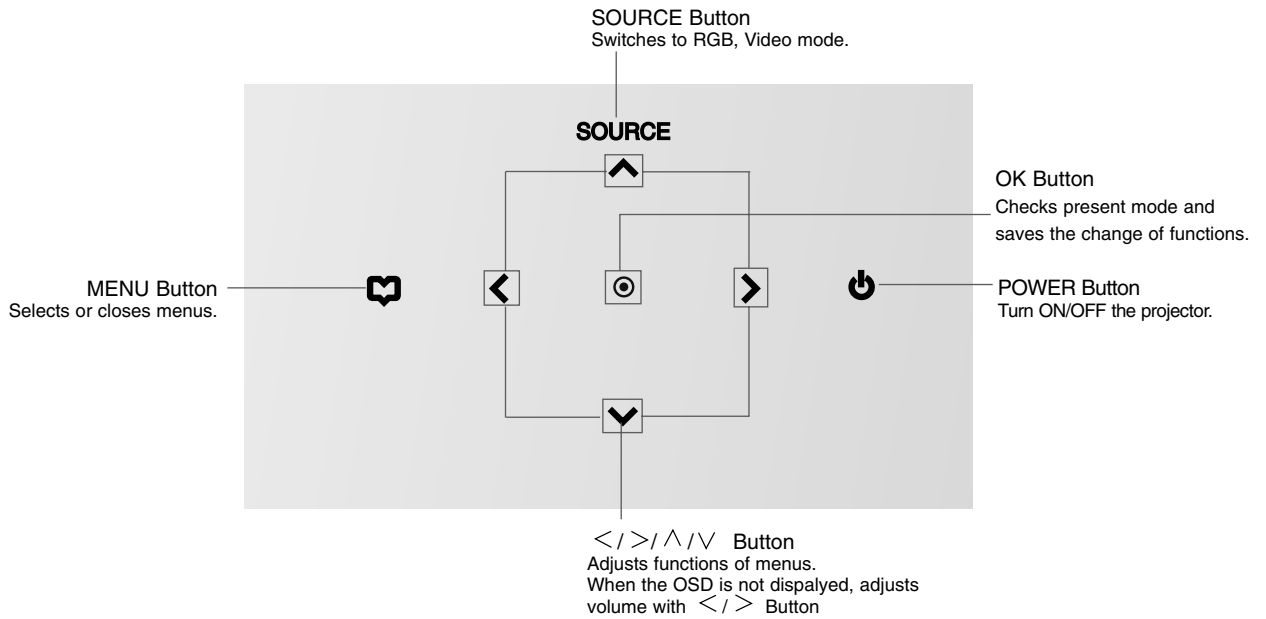

Remote Control

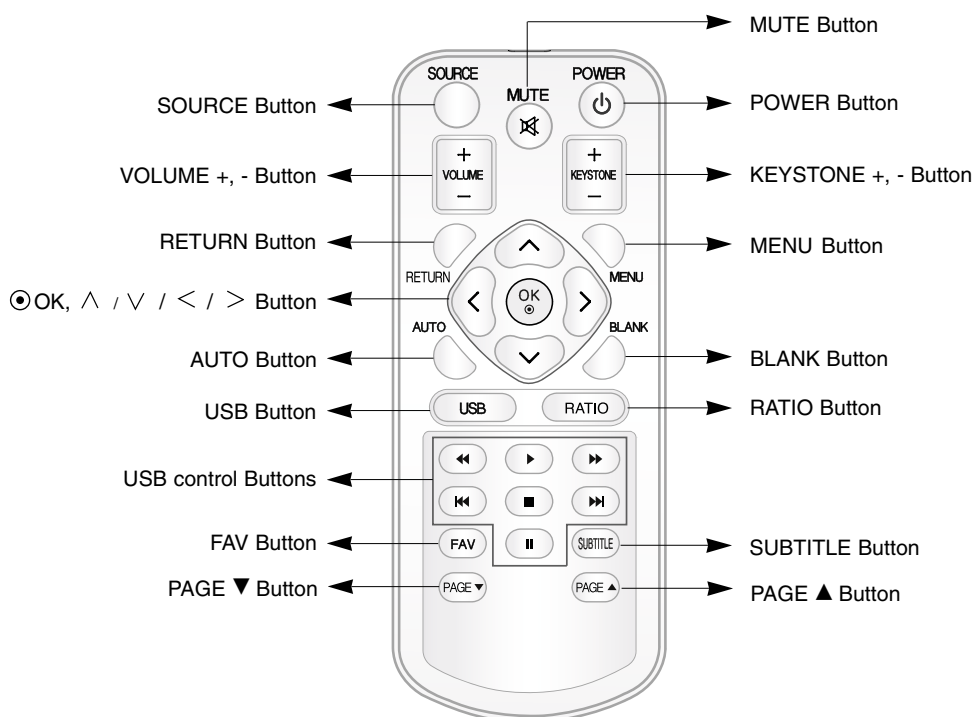

Installing Batteries

CAUTION

RISK OF EXPLOSION IF BATTERY IS REPLACED WITH AN INCORRECT TYPE.
DISPOSE OF USED BATTERIES ACCORDING TO THE INSTRUCTIONS.

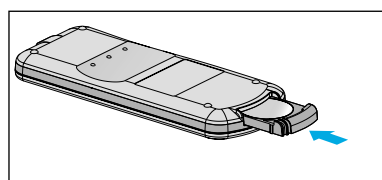
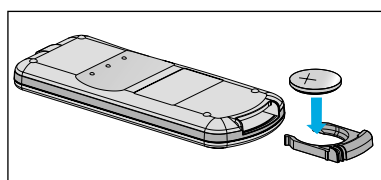
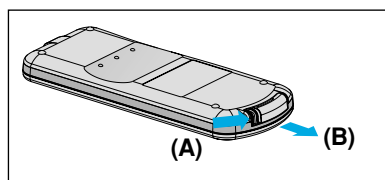

1. Remove the battery compartment cover by sliding the cover in the direction of the arrow (A). Pull out the cover in the direction of the arrow (B).
2. Insert the battery with the positive side facing up.
3. Replace the cover.

Note!

- Only use a 3V lithium battery (CR2032).
- Dispose of used batteries according to local ordinance regulations.
- Remove the battery when not using the projector for prolonged periods.

Accessories



Remote Control



3V Battery



Owner's manual



CD Owner's manual



Polishing Cloth



Power Cord



Computer Cable



A/V Cable



Adapter



RGB to Component Cable

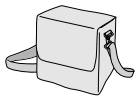

Portable bag
(*Only for HS102G model)

Note!

- Use a remote control up to 6 meters distance and 30 degree (left/right) within the receiving unit scope.
- We recommend you to use the remote control under 3 meters distance and 30 degree (left/right) when the cables are connected in the back outputs.

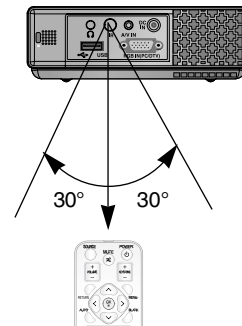

Optional Extras

* Contact your dealer to purchase these items.

* Optional parts can be changed without notice to improve the quality of the product, and new optional parts can be added.

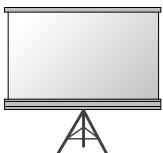

Projection Screen



Component Cable



Tripod

Installing and Composition

Installation Instructions

* Don't place the projector in the following conditions. It may cause malfunction or product damage.

● Provide proper ventilation for this projector.

- The projector is equipped with ventilation holes(intake) on the bottom and ventilation holes(exhaust) on the front. Do not block or place anything near these holes, or internal heat build-up may occur, causing picture degradation or damage to the projector.

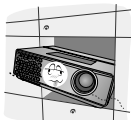

- Do not place the projector on a carpet, rug or other similar surface. It may prevent a adequate ventilation of the projector bottom. This product should be mounted to a wall or ceiling only.

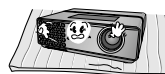

- Never push projector or spill any kind of liquid into the projector.



- Leave an adequate distance(30cm/12 inches or more) around the projector.



● Place this projector in adequate temperature and humidity conditions.

- Install this projector only in a location where adequate temperature and humidity is available. (refer p.41)

● Don't place the projector where it can be covered with dust.

- This may cause overheating of the projector.

● Do not obstruct the slots and openings of the projector. This may cause overheating and create a fire hazard.

● The projector is manufactured using high-precision technology. You may, however, see tiny black points and/or bright points (red, blue, or green) that continuously appear on the projector Screen. This is a normal result of the manufacturing process and does not indicate a malfunction.

● To display DTV programs, it is necessary to purchase a DTV receiver (Set-top Box) and connect it to the projector.

● When the remote control does not work during operation.

- The remote control may not work when a lamp equipped with electronic ballast or a three-wavelength lamp is installed. Replace those lamps with international standard products to use the remote control normally.

How to install the projector using the tripod

* You can install this projector using a tripod for the camera. You can assemble the projector instead of the camera on camera tripod.

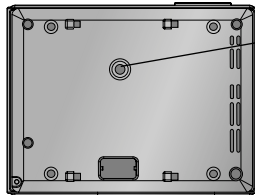

Bottom side of Projector

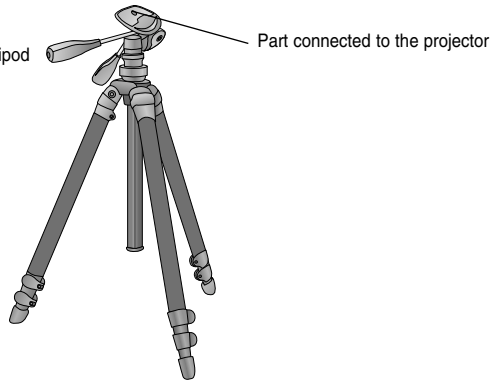

Camera Tripod

- If you have a camera tripod, assemble the projector to the part connecting to the camera tripod

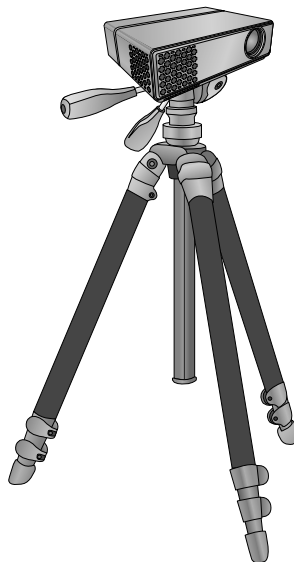

Finished condition when projector is install on the tripod

Basic Operation of the Projector

1. Place the projector on a sturdy and horizontal surface with the PC or AV source.
2. Place the projector with the desired distance from the screen. The distance between the projector and the screen determines the actual size of the image.
3. Position the projector so that the lens is set at a right angle to the screen. If the projector is not set at a right angle, the screen image will be crooked. If this is so then the keystone adjustment may correct this (Refer to page 27.).
4. Connect the cables of the projector to a wall power socket and other connected sources.

projection distance based on the picture format

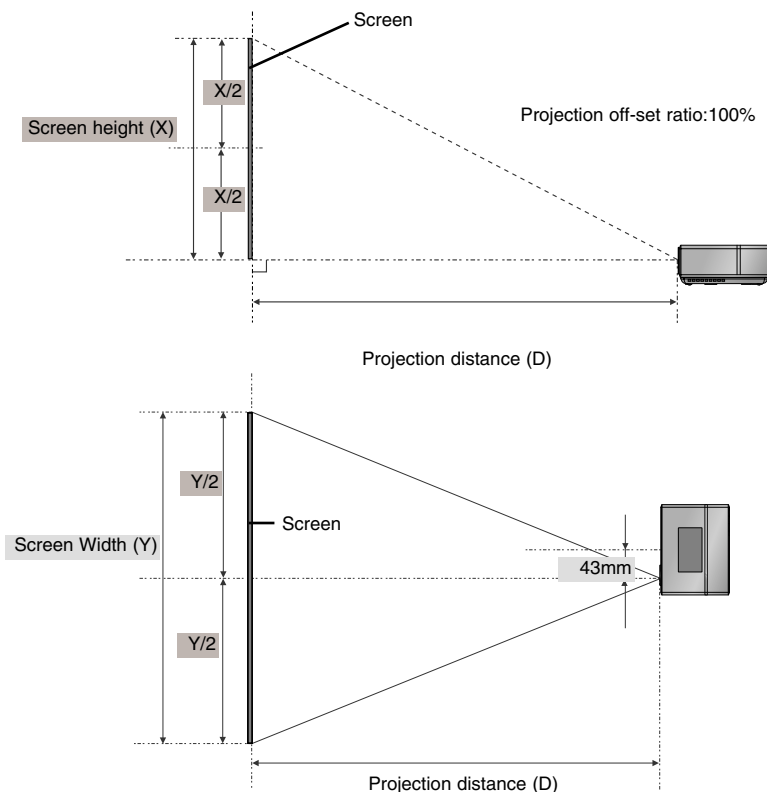

4 : 3 Scale				
Diagonal Size (inch)	Diagonal Size (mm)	Horizontal Size (mm)	Vertical Size (mm)	Projection Distance(D) (mm)
15	381	305	229	406
20	508	406	305	546
25	635	508	381	686
30	762	610	457	827
35	889	711	533	967
40	1016	813	610	1107
45	1143	914	686	1247
50	1270	1016	762	1386
55	1397	1118	838	1528
60	1524	1219	914	1668
65	1651	1321	991	1807
70	1778	1422	1067	1948
75	1905	1524	1143	2088
80	2032	1626	1219	2228

Using Kensington Security System

- The projector has a 'Kensington' Security System Connector on the side panel. Connect the 'Kensington' Security System cable as below.
- For the detailed installation and use of the Kensington Security System, refer to the user's guide attached to the Kensington Security System set.
And for further information, contact <http://www.kensington.com>, the internet homepage of the Kensington company that deals with expensive electronic equipment such as notebook PCs or projectors.
- Kensington Security System is an optional item.

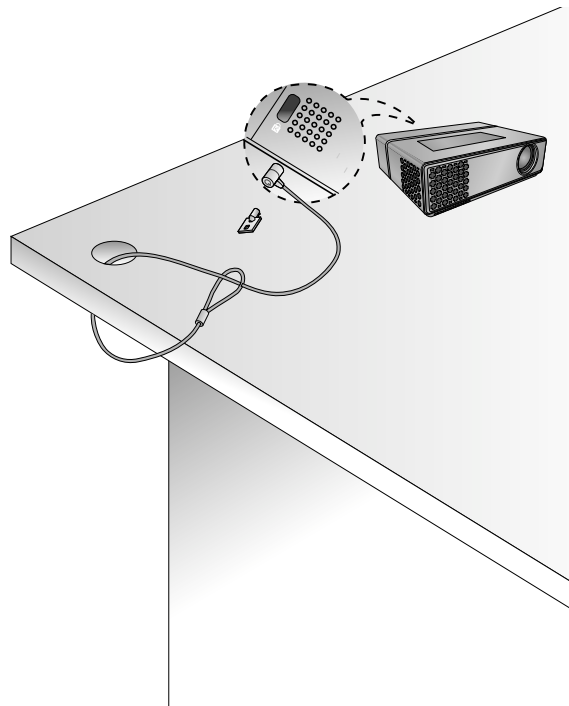

Turning on the Projector

1. Connect power cord correctly.
2. Press the ϕ button on the top cover or the **POWER** button on the remote control. (The light on the control panel will be turned on.)
 - Press the SOURCE button on the remote control or the SOURCE button on the control panel to select the input signal you want.
 - When you press the POWER button on the remote control or the ϕ button on the control panel when you turn on the projector, the lights for all buttons on the control panel will be turned on.

Turning off the Projector

1. Press the ϕ button on the top cover or the **POWER** button on the remote control.
2. Press the ϕ button on the top cover or the **POWER** button on the remote control again to turn off the power.
 - When you press POWER button when you turn off the projector, the lights for all buttons on the control panel will be turned off. When you press any button on the control panel when the projector is turned off, the light only on the POWER LED turned on. (When the POWER cord is connected.)



Power off?
Please press Power key again.

Focus and Position of the Screen Image

When an image appears on the screen, check if it is in focus and fits well to the screen.

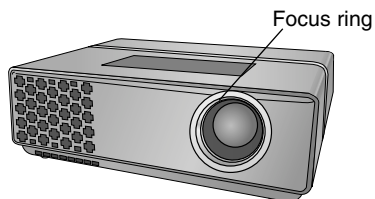

- To adjust the focus of the image, rotate the focus ring which is the outer ring on the lens.

Selecting source mode

1. Press the **SOURCE** button on the top cover or remote control.

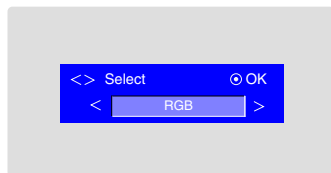

2. Each press of the < , > button changes the display as below.

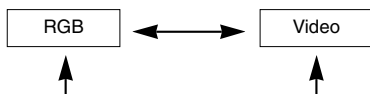

- When you connect the RGB to Component cable to the RGB IN (PC/DTV) terminal and select RGB input, you can receive the Component input.
- DivX mode runs automatically when connects USB device.

Connection

Connecting to a Desktop PC

* You can connect the projector to a computer of VGA, SVGA, XGA and SXGA output.

* Refer to page 39 for the supported monitor displays of the projector.

< How to connect >

Connect computer cable to **RGB IN (PC/DTV)** of the projector.

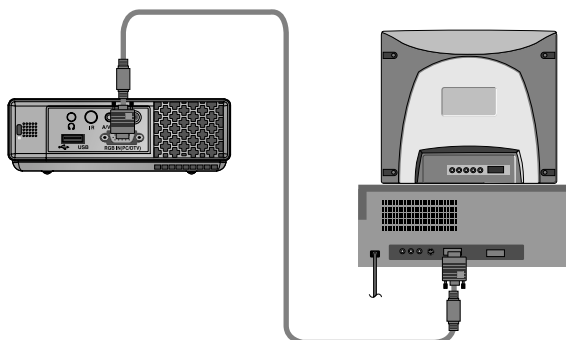

Connecting to a Notebook PC

< How to connect >

Connect computer cable to **RGB IN (PC/DTV)** of the projector.

* If you set your computer to output the signal to both the display of your computer and the external projector, the picture of the external projector may not appear properly. In such cases, set the output mode of your computer to output the signal only to the external projector. For details, refer to the operating instructions supplied with your computer.

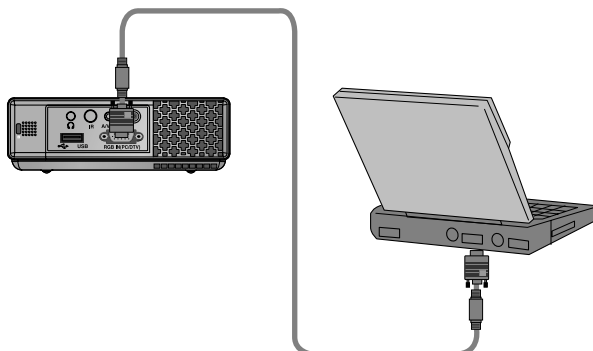

Connecting to a Video Source

* You can connect a VTR, a camcorder or any other compatible video image source to the projector.

< How to connect >

a. Connect the **A/V IN** jack of the projector to the output jacks of the A/V source with A/V cable.

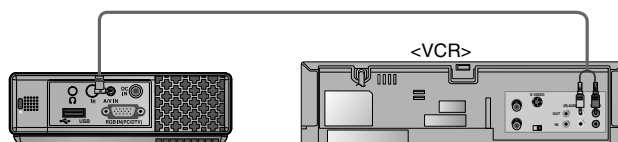

Connecting to a DVD

* The output jacks (Y, P_B, P_R) of the DVD might be labelled as Y, Pb, Pr / Y, B-Y, R-Y / Y, Cb, Cr according to the equipment.

< How to connect >

a. After connecting the Component cable of DVD to the RGB to Component cable, connect it to the **RGB IN(PC/DTV)** terminal of the projector.

* When connecting the component cable, match the jack colors with the component cable.(Y=green, P_B=blue, P_R=red)

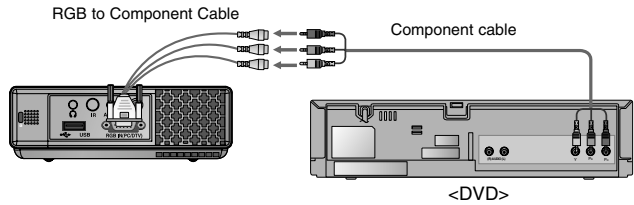

Signal	Component	RGB/DTV
480i	O	X
480p	O	O
720p	O	O
1080i	O	O
576i	O	X
576p	O	O

Connecting to a D-TV Set-Top Box

* To receive D-TV programmes, it is necessary to purchase a D-TV receiver (Set-Top Box) and connect it to the projector.
 * Please refer to the owner's manual of the D-TV Set-Top Box for the connection between projector and D-TV Set-Top Box.

< How to connect an RGB source >

a. Connect RGB cable to **RGB IN (PC/DTV)** of the projector.

b. Use a DTV receiver with DTV 480p(576p)/720p/1080i mode.

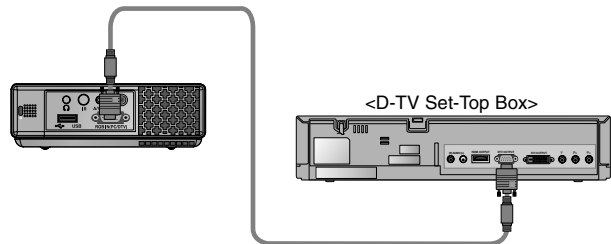

< How to connect a Component source >

a. Connect the D-TV Set-Top Box Component cable with RGB to Component cable and then connect it to **RGB IN(PC/DTV)** of the projector.

* When connecting the component cable, match the jack colors with the component cable.(Y=green, P_B=blue, P_R=red)

b. Use a DTV receiver with DTV 480p(576p)/720p/1080i mode.

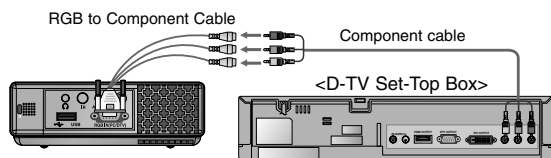

Function



* In this manual, the OSD(On Screen Display) may be different from your Projector's because it is just an example to help with the Projector operation.

* This operating guide explains operation of RGB(PC) mode mainly.

Video Menu Options

Adjusting Video

1. Press the **MENU** button and then use < , > button to select the  menu.
2. Press the ^ , v button to select a video item you want to adjust.
3. Press the < , > button to adjust the screen condition as you want.

- Each adjustment of  menu options will not affect other inputs. As required, re-adjust  menu options for the input sources.
- To restore the original image condition after changing it, press **OK** button after selecting [**Reset**] item.
- When receiving an NTSC signal, the picture item **Tint** is displayed and can be adjusted.(60Hz only)
- You can use this function through the  button on the control panel.
- Press the **MENU** button twice or the **RETURN** button to exit the menu screen.

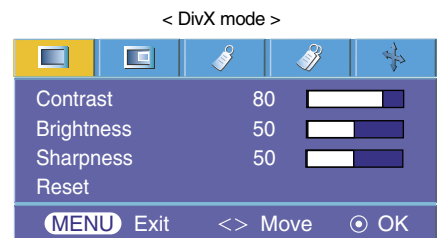
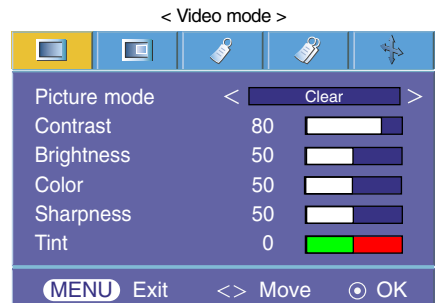
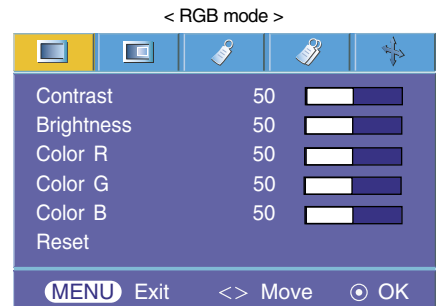

Picture mode

- * Use Picture mode function to set the projector for the best picture appearance.
- * This function does not work in RGB or DivX mode.

1. Press the **MENU** button and then use < , > button to select the  menu.
2. Press the ^ , v button to select **Picture mode** item.
3. Press the < , > button to adjust the screen condition as you want.

- Each press of the < , > button changes the screen as shown below.

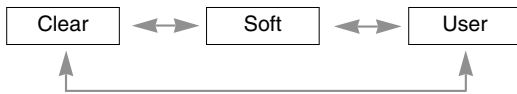

- You can use this function through the  button on the control panel.
- Press the **MENU** button twice or the **RETURN** button to exit the menu screen.

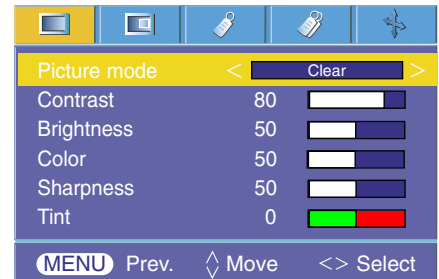

Color Temperature Control

1. Press the **MENU** button and then use < , > button to select the  menu.
2. Press the ^ , v button to select **Color temp.** item.
3. Press the < , > button to make desired adjustments.

- Each press of the < , > button changes the screen as shown below.

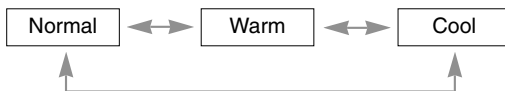

- You can use this function through the  button on the control panel.
- Press the **MENU** button twice or the **RETURN** button to exit the menu screen.

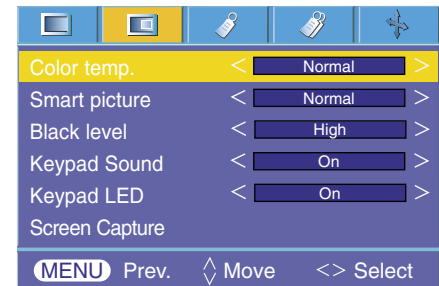

Smart picture Function

1. Press the **MENU** button and then use < , > button to select the  menu.
2. Press the ^ , v button to select **Smart picture** item.
3. Press the < , > button to make desired adjustments.

- Each press of the < , > button changes the screen as shown below.

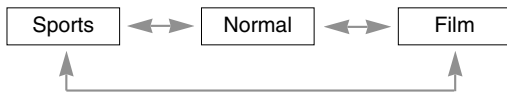

- You can use this function through the  button on the control panel.
- Press the **MENU** button twice or the **RETURN** button to exit the menu screen.

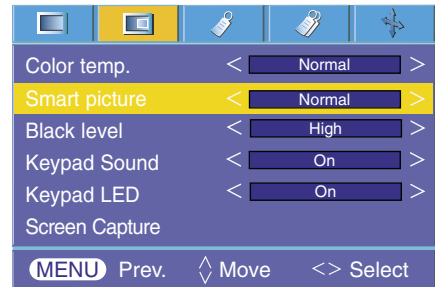

Black level Function

1. Press the **MENU** button and then use < , > button to select the  menu.
2. Press the ^ , v button to select **Black level** item.
3. Press the < , > button to select Low or High.

- This function works in the following mode : Video
- You can use this function through the  button on the control panel.
- Press the **MENU** button twice or the **RETURN** button to exit the menu screen.

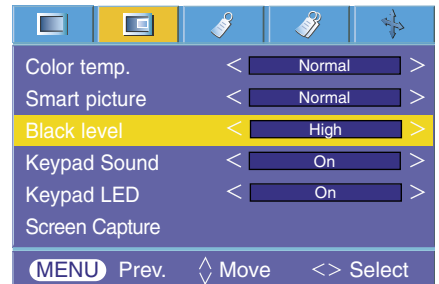

* What is the **Black level** function?

When you watch the movie, this function adjusts the set to the best picture appearance. Adjusting the contrast and the brightness of the screen using the black level of the screen.

Keypad Sound Function

1. Press the **MENU** button and then use < , > button to select the  menu.

2. Press the ^ , v button to select **Keypad Sound** item.

3. Press the < , > button to select On or Off.

- You can use this function through the  button on the control panel.
- Press the **MENU** button twice or the **RETURN** button to exit the menu screen.

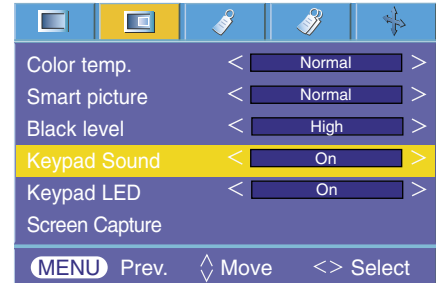

Keypad LED Function

1. Press the **MENU** button and then use < , > button to select the  menu.

2. Press the ^ , v button to select **Keypad LED** item.

3. Press the < , > button to select On or Off.

- You can use this function through the  button on the control panel.
- Press the **MENU** button twice or the **RETURN** button to exit the menu screen.

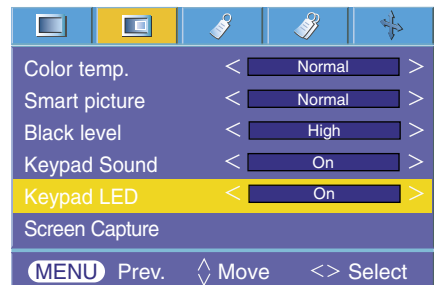

Screen Capture Function

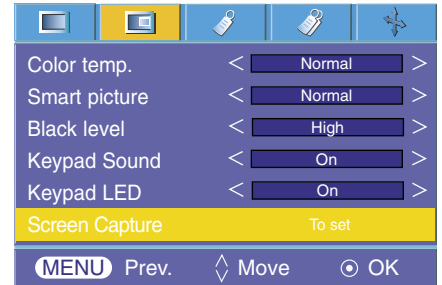
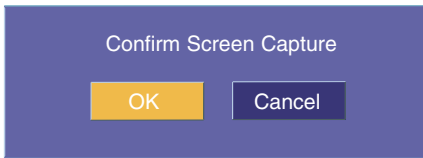

1. Press the **MENU** button and then use < , > button to select the  menu.
2. Press the ^ , v button to select **Screen Capture** item.
3. Press the **OK** button to capture actual screen image.



4. Press the **OK** button again to save Screen capture image.
 - You can use the captured image as a Blank image.
 - You can not use the remote control when this function is in use.
 - If you want see your captured image, select Captured image in the Blank image function.
 - You can use this function through the  button on the control panel.
 - Press the **MENU** button twice or the **RETURN** button to exit the menu screen.

Special Menu Options

Selecting Language

1. Press the **MENU** button and then use < , > button to select the  menu.
2. Press the \wedge , \vee button to select **Language** item.
3. Press the < , > button to select the language you want to use.
 - On-Screen-Display (OSD) is displayed in the selected language.
 - You can use this function through the  button on the control panel.
 - Press the **MENU** button twice or the **RETURN** button to exit the menu screen.

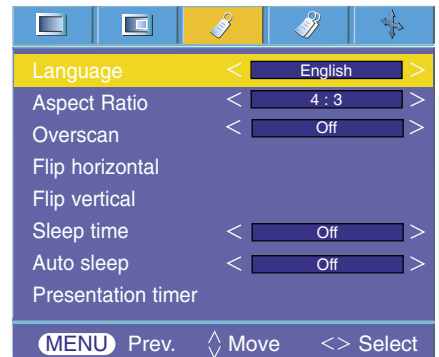

Using RATIO Function

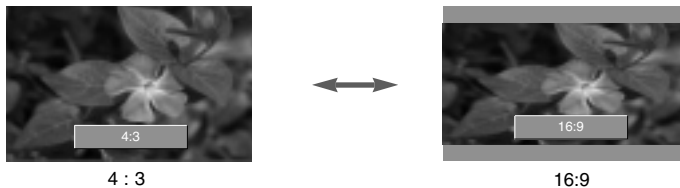

1. Press the **RATIO** button on the remote control.
Each press of the button changes the display as below.



Note!

You can also use this function by using the  button on the control panel.



Overscan Function

1. Press the **MENU** button and then use < , > button to select the  menu.
2. Press the \wedge , \vee button to select **Overscan** item.
3. Press the < , > buttons.
 - The **Overscan** function can be adjusted only in RGB, Component and DivX modes.
 - The **Overscan** function can be adjusted between Off and 10%.
 - You can use this function through the  button on the control panel.
 - Press the **MENU** button twice or the **RETURN** button to exit the menu screen.



Flip horizontal Function

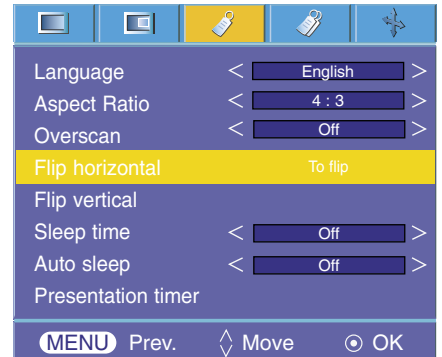

* This function reverses the projected image horizontally.
Use this function when rear projecting an image.

1. Press the **MENU** button and then use < , > button to select the  menu.
2. Press the ^ , v button to select **Flip horizontal** item.
3. Press the **OK** button to see reversed image.
 - Each time you press the **OK** button, the image will be reversed.
 - You can use this function through the  button on the control panel.
 - Press the **MENU** button twice or the **RETURN** button to exit the menu screen.



Flip vertical Function

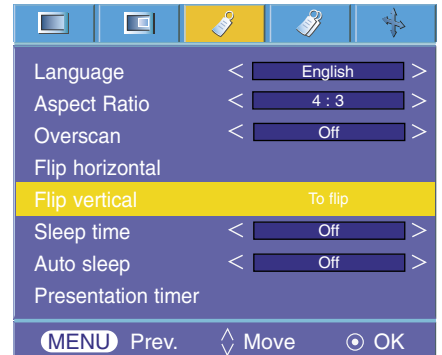

* This function reverses the projected image vertically.
* When you hang the projector upside down from the ceiling ,
you will need to reverse the image vertically and horizontally.

1. Press the **MENU** button and then use < , > button to select the  menu.
2. Press the ^ , v button to select **Flip vertical** item.
3. Press the **OK** button to see reversed image.
 - Each time you press the **OK** button, the image will be reversed.
 - You can use this function through the  button on the control panel.
 - Press the **MENU** button twice or the **RETURN** button to exit the menu screen.



Sleep time Function

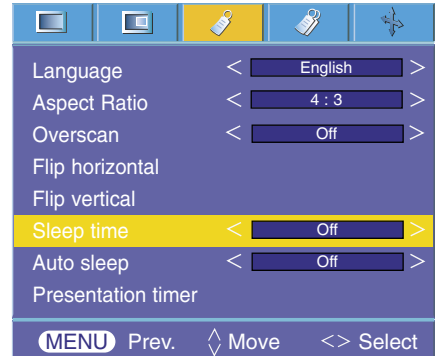
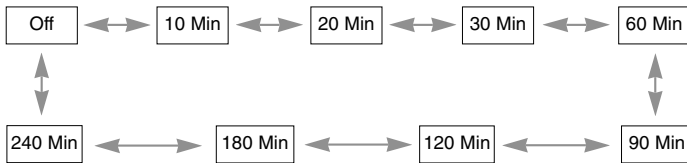

* The sleep timer turns the projector off at the preset time.

1. Press the **MENU** button and then use < , > button to select the  menu.
2. Press the ^ , v button to select **Sleep time** item.
3. Press the < , > button to select the desired preset time.
 - You can use this function through the  button on the control panel.
 - Press the **MENU** button twice or the **RETURN** button to exit the menu screen.



Auto sleep Function

* This function turns the projector off automatically after the preset time is passed when there is no signal.

1. Press the **MENU** button and then use < , > button to select the  menu.
2. Press the ^ , v button to select **Auto sleep** item.
3. Press the < , > button to select the desired preset time.
 - You can use this function through the  button on the control panel.
 - Press the **MENU** button twice or the **RETURN** button to exit the menu screen.

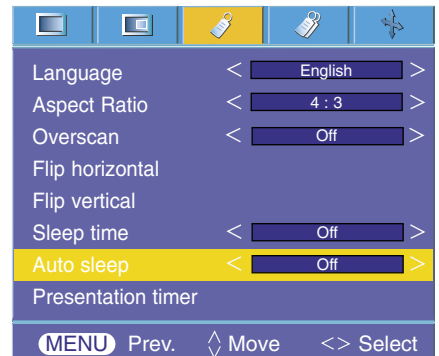
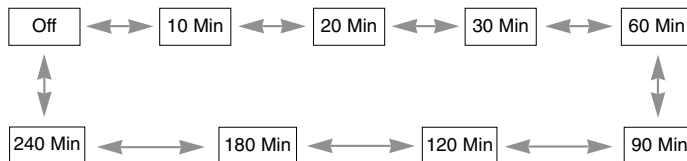

Presentation timer Function

1. Press the **MENU** button and then use < , > button to select the  menu.
2. Press the ^ , v button to select **Presentation timer** item and press **OK** button.
3. Press the ^ , v button to select **Time alarm** or **Time keeper** item.

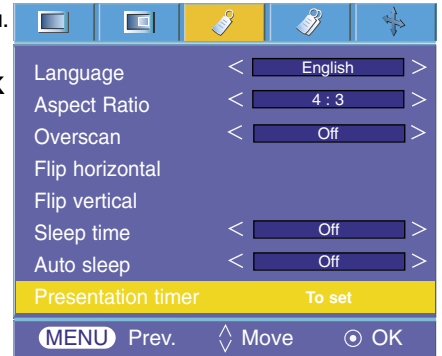
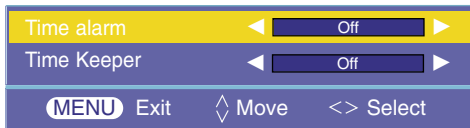



4. Press the < , > button to select the desired preset time.
5. The timer for Time keeper item starts to operate if you select specific time and press the **OK** button, and the timer for Time alarm item starts to operate if you select specific time.

- Time alarm function : If you select a specific time, it is displayed in minute units. After 1 minute, the remaining time is displayed at the bottom right of the screen, and then disappears after 5 seconds. When the remaining time is displayed, other OSD windows are closed. When the set time is reached, '0 minute' flickers 10 times at 1 second intervals, and then disappears.
- Time keeper function : If you select a specific time, it continues to be displayed in minute(') and second(") units. Even though other OSD windows appear, the remaining time is displayed again after the windows are closed. When the set time is reached. '0' 00" flickers 10 times at 1 second intervals, and then disappears.
- The **Time alarm** function and the **Time keeper** function cannot be used at the same time.
- The **Time alarm** function can be set from 5 to 60 minutes at 5 minute intervals (Off, 5, 10, 15, 20,, 55, 60 minutes).
- The **Time keeper** function can be set from 1 to 10 minutes at 1 minute intervals, and from 10 to 60 minutes at 5 minute intervals (Off, 1, 2, 3, 4,, 8, 9, 10, 15, 20, 25,, 55, 60 minutes).
- You can use this function through the  button on the control panel.
- Press the **MENU** button twice or the **RETURN** button to exit the menu screen.

Using Keystone Function

- * Use this function when the screen is not at a right angle to the projector and the image is a trapezoid shape.
 * Only use the **Keystone** function when you can't get the best angle of projection.

1. Press the **KEYSTONE +, -** button of remote control.
2. Press the **KEYSTONE +, -** button to adjust the screen condition as you want.

- **Keystone** can be adjusted from -20 to 20.
- You can use the Keystone function on the  menu screen by pressing the **MENU** button, or by pressing the < , > buttons on the control panel.
- You can use this function through the  button on the control panel.
- Press the **MENU** button twice or the **RETURN** button to exit the menu screen.

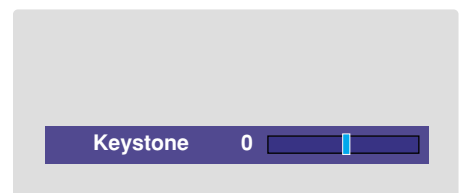

Using Blank Function

*This function may be effective if you need to get the attention of the audience during presentations, meetings or briefings.

1. Press the **BLANK** button on the remote control.

- The screen turns off to a background image.
- You can choose the background image.

(Refer to 'Selecting blank image')

2. Press any button to cancel the blank function.

- To temporarily turn off the image, press **BLANK** on the remote control. Do not block the projection lens with any objects when the projector is under operation as this could cause the objects to become heated and deformed or even cause a fire.

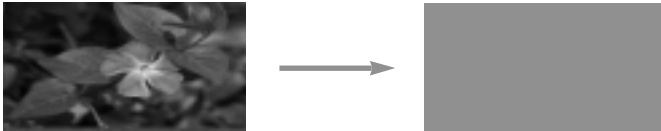

Selecting Blank image

1. Press the **MENU** button and then use < , > button to select the  menu.

2. Press the ^ , v button to select **Blank image** item.

3. Press the < , > button to select the color you want to use.

- Background image will be altered to the selected Blank image function.
- You can choose blue, black, green, or captured image for the Blank image.
- If you have a captured image, you can use it as a blank image instead of logo image. And you only have one last captured image.
- When you select the Captured image, displays a logo, if you don't have a captured image.
- You can use this function through the  button on the control panel.
- Press the **MENU** button twice or the **RETURN** button to exit the menu screen.

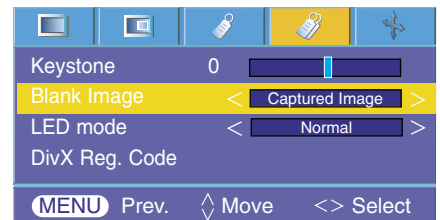

LED mode Function

1. Press the **MENU** button and then use < , > button to select the  menu.
2. Press the ^ , v button to select **LED mode** item.
3. Press the < , > button to select Normal or Dark.

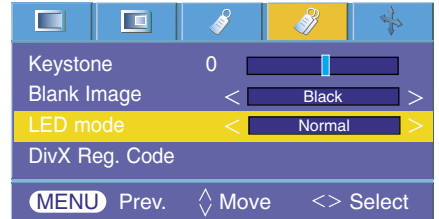

- You can use this function through the  button on the control panel.
- Press the **MENU** button twice or the **RETURN** button to exit the menu screen.
- Refer to the page 38 for DivX Reg. Code.

Screen Menu Options

Auto configure Function

- * This function assures you of getting the best video quality by automatically adjusting the horizontal size and synchronization of the image.
- * Auto Tracking function works in RGB PC input only.

1. Press the **AUTO** button of the remote controller.
 - Image positioning and synchronization are automatically adjusted.
2. If any more manual adjustment is needed according to the various PC mode inputs even after the auto-correction, execute **Phase, Clock, Horizontal** and **Vertical** function in  menu. In certain circumstances, you can't get the best picture quality by only using auto-correction.

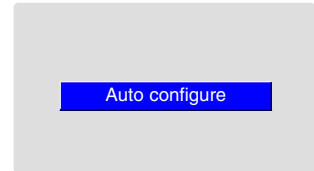

Note!

You can also use this function by using the MENU button. (Only in RGB mode)
For best results, perform this function while displaying a still image.

Using Phase Function

1. Press the **MENU** button and then use \leftarrow , \rightarrow button to select the  menu.
2. Press the \wedge , \vee button to select **Phase** item.
3. Press the \leftarrow , \rightarrow button to make desired adjustments.

- **Phase** adjustment range is 0 ~ 31.
- The variable range can be different depends on input resolutions.
- You can use this function through the  button on the control panel.
- Press the **MENU** button twice or the **RETURN** button to exit the menu screen.

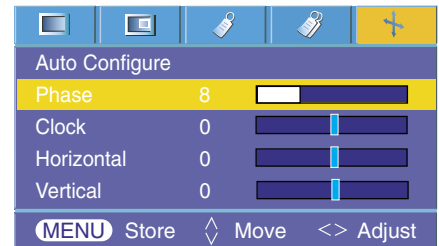

Using Clock Function

1. Press the **MENU** button and then use \leftarrow , \rightarrow button to select the  menu.
2. Press the \wedge , \vee button to select **Clock** item.
3. Press the \leftarrow , \rightarrow button to make desired adjustments.

- **Clock** adjustment range is -20 ~ 20.
- The variable range can be different depends on input resolutions.
- You can use this function through the  button on the control panel.
- Press the **MENU** button twice or the **RETURN** button to exit the menu screen.

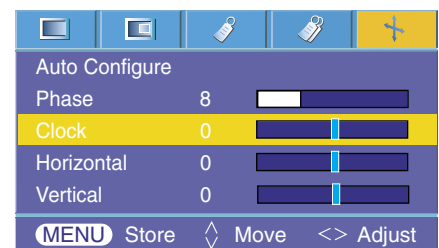

Using Horizontal Function

1. Press the **MENU** button and then use < , > button to select the menu. 
2. Press the ^ , v button to select **Horizontal** item.
3. Press the < , > button to make desired adjustments.

- **Horizontal** adjustment range is -50 ~ 50.
- The variable range can be different depends on input resolutions.
- You can use this function through the  button on the control panel.
- Press the **MENU** button twice or the **RETURN** button to exit the menu screen.

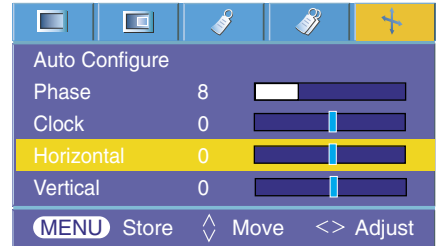

Using Vertical Function

1. Press the **MENU** button and then use < , > button to select the menu. 
2. Press the ^ , v button to select **Vertical** item.
3. Press the < , > button to make desired adjustments.

- **Vertical** adjustment range is -50 ~ 50.
- The variable range can be different depends on input resolutions.
- You can use this function through the  button on the control panel.
- Press the **MENU** button twice or the **RETURN** button to exit the menu screen.

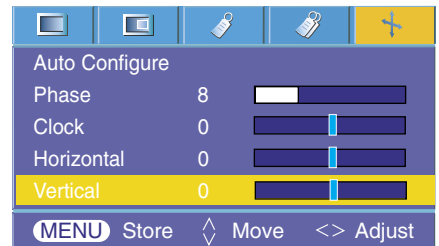

USB

* Image shown may differ from your projector.

To use the USB device

Connecting the USB device

* When you connect a USB device, this screen is displayed, automatically.
In USB device, you can not add a new folder or delete the existing folder.

1. Connect the USB device to the USB jack on the back of the set.
2. It turns automatically to DivX Home Menu.

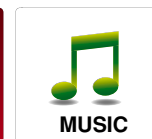
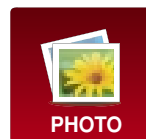
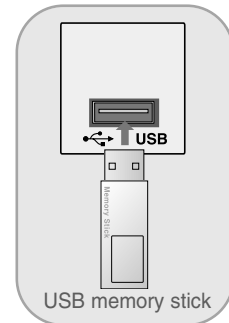

Precautions when using the USB device

- ▶ Only a USB storage device is recognizable. Digital camera and mobile phone are not supported.
- ▶ If the USB storage device is connected through a USB hub, the device is not recognizable.
- ▶ A USB storage device using an automatic recognition programme may not be recognized.
- ▶ A USB storage device which uses its own driver may not be recognized.
- ▶ In case of a card reader, up to one memory cards are concurrently recognizable.
- ▶ The recognition speed of a USB storage device may depend on each device.
- ▶ Please do not turn off the PROJECTOR or unplug the USB device when the connected USB storage device is working. When such device is suddenly separated or unplugged, the stored files or the USB storage device may be damaged.
- ▶ Please do not connect the USB storage device which was artificially maneuvered on the PC. The device may cause the product to malfunction or fail to be played. Never forget to use only a USB storage device which has normal music files or image files.
- ▶ Please use only a USB storage device which was formatted as a FAT32 file system provided with the Windows operating system. In case of a storage device formatted as a different utility programme which is not supported by Windows, it may not be recognized.
- ▶ Please connect power to a USB storage device which requires an external power supply. If not, the device may not be recognized.
- ▶ Please connect a USB storage device with cable is offered by USB maker. If connected with cable is not offered by USB maker or an excessively long cable, the device may not be recognized.
- ▶ Some USB storage devices may not be supported or operated smoothly.
- ▶ If the name of a folder or file is too long, it will not be displayed or recognized.
- ▶ File alignment method is based on storage order in USB storage device.
- ▶ Please backup the important file because a data of USB device may be damaged. Data management is consumer's responsibility and in consequence the manufactures does not cover the product bearing data damage.
- ▶ If the quantity of folders and files is over 1,000, it will not be displayed or recognized about exceeded files and folders.
- ▶ It is supported for only primary partition. If there is an extended partition, it is not displayed or recognized.

Photo List

* It is available to playback the photo file(*.jpg) in the USB device.

The On Screen Display may be different from your set. Images are an example to assist with the projector operation.

Screen Components

1. Slide show the selected item.
2. Set the time interval of the slide show.
3. Listen to music while viewing photos in full size.
4. Moves to upper level file.
5. Corresponding buttons on the remote control

The screenshot shows the 'Photo List' screen. On the left, a 'Preview' window displays a photo of a butterfly with the file name 'LETY003' and '1366X768 1/1'. On the right, a 'List' window shows a directory structure: 'Up folder', 'AB101', 'LETY001', 'LETY002', and 'LETY003' (highlighted in red). A control panel at the bottom contains buttons for 'Move', 'OK', 'P Move Page', 'RETURN', and 'Exit'. Numbered callouts 1-5 point to: 1. Play button, 2. Timer button, 3. Music button, 4. List window, and 5. Bottom control bar.

Set up the menu in Full-Sized screen

* You can change the settings to display photos stored on a USB device, on a full-sized screen. Detailed operations are available on full-sized photo view screen.

1. Use \wedge , \vee button to select the desired photos.
2. Press the \odot **OK** button.
3. The selected photo is displayed in full size and show up the menu.

▶ \blacktriangle 90°	▶ \blacktriangledown 90°	(Rotate) : Rotate photos.
▶ ◀ Prev		: Display the previous photo viewing.
▶ ▶ Next		: Display the next photo viewing.
▶ ■ Stop		: Stop the viewing the photos.
▶ \odot Hide		: Hide the menu on the full-sized screen.

- To see the menu again on the full-sized screen, press ENTER button.



4. Press **USB** button to return to the **DivX** Home menu.

- On operating the JPEG viewing, press the **USB** button after pressing the **STOP** button to return to the DivX Home menu.

- The aspect ratio of a photo may change the size of the photo displayed on the screen in full size.



Viewing the Slide show

1. Use the \wedge or \vee button to select the desired photos.
2. Press the $<$ button to select  .
3. Press the \odot OK button.

▶ **Stop** : Stop the viewing the slide show.

▶ **Hide** : Hide the menu on the full-sized screen.

- To see the menu again on the full-sized screen, press \odot OK button.

4. Press the $<$ button to select  .
5. Use $<$ or $>$ button to control the time interval of the slide show.
6. Press the \odot OK button to store it.
7. Press the $<$ button to select  .
8. Press the \odot OK button to listen to music while viewing photos in full size.

Set the music device and album in Option.

 - You should memorize FAV list to operate this function in Music List.
9. Press **USB** button to return to the DivX Home menu.
 - On operating the Slideshow/BMG function, press the **USB** button after pressing the RETURN button to return to the DivX Home menu.

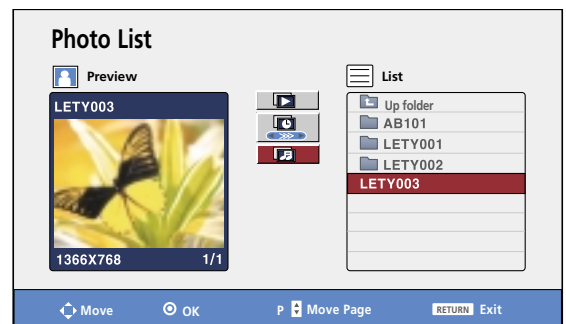
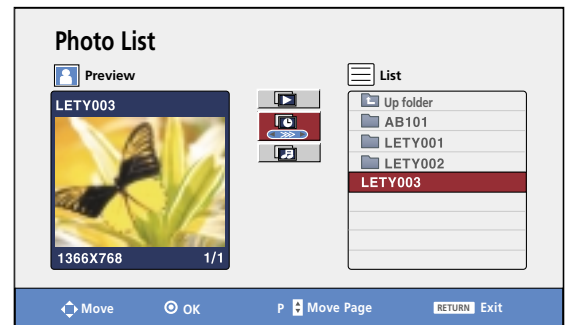
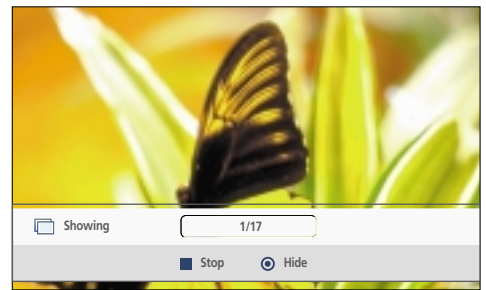
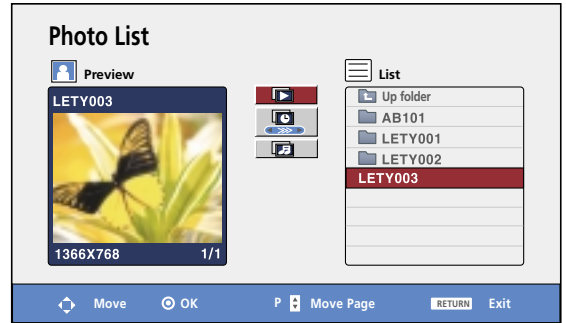

Note!

- If it is Progressive JPEG format, some photos may be not decoded.
- If the width of resolution is over 4800, it is not supported.
- When loading, some buttons may not work.

Music List

- * Purchased music files(*.MP3) may contain copyright restrictions. Playback of these files may not be supported by this model. Music file on your USB device can be played by this unit.
The On Screen Display may be different from your set. Images are an example to assist with the projector operation.

Screen Components

1. Moves to upper level file

2. Delete All : Delete all selected music.
• It is impossible to delete only one music in music list.

3. Corresponding buttons on the remote control

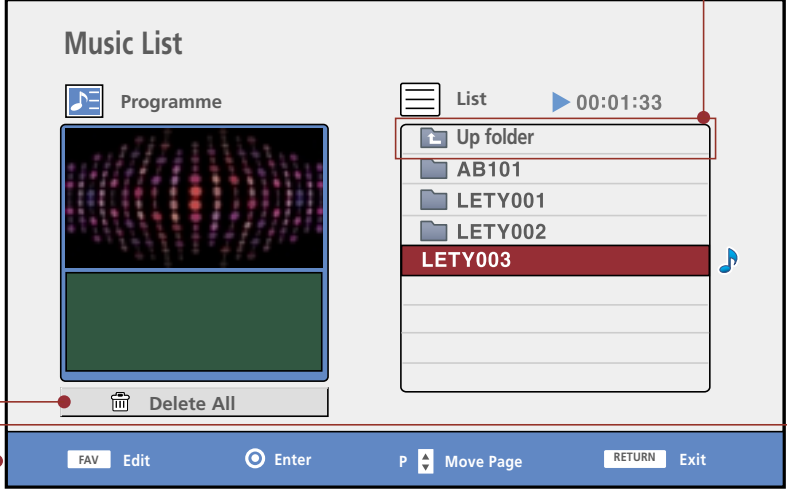

The screenshot shows the 'Music List' interface. On the left, there is a 'Programme' section with a visualizer. On the right, a 'List' section shows a directory tree with folders 'Up folder', 'AB101', 'LETY001', 'LETY002', and 'LETY003'. The 'LETY003' folder is selected and highlighted in red. A red box highlights the 'Up folder' button, and another red box highlights the 'Delete All' button. A third red box highlights the bottom navigation bar containing buttons for 'FAV Edit', 'Enter', 'Move Page', and 'RETURN Exit'.

1. a. If you want to listen to music, use the \wedge or \vee button to select music.
- b. Press the \odot OK button to play the music.
- c. All music in selected folder is played, repeatedly.

2. a. If you want to listen to several music in sequence, use the \wedge or \vee button to select music.
- b. Press FAV button and then use \odot OK button to make music list.
 - When FAV button is pressed,  is displayed and then it is possible to edit music list.
- c. To make music list, repeat steps a to b.
- d. Press $<$ button and then use \odot OK button to play music in music list.
- e. Up to 30 files are stored.

3. Press **USB** button to return to the DivX Home menu.
 - On operating the MP3 playing, press the USB button after pressing the RETURN button to return to the DivX Home menu.

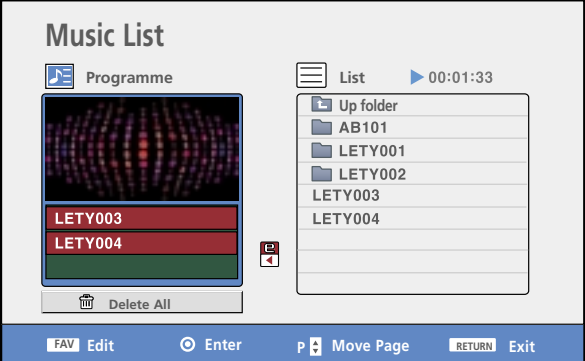

The screenshot shows the 'Music List' interface with a playlist. The 'List' section shows folders 'Up folder', 'AB101', 'LETY001', 'LETY002', and a playlist containing 'LETY003' and 'LETY004'. The 'FAV Edit' button is visible in the bottom navigation bar.

- If you don't press any button for a while during the playing, the play information box (as shown in the below) will float as a screen saver.
- The 'Screen Saver'?
Screen saver is to prevent screen pixel damage due to an fixed image remaining on the screen for a extended period of time.
- If you press **OK** , **RETURN** buttons, screen saver is stopped.



Note!

- When music is playing,  is displayed in Back of the music title.
- A music downloaded from a paid service with copyright protection does not start but displays inappropriate information in playtime.
- The **◀▶** buttons on the remote control are not available in this mode.
- Customer should note that permission is required in order to download MP3 files form the internet, our company has no right to guarantee such permission, permission should always be sought from the copyright owner.
- When loading, some buttons may not work.

Supported music file: *.MP3

Sampling Frequency : 32 ~ 48kHz

Bit rate : 32 ~ 320kbps

Movie List

* The movie list is activated once USB is detected. It is used when playing movie files on PROJECTOR.

Displays the movies in the USB folder and supports play.

Allows playback of all movies in the folder and user desired files.

Editing such as delete and add is not allowed.

It is a movie list that displays folder information and DivX file.

Screen Components

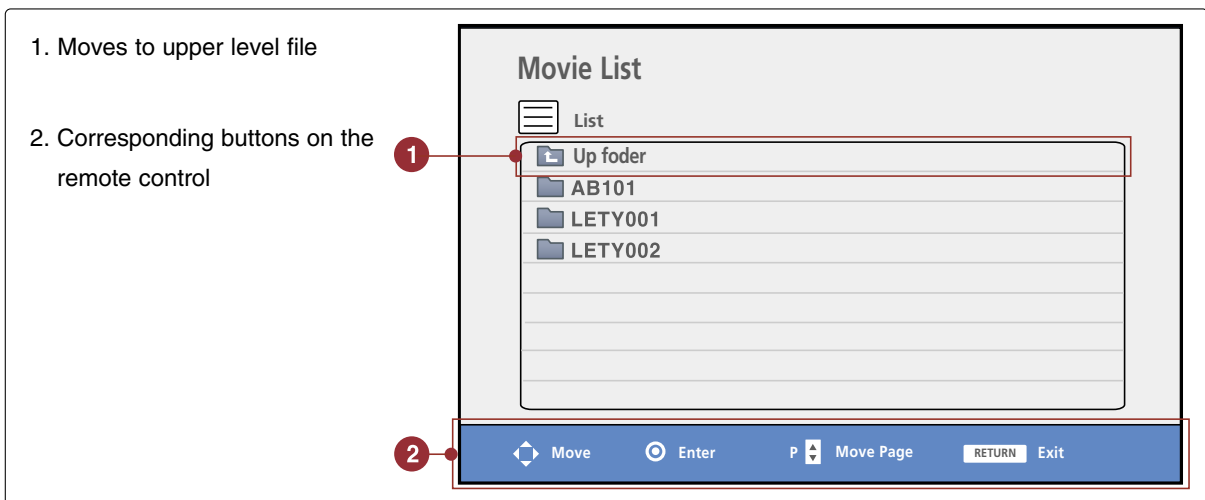

1. Use the \wedge or \vee button to select the desired movie titles.

2. Press the \odot OK button to play the movie and show the menu.

Control	Language	Position	Sync	Aspect Ratio
\vee To set	\odot Hide			
< On >				

- ▶ **Control** : Turns the subtitle display on and off during movie play.
- ▶ **Language** : Changes the Language Group of the subtitle during movie play.
- ▶ **Position** : Changes the position of the subtitle either up or down during movie play.
- ▶ **Sync** : Adjusts the time synchronisation of the subtitle from -5 secs ~ +5 secs by steps of 1 secs during movie play.
- ▶ **Aspect Ratio** : Adjusts the picture formats ; 4:3 or 16:9

- To see the menu again on the full-sized screen, press \odot OK button.

3. Press **USB** button to return to the DivX Home menu.

- On operating the movie playing, press the **USB** button after pressing the RETURN button to return to the DivX Home menu.

DivX Audio Language & Subtitle Language

- When DivX is playing, if you press the **OK** button and then select language, this message is displayed.

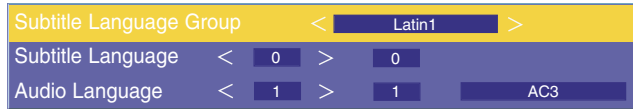

Press the **^ v < >** button to select the desired option.

Supports up to Mpeg, Mp3, PCM, Dolby D file.

DivX registration code

Confirm the DivX registration code number of the projector. Using the registration number, movies can be rented or purchased at www.divx.com/vod.

With a DivX registration code from other projector, playback of rented or purchased DivX file is not allowed. (Only DivX files matched with the registration code of the purchased projector are playable.)

1. Press the **MENU** button and then use **< , >** button to select the menu.
2. Press the **^ , v** button to select **DivX Reg. Code** item.
3. Press the **OK** button.

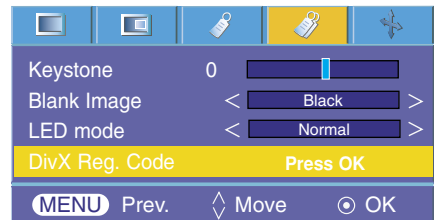

- Press the **MENU** button twice or the **RETURN** button to exit the menu screen.

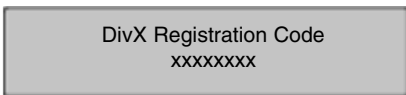

- Official DivX[®] Certified Product
- “Plays all versions of DivX[®] video (including DivX[®] 6) with standard playback of DivX[®] media files”
- DivX[®] Certified Products: “DivX, DivX Certified, and associated logos are trademarks of DivX, Inc. and are used under license.”

Note!

Supported movie file

Resolution : under 720x480(720x576) WxH pixels.

Frame rate : under 30 frames/sec

- Video Codec : MP 43, DIVX_3_11, DIVX_4_12, DIVX_5_0, XVID, MP4S, RMP4, MP4V, _3IVX.
- Files supported : *.avi, *.mpg, *.mpeg, *.divx
- When loading, some buttons may not work.



Manufactured under license from Dolby Laboratories. “Dolby” and the double-D symbol are trademarks of Dolby Laboratories.

Supported Monitor Display

* The following table lists the display formats supported by the projector.

Sources	Format	Vertical Freq.(Hz)	Horizontal Freq.(kHz)
VGAEGA	640X350	70.090	31.468
	640X350	85.080	37.861
PC98	640X400	70.090	31.468
	640X400	85.080	37.861
	720X400	70.082	31.469
	720X400	85.039	37.927
VGA	640X480	59.940	31.469
	640X480	72.800	37.861
	640X480	75.000	37.500
	640X480	85.008	43.269
SVGA	800X600	56.250	35.156
	800X600	60.317	37.879
	800X600	72.188	48.077
	800X600	75.000	46.875
	800X600	85.061	53.674
XGA	1024X768	60.004	48.363
	1024X768	70.069	56.476
	1024X768	75.029	60.023
SXGA	1152X864	60.053	54.348

* If the projector does not support the input signal, "Out of Range" message appears on the screen.

* The projector supports DDC1/2B type as Plug & Play function. (Auto recognition of PC monitor)

* The Synchronization input form for horizontal and vertical frequencies are Separate.

* According to PC, the optimum vertical frequency may not be displayed up to the optimum frequency of set in 'Registration information (Display registration information)'. (ex, The optimum vertical frequency may be displayed up to 85Hz or under in the resolution of 640X480 or 800X600.)

<DVD/DTV Input>

Signal	Component-*1	RGB(DTV)-*2
NTSC(60Hz)	480i	O
	480p	O
	720p	O
	1080i	O
PAL(50Hz)	576i	X
	576p	O
	720p	O
	1080i	O

* Cable type

1- RGB to Component Cable

2- Computer Cable

* Recommended 720p for a better image.

Maintenance

* The projector needs little maintenance. You should keep the lens clean because any dirt or stains may appear on the screen. If any parts need to be replaced, contact your dealer. When cleaning any part of the projector, always turn the power off and unplug the projector first.

Cleaning the lens

If there is any dust or stain on the surface of the lens, you must always clean the lens. Use an air spray or cleaning cloth for product exterior, provided with the product, to lightly clean the product. When you want to remove dust or stain on the lens, use the air spray or cloth for product exterior, provided with the product, with neutral detergent and water.

Cleaning the Projector Case

To clean the projector case, first unplug the power cable. To remove dirt or dust, wipe the casing with polish cloth provided. When you want to remove the dust or stain on the lens, use the cloth for product exterior, provided with the product. Do not use alcohol, benzene, thinners or other chemical detergents as these can cause the casing to be warped or discolored.

Specifications

MODEL	HS102 (HS102-JE) / HS102G (HS102G-JE)
Resolution	800(Horizontal) x 600(Vertical)pixel
Horizontal / Vertical Ratio	4:3(horizontal:vertical)
DLP panel size	0.55 inches
Screen size (Projection distance)	0.40 ~ 2.23m(15 ~ 80 inches)
Projection OFF SET	100%
Remote control distance	6m
Video compatibility	NTSC/PAL/SECAM/NTSC4.43/PAL-M/PAL-N
Power	19V  , 6.3A
AC-DC Adapter	LG, PA-1121-04
Height(mm/inches)	50/2.0
Breadth(mm/inches)	154/6.1
Length(mm/inches)	117/4.6
Weight(g/pound)	780/1.72

Operating Condition

Temperature

In operation : 32~95°F(0°C~35°C)
In storage and transit : -4~140°F(-20°C~60°C)

Humidity

In operation : 0~ 75% relative humidity by dry hygrometer
Not in operation : 0 ~ 85% relative humidity by dry hygrometer

