

Welcome:

Thank you kindly for purchasing this fine product.

Much investment in time and effort has gone into its development, and it is our hope that it will give you many years of trouble-free service.

Safety Notice:

1. Do not drop, puncture or disassemble the device; otherwise the warranty will be voided.
2. Avoid all contact with water, and dry hands before using.
3. Do not expose the device to high temperature or leave it in direct sunlight. Doing so may damage the device.
4. Use the device with care. Avoid pressing hard on the device body.
5. For your own safety, avoid using the device when there is a storm or lightning.
6. Do not use batteries of different specifications. Doing so may lead to the potential for serious damage.
7. Remove the battery during long periods between usage, as a deteriorated battery may affect the functionality of the device.
8. Remove the battery if it shows signs of leaking or distortion.
9. Use only the accessories supplied by the manufacturer.
10. Keep the device out of the reach of infants.
11. Risk of explosion if battery is replaced by an incorrect type.
12. Dispose of used batteries according to the instructions.

FCC Compliance Statement:

This device complies with Part 15 of the FCC Rules. Operation is subjected to the following two conditions: (1) this device may not cause harmful interference, and (2) this device must accept any interference received, including interference that may cause undesired operation.



This equipment has been tested and found to comply with limits for a Class B digital device, pursuant to Part 15 of the FCC rules. These limits are designed to provide reasonable protection against harmful interference in residential installations. This equipment generates, uses, and can radiate radio frequency energy, and if not installed and used in accordance with the instructions, may cause harmful interference to radio communications.

However, there is no guarantee that interference will not occur in a particular installation. If this equipment does cause interference to radio or television equipment reception, which can be determined by turning the equipment off and on, the user is encouraged to try to correct the interference by one or more of the following measures:

- Reorient or relocate the receiving antenna.
- Move the equipment away from the receiver.
- Plug the equipment into an outlet on a circuit different from that to which the receiver is connected.
- Consult the dealer or an experienced radio/television technician for additional suggestions.

You are cautioned that any change or modifications to the equipment not expressly approved by the party responsible for compliance could void Your authority to operate such equipment.



If the time arises to throw away your product, please recycle all the components possible.

Batteries and rechargeable batteries are not to be disposed in your domestic waste! Please recycle them at your local recycling point.

Together we can help to protect the environment.

Table of Contents

Getting Started	1
Projector parts	1
Reading LED indicators	2
Installing the battery.....	2
Charging the battery	2
Inserting a memory card (optional).....	3
Turning on/off your projector.....	3
Adjusting the Focus	3
Functions and Operations	4
Introduction to main menu	4
Setting language.....	4
Checking Memory.....	5
Playing Video.....	6
Playing back still pictures.....	7
Playing back Powerpoint/PDF files.....	7
Inserting MP3 music into photo playing	8
Zoom function	8
Playing back Music.....	9
Repeat playing video, still picture or music	9
Playing back files in other devices.....	10
Menu operation.....	12
Menu items in Settings mode	12
Managing the files in built-in memory or memory card from PC.....	13
Remote Controller.....	14
Battery Life Indicator.....	14
Specifications.....	15

Getting Started

● Projector parts

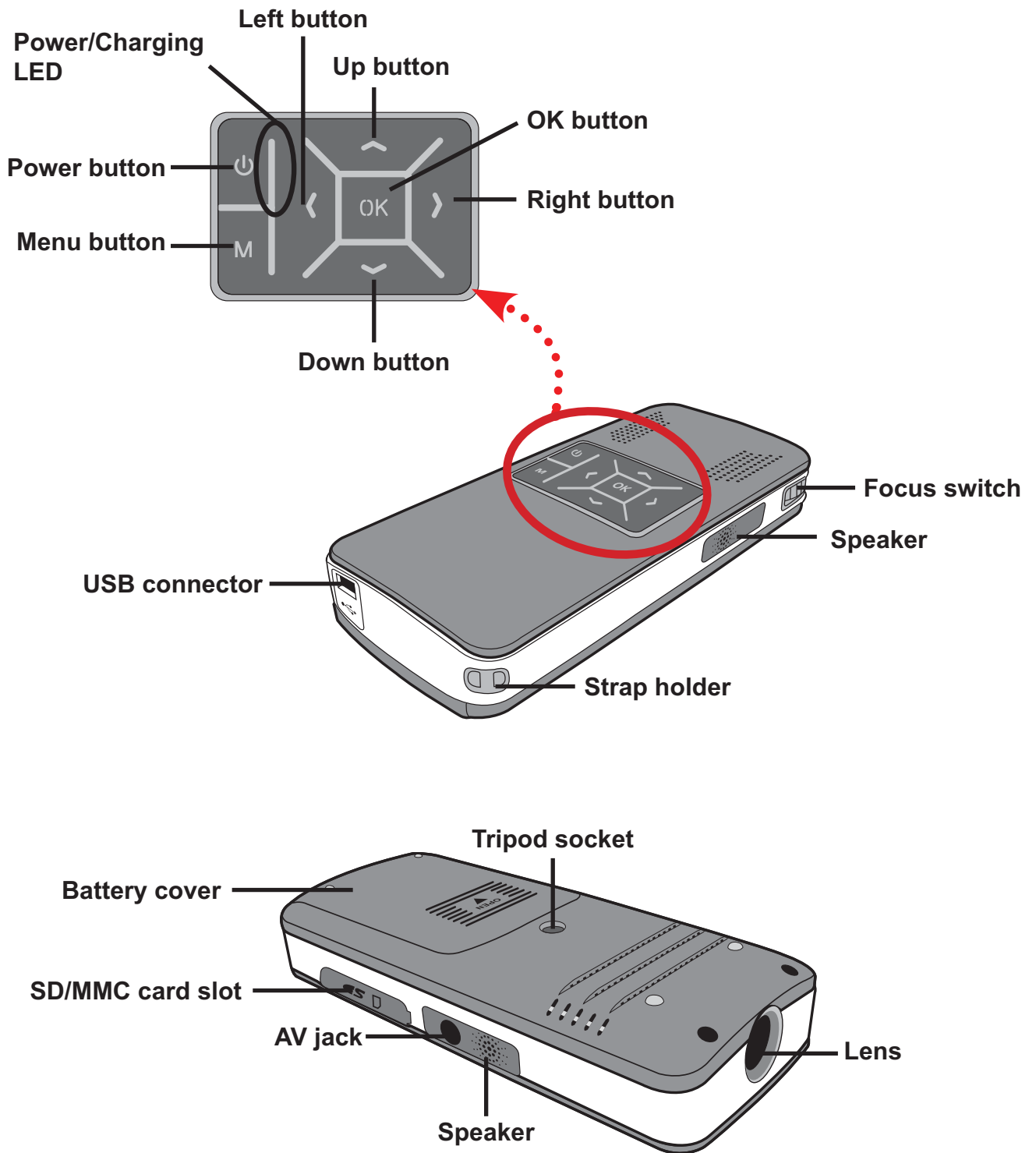

● Reading LED indicators

The **Power LED** is lighting orange when projector is charged.

Only **Power LED** is lighting green when connected with AC power adapter in standby mode or complete charged mode.

If all of the LEDs are turned on, projector is in operation mode.

● Installing the battery

1. Slide the battery cover open.
2. Place the included Li-Ion battery into the compartment. Note that the metallic contacts must be aligned with the contacts in the compartment.
3. After the battery is properly installed, replace the battery cover.

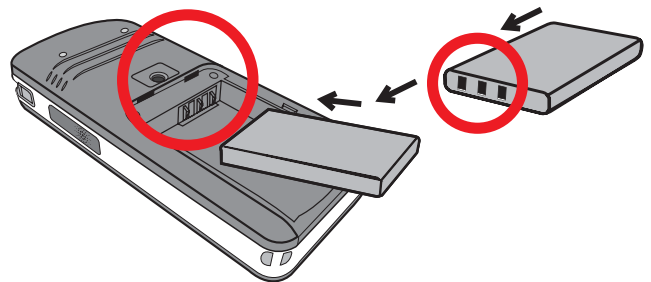

● Charging the battery

Please charge the battery at least 3 hours prior to its first use.

1. Connect the cable.
Connect one end of the supplied AC adapter to the USB port of the projector and the other end to a wall outlet.
OR
Connect one end of the supplied USB cable to the USB port of the projector and the other end to a powered PC. Make sure the projector is powered off.
2. The charging LED turns orange and the charge starts.
3. When the charging is interrupted or the battery pack is fully charged, the charging LED will turn green.



! When using a PC to charge the battery, do not turn on the projector, or the charge will stop.

● Inserting a memory card (optional)

To insert a memory card, do the following:

- (1) Open the SD card cover.
- (2) Gently push the card as indicated until the card reaches the bottom of the slot.

To remove the memory card, gently push it down and it will pop up. Then pull the card out of the slot.



● Turning on/off your projector

Press and hold down the **Power** button for **4** seconds to turn on the projector.

To turn off the projector, press and hold down the **Power** button for 2 seconds.

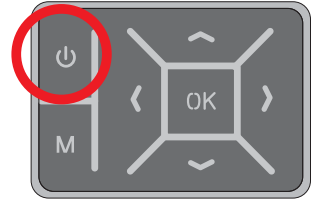

● Adjusting the Focus

Please adjust the **Focus switch** to have a better view during usage.



Functions and Operations

● Introduction to main menu

After turn on the projector, you will see “**Welcome**” screen first then main menu as below.

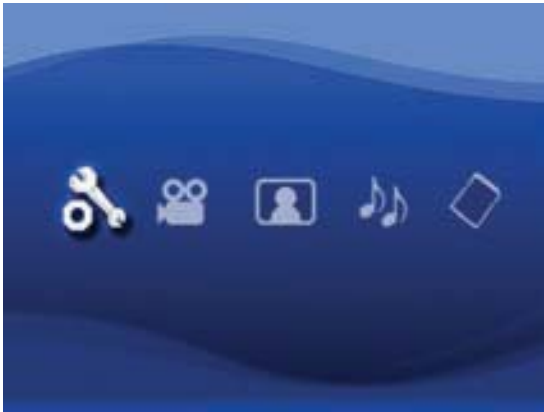

- **Settings:** This function allows users to set some preference settings such as **Language, Brightness, Contrast, Saturation, Slideshow Speed, Auto power off** and **Beep sound**.
- **Video:** This function allows users to select video file to project from screen.
- **Photo:** This function allows users to select JPEG image file to project from screen.
- **Music:** This function allows users to select MP3 files to play from the projector.
- **Memory:** This function allows users to check the available memory type and capacity and select it for target source for projection.



● Setting language

1. Turn on the projector. The main menu will appear.
2. Use the **Left/Right** button to select the **Settings** mode and press **OK** to enter the menu screen.
3. Use the **Up/Down** button to select the **Language** item, and then Press the **Right** button.
4. Move the **Up/Down** button to select a language.
5. When done, press **OK** to confirm the setting.

● Checking Memory

This function is to select which memory type to playback from and its capacity and available size. The default is built-in memory.

1. Use the **Left/Right** button to select “**Memory**” and then press **OK** button.
2. The Memory Check box will display as below. Use the **Up/Down** button to select the memory type.

Selection	Memory	Available/Capacity
√		669MB / 979MB
		1.9GB / 1.9GB

3. Press **OK** button after selection to return to the main menu.

❗ If there is no memory card inserted, the screen will only show internal built-in memory status.

● Playing Video

1. Use the **Left/Right** button to select “**Video**” and then press **OK** button.
2. Use the **Up/Down** button to select target folder or video files to see the first screen of each video. Press the **OK** button to confirm the selection. (Some larger files may require more time to switch.)
3. When selecting one Video file, press **OK** to play it back. (play once only)
4. Use the **Left/Right** button to backward or forward to another video.
5. You can use **Up/Down** button to control volume.
6. Press **OK** can pause video, and press **OK** again can resume playing.

- ! It's normal that the projector will feel warm with continuous use due to its high performance.
- ! Sometimes your video files with MP4, ASF or AVI file formats may not be able to play back by this projector. Please try using bundled ArcSoft Media Converter (AMC) program to convert video files into formats optimized for use on this projector. But it is not guaranteed that all of the input video files can be accepted by AMC for file conversion.

Supported file types for conversion (Input file formats)

- Windows AVI files (*.AVI)
- Advanced Systems Format (*.ASF)
- Video CD (*.DAT)
- Quick Time files (*.MOV)
- MP4 files (*.MP4; *.M4V)
- MPEG (*.MPG; *.MPEG; *.MPE)
- RealMedia Video (*.RMVB)
- Windows Media Video (*.WMV)

Supported file types for export

- MJPEG AVI (recommended)
- MPEG-4 ASF

For details information, please check the “Help” under Extra from AMC program or visit AcrSoft web site at www.arcsoft.com to understand the key features and how to use.

● Playing back still pictures

1. Use the **Left/Right** button to select “**Photo**” and then press **OK** button.
2. Use the **Up/Down** button to select target folder or photo to see the pre-view image. Press the **OK** button to confirm the selection.
3. After a photo is selected, press **OK** to display full size of this photo.
4. Use the **Left/Right** button to display last or next photo.

● Playing back Powerpoint/PDF files



When giving a presentation using PowerPoint/PDF documents, please save the PPT/PDF file into .jpeg format.

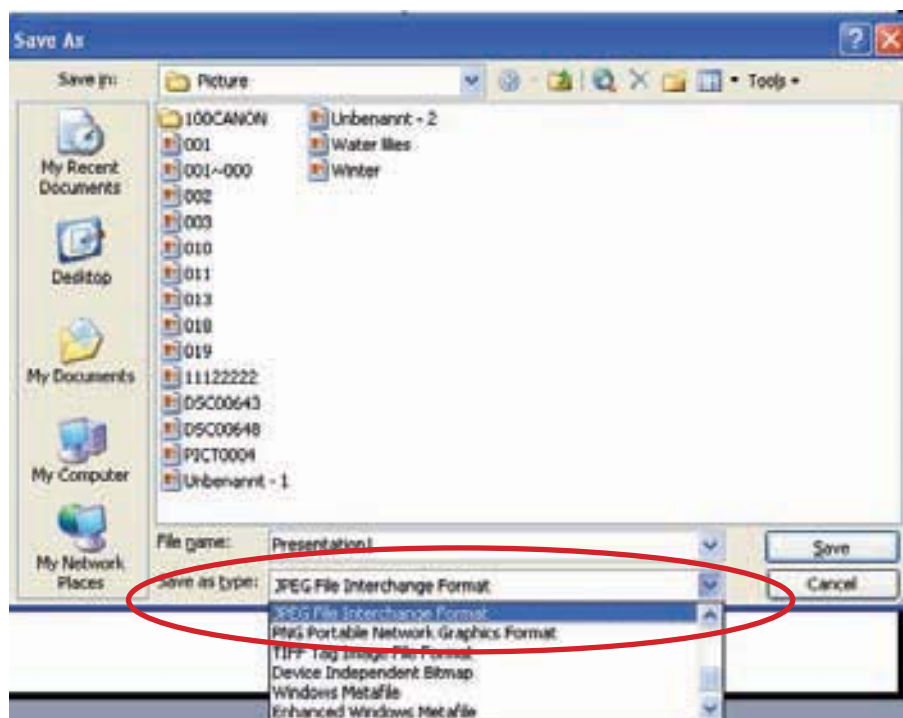

1. Execute PowerPoint/Acrobat program first.
2. Open the PPT/PDF file.
3. Launch “**File**” > “**Save as**” dialogue, then select “**JPEG File Exchange Format**” from “**Save as type**” drop-down list.
4. Rename the file if necessary:
The playback sequence is in the order of the first digit Arabic numerals, such as 1, 10, 100, 101, 11, then 2, 20, 21, and so on. To avoid playback order confusion, please rename the file 1 ~ 9 as 01 ~ 09, 100 as A100, etc.



● Inserting MP3 music into photo playing

1. Press **Menu** button for 2 seconds to show the function bar on the screen bottom.

2. Use the **Up/Down** button to select  (default setting) or .

Select  to play MP3 files in the same folder of displayed picture (s) and  to disable this function.

! If you cannot hear music, please check if there are MP3 files in the same folder of the displayed picture (s).

● Zoom function

1. Press **Menu** button for 2 seconds to show the function bar on the screen bottom.
2. Use the **Left/Right** button to select “**Zoom-in**” mode and use **Down** button to enter **Zoom** mode. A small Zoom screen will appear on the right down corner.
3. Press **Up** button to go for Zoom x2, x3, x4, x1 or **Down** button for x4, x3, x2, x1 step by step.
4. When you are in magnification of x2, x3 or x4, the Zoom screen will indicate the area of the original photo being displayed.
5. Press and hold **Right, Left, Up** or **Down** button to move the view screen around the photo.
6. Press **Menu** button to return to x1 stage and press **Menu** button again to exit the **Zoom-in** mode.

● Playing back Music

1. Use the **Left/Right** button to select “**Music**” and then press **OK** button.
2. Use the **Up/Down** button to select target folder or MP3 files. Press the **OK** button to confirm the selection.
3. After one MP3 file is selected, press **OK** to play it back. (play once only)
4. Use the **Left/Right** button to playback last or next mp3 file.
5. When MP3 is playing, use the **Up/Down** button to adjust the volume up and down.
6. Press **OK** can pause music, and press **OK** again can resume playing.
7. Using headphone to listen to music. (also suitable for playing video)
 - 1) Connect headphone to AV jack of projector.
 - 2) Press **OK** to select “Audio Out”.

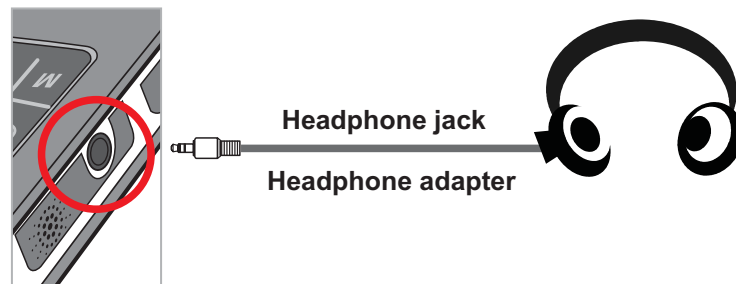





! If the projector stays inactive for 20 seconds, the screen will automatically turn off.

● Repeat playing video, still picture or music

The default setting is to play selected **video, still picture or music** once. If users want to repeat the **video, still picture or music (s)**, please do the following:

1. During the playing back of video, photo, or music, press **Menu** button for 2 seconds to show the function bar on the screen bottom.

2. Use the **Up/Down** button to select , , or .

 (default setting): No repeat play

 : Play the **video, still picture or music (s)** in the same folder

 : Play the **video, still picture or music (s)** in the memory card or internal built-in memory.

● Playing back files in other devices

▶ Connecting the projector to your media players

Steps of connecting projector with external player:

Before connecting your media player to projector, you need to have media player dedicated composite AV-out cable and projector AV cable ready.

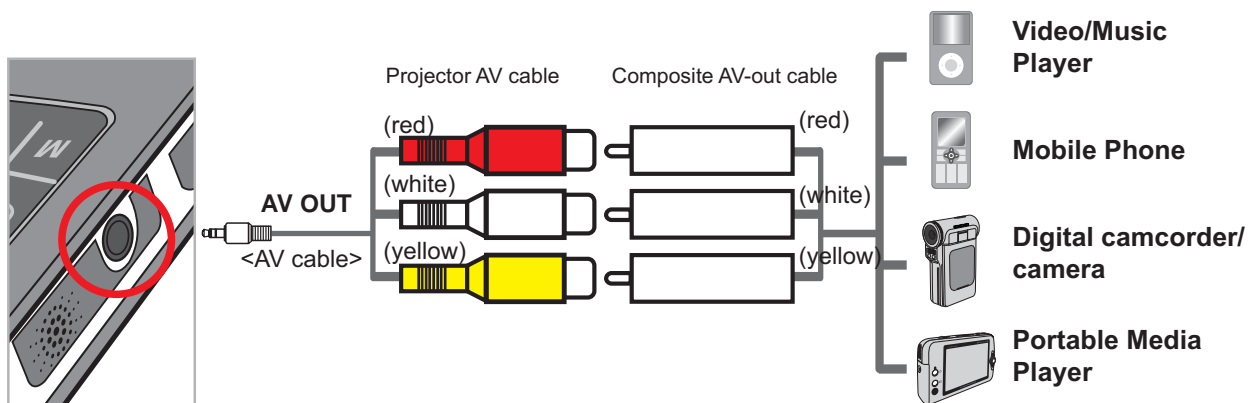

1. Connect Composite AV-out cable to media player.
2. Connect both AV cables (Yellow to Yellow, white to white and red to red).
3. Select "AV in" when you are asked to select "AV in" or "Audio out".
4. Now you can project image and audio from projector. You also can control the volume from control panel (**Up/Down** button).

● Menu operation

The menu items provide several options for you to fine-tune your projector functions. The following table gives details on menu operations.

How to...	Action
Bring up the menu	Press the MENU button.
Move the highlight bar	Use the Up/Down button or Left/Right button.
Enter sub-menu/Confirm an item	Press the OK button.
Exit menu/Go back to upper menu	Press the MENU button (when in sub-menu).

● Menu items in Settings mode

Power-on → Select the **Settings** mode → Press the **OK** button.

Item	Option	Description
Language	-	Lets you select the language used for OSD.
Brightness	-4 ~ +4	Set projection screen brightness.
Contrast	-4 ~ +4	Set projection screen contrast.
Saturation	-4 ~ +4	Set projection screen color saturation.
Slideshow Speed	3 sec, 5 sec, 8 sec, 15 sec	Set the interval time between each slide
Auto Power Off	Off	Disable Auto-off function.
	3 min	The projector automatically shuts down when staying inactive for over 3 minutes.
	5 min	The projector automatically shuts down when staying inactive for over 5 minutes.
Beep	On	Enable beep sound.
	Off	Disable beep sound.
Default	Yes	Restore factory defaults. Note that your current settings will be overridden.
	No	Cancel action.

● Managing the files in built-in memory or memory card from PC

Please follow the procedures below to manage files in either built-in memory or memory card.



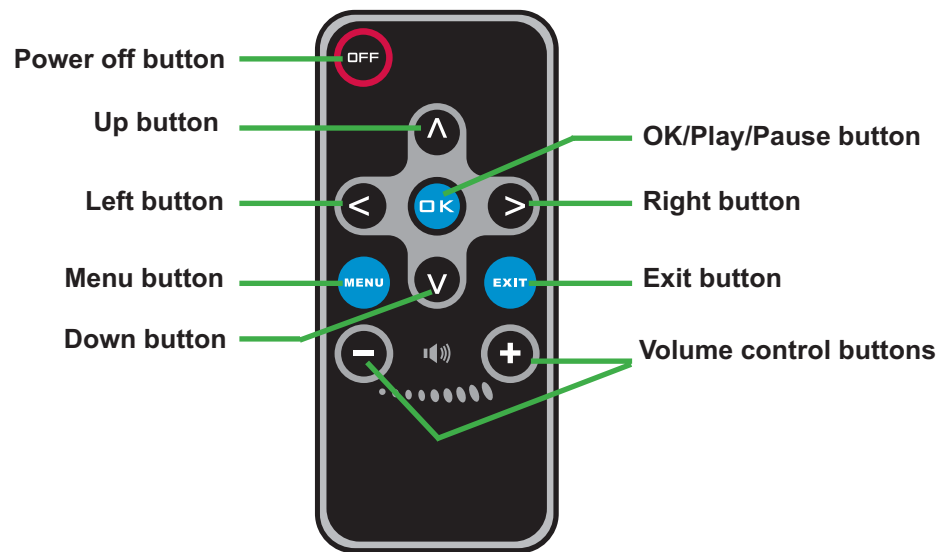

1. Make sure the projector is powered off if the battery is installed.
2. Connect one end of the bundled USB cable to the USB port of the projector and the other end to a powered PC.
3. Turn on the projector:
Press and hold down the **Power** button for 4 seconds till you hear music.
4. A removable disk will appear in your computer.

- ❗ PC can only recognize one storage medium each time (check memory card first, then built-in memory if no memory cards is inserted).
- ❗ Do not switch the storage medium during operation.
- ❗ When connecting the projector to PC USB port without turning on the projector, the PC starts charging the battery inside the projector. To read the files in the memory, press the **Power** button or remove the battery first.

● Remote Controller



● Battery Life Indicator

Icon	Description
	Full battery life
	Moderate battery life
	Low battery life
	Empty battery life

Note 1: To avoid sudden outage of power supply, you are recommended to plug AC power adapter first then take off the battery when the icon indicates low battery life.

Note 2: When “Battery Low” message appeared on the screen, the projector will be powered off automatically.

● Specifications

Item	Description
Optical Technology	LCoS
Light Source	White LED
Aspect Ratio	4:3
Luminous Flux	10 Lumens (Max.)
Resolution	640 x 480 (VGA)
Projection Image Size	6" ~ 50" (15cm ~ 127cm) (Diagonal)
Projection Distance	25cm ~ 180cm
Zoom & Focus	Manual
Projection Source	External from 3-in-1 AV jack, built-in memory or memory card
Play back format	Photo: .JPEG Audio: .MP3 Video: .MPEG-4 (.AVI, .ASF, .MP4), H.264 (.MP4), M-JPEG (.AVI) through ArcSoft Media Converter.
Audio speaker	Stereo (0.5W x 2)
Memory Slot	SD/SDHC/MMC/MS Pro
Power Supply	AC power adapter or NP120 Li-Lon rechargeable battery
Operation temperature	0°C ~ 35°C
Dimension	125mm x 55mm x 23mm
Weight	100g (without battery)

Note: Specifications are subject to change without notification.