

## LCD Projector

# MC-AW3506/MC-AW3006 MC-AX3506/MC-AX3006

## User's Manual (detailed) Operating Guide

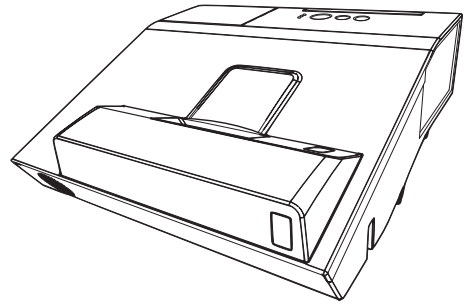

Thank you for purchasing this projector.

**⚠ WARNING** ▶ Before using this product, please read all manuals for this product. Be sure to read “**Safety Guide**” first. After reading them, store them in a safe place for future reference.

### About this manual

Various symbols are used in this manual. The meanings of these symbols are described below.

**⚠ WARNING** This symbol indicates information that, if ignored, could possibly result in personal injury or even death due to incorrect handling.

**⚠ CAUTION** This symbol indicates information that, if ignored, could possibly result in personal injury or physical damage due to incorrect handling.

**NOTICE** This entry notices of fear of causing trouble.

 Please refer to the pages written following this symbol.

**NOTE** • The information in this manual is subject to change without notice.  
• The illustrations in this manual are for illustrative purposes. They may differ slightly from your projector.  
• The manufacturer assumes no responsibility for any errors that may appear in this manual.  
• The reproduction, transfer or copy of all or any part of this document is not permitted without express written consent.

# Contents

<b>Introduction</b> . . . . .	<b>3</b>	<b>INPUT menu</b> . . . . .	<b>44</b>
Features . . . . .	3	PROGRESSIVE, VIDEO NR, COLOR SPACE,	
Checking the contents of package . . .	3	VIDEO FORMAT, HDMI RANGE, COMPUTER IN,	
Part names . . . . .	4	FRAME LOCK, RESOLUTION	
<b>Setting up</b> . . . . .	<b>7</b>	<b>SETUP menu</b> . . . . .	<b>48</b>
Arrangement . . . . .	7	D-ZOOM, D-SHIFT, PICT.POSIT.H,  KEYSTONE,	
Connecting with your devices . . . . .	10	 KEYSTONE, PERFECT FIT, LAMP & FILTER,	
Connecting to a power supply . . . . .	16	IMAGE OPTIMIZER, INSTALLATION, STANDBY MODE	
Using the security bar and slot . . . . .	16	<b>AUDIO menu</b> . . . . .	<b>54</b>
Using the cable cover . . . . .	17	VOLUME, SPEAKER, AUDIO SOURCE,	
<b>Remote control</b> . . . . .	<b>18</b>	MIC VOLUME	
Installing the batteries . . . . .	18	<b>SCREEN menu</b> . . . . .	<b>55</b>
About the remote control signal . . .	19	LANGUAGE, MENU POSITION, BLANK,	
Changing the frequency of remote control signal . .	19	AUTO BLANK, START UP, MyScreen,	
Using as a simple PC mouse & keyboard . .	20	MyScreen Lock, MESSAGE, SOURCE NAME,	
<b>Power on/off</b> . . . . .	<b>21</b>	TEMPLATE, C.C.	
<b>Operating</b> . . . . .	<b>24</b>	<b>OPTION menu</b> . . . . .	<b>61</b>
Adjusting the volume . . . . .	24	SEARCH SKIP, AUTO SEARCH,	
Temporarily muting the screen and		DIRECT POWER ON, AUTO POWER OFF,	
audio output . . . . .	24	MY BUTTON, SCHEDULE, SERVICE	
Selecting an input signal . . . . .	25	<b>NETWORK menu</b> . . . . .	<b>76</b>
Selecting an aspect ratio . . . . .	25	<b>SECURITY menu</b> . . . . .	<b>77</b>
Adjusting the projector's elevator . .	26	SECURITY PASSWORD CHANGE,	
Adjusting the zoom and focus . . . . .	26	MyScreen PASSWORD, PIN LOCK,	
Using the automatic adjustment feature . .	27	MY TEXT PASSWORD, MY TEXT DISPLAY,	
Using the TEMPLATE feature . . . . .	28	MY TEXT WRITING, CLONING LOCK	
Other buttons . . . . .	28	<b>Presentation tools</b> . . . . .	<b>82</b>
Adjusting the position . . . . .	29	PC-LESS Presentation . . . . .	82
Correcting the keystone/perfect fit		USB Display (Windows® computer) . .	92
distortions . . . . .	29	USB Display (Mac® computer) . . . . .	96
Using the magnify feature . . . . .	30	<b>Maintenance</b> . . . . .	<b>100</b>
Temporarily freezing the screen . . .	31	Replacing the lamp . . . . .	100
Using the menu function . . . . .	32	Cleaning and replacing the air filter .	102
<b>EASY MENU</b> . . . . .	<b>34</b>	Installing or replacing the	
ASPECT, D-ZOOM,  KEYSTONE,  KEYSTONE,		internal clock battery . . . . .	104
PERFECT FIT, PICTURE MODE, ECO MODE,		Caring for the projection window . . .	105
INSTALLATION, RESET, FILTER TIME, LANGUAGE,		Other care . . . . .	106
ADVANCED MENU, EXIT		<b>Troubleshooting</b> . . . . .	<b>107</b>
<b>PICTURE menu</b> . . . . .	<b>37</b>	Related messages . . . . .	107
BRIGHTNESS, CONTRAST, HDCR,		Regarding the indicator lamps . . .	109
ACCENTUALIZER, GAMMA, COLOR TEMP,		Resetting all settings . . . . .	112
COLOR, TINT, SHARPNESS, ACTIVE IRIS, MY MEMORY		Phenomena that may be easy to	
<b>IMAGE menu</b> . . . . .	<b>41</b>	be mistaken for machine defects . .	112
ASPECT, OVER SCAN, V POSITION, H POSITION,		<b>Specifications</b> . . . . .	<b>118</b>
H PHASE, H SIZE, AUTO ADJUST EXECUTE			

## Introduction

### Features

The projector provides you with the broad use by the following features.

- ✓ The unique optics system produces a large projected image in a short distance, which provides you with various ways of use.
- ✓ This projector has a variety of I/O ports that supposedly cover for any business scene.
- ✓ The **HDMI** port can support various image equipment which have digital interface to get clearer pictures on a screen.
- ✓ Has an HDCR and an ACCENTUALIZER features which are original image stabilizer for a clearer image.
- ✓ Has a DICOM<sup>®</sup> ("Digital Imaging and Communication in Medicine") simulation mode. This mode simulates the DICOM standard, which is a standard applicable to digital communications in medicine.
- ✓ This projector can be controlled and monitored via LAN connection. Furthermore, you can use the designated USB wireless adapter (optional) to establish wireless LAN connection.
- ✓ The built-in 16W speaker can deliver sufficient sound volume in a large space like a classroom without external speakers.
- ✓ This projector's network supports the PJLink<sup>™</sup> standard. PJLink<sup>™</sup> is a unified standard for operating and controlling data projectors. For specifications of PJLink<sup>™</sup>, see the web site of the PJLink<sup>™</sup>.
- ✓ Equipped with IMAGE OPTIMIZER which is original function to maintain visibility by automatic image correction in accordance with lamp deterioration.

### Checking the contents of package

Please see the **Contents of package** section in the **User's Manual (concise)** which is a book. Your projector should come with the items shown there. Require of your dealer immediately if any items are missing.

**NOTE** • Keep the original packing materials, for future reshipment. Be sure to use the original packing materials when moving the projector. Use special caution for the lens.

## Part names

### Projector

(1) Lamp cover (📖100)

The lamp unit is inside.

(2) Control panel (📖5)

(3) Elevator feet (x 2) (📖26)

(4) Remote sensor (x 2)(📖19)

(5) projection window (📖105)

(6) Intake vents

(7) Filter cover (📖102)

The air filter and intake vent are inside.

(8) Speaker (📖13, 24, 54)

(9) Exhaust vent

(10) **AC** (AC inlet) (📖16)

(11) Ports (📖5)

(12) Security bar (📖16)

(13) Security slot (📖16)

(14) Spacer (x 2) (📖26)

(15) Battery cover (📖104)

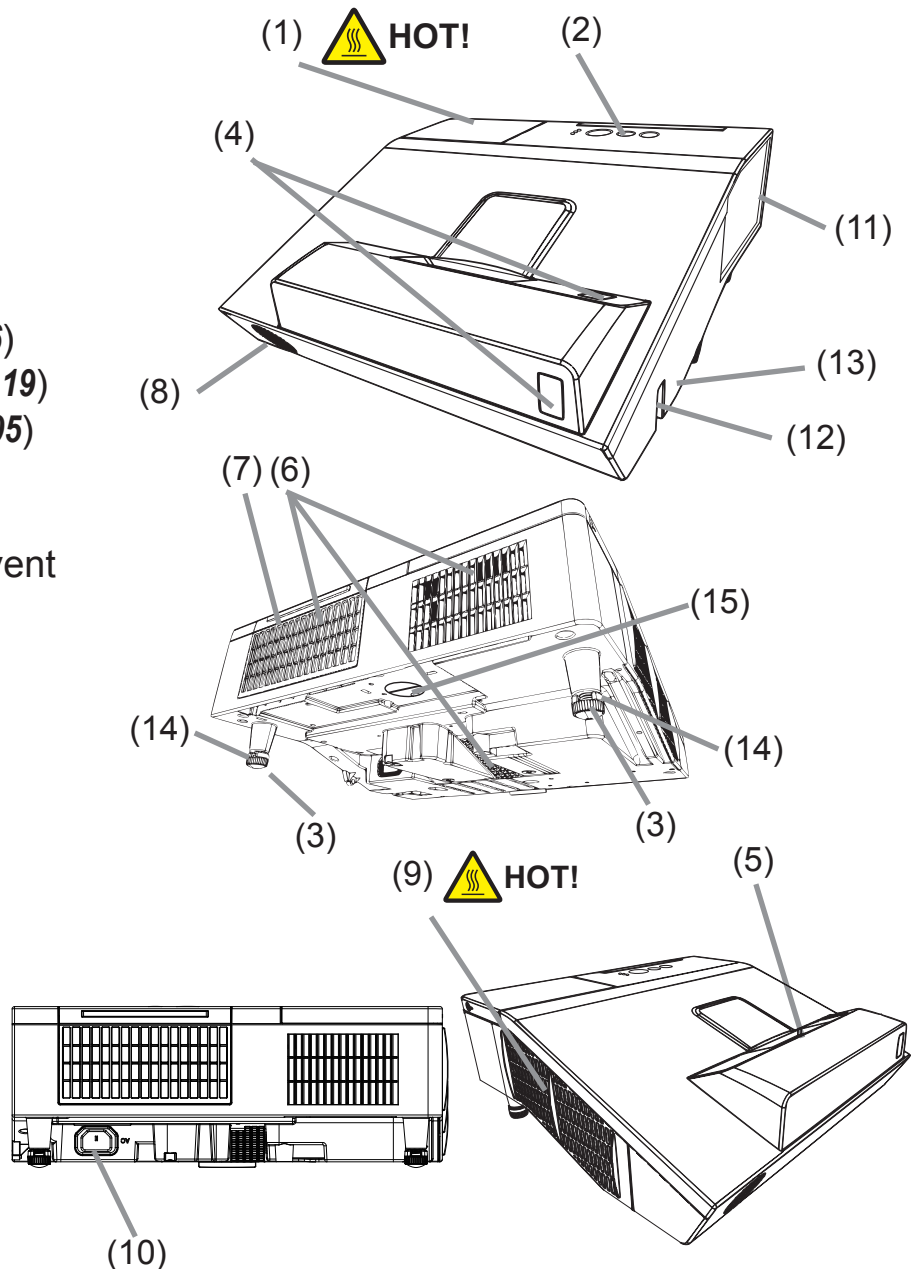

**⚠️ WARNING ►HOT!** : Do not touch around the lamp cover and the exhaust vents during use or just after use, since it is too hot.

► Never look into the projection window while the projection lamp lights, since the projection lamp ray may cause a trouble on your eyes.

► Do not use the security bar and slot to prevent the projector from falling down, since it is not designed for it.

**⚠️ CAUTION** ► Maintain normal ventilation to prevent the projector from heating up. Do not cover, block or plug up the vents. Do not place anything that can stick or be sucked to the vents, around the intake vents. Clean the air filter periodically.

## Part names (continued)

### Control panel

- (1) **STANDBY/ON** button (📖 21)
- (2) **INPUT** button (📖 25)
- (3) **POWER** indicator (📖 21, 109)
- (4) **TEMP** indicator (📖 109)
- (5) **LAMP** indicator (📖 109)

### Buttons ◀/▶/▲/▼

- (6) **FOCUS +/-** buttons

when no menu is displayed (📖 27), or  
Cursor ◀/▶ buttons

when a menu is displayed (📖 32). FOCUS +/- function is invalid when the  
**USB TYPE A** port is selected as the input source.

- (7) **MENU** buttons

when no menu is displayed (📖 32), or  
Cursor ▲/▼ buttons

when a menu is displayed (📖 32).

The ◀/▶/▲/▼ buttons on the projector work only as the cursor buttons while the template is displayed (📖 59).

### Ports (📖 10 ~ 15)

- (1) **USB TYPE A** port (x2)
- (2) **LAN** port
- (3) **USB TYPE B** port
- (4) **HDMI** port (x2)
- (5) **MIC** port
- (6) **AUDIO IN1** port
- (7) **AUDIO IN2(L,R)** ports
- (8) **AUDIO OUT** port
- (9) **COMPUTER IN1** port
- (10) **COMPUTER IN2 / MONITOR OUT** port
- (11) **VIDEO IN** port
- (12) **CONTROL** port

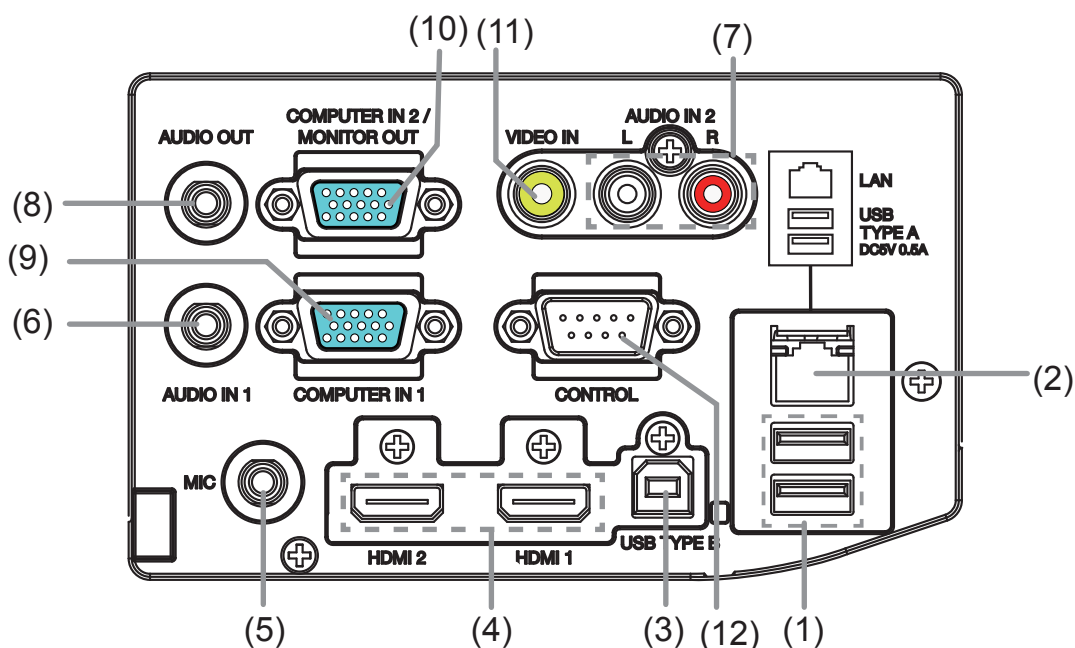

## Part names (continued)

### Remote control

- (1) **INPUT** button (📖 25)
- (2) **IWB** button \*
- (3) **CALIBRATION** button \*
- (4) **STANDBY/ON** button (📖 21)
- (5) **ASPECT** button (📖 25)
- (6) **AUTO** button (📖 27)
- (7) **ACCENTUALIZER** button (📖 28)
- (8) **HDCR** button (📖 28)
- (9) **FOCUS -** button (📖 27)
- (10) **FOCUS +** button (📖 27)
- (11) **D-ZOOM -** button (📖 26)
- (12) **D-ZOOM +** button (📖 26)
- (13) **PAGE UP** button (📖 20)
- (14) **MAGNIFY - ON** button (📖 30)
- (15) **MY BUTTON - 1** button (📖 63)
- (16) **VOLUME +** button (📖 24)
- (17) **PAGE DOWN** button (📖 20)
- (18) **MAGNIFY - OFF** button (📖 30)
- (19) **MY BUTTON - 2** button (📖 63)
- (20) **VOLUME -** button (📖 24)
- (21) **KEystone/PERFECT FIT** button (📖 29)
- (22) **TEMPLATE** button (📖 28)
- (23) **FREEZE** button (📖 31)
- (24) **AV MUTE** button (📖 24)
- (25) **ESC** button (📖 32)
- (26) **MENU** button (📖 32, 33)
- (27) **ENTER** button (📖 32, 33)
- (28) **POSITION** button (📖 29, 33)
- (29) **RESET** button (📖 32)
- (30) **▲/▼/◀/▶** cursor buttons (📖 32)
- (31) Battery cover (📖 18)

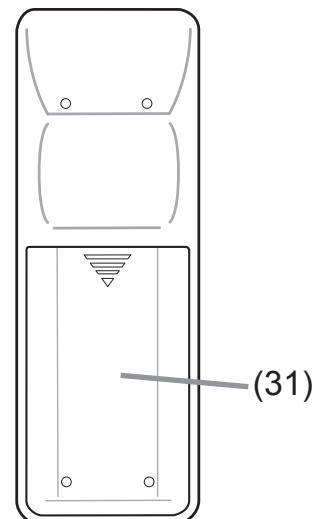
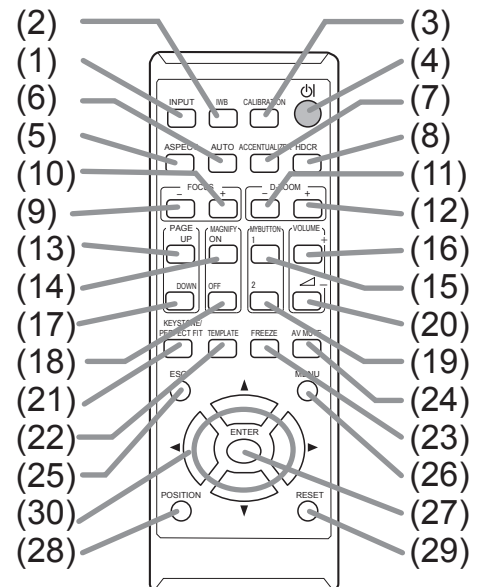

Back of the remote control

**NOTE** • Any button marked with “\*” is not supported on this projector (📖 108).

## Setting up

Install the projector according to the environment and manner the projector will be used in.

### Arrangement

Refer to tables **T-1** to **T-3** and figures **F-1** and **F-2** at the end of User's Manual (concise) to determine the screen size and projection distance.

The values shown in the table are calculated for a full size screen.

Ⓐ Screen size (diagonal) Ⓑ①, Ⓑ② Projection distance ( $\pm 8\%$ ) Ⓒ①, Ⓒ② Screen height ( $\pm 8\%$ )

- For the case of installation in special conditions such as on the wall or ceiling, the specified mounting accessories and service may be required. Tabletop use must be setup with the designated optional accessories. Before installing the projector, consult your dealer about your installation.
- The screen position may shift after installation if the projector is mounted on locations such as the wall or ceiling, due to the flexibility of the plastic projector body. If readjustment is necessary, consult with your dealer or service personnel.
- The projected image position and/or focus may change during warm-up (approx. 30 minutes after the lamp is turned on) or when the ambient conditions change. Readjust the image position and/or focus as necessary.
- Since the projector features an ultra short throw, be aware that it is required to select a screen carefully to have better performance.
  - A soft screen such as a pull-down screen may cause serious distortion of a projected image. A hard screen such as a board screen is recommended for use with this projector.
  - A high-gain screen such as a bead screen that has narrow viewing angle is not suitable for this projector. A low-gain screen (around 1.0) such as a matte screen that has wide viewing angle is recommended for use with this projector.
  - A screen with a weave pattern may cause moiré on the projected image, which is not a failure of the projector. A screen that has less moiré effects is recommended for use with this projector.

**⚠ WARNING** ► Place the projector in a stable horizontal position. If the projector falls or is knocked over, it could cause injury and/or damage to the projector. Using a damaged projector could then result in fire and/or electric shock.

- Do not place the projector on an unstable, slanted or vibrational surface such as a wobbly or inclined stand.
- Do not place the projector on its side or front position. To place the projector on its rear position for the table top use, it is required to use the designated optional parts. Consult with your dealer.
- Consult with your dealer before a special installation such as on the wall or ceiling.

(continued on next page)

## Arrangement (continued)

- ⚠ WARNING** ► Place the projector in a cool place, and ensure that there is sufficient ventilation. The high temperature of the projector could cause fire, burns and/or malfunction of the projector.
- Do not stop-up, block or otherwise cover the projector's vents.
  - Keep a space of 30 cm or more between the sides of the projector and other objects such as walls.
  - Do not place or attach anything that would block the projection window or vent holes.
  - Do not place the projector on metallic thing or anything weak in heat.
  - Do not place the projector on carpet, cushions or bedding.
  - Do not place the projector in direct sunlight or near hot objects such as heaters. Do not place the projector where the air from an air conditioner or similar unit will blow on it directly.
  - Do not place anything near the projection window or vents, or on top of the projector. It causes high temperature and could result in fire or smoke.
    - Do not put anything such as a remote control on the projection window.
    - Do not put anything on the projector. It slips down and blocks the projection window.
  - Do not place anything that may be sucked into or stick to the vents on the bottom of the projector. This projector has some intake vents also on the bottom.
- Do not place the projector anywhere where it may get wet. Getting the projector wet or inserting liquid into the projector could cause fire, electric shock and/or malfunction of the projector.
- Do not place the projector in a bathroom or the outdoors.
  - Do not place anything containing liquid near the projector.
  - Do not place the projector where any oils, such as cooking or machine oil, are used. Oil may harm the product, resulting in malfunction, or falling from the mounted position. Do not use adhesive such as threadlocker, lubricant and so on.
- Use only the mounting accessories the manufacturer specified, and leave installing and removing the projector with the mounting accessories to the service personnel.
- Read and keep the user's manual of the mounting accessories used.

(continued on next page)



**Arrangement (continued)**

**⚠ CAUTION** ▶ Avoid placing the projector in smoky, humid or dusty place. Placing the projector in such places could cause fire, electric shock and/or malfunction of the projector.

- Do not place the projector near humidifiers, smoking spaces or a kitchen. Also do not use an ultrasonic humidifier near the projector. Otherwise chlorine and minerals contained in tap water are atomized and could be deposited in the projector causing image degradation or other problems.

- ▶ Position the projector to prevent light from directly hitting the projector's remote sensor.

- ▶ Do not place the product in a place where radio interference may be caused.

- ▶ Do not place this product in a magnetic field.

- ▶ If the projector is used at an altitude of about 1600 m or higher, set ALTITUDE of the SERVICE item in the OPTION menu to HIGH (📖68). Otherwise, set it to NORMAL.

If the projector is used with a wrong setting, it may cause damage to the projector itself or the parts inside.

**NOTE** • The projector may make a rattling sound when tilted, moved or shaken, since a flap to control the air flow inside of the projector has moved. Be aware that this is not a failure or malfunction.

- The incoming light to the screen from the projector has a large angle. While the white image is on the screen, you may see it with colors, but this is because of the type of the screen used or the angles viewed, and it is not a malfunction.

- When the ambient temperature is around 35 to 40°C, the brightness of lamp is reduced automatically.

## Connecting with your devices

Before connecting the projector to a device, consult the manual of the device to confirm that the device is suitable for connecting with this projector and prepare the required accessories, such as a cable in accord with the signal of the device. Consult your dealer when the required accessory did not come with the product or the accessory is damaged.

After making sure that the device and projector are turned off, connect them following the instructions below.

**⚠ WARNING** ▶ Use only the appropriate accessories. Otherwise it could cause a fire or damage to the device and the projector.

- Use only the accessories specified or recommended by the projector's manufacturer. Consult your dealer when the required accessory did not come with the product or the accessory is damaged. It may be regulated under some standard.
- For a cable with a core at only one end, connect the end with the core to the projector. That may be required by EMI regulations.
- Neither disassemble nor modify the projector and the accessories.
- Do not use the damaged accessory. Be careful not to damage the accessories. Route a cable so that it is neither stepped on nor pinched out.

**⚠ CAUTION** ▶ Do not turn on or off the projector while connected to a device in operation, unless that is directed in the manual of the device. Otherwise it may cause malfunction in the device or projector.

- ▶ Be careful not to mistakenly connect a connector to a wrong port. Otherwise it may cause malfunction in the device or projector.
- When connecting a connector to a port, make sure that the shape of the connector fits the port.
- Tighten the screws to connect a connector equipped with screws to a port.
- Use the cables with straight plugs, not L-shaped ones, as the input ports of the projector are recessed.

(continued on next page)

## Connecting with your devices (continued)

### About Plug-and-Play capability

- Plug-and-Play is a system composed of a computer, its operating system and peripheral equipment (i.e. display devices). This projector is VESA DDC 2B compatible. Plug-and-Play can be used by connecting this projector to a computer that is VESA DDC (display data channel) compatible.
  - Take advantage of this feature by connecting a computer cable to the **COMPUTER IN1** port (DDC 2B compatible). Plug-and-Play may not work properly if any other type of connection is attempted.
  - Please use the standard drivers in your computer as this projector is a Plug-and-Play monitor.
- When AUTO is selected for the **COMPUTER IN1** or **COMPUTER IN2** port in COMPUTER IN of the INPUT menu, that port will accept component video signals (📖46).
- When the **USB TYPE B** port and the computer's type A USB port are connected, you can use the **USB TYPE B** port as a picture input port from the computer, or use the remote control as a simple mouse and keyboard of the computer. (📖20).

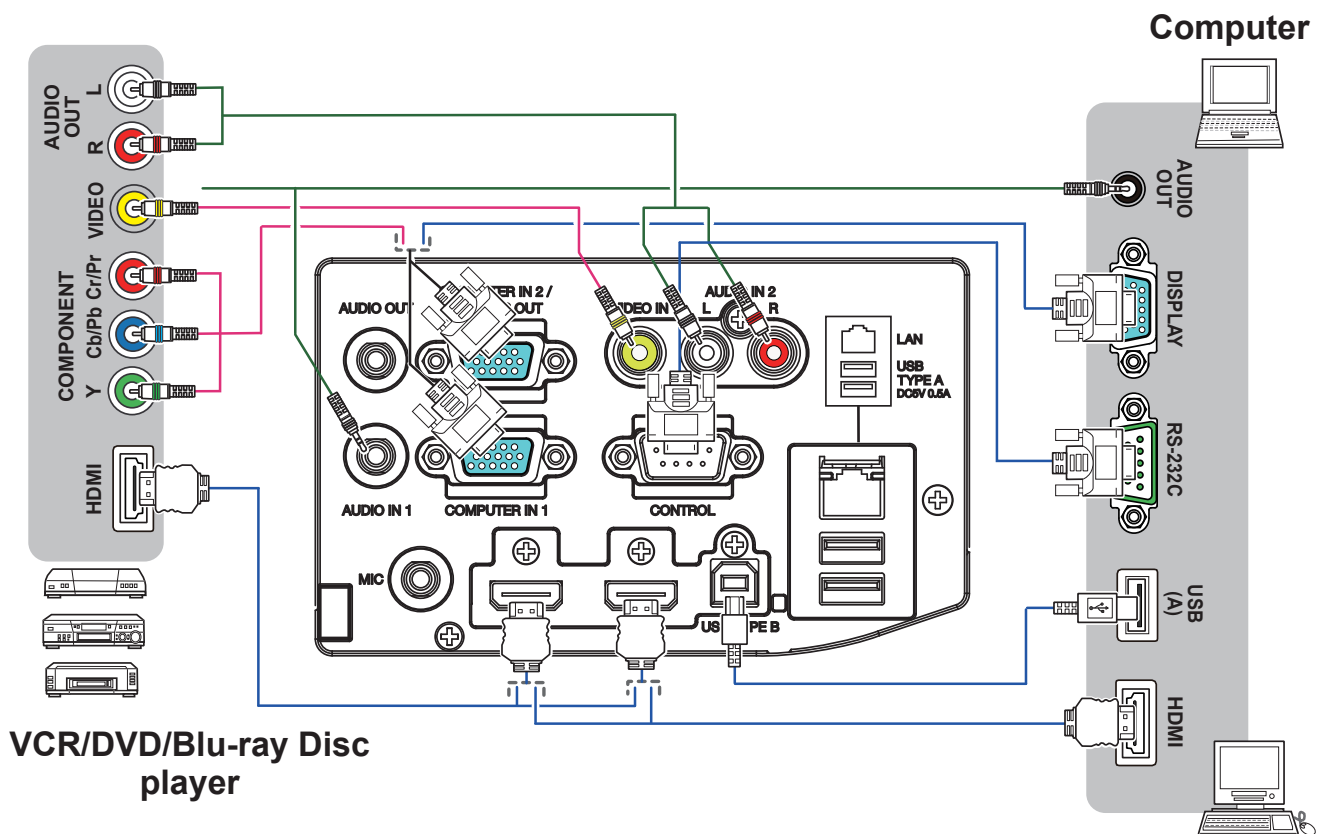

(continued on next page)

## Connecting with your devices (continued)

**NOTE** • Before connecting the projector to a computer, consult the computer's manual and check the compatibility of the signal level, the synchronization methods and the display resolution output to the projector.

- Some signal may need an adapter to input this projector.
- Some computers have multiple screen display modes that may include some signals which are not supported by this projector.
- Although the projector can display signals with resolution up to UXGA (1600X1200), the signal will be converted to the projector's panel resolution before being displayed. The best display performance will be achieved if the resolutions of the input signal and the projector panel are identical.
- If you connect this projector and a notebook computer, you need output the display to an external monitor, or output simultaneously to the internal display and an external monitor. Consult the computer's manual for the setting.
- Depending on the input signal, the automatic adjustment function of this projector may take some time and not function correctly.
- Note that a composite sync signal or sync-on-green signal may confuse the automatic adjustment function of this projector (46).
- If the automatic adjustment function does not work correctly, you may not see the dialog to set the display resolution. In such a case, use an external display device. You may be able to see the dialog and set an appropriate display resolution.

(continued on next page)

## Connecting with your devices (continued)

- If you insert a USB storage device, such as a USB memory, into the **USB TYPE A** port and select the port as the input source, you can view images stored in the device (📖82).
- You can connect a dynamic microphone to the **MIC** port with a 3.5 mm mini-plug. In that case, the built-in speaker outputs the sound from the microphone, even while the sound from the projector is output. You can input line level signal to the **MIC** port from equipment such as wireless microphone. In the normal mode, the volume of the microphone can be adjusted separately from the volume of the projector using the menu. (📖54)

In the standby mode, the volume of the microphone is adjustable with the **VOLUME +/-** buttons on the remote control, in synchronization with the volume of the projector. (📖24)

Even when the sound of projector is set to mute mode by the **AUDIO SOURCE** function (📖54), the volume of the microphone is adjustable.

In both modes (standby or normal), the **AV MUTE** button on the remote control works on the sounds of the microphone and the projector. (📖24)

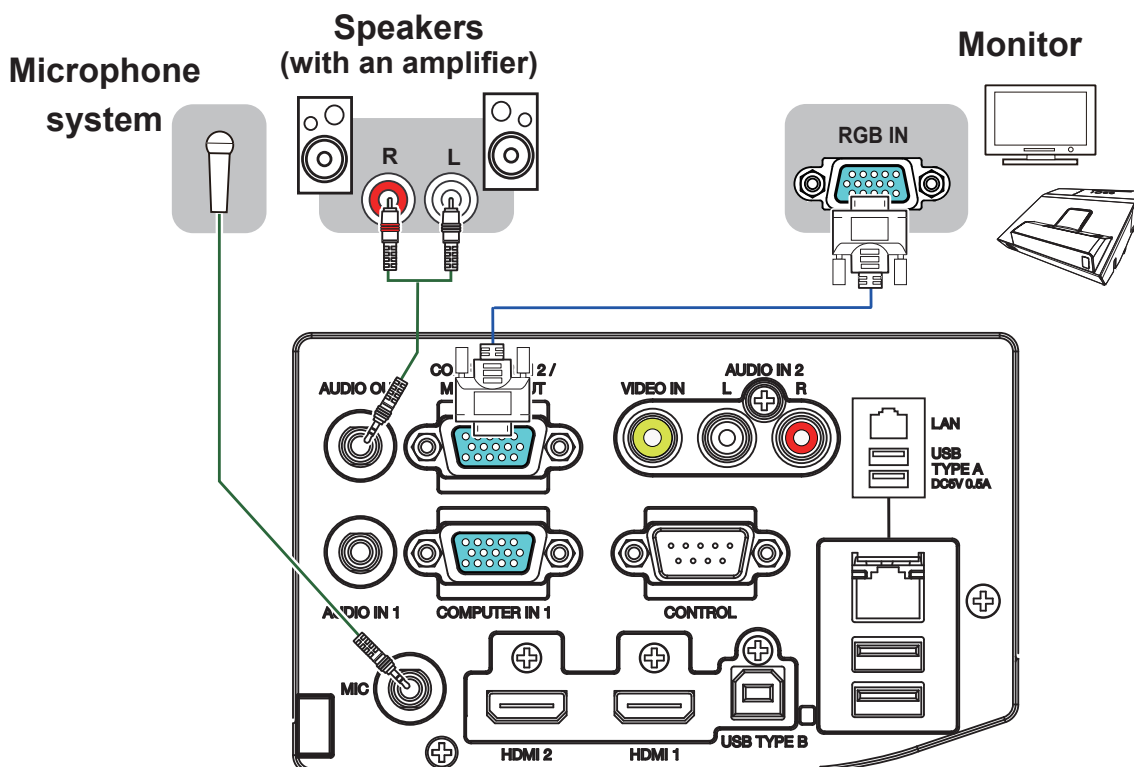

**NOTE** • If a loud feedback noise is produced from the speaker, move the microphone away from the speaker.

- This projector doesn't support plug-in power for the microphone.

(continued on next page)

## Connecting with your devices (continued)

To use network functions of the projector, connect the **LAN** port with the computer's LAN port, or with an access point that is connected to the computer with wireless LAN, using a LAN cable. To use NETWORK BRIDGE function, also connect the **CONTROL** port and an RS-232C port of the external device to communicate as a network terminal. See the **User's Manual - Network Guide** for details of the network functions.

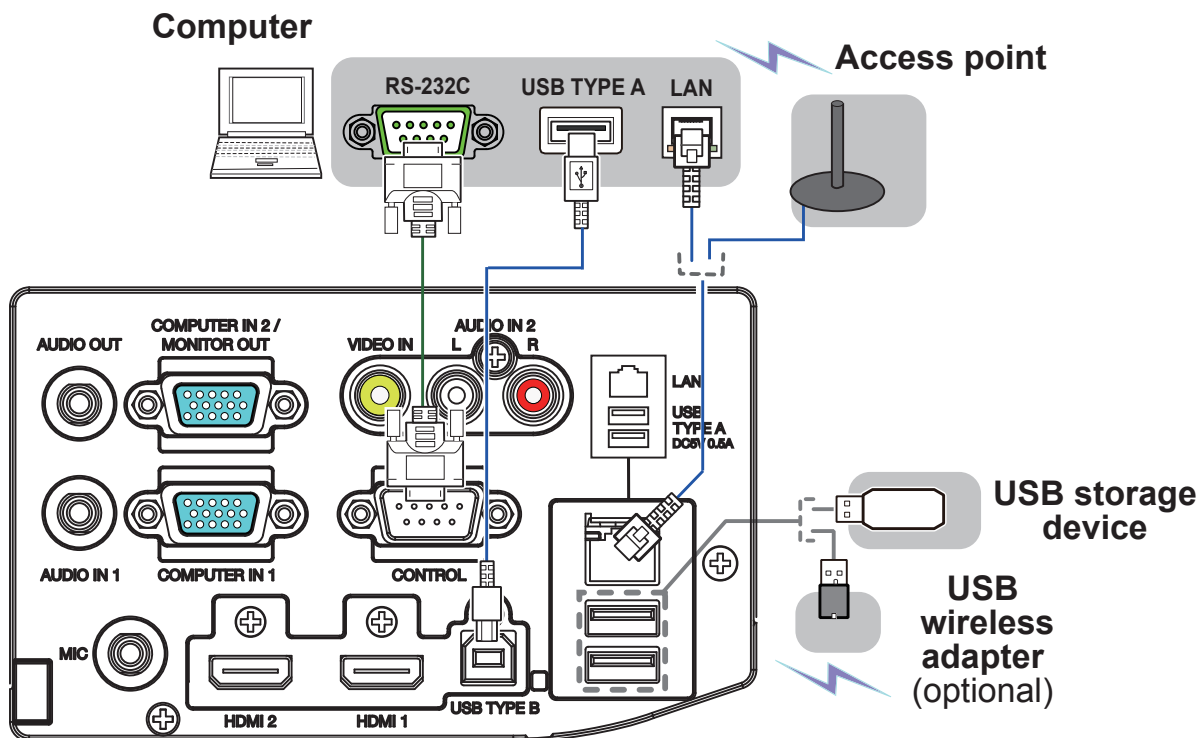

- ⚠ CAUTION** ▶ Before connecting the projector to a network system be sure to obtain the consent of the administrator of the network.
- ▶ Do not connect the **LAN** port to any network that might have the excessive voltage.
  - ▶ The designated USB wireless adapter that is sold as an option is required to use the wireless network function of this projector.
  - ▶ Before removing the USB storage device from the port of the projector, be sure to use the REMOVE USB function on the thumbnail screen to secure your data (📖85).
  - ▶ Do not use any extension cable or device when connecting the adapter to the projector. Before you insert or pull out the USB wireless adapter from the projector, turn off the power of the projector and pull out the power cord's plug from the outlet. Do not touch the USB wireless adapter while the projector is receiving AC power.
  - ▶ To connect both the LAN cable and USB device to the projector, use a LAN cable that is flat on the side where the plug's wire is visible. Otherwise, both of them cannot be connected correctly, or the wire may break (malfunction).

(continued on next page)

## Connecting with your devices (continued)

- NOTE** • If an oversized USB storage device blocks the **LAN** port, use a USB extension cable to connect the USB storage device.
- The **HDMI** port of this model is compatible with HDCP (High-bandwidth Digital Content Protection) and therefore capable of displaying a video signal from HDCP compatible DVD players or the like.
  - The **HDMI** supports the following signals.  
Video signal : 480i@60, 480p@60, 576i@50, 576p@50, 720p@50/60, 1080i@50/60, 1080p@50/60  
Audio signal : Format Linear PCM  
Sampling frequency 48kHz / 44.1kHz / 32kHz
  - This projector can be connected with another equipment that has HDMI® connector, but with some equipment the projector may not work properly, something like no video.
  - Be sure to use an HDMI® cable that has the HDMI® logo.
  - Use a Category 2-certified HDMI® cable to input 1080p@50/60 signal to the projector.
  - When the projector is connected with a device having DVI connector, use a DVI to HDMI® cable to connect with the **HDMI** input.
  - Up to one USB wireless adapter (optional) can be connected to a projector.

## Connecting to a power supply

1. Put the connector of the power cord into the **AC** (AC inlet) of the projector.
2. Firmly plug the power cord's plug into the outlet. In a couple of seconds after the power supply connection, the **POWER** indicator will light up in steady orange.

Please remember that when the DIRECT POWER ON function activated (📖 62), the connection of the power supply make the projector turn on.

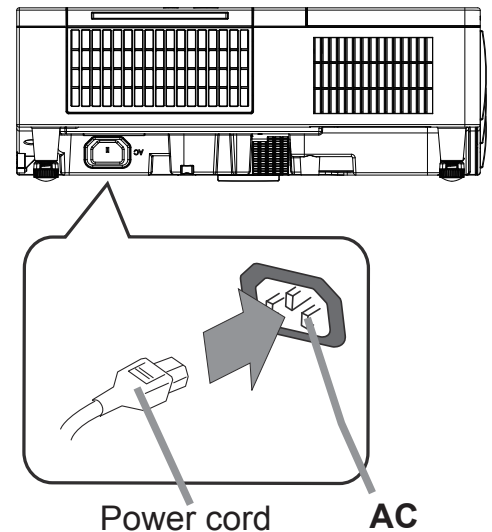

**⚠️ WARNING** ▶ Please use extra caution when connecting the power cord, as incorrect or faulty connections may result in fire and/or electrical shock.

- Do not touch the power cord with a wet hand.
- Only use the power cord that came with the projector. If it is damaged, consult your dealer to get a new one. Never modify the power cord.
- Only plug the power cord into an outlet whose voltage is matched to the power cord. The power outlet should be close to the projector and easily accessible. Remove the power cord for complete separation.
- Do not distribute the power supply to multiple devices. Doing so may overload the outlet and connectors, loosen the connection, or result in fire, electric shock or other accidents.
- Do not press the main body of projector on the power cord.
- Connect the ground terminal for the AC inlet of this unit to the ground terminal of the building using an appropriate power cord (bundled).

## Using the security bar and slot

A commercial anti-theft chain or wire up to 10 mm in diameter can be attached to the security bar on the projector.

Also this product has the security slot for the Kensington lock.

For details, see the manual of the security tool.

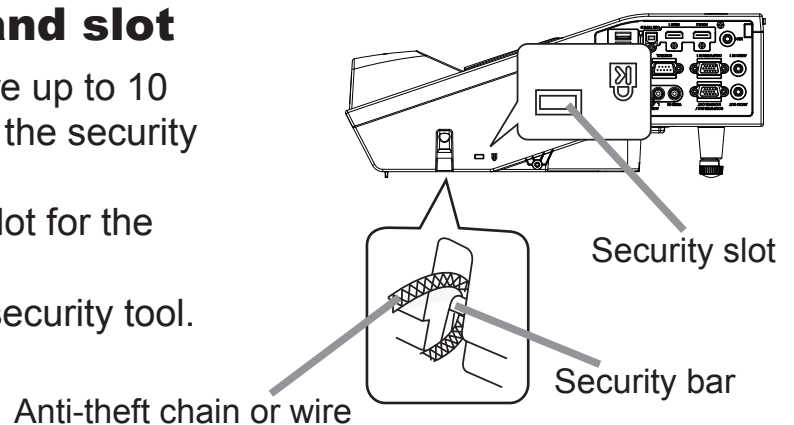

**⚠️ WARNING** ▶ Do not use the security bar and slot to prevent the projector from falling down, since it is not designed for it.

**⚠️ CAUTION** ▶ Do not place anti-theft chain or wire near the exhaust vents. It may become too hot.

**NOTE** • The security bar and slot is not comprehensive theft prevention measures. It is intended to be used as supplemental theft prevention measure.



## Using the cable cover

Utilize the cable cover as the guard and blind for the connecting parts.

1. Connect the signal cables and the power cord to the projector first.
2. Insert the three knobs on the cable cover into the three holes on the projector as shown in the figure. Pass the cables through the holes on the bottom of the cable cover.

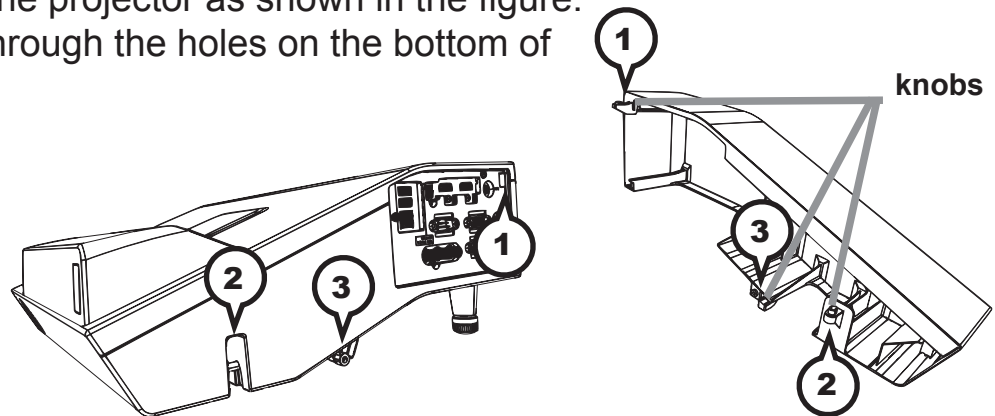

3. Fix the cover's screw.

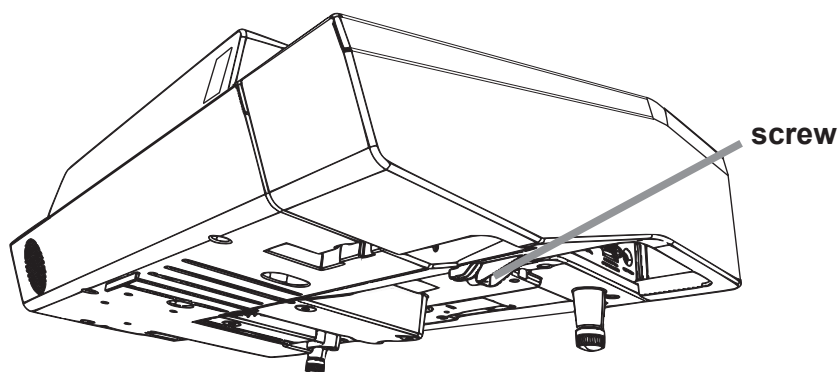

**⚠ CAUTION** ► Be careful not to pinch the cables in the cable cover, to prevent damage to the cables.  
► Use the cable cover that is supplied with the projector. Do not attempt any modifications to the cable cover.

## Remote control

## Installing the batteries

Please insert the batteries into the remote control before using it. If the remote control starts to malfunction, try to replace the batteries. If you will not use the remote control for long period, remove the batteries from the remote control and store them in a safe place.

1. Remove the battery cover.
2. Align and insert the two AA batteries (Use the appropriate AA carbon-zinc or alkaline batteries (non-rechargeable) in accordance with laws and regulations.) according to their plus and minus terminals as indicated in the remote control.
3. Put the battery cover back to the former state.

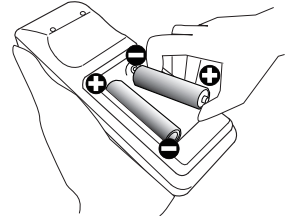

**⚠ WARNING** ► Always handle the batteries with care and use them only as directed. Improper use may result in battery explosion, cracking or leakage, which could result in fire, injury and/or pollution of the surrounding environment.

- Be sure to use only the batteries specified. Do not use batteries of different types at the same time. Do not mix a new battery with used one.
- Make sure the plus and minus terminals are correctly aligned when loading a battery.
- Keep a battery away from children and pets.
- Do not recharge, short circuit, solder or disassemble a battery.
- Do not place a battery in a fire or water. Keep batteries in a dark, cool and dry place.
- If you observe battery leakage, wipe out the leakage and then replace a battery. If the leakage adheres to your body or clothes, rinse well with water immediately.
- Obey the local laws on disposing the battery.

## About the remote control signal

The remote control works with the projector's remote sensor. This projector has a remote sensor on the front. The sensor senses the signal within the following range when the sensor is active:

60 degrees (30 degrees to the left and right of the sensor)  
within 3 meters about.

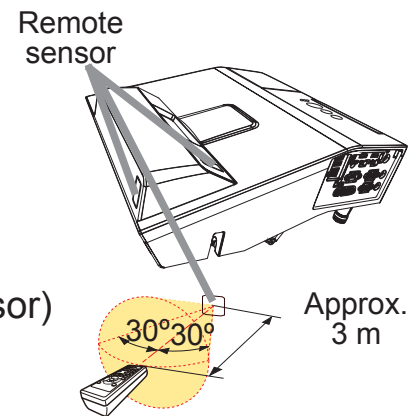

**NOTE** • You can deactivate one of the sensors using the REMOTE RECEIV. item in the SERVICE menu of the OPTION menu (📖69) .

- The remote control signal reflected in the screen or the like may be available. If it is difficult to send the signal to the sensor directly, attempt to make the signal reflect.
- The remote control uses infrared light to send signals to the projector (Class 1 LED), so be sure to use the remote control in an area free from obstacles that could block the remote control's signal to the projector.
- The remote control may not work correctly if strong light (such as direct sun light) or light from an extremely close range (such as from an inverter fluorescent lamp) shines on the remote sensor of the projector. Adjust the position of projector avoiding those lights.

## Changing the frequency of remote control signal

The accessory remote control has the two choices on signal frequency Mode 1:NORMAL and Mode 2:HIGH. If the remote control does not function properly, attempt to change the signal frequency.

In order to set the Mode, please keep pressing the combination of two buttons listed below simultaneously for about 3 seconds.

- (1) Set to Mode 1:NORMAL... **VOLUME -** and **RESET** buttons
- (2) Set to Mode 2:HIGH... **MAGNIFY OFF** and **ESC** buttons

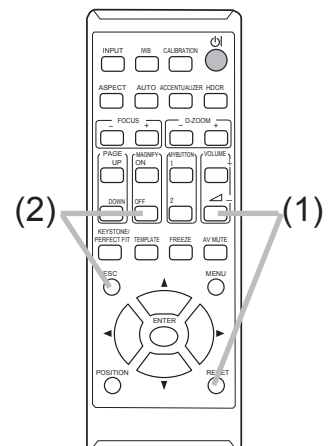

Please remember that the REMOTE FREQ. in the SERVICE item of the OPTION menu (📖70) of the projector to be controlled should be set to the same mode as the remote control.

## Using as a simple PC mouse & keyboard

The accessory remote control works as a simple mouse and keyboard of the computer, when the projector's **USB TYPE B** port and the computer's type A USB port are connected.

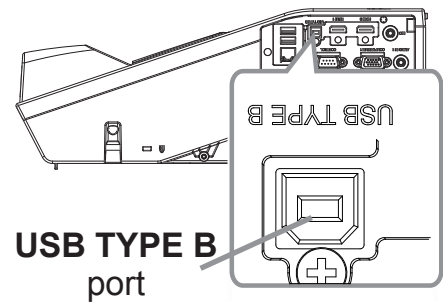

- (1) **PAGE UP key:** Press the **PAGE UP** button.
- (2) **PAGE DOWN key:** Press the **PAGE DOWN** button.
- (3) **Mouse left button:** Press the **ENTER** button.
- (4) **Move pointer:** Use the cursor buttons ▲, ▼, ◀ and ▶.
- (5) **ESC key:** Press the **ESC** button.
- (6) **Mouse right button:** Press the **RESET** button.

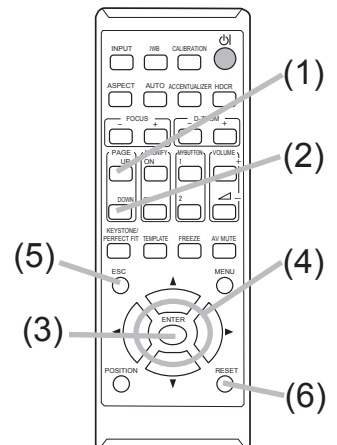

**⚠ NOTICE** ► Improper use of the simple mouse & keyboard function could damage your equipment. While using this function, please connect this product only to a computer. Be sure to check your computer's manuals before connecting this product to the computer.

**NOTE** When the simple mouse & keyboard function of this product does not work correctly, please check the following.

- When a USB cable connects this projector with a computer having a built-in pointing device (e.g. track ball) like a laptop PC, open BIOS setup menu, then select the external mouse and disable the built-in pointing device, because the built-in pointing device may have priority to this function.
- Windows® 7 or higher is required for this function. And also this function may not work depending on the computer's configurations and mouse drivers. This function can work with the computer which can operate general USB mouse or keyboard.
- You cannot do things like press two buttons at once (for instance, pressing two buttons at the same time to move the mouse pointer diagonally).
- This function is activated only when the projector is working properly. This function is not available in any of the following cases:
  - While the lamp is warming up. (The **POWER** indicator blinks in green.)
  - When **USB TYPE A** port is selected.
  - While displaying BLANK (📖 24) or MY IMAGE screen.
  - When any menu is displayed on the screen.
  - While using the cursor buttons to operate the sound or screen functions such as adjusting the sound volume, correcting the keystone, correcting the picture position and magnifying the screen.

## Power on/off

## Turning on the power

1. Make sure that the power cord is firmly and correctly connected to the projector and the outlet.
2. Make sure that the **POWER** indicator is steady orange (📖109).
3. Press **STANDBY/ON** button on the projector or the remote control. The projection lamp lights up, and the **POWER** indicator begins to blink green. When the power is completely on, the indicator will stop blinking and light in steady green (📖109).

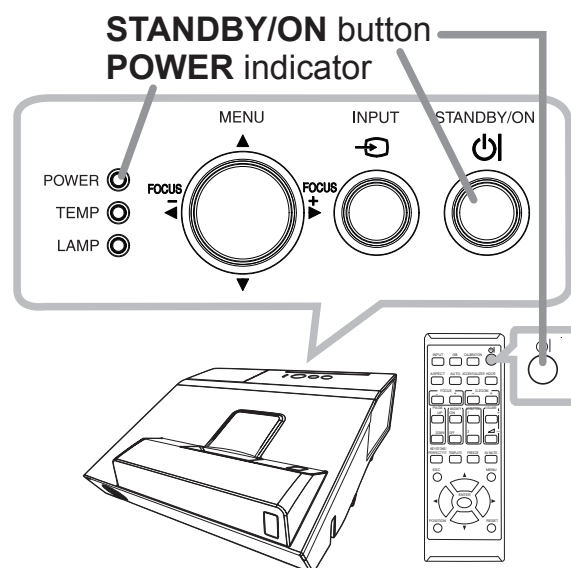

To display the picture, select an input signal according to the section **Selecting an input signal** (📖25).

The INITIAL SETTING Menu will be displayed by factory default upon startup. Once the INITIAL SETTING Menu is set, it will not appear until **FACTORY RESET** (📖75) is executed. If you wish to change the settings, refer to the **LANGUAGE** (📖55) and **ALTITUDE** (📖68) menu.

- (1) **LANGUAGE**: Use the ▲/▼/◀/▶ buttons to select the desired language and press the **ENTER** button of the remote control or the  button of the projector to execute.

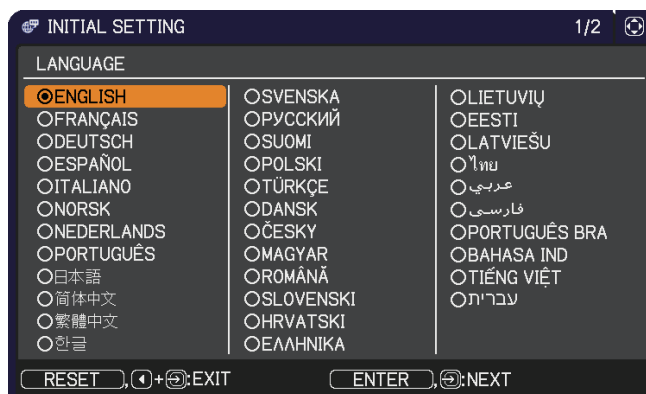

- (2) **ALTITUDE**: Use the ▲/▼ buttons to select **NORMAL** for altitude below 1600 m (5250 feet), otherwise select **HIGH** and press the **ENTER** button of the remote control or the  button of the projector to execute.

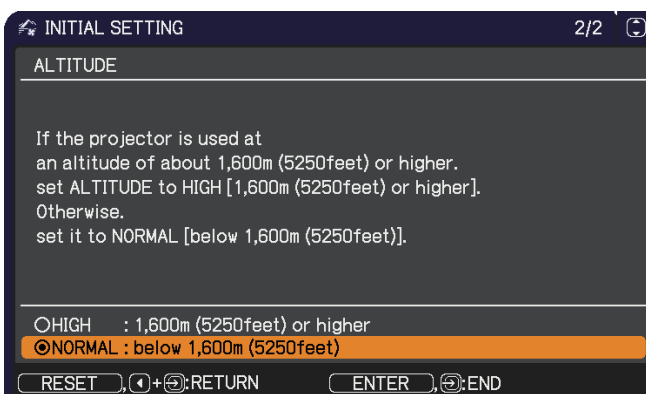

(continued on next page)

⚠ **WARNING** ▶ Never look into the projection window while the projection lamp lights, since the projection lamp ray may cause a trouble on your eyes.

▶ Do not place the projector vertically as shown in the figure on the right. It could cause malfunction or injury. Tabletop use must be setup with the designated optional accessories.

▶ The projection window of this machine is made of glass. It can be damaged by excessive force or an impact. Read the following important warnings carefully, and follow them for your own safety.

- Do not apply excessive force on or allow impact to the projection window.
- Keep the projector out of the reach of children.
- If the projection window is broken, the projected image will be distorted. Never touch a broken projection window, and contact your dealer.

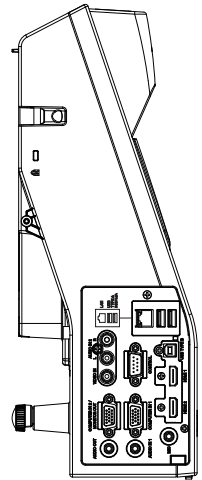



## Turning off the power

1. Press the **STANDBY/ON** button on the projector or the remote control.
  - The message “Power off?” will appear on the screen for about 5 seconds.
2. Press the **STANDBY/ON** button again while the message appears.
  - The projector lamp will go off, and the **POWER** indicator will begin blinking in orange. Then **POWER** indicator will stop blinking and light in steady orange when the lamp cooling is completed ( 109).

Do not turn the projector on for about 10 minutes or more after turning it off. Also, do not turn the projector off shortly after turning it on. Such operations might cause the lamp to malfunction or shorten the lifetime of some parts including the lamp.

**⚠ WARNING** ▶ Do not touch around the lamp cover and the exhaust vents during use or just after use, since it is too hot.  
▶ Remove the power cord for complete separation. The power outlet should be close to the projector and easily accessible.

**NOTE** • Turn the power on/off in right order. Please power on the projector prior to the connected devices.  
• This projector has the function that can make the projector automatically turn on/off. Please refer to the DIRECT POWER ON ( 62) and AUTO POWER OFF ( 62) items of the OPTION menu.

Operating

## Adjusting the volume

VOLUME +/- button

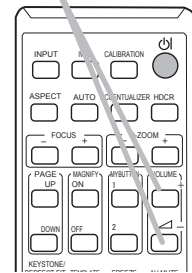

1. Use the **VOLUME +/VOLUME -** buttons to adjust the volume.
  - A dialog will appear on the screen to aid you in adjusting the volume. If you do not do anything, the dialog will automatically disappear after about ten seconds.
  - When  $\times$  is selected for current picture input port, the volume adjustment is disabled. Please see AUDIO SOURCE item of AUDIO menu (📖54).
  - Even if the projector is in the standby mode, the volume is adjustable when both of the following conditions are true:
    - An option other than  $\times$  is selected for STANDBY in the AUDIO SOURCE item of the AUDIO menu (📖54).
    - NORMAL is selected in the STANDBY MODE item of the SETUP menu (📖53).
  - In the standby mode, the volume of the microphone is adjustable with the **VOLUME +/-** buttons on the remote control, in synchronization with the volume of the projector (📖13).

## Temporarily muting the screen and audio output

AV MUTE button

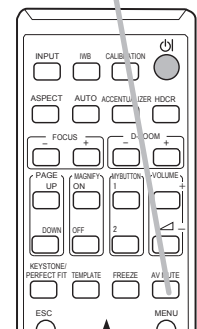

1. Press the **AV MUTE** button on the remote control.
  - The BLANK screen will be displayed instead of the screen of input signals and the sound from the **AUDIO OUT** port will be muted. Please refer to the BLANK item in SCREEN menu about the BLANK screen (📖55).
  - To exit from the AV MUTE mode and restore the screen and audio, press the **AV MUTE** button again.

**NOTE** • The projector automatically exits from the AV MUTE mode when some control buttons are pressed.

- The audio is output from the external audio system connected to the **AUDIO OUT** port.

**⚠ WARNING** ► If you wish to have a blank screen while the projector's lamp is on, use the AV MUTE function above .  
 Taking any other action may cause the damage on the projector.  
 Blocking the beam by something causes high temperature and could result in fire or smoke.



## Selecting an input signal

1. Press the **INPUT** button on the projector or the remote control. Select a desirable input referring to the displayed input list.

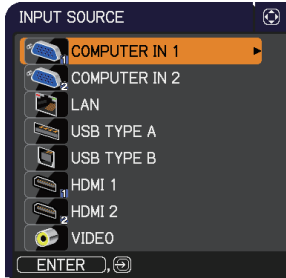

INPUT button

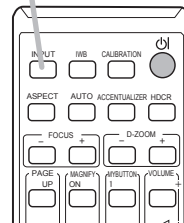

INPUT button

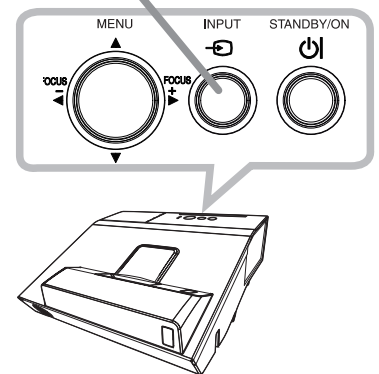

- While ON is selected for AUTO SEARCH item in OPTION menu (61), the projector will keep checking the ports in above order repeatedly till an input signal is detected. The ports can be set to be ignored in searching by the AUTO SEARCH function.
- It may take several seconds to project the images from the **USB TYPE B** port.

## Selecting an aspect ratio

1. Press **ASPECT** button on the remote control.
  - Each time you press the button, the projector switches the mode for aspect ratio in turn.

ASPECT button

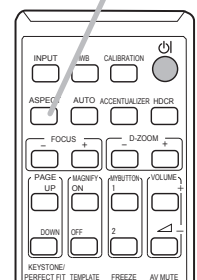

- For a computer signal

NORMAL → 4:3 → 16:9 → 16:10 → ZOOM → NATIVE



- For an HDMI® signal

NORMAL → 4:3 → 16:9 → 16:10 → 14:9 → ZOOM → NATIVE



- For a video signal or component video signal

4:3 → 16:9 → 16:10 → 14:9 → ZOOM → NATIVE



- For an input signal from the LAN, USB TYPE A or USB TYPE B port, or if there is no signal

16:10 (fixed)

- **ASPECT** button does not work when no proper signal is inputted.
- NORMAL mode keeps the original aspect ratio setting.
- The on-screen menu might be displayed outside of the image display area depending on the adjustment value of the ASPECT, D-ZOOM, KEYSTONE, KEYSTONE and PERFECT FIT. Changing the values of ASPECT, D-ZOOM, KEYSTONE, KEYSTONE and PERFECT FIT may fix the symptom.

## Adjusting the projector's elevator

The projector has 2pcs Rear foot for horizontals and inclinations. Spacers on the each elevator foot are installed at the time of shipment, and projector is in a condition to be able to just project. If necessary, detach the spacer, and the elevator feet can be manually twisted to make more precise adjustments.

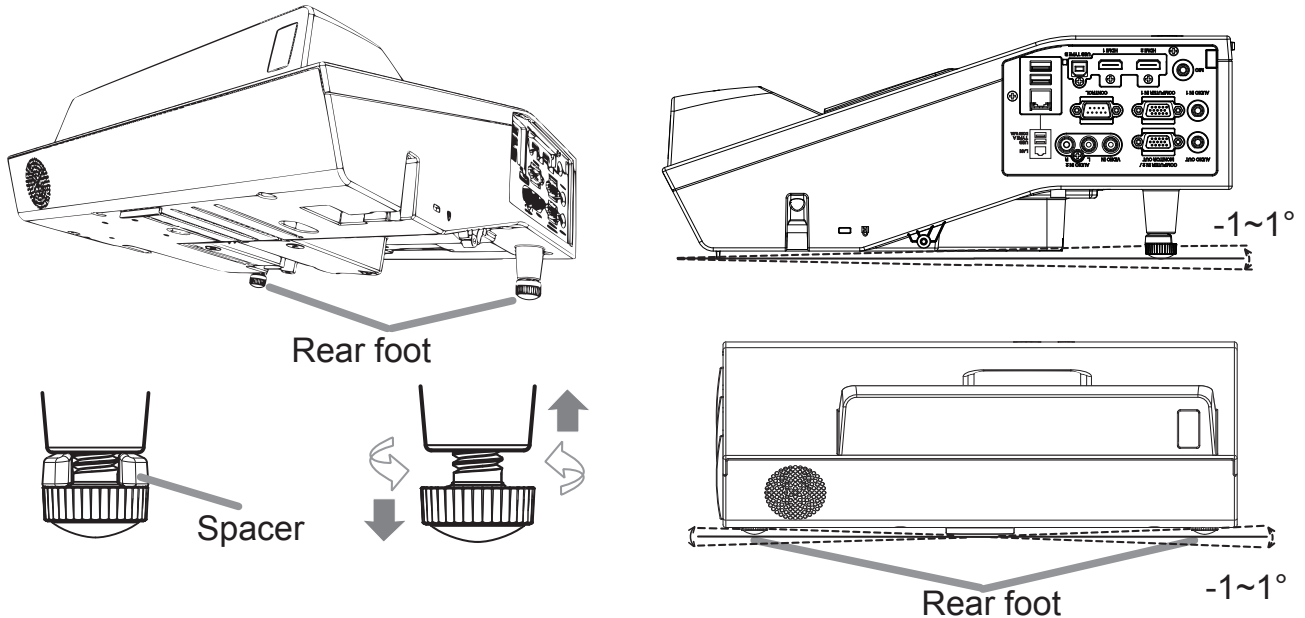

**⚠ WARNING** ▶ Keep the spacers away from children and pets. Be careful not to let them swallow the spacers. If swallowed, consult a physician immediately for emergency treatment.

**NOTE** • The adjustment angle can be adjusted up to plus or minus 1° each of foot.  
 • After the foot is adjusted, it is possible to return it to the state of the shipment with a spacer. If change the setting place of the projector, it will recommend keep and reuse the spacers.

## Adjusting the zoom and focus

Press the **D-ZOOM +** or **D-ZOOM -** button on the remote control to display D-ZOOM dialog on screen.

Use the **D-ZOOM +** and **D-ZOOM -** buttons to adjust the picture size.

To finish the operation, do not touch these buttons for about ten seconds until the dialog is disappeared.

• If you want to expand a part of the image, use the magnify function (📖30).

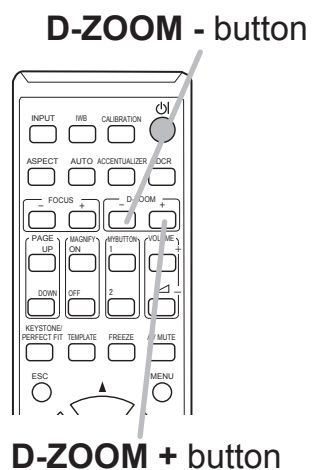

(continued on next page)

Press the **FOCUS +** or **FOCUS -** button on the remote control, or **FOCUS +** or **FOCUS -** button on the projector (📖5) while no menu is on screen, to display the FOCUS box on screen. Use the **FOCUS +** and **FOCUS -** buttons to adjust the screen focus. After the focus adjustment, wait for a while until the FOCUS box is disappeared, if you want to display any other menu on screen by pushing the **MENU** button on the projector.

- The ◀/▶/▲/▼ buttons on the projector work only as the cursor buttons while the template is displayed (📖59).

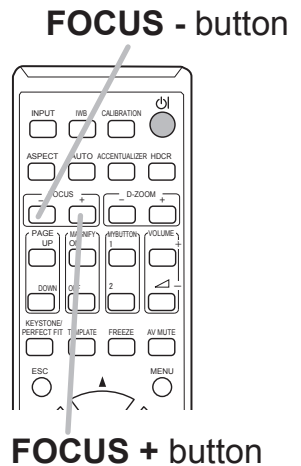

## Using the automatic adjustment feature

1. Press **AUTO** button on the remote control.
  - Pressing this button performs the following.

- **For a computer signal**

The vertical position, the horizontal position and the horizontal phase will be automatically adjusted.

Make sure that the application window is set to its maximum size prior to attempting to use this feature. A dark picture may still be incorrectly adjusted. Use a bright picture when adjusting.

- **For a video signal**

The video format best suited for the respective input signal will be selected automatically. This function is available only when the AUTO is selected for the VIDEO FORMAT item in the INPUT menu (📖45). The vertical position and horizontal position will be automatically set to the default.

- **For a component video signal**

The vertical position and horizontal position will be automatically set to the default. The horizontal phase will be automatically adjusted.

- The automatic adjustment operation requires approx. 10 seconds. Also please note that it may not function correctly with some input.
- When this function is performed for a video signal, a certain extra such as a line may appear outside a picture.
- When this function is performed for a computer signal, a black frame may be displayed on the edge of the screen, depending on the PC model.
- The items adjusted by this function may vary when the FINE or DISABLE is selected for the AUTO ADJUST item of the SERVICE item in the OPTION menu (📖68).

### AUTO button

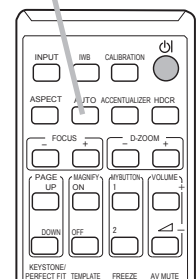

## Using the **TEMPLATE** feature

1. Press the **TEMPLATE** button on the remote control to display the template. Each time you press the ▲/▼ cursor buttons, the projector switches the mode for **TEMPLATE** in turn.

TEST PATTERN ⇔ DOT-LINE1 ⇔ DOT-LINE2 ⇔ DOT-LINE3



HAS-WM05



HAS-WM03 ⇔ MAP2 ⇔ MAP1 ⇔ CIRCLE2 ⇔ CIRCLE1



DOT-LINE4

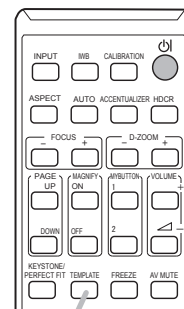

**TEMPLATE** button

## Other buttons

**HDCR**: Displays the HDCR menu (📖 37).

**ACCENTUALIZER**: Displays the ACCENTUALIZER menu (📖 37).

**ACCENTUALIZER** button

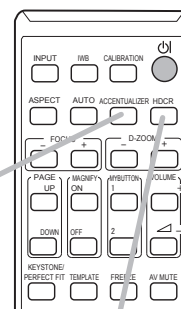



**HDCR** button

## Adjusting the position

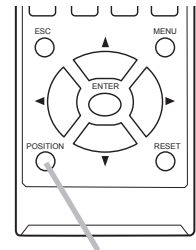

1. Press the **POSITION** button on the remote control while no menu is on screen, to display the D-SHIFT (  48) dialog on screen.
2. Use the ▲, ▼, ◀ and ▶ buttons to adjust the picture position.  
 Press the **POSITION** button again to finish this operation.



**POSITION** button

- This is a function to shift the position of the shrunken picture by the D-ZOOM (  48) function.
- When an OSD (On Screen Display) menu is displayed, this operation moves the position of the OSD menu, but not the position of the picture (  33).
- The D-SHIFT adjustment values are not valid when the D-ZOOM is set to 320 (full screen).

## Correcting the keystone/perfect fit distortions

1. Press the **KEYSTONE/PERFECT FIT** button on the remote control. A dialog will appear on the screen to aid you in correcting the distortion.
2. Use the ▲/▼ cursor buttons to select MANUAL or PERFECT FIT operation, and press the ▶ button to perform the following.
  - (1) MANUAL displays a dialog for keystone correction. Use the ▲/▼ buttons to select  KEYSTONE /  KEYSTONE, then use the ◀/▶ buttons for adjustment.
  - (2) PERFECT FIT displays a dialog for adjusting the shape of the projected image in each of the corners and sides. To close the dialog and complete this operation, press **KEYSTONE/PERFECT FIT** button again. Even if you do not do anything, the dialog will automatically disappear after about ten seconds.



**KEYSTONE/ PERFECT FIT** button

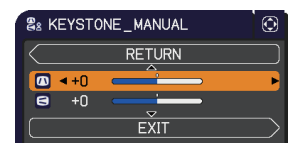
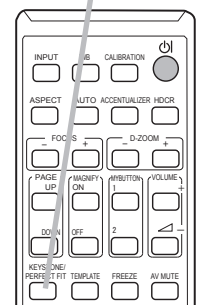

- The adjustable range of this function will vary among inputs. For some input, this function may not work well.

## Using the magnify feature

1. Press the **MAGNIFY ON** button on the remote control.  
 The picture will be magnified, and the MAGNIFY dialog will appear on the screen. When the **MAGNIFY ON** button is pressed for the first time after the projector is turned on, the picture will be zoomed by 1.5 times. On the dialog, triangle marks to show each direction will be displayed.

**MAGNIFY ON/OFF button**

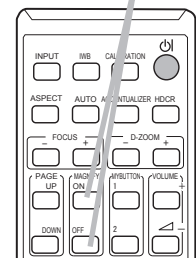

2. The display magnification of the projector switches in order with every press of the **MAGNIFY ON** button.

- For computer signals, HDMI® (RGB) signals, input signals from the LAN, USB TYPE A or USB TYPE B port

1.5 times → 2 times → 3 times → 4 times → 1 time



- For video signals, component video signals or HDMI® (Component) signals

1.5 times → 2 times → 1 time



3. While the triangles are displayed on the dialog, use the ▲/▼/◀/▶ cursor buttons to shift the magnifying area.

4. Press the **MAGNIFY OFF** button on the remote control to exit magnification.

- The MAGNIFY dialog will automatically disappear in several seconds with no operation. The dialog will appear again if the **MAGNIFY ON** button is pressed when the dialog has automatically disappeared.
- The magnification is automatically disabled when the displaying signal or its display condition is changed.
- While the magnification is active, the keystone distortion condition may vary. It will be restored when the magnification is disabled.
- Some horizontal stripes might be visible on the image while magnification is active.
- This function is not available in the following cases:
  - A sync signal in the range not supported is input.
  - There is no input signal.

## Temporarily freezing the screen

1. Press the **FREEZE** button on the remote control.
    - The “FREEZE” indication will appear on the screen (however, the indication will not appear when the OFF is selected for the MESSAGE item in the SCREEN menu (📖57)), and the projector will go into the FREEZE mode, which the picture is frozen.
- To exit the FREEZE mode and restore the screen to normal, press the **FREEZE** button again.

**FREEZE** button

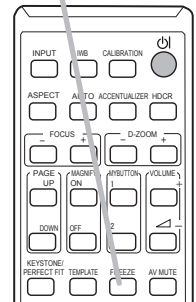

- The projector automatically exits from the FREEZE mode when some control buttons are pressed.
- If the projector continues projecting a still image for a long time, the LCD panel might possibly be burned in. Do not leave the projector in the FREEZE mode for too long.
- Images might appear degraded when this function is operated, but it is not a malfunction.

## Using the menu function

This projector has the following menus:

PICTURE, IMAGE, INPUT, SETUP, AUDIO, SCREEN, OPTION, NETWORK, SECURITY and EASY MENU.

EASY MENU consists of functions often used, and the other menus are classified into each purpose and brought together as the ADVANCED MENU.

Each of these menus is operated using the same methods. While the projector is displaying any menu, the **MENU** button on the projector works as the cursor buttons. The basic operations of these menus are as follows.

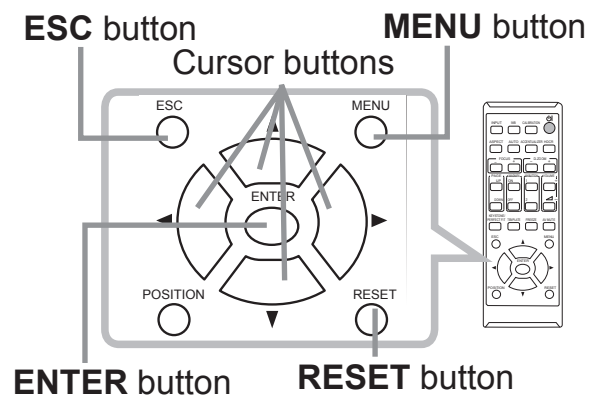
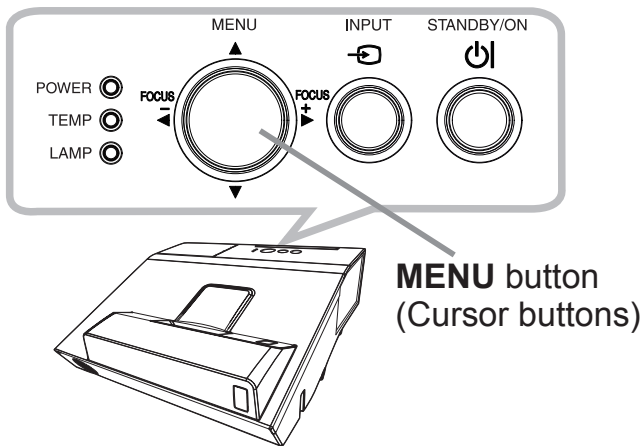

1. To start the MENU, press the **MENU** button. The MENU you last used (EASY or ADVANCED) will appear. EASY MENU has priority to appear just after powered on.

### 2. In the EASY MENU

- (1) Use the ▲/▼ cursor buttons to select an item to operate. If you want to change it to the ADVANCED MENU, select the ADVANCED MENU.
- (2) Use the ◀/▶ cursor buttons to operate the item.

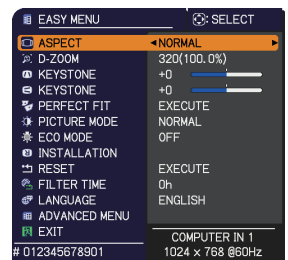

### In the ADVANCED MENU

- (1) Use the ▲/▼ cursor buttons to select a menu. If you want to change it to the EASY MENU, select the EASY MENU. The items in the menu appear on the right side.
- (2) Press the ▶ cursor button or **ENTER** button to move the cursor to the right side. Then use the ▲/▼ cursor buttons to select an item to operate and press the ▶ cursor button or **ENTER** button to progress. The operation menu or dialog of the selected item will appear.
- (3) Use the buttons as instructed in the OSD to operate the item.

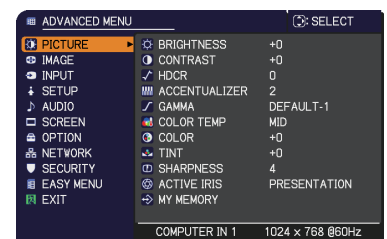

(continued on next page)



### Using the menu function (continued)

3. To close the MENU, press the **MENU** button again or select EXIT and press the ◀ cursor button or **ENTER** button. Even if you do not do anything, the dialog will automatically disappear after about 30 seconds.
  - If you want to move the menu position, use the cursor buttons after pressing the **POSITION** button.
  - Some functions cannot be performed when a certain input port is selected, or when a certain input signal is displayed.
  - When you want to reset the operation, press the **RESET** button on the remote control during the operation. Note that some items (ex. LANGUAGE, VOLUME) cannot be reset.
  - In the ADVANCED MENU, when you want to return to the previous display, press the ◀ cursor button or **ESC** button on the remote control.

### Indication in OSD (On Screen Display)

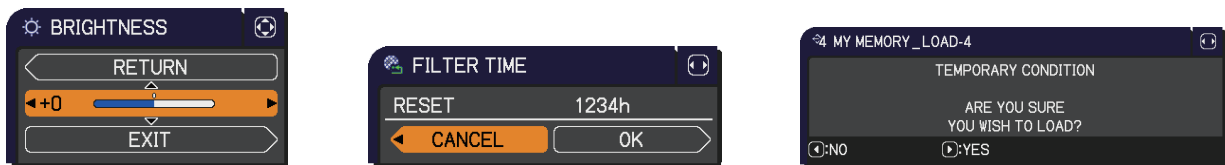

The meanings of the general words on the OSD are as follows.

Indication	Meaning
EXIT	Selecting this word finishes the OSD menu. It's the same as pressing the <b>MENU</b> button.
RETURN	Selecting this word returns the menu to the previous menu.
CANCEL or NO	Selecting this word cancels the operation in the present menu and returns to the previous menu.
OK or YES	Selecting this word executes the prepared function or shifts the menu to the next menu.

EASY MENU

From the EASY MENU, items shown in the table below can be performed.

Select an item using the ▲/▼ cursor buttons. Then perform it according to the following table.

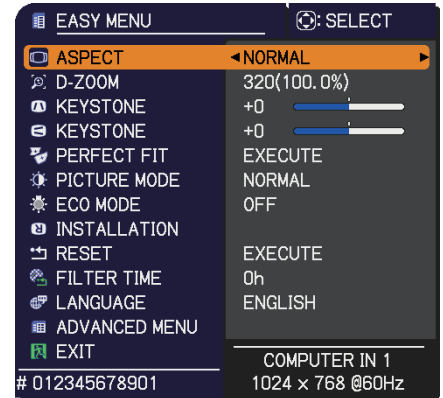

Item	Description
<b>ASPECT</b>	Using the ◀/▶ buttons switches the mode for aspect ratio. See the ASPECT item in IMAGE menu (📖41).
<b>D-ZOOM</b>	Using the ◀/▶ cursor buttons adjusts the magnification ratio. Small ⇄ Large See the D-ZOOM item in the SETUP menu (📖48). • The on-screen menu might be displayed outside of the image display area depending on the adjustment value of the ASPECT and D-ZOOM. Changing the values of ASPECT and D-ZOOM may fix the symptom.
<b>⏏ KEYSTONE</b>	Using the ◀/▶ buttons corrects the vertical keystone distortion. See the ⏏ KEYSTONE item in SETUP menu (📖49).
<b>⏏ KEYSTONE</b>	Using the ◀/▶ buttons corrects the horizontal keystone distortion. See the ⏏ KEYSTONE item in SETUP Menu (📖49).
<b>PERFECT FIT</b>	Pressing the ▶ button displays the dialog for adjusting the shape of the projected image in each of the corners and sides. See the PERFECT FIT item in SETUP menu (📖50).

(continued on next page)

Item	Description
<b>PICTURE MODE</b>	<p>Using the ◀/▶ buttons switches the picture mode. The picture modes are combinations of GAMMA and COLOR TEMP settings. Choose a suitable mode according to the projected source.</p> <p style="text-align: center;">NORMAL ⇔ CINEMA ⇔ DYNAMIC ⇔ BOARD(BLACK)  ⇕  DICOM SIM. <span style="float: right;">⇕</span>  ⇕  PHOTO ⇔ DAYTIME ⇔ WHITEBOARD ⇔ BOARD(GREEN)</p> <ul style="list-style-type: none"> <li>• When the combination of GAMMA and COLOR TEMP differs from pre-assigned modes above, the display on the menu for the PICTURE MODE is “CUSTOM”. Please refer to the GAMMA and COLOR TEMP (📖38, 39) items in PICTURE menu.</li> <li>• Lines or other noise might appear on the screen when this function is operated, but it is not a malfunction.</li> <li>• DICOM SIM. is the projector's DICOM® ("Digital Imaging and Communication in Medicine") simulation mode. This mode simulates the DICOM standard, which is a standard applicable to digital communications in medicine, and can be useful for displaying medical images, such as X-rays photos. This projector is not a medical device and is not compliant to the DICOM standard, and neither the projector nor the DICOM SIM. mode should be used for medical diagnosis.</li> </ul>
<b>ECO MODE</b>	<p>Using the ◀/▶ buttons changes the eco mode setting. See the ECO MODE item of the LAMP &amp; FILTER item in SETUP menu. (📖51)</p> <ul style="list-style-type: none"> <li>• When the ambient temperature is around 35 to 40°C, the brightness of lamp is reduced automatically.</li> </ul>
<b>INSTALLATION</b>	<p>Pressing the ▶ button displays the INSTALLATION dialog. See the INSTALLATION item in SETUP menu (📖53).</p>
<b>RESET</b>	<p>Performing this item resets all of the EASY MENU items except the FILTER TIME and LANGUAGE. A dialog is displayed for confirmation. Selecting the OK using the ▶ button performs resetting.</p>
<b>FILTER TIME</b>	<p>The usage time of the air filter is shown in the menu. Performing this item resets the filter time which counts usage time of the air filter. A dialog is displayed for confirmation. Selecting the OK using the ▶ button performs resetting. See the FILTER TIME item of the LAMP &amp; FILTER item in SETUP menu. (📖52)</p>

(continued on next page)

## EASY MENU

Item	Description
<b>LANGUAGE</b>	Using the ◀/▶ buttons changes the display language. See the LANGUAGE item in SCREEN menu (📖55).
<b>ADVANCED MENU</b>	Press the ▶ or <b>ENTER</b> button to use the menu of PICTURE, IMAGE, INPUT, SETUP, AUDIO, SCREEN, OPTION, NETWORK or SECURITY.
<b>EXIT</b>	Press the ◀ or <b>ENTER</b> button to finish the OSD menu.

## PICTURE menu

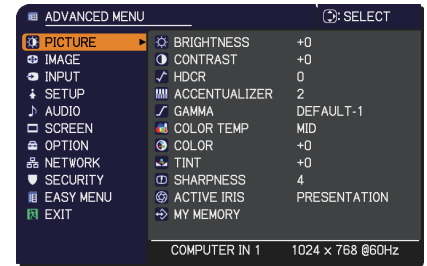

From the PICTURE menu, items shown in the table below can be performed.

Select an item using the ▲/▼ cursor buttons, and press the ► cursor button or **ENTER** button to execute the item. Then perform it according to the following table.



Item	Description
<b>BRIGHTNESS</b>	Using the ◀/▶ buttons adjusts the brightness. Dark ⇔ Light
<b>CONTRAST</b>	Using the ◀/▶ buttons adjusts the contrast. Weak ⇔ Strong
<b>HDCR</b>	A function to show a clear picture in a bright room. Using the ◀/▶ buttons adjusts the contrast. • This function may not work properly when IMAGE OPTIMIZER is enabled.
<b>ACCENTUALIZER</b>	ACCENTUALIZER is a function to improve the legibility. Using the ◀/▶ buttons adjusts the sharpness. Weak ⇔ Strong • There may be some noise and/or the screen may flicker for a moment when an adjustment is made. This is not a malfunction. • This function may not work properly when IMAGE OPTIMIZER is enabled.

(continued on next page)

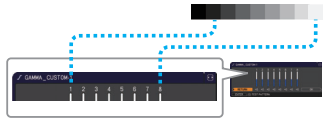
Item	Description
<p><b>GAMMA</b></p>	<p>Using the ▲/▼ buttons switches the gamma mode.</p> <p><b>To adjust CUSTOM</b></p> <p>Selecting a mode whose name includes CUSTOM and then pressing the ► button or the <b>ENTER</b> button displays a dialog to aid you in adjusting the mode. This function is useful when you want to change the brightness of particular tones.</p>  <p>Choose an item using the ◀/▶ buttons, and adjust the level using the ▲/▼ buttons.</p> <p>You can display a test pattern for checking the effect of your adjustment by pressing the <b>ENTER</b> button. Each time you press the <b>ENTER</b> button, the pattern changes as below.</p> <p>No pattern ⇨ Gray scale of 9 steps ⇩</p> <p>⇧ Ramp ⇩ Gray scale of 15 steps</p>  <p>The eight equalizing bars correspond to eight tone levels of the test pattern (Gray scale of 9 steps) except the darkest in the left end. If you want to adjust the 2nd tone from left end on the test pattern, use the equalizing adjustment bar "1". The darkest tone at the left end of the test pattern cannot be controlled with any of equalizing adjustment bar.</p> <ul style="list-style-type: none"> <li>• Lines or other noise might appear on the screen when this function is operated, but it is not a malfunction.</li> </ul> 

(continued on next page)

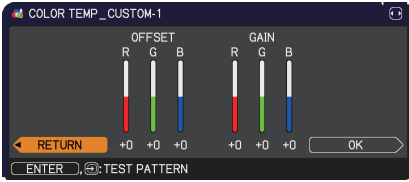
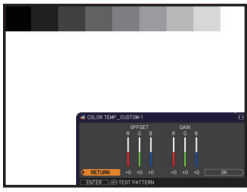
Item	Description
<p><b>COLOR TEMP</b></p>	<p>Using the ▲/▼ buttons switches the color temperature mode.</p> <p><b>To adjust CUSTOM</b></p> <p>Selecting a mode whose name includes CUSTOM and then pressing the ► button or the <b>ENTER</b> button displays a dialog to aid you in adjusting the OFFSET and GAIN of the selected mode.</p>  <p>OFFSET adjustments change the color intensity on the whole tones of the test pattern.</p> <p>GAIN adjustments mainly affect color intensity on the brighter tones of the test pattern.</p> <p>Choose an item using the ◀/▶ buttons, and adjust the level using the ▲/▼ buttons.</p> <p>You can display a test pattern for checking the effect of your adjustment by pressing the <b>ENTER</b> button. Each time you press the <b>ENTER</b> button, the pattern changes as below.</p> <p>No pattern ⇔ Gray scale of 9 steps ⇓          ↑ ⇔ Ramp ⇔ Gray scale of 15 steps</p>  <ul style="list-style-type: none"> <li>• Lines or other noise might appear on the screen when this function is operated, but it is not a malfunction.</li> </ul>
<p><b>COLOR</b></p>	<p>Using the ◀/▶ buttons adjusts the strength of whole color.</p> <p>Weak ⇔ Strong</p> <ul style="list-style-type: none"> <li>• This item is unavailable for a computer signal of <b>COMPUTER IN</b> or <b>HDMI</b> port, and is also unavailable for <b>LAN</b>, <b>USB TYPE A</b> and <b>USB TYPE B</b> port.</li> </ul>
<p><b>TINT</b></p>	<p>Using the ◀/▶ buttons adjusts the tint.</p> <p>Reddish ⇔ Greenish</p> <ul style="list-style-type: none"> <li>• This item is unavailable for a computer signal of <b>COMPUTER IN</b> or <b>HDMI</b> port, and is also unavailable for <b>LAN</b>, <b>USB TYPE A</b> and <b>USB TYPE B</b> port.</li> </ul>

(continued on next page)

Item	Description
<p><b>SHARPNESS</b></p>	<p>Using the ◀/▶ buttons adjusts the sharpness. Weak ⇔ Strong</p> <ul style="list-style-type: none"> <li>• There may be some noise and/or the screen may flicker for a moment when an adjustment is made. This is not a malfunction.</li> </ul>
<p><b>ACTIVE IRIS</b></p>	<p>Using the ▲/▼ cursor buttons changes the active iris control mode. PRESENTATION ⇔ THEATER ⇔ OFF ↑—————↑</p> <p><u>PRESENTATION</u> : The active iris displays the best presentation image for both bright and dark scenes. <u>THEATER</u> : The active iris displays the best theater image for both bright and dark scenes. <u>OFF</u> : The active iris is always open.</p> <ul style="list-style-type: none"> <li>• The screen may flicker when the PRESENTATION or THEATER modes are selected. If this occurs select OFF.</li> </ul>
<p><b>MY MEMORY</b></p>	<p>This projector has 4 memories for adjustment data (for all the items of the PICTURE menu). Selecting a function using the ▲/▼ buttons and pressing the ▶ or <b>ENTER</b> button performs each function.</p> <p>↳ LOAD-1 ⇔ LOAD-2 ⇔ LOAD-3 ⇔ LOAD-4 ↲ ↳ SAVE-4 ⇔ SAVE-3 ⇔ SAVE-2 ⇔ SAVE-1 ↲</p> <p><u>LOAD-1, LOAD-2, LOAD-3, LOAD-4</u> Performing a LOAD function loads the data from the memory linked in the number included in the function's name, and adjusts the picture automatically depending on the data.</p> <ul style="list-style-type: none"> <li>• The LOAD functions whose linked memory has no data are skipped.</li> <li>• Remember that the current adjusted condition will be lost by loading data. If you want to keep the current adjustment, please save it before performing a LOAD function.</li> <li>• There may be some noise and the screen may flicker for a moment when loading data. This is not malfunction.</li> <li>• You can perform the LOAD function using the <b>MY BUTTON</b>. Please see MY BUTTON item in OPTION menu (63).</li> </ul> <p><u>SAVE-1, SAVE-2, SAVE-3, SAVE-4</u> Performing a SAVE function saves the current adjustment data into the memory linked in the number included in the function's name.</p> <ul style="list-style-type: none"> <li>• Remember that the current data being stored of a memory will be lost by saving new data into the memory.</li> </ul>



IMAGE menu

From the IMAGE menu, items shown in the table below can be performed.

Select an item using the ▲/▼ cursor buttons, and press the ► cursor button or **ENTER** button to execute the item. Then perform it according to the following table.

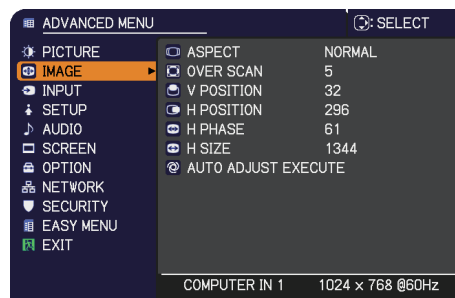

Item	Description
<b>ASPECT</b>	<p>Using the ▲/▼ buttons switches the mode for aspect ratio.</p> <p><b>For a computer signal</b>                      NORMAL ⇔ 4:3 ⇔ 16:9 ⇔ 16:10 ⇔ ZOOM ⇔ NATIVE</p> <p><b>For an HDMI® signal</b>                      NORMAL ⇔ 4:3 ⇔ 16:9 ⇔ 16:10 ⇔ 14:9 ⇔ ZOOM ⇔ NATIVE</p> <p><b>For a video signal or component video signal</b>                      4:3 ⇔ 16:9 ⇔ 16:10 ⇔ 14:9 ⇔ ZOOM ⇔ NATIVE</p> <p><b>For an input signal from the LAN, USB TYPE A or USB TYPE B port, or if there is no signal</b>                      16:10 (fixed)                      • The NORMAL mode keeps the original aspect ratio of the signal.</p>
<b>OVER SCAN</b>	<p>Using the ◀/▶ buttons adjusts the over-scan ratio.                      Small (It magnifies picture) ⇔ Large (It reduces picture)</p> <p>• This item can't be selected for a computer signal of <b>COMPUTER IN</b> port, and <b>LAN, USB TYPE A, USB TYPE B</b> port.</p>

(continued on next page)

Item	Description
<p><b>V POSITION</b></p>	<p>Using the ◀/▶ buttons adjusts the vertical position. Down ⇔ Up</p> <ul style="list-style-type: none"> <li>• Over-adjusting the vertical position may cause noise to appear on the screen. If this occurs, please reset the vertical position to the default setting. Pressing the <b>RESET</b> button when the V POSITION is selected will reset the V POSITION to the default setting.</li> <li>• When this function is performed on a video signal, the range of this adjustment depends on OVER SCAN (📖41) setting. It is not possible to adjust when OVER SCAN is set to 10.</li> <li>• This function is unavailable for a signal from the <b>LAN, USB TYPE A, USB TYPE B</b> or <b>HDMI 1/2</b> port.</li> </ul>
<p><b>H POSITION</b></p>	<p>Using the ◀/▶ buttons adjusts the horizontal position. Right ⇔ Left</p> <ul style="list-style-type: none"> <li>• Over-adjusting the horizontal position may cause noise to appear on the screen. If this occurs, please reset the horizontal position to the default setting. Pressing the <b>RESET</b> button when the H POSITION is selected will reset the H POSITION to the default setting.</li> <li>• When this function is performed on a video signal, the range of this adjustment depends on OVER SCAN (📖41) setting. It is not possible to adjust when OVER SCAN is set to 10.</li> <li>• This function is unavailable for a signal from the <b>LAN, USB TYPE A, USB TYPE B</b> or <b>HDMI 1/2</b> port.</li> </ul>

(continued on next page)

Item	Description
<b>H PHASE</b>	<p>Using the ◀/▶ buttons adjusts the horizontal phase to eliminate flicker. Right ⇔ Left</p> <ul style="list-style-type: none"> <li>• This item can be selected only for a computer signal or a component video signal. This function is unavailable for a signal from the <b>LAN, USB TYPE A, USB TYPE B</b> or <b>HDMI 1/2</b> port.</li> </ul>
<b>H SIZE</b>	<p>Using the ◀/▶ buttons adjusts the horizontal size. Small ⇔ Large</p> <ul style="list-style-type: none"> <li>• This item can be selected only for a computer signal. This function is unavailable for a signal from the <b>LAN, USB TYPE A, USB TYPE B</b> or <b>HDMI 1/2</b> port.</li> <li>• When this adjustment is excessive, the picture may not be displayed correctly. In such a case, please reset the adjustment by pressing the <b>RESET</b> button on the remote control during this operation.</li> <li>• Images might appear degraded when this function is operated, but it is not a malfunction.</li> </ul>
<b>AUTO ADJUST EXECUTE</b>	<p>Selecting this item performs the automatic adjustment feature.</p> <p><b>For a computer signal</b> The vertical position, the horizontal position and the horizontal phase will be automatically adjusted. Make sure that the application window is set to its maximum size prior to attempting to use this feature. A dark picture may still be incorrectly adjusted. Use a bright picture when adjusting.</p> <p><b>For a video signal</b> The video format best suited for the respective input signal will be selected automatically. This function is available only when the AUTO is selected for the VIDEO FORMAT item in the INPUT menu (📖45). The vertical position and horizontal position will be automatically set to the default.</p> <p><b>For a component video signal</b> The vertical position and horizontal position will be automatically set to the default. The horizontal phase will be automatically adjusted.</p> <ul style="list-style-type: none"> <li>• The automatic adjustment operation requires approx. 10 seconds. Also please note that it may not function correctly with some input.</li> <li>• When this function is performed for a video signal, a certain extra such as a line may appear outside a picture.</li> <li>• When this function is performed for a computer signal, a black frame may be displayed on the edge of the screen, depending on the PC model.</li> <li>• The items adjusted by this function may vary when the FINE or DISABLE is selected for the AUTO ADJUST item of the SERVICE item in the OPTION menu (📖68).</li> </ul>

## INPUT menu

From the INPUT menu, items shown in the table below can be performed.

Select an item using the ▲/▼ cursor buttons, and press the ► cursor button or **ENTER** button to execute the item. Then perform it according to the following table.

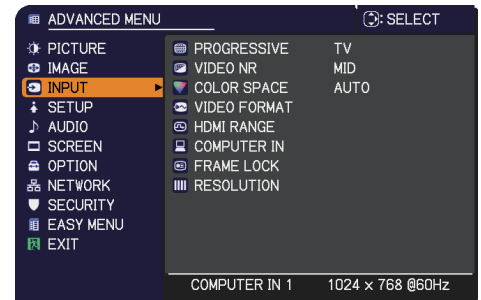

Item	Description
<b>PROGRESSIVE</b>	<p>Using the ▲/▼ buttons switches the progress mode.                      TV ⇄ FILM ⇄ OFF                      ↑—————↑</p> <ul style="list-style-type: none"> <li>• This function works only for a video signal, component video signal (of 480i@60 or 576i@50 or 1080i@50/60) and an HDMI® signal (of 480i@60 or 576i@50 or 1080i@50/60).</li> <li>• When TV or FILM is selected, the screen image will be sharp. FILM adapts to the 2-3 Pull-Down conversion system. But these may cause a certain defect (for example, jagged line) of the picture for a quick moving object. In such a case, please select OFF, even though the screen image may lose sharpness.</li> </ul>
<b>VIDEO NR</b>	<p>Using the ▲/▼ buttons switches the noise reduction mode.                      HIGH ⇄ MID ⇄ LOW                      ↑—————↑</p> <ul style="list-style-type: none"> <li>• This function works only for a video signal, component video signal (of 480i@60 or 576i@50 or 1080i@50/60) and an HDMI® signal (of 480i@60 or 576i@50 or 1080i@50/60).</li> </ul>
<b>COLOR SPACE</b>	<p>Using the ▲/▼ buttons switches the mode for color space.                      AUTO ⇄ RGB ⇄ SMPTE240 ⇄ REC709 ⇄ REC601                      ↑—————↑</p> <ul style="list-style-type: none"> <li>• This item can be selected only for a computer signal, component video signal(except for signals from the <b>LAN</b>, <b>USB TYPE A</b> and <b>USB TYPE B</b> ports) or an HDMI™ signal.</li> <li>• The AUTO mode automatically selects the optimum mode.</li> <li>• The AUTO operation may not work well at some signals. In such a case, it might be good to select a suitable mode except AUTO.</li> </ul>

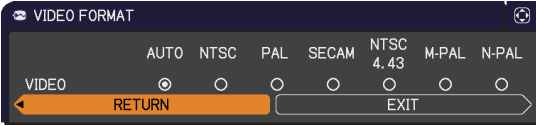
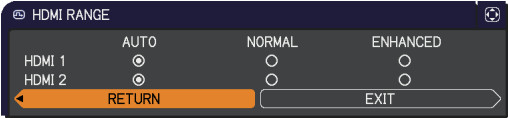

(continued on next page)

Item	Description
<p><b>VIDEO FORMAT</b></p>	<p>The video format for <b>VIDEO IN</b> port can be set. Using the ◀/▶ buttons switches the mode for video format.</p>  <p>AUTO ⇔ NTSC ⇔ PAL ⇔ SECAM          ↕ N-PAL ⇔ M-PAL ⇔ NTSC4.43 ↕</p> <ul style="list-style-type: none"> <li>• This item is performed only for a video signal from the <b>VIDEO IN</b> port.</li> <li>• The AUTO mode automatically selects the optimum mode.</li> <li>• The AUTO operation may not work well for some signals. If the picture becomes unstable (e.g. an irregular picture, lack of color), please select the mode according to the input signal.</li> </ul>
<p><b>HDMI RANGE</b></p>	<p>The digital range of HDMI<sup>®</sup> input signals from the <b>HDMI 1</b> and <b>2</b> ports can be set.          (1) Use the ▲/▼ buttons to select the <b>HDMI</b> port to be set.          (2) Use the ◀/▶ buttons to select the digital range.</p>  <p>AUTO ⇔ NORMAL ⇔ ENHANCED          ↕ ↕</p> <p>AUTO: automatically sets the optimum mode.          NORMAL: sets the suitable mode for DVD signals. (16-235)          ENHANCED: sets the suitable mode for computer signals. (0-255)</p> <ul style="list-style-type: none"> <li>• If the contrast of the screen image is too strong or too weak, try finding a more suitable mode.</li> </ul>

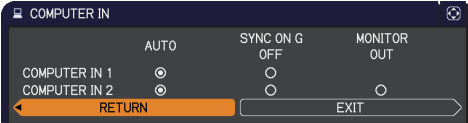
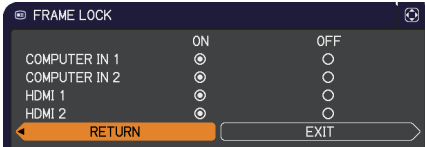
(continued on next page)

Item	Description
<p><b>COMPUTER IN</b></p>	<p>The computer input signal type for <b>COMPUTER IN1</b> and <b>IN2</b> ports can be set.</p> <p>(1) Use the ▲/▼ buttons to select the <b>COMPUTER IN</b> port to be set.</p> <p>(2) Use the ◀/▶ buttons to select the computer input signal type.</p> <p>(COMPUTER IN1)            AUTO ⇔ SYNC ON G OFF</p> <p>(COMPUTER IN2)            AUTO ⇔ SYNC ON G OFF ⇔ MONITOR OUT</p> <ul style="list-style-type: none"> <li>• Selecting the AUTO mode allows you to input a sync on G signal or component video signal from the port (📖12).</li> <li>• In the AUTO mode, the picture may be distorted with certain input signals. In such a case, remove the signal connector so that no signal is received and select the SYNC ON G OFF, and then reconnect the signal.</li> </ul> 
<p><b>FRAME LOCK</b></p>	<p>Set the frame lock function on/off for each port.</p> <p>(1) Use the ▲/▼ buttons to select the input ports.</p> <p>(2) Use the ◀/▶ buttons to turn the frame lock function on/off .</p> <p>ON ⇔ OFF</p> <ul style="list-style-type: none"> <li>• This item can be performed only on a signal with a vertical frequency of 49 to 51Hz, 59 to 61 Hz.</li> <li>• When ON is selected, moving pictures are displayed more smoothly.</li> <li>• This function is unavailable for a signal from the <b>HDMI</b> (of 480i@60 or 576i@50 or 1080i@50/60) port.</li> </ul> 

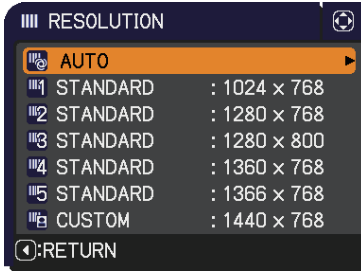
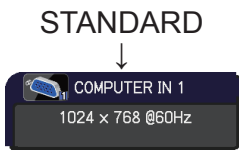
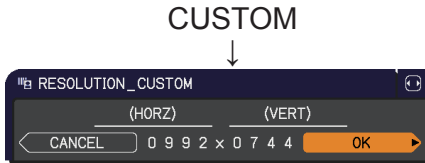
(continued on next page)

Item	Description
<p><b>RESOLUTION</b></p>	<p>The resolution for the <b>COMPUTER IN1</b> and <b>COMPUTER IN2</b> input signals can be set on this projector.</p> <p>(1) In the INPUT menu select the RESOLUTION using the ▲/▼ buttons and press the ► button. The RESOLUTION menu will be displayed.</p>  <p>(2) In the RESOLUTION menu select the resolution you wish to display using the ▲/▼ buttons. Selecting AUTO will set a resolution appropriate to the input signal.</p> <p>(3) Pressing the ► or <b>ENTER</b> button when selecting a STANDARD resolution will automatically adjust the horizontal and vertical positions, clock phase and horizontal size. The INPUT_INFORMATION dialog will be displayed.</p>  <p>(4) To set a custom resolution use the ▲/▼ buttons to select the CUSTOM and the RESOLUTION_CUSTOM box will be displayed. Set the horizontal (HORZ) and vertical (VERT) resolutions using the ▲/▼/◀/▶ buttons. This function may not support all resolutions.</p>  <p>(5) Move the cursor to OK on screen and press the ► or <b>ENTER</b> button. The message "ARE YOU SURE YOU WISH TO CHANGE RESOLUTION?" appears. To save the setting, press the ► button. The horizontal and vertical positions, clock phase and horizontal size will be automatically adjusted. The INPUT_INFORMATION dialog will be displayed.</p>  <p>(6) To revert back to the previous resolution without saving changes, move the cursor to CANCEL on screen and press the ◀ or <b>ENTER</b> button. The screen will then return to the RESOLUTION menu displaying the previous resolution.</p> <ul style="list-style-type: none"> <li>• For some pictures, this function may not work well.</li> </ul>

## SETUP menu

From the SETUP menu, items shown in the table below can be performed.

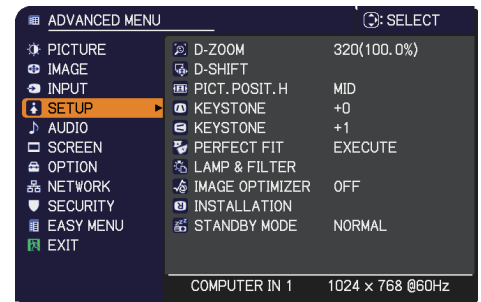

Select an item using the ▲/▼ cursor buttons, and press the ► cursor button or **ENTER** button to execute the item. Then perform it according to the following table.









Item	Description
<b>D-ZOOM</b>	Using the ◀/▶ cursor buttons adjusts the magnification ratio. Small ⇔ Large • The on-screen menu might be displayed outside of the image display area depending on the adjustment value of the ASPECT and D-ZOOM. Changing the values of ASPECT and D-ZOOM may fix the symptom.
<b>D-SHIFT</b>	Using the ◀/▶/▲/▼ cursor buttons adjusts the picture position. • The D-SHIFT adjustment values are not valid when the D-ZOOM is set to 320 (full screen).

(continued on next page)



Item	Description
<p><b>PICT. POSIT. H</b></p>	<p>Using the ▲/▼ cursor buttons selects the horizontal picture position.            LEFT ⇔ MID ⇔ RIGHT            The PICT. POSIT. H is not changed if any of the following cases apply.</p> <ul style="list-style-type: none"> <li>• The ASPECT is set to 16:9 or 16:10 or ZOOM.</li> <li>• The input signal has an aspect ratio of 16:9, 16:10 or vertically smaller than 16:10, while ASPECT is set to NORMAL.</li> <li>• Horizontal size of the displayed image is full on the effective display area, while the ASPECT is set to NATIVE.</li> <li>• One of the following messages is displayed on the screen:              "NO INPUT IS DETECTED"              "SYNC IS OUT OF RANGE"              "INVALID SCAN FREQ."</li> <li>• The BLANK or TEMPLATE function is selected.</li> </ul>
<p> <b>KEYSTONE</b></p>	<p>Using the ◀/▶ buttons corrects the vertical keystone distortion.            Shrink the bottom of the image ⇔ Shrink the top of the image</p> <ul style="list-style-type: none"> <li>• The adjustable range of this function will vary among inputs. For some input, this function may not work well.</li> <li>• This function will be unavailable when the PERFECT FIT (📖50) is adjusted.</li> </ul>
<p> <b>KEYSTONE</b></p>	<p>Using the ◀/▶ buttons corrects the horizontal keystone distortion.            Shrink the right of the image ⇔ Shrink the left of the image</p> <ul style="list-style-type: none"> <li>• The adjustable range of this function will vary among inputs. For some input, this function may not work well.</li> <li>• This function will be unavailable when the PERFECT FIT (📖50) is adjusted.</li> </ul>

(continued on next page)

Item	Description
<p><b>PERFECT FIT</b></p>	<p>This item allows you to adjust the shape of the projected image in each of the corners and sides.</p> <p>(1) Choose a corner or side to adjust using the ▲/▼/◀/▶ buttons and press the <b>ENTER</b> or  button.</p> <p>(2) Adjust the distortion as below. Use the ▲/▼/◀/▶ buttons to adjust the position of the corner. Use the ▲/▼ buttons to adjust the distortion of the top or bottom side, after defining the adjusting position with the ◀/▶ buttons. Use the ◀/▶ buttons to adjust the distortion of the left or right side, after defining the adjusting position with the ▲/▼ buttons.</p> <p>(3) To adjust another corner or side, follow the same procedure from (1) above. To reset the adjustment of all the corners and sides, select RESET with the ▲/▼/◀/▶ buttons and press the <b>ENTER</b> or  button.</p> <p>(4) This projector is equipped with a memory feature for PERFECT FIT adjustment. Up to 3 sets of adjustments can be stored.</p> <ul style="list-style-type: none"> <li>• <b>LOAD:</b> To recall stored adjustments, select one of the LOAD icons  numbered 1 to 3 (number of the memory) with the ◀ /▲/▼ buttons and press the <b>ENTER</b> or  button. Remember that the current adjusted condition will be lost by loading data. If you want to keep the current adjustment, please save it before performing a LOAD function.</li> <li>- The LOAD functions whose linked memory has no data are skipped.</li> <li>- There may be some noise and the screen may flicker for a moment when loading data. This is not malfunction.</li> <li>• <b>SAVE:</b> To store the current PERFECT FIT adjustment, select one of the SAVE icons  numbered 1 to 3 (number of the memory) with the ◀ /▲/▼ buttons and press the <b>ENTER</b> or  button. Remember that the current data being stored of a memory will be lost by saving new data into the memory.</li> </ul>

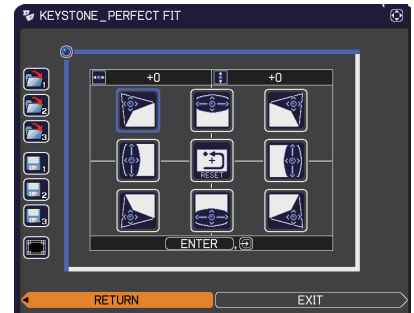

(continued on next page)

Item	Description
<p><b>PERFECT FIT (continued)</b></p>	<ul style="list-style-type: none"> <li>• While the distortion is adjusted with the PERFECT FIT function, keystone adjustment feature is unavailable. To correct the keystone distortion, reset the adjustment of all the corners and sides.</li> <li>• The adjustable range of this correction will vary among inputs. For some input, this function may not work well.</li> <li>• One adjustment position common to the top and bottom sides can be set. Also, another adjustment position common to the left and right sides can be set.</li> <li>• The distortion of the top and bottom sides can be adjusted only in the same direction, pincushion or barrel. The adjustment for the left and right sides is carried out in the same manner.</li> </ul>
<p><b>LAMP &amp; FILTER</b></p>	<p><b>AUTO ECO MODE</b></p> <p>Using the ▲/▼ buttons turns on/off the AUTO ECO MODE. ON ⇔ OFF</p> <ul style="list-style-type: none"> <li>• When ON is selected, the projector will always be set to ECO-2 at start-up regardless of the ECO MODE (📖51) setting. An OSD message “AUTO ECO MODE” will be displayed for tens of seconds when the projector starts with this function activated.</li> </ul>
	<p><b>ECO MODE</b></p> <p>Using the ▲/▼ buttons switches the ECO MODE. OFF ⇔ ECO-1 ⇔ ECO-2 ⇔ INTELLIGENT ECO ⇔ SAVER</p>  <ul style="list-style-type: none"> <li>• When the ECO-1/2 is selected, acoustic noise and screen brightness are reduced.</li> <li>• When INTELLIGENT ECO is selected, the brightness of the lamp changes according to the level of the input signal. The lamp becomes brighter when the input signal level is high and darker when the level is low. If dark images are projected continuously, the brightness of the lamp may increase to maintain its performance.</li> <li>• When SAVER is selected, you can select the time within 1 to 30 min. for SAVER MODE using the ► button. If the image signal level doesn't change more than the period set, the lamp brightness is reduced and electric power consumption decreased. If the image signal level changes or any buttons are operated, the lamp will brighten again. If dark images are projected continuously, the brightness of the lamp may increase to maintain its performance.</li> <li>• When AUTO ECO MODE (📖above) is set to ON, the projector will always be set to ECO-2 at start-up regardless this setting.</li> <li>• When the ambient temperature is around 35 to 40°C, the brightness of lamp is reduced automatically.</li> </ul>

(continued on next page)

Item	Description
<b>LAMP &amp; FILTER</b> (continued)	<p><b>LAMP TIME</b></p> <p>The lamp time is the usage time of the lamp, counted after the last resetting. Pressing the <b>RESET</b> button on the remote control or the ► button of the projector displays a dialog. To reset the lamp time, select the OK using the ► button. CANCEL ⇨ OK</p> <ul style="list-style-type: none"> <li>• Please reset the lamp time only when you have replaced the lamp, for a suitable indication about the lamp.</li> <li>• For the lamp replacement, see the section "Replacing the lamp" (📖100).</li> <li>• The IMAGE OPTIMIZER function does not work properly unless LAMP TIME is initialized when replacing a lamp.</li> </ul>
	<p><b>FILTER TIME</b></p> <p>The filter time is the usage time of the air filter, counted after the last resetting. Pressing the <b>RESET</b> button on the remote control or the ► button of the projector displays a dialog. To reset the filter time, select the OK using the ► button. CANCEL ⇨ OK</p> <ul style="list-style-type: none"> <li>• Please reset the filter time only when you have cleaned or replaced the air filter, for a suitable indication about the air filter.</li> <li>• For the air filter cleaning, see the section "Cleaning and replacing the air filter" (📖102).</li> </ul>
	<p><b>FILTER MESSAGE</b></p> <p>Use the ▲/▼ button to set the timer for notifying by the message when to replace the filter unit 100h ⇨ ••• ⇨ 5000h ⇨ OFF</p> <p>After choosing an item except OFF, the message "REMINDER *** HRS PASSED ...." will appear after the timer reaches the interval time set by this feature (📖108). When the OFF is chosen, the message will not appear. Utilize this feature to keep the air filter clean, setting the suitable time according to your environment of this projector.</p> <ul style="list-style-type: none"> <li>• Please take care of the filter unit periodically, even if there is no message. If the air filter becomes to be blocked by dust or other matter, the internal temperature will rise, which could cause malfunction, or reduce the lifetime of the projector.</li> <li>• Please be careful with the operating environment of the projector and the condition of the filter unit.</li> </ul>
<p><b>IMAGE OPTIMIZER</b></p>	<p>When this function is enabled, automatic image correction is performed to maintain visibility in accordance with lamp deterioration.</p> <ul style="list-style-type: none"> <li>• This function may not work properly when HDCR/ ACCENTUALIZER is set to other than 0.</li> <li>• This function does not work properly unless LAMP TIME is initialized when replacing a lamp.</li> </ul>

(continued on next page)

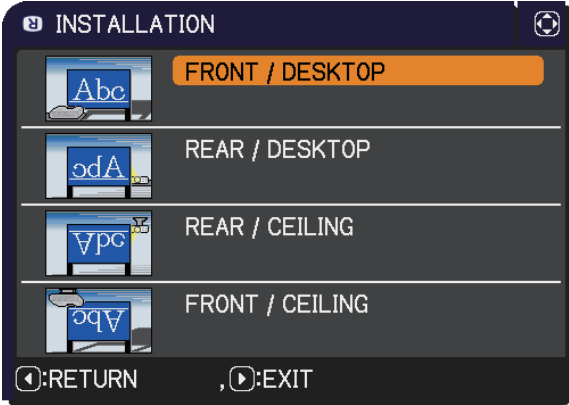
Item	Description
<p><b>INSTALLATION</b></p>	<p>Pressing the ► button displays the dialog for changing the INSTALLATION setting.</p>  <p>Use the ▲/▼ buttons to select the desired setting on the INSTALLATION dialog.</p>
<p><b>STANDBY MODE</b></p>	<p>Using the ▲/▼ buttons switches the standby mode setting between NORMAL and SAVING.</p> <p>NORMAL ⇄ SAVING</p> <p>When SAVING is selected, the power consumption in the standby mode is lowered with some functional restriction as below:</p> <ul style="list-style-type: none"> <li>• When SAVING is selected, the RS-232C communication control except to turn the projector on and the network function are disabled while the projector is in the standby mode. If the COMMUNICATION TYPE in the COMMUNICATION menu is set to NETWORK BRIDGE, all of the RS-232C commands are disabled (📖71).</li> <li>• When SAVING is selected, STANDBY setting of AUDIO SOURCE (📖54) is invalid, no signal is output from <b>AUDIO OUT</b> port and no sound from a built-in speaker.</li> <li>• When SAVING is selected, STANDBY setting of MONITOR OUT is invalid, and no signal is output from <b>MONITOR OUT</b> port in the standby mode.</li> <li>• The USB connection is disabled while the projector is in standby mode if the STANDBY MODE item in the SETUP menu of the projector is set to SAVING.</li> <li>• When SAVING is selected, CLONING load function is invalid while in STANDBY MODE.</li> <li>• When SAVING is selected, SCHEDULE function (Ex. POWER-ON) at STANDBY MODE will not be operated.</li> </ul>

## AUDIO menu

From the AUDIO menu, items shown in the table below can be performed. Select an item using the ▲/▼ cursor buttons, and press the ► cursor button or the **ENTER** button to execute the item. Then perform it according to the following table.

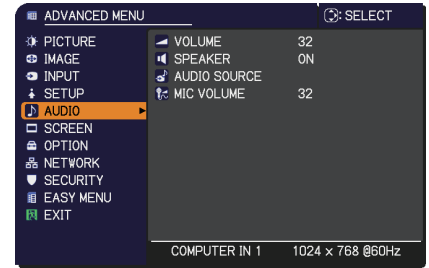

Item	Description
<b>VOLUME</b>	Using the ◀/▶ buttons adjusts the volume. Low ⇔ High
<b>SPEAKER</b>	Using the ▲/▼ buttons turns on/off the built-in speaker. ON ⇔ OFF When OFF is selected, the built-in speaker does not work.
<b>AUDIO SOURCE</b>	<p>While the image signal from the input port chosen in step (1) is projected, the audio signal from the input port selected in step (2) is output to both the <b>AUDIO OUT</b> port and built-in speaker of this projector. However, the built-in speaker does not work when <b>SPEAKER</b> is set to OFF.</p> <p>(1) Choose a picture input port using the ▲/▼ buttons. Choose <b>STANDBY</b> to select the sound output in the standby mode.</p> <p>(2) Select an audio input port or the mute icon using the ◀/▶ buttons. The icons indicate the following;</p> <p>No.1: <b>AUDIO IN1</b> port      No.2: <b>AUDIO IN2</b> port                      No.3: <b>LAN</b> port              No.4: <b>USB TYPE A</b> port                      No.5: <b>USB TYPE B</b> port    No.6: <b>HDMI 1</b> port                      No.7: <b>HDMI 2</b> port          ☒ : mutes the sound</p> <ul style="list-style-type: none"> <li>• Audio input from port No.3 to 7 can only be selected by each of the picture input ports.</li> <li>• Even if the projector is in the standby mode, cooling fans may work and make noises when the built-in speaker is in operation.</li> <li>• C.C. (Closed Caption) is automatically activated when ☒ is selected and an input signal containing C.C. is received. This function is available only when the signal is NTSC for <b>VIDEO</b> or 480i@60 for <b>COMPUTER IN1</b> or <b>COMPUTER IN2</b>, and when <b>AUTO</b> is selected for <b>DISPLAY</b> in the C.C. menu under the <b>SCREEN</b> menu (📖60).</li> </ul>
<b>MIC VOLUME</b>	Using the ◀/▶ buttons adjusts the volume of the microphone connected to the <b>MIC</b> port. Low ⇔ High

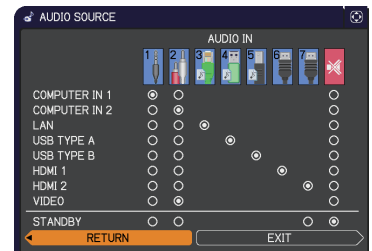

## SCREEN menu

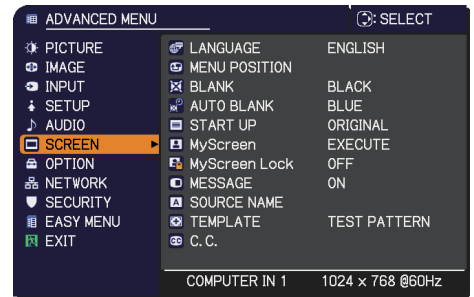

From the SCREEN menu, items shown in the table below can be performed.

Select an item using the ▲/▼ cursor buttons, and press the ► cursor button or **ENTER** button to execute the item. Then perform it according to the following table.

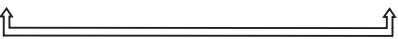
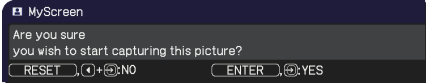

Item	Description
<b>LANGUAGE</b>	<p>Using the ▲/▼/◀/▶ buttons switches the OSD (On Screen Display) language.</p> <p>ENGLISH ↔ FRANÇAIS ↔ DEUTSCH ↔ ESPAÑOL</p> <p>↑ ..... (shown in the LANGUAGE dialog) ..... =↑</p> <p>Press the <b>ENTER</b> or ◀ button to save the language setting.</p>
<b>MENU POSITION</b>	<p>Using the ▲/▼/◀/▶ buttons adjusts the menu position. To quit the operation, press the <b>MENU</b> button on the remote control or keep no operation for about 10 seconds.</p>
<b>BLANK</b>	<p>Using the ▲/▼ buttons switches the mode for the blank screen. The blank screen is a screen for the temporarily blanking feature (📖24). It is displayed by pressing the <b>AV MUTE</b> button on the remote control.</p> <p>MyScreen ↔ ORIGINAL ↔ BLUE ↔ WHITE ↔ BLACK</p> <p>↑ ..... =↑</p> <p><u>MyScreen</u> : Screen can be registered by the MyScreen item (📖56).  <u>ORIGINAL</u> : Screen preset as the standard screen.  <u>BLUE, WHITE, BLACK</u> : Plain screens in each color.</p> <ul style="list-style-type: none"> <li>• To avoid remaining as an afterimage, the MyScreen or ORIGINAL screen will change to the plain black screen after several minutes.</li> </ul>
<b>AUTO BLANK</b>	<p>Using the ▲/▼ buttons switches the mode for the AUTO BLANK screen.</p> <p>BLUE ↔ WHITE ↔ BLACK</p> <p>↑ ..... =↑</p> <ul style="list-style-type: none"> <li>• To avoid remaining as an afterimage, displayed image will change to the designated blank color screen by AUTO BLANK after several minutes at the following conditions. <ul style="list-style-type: none"> <li>- When MyScreen or ORIGINAL is displayed as BLANK screen.</li> <li>- When start-up screen is displayed.</li> </ul> </li> </ul>

(continued on next page)

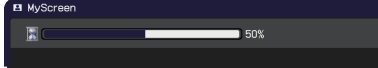
Item	Description
<p><b>START UP</b></p>	<p>Using the ▲/▼ buttons switches the mode for the start-up screen. The start-up screen is a screen displayed when no signal or an unsuitable signal is detected.</p> <p>MyScreen ↔ ORIGINAL ↔ OFF</p>  <p><u>MyScreen</u> : Screen can be registered by the MyScreen item (📖56).  <u>ORIGINAL</u> : Screen preset as the standard screen.  <u>OFF</u> : Plain black screen.</p> <ul style="list-style-type: none"> <li>• To avoid remaining as an afterimage, the MyScreen or ORIGINAL screen will change to the AUTO BLANK screen (📖55) after several minutes.</li> <li>• When the ON is selected to the MyScreen PASSWORD item in the SECURITY menu (📖78), the START UP is fixed to MyScreen.</li> </ul>
<p><b>MyScreen</b></p>	<p>This item allows you to capture an image for use as a MyScreen image which can be used as the BLANK screen and START UP screen. Display the image you want to capture before executing the following procedure.</p> <p>Selecting this item displays a dialog titled “MyScreen”. It will ask you if you start capturing an image from the current screen.</p>  <p>Please wait for the target image to be displayed, and press the <b>ENTER</b> or  button to start registration.</p> <p>To restore the screen and return to the previous dialog, press the <b>RESET</b> button on the remote control.</p> <p>Registration may take several minutes.</p>  <p>When the registration is completed, the registered screen and the following message is displayed for several seconds:  <b>“MyScreen registration is finished.”</b></p> <p>If the registration failed, the following message is displayed:  <b>“A capturing error has occurred. Please try again.”</b></p> <ul style="list-style-type: none"> <li>• This function cannot be selected when the ON is selected to the MyScreen Lock item (📖57).</li> <li>• This function cannot be selected when the ON is selected to the MyScreen PASSWORD item in SECURITY menu (📖78).</li> <li>• This function is unavailable for a signal from the <b>LAN, USB TYPE A, USB TYPE B</b> or <b>HDMI 1/2</b> port.</li> </ul>

(continued on next page)



Item	Description
<b>MyScreen Lock</b>	<p>Using the ▲/▼ buttons turns on/off the MyScreen lock function. ON ⇔ OFF</p> <p>When the ON is selected, the item MyScreen is locked. Use this function for protecting the current MyScreen.</p> <ul style="list-style-type: none"> <li>• This function cannot be selected when the ON is selected to the MyScreen PASSWORD item in SECURITY menu (📖78).</li> </ul>
<b>MESSAGE</b>	<p>Using the ▲/▼ buttons turns on/off the message function. ON ⇔ OFF</p> <p>When the ON is selected, the following message function works.</p> <p>“AUTO IN PROGRESS” while automatically adjusting  “NO INPUT IS DETECTED”  “SYNC IS OUT OF RANGE”  “INVALID SCAN FREQ.”  “NOT AVAILABLE”  “Searching...” while searching for the input  “Detecting...” while an input signal is detected  “AUTO ECO MODE” while starting up with AUTO ECO MODE</p> <p>The indication of the input signal displayed by changing  The indication of the aspect ratio displayed by changing  The indication of the PICTURE MODE displayed by changing  The indication of the ACTIVE IRIS displayed by changing  The indication of the MY MEMORY displayed by changing  The indication of “FREEZE” and “II” while freezing the screen by pressing the <b>FREEZE</b> button.  The indication of the TEMPLATE displayed by changing.  The indication of the ECO MODE displayed by changing.  The indication of "+++ FOCUS +++" displayed by changing  The D-ZOOM dialog displayed by changing</p> <ul style="list-style-type: none"> <li>• When the OFF is selected, please remember if the picture is frozen. Do not mistake freezing for a malfunction (📖31).</li> </ul>

(continued on next page)

Item	Description
<p><b>SOURCE NAME</b></p>	<p>Each input port for this projector can have a name applied to it.</p> <p>(1) Use the ▲/▼ buttons on the SCREEN menu to select SOURCE NAME and press the ► or <b>ENTER</b> button. The SOURCE NAME menu will be displayed.</p> <p>(2) Use the ▲/▼ buttons on the SOURCE NAME menu to select the port to be named and press the ► button. The SOURCE NAME dialog will be displayed. Right side of the menu is blank until a name is specified.</p> <p>(3) Select an icon you would like to assign to the port in the SOURCE NAME dialog. The name assigned to the port will also be automatically switched according to your icon selection. Press the <b>ENTER</b> or ↵ button to determine your icon selection.</p> <p>(4) Select a number you would like to assign to the port along with the icon. You can select the number either from blank (no number assigned), 1, 2, 3, or 4. Then press the <b>ENTER</b> or ↵ button.</p> <p>(5) If you would like to modify the name assigned to the port, select CUSTOM NAME and press the <b>ENTER</b> or ↵ button.</p>

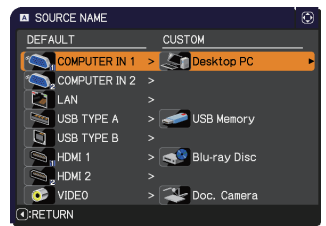
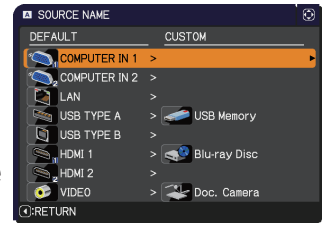

(continued on next page)

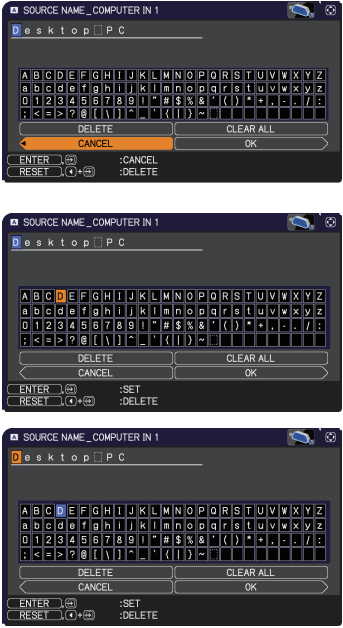
Item	Description
<p><b>SOURCE NAME (Continued)</b></p>	<p>(6) The current name will be displayed on the first line. Use the ▲/▼/◀/▶ buttons and the <b>ENTER</b> or <b>↵</b> button to select and enter characters. To erase 1 character at one time, press the <b>RESET</b> button or press the ◀ and <b>↵</b> button at the same time. Also if you move the cursor to <b>DELETE</b> or <b>ALL CLEAR</b> on screen and press the <b>ENTER</b> or <b>↵</b> button, 1 character or all characters will be erased. The name can be a maximum of 16 characters.</p> <p>(7) To change an already inserted character, press the ▲ button to move the cursor to the first line, and use the ◀/▶ buttons to move the cursor on the character to be changed. After pressing the <b>ENTER</b> or <b>↵</b> button, the character is selected. Then, follow the same procedure as described at the item (6) above.</p> <p>(8) To finish entering text, move the cursor to the <b>OK</b> on screen and press the ▶, <b>ENTER</b> or <b>↵</b> button. To revert to the previous name without saving changes, move the cursor to the <b>CANCEL</b> on screen and press the ◀, <b>ENTER</b> or <b>↵</b> button.</p> 
<p><b>TEMPLATE</b></p>	<p>Using the ▲/▼ cursor buttons switches the mode for the template screen. Press the ▶ cursor (or the <b>ENTER</b>) button to display the selected template, and press the ◀ cursor button to close the displayed screen.</p> <p>TEST PATTERN ⇔ DOT-LINE1 ⇔ DOT-LINE2 ⇔ DOT-LINE3          ⇕          HAS-WM05 <span style="float: right;">DOT-LINE4</span>          ⇕          HAS-WM03 ⇔ MAP2 ⇔ MAP1 ⇔ CIRCLE2 ⇔ CIRCLE1</p> <p>You can turn a map upside down and scroll it horizontally when MAP1 or MAP2 is selected. To invert or scroll the map, display the guidance by pressing the <b>RESET</b> button on the remote three seconds or more when MAP1 or MAP2 appears.</p>

(continued on next page)

Item	Description
<p style="text-align: center;"><b>C.C. (Closed Caption)</b></p>	<p>The C.C. is the function that displays a transcript or dialog of the audio portion of a video, files or other presentation or other relevant sounds. It is required to have NTSC format video or 480i@60 format component video source supporting C.C. feature to utilize this function.</p> <p>It may not work properly, depending on equipment or signal source. In this case, please turn off the Closed Caption.</p>
	<p><b>DISPLAY</b></p> <p>Select Closed Caption DISPLAY setting from following options using the ▲/▼ buttons.</p> <p style="text-align: center;">AUTO ↔ ON ↔ OFF</p> <p style="text-align: center;">↑—————↑</p> <p><u>AUTO</u> : Closed Caption automatically appears when the input signal (C.C. compatible) from the port with the mute icon set at AUDIO SOURCE is selected.</p> <p><u>ON</u> : Closed Caption is on.</p> <p><u>OFF</u> : Closed Caption is off.</p> <ul style="list-style-type: none"> <li>• The caption is not displayed when the OSD menu is active.</li> <li>• The Closed Caption is the function to display the dialogue, narration, and / or sound effects of a television program or other video sources. The Closed Caption availability is depending upon broadcaster and/or content.</li> </ul>
	<p><b>MODE</b></p> <p>Select Closed Caption MODE setting from following options using the ▲/▼ buttons.</p> <p style="text-align: center;">CAPTIONS ↔ TEXT</p> <p><u>CAPTIONS</u> : Display Closed Caption.</p> <p><u>TEXT</u> : Display Text data, which is for additional information such as news reports or a TV program guide. The information covers the entire screen. Not all of the C.C. program has Text information.</p>
	<p><b>CHANNEL</b></p> <p>Select Closed Caption CHANNEL from following options using ▲/▼ buttons.</p> <p style="text-align: center;">1 ↔ 2 ↔ 3 ↔ 4</p> <p style="text-align: center;">↑—————↑</p> <p><u>1</u>: Channel 1, primary channel / language</p> <p><u>2</u>: Channel 2</p> <p><u>3</u>: Channel 3</p> <p><u>4</u>: Channel 4</p> <p>The channel data may vary, depending on the content. Some channel might be used for secondary language or empty.</p>

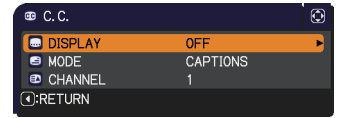

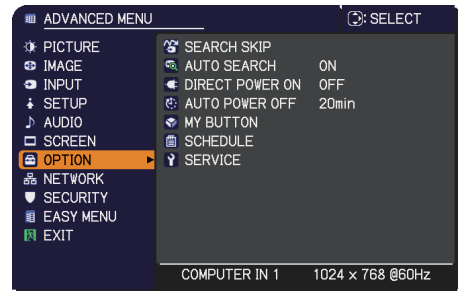

## OPTION menu



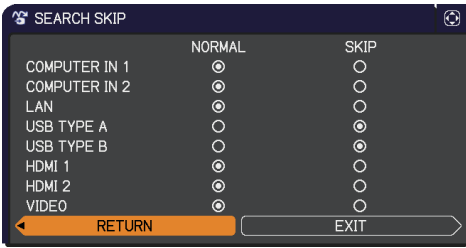

From the OPTION menu, items shown in the table below can be performed.

Select an item using the ▲/▼ cursor buttons, and press the ► cursor button or **ENTER** button to execute the item. Then perform it according to the following table.

Item	Description
<p><b>SEARCH SKIP</b></p>	<p>The ports can be set to be ignored in searching by the AUTO SEARCH function (<a href="#">see below</a>).</p>  <p>(1) Choose a picture input port using the ▲/▼ buttons.                  (2) Using the ◀/▶ buttons turns on/off the SEARCH SKIP function.                  NORMAL ⇔ SKIP</p> <p>The port that is set to SKIP will be ignored.</p> <ul style="list-style-type: none"> <li>It is not possible to set SKIP to all ports at the same time.</li> </ul>
<p><b>AUTO SEARCH</b></p>	<p>Using the ▲/▼ buttons turns on/off the automatic signal search function.</p> <p>ON ⇔ OFF</p> <p>When the ON is selected, detecting no signal automatically cycles through input ports in the following order. The search is started from the current port. Then when an input is found, the projector will stop searching and display the image.</p>  <ul style="list-style-type: none"> <li>It may take several seconds to project the images from the <b>USB TYPE B</b> port.</li> </ul>

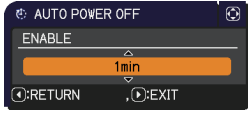
(continued on next page)

Item	Description
<p><b>DIRECT POWER ON</b></p>	<p>Using the ▲/▼ buttons turns on/off the DIRECT POWER ON function.</p> <p>ON ⇔ OFF</p> <p>When set to the ON, the lamp in projector will be automatically turned on without the usual procedure (📖21), only when the projector is supplied with the power after the power was cut while the lamp was on.</p> <ul style="list-style-type: none"> <li>• This function does not work as long as the power has been supplied to the projector while the lamp is off.</li> <li>• After turning the lamp on by the DIRECT POWER ON function, if neither input nor operation is detected for about 30 minutes, the projector is turned off, even though the AUTO POWER OFF function (📖62) is disabled.</li> </ul>
<p><b>AUTO POWER OFF</b></p>	<p>Using the ▲/▼ buttons adjusts the time to count down to automatically turn the projector off.</p> <p>Long (max. 99 minutes) ⇔ Short (min. 0 minute = DISABLE)</p> <div style="display: flex; justify-content: space-around; align-items: center;">   </div> <p>When the time is set to 0, the projector is not turned off automatically. When the time is set to 1 to 99, and when the passed time with no-signal or an unsuitable signal reaches at the set time, the projector lamp will be turned off.</p> <p>If one of the projector's buttons or the remote control buttons is pressed or one of the commands (except get commands) is transmitted to the <b>CONTROL</b> port during the corresponding time, projector will not be turned off.</p> <p>Please refer to the section “Turning off the power” (📖23).</p>

(continued on next page)

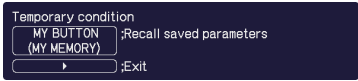
Item	Description
<p><b>MY BUTTON</b></p>	<p>This item is to assign one of the following functions to <b>MY BUTTON 1/2</b> on the remote control (📖6).</p> <p>(1) Use the ▲/▼ buttons on the MY BUTTON menu to select a MY BUTTON - (1/2) and press the ► or <b>ENTER</b> button to display the MY BUTTON setup dialog.</p> <p>(2) Then using the ▲/▼/◀/▶ buttons sets one of the following functions to the chosen button. Press the <b>ENTER</b> or ↵ button to save the setting.</p> <ul style="list-style-type: none"> <li>• COMPUTER IN1: Selects the input from <b>COMPUTER IN1</b> port.</li> <li>• COMPUTER IN2: Selects the input from <b>COMPUTER IN2</b> port.</li> <li>• LAN: Selects input from <b>LAN</b> port.</li> <li>• USB TYPE A: Selects input from <b>USB TYPE A</b> port.</li> <li>• USB TYPE B: Selects input from <b>USB TYPE B</b> port.</li> <li>• HDMI1: Selects input from <b>HDMI 1</b> port.</li> <li>• HDMI2: Selects input from <b>HDMI 2</b> port.</li> <li>• VIDEO: Selects the input from <b>VIDEO IN</b> port.</li> <li>• SLIDESHOW: Selects the input from <b>USB TYPE A</b> port, and starts a Slideshow.</li> <li>• MY IMAGE: Displays the MY IMAGE menu.</li> <li>• MESSENGER: Turns the messenger text displayed on the screen on/off (📖Messenger Function in the <b>User's Manual - Network Guide</b>). When there is no transferred text data to display, the message "NO MESSENGER DATA" appears.</li> <li>• INFORMATION: Displays SYSTEM_INFORMATION, INPUT_INFORMATION (📖75), WIRELESS INFORMATION, WIRED INFORMATION, OTHER INFORMATION or nothing.</li> <li>• MY MEMORY: Loads one of adjustment data stored (📖40). When more than one data are saved, the adjustment changes every time the <b>MY BUTTON</b> is pressed. When no data is saved in memory, the dialog "No saved data" appears. When the current adjustment is not saved to memory, the dialog as shown in the right appears.</li> </ul> <p>If you want to keep the current adjustment, please press the ► button to exit. Otherwise loading a data will overwrite the current adjusted condition.</p> <div style="display: flex; justify-content: space-around; align-items: flex-start;"> <div style="text-align: center;">  <p>↔ No saved data</p> </div> <div style="text-align: center;">  <p>Temporary condition              MY BUTTON (MY MEMORY) ;Recall saved parameters              ;Exit</p> </div> </div>

(continued on next page)

Item	Description								
<p><b>MY BUTTON (Continued)</b></p>	<ul style="list-style-type: none"> <li>• ACTIVE IRIS: Changes the active iris mode.</li> <li>• PICTURE MODE: Changes the PICTURE MODE (📖35).</li> <li>• FILTER RESET: Displays the filter time reset confirmation dialogue (📖52).</li> <li>• RESOLUTION: Turns on/off the RESOLUTION dialog (📖47).</li> <li>• MIC VOLUME: Turns on/off the MIC VOLUME dialog (📖54).</li> <li>• ECO MODE: Changes the ECO MODE (📖51).</li> <li>• SAVER MODE: Turns on/off the SAVER MODE (📖51).</li> </ul>								
<p><b>SCHEDULE</b></p>	<p>■ <b>How to setup the item</b></p> <ol style="list-style-type: none"> <li>1. Use the ▲/▼/◀/▶ cursor buttons to select or adjust.</li> <li>2 Select OK to finish the settings.</li> </ol> <div style="border: 1px solid black; padding: 5px; margin: 10px 0;"> <p><b>NOTE</b> • Please refer to the actual on-screen display(OSD) for appropriate operation.</p> </div> <table border="1" style="width: 100%; border-collapse: collapse;"> <thead> <tr> <th data-bbox="440 846 751 902">Item</th> <th data-bbox="751 846 1458 902">Description</th> </tr> </thead> <tbody> <tr> <td data-bbox="440 902 751 1032"> <p><b>DATE AND TIME</b></p> </td> <td data-bbox="751 902 1458 1032"> <p>Inputs the current date (year/month/day) and the time (24-hour clock) to set a reference time in the projector.</p> </td> </tr> <tr> <td data-bbox="440 1032 751 1200"> <p><b>SPECIFIC DATE</b></p> </td> <td data-bbox="751 1032 1458 1200"> <p>Specifies the date (month/day) if you execute only one specific day. You can set 10 different schedules from SPECIFIC DATE-1 to SPECIFIC DATE-10.</p> </td> </tr> <tr> <td data-bbox="440 1200 751 1368"> <p><b>PROGRAM EDIT</b></p> </td> <td data-bbox="751 1200 1458 1368"> <p>Sets what event to execute at what time of the day. One program can be set in one day, and up to 16 programs can be set. Up to 20 events can be set in one program.</p> </td> </tr> </tbody> </table> <p>■ <b>Setting procedure</b></p> <ol style="list-style-type: none"> <li>① Determine the current date/time as reference in DATE AND TIME.</li> <li>② Make a schedule of what event to execute at what time of the day in PROGRAM EDIT.</li> <li>③ Select the date (one specific day: SPECIFIC DATE or the days of the week: every week) to be scheduled, then select a program.</li> </ol> <p>Switch the screen of the days of the week and SPECIFIC DATE by vertical scroll. (Page 1 of 2: Days of the week, Page 2 of 2: SPECIFIC DATE)</p>	Item	Description	<p><b>DATE AND TIME</b></p>	<p>Inputs the current date (year/month/day) and the time (24-hour clock) to set a reference time in the projector.</p>	<p><b>SPECIFIC DATE</b></p>	<p>Specifies the date (month/day) if you execute only one specific day. You can set 10 different schedules from SPECIFIC DATE-1 to SPECIFIC DATE-10.</p>	<p><b>PROGRAM EDIT</b></p>	<p>Sets what event to execute at what time of the day. One program can be set in one day, and up to 16 programs can be set. Up to 20 events can be set in one program.</p>
Item	Description								
<p><b>DATE AND TIME</b></p>	<p>Inputs the current date (year/month/day) and the time (24-hour clock) to set a reference time in the projector.</p>								
<p><b>SPECIFIC DATE</b></p>	<p>Specifies the date (month/day) if you execute only one specific day. You can set 10 different schedules from SPECIFIC DATE-1 to SPECIFIC DATE-10.</p>								
<p><b>PROGRAM EDIT</b></p>	<p>Sets what event to execute at what time of the day. One program can be set in one day, and up to 16 programs can be set. Up to 20 events can be set in one program.</p>								

(continued on next page)

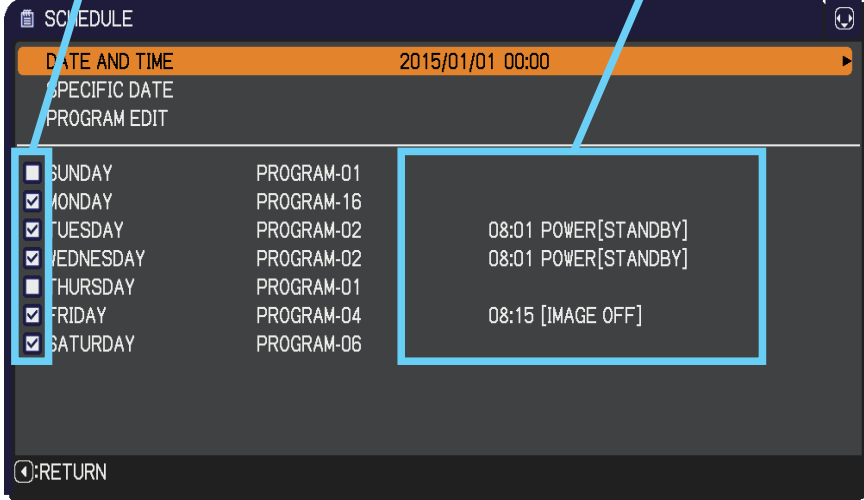
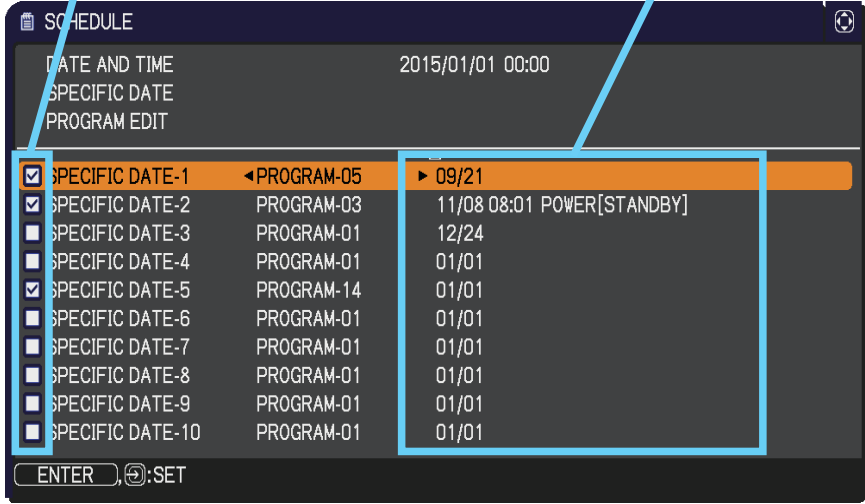

Item	Description
<p><b>SCHEDULE (Continued)</b></p>	<p>■ <b>How to activate(DATE AND TIME / SPECIFIC DATE)</b> Place a check mark in the box.</p> <p>Check mark in the box</p> <p>Date and first setup info could be seen with the check mark.</p> 
	<p>1/2 page (Set the DATE(Year/Month/Date) and Time(24-hour scale).)</p> <p>Check mark in the box</p> <p>Date and first setup info could be seen with the check mark.</p>  <p>2/2 page (Set specific date from 1 to 10.)</p>

(continued on next page)

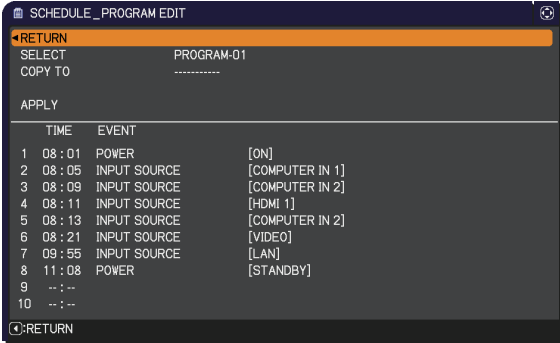
Item	Description
<p><b>SCHEDULE (Continued)</b></p>	<p>Press the ▼ cursor button to move from 1/2 page to 2/2 page with the state of selecting "SATURDAY".</p> <p>■ <b>PROGRAM EDIT</b> The TIME and EVENT for Program 1 to 16 can be edited.</p> <ul style="list-style-type: none"> <li>• <b>RETURN</b> Select this to go back to the top menu of the SCHEDULE.</li> <li>• <b>SELECT</b> Select from PROGRAM-01 to 16 to edit. Up to 20 events can be set in each program.</li> <li>• <b>COPY TO</b> The selected program (with the settings of TIME and EVENT) can be copied to other program.</li> <li>• <b>APPLY</b> Select this to apply and save all adjustments and settings.</li> </ul> 

(continued on next page)

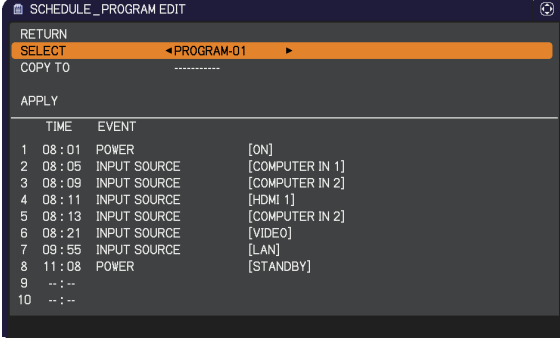
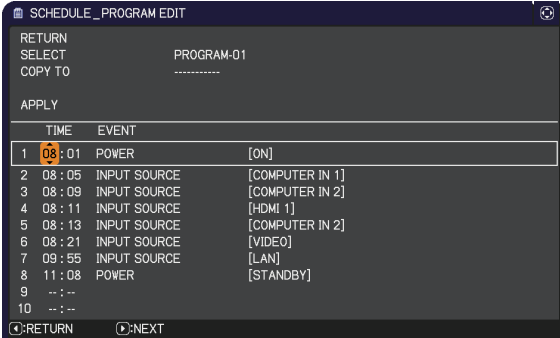
Item	Description
<p><b>SCHEDULE (Continued)</b></p>	<p>■ <b>How to edit the selected PROGRAM</b></p> <ol style="list-style-type: none"> <li>1. Select from 1 to 20 events. Use the ▲/▼ cursor buttons to select. Press the ► cursor button to set the TIME and EVENT.</li> <li>2. Use the ◀/▶ cursor buttons to select.</li> <li>3. Use the ◀/▶ cursor buttons to adjust.</li> </ol>  <p>EVENT can be selected as listed below.</p> <ul style="list-style-type: none"> <li>◦ POWER – ON, STANDBY</li> <li>◦ INPUT SOURCE – "input source"channel</li> <li>◦ MY IMAGE – IMAGE-1 to 4, IMAGE OFF</li> <li>◦ MESSENGER – TEXT-1 to 12, TEXT OFF</li> <li>◦ ECO MODE – OFF, ECO-1, ECO-2, INTELLIGENT ECO, SAVER</li> <li>◦ BLANK – ON, OFF</li> <li>◦ SLIDESHOW - START, STOP</li> </ul>  <ol style="list-style-type: none"> <li>4. Press the ► cursor button to finish the settings.</li> <li>5. Select APPLY to save the settings.</li> </ol> <div style="border: 1px solid black; padding: 10px; margin-top: 10px;"> <p><b>NOTE</b></p> <ul style="list-style-type: none"> <li>• Please refer to the actual on-screen display(OSD) for appropriate operation.</li> <li>• When the STANDBY MODE is set to SAVING, SCHEDULE function (Ex:POWER-ON) at STANDBY MODE will not be operated.</li> </ul> </div>

(continued on next page)

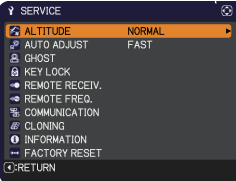
Item	Description
<b>SERVICE</b>	<p>Selecting this item displays the SERVICE menu.</p> <p>Select an item using the ▲/▼ buttons, and press the ► button or the <b>ENTER</b> button on the remote control to execute the item.</p> 
	<p><b>ALTITUDE</b></p> <p>Using the ▲/▼ buttons switches the rotation speed of the cooling fans. If the projector is used at an altitude of about 1600 m or higher, select HIGH. Otherwise, select NORMAL. Note that the projector is noisier when the HIGH is selected.</p> <p style="text-align: center;">HIGH ⇔ NORMAL</p>
	<p><b>AUTO ADJUST</b></p> <p>Using the ▲/▼ buttons to select one of the mode. When the DISABLE is selected, the automatic adjustment feature is disabled.</p> <p style="text-align: center;">FINE ⇔ FAST ⇔ DISABLE</p> <p style="text-align: center;">↑—————↑</p> <p><u>FINE</u>: Finer tuning including H.SIZE adjustment.  <u>FAST</u>: Faster tuning, setting H.SIZE to prearranged data for the input signal.</p> <ul style="list-style-type: none"> <li>Depending on conditions, such as input image, signal cable to the projector, environment around the projector, etc., the automatic adjustment may not work correctly. In such a case, please choose DISABLE to disable the automatic adjustment, and make adjustment manually.</li> </ul>
	<p><b>GHOST</b></p> <p>Adjust the settings using the ▲/▼ buttons to eliminate ghosting.</p>



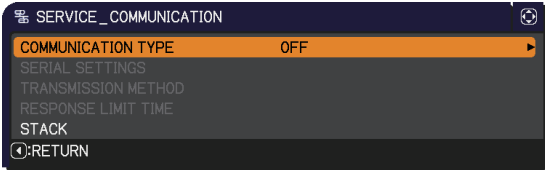

(continued on next page)

Item	Description								
<p><b>SERVICE (continued)</b></p>	<p><b>KEY LOCK</b>                      (1) Use the ▲/▼ buttons to select CONTROL PANEL or REMOTE CONTROL.                      (2) Use the ◀/▶ buttons to turn the key lock function on/off.                      When ON is selected, all buttons on the projector or remote control except the <b>STANDBY/ON</b> button are locked.</p> <ul style="list-style-type: none"> <li>• Please use this function to prevent tampering or accidental operation.</li> <li>• It is not possible to set both CONTROL PANEL and REMOTE CONTROL to ON.</li> </ul>								
	<p><b>REMOTE RECEIV.</b>                      (1) Select a remote sensor using the ▲/▼ button.                      FRONT ↔ TOP                      (2) Switch it using the ◀/▶ button.                      ON ↔ OFF</p> <div data-bbox="1109 739 1465 833" style="border: 1px solid black; padding: 5px; width: fit-content;"> <p>• SERVICE_REMOTE RECEIV. <span style="float: right;">⊗</span></p> <table style="width: 100%; border-collapse: collapse;"> <tr> <td style="width: 33%; text-align: center;">FRONT</td> <td style="width: 33%; text-align: center;">ON</td> <td style="width: 33%; text-align: center;">OFF</td> </tr> <tr> <td style="text-align: center;">TOP</td> <td style="text-align: center;">○</td> <td style="text-align: center;">○</td> </tr> <tr> <td style="text-align: center;">◀</td> <td style="text-align: center;">RETURN</td> <td style="text-align: center;">EXIT ▶</td> </tr> </table> </div> <ul style="list-style-type: none"> <li>• When one sensor is turned off, the other cannot be turned off too.</li> </ul>	FRONT	ON	OFF	TOP	○	○	◀	RETURN
FRONT	ON	OFF							
TOP	○	○							
◀	RETURN	EXIT ▶							

(continued on next page)

Item	Description
<p><b>SERVICE (continued)</b></p>	<p><b>REMOTE FREQ.</b></p> <p>(1) Use the ▲/▼ button to change the projector's remote sensor frequency setting (📖19). 1:NORMAL ⇔ 2:HIGH</p> <p>(2) Use the ◀/▶ button to change the projector's remote sensor on or off. ON ⇔ OFF</p> <p>If the remote control does not function correctly, disable either of them. It's not possible to disable both options at the same time.</p>
	<p><b>COMMUNICATION</b></p> <p>Selecting this item displays COMMUNICATION menu. In this menu, you can configure the serial communication settings of the projector using the <b>CONTROL</b> port.</p>   <ul style="list-style-type: none"> <li>• Select an item using the cursor buttons ▲/▼. Then pressing the ▶ button opens the submenu for the setting item you selected. Or, pressing the ◀ button instead of the ▶ button makes the menu back to the previous one without changing the setup. Each submenu can be operated as described above.</li> <li>• When COMMUNICATION TYPE (📖71) is set to OFF, the other items in COMMUNICATION menu are invalid.</li> <li>• For the function of serial communication, refer to the <b>User's Manual - Network Guide</b>.</li> </ul>

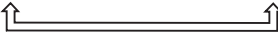
(continued on next page)





Item	Description
<p><b>SERVICE (continued)</b></p>	<p style="text-align: center; vertical-align: middle;"><b>COMMUNICATION (continued)</b></p> <p><b>COMMUNICATION TYPE</b>            Select the communication type for transmission via the <b>CONTROL</b> port.  <u>NETWORK BRIDGE</u>: Select this type, if it is required to control an external device as a network terminal, via this projector from the computer.            The <b>CONTROL</b> port doesn't accept RS-232C commands ( <b>Network Bridge Function</b> in the <b>User's Manual - Network Guide</b>)  <u>OFF</u>: Select this mode to receive RS-232C commands using the <b>CONTROL</b> port.            • OFF is selected as the default setting.            • When you select the NETWORK BRIDGE, check the item, TRANSMISSION METHOD ( <i>below</i>).</p> <p><b>SERIAL SETTINGS</b>            Select the serial communication condition for the <b>CONTROL</b> port.</p> <p><b>BAUD RATE</b>            4800bps ⇔ 9600bps ⇔ 19200bps ⇔ 38400bps  </p> <p><b>PARITY</b>            NONE ⇔ ODD ⇔ EVEN  </p> <p>• The BAUD RATE is fixed to 19200bps and PARITY is fixed NONE when the COMMUNICATION TYPE is set to OFF ( <i>above</i>).</p> <p><b>TRANSMISSION METHOD</b>            Select the transmission method for communication by the NETWORK BRIDGE from the <b>CONTROL</b> port.            HALF-DUPLEX ⇔ FULL-DUPLEX  <u>HALF-DUPLEX</u>: This method lets the projector make two way communication, but only one direction, either transmitting or receiving data, is allowed at a time.  <u>FULL-DUPLEX</u>: This method lets the projector make two way communication, transmitting and receiving data at the same time.            • HALF-DUPLEX is selected as the default setting.            • If you select HALF-DUPLEX, check the setting of the item RESPONSE LIMIT TIME ( <b>72</b>).</p>

(continued on next page)

Item	Description	
<p style="text-align: center;"><b>SERVICE (continued)</b></p>	<p><b>COMMUNICATION (continued)</b></p>	<p><b>RESPONSE LIMIT TIME</b>                      Select the time period to wait for receiving response data from other device communicating by the NETWORK BRIDGE and the HALF-DUPLEX through the <b>CONTROL</b> port.</p> <p style="text-align: center;">OFF ⇔ 1s ⇔ 2s ⇔ 3s  </p> <p><u>OFF</u>: Select this mode if it is not required to check the responses from the device that the projector sends data to. In this mode, the projector can send out data from the computer continuously.</p> <p><u>1s /2s /3s</u>: Select the time period to keep the projector waiting for response from the device that the projector sends data to. While waiting the response, the projector does not send out any data from the <b>CONTROL</b> port.</p> <ul style="list-style-type: none"> <li>• This menu is available only when the NETWORK BRIDGE is selected for the COMMUNICATION TYPE and the HALF-DUPLEX is selected for the TRANSMISSION METHOD (71).</li> <li>• OFF is selected as the default setting.</li> </ul>
	<p><b>CLONING</b></p>	<p>The settings of the projector can be copied via USB memory.</p> <p><b>SAVE</b>: Saves each settings of the projector to USB memory.</p> <p><b>LOAD</b>: Loads each settings of the projector from USB memory. Message will be displayed after loading, and power will turn off after five min. or by pressing the ► button. (A message is displayed for a few seconds if loading fails.)</p> <p>After saving / loading, you can remove the USB storage device.</p>

(continued on next page)





Item	Description
<p style="text-align: center;"><b>SERVICE (continued)</b></p>	<p>The following items are exempted.            SETUP: LAMP TIME, FILTER TIME            OPTION: SCHEDULE_DATE AND TIME,            SERVICE(GHOST)            NETWORK: WIRELESS SETUP                      (SIMPLE ACCESS POINT),                      WIRELESS SETUP                      (INFRASTRUCTURE)                      AND WIRED SETUP                      (IP ADDRESS, SUBNET MASK,                      DEFAULT GATEWAY), MY IMAGE,                      PRESENTATION, AMX D.D.</p> <p>SECURITY: MY TEXT DISPLAY</p> <ul style="list-style-type: none"> <li>• Operation is not available if SECURITY_ CLONING LOCK is turned ON.</li> <li>• The Screen_MyScreen can only be loaded.</li> </ul> <p><u>CLONING load function on STANDBY MODE</u></p> <ul style="list-style-type: none"> <li>• While the projector is in STANDBY MODE, push the  button of control panel together with the  button, and then press the  button to start operating the CLONING load function.</li> <li>• During loading process, the three indicators of control panel (POWER (orange), TEMP, LAMP) will remain on.</li> <li>• After the loading process, the three indicators (POWER (orange), TEMP, LAMP) will turn off. Then, you can remove the USB storage device.</li> <li>• If the loading fails, the three indicators (POWER (orange), TEMP, LAMP) will blink at the same time.</li> <li>• CLONING is invalid with the following conditions.               <ul style="list-style-type: none"> <li>- CLONING LOCK is turned ON.                    With this condition, the three indicators (POWER (orange), TEMP, LAMP) will blink at approximately three seconds intervals.</li> <li>- If the STANDBY MODE is set to SAVING.</li> <li>- If there is no USB memory inserted into <b>USB TYPE A</b> port.</li> <li>- If PIN LOCK is not being released.</li> <li>- If a system error occurs.</li> </ul> </li> <li>• Please operate one of the following after loading.               <ul style="list-style-type: none"> <li>- Press the  button and  button of the control panel at the same time.</li> <li>- Wait at least five min. after loading.</li> <li>- Restart the projector after re-plugging the AC cable.</li> </ul> </li> </ul>

(continued on next page)

Item	Description	
<p><b>SERVICE (continued)</b></p>	<p><b>CLONING (continued)</b></p>	<p><u>Load MyScreen data</u></p> <ul style="list-style-type: none"> <li>• Please save the image data as "pj_logo.bmp" or "pj_logo.gif" into USB memory.</li> <li>• Please note that the only compatible formats are as follows.</li> </ul> <p>-File format</p> <p style="padding-left: 20px;"><u>Windows BMP</u> bit/pixel: 4/8/16/24/32bit</p> <p style="padding-left: 20px;"><u>Compression format</u> :</p> <p style="padding-left: 40px;">Without compression/RLE/GIF</p> <p>-Image size: more than 36x36, less than 1280x800</p> <ul style="list-style-type: none"> <li>• If two kinds of file format are saved, "pj_logo.bmp" will be registered into MyScreen data.</li> <li>• If MyScreen LOCK or MyScreen PASSWORD is turned ON, the data of MyScreen cannot be loaded.</li> </ul> <p><u>Setting the data</u></p> <ul style="list-style-type: none"> <li>• Operating the SAVE function under CLONING will name the file as "pj_data.bin" into the USB memory. Please do not attempt to change the file name or the folder structure.</li> <li>• If a file with the same name already exists, it will be overwritten by operating the SAVE function.</li> </ul> <p><u>Loading function</u></p> <ul style="list-style-type: none"> <li>• Please note that saved data from other model cannot be loaded.</li> <li>• Please note that, if any of the following functions: MyScreen PASSWORD, PIN LOCK, MY TEXT PASSWORD under SECURITY menu or MyScreen Lock under SCREEN menu is ON, the respective saved data cannot be loaded.</li> </ul>

(continued on next page)

Item	Description
<p><b>SERVICE (continued)</b></p>	<p><b>CLONING (continued)</b></p> <p><u>Loading function (continued)</u></p> <ul style="list-style-type: none"> <li>• Please note that the saved data of START UP and MyScreen Lock under SCREEN menu cannot be loaded if MyScreen PASSWORD under SECURITY menu is ON.</li> <li>• Please note that the saved data of MY TEXT WRITING cannot be loaded if MY TEXT PASSWORD under SECURITY menu is ON.</li> </ul>
	<p><b>INFORMATION</b></p> <p>Selecting this item displays a dialog titled “INPUT_INFORMATION”. It shows the information about the current input.</p> <div style="display: flex; justify-content: space-around; align-items: center;">    </div> <ul style="list-style-type: none"> <li>• The “FRAME LOCK” message on the dialog means the frame lock function is working.</li> <li>• This item can't be selected for no signal and sync out.</li> <li>• When the MY TEXT DISPLAY is set to ON, the MY TEXT is displayed together with the input information in the INPUT_INFORMATION box (📖81).</li> </ul>
	<p><b>FACTORY RESET</b></p> <p>Selecting OK using the ► button performs this function. By this function, all the items in all of menus will collectively return to the initial setting. Note that the items STANDBY MODE, AUTO BLANK, LAMP TIME, FILTER TIME, LANGUAGE, FILTER MESSAGE, NETWORK and SECURITY settings are not reset.</p> <p>CANCEL ⇨ OK</p> <p>Be sure to set ALTITUDE after resetting all the settings (📖68).</p>

## NETWORK menu

See the **Network Guide** for details of NETWORK operation.

Remember that incorrect network settings on this projector may cause trouble on the network. Be sure to consult with your network administrator before connecting to an existing access point on your network.

# SECURITY menu

This projector is equipped with security functions.

From the SECURITY menu, items shown in the table below can be performed.

To use SECURITY menu: User registration is required before using the security functions.

## Enter to the SECURITY menu

1. Press the ► button. The ENTER PASSWORD box will be displayed.
2. Use the ▲/▼/◀/▶ buttons to enter the registered password. The factory default password is as follows.

MC-AW3506/MC-AW3006 : 91505  
MC-AX3506/MC-AX3006 : 0706



This password can be changed ( below). Move the cursor to the right side of the ENTER PASSWORD box and press the ► button to display the SECURITY menu.

- It is strongly recommended the factory default password to be changed as soon as possible.
  - If an incorrect password is input, the ENTER PASSWORD box will be displayed again. If incorrect password is input 3 times, the projector will turn off. Afterwards the projector will turn off every time an incorrect password is input.
3. Items shown in the table below can be performed.



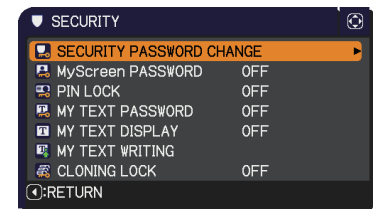
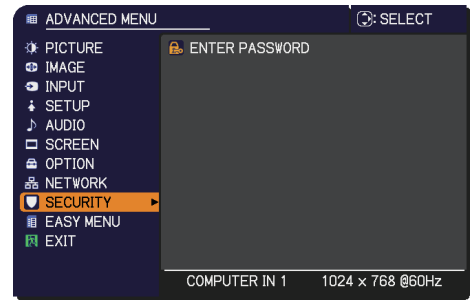

## If you have forgotten your password

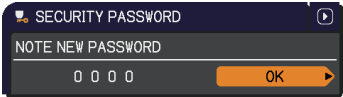
- (1). While the ENTER PASSWORD box is displayed, press and hold the **RESET** button on the remote control for about 3 seconds or press and hold the  button for 3 seconds while pressing the ► button on the projector.
  - (2). The 10 digit Inquiring Code will be displayed. Contact your dealer with the 10 digit Inquiring Code. Your password will be sent after your user registration information is confirmed.
- If there is no key input for about 55 seconds while the Inquiring Code is displayed, the menu will close. If necessary, repeat the process from (1).

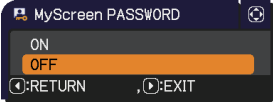

Item	Description
<p><b>SECURITY PASSWORD CHANGE</b></p>	<ol style="list-style-type: none"> <li>(1) Use the ▲/▼ buttons on the SECURITY menu to select SECURITY PASSWORD CHANGE and press the ► button to display the ENTER NEW PASSWORD box. </li> <li>(2) Use the ▲/▼/◀/▶ buttons to enter the new password.</li> <li>(3) Move the cursor to the right side of the ENTER NEW PASSWORD box and press the ► button to display the NEW PASSWORD AGAIN box, enter the same password again. </li> <li>(4) Move the cursor to the right side of the NEW PASSWORD AGAIN box and press the ► button and the NOTE NEW PASSWORD box will be displayed for about 30 seconds, please make note of the password during this time. Pressing the <b>ENTER</b> button on the remote control or ► button on the projector will close the NOTE NEW PASSWORD box. </li> </ol> <ul style="list-style-type: none"> <li>• Please do not forget your password.</li> </ul>

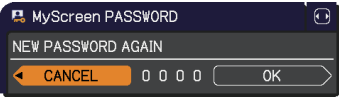
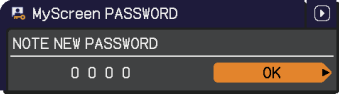

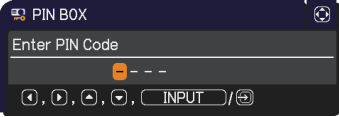
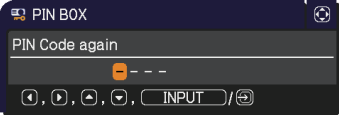
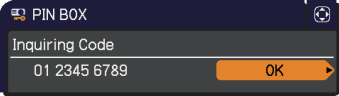

(continued on next page)

Item	Description
<p><b>MyScreen PASSWORD</b></p>	<p>The MyScreen PASSWORD function can be used to prohibit access to the MyScreen function and prevent the currently registered MyScreen image from being overwritten.</p> <p><b>1 Turning on the MyScreen PASSWORD</b></p> <p>1-1 Use the ▲/▼ buttons on the SECURITY menu to select MyScreen PASSWORD and press the ► button to display the MyScreen PASSWORD on/off menu.</p>  <p>1-2 Use the ▲/▼ buttons on the MyScreen PASSWORD on/off menu to select ON. The ENTER NEW PASSWORD box (small) will be displayed.</p>  <p>1-3 Use the ▲/▼/◀/▶ buttons to enter the password. Move the cursor to the right side of the ENTER NEW PASSWORD box (small) and press the ► button to display the NEW PASSWORD AGAIN box, enter the same PASSWORD again.</p>  <p>1-4 Move the cursor to the right side of the NEW PASSWORD AGAIN box and press the ► button to display the NOTE NEW PASSWORD box for about 30 seconds, please make note of the password during this time.</p>  <p>Pressing the <b>ENTER</b> button on the remote control or the ► button on the projector will return to MyScreen PASSWORD on/off menu.</p> <p>When a password is set for MyScreen:</p> <ul style="list-style-type: none"> <li>• The MyScreen registration function (and menu) will be unavailable.</li> <li>• The MyScreen Lock menu will be unavailable.</li> <li>• The START UP setting will be locked on MyScreen (and the menu will be unavailable).</li> </ul> <p>Turning the MyScreen PASSWORD off will allow normal operation of these functions.</p> <ul style="list-style-type: none"> <li>• Please do not forget your MyScreen PASSWORD.</li> </ul> <p><b>2 Turning off the MyScreen PASSWORD</b></p> <p>2-1 Follow the procedure in 1-1 to display the MyScreen PASSWORD on/off menu.</p> <p>2-2 Select OFF to display the ENTER PASSWORD box (large). Enter the registered password and the screen will return to the MyScreen PASSWORD on/off menu.</p>  <p>If an incorrect PASSWORD is input, the menu will close. If necessary, repeat the process from 2-1.</p> <p><b>3 If you have forgotten your password</b></p> <p>3-1 Follow the procedure in 1-1 to display the MyScreen PASSWORD on/off menu.</p> <p>3-2 Select OFF to display the ENTER PASSWORD box (large). The 10 digit Inquiring Code will be displayed inside the box.</p> <p>3-3 Contact your dealer with the 10 digit Inquiring Code. Your password will be sent after your user registration information is confirmed.</p>

(continued on next page)

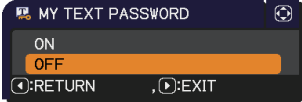
Item	Description
<p><b>PIN LOCK</b></p>	<p>PIN LOCK is a function which prevents the projector from being used unless a registered Code is input.</p> <p><b>1 Turning on the PIN LOCK</b></p> <p>1-1 Use the ▲/▼ buttons on the SECURITY menu to select PIN LOCK and press the ► button or the <b>ENTER</b> button to display the PIN LOCK on/off menu.</p>  <p>1-2 Use the ▲/▼ buttons on the PIN LOCK on/off menu to select ON and the Enter PIN Code box will be displayed.</p>  <p>1-3 Input a 4 part PIN code using the ▲/▼/◀/▶, <b>INPUT</b> or ↻ button.</p> <p>The PIN Code again box will appear.</p>  <p>Reenter the same PIN code. This will complete the PIN code registration.</p> <ul style="list-style-type: none"> <li>• If there is no key input for about 55 seconds while the Enter PIN Code box or the PIN Code again box is displayed, the menu will close. If necessary, repeat the process from 1-1.</li> </ul> <p>Afterwards, anytime the projector is restarted after AC power is turned off the Enter PIN Code box will be displayed. Enter the registered PIN code. The projector can be used after entering the registered PIN code. If an incorrect PIN code is input, the Enter PIN code box will be displayed again. If an incorrect PIN code is input 3 times, the projector will turn off. Afterwards the projector will turn off every time an incorrect PIN code is input. The projector will also turn off if there is no key input for about 5 minutes while the Enter PIN code box is displayed.</p> <p>This function will activate only when the projector is started after AC power is turned off.</p> <ul style="list-style-type: none"> <li>• Please do not forget your PIN code.</li> </ul> <p><b>2 Turning off the PIN LOCK</b></p> <p>2-1 Follow the procedure in 1-1 to display the PIN LOCK on/off menu.</p> <p>2-2 Use the ▲/▼ buttons to select OFF and the Enter PIN Code box will be displayed.</p> <p>Enter the registered PIN code to turn the PIN LOCK function off.</p> <p>If an incorrect PIN code is input 3 times, the projector will turn off.</p> <p><b>3 If you have forgotten your PIN code</b></p> <p>3-1 While the Enter PIN code box is displayed, press and hold the <b>RESET</b> button for 3 seconds or press and hold the ↻ button for 3 seconds while pressing the ► button on the projector.</p> <p>The 10 digit Inquiring Code will be displayed.</p>  <ul style="list-style-type: none"> <li>• If there is no key input for about 5 minutes while the Inquiring Code is displayed, the projector will turn off.</li> </ul> <p>3-2 Contact your dealer with the 10 digit Inquiring Code. Your PIN code will be sent after your user registration information is confirmed.</p>

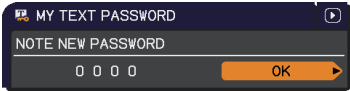
(continued on next page)

Item	Description
<p><b>MY TEXT PASSWORD</b></p>	<p>The MY TEXT PASSWORD function can prevent the MY TEXT from being overwritten. When the password is set for the MY TEXT;</p> <ul style="list-style-type: none"> <li>• The MY TEXT DISPLAY menu will be unavailable, which can prohibit changing the DISPLAY setting.</li> <li>• The MY TEXT WRITING menu will be unavailable, which can prevent the MY TEXT from being overwritten.</li> </ul> <p><b>1 Turning on the MY TEXT PASSWORD</b></p> <p>1-1 Use the ▲/▼ buttons on the SECURITY menu to select the MY TEXT PASSWORD and press the ► button to display the MY TEXT PASSWORD on/off menu.</p>  <p>1-2 Use the ▲/▼ buttons on the MY TEXT PASSWORD on/off menu to select ON. The ENTER NEW PASSWORD box (small) will be displayed.</p>  <p>ENTER NEW PASSWORD box (small)</p> <p>1-3 Use the ▲/▼/◀/▶ buttons to enter the password. Move the cursor to the right side of the ENTER NEW PASSWORD box (small) and press the ► button to display the NEW PASSWORD AGAIN box, and then enter the same password again.</p>  <p>1-4 Move the cursor to the right side of the NEW PASSWORD AGAIN box and press the ► button to display the NOTE NEW PASSWORD box for about 30 seconds, then please make note of the password during this time.</p>  <p>Pressing the <b>ENTER</b> button on the remote control or the ► button on the projector will return to the MY TEXT PASSWORD on/off menu.</p> <p><b>2 Turning off the MY TEXT PASSWORD</b></p> <p>2-1 Follow the procedure in 1-1 to display the MY TEXT PASSWORD on/off menu.</p> <p>2-2 Select OFF to display the ENTER PASSWORD box (large). Enter the registered password and the screen will return to the MY TEXT PASSWORD on/off menu.</p>  <p>ENTER PASSWORD box (large)</p> <p>If an incorrect password is input, the menu will close. If necessary, repeat the process from 2-1</p> <p><b>3 If you have forgotten your password</b></p> <p>3-1 Follow the procedure in 1-1 to display the MY TEXT PASSWORD on/off menu.</p> <p>3-2 Select OFF to display the ENTER PASSWORD box (large). The 10 digit inquiring code will be displayed inside the box.</p> <p>3-3 Contact your dealer with the 10 digit inquiring code. Your password will be sent after your user registration information is confirmed.</p>

(continued on next page)



Item	Description
<p><b>MY TEXT DISPLAY</b></p>	<p>(1) Use the ▲/▼ buttons on the SECURITY menu to select the MY TEXT DISPLAY and press the ► or <b>ENTER</b> button to display the MY TEXT DISPLAY on/off menu.</p> <p>(2) Use the ▲/▼ buttons on the MY TEXT DISPLAY on/off menu to select on or off.</p> <p>ON ⇔ OFF</p> <p>When it is set ON, the MY TEXT will be displayed on the START UP screen and the INPUT_INFORMATION when the INFORMATION on the SERVICE menu is chosen.</p> <ul style="list-style-type: none"> <li>• This function is available only when the MY TEXT PASSWORD function is set to the OFF.</li> </ul>
<p><b>MY TEXT WRITING</b></p>	<p>(1) Use the ▲/▼ buttons on the SECURITY menu to select the MY TEXT WRITING and press the ► button. The MY TEXT WRITING dialog will be displayed.</p> <p>(2) The current MY TEXT will be displayed on the first 3 lines. If not yet written, the lines will be blank.</p> <p>Use the ▲/▼/◀/▶ buttons and the <b>ENTER</b> or ↵ button to select and enter characters. To erase 1 character at one time, press the <b>RESET</b> button or press the ◀ and ↵ button at the same time. Also if you move the cursor to DELETE or ALL CLEAR on screen and press the <b>ENTER</b> or ↵ button, 1 character or all characters will be erased. The MY TEXT can be input up to 24 characters on each line.</p> <p>(3) To change an already inserted character, press the ▲/▼ button to move the cursor to one of the first 3 lines, and use the ◀/▶ buttons to move the cursor on the character to be changed.</p> <p>After pressing the <b>ENTER</b> or ↵ button, the character is selected. Then, follow the same procedure as described at the item (2) above.</p> <p>(4) To finish entering text, move the cursor to the OK on screen and press the ►, <b>ENTER</b> or ↵ button. To revert to the previous MY TEXT without saving changes, move the cursor to the CANCEL on screen and press the ◀, <b>ENTER</b> or ↵ button.</p> <ul style="list-style-type: none"> <li>• The MY TEXT WRITING function is available only when the MY TEXT PASSWORD function is set to OFF.</li> </ul>
<p><b>CLONING LOCK</b></p>	<p>The CLONING operation under OPTION_SERVICE menu is not available if ON is selected.</p>

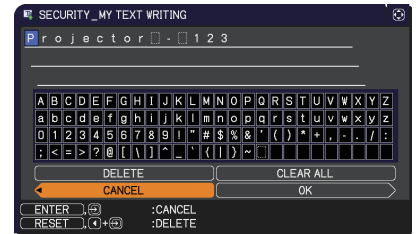
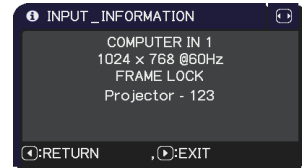

### Presentation tools

The projector has the following convenient tools that enable on-screen presentations easily and quickly:

- PC-LESS Presentation ([📖 below](#))
- Drawing function  
Drawing function enables you to draw on the projector's screen with USBmouse or tablets connected to the **USB TYPE A** ports. For details, refer to the manual for peripheral equipment.
- USB Display ([📖 92, 96](#))

### PC-LESS Presentation

The PC-LESS Presentation reads image and audio data from the storage media inserted into the **USB TYPE A** port and displays the image in the following modes. The PC-LESS Presentation can be started by selecting the **USB TYPE A** port as the input source.

This feature allows you to make your presentations without using your computer.

- Thumbnail mode ([📖 83](#))
- Full Screen mode ([📖 87](#))
- Slideshow mode ([📖 89](#))

#### [Supported storage media]

- USB memory (USB memory type, USB hard disk and USB card reader type)

**NOTE** • USB readers (adapters) that have more than one USB slot may not work (if the adapter is acknowledged as multiple devices connected).  
• USB devices with security software may not work.  
• Be careful when inserting or removing a USB device. ([📖 14, 85](#))

#### [Supported format]

- FAT12, FAT16 and FAT32

**NOTE** • NTFS is not supported.

**PC-LESS Presentation (continued)****[Supported file format and its extension]**

- JPEG (.jpeg, .jpg)      \* Progressive is not supported.
- Bitmap (.bmp)            \* 16bit mode and compressed bitmap is not supported.
- PNG (.png)                \* Interlace PNG is not supported.
- GIF (.gif)
- Movie (.avi, .mov)      \* Supported video format: Motion-JPEG  
Supported audio format: WAV (Linear PCM, Stereo 16bit),  
IMA-ADPCM

**NOTE** • Files with a resolution larger than the following are not supported.

MC-AW3506/MC-AW3006: 1280 x 800 (Still), 768 x 576 (Movie)

MC-AX3506/MC-AX3006: 1024 x 768 (Still), 768 x 576 (Movie)

(\* Some computers may not support 1280 x 800.)

- Files with a resolution smaller than 36 x 36 are not supported.
- Files with a resolution smaller than 100 x 100 may not be displayed.
- Movie images with a frame rate higher than 15 fps cannot be displayed.
- Movie images with a bit rate higher than 20 Mbps cannot be displayed.
- Some supported files may not be displayed.
- Only a frame appears when the content of image data cannot be displayed in the Thumbnail mode.
- Even with the file format and audio format combinations described above, playback of some files may fail.

**Thumbnail mode**

The Thumbnail mode displays the images stored in a USB storage device on the Thumbnail screen. Maximum 20 images are displayed in a screen.

If you wish, you can jump into the Full Screen mode or Slideshow mode, after you select some images in the Thumbnail mode.

The Thumbnail mode will be started as the primary function of the PC-LESS Presentation after selecting the **USB TYPE A** port as the input source.



## PC-LESS Presentation (continued)





### Operating by buttons or keys

You can control the images on the Thumbnail screen with the remote control, control panel or Web Remote Control. The following functions can be supported while the Thumbnail is displayed.

Button operation			Functions
The remote control	Control panel	Web Remote Control	
▲/▼/◀/▶	▲/▼/◀/▶	[▲]/[▼]/[◀]/[▶]	Move cursor
PAGE UP PAGE DOWN	-	[PAGE UP] [PAGE DOWN]	Switches pages
ENTER	INPUT	[ENTER]	<ul style="list-style-type: none"> <li>• Displays the selected image on the Full Screen mode when a cursor is on a thumbnail image.</li> <li>• Displays the setup menu ( <i>below</i>) for the selected image when a cursor is on a thumbnail image number.</li> </ul>





### The setup menu for the selected image

Use the ◀/▶ cursor buttons to switch each setting or use the ▶ cursor button to execute the functions as follows.

Item	Functions
RETURN	Press the ▶ cursor button or <b>ENTER</b> to return to the Thumbnail screen.
START	Switch to ON to set the selected image as the first image in the Slideshow. This setting information will be saved in the “playlist.txt” file (  91).
STOP	Switch to ON to set the selected image as the last image in the Slideshow. This setting information will be saved in the “playlist.txt” file (  91).
SKIP	Switch to ON to skip the selected image in the Slideshow. This setting information will be saved in the “playlist.txt” file (  91).
ROTATE	Press the ▶ cursor or <b>ENTER</b> button to rotate the selected still image 90 degrees clockwise. This setting information will be saved in the “playlist.txt” file (  91).
DELETE	Press the ▶ cursor or <b>ENTER</b> button to delete selected image. After executing delete, renew the image number displayed Thumbnail menu. If first or end image in the Slideshow is deleted, renew the setting of start/stop.





**PC-LESS Presentation (continued)****Operating by the menu on the Thumbnail screen**

You can also control the images by using the menu on the Thumbnail screen.

Item	Functions
	Moves to an upper folder.
<b>SORT</b>	Allows you to sort files and folders as following.
<b>RETURN</b>	Press the ► cursor button or <b>ENTER</b> to return to the Thumbnail screen.
<b>NAME UP</b>	Sorts in ascending order by file name.
<b>NAME DOWN</b>	Sorts in descending order by file name.
<b>DATE UP</b>	Sorts in ascending order by file date.
<b>DATE DOWN</b>	Sorts in descending order by file date.
<b>▲/▼</b>	Go to previous / next page.
<b>SLIDESHOW</b>	Configures and starts the Slideshow (  89).
<b>RETURN</b>	Press the ► cursor button or <b>ENTER</b> to return to the Thumbnail screen.
<b>PLAY</b>	Press the ► cursor button or <b>ENTER</b> to start the Slideshow.
<b>START</b>	Sets the beginning number of the Slideshow.
<b>STOP</b>	Sets the end number of the Slideshow.
<b>INTERVAL</b>	Sets the interval time for displaying still images during the Slideshow.
<b>PLAY MODE</b>	Selects the Slideshow mode.
<b>INPUT</b>	The input source list is displayed.
<b>MENU</b>	Displays the menu.
<b>REMOVE USB</b>	Be sure to use this function before removing USB storage device from the projector. After that, the projector will not recognize a USB storage device until you insert it again into the <b>USB TYPE A</b> input port.
 / 	Turns the sound on/off for files that contain audio data.

**PC-LESS Presentation (continued)**

**NOTE** • These operations are not accessible while the projector OSD is displayed.

- The Thumbnail mode is able to display up to 20 files in one page.
- It is not possible to change the input port by using the  button when the Thumbnail screen, Slideshow, or Full Screen is displayed.
- The image quality may deteriorate when playing back audio data included in a movie. If you want to give priority to the image quality, turn off the sound by setting  to off.
- If one of the **AUDIO IN** ports is selected or  is selected for USB TYPE A in AUDIO SOURCE of the AUDIO menu ( 54),  cannot be operated.
- Some error icons will be displayed in the Thumbnail.



————— This file seems to be broken or not supported format.

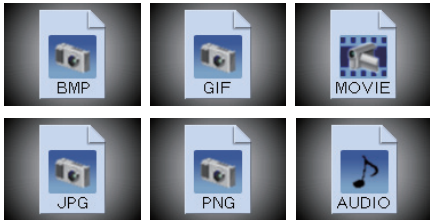

} A file that cannot be displayed on the thumbnail screen is indicated by a file format icon.

**PC-LESS Presentation (continued)****Full Screen Mode**

The Full Screen mode shows a full display image. To display in Full Screen mode, select an image in the Thumbnail screen. Then press the **ENTER** button on the remote control, the  button on the control panel or click **[ENTER]** on the Web Remote Control.



} Full screen display

**Operations for still images**

The following operations are enabled in the Full Screen mode while a still image is displayed.





Button operation			Functions
The remote control	Control panel	Web Remote Control	
▼ ▶ or <b>PAGE DOWN</b>	▼ or ▶	[▼] [▶] or <b>[PAGE DOWN]</b>	Shows the next file.
▲ ◀ or <b>PAGE UP</b>	▲ or ◀	[▲] [◀] or <b>[PAGE UP]</b>	Shows the previous file.
<b>ENTER</b>	<b>INPUT</b>	<b>[ENTER]</b>	Displays Thumbnail.

## PC-LESS Presentation (continued)

### Operations for movie

A remote control icon and a progress bar are displayed when one of the cursor buttons, **ENTER** button or  button on the remote control, control panel or Web Remote Control is pressed or clicked while a movie is playing in the Full Screen mode. The following operations are enabled while the remote control icon and progress bar are displayed.



Button operation			Functions
The remote control	Control panel	Web Remote Control	
▲	▲	[▲]	 (Play) /  (Pause) toggle
▶	▶	[▶]	 (FF) Fast-forward
◀	◀	[◀]	 (REW) Fast-rewind
<b>ENTER</b>	<b>INPUT</b>	[ <b>ENTER</b> ]	 (Stop), Displays Thumbnail.
<b>PAGE DOWN</b>	–	[ <b>PAGE DOWN</b> ]	Shows the next file.
<b>PAGE UP</b>	–	[ <b>PAGE UP</b> ]	Shows the previous file.

**NOTE** • These operations are not accessible while the projector OSD is displayed.  
 • It is not possible to change the input port by using the  button when the Thumbnail screen, Slideshow, or Full Screen is displayed.



**PC-LESS Presentation (continued)**

**Slideshow mode**

The Slideshow mode displays images in full screen and switches the images at intervals set in INTERVAL on the Thumbnail screen menu (📖85).

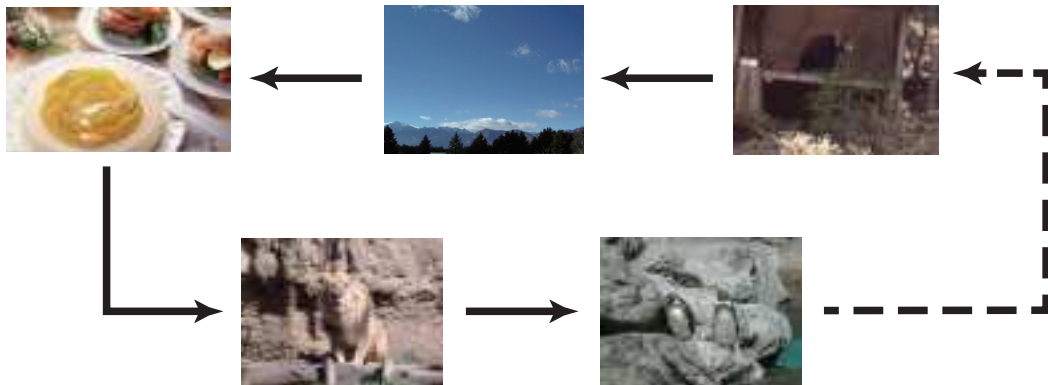



You can start this function from the Slideshow menu. To display the Slideshow menu, select the SLIDESHOW button in the Thumbnail mode and press the **ENTER** button on the remote control,  button on the control panel, or click **[ENTER]** on the Web Remote Control.

While the Slideshow is displayed, the following button operations are enabled when still images are displayed, and the same button operations in the Full Screen mode are enabled when movies are displayed.

Button operation			Functions
The remote control	Control panel	Web Remote Control	
<b>ENTER</b>	<b>INPUT</b>	<b>[ENTER]</b>	Displays thumbnail

**NOTE** • These operations are not accessible while the projector OSD is displayed.

- It is not possible to change the input port by using the  button when the Thumbnail screen, Slideshow, or Full Screen is displayed.
- When the Slideshow mode is set to ONE TIME and the last file is a still image, the last slide of the presentation will remain displayed until the **ENTER** button on the remote control or Web Remote Control, or the  button on the control panel is pressed.

### PC-LESS Presentation (continued)

You can play the Slideshow at your desired configuration. Configure the Slideshow items in the Thumbnail.

- 1) RETURN : Returns to the thumbnail mode.
- 2) PLAY : Play the Slideshow.
- 3) START : Set the beginning number of the Slideshow.
- 4) STOP : Set the end number of the Slideshow.
- 5) INTERVAL : Sets the interval time for displaying still images during the Slideshow.  
It is not recommend to set the interval time very short something like several seconds, because it may take more than several seconds to read and display an image file if it is stored in very deep layer directory or if so many files are stored in the same directory.
- 6) PLAY MODE : Select the Slideshow mode.  
ONE TIME : Play the Slideshow one time.  
ENDLESS : Play the Slideshow endless.

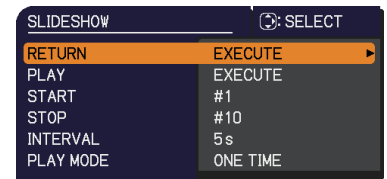

**NOTE** • The settings of the Slideshow are saved to the “**playlist.txt**” file that is stored in the storage media. If the file is not existed, it is generated automatically.

- The settings for the START, STOP, INTERVAL, and PLAY MODE are saved to the Playlist.
- If the storage media is under the write protection or the “**playlist.txt**” is the read only type file, it is impossible to change the settings of the Slideshow.

## PC-LESS Presentation (continued)

### Playlist

The Playlist is a DOS format text file, which decides the order of displayed still image files in the Thumbnail or Slideshow.

The playlist file name is “playlist.txt” and it can be edited on a computer.

It is created in the folder that contains the selected image files when the PC-LESS Presentation is started or the Slideshow is configured.

#### [Example of “playlist.txt” files]

START setting : STOP setting : INTERVAL setting : PLAY MODE setting :

img001.jpg: : :

img002.jpg:600: : :

img003.jpg:700:rot1: :

img004.jpg: : :SKIP:

img005.jpg:1000:rot2:SKIP:

The “playlist.txt” file contains the following information.

Each piece of information requires to be separated by “:”, and “:” at the end of each line.

1st line: START, STOP, INTERVAL and PLAY MODE settings ([📖90](#)).

2nd line and after: file name, interval time, rotation setting and skip setting.

interval time: It can be set from 0 to 999900 (ms) with an increment of 100 (ms).

rotation setting: “rot1” means a rotation at 90 degrees clockwise; “rot2” and “rot3” increase another 90 degrees in order.

skip setting: “SKIP” means that the image will not be displayed in the Slideshow.

- NOTE** • The maximum length in a line on the "playlist.txt" file is 255 characters including linefeed. If any line exceeds the limit, the "playlist.txt" file becomes invalid.
- Up to 999 files can be registered to the Playlist. However, if some folders exist in the same directory the limit number is decreased by the number of folders. Any files over the limit will not be shown in the Slideshow.
  - If the storage device is protected or does not have sufficient space, the “playlist.txt” file cannot be created.
  - For the Slideshow settings, refer to the section **Slideshow mode** ([📖89](#)).

## USB Display(Windows® computer)

The projector can display images transferred from a computer via an USB cable (📖11).

### Hardware and software requirement for computer

- **OS:** One of the following.  
Windows® 7  
Windows® 8.1  
Windows® 10
- **CPU:** Pentium® 4 (2.8 GHz or higher)
- **Graphic card:** 16 bit, XGA or higher
- **Memory:** 512 MB or higher
- **Hard disk space:** 30 MB or higher
- **USB Port**
- **USB cable :** 1 piece

### Starting USB Display

When you connect your computer to the **USB TYPE B** port on the projector using a USB cable, the projector will be recognized as a CD-ROM drive on your computer. Then, the software in the projector, "LiveViewerLiteForUSB.exe", will run automatically and the application, "LiveViewer Lite for USB", will be ready on your computer for the USB Display. The application, "LiveViewer Lite for USB", will close automatically when the USB cable is unplugged. However, it may remain displayed at times.

**NOTE** • If the software does not start automatically (this is typically because CD-ROM autorun is disabled on your OS), follow the instructions below.

(1) Click on the [Start] button on the toolbar and select the "Run"

(2) Enter F:\LiveViewerLiteForUSB.exe and then press the [OK]

↑—— If your CD-ROM drive is not drive F on your computer, you will need to replace F with the correct drive letter assigned to your CD-ROM drive.

- CD-ROM autorun is disabled while the screen saver is running.
- The image transmission from the computer is suspended while the password-protected screen saver is running. To resume the transmission, exit the screen saver.
- If "Waiting for connection." remains displayed while the USB cable is connected, remove the USB cable and reconnect after a while.

(continued on next page)

## USB Display(Windows® computer) (continued)

This application will appear in the Windows notification area once it starts. You can quit the application from your computer by selecting “Quit” on the menu.

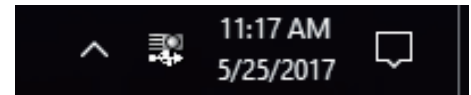

**NOTE** • The “LiveViewer” (refer to the **Network Guide**) and this application cannot be used at the same time. If you connect your computer to the projector by using a USB cable while the “LiveViewer” is running, the following message will be displayed.

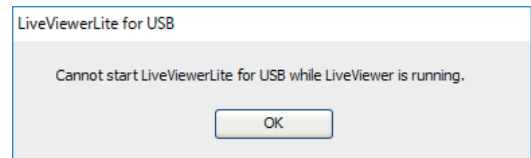

while the “LiveViewer” is running, the following message will be displayed.

- Depending on the software installed on your computer, images on your computer cannot be transferred using “LiveViewer Lite for USB”.
- If any application software having the firewall function is installed into your computer, make the firewall function invalid with following the user's manual.
- Some security software may block image transmission. Please change the security software setting to allow the use of "LiveViewer Lite for USB".
- When the audio input from **USB TYPE B** is selected, if the sound level is still low even after raising the volume level in the projector to the maximum, check whether your computer outputs audio and raise the volume level accordingly.
- If the computer in use is equipped with **HDMI** port, the audio setting will be changed and sound interruption or noise may occur when the **HDMI** cable is connected or disconnected during USB Display. Restart USB Display for this case.
- Image distortion or sound interruption may occur when “LiveViewer” is connected to **LAN** (wireless or wired) during USB Display. The above decline in performance is noticeable especially when multiple computers are connected to “LiveViewer”.

## USB Display(Windows® computer) (continued)

### Right-Click menu

The menu shown in the right will be displayed when you right-click the application icon in the Windows notification area.

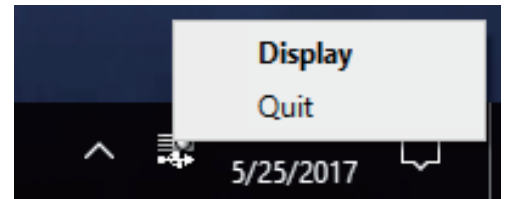

**Display** : The Floating menu is displayed, and the icon disappears from the Windows notification area.

**Quit** : The application is closed, and the icon disappears from the Windows notification area.

**NOTE** • If you wish to restart the application, you need to unplug the USB cable and plug it again.

### Floating menu

If you select “Display” on the Right-Click menu, the Floating menu shown in the right will appear on your computer screen.

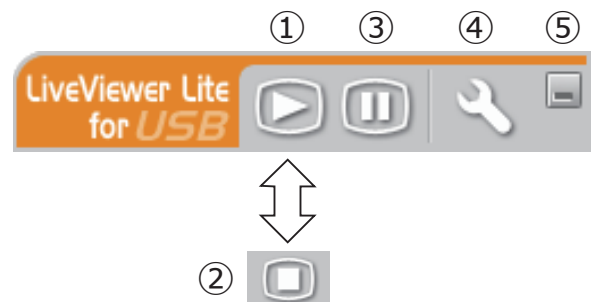

① Start capture button

The transmission to the projector is started and the images will be displayed.

② Stop button

The image transmission is stopped.

③ Hold button

The image on the projector’s screen is temporally frozen. The last image before the button is clicked is remained on the screen. You can revise the image data on your computer without showing it on the projector's screen.

④ Option button

The Options window is displayed.

⑤ Minimize button

The Floating menu is closed, and the icon reappears in the Windows notification area.

**NOTE** • If you click the Start capture button and/or Stop button repeatedly, images may not be displayed on the screen.

## USB Display(Windows® computer) (continued)

### Options window

If you select the Option button on the Floating menu, the Options window is displayed.

#### Optimize Performance

The “LiveViewer Lite for USB” captures screenshots in JPEG data and sends them to the projector. The “LiveViewer Lite for USB” has two options that have different compression rate of JPEG data.

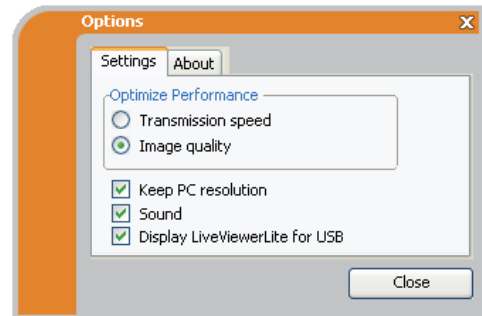

#### Transmission speed

Speed takes priority over Image quality.  
It makes JPEG compression rate higher.

The screen on the projector is rewritten quicker because the transferred data is smaller, but the image quality is worse.

#### Image quality

Image quality takes priority over Speed.  
It makes JPEG compression rate lower.

The screen on the projector is rewritten slower because the transferred data is larger, but the image quality is better.

#### Keep PC resolution

If you remove the check mark from the [**Keep PC resolution**] box, the screen resolution of your computer will be switched as follows, and the display speed may be faster.

MC-AW3506, MC-AW3006: 1280 x 800 (WXGA)

MC-AX3506, MC-AX3006: 1024 x 768 (XGA)

If your computer does not support the display resolution specified above, a smaller resolution that is the largest among the resolutions that are supported by the computer will be selected.

#### Sound

Turns the sound on/off. The image quality may deteriorate when you play back audio data transferred together with the image data. To give priority to the image quality, turn off the sound by selecting the checkbox.

#### Display LiveViewer Lite for USB

If you want to display the "LiveViewer Lite for USB" application window on the screen, please check the box.

#### About

The version information of the “LiveViewer Lite for USB”.

**NOTE** • When the resolution is changed, the arrangement of icons on computer desktop screen may be changed.

• If one of the **AUDIO IN** ports is selected or  $\times$  is selected for USB TYPE B in AUDIO SOURCE of the AUDIO menu (📖54), audio sound operation in the Options window will be disabled.

## USB Display(Mac® computer)

The projector can display images transferred from a computer via an USB cable (📖11).

### Hardware and software requirement for computer

- **OS:** Mac OS X® 10.6  
     Mac OS X® 10.7  
     OS X® 10.8  
     OS X® 10.9  
     OS X® 10.10  
     OS X® 10.11  
     macOS® 10.12
- **Graphic card:** 16 bit, XGA or higher
- **Memory:** 512 MB or higher
- **Hard disk space:** 30 MB or higher

### Starting USB Display

When you connect your computer to the **USB TYPE B** port on the projector using a USB cable, the projector will be recognized as a CD-ROM drive on your computer. Double click the CD-ROM, then double click

"LiveViewerLiteForUSB\_MacOS.app.". The application, "LiveViewer Lite for USB", will close automatically when the USB cable is unplugged. However, it may remain displayed at times.



**NOTE** • The image transmission from the computer is suspended while the password-protected screen saver is running. To resume the transmission, exit the screen saver.

- If "Waiting for connection." remains displayed while the USB cable is connected, remove the USB cable and reconnect after a while.

(continued on next page)



**USB Display(Mac® computer) (continued)**

**NOTE** • The “LiveViewer” (refer to the **Network Guide**) and this application cannot be used at the same time. If you connect your computer to the projector by using a USB cable while the “LiveViewer” is running, the following message will be displayed.

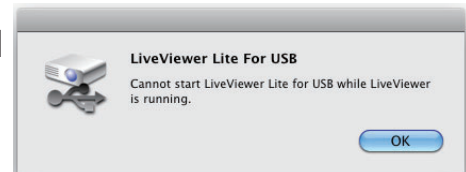

- Depending on the software installed on your computer, images on your computer cannot be transferred using “LiveViewer Lite for USB”.
- If any application software having the firewall function is installed into your computer, make the firewall function invalid with following the user's manual.
- Some security software may block image transmission. Please change the security software setting to allow the use of "LiveViewer Lite for USB".
- When the audio input from **USB TYPE B** is selected, if the sound level is still low even after raising the volume level in the projector to the maximum, check whether your computer outputs audio and raise the volume level accordingly.
- If the computer in use is equipped with **HDMI** port, the audio setting will be changed and sound interruption or noise may occur when the **HDMI** cable is connected or disconnected during USB Display. Restart USB Display for this case.
- Image distortion or sound interruption may occur when “LiveViewer” is connected to **LAN** (wireless or wired) during USB Display. The above decline in performance is noticeable especially when multiple computers are connected to “LiveViewer”.

## USB Display(Mac® computer) (continued)

### Menu

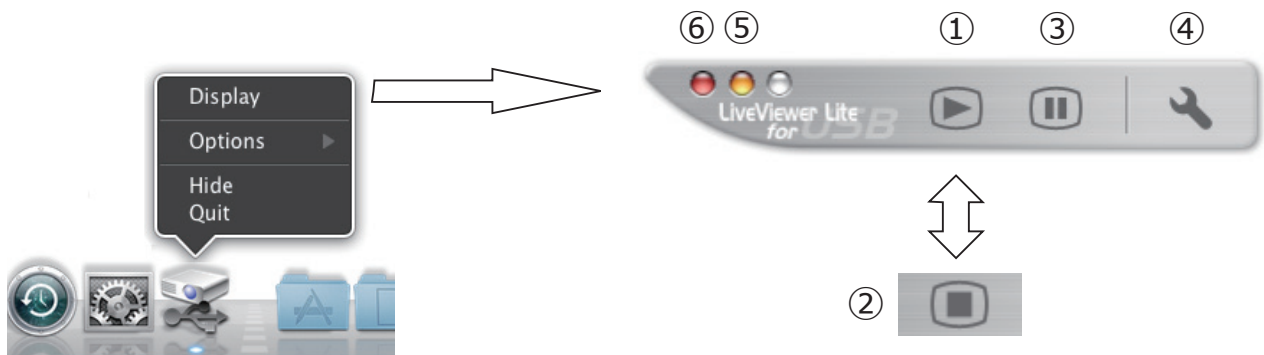

If you select “Display” on the Right-Click menu, the Floating menu shown in the right will appear on your computer screen.

- ① Start capture button  
The transmission to the projector is started and the images will be displayed.
- ② Stop button  
The image transmission is stopped.
- ③ Hold button  
The image on the projector’s screen is temporally frozen. The last image before the button is clicked is remained on the screen. You can revise the image data on your computer without showing it on the projector's screen.
- ④ Option button  
The Options window is displayed.
- ⑤ Minimize button  
The Floating menu is closed, and the icon reappears in the Dock.
- ⑥ Exit button  
The Floating menu is closed.

**NOTE** • If you click the Start capture button and/or Stop button repeatedly, images may not be displayed on the screen.

## USB Display(Mac® computer) (continued)

### Options window

If you select the Option button on the Floating menu, the Options window is displayed.

#### Optimize Performance

The “LiveViewer Lite for USB” captures screenshots in JPEG data and sends them to the projector. The “LiveViewer Lite for USB” has two options that have different compression rate of JPEG data.



#### Transmission speed

Speed takes priority over Image quality.

It makes JPEG compression rate higher.

The screen on the projector is rewritten quicker because the transferred data is smaller, but the image quality is worse.

#### Image quality

Image quality takes priority over Speed.

It makes JPEG compression rate lower.

The screen on the projector is rewritten slower because the transferred data is larger, but the image quality is better.

#### Keep PC resolution

If you remove the check mark from the **[Keep PC resolution]** box, the screen resolution of your computer will be switched as follows, and the display speed may be faster.

MC-AW3506, MC-AW3006: 1280 x 800 (WXGA)

MC-AX3506, MC-AX3006: 1024 x 768 (XGA)

If your computer does not support the display resolution specified above, a smaller resolution that is the largest among the resolutions that are supported by the computer will be selected.

#### Sound

Turns the sound on/off. The image quality may deteriorate when you play back audio data transferred together with the image data. To give priority to the image quality, turn off the sound by selecting the checkbox.

#### About

The version information of the “LiveViewer Lite for USB”.

**NOTE** • When the resolution is changed, the arrangement of icons on computer desktop screen may be changed.

• If one of the **AUDIO IN** ports is selected or  $\times$  is selected for USB TYPE B in AUDIO SOURCE of the AUDIO menu (54), audio sound operation in the Options window will be disabled.

## Maintenance

**Replacing the lamp**

A lamp has finite product life. Using the lamp for long periods of time could cause the pictures darker or the color tone poor. Note that each lamp has a different lifetime, and some may burst or burn out soon after you start using them. Preparation of a new lamp and early replacement are recommended. To prepare a new lamp, make contact with your dealer and tell the lamp type number.

**Type number : DT01411**

**Replacing the lamp**

1. Turn the projector off, and unplug the power cord.
  - Allow the projector to cool for at least 45 minutes.
2. Prepare a new lamp. If the projector is mounted on a ceiling, or if the lamp has broken, also ask the dealer to replace the lamp.

lamp cover

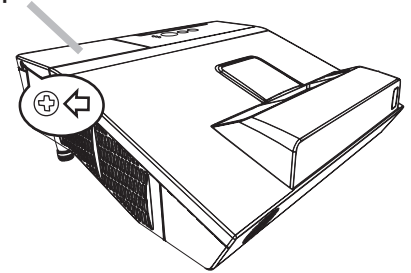
**In case of replacement by yourself, follow the following procedure.**

3. Loosen the screw (marked by arrow) of the lamp cover and then slide and lift the lamp cover to the side to remove it.
4. Loosen the 2 screws (marked by arrow) of the lamp, and slowly pick up the lamp by the handle. Never loosen any other screws.
5. Insert the new lamp, and retighten firmly the 2 screws of the lamp that are loosened in the previous process to lock it in place.
6. While putting the interlocking parts of the lamp cover and the projector together, slide the lamp cover back in place. Then firmly fasten the screw of the lamp cover.
7. Turn the projector on and reset the lamp time using the LAMP TIME item in the SETUP menu.
  - (1) Press the **MENU** button to display a menu.
  - (2) Point at the ADVANCED MENU in the menu using the ▼/▲ button, then press the ► button.
  - (3) Point at the SETUP in the left column of the menu using the ▼/▲ button, then press the ► button.
  - (4) Point at the LAMP & FILTER using the ▼/▲ button, then press the ► button.
  - (5) Point at the LAMP TIME using the ▼/▲ button, then press the ► button. A dialog will appear.
  - (6) Press the ► button to select “OK” on the dialog. It performs resetting the lamp time.

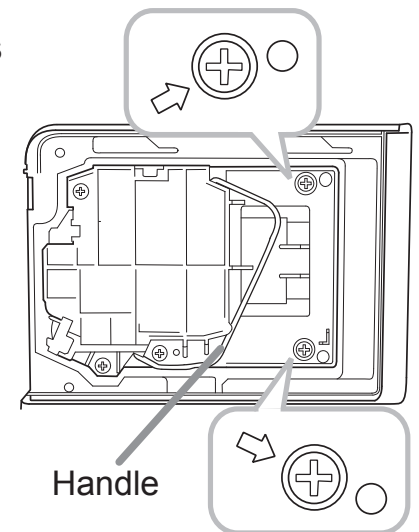
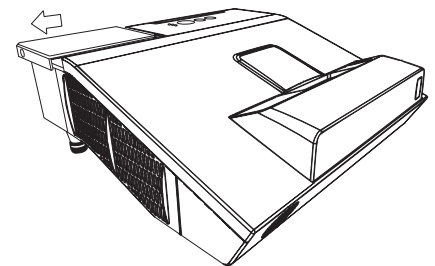

**⚠ CAUTION** ► Do not touch any inner space of the projector, while the lamp is taken out.

**NOTE** • Please reset the lamp time only when you have replaced the lamp, for a suitable indication about the lamp.

## Replacing the lamp (continued)

### Lamp warning



**HIGH VOLTAGE**



**HIGH TEMPERATURE**



**HIGH PRESSURE**

**⚠ WARNING** ► The projector uses a high-pressure mercury glass lamp. The lamp can break with a loud bang, or burn out, if jolted or scratched, handled while hot, or worn over time. Note that each lamp has a different lifetime, and some may burst or burn out soon after you start using them. In addition, if the bulb bursts, it is possible for shards of glass to fly into the lamp housing, and for gas containing mercury and dust containing fine particles of glass to escape from the projector's vent holes.

► **About disposal of a lamp:** This product contains a mercury lamp; do not put it in a trash. Dispose of it in accordance with environmental laws.

- For lamp recycling, go to [www.lamprecycle.org](http://www.lamprecycle.org) (in the US).
- For product disposal, consult your local government agency or [www.eiae.org](http://www.eiae.org) (in the US) or [www.epsc.ca](http://www.epsc.ca) (in Canada).

For more information, call your dealer.



Disconnect  
the plug  
from the  
power  
outlet

- If the lamp should break (it will make a loud bang when it does), unplug the power cord from the outlet, and make sure to request a replacement lamp from your local dealer. Note that shards of glass could damage the projector's internals, or cause injury during handling, so please do not try to clean the projector or replace the lamp yourself.
- If the lamp should break (it will make a loud bang when it does), ventilate the room well, and make sure not to inhale the gas or fine particles that come out from the projector's vent holes, and not to get them into your eyes or mouth.
- Before replacing the lamp, turn the projector off and unplug the power cord, then wait at least 45 minutes for the lamp to cool sufficiently. Handling the lamp while hot can cause burns, as well as damaging the lamp.



- Never unscrew except the appointed (marked by an arrow) screws.
- Do not open the lamp cover while the projector is mounted on a wall or ceiling. This is dangerous, since if the lamp's bulb has broken, the shards will fall out when the cover is opened. In addition, working in high places is dangerous, so ask your local dealer to have the lamp replaced even if the bulb is not broken.
- Do not use the projector with the lamp cover removed. At the lamp replacing, make sure that the screws are screwed in firmly. Loose screws could result in damage or injury.



- Use only the lamp of the specified type. Use of a lamp that does not meet the lamp specifications for this model could cause a fire, damage or shorten the life of this product.
- If the lamp breaks soon after the first time it is used, it is possible that there are electrical problems elsewhere besides the lamp. If this happens, consult your local dealer or a service representative.
- Handle with care: jolting or scratching could cause the lamp bulb to burst during use.
- Using the lamp for long periods of time, could cause it dark, not to light up or to burst. When the pictures appear dark, or when the color tone is poor, please replace the lamp as soon as possible. Do not use old (used) lamps; this is a cause of breakage.

## Cleaning and replacing the air filter

The air filter unit of this projector consists of a filter cover, two kinds of filters, and a filter frame. The new double large filters system is expected to function longer. However, please check and clean it periodically to keep ventilation needed for normal operation of the projector.

When the indicators or a message prompts you to clean the air filter, comply with it as soon as possible. Replace the filters when they are damaged or too soiled. To prepare new filters, make contact with your dealer and tell the following type number.

**Type number : UX37191** (Filter set)

When you replace the lamp, please replace the air filter. An air filter of specified type will come together with a replacement lamp for this projector.

1. Turn the projector off, and unplug the power cord.
  - Allow the projector to sufficiently cool down.
2. Use a vacuum cleaner on and around the filter cover.
3. Slide the filter unit upward to take it off from the projector.
4. Use a vacuum cleaner for the filter vent of the projector.
5. Take the fine meshed filter out while holding the filter cover. It is recommended to leave the coarse meshed filter in the filter cover as it is.
6. Use a vacuum cleaner on both sides of the fine meshed filter while holding it so it will not be sucked in. Use a vacuum cleaner for the inside of the filter cover to clean up the coarse meshed filter. If the filters are damaged or heavily soiled, replace them with new ones.
7. Put the fine meshed filter on the coarse meshed one, turning its plastic band side up.
8. Put the filter unit back into the projector.

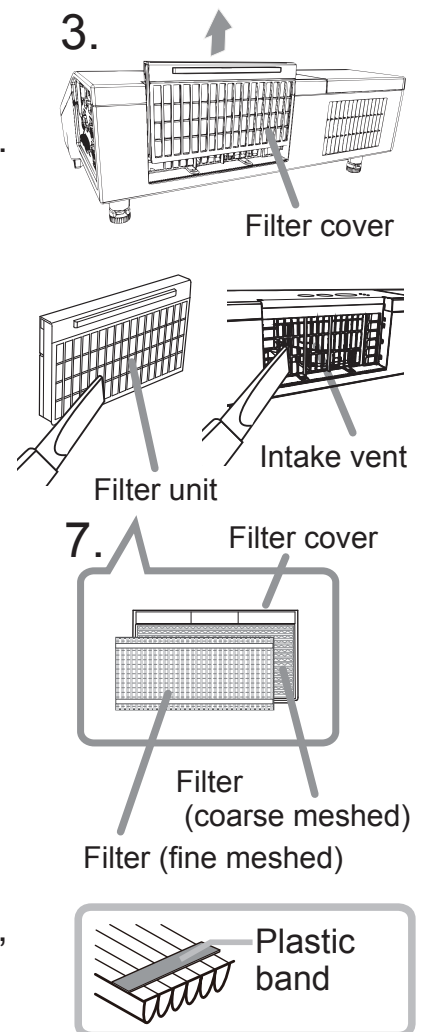

(continued on next page)

### ***Cleaning and replacing the air filter (continued)***

9. Turn the projector on and reset the filter time using the FILTER TIME item in the EASY MENU.
  - (1) Press the **MENU** button to display a menu.
  - (2) Point at the FILTER TIME using the ▼/▲ button, then press the ► button. A dialog will appear.
  - (3) Press the ► button to select “OK” on the dialog. It performs resetting the filter time.

**⚠ WARNING** ► Before taking care of the air filter, make sure the power cable is not plugged in, then allow the projector to cool sufficiently. Taking care of the air filter in a high temperature state of the projector could cause an electric shock, a burn or malfunction to the projector.

► Use only the air filter of the specified type. Do not use the projector without the air filter or the filter cover. It could result in a fire or malfunction to the projector.

► Clean the air filter periodically. If the air filter becomes clogged by dust or the like, internal temperatures rise and could cause a fire, a burn or malfunction to the projector.

**NOTE** • Please replace the air filter when it is damaged or heavily soiled.

- When you replace the projection lamp, please replace the air filter. An air filter of specified type will come together with a replacement lamp for this projector.
- Please reset the filter time only when you have cleaned or replaced the air filter, for a suitable indication about the air filter.
- The projector may display the message such as “CHECK THE AIR FLOW” or turn off the projector, to prevent the internal heat level rising.

## Installing or replacing the internal clock battery

This product has an internal clock. When you use the function that requires the internal clock (📖"Event Scheduling" in the Network Guide), install a new battery. If the internal clock starts to malfunction, try to replace the battery. Use the following type of battery, and follow the steps below.

MAXELL, Part No. **CR2032** or **CR2032H**

1. Turn the projector off, and unplug the power cord. Allow the projector to cool sufficiently.
2. After making sure that the projector has cooled adequately, slowly turn over the projector, so that the bottom is facing.
3. Turn the battery cover fully in the direction indicated "**OPEN**" using a coin or the like, and pick the cover up to remove it.
4. Pry up the old battery using a flathead screwdriver or the like to take it out. Do not use any metal tools. While prying it up, put a finger lightly on the battery since it may pop out of the holder.
5. Install a new battery in place. Slide the battery in under the plastic claw, and push it into the holder until it clicks.
6. Replace the battery cover in place, then turn it in the direction indicated "**CLOSE**" using such as coins, to fix.

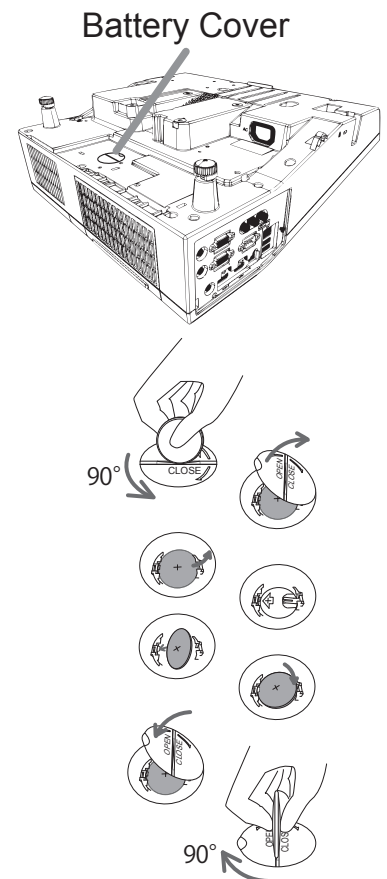

**⚠WARNING** ▶ Always handle the batteries with care and use them only as directed. Battery may explode if mistreated. Do not recharge, disassemble or dispose of in fire.

And also improper use may result in cracking or leakage, which could result in fire, injury and/or pollution of the surrounding environment.

- Be sure to use only the batteries specified.
- Make sure the plus and minus terminals are correctly aligned when loading a battery.
- Keep a battery away from children and pets. If swallowed consult a physician immediately for emergency treatment.
- Do not short circuit or solder a battery.
- Do not allow a battery in a fire or water. Keep batteries in a dark, cool and dry place.
- If you observe battery leakage, wipe out the leakage and then replace a battery. If the leakage adheres to your body or clothes, rinse well with water immediately.
- Obey the local laws on disposing a battery.

**NOTE** • The internal battery is required to be replaced when the time is off soon after setting date and time.



## Caring for the projection window

If the projection window is flawed, soiled or fogged, it could cause deterioration of display quality. Please take care of the projection window, being cautious of handling.

1. Turn the projector off and unplug the power cord from the power outlet. And cool the projector down by leaving it for a while as it is.
2. Use an air blower to blow away dust on the projection window before wiping. Wipe softly the projection window with a dampened soft cleaning cloth for lens on the market, being careful not to give any damage on the projection window.

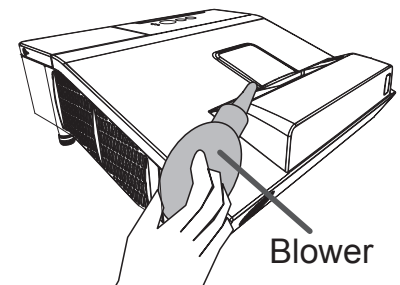

- Use commercially available lens tissue to clean the lens (used to clean cameras, eyeglasses, etc.).
- If the lens is heavily soiled, wipe it with a cloth moistened with little water.
- Never use polishing agents, detergents, chemicals, or solvents such as benzine or thinner.
- Excepting for lens, use a soft cloth to clean. When excessively soiled, dilute a neutral detergent in water, wet and wring out the soft cloth.

**⚠ WARNING** ▶ Before caring for the projection window, turn the projector off and unplug the power cord, then cool the projector sufficiently.

▶ Do not use a vacuum cleaner to clean the projection window, since it might give some damage.

▶ Do not use cleaners or chemicals other than those specified in this manual. Pay special attention to the projection window as these materials could cause serious damage to either.

## Other care

### Inside of the projector

In order to ensure the safe use of your projector, please have it cleaned and inspected by your dealer about once every year.

### Caring for the cabinet and remote control

Incorrect care could have adverse influence such as discoloration, peeling paint, etc.

1. Turn the projector off, and unplug the power cord. Allow the projector to cool sufficiently.
2. After making sure that the projector is cool adequately, lightly wipe with gauze or a soft cloth.  
If the projector is extremely dirty, dip soft cloth in water or a neutral cleaner diluted in water, and wipe lightly after wringing well. Then, wipe lightly with a soft, dry cloth.

**⚠ WARNING** ▶ Before caring, make sure the power cord is not plugged in, and then allow the projector to cool sufficiently. The care in a high temperature state of the projector could cause a burn and/or malfunction to the projector.

▶ Never try to care for the inside of the projector personally. Doing is so dangerous.

▶ Avoid wetting the projector or inserting liquids in the projector. It could result in a fire, an electric shock, and/or malfunction to the projector.

- Do not put anything containing water, cleaners or chemicals near the projector.
- Do not use aerosols or sprays.

**⚠ CAUTION** ▶ Please take right care of the projector according to the following. Incorrect care could cause not only an injury but adverse influence such as discoloration, peeling paint, etc.

▶ Do not use cleaners or chemicals other than those specified in this manual.

▶ Do not polish or wipe with hard objects.

**NOTICE** ▶ Do not directly touch the projection window surface with hands.

## Troubleshooting



If an abnormal operation should occur, stop using the projector immediately.

**⚠ WARNING** ▶ Never use the projector if abnormal operations such as smoke, strange odor, excessive sound, damaged casing or elements or cables, penetration of liquids or foreign matter, etc. should occur. In such cases, immediately disconnect the power plug from the power outlet. After making sure that the smoke or odor has stopped, contact to your dealer or service company.

Otherwise if a problem occurs with the projector, the following checks and measures are recommended before requesting repair.  
If this does not resolve the problem, please contact your dealer or service company. They will tell you what warranty condition is applied.



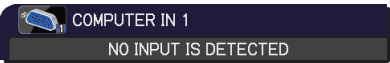

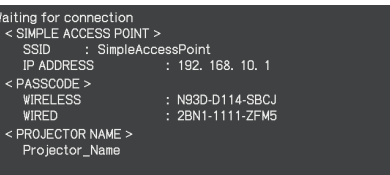

### Related messages

When some message appears, check and cope with it according to the following table. Although these messages will be automatically disappeared around several minutes, it will be reappeared every time the power is turned on.

Message	Description
	<p><b>There is no input signal.</b> Please confirm the signal input connection, and the status of the signal source.</p>
	<p><b>Projector is waiting for an image file.</b> Check the hardware connection, settings on the projector and network-related settings. The computer-Projector network connection might be disconnected. Please re-connect using “Connect button” of the “LiveViewer”.</p>
	

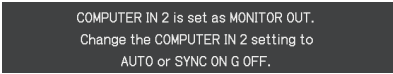
(continued on next page)

Related messages (continued)

Message	Description
	<p><b>The horizontal or vertical frequency of the input signal is not within the specified range.</b> Please confirm the specs for your projector or the signal source specs.</p>
	<p><b>An improper signal is input.</b> Please confirm the specs for your projector or the signal source specs.</p>
	<p><b>The COMPUTER IN2/MONITOR OUT port is selected as the picture input source even if MONITOR OUT is selected for COMPUTER IN2(46).</b> Select AUTO or SYNC ON G OFF in the dialog to project the picture input to the <b>COMPUTER IN2/MONITOR OUT</b> port. In this case, you cannot use the MONITOR OUT function. Otherwise select other port for picture input.</p>
	<p><b>The internal temperature is rising.</b> Please turn the power off, and allow the projector to cool down at least 20 minutes. After having confirmed the following items, please turn the power ON again.</p> <ul style="list-style-type: none"> <li>• Is there blockage of the air passage aperture?</li> <li>• Is the air filter dirty?</li> <li>• Does the peripheral temperature exceed 40°C?</li> <li>• Is the projector used at an altitude of about 1600 m or higher? If the projector is used at an altitude of about 1600 m or higher, set ALTITUDE of the SERVICE item in the OPTION menu to HIGH (68). If the projector is used with a wrong setting, it may cause damage to the projector itself or the parts inside.</li> </ul>
	<p><b>A note of precaution when cleaning the air filter.</b> Please immediately turn the power off, and clean or change the air filter referring to the “Cleaning and replacing the air filter” section of this manual. After you have cleaned or changed the air filter, please be sure to reset the filter time (52, 102).</p>
	<p><b>The button operation is not available.</b></p>

## Regarding the indicator lamps

When operation of the **LAMP**, **TEMP** and **POWER** indicators differs from usual, check and cope with it according to the following table.

POWER indicator	LAMP indicator	TEMP indicator	Description
Lighting In <b>Orange</b>	Turned <b>off</b>	Turned <b>off</b>	<b>The projector is in a standby state.</b> Please refer to the section "Power on/off".
<i>Blinking</i> In <b>Green</b>	Turned <b>off</b>	Turned <b>off</b>	<b>The projector is warming up.</b> Please wait.
Lighting In <b>Green</b>	Turned <b>off</b>	Turned <b>off</b>	<b>The projector is in an on state.</b> Ordinary operations may be performed.
<i>Blinking</i> In <b>Orange</b>	Turned <b>off</b>	Turned <b>off</b>	<b>The projector is cooling down.</b> Please wait.
<i>Blinking</i> In <b>Red</b>	(discre- tionary)	(discre- tionary)	<b>The projector is cooling down. A certain error has been detected.</b> Please wait until <b>POWER</b> indicator finishes blinking, and then perform the proper measure using the item descriptions below.
<i>Blinking</i> In <b>Red</b> or Lighting In <b>Red</b>	Lighting In <b>Red</b>	Turned <b>off</b>	<b>The lamp cannot be lighted. There is a possibility that interior portion has become heated, or that the power supply is unstable.</b> Please turn the power off, and allow the projector to cool down at least 20 minutes. After the projector has sufficiently cooled down, please make confirmation of the following items, and then turn the power on again. <ul style="list-style-type: none"> <li>• Is there blockage of the air passage aperture?</li> <li>• Is the air filter dirty?</li> <li>• Does the peripheral temperature exceed 40°C?</li> </ul> Otherwise, remove the lamp unit once, and then put it back into place, referring to the "Replacing the lamp". If the same indication is displayed after the remedy, please change the lamp referring to the section "Replacing the lamp".
<i>Blinking</i> In <b>Red</b> or Lighting In <b>Red</b>	<i>Blinking</i> In <b>Red</b>	Turned <b>off</b>	<b>The lamp cover has not been properly fixed.</b> Please turn the power off, and allow the projector to cool down at least 45 minutes. After the projector has sufficiently cooled down, please make confirmation of the attachment state of the lamp cover. After performing any needed maintenance, turn the power on again. If the same indication is displayed after the remedy, please contact your dealer or service company.

(continued on next page)

**Regarding the indicator lamps (continued)**

POWER indicator	LAMP indicator	TEMP indicator	Description
Blinking In <b>Red</b> or Lighting In <b>Red</b>	Turned off	Blinking In <b>Red</b>	<b>The cooling fan is not operating.</b> Please turn the power off, and allow the projector to cool down at least 20 minutes. After the projector has sufficiently cooled down, please make confirmation that no foreign matter has become caught in the fan, etc., and then turn the power on again. If the same indication is displayed after the remedy, please contact your dealer or service company.
Blinking In <b>Red</b> or Lighting In <b>Red</b>	Turned off	Lighting In <b>Red</b>	<b>There is a possibility that the interior portion has become heated.</b> Please turn the power off, and allow the projector to cool down at least 20 minutes. After the projector has sufficiently cooled down, please make confirmation of the following items, and then turn the power on again. <ul style="list-style-type: none"> <li>• Is there blockage of the air passage aperture?</li> <li>• Is the air filter dirty?</li> <li>• Does the peripheral temperature exceed 40°C?</li> <li>• Is the projector used at an altitude of about 1600 m or higher? If the projector is used at an altitude of about 1600 m or higher, set ALTITUDE of the SERVICE item in the OPTION menu to HIGH (📖68).</li> </ul>
Lighting In <b>Green</b>	Simultaneous blinking in <b>Red</b>		<b>It is time to clean the air filter.</b> Please immediately turn the power off, and clean or change the air filter referring to the section “Cleaning and replacing the air filter”. After cleaning or changing the air filter, please be sure to reset the filter time. After the remedy, reset the power to ON.
Lighting In <b>Green</b>	Alternative blinking in <b>Red</b>		<b>There is a possibility that the interior portion has become overcooled.</b> Please use the unit within the usage temperature parameters (0°C to 40°C). After the treatment, reset the power to ON.
Blinking In <b>Green</b> for approx. 3 seconds.	Turned off	Turned off	<b>At least 1 "Power ON" schedule is saved to the projector.</b> Please refer to <b>Schedule Settings</b> section of <b>User's Manual - Network Guide</b> .

(continued on next page)

**Regarding the indicator lamps (continued)**

POWER indicator	LAMP indicator	TEMP indicator	Description
Lighting In <b>Orange</b>	Lighting In <b>Red</b>	Lighting In <b>Red</b>	<b>Loading the saved data of CLONING on STANDBY MODE.</b>
<i>Blinking</i> In <b>Orange</b>	<i>Blinking</i> In <b>Red</b>	<i>Blinking</i> In <b>Red</b>	<b>Loading the saved data of CLONING has failed on STANDBY MODE.</b> Please refer to CLONING (📖72 ~ 75).
Turned <b>off</b>	Turned <b>off</b>	Turned <b>off</b>	<b>Loading the saved data of CLONING has succeeded on STANDBY MODE.</b>

**NOTE** • When the interior portion has become overheated, for safety purposes, the projector is automatically shut down, and the indicator lamps may also be turned off. In such a case, disconnect the power cord, and wait at least 45 minutes. After the projector has sufficiently cooled down, please make confirmation of the attachment state of the lamp and lamp cover, and then turn the power on again.

## Resetting all settings

When it is hard to correct some wrong settings, the FACTORY RESET function of SERVICE item in OPTION menu (📖75) can reset all settings (except settings such as STANDBY MODE, AUTO BLANK, LANGUAGE, LAMP TIME, FILTER TIME, FILTER MESSAGE, SECURITY and NETWORK) to the factory default. Be sure to set ALTITUDE after resetting all the settings(📖68).

## Phenomena that may be easy to be mistaken for machine defects

About the phenomenon confused with a machine defect, check and cope with it according to the following table.

Phenomenon	Cases not involving a machine defect	Reference page
Power does not come on.	<b>The electrical power cord is not plugged in.</b> Correctly connect the power cord.	16
	<b>The main power source has been interrupted during operation such as by a power outage (blackout), etc.</b> Please disconnect the power plug from the power outlet, and allow the projector to cool down at least 10 minutes, then turn the power on again.	16, 21
	<b>Either there is no lamp and/or lamp cover, or either of these has not been properly fixed.</b> Please turn the power off and disconnect the power plug from the power outlet, and allow the projector to cool down at least 45 minutes. After the projector has sufficiently cooled down, please make confirmation of the attachment state of the lamp and lamp cover, and then turn the power on again.	100
Neither sounds nor pictures are outputted.	<b>The signal cables are not correctly connected.</b> Correctly connect the connection cables.	10 ~ 15
	<b>Signal source does not correctly work.</b> Correctly set up the signal source device by referring to the manual of the source device.	–
	<b>The input changeover settings are mismatched.</b> Select the input signal, and correct the settings.	25
	<b>The BLANK function for pictures and the MUTE function for sounds are working.</b> AV MUTE may be active. Refer to the item “Sound does not come out” and “No pictures are displayed” on the next page to turn off the MUTE and BLANK functions.	24

(continued on next page)



*Phenomena that may be easy to be mistaken for machine defects (continued)*

Phenomenon	Cases not involving a machine defect	Reference page
Sound does not come out.	<p><b>The signal cables are not correctly connected.</b> Correctly connect the audio cables.</p>	10 ~ 15
	<p><b>The MUTE function is working.</b> Restore the sound pressing the <b>VOLUME +/-</b> button on the remote control.</p>	24
	<p><b>The volume is adjusted to an extremely low level.</b> Adjust the volume to a higher level using the menu function or the remote control.</p>	24, 54
	<p><b>The AUDIO SOURCE/SPEAKER setting is not correct.</b> Correctly set the AUDIO SOURCE/SPEAKER in AUDIO menu.</p>	54
	<p><b>The Sound button (♫) or checkbox is disabled.</b> If you have selected <b>USB TYPE A</b>, turn the sound on from the Thumbnail menu. If you have selected <b>USB TYPE B</b>, put a check mark on the Sound checkbox in the Options window of “LiveViewer Lite for USB”. If you have selected <b>LAN</b>, put a check mark on the Sound checkbox in the Option menu of “LiveViewer”.</p>	85, 95, 99

(continued on next page)

*Phenomena that may be easy to be mistaken for machine defects (continued)*

Phenomenon	Cases not involving a machine defect	Reference page
No pictures are displayed.	<p><b>The signal cables are not correctly connected.</b> Correctly connect the connection cables.</p>	10 ~ 15
	<p><b>The brightness is adjusted to an extremely low level.</b> Adjust BRIGHTNESS to a higher level using the menu function.</p>	37
	<p><b>The computer cannot detect the projector as a plug-and-play monitor.</b> Make sure that the computer can detect a plug-and-play monitor using another plug-and-play monitor.</p>	11
	<p><b>The BLANK screen is displayed.</b> Press the <b>AV MUTE</b> button on the remote control.</p>	24
	<p><b>The projector does not recognize the USB storage device inserted into USB TYPE A port.</b> Before removing the USB storage device, be sure to use the REMOVE USB function on the thumbnail screen, which appears when the <b>USB TYPE A</b> port is selected as the input source.</p>	14
The remote control is not operating.	<p><b>"Waiting for connection." remains displayed even though the USB TYPE B port is selected.</b> Remove the USB cable and reconnect after a while.</p>	11
	<p><b>The projector is not receiving a signal from the remote control. (frequency)</b> See "REMOTE FREQ." under the SERVICE item in the OPTION menu and Changing the frequency of remote control signal. Set either of the following settings. 1. Set 1. NORMAL to ON and 2. HIGH to OFF. On the remote control, set the signal frequency mode to NORMAL. 2. Set 2. HIGH to ON and 1. NORMAL to OFF. On the remote control, set the signal frequency mode to HIGH.</p>	19, 70
<p><b>The projector is not receiving a signal from the remote control. (direction)</b> See "REMOTE RECEIV." under the SERVICE item in the OPTION menu. Change a remote sensor settings to FRONT or TOP.</p>	69	

(continued on next page)

**Phenomena that may be easy to be mistaken for machine defects (continued)**

Phenomenon	Cases not involving a machine defect	Reference page
Video screen display freezes.	<b>The FREEZE function is working.</b> Press the <b>FREEZE</b> button to restore the screen to normal.	31
Colors have a faded- out appearance, or Color tone is poor.	<b>Color settings are not correctly adjusted.</b> Perform picture adjustments by changing the COLOR TEMP, COLOR, TINT and/or COLOR SPACE settings, using the menu functions.	39, 44
	<b>COLOR SPACE setting is not suitable.</b> Change the COLOR SPACE setting to AUTO, RGB, SMPTE240, REC709 or REC601.	44
Pictures appear dark.	<b>The brightness and/or contrast are adjusted to an extremely low level.</b> Adjust BRIGHTNESS and/or CONTRAST settings to a higher level using the menu function.	37
	<b>The projector is operating in Eco mode.</b> Set ECO MODE to OFF, and set AUTO ECO MODE to OFF, in the SETUP menu.	51
	<b>The lamp is approaching the end of its product lifetime.</b> Replace the lamp.	100, 101
	<b>When the internal temperature is high (even if the ambient temperature is lower than 35°C), the brightness of lamp might be reduced automatically.</b> Please clean or replace the air filter.	102
Pictures appear blurry.	<b>Either the focus and/or horizontal phase settings are not properly adjusted.</b> Adjust the focus using the <b>FOCUS</b> button, and/or H PHASE using the menu function.	27, 43
	<b>The projection window is dirty or misty.</b> Clean the projection window referring to the section “Caring for the projection window”.	105
Some kind of image degradation such as flickering or stripes appear on screen.	<b>When the projector is operating in Eco mode, flickering may appear on screen.</b> Set ECO MODE to OFF, and set AUTO ECO MODE to OFF, in the SETUP menu.	51
	<b>The OVER SCAN ratio is too big.</b> Adjust OVER SCAN in the IMAGE menu smaller.	41
	<b>Excessive VIDEO NR.</b> Change the setting of VIDEO NR in the INPUT menu.	44
	<b>The FRAME LOCK function cannot work on the current input signal.</b> Set FRAME LOCK in the INPUT menu to OFF.	46

(continued on next page)

*Phenomena that may be easy to be mistaken for machine defects (continued)*

Phenomenon	Cases not involving a machine defect	Reference page
The sound or image is unstable or is output intermittently.	<b>When LAN, USB TYPE A or USB TYPE B port is selected, some ports of the output may be missing due to signal processing delay.</b> Change the signal or use another port.	25, 54
The computer connected to the <b>USB TYPE B</b> port of the projector does not start up.	<b>The computer cannot start up in the current hardware configuration.</b> Disconnect the USB cable from the computer, then reconnect it after starting up the computer.	11
RS-232C does not work.	<b>The SAVING function is working.</b> Select NORMAL for STANDBY MODE item in the SETUP menu.	53
	<b>The COMMUNICATION TYPE for the CONTROL port is set to NETWORK BRIDGE.</b> Select OFF for COMMUNICATION TYPE item in the OPTION - SERVICE - COMMUNICATION menu.	71
Network does not work	<b>The SAVING function is working.</b> Select NORMAL for STANDBY MODE item in the SETUP menu.	53
	<b>The same network address is set for both wireless and wired LAN.</b> Change the network address setting for wireless or wired LAN.	—
NETWORK BRIDGE function does not work	<b>The NETWORK BRIDGE function is turned off.</b> Select NETWORK BRIDGE for COMMUNICATION TYPE item in the OPTION - SERVICE - COMMUNICATION menu.	71
Schedule function does not work	<b>The SAVING function is working.</b> Select NORMAL for STANDBY MODE item in the SETUP menu.	53
	<b>The internal clock has been reset.</b> When you do not install the battery, once you turn off the projector in the SAVING mode or the AC power, the current date and time setting is reset. Check the DATE AND TIME setting for WIRELESS SETUP or WIRED SETUP in the NETWORK menu or install the batteries.	—

(continued on next page)

**Phenomena that may be easy to be mistaken for machine defects (continued)**

Phenomenon	Cases not involving a machine defect	Reference page
<p>When the projector is connected to wired LAN, it powers off and on as described below.</p> <p>Powers off ←</p> <p>↓</p> <p><b>POWER</b> indicator blinks in orange a few times</p> <p>↓</p> <p>Goes into standby mode</p>	<p><b>Disconnect the LAN cable and check that the projector is working properly.</b></p> <p>If this phenomenon occurs after connecting to the network, there may be a loop between two Ethernet switching hubs within the network, as explained below.</p> <ul style="list-style-type: none"> <li>- There are two or more Ethernet switching hubs in a network.</li> <li>- Two of the hubs are doubly connected by LAN cables.</li> <li>- This double connection forms a loop between the two hubs.</li> </ul> <p>Such a loop may have an adverse effect on the projector as well as the other network devices.</p> <p>Check the network connection and remove the loop by disconnecting the LAN cables such that there is only one connecting cable between two hubs.</p>	<p>—</p>
<p>Unable to save the CLONING data.</p>	<p><b>USB memory is out of memory.</b></p> <p>Please delete unnecessary files to free up memory. At least 1MB of memory is needed.</p> <p>USB memory is write-protected.</p> <p>Unlock the USB memory.</p>	
<p>Unable to load the CLONING saved data.</p>	<p><b>Unable to find the saved data from USB memory.</b></p> <p>Execute SAVE then LOAD by going through the procedure.</p> <p>File name of USB memory doesn't match.</p> <p>Please assign "pj_data.bin" for setting data, and for MyScreen "pj_logo.bmp" or "pj_logo.gif".</p> <p>STANDBY mode is set to SAVING.</p> <p>Switch the SAVING to NORMAL in STANDBY MODE under SET UP menu beforehand to load the CLONING data using control panel on the projector while the lamp is in standby state.</p>	<p>72 ~ 75</p>

**NOTE** • Although bright spots or dark spots may appear on the screen, this is a unique characteristic of liquid crystal displays, and it does not constitute or imply a machine defect.

## Specifications

Please see the **Specifications** in the **User's Manual (concise)** which is a book.

### **End User License Agreement for the Projector Software**

- Software in the projector consists of the plural number of independent software modules and there exist our copyright or/and third party copyrights for each of such software modules.
- Be sure to read “End User License Agreement for the Projector Software” which is separated document.

### **Trademark acknowledgment**

- Mac<sup>®</sup>, OS X<sup>®</sup> and macOS<sup>®</sup> are registered trademarks of Apple Inc. in the U.S. and/or other countries.
- Windows<sup>®</sup> and Internet Explorer<sup>®</sup> are registered trademarks of Microsoft Corporation in the U.S. and/or other countries.
- VESA and DDC are trademarks of the Video Electronics Standard Association.
- HDMI<sup>®</sup>, HDMI High-Definition Multimedia Interface<sup>®</sup> and HDMI<sup>®</sup> logo are trademarks or registered trademarks of HDMI Licensing Administrator, Inc. in the United States and other countries.
- Trademark PJLink is a trademark applied for trademark rights in Japan, the United States of America and other countries and areas. 
- Blu-ray Disc<sup>™</sup> and Blu-ray<sup>™</sup> are trademarks of Blu-ray Disc Association.
- DICOM<sup>®</sup> is the registered trademark of the National Electrical Manufacturers Association for its standards publications relating to digital communications of medical information.

All other trademarks are the properties of their respective owners.