

LCD Projector

MP-WU8801W/MP-WU8801B

MP-WU8701W/MP-WU8701B

User's Manual (detailed) Operating Guide

Thank you for purchasing this projector.

⚠ WARNING ▶ Before using this projector, read all the manuals for this projector. Read **Safety Guide** first. After reading the manuals, store them in a safe place for future reference.

About this manual

Various symbols are used in this manual. The meanings of these symbols are described below.

⚠ WARNING This symbol indicates information that, if ignored, could possibly result in personal injury or even death due to incorrect handling.

⚠ CAUTION This symbol indicates information that, if ignored, could possibly result in personal injury or physical damage due to incorrect handling.

NOTICE This entry notices of fear of causing trouble.



Refer to the pages written following this symbol.

NOTE • The information in this manual is subject to change without notice.

- The illustrations in this manual are for illustrative purposes. They may differ from your projector.
- The manufacturer assumes no responsibility for any errors that may appear in this manual.
- The reproduction, transfer or copy of all or any part of this document is not permitted without express written consent.

Trademark acknowledgment

- VESA and DDC are trademarks of the Video Electronics Standard Association.
- HDMI™, the HDMI logo, and High-Definition Multimedia Interface are trademarks or registered trademarks of HDMI Licensing LLC in the United States and other countries.
- Trademark PJLink is a trademark applied for trademark rights in Japan, the United States of America and other countries and areas.
- Blu-ray Disc™ and Blu-ray™ are trademarks of Blu-ray Disc Association.
- DICOM® is the registered trademark of the National Electrical Manufacturers Association for its standards publications relating to digital communications of medical information.
- HDBaseT™ and the HDBaseT Alliance logo are trademarks of the HDBaseT Alliance.
- DisplayPort™ is trademark owned by the Video Electronics Standards Association (VESA®) in the United States and other countries.

All other trademarks are the properties of their respective owners.

PJLink™

Contents



Introduction	3	EASY MENU	57
Features	3	PICTURE menu	59
Checking the contents of package	3	IMAGE menu	63
Part names	4	INPUT menu	66
Projector, Control panel and Indicators, Ports, Remote control		SETUP menu	72
Setting up	8	AUDIO menu	80
Arrangement	10	SCREEN menu	81
Connecting with your devices	13	OPTION menu	87
Fastening the cables	24	NETWORK menu	105
Attaching the terminal cover	25	SECURITY menu	106
Using the security bar and slot	26	Maintenance	113
Connecting to a power supply	27	Cleaning and replacing the air filter ..	113
Remote control	28	Inserting or replacing the internal clock battery	115
Installing the batteries	28	Other care	116
Using the REMOTE ID function	29	Troubleshooting	118
Changing the frequency of remote control signal ..	29	Related messages	118
About the remote control signal	30	Regarding the indicator lamps	121
Power on/off	31	Resetting all settings	126
Turning on the power	31	Issues that may be easy to be mistaken for machine defects ..	127
Turning off the power	31	Specifications	136
Operating	33		
Adjusting the volume	33		
Temporarily turning off the screen and audio ..	33		
Selecting an input signal	34		
Selecting an aspect ratio	35		
Limiting OSD display	36		
Adjusting the projector's elevator	37		
Adjusting the lens	38		
Adjusting the zoom and focus, Adjusting the lens position, Lens memory ..			
Correcting the distortion	41		
Using the EDGE BLENDING features ..	44		
Using the magnify feature	48		
Temporarily freezing the screen	49		
Temporarily shading the screen	49		
PbyP (Picture by Picture) / PinP (Picture in Picture) ..	50		
Using the menu function	54		
Indication in OSD, Menu items			

Introduction

Features

The projector provides you with the broad use by the following features.

- ✓ The HDMI™/DisplayPort™/HDBaseT™ ports can support various image equipment which have digital interface to get clearer pictures on a screen.
- ✓ The super bright light source and high quality optical system can fulfill the demands of professional uses.
- ✓ Optional lens units and a wide range of the lens shift feature provide more flexibility in where you can install the projector.
- ✓ The multiple I/O ports is believed to support any business scene.
- ✓ HDCR and ACCENTUALIZER features are original image stabilizer for a clearer image.
- ✓ A DICOM® (“Digital Imaging and Communication in Medicine”) provides simulation mode. This mode simulates the DICOM standard, which is a standard applicable to digital communications in medicine.
- ✓ COLOR MANAGEMENT corrects an image by dividing it into three-dimensional space such as color phase, color saturation, and brightness.

Checking the contents of package

See the **Contents of package** section in the **User’s Manual (concise)** which is a book. Your projector should come with the items shown there. Consult your dealer immediately if any items are missing.

⚠ WARNING ► Keep small parts away from children and pets. Take care not to put in the mouth. If swallowed, consult a physician immediately for emergency treatment.

NOTE • Keep the original packing materials for future shipment. Use the original packing materials when moving the projector. Remove the lens unit and attach the lens hole cover when moving the projector.

Part names

Projector

- (1) Filter cover ([113](#))
The air filter and intake vent are inside.
- (2) Elevator feet (x2) ([37](#))
- (3) Remote sensors (x2) ([30, 99](#))
- (4) Lens hole cover
- (5) Indicators ([5](#))
- (6) Intake vents
- (7) Control panel ([5](#))
- (8) AC (AC inlet) ([27](#))
- (9) Exhaust vents
- (10) Ports ([6](#))
- (11) Security bar ([26](#))
- (12) Security slot ([26](#))
- (13) Safety bar ([26](#))
- (14) Battery cover ([115](#))

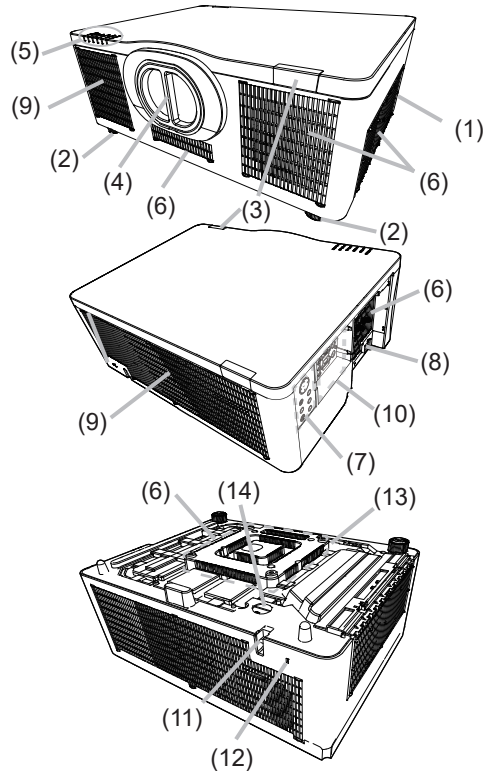

⚠ WARNING ▶ Do not open or remove any portion of the projector, unless the manuals direct it.

▶ Do not subject the projector to unstable conditions.

▶ Do not apply a shock or pressure to this projector. Remove all the attachments including the power cord and cables, from the projector when carrying the projector.

▶ Do not look into the lens and the openings on the projector while the light source is on as the projection ray may cause a trouble on your eyes.

▶ Keep any object away from concentrated projection light beam. Blocking the beam causes high temperature and could result in fire or smoke.

⚠ CAUTION ▶ Do not touch around the exhaust vents during use or just after use, since it is too hot.

▶ Do not attach anything onto the lens except the lens cover of this projector because it could damage the lens, such as melting the lens.



(continued on next page)

Part names (continued)**Control panel and Indicators**

- (1) **STANDBY/ON** button (📖31)
- (2) **INPUT** button (📖34, 54)
- (3) **MENU** button (📖54)
- (4) **LENS SHIFT** button (📖39)
- (5) **ZOOM** button (📖38)
- (6) **FOCUS** button (📖38)
- (7) **SHUTTER** button (📖49)
- (8) **SERVICE** indicator (📖124, 125)
- (9) **STATUS** indicator (📖122 ~ 124)
- (10) **FILTER** indicator (📖123)
- (11) **LIGHT** indicator (📖124)
- (12) **TEMP** indicator (📖123 ~ 125)
- (13) **POWER** indicator (📖31, 121 ~ 125)

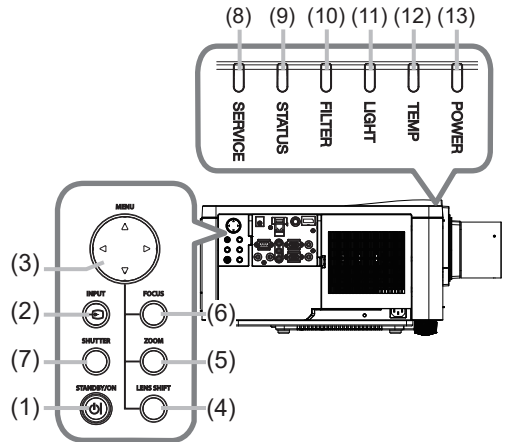

(continued on next page)

Part names (continued)

Ports (13 ~ 23)

- (1) **COMPUTER IN** port
- (2) **HDBaseT** port
- (3) **LAN** port
- (4) **WIRELESS** port
- (5) **HDMI 1** port
- (6) **HDMI 2** port
- (7) **DisplayPort** port
- (8) **VIDEO** port
- (9) **3G-SDI** port (MP-WU8801W/MP-WU8801B)
- (10) **AUDIO IN1** port
- (11) **AUDIO IN2 (L, R)** ports
- (12) **AUDIO OUT** port
- (13) **MONITOR OUT** port
- (14) **REMOTE CONTROL IN** port
- (15) **REMOTE CONTROL OUT** port
- (16) **CONTROL** port
- (17) **HDMI OUT** port

MP-WU8701W/MP-WU8701B

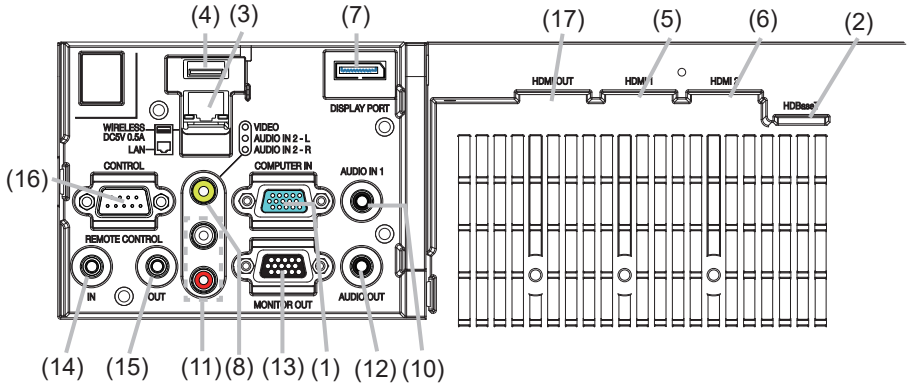

MP-WU8801W/MP-WU8801B

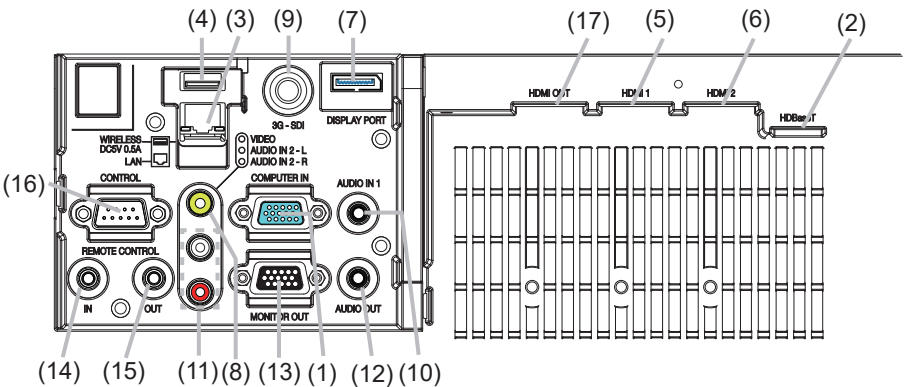

Part names (continued)

Remote control

-
- (1) **STANDBY** button ([131](#))
- (2) **ON** button ([131](#))
- (3) **ID - 1 / 2 / 3 / 4** buttons ([129](#))
- (4) **COMPUTER 1** button ([134](#))
- (5) **COMPUTER 2** button *1
- (6) **VIDEO** button ([134](#))
- (7) **LAN** button ([134](#))
- (8) **USB TYPE A** button *1
- (9) **USB TYPE B** button *1
- (10) **HDMI 1** button ([134](#))
- (11) **HDMI 2** button ([134](#))
- (12) **DisplayPort** button ([134](#))
- (13) **HDBaseT** button ([134](#))
- (14) **SDI** button ([134](#))
- (Supported only for MP-WU8801W/MP-WU8801B)
- (15) **DIGITAL** button *1
- (16) **FOCUS + / -** buttons ([138](#))
- (17) **ZOOM + / -** buttons ([138](#))
- (18) **AV MUTE** button ([133](#))
- (19) **LENS MEMORY LOAD / SAVE** buttons ([140](#))
- (20) **SHIFT** button ([139](#))
- (21) **OSD MSG** button ([136](#))
- (22) **▲ / ▼ / ◀ / ▶** cursor buttons
- (23) **ENTER** button ([154](#))
- (24) **RESET** button ([154](#))
- (25) **MENU** button ([154](#))
- (26) **GEOMETRY** button ([141](#))
- (27) **PICTURE** button ([160 ~ 162](#))
- (28) **NETWORK** button
- (29) **INTERACTIVE** button *2
- (30) **FREEZE** button ([149](#))
- (31) **PbyP** button ([150](#))
- (32) **MAGNIFY ON / OFF** buttons ([148](#))
- (33) **VOLUME + / -** buttons ([133](#))
- (34) **INFO** button (35) **ASPECT** button ([135](#))
- (36) **MY BUTTON - 1 / 2 / 3 / 4** buttons ([190, 191](#))
- (37) Battery cover ([128](#)) (38) Wired remote control port ([121](#)) (38)

NOTE • When you press the button marked with *1, the input signal selection menu is displayed.

- Any button marked with *2 is not supported on this projector ([120](#)).
- Each time you press any button (except ID buttons), the ID button of current selected ID number lights ([129](#)).

Setting up

Install the projector according to the environment and manner the projector will be used in.

This projector will perform in a free tilt angle, as shown in the figures below.

For the case of installation in a special state such as ceiling mount, the specified mounting accessories and service may be required. Before installing the projector, consult your dealer about your installation.

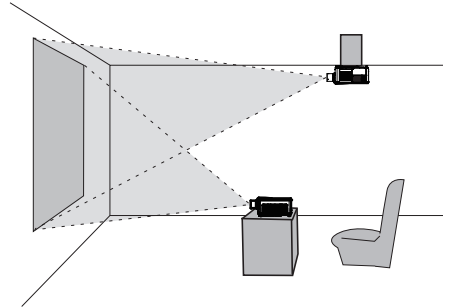

Horizontal 360°

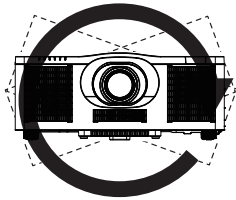

Vertical 360°

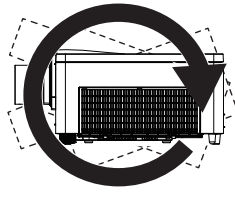

Tilt 360°
(combination of
horizontal and vertical)

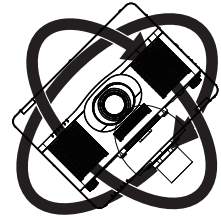

Setting up (continued)

Secure a clearance of 30 cm or greater between the intake vents of the projector and other objects such as walls. There are intake vents on the left and right sides.

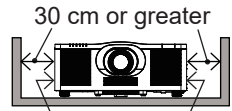

Secure a clearance of 50 cm or greater between the exhaust vents of the projector and other objects such as walls. There are exhaust vents on the back side.

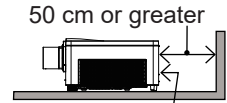

When installing the projectors side by side, secure a clearance of 50 cm or greater between both projectors.

Assume that there is enough clearance in the front and top of the projector.

These also apply to the portrait mode installation.

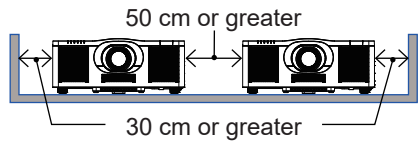

Installing the lens unit

See the manual of the optional lens.

Arrangement

Refer to table **T-2** at the back of **User's Manual (concise)** as well as the following to determine the screen size and projection distance. The values shown in the table are calculated for a full size screen.

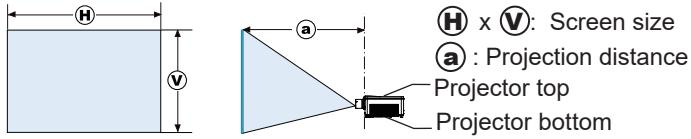

(continued on next page)

Arrangement (continued)

⚠ WARNING ▶ Install the projector where you can access the power outlet easily. If an abnormality should occur, unplug the projector immediately. Otherwise it could cause a fire or electric shock.

▶ Do not subject the projector to unstable conditions. If the projector falls or topples over, it could result in injury or damage to the projector and the surrounding things. Using a damaged projector could result in a fire and an electric shock.

- Do not place the projector in unstable places, such as an inclined surface, places subject to vibration, on top of a wobbly table or cart, or a surface that is smaller than the projector.
- Do not put the projector on its side, front or rear position.
- Do not attach nor place anything on the projector unless otherwise specified in the manual.
- Do not use any mounting accessories except the accessories specified by the manufacturer. Read and keep the manuals of the accessories used.
- For special installation such as ceiling mounting, be sure to consult your dealer beforehand.
- You can install the projector for any direction with specified mounting accessories. Consult with your dealer about such a special installation.
- Remove all the attachments including the power cord and cables, from the projector when carrying the projector.

▶ Do not install the projector near thermally conductive or flammable things. Such things when heated by the projector could result in a fire and burns.

- Do not place the projector on a metal stand.

▶ Do not place the projector where any oils, such as cooking or machine oil, are used. Oil may harm the projector, resulting in malfunction, or falling from the mounted position. Do not use adhesive such as threadlocker, lubricant and so on.

▶ Do not place the projector in a place where it may get wet. Getting the projector wet or inserting liquid into the projector could cause a fire and an electric shock, and damage the projector.

- Do not place the projector near water, such as in a bathroom, kitchen, or poolside.
- Do not place the projector outdoors or by the window.
- Do not place anything containing liquid near the projector.

▶ Do not block the intake vents and exhaust vents of the projector. If the intake vents and exhaust vents of the projector are blocked, the accumulated inside heat may cause fire.

(continued on next page)

Arrangement (continued)

⚠ CAUTION ▶ Place the projector in a cool place with sufficient ventilation. The projector may shutdown automatically or may malfunction if its internal temperature is too high.

Using a damaged projector could result in a fire and an electric shock.

- Do not place the projector in direct sunlight or near hot objects such as heaters.
- Do not place the projector where the air from an air conditioner or similar unit directly blows on it.
- Do not place the projector on carpet, cushions or bedding.
- Do not stop up, block nor cover the projector's vent holes. Do not place anything around the projector that could be sucked in or stuck to the projector's intake vents.
- Do not place the projector at places that are exposed to magnetic fields, doing so can cause the cooling fans inside the projector to malfunction.

▶ Avoid placing the projector in smoky, humid or dusty place. Placing the projector in such places could cause a fire, an electric shock and malfunction of the projector.

- Do not place the projector near humidifiers. Especially for an ultrasonic humidifier, chlorine and minerals contained in tap water are atomized and could be deposited in the projector causing image degradation or other problems.
- Do not place the projector in a smoking area, kitchen, passageway or by the window.

NOTICE • Position the projector to prevent light from directly hitting the projector's remote sensor.

- Positional deviation or distortion of a projected image, or shift of the focus may occur due to ambient conditions, and so on. They tend to occur until the operation becomes stable, especially within about 30 minutes after the light source is turned on. Check and readjust them as necessary.
- Do not place the projector in a place where radio interference may be caused.
- Keep heat-sensitive things away from the projector. Otherwise, they may be damaged by the heat from the projector.

NOTE • When the ambient temperature is around 35 to 45°C, the brightness of light source is reduced automatically.

Connecting with your devices

Before connecting the projector to a device, consult the manual of the device to confirm that the device is suitable for connecting with this projector and prepare the required accessories, such as a cable in accord with the signal of the device. Consult your dealer when the required accessory did not come with the projector or the accessory is damaged.

After making sure that the projector and the devices are turned off, perform the connection, according to the following instructions. Refer to the figures in subsequent pages.

Before connecting the projector to a network system, read **Network Guide** too.

⚠ WARNING ▶ **Use only the appropriate accessories.** Otherwise it could cause a fire or damage the projector and devices.

- Use only the accessories specified or recommended by the projector's manufacturer. It may be regulated under some standard.
- Neither disassemble nor modify the projector and the accessories.
- Do not use the damaged accessory. Be careful not to damage the accessories. Route a cable so that it is neither stepped on nor pinched out.

⚠ CAUTION ▶ **For a cable with a core at only one end, connect the end with the core to the projector.** That may be required by EMI regulations.

NOTE • Do not turn on or off the projector while connected to a device in operation, unless directed in the manual of the device. Otherwise it may cause malfunction in the device or projector.

- The function of some input ports can be selected according to your requirements. Check the reference page indicated beside each port in the following illustration. (📖 14 ~ 23)
- Be careful not to mistakenly connect a connector to a wrong port. Otherwise it may cause malfunction in the device or projector.
 - When connecting a connector to a port, make sure that the shape of the connector fits the port.
 - Tighten the screws to connect a connector equipped with screws to a port.
 - Use the cables with straight plugs, not L-shaped ones, as the input ports of the projector are recessed.

About Plug-and-Play capability

- Plug-and-Play is a system composed of a computer, its operating system and peripheral equipment (such as display devices). This projector is VESA DDC 2B compatible. Plug-and-Play can be used by connecting this projector to a computer that is VESA DDC (display data channel) compatible.
 - Take advantage of this feature by connecting a computer cable to the **COMPUTER IN** port (DDC 2B compatible). Plug-and-Play may not work properly if any other type of connection is attempted.
 - Use the standard drivers in your computer as this projector is a Plug-and-Play monitor.

(continued on next page)

Connecting with your devices (continued)

MP-WU8701W/MP-WU8701B

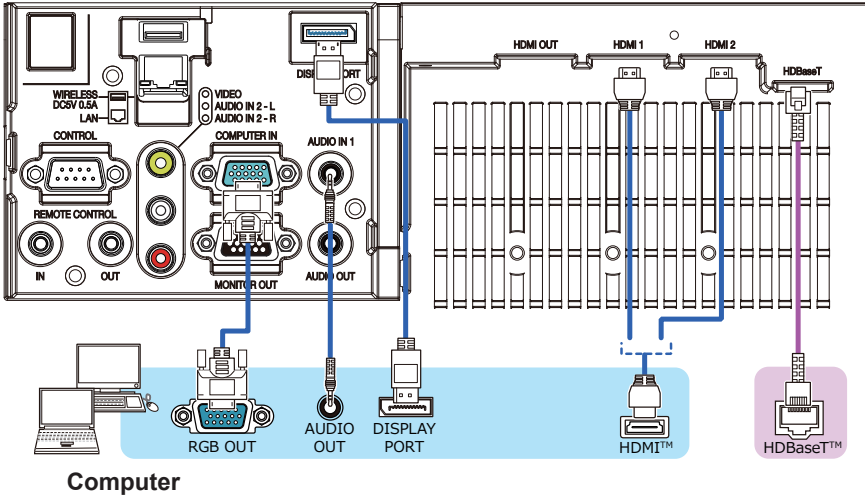

MP-WU8801W/MP-WU8801B

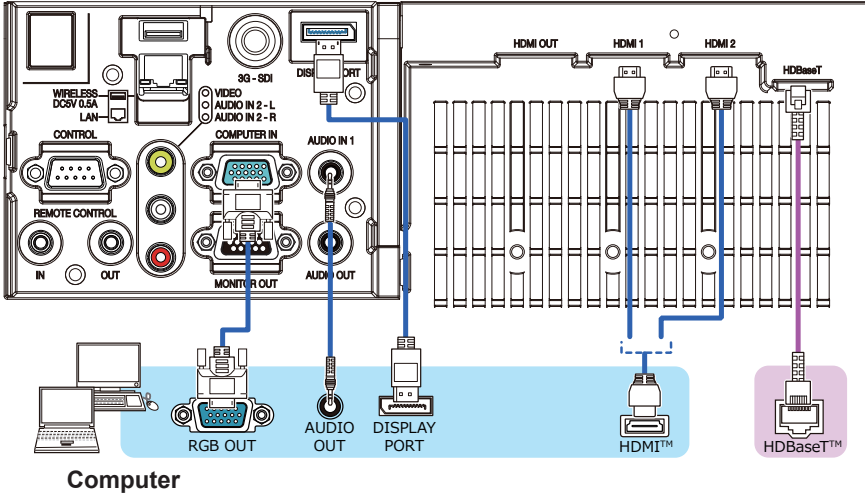

(continued on next page)

Connecting with your devices (continued)

- NOTE** • Before connecting the projector to a computer, consult the computer's manual and check the compatibility of the signal level, the synchronization methods and the display resolution output to the projector.
- Some signal may need an adapter to input this projector.
 - Some computers have multiple screen display modes that may include some signals which are not supported by this projector.
 - Although the projector can display signals with a resolution up to 4K (4096x2160), the signal is converted to the projector's panel resolution before being displayed. The best display performance is achieved if the resolutions of the input signal and the projector panel are identical.
 - If you connect this projector and a notebook computer, you must output the display to an external monitor, or output simultaneously to the internal display and an external monitor. Consult the computer's manual for the setting.
 - Depending on the input signal, the automatic adjustment function of this projector may take some time and not function correctly.
 - A composite sync signal or sync-on-green signal may confuse the automatic adjustment function of this projector (📖 69).
 - If the automatic adjustment function does not work correctly, you may not see the dialog to set the display resolution. In such a case, use an external display device. You may see the dialog and set an appropriate display resolution.
 - Use DisplayPort cables conforming to the DisplayPort standard.
 - Use of DisplayPort cables not conforming to the DisplayPort standard may cause abnormal operations such as images with interruption or not displayed.
 - When the projector is connected to the output of the computer with an early type of chipset or graphics card that supports the DisplayPort, the projector and/or computer may not operate normally. In that case, turn off the projector and/or computer, then turn on again.
 - When connecting the output of the DisplayPort to the input of the projector, use of the computer with the newest chipset or graphics card is recommended.
 - Commercially available DisplayPort cables may have a lock system. When unplugging the cable, push the button on the connector of the cable.
 - Some computers may take a long time to display the image.
 - Power supply is available to the connected device with the input port of DisplayPort. However, it is not available to the computer.
 - When the signal from the device with a signal converting adapter is connected to the input port of DisplayPort, the image may not be displayed.
 - Use a commercially available converter when connecting the output port of HDMI of the computer with the input port of DisplayPort of the projector.

(continued on next page)

Connecting with your devices (continued)

MP-WU8701W/MP-WU8701B

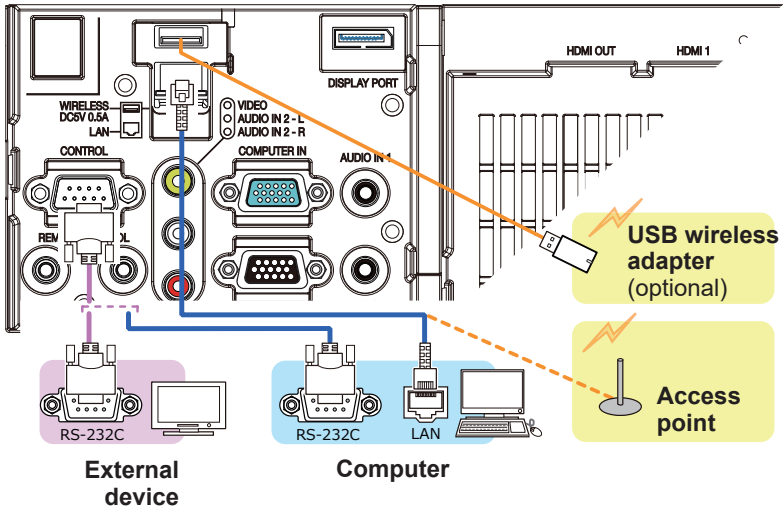

MP-WU8801W/MP-WU8801B

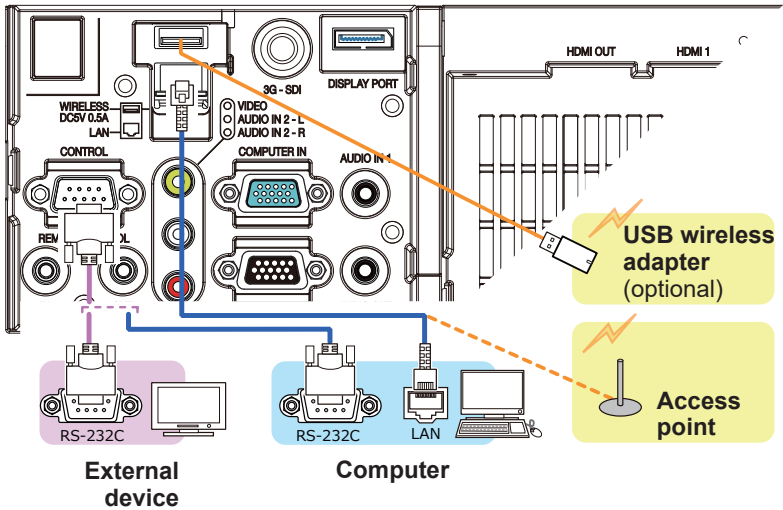

(continued on next page)

Connecting with your devices (continued)

⚠ **WARNING** ▶ Heat may build up in the USB wireless adapter, to avoid possible burns disconnect the projector power cord for 10 minutes before touching the adapter.

⚠ **CAUTION** ▶ Before connecting the projector to a network system, obtain the consent of the administrator of the network.

▶ Do not connect the **LAN** port to any network that might have the excessive voltage.

▶ The designated USB wireless adapter sold as an option is required to use the wireless network function of this projector. Before connecting the USB wireless adapter, turn off the power of the projector and disconnect the power cord. Do not use any extension cable or device when connecting the adapter to the projector.

▶ To connect both the LAN cable and USB wireless adapter to the projector, use a LAN cable that is flat on the side where the plug's wire is visible. Otherwise, both of them cannot be connected correctly, or the wire may break (malfunction).

(continued on next page)

Connecting with your devices (continued)

About HDBaseT™ connection

- HDBaseT is a technology to transmit image, sound, ethernet or serial control signal using a LAN cable.
- LAN or HDBaseT input port can be selected as ethernet signal input by switching in the menu.
- Use LAN cables of up to 100m long. Up to 70m long for 4K signal. Exceeding this length, the image and sounds are deteriorated, and even experience malfunction on LAN transmission.

NOTE • The **HDMI** ports of this model are compatible with HDCP (High-bandwidth Digital Content Protection) and therefore capable of displaying video signals from HDCP compatible DVD players or the like.

- The **HDMI** ports support the following signals:

For Video signals, refer to User's Manual (detailed) Technical.

Audio signal : Format Linear PCM

Sampling frequency 48kHz / 44.1kHz / 32kHz

- This projector can be connected with another equipment that has HDMI™ connector, but with some equipment the projector may not work properly, something like no video.
- Qualified cable is required for HDBaseT connection.
- Use an HDMI™ cable that has the HDMI™ logo.
- Use a Category 2-certified HDMI™ cable to input 1080p@50/60 signal to the projector.
- When the projector is connected with a device having DVI connector, use a DVI to HDMI™ cable to connect with the HDMI™ input.
- The HDMI™ cables might come off due to the lack of a mechanical lock on the cables and connectors. Fasten the HDMI cables by using the HDMI cable holder and the Cable tie to prevent them from coming off ( 24).

(continued on next page)

Connecting with your devices (continued)

- NOTE** • This projector has HDMI input/output ports and can be connected to multiple devices such as projectors or monitors with HDMI cable.
- The projected image is output when HDMI 1 or HDBaseT is selected.
 - The resolution of the signal input to the projector and signal output from the projector may be restricted by the maximum resolution of the connected device such as projector or monitor.
 - HDMI output operation in normal standby depends on the setting of the menu (📖79). It is not output when standby mode is NETWORK(WOL) or SAVING.
 - When outputting HDMI signal, turn on the output side connected device before inputting image signal to the projector.
 - Up to 4 devices can be connected in series for HDMI output port of this projector.
 - The number of devices that can be connected varies depending on HDCP version, the restriction of the number of devices for HDCP repetition of source device, and the quality of a cable.
 - The projected image from the projector may be interrupted when POWER OFF/ON, input switching, or HDMI cable removal/insertion is executed on the second or subsequent projector or monitor.
 - HDMI output may be interrupted when the projector is turned on/off.

(continued on next page)

Connecting with your devices (continued)

MP-WU8701W/MP-WU8701B

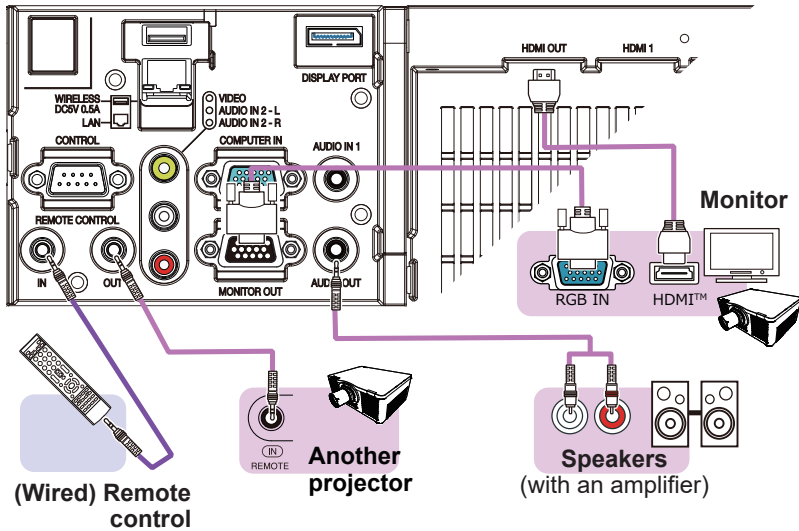

MP-WU8801W/MP-WU8801B

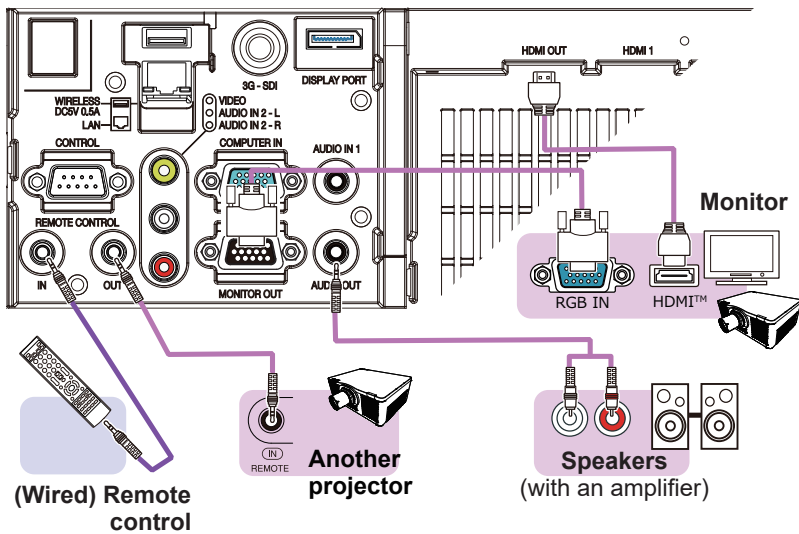

(continued on next page)

Connecting with your devices (continued)

NOTE • To use a wired remote control, connect a wired remote control to the **REMOTE CONTROL IN** port. You can also connect another projector to the **REMOTE CONTROL OUT** port to control it from the wired remote control. You can use this projector as a remote control-relay with the **REMOTE CONTROL IN** and **OUT** ports. To connect the wired remote control or another projector to the **REMOTE CONTROL IN** or **OUT** ports, use audio cables with 3.5 mm diameter stereo mini plugs. This function is useful when a wireless remote signal may not reliably reach the projector.

- The signal received in a remote sensor and the remote control signal input from HDBaseT™ are also output from **REMOTE CONTROL OUT**.
- The projector may not be operated correctly if they are operated from multiple remote controls at the same time.

(continued on next page)

Connecting with your devices (continued)

MP-WU8801W/MP-WU8801B

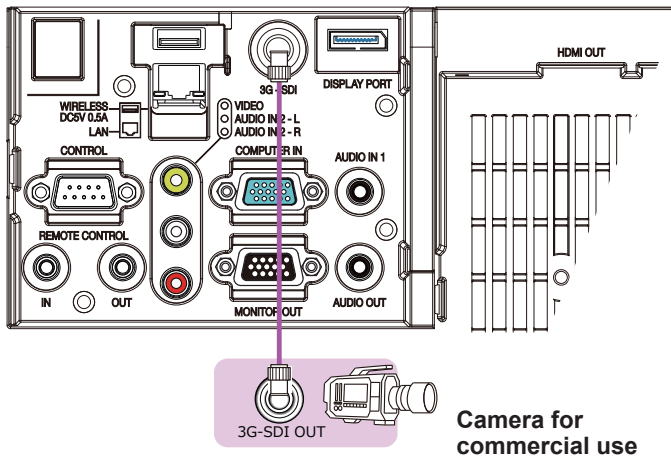

NOTE • The **3G-SDI** port of this model supports the following SDI signals:

- SD-SDI signal: conforming to SMPTE ST 259-C standard
 - YCBCR 4:2:2 10-bit
 - 480i, 576i
- Single link HD-SDI signal: conforming to SMPTE ST 292 standard
 - YPBPR 4:2:2 10-bit
 - 720p@50/60, 1080i@50/60, 1080sf@25/30
- 3G-SDI Level-A signal: conforming to SMPTE ST 424 standard
 - YPBPR 4:2:2 10-bit
 - 1080p@50/60

- This projector can be connected with other equipment that has SDI connector, but with some equipment the projector may not work properly.
- Use a cable of 5CFB or greater (5CFB, 7CFB, and so on), or Belden 1694A or greater to transmit the image properly. Use a cable with a length of 100m or less.
- Setting by MENU is necessary depending on a connected device.

Fastening the cables

Use the supplied cable tie to fasten the HDMI cable.

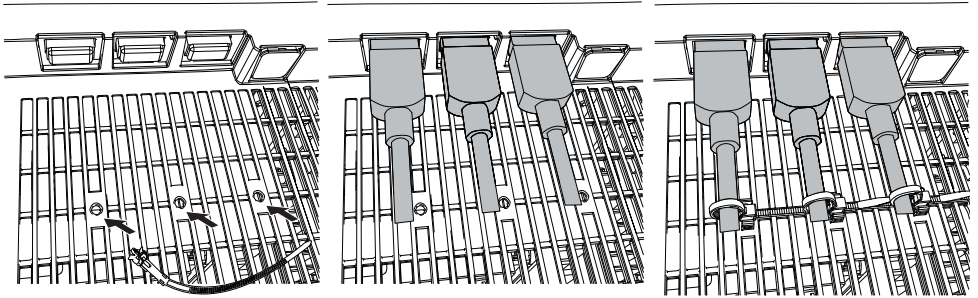

⚠ WARNING ▶ Do not fasten the cables other than HDMI.

⚠ CAUTION ▶ To fasten the cable, use a supplied cable tie.
▶ Do not bind the cables too tightly. The cables or the hole might be damaged.

Attaching the terminal covers

Two types of terminal covers for the ports side of the projector are available. The smaller one is the cover for the left part. The larger one is the cover for the right part.

To attach the terminal cover, insert the two claws of the cover into the hole on the projector and fasten the cover with the hook.

To detach the terminal cover, while pushing lightly the hook in the direction of arrow in the figure, pull it toward you.

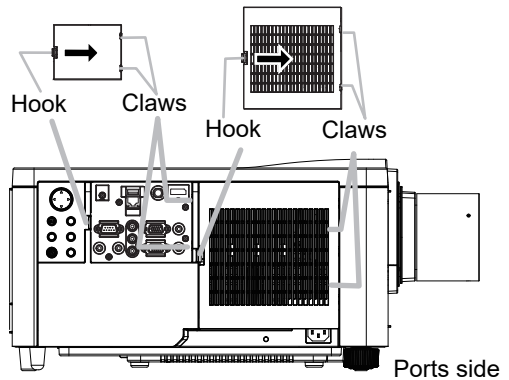

Using the security bar and slot

A commercially available anti-theft chain or wire can be attached to the security bar on the projector. Refer to the figure to choose an anti-theft chain or wire.

This projector has the security slot for the Kensington lock.

For details, see the manual of the security tool.

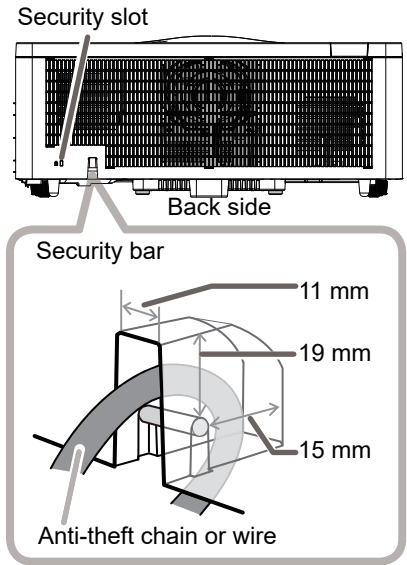

⚠ WARNING ► Do not use the security bars and slot to prevent the projector from falling down, as it is not designed for it.

⚠ CAUTION ► Do not place anti-theft chain or wire near the exhaust vents. It may become too hot.

NOTE • The security bar and slot is not comprehensive theft prevention measures. It is intended to be used as supplemental theft prevention measure.
• The safety bar (📖4) can be used for the same purpose as the security bar.

Connecting to a power supply

1. Put the connector of the power cord into the **AC** (AC inlet) of the product.
2. Firmly plug the power cord's plug into the outlet. In a couple of seconds after the power supply connection, the **POWER** indicator lights up in steady orange. When the **DIRECT POWER ON** function is activated, the connection of the power supply make the projector turn on. When the **AUTO POWER ON** function is activated and the projector is receiving an input signal, it is turned on by connecting to the power supply.
3. Use the supplied cable tie (for power cord) to fasten the power cord.

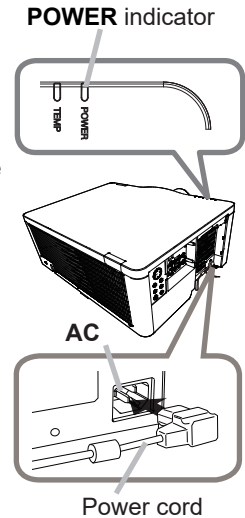
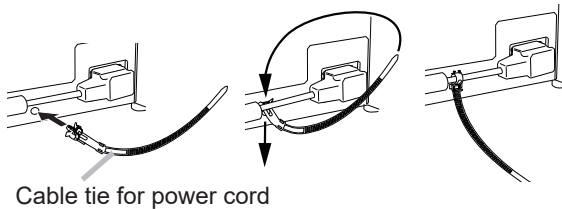

⚠ WARNING ▶ Do not connect the projector to a power supply while no lens unit is attached to it.

▶ Use extra caution when connecting the power cord, as incorrect or faulty connections may result in fire and/or electrical shock.

- Do not touch the power cord with a wet hand.
- Only use the power cord that came with the projector. If it is damaged, consult your dealer to get a new one. Never modify the power cord.
- Only plug the power cord into an outlet whose voltage is matched to the power cord. The power outlet should be close to the projector and easily accessible. Remove the power cord for complete separation.
- Do not distribute the power supply to multiple devices. Doing so may overload the outlet and connectors, loosen the connection, or result in fire, electric shock or other accidents.
- Do not press the main body of projector on the power cord.
- Connect the ground terminal for the AC inlet of this unit to the ground terminal of the building using an appropriate power cord (bundled).

NOTICE • This projector is also designed for IT power systems with a phase-to-phase voltage of 220 to 240 V.

Remote control

Installing the batteries

Insert the batteries into the remote control before using it.

Use the appropriate AA carbon-zinc or alkaline batteries (non-rechargeable) in accordance with laws and regulations.

If the remote control starts to malfunction, try to replace the batteries. If you will not use the remote control for long period, remove the batteries from the remote control and store them in a safe place.

1. Remove the battery cover.
2. Align and insert the two AA batteries according to their plus and minus terminals as indicated in the remote control.
3. Put the battery cover back to the former state.

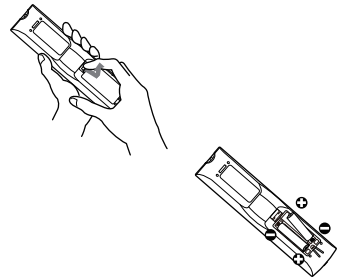

⚠ WARNING ► Always handle the batteries with care and use them only as directed. Improper use may result in battery explosion, cracking or leakage, which could result in fire, injury and/or pollution of the surrounding environment.

- Be sure to use only the batteries specified. Do not use batteries of different types at the same time. Do not mix a new battery with used one.
- Make sure the plus and minus terminals are correctly aligned when loading a battery.
- Keep a battery away from children and pets.
- Do not recharge, short circuit, solder or disassemble a battery.
- Do not place a battery in a fire or water. Keep batteries in a dark, cool and dry place.
- If you observe battery leakage, wipe out the leakage and then replace a battery. If the leakage adheres to your body or clothes, rinse well with water immediately.
- Obey the local laws on disposing the battery.

Using the REMOTE ID function

Use this function to control specific projectors by the remote control assigned the same ID number when you use multiple projectors of the same type at the same time.

Assign an ID number to each projector before using the REMOTE ID item in the SERVICE menu of the OPTION menu (☞99). Press the **ID** button with the same ID number as assigned to the projector you are going to control. The **ID** button selected lights for several seconds.

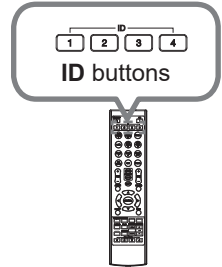

- NOTE**
- Each time you press any button (except **ID** buttons), the **ID** button of current selected ID number lights.
 - To confirm the projector's current ID, press any **ID** button for three seconds. Its number is shown on each screen regardless of set ID of projector.

Changing the frequency of remote control signal

The accessory remote control has the two choices on signal frequency Mode 1:NORMAL and Mode 2:HIGH. If the remote control does not function properly, attempt to change the signal frequency.

To set the Mode, press the combination of two buttons listed below simultaneously for about three seconds.

- (1) Set to Mode 1:NORMAL
MENU and **MY BUTTON-4** buttons
- (2) Set to Mode 2:HIGH
RESET and **MY BUTTON-1** buttons

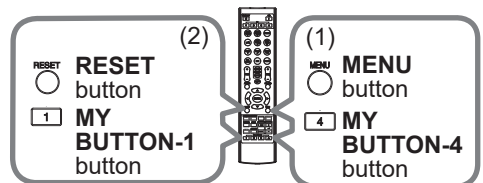

The REMOTE FREQ. in the SERVICE item of the OPTION menu (☞99) of the projector to be controlled should be set to the same mode as the remote control.

About the remote control signal

The remote control works with the projector's remote sensor. This projector has two remote sensors on the front and back sides.

The sensors can sense signals within the following range:
60 degrees (30 degrees to the left and right of the sensor)
within about 3 meters.

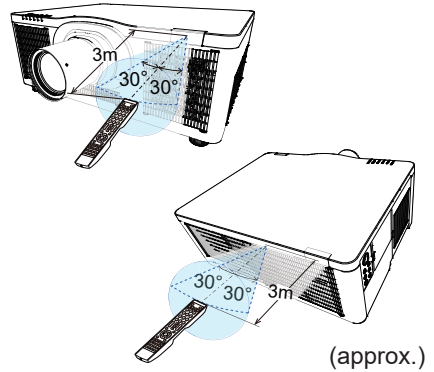

- NOTE** • You can deactivate one of the sensors using the REMOTE RECEIV. item in the SERVICE menu of the OPTION menu (☞99).
- The remote control signal reflected in the screen may be available. If it is difficult to send the signal to the sensor directly, try to make the signal reflect.
 - The remote control uses infrared light to send signals to the projector (Class 1 LED). Use the remote control in an area free from obstacles that could block the remote control's signal to the projector.
 - The remote control may not work correctly if strong light (such as direct sun light) or light from an extremely close range (such as from an inverter fluorescent lamp) shines on the remote sensor of the projector. Adjust the position of projector avoiding those lights.

Power on/off

Turning on the power

1. Make sure that the power cord is firmly and correctly connected to the projector and the outlet.
2. Make sure that the **POWER** indicator is lighted in steady orange (📖121). Then remove the lens cover.
3. Press **STANDBY/ON** button on the projector or the **ON** button on the remote control.
The projection light source lights up and the **POWER** indicator begins blinking in green. When the power is completely on, the indicator stops blinking and light in a steady green (📖121).

To display the picture, select an input signal according to the section **Selecting an input signal** (📖34).

Turning off the power

1. Press the **STANDBY/ON** button on the projector or the **STANDBY** button on the remote control.
The message “Power off?” appears on the screen for about five seconds.
2. Press the **STANDBY/ON** or **STANDBY** button again while the message appears.
The light source goes off, and the **POWER** indicator begins blinking in orange. The **POWER** indicator stops blinking and lights in a steady orange when the light source cooling is completed (📖121).
3. Attach the lens cover, after the **POWER** indicator turns to steady orange.

(continued on next page)

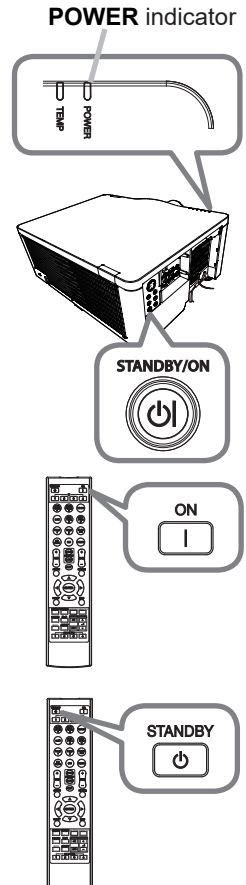

⚠ WARNING ▶ A strong light is emitted when the projector's power is on. Do not look into the lens of the projector or look inside of the projector through any of the projector's openings as the projection ray may cause a trouble on your eyes.

- ▶ Keep objects away from concentrated projection light beam. Blocking the beam by something causes high temperature and could result in fire or smoke.
- ▶ Do not touch around the exhaust vents during use or just after use, as it is too hot.

NOTE • Turn the power on/off in the right order. Power on the projector prior to the connected devices.

- This projector can automatically turn on/off. Refer to the DIRECT POWER ON (📖88), AUTO POWER ON (📖88) and AUTO POWER OFF (📖89) items of the OPTION menu.

Operating

Adjusting the volume

Use the **VOLUME + / -** buttons to adjust the volume. A dialog appears on the screen to help you in adjusting the volume. If you do nothing, the dialog automatically disappears after a few seconds.

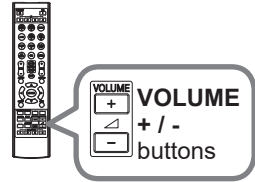

- NOTE**
- When \times is selected for current picture input port, the volume adjustment is disabled. See AUDIO SOURCE item of AUDIO menu (80).
 - If the projector is in the standby mode, the volume is adjustable when both of the following conditions are true:
 - An option other than \times is selected for AUDIO OUT in the STANDBY OUTPUT item of the SETUP menu (79).
 - NORMAL or QUICK START is selected in the STANDBY MODE item of the SETUP menu (76).

Temporarily turning off the screen and audio

Press **AV MUTE** button on the remote control. The BLANK screen is displayed instead of the screen of input signals and the sound is muted. Refer to the BLANK item in SCREEN menu about the BLANK screen (81).

To exit from the AV MUTE mode and restore the screen and audio, press **AV MUTE** button again.

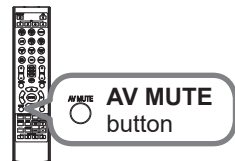

- NOTE**
- The projector automatically exits from the AV MUTE mode when some control buttons are pressed.
 - The **LIGHT** indicator of the projector blinks while a black BLANK screen is displayed.

Selecting an input signal

Press **INPUT** button on the projector.
 Select a desirable input referring to the displayed input list.

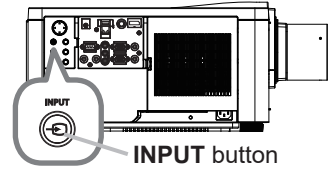

Press **COMPUTER 1**, **VIDEO**, **LAN**, **HDMI 1 / 2**, **DisplayPort**, **HDBaseT** or **SDI** button on the remote control.

The port corresponding to each button is selected as below.

Button	Ports
COMPUTER 1	COMPUTER IN
COMPUTER 2	-
VIDEO	VIDEO
LAN	LAN
USB TYPE A	-
USB TYPE B	-
HDMI 1	HDMI 1
HDMI 2	HDMI 2
DisplayPort	DisplayPort
HDBaseT	HDBaseT
SDI	3G-SDI*
DIGITAL	-

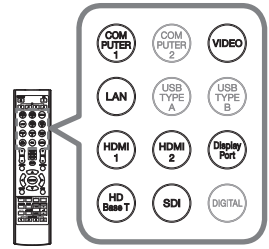

Buttons for input ports

NOTE • While ON is selected for AUTO SEARCH item in the OPTION menu, the projector keeps checking every port sequentially till an input signal is detected (📖87).

* MP-WU8801W/MP-WU8801B only

Selecting an aspect ratio

Press the **ASPECT** button on the remote control.
Each time you press the button, the projector switches the mode for aspect ratio in sequence.

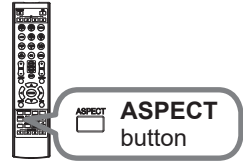

○ **For a computer signal**

NORMAL → 4:3 → 16:9 → 16:10 → ZOOM → NATIVE

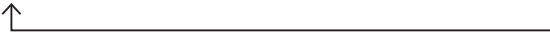

○ **For HDMI™, HDBaseT™, and DisplayPort™ signals**

NORMAL → 4:3 → 16:9 → 16:10 → 14:9 → ZOOM → NATIVE



○ **For a video signal or component video signal**

4:3 → 16:9 → 16:10 → 14:9 → ZOOM → NATIVE



○ **For an SDI signal (MP-WU8801W/MP-WU8801B only)**

NORMAL → 4:3 → 16:9 → 16:10 → ZOOM → NATIVE

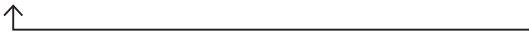

○ **For an input signal from the LAN port, or if there is no signal**

16:10 (fixed)

NOTE • The **ASPECT** button does not work when no proper signal is input.

- NORMAL mode keeps the original aspect ratio setting.
- You cannot select NATIVE when inputting 4K signal.

Limiting OSD display

To change this function, follow the steps below.

1. Press the **OSD MSG** button on the remote control for 3 seconds.
2. The OSD MESSAGE dialog will be displayed.
While this OSD is displayed, press the **OSD MSG** button again on the remote control.
3. Toggle and change the function.

NORMAL ⇔ SILENT ⇔ INHIBIT



OSD MSG
OSD MSG
button

Adjusting the projector's elevator

Increasing or shortening the length of the elevator feet shifts the projection position and the projection angle.

Turn the elevator feet each to adjust their length.

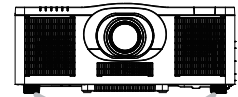

Elevator feet

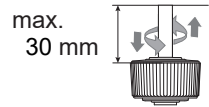

⚠ WARNING ► Do not lengthen the elevator feet exceeding 30 mm. The foot lengthened exceeding the limit may come off and drop the projector down, and result in an injury or damaging the projector.

Adjusting the lens

Adjusting the zoom and focus

The ZOOM or FOCUS dialog appears when you press any of the buttons from **ZOOM**, **ZOOM -**, **ZOOM +**, **FOCUS**, **FOCUS +** and **FOCUS -**.

1. Use the **ZOOM + / -** buttons on the remote control or **ZOOM** button and ◀/▶ cursor buttons on the projector to adjust the screen size.
2. Use the **FOCUS + / -** buttons on the remote control or **FOCUS** button and ◀/▶ cursor buttons on the projector to focus the picture.

NOTE • The projector may ignore the operation by other buttons while the lens is moving.

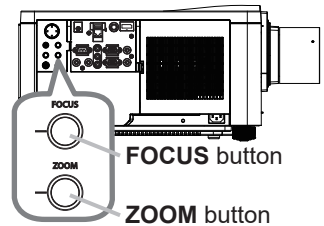
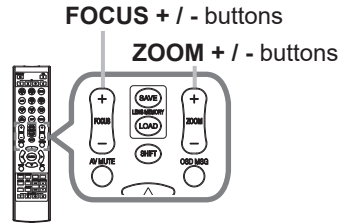

Adjusting the lens (continued)

Adjusting the lens position

Press the **LENS SHIFT** button on the projector or the **SHIFT** button on the remote control to display the LENS SHIFT menu. Press the **▶** or **ENTER** button to select LENS SHIFT, then shift the lens with the **▲/▼/◀/▶** buttons. Generally, better image quality can be got when the lens is set to the center.

Press the **◀** or **ENTER** button to go back to menu selection. To exit the LENS SHIFT function, press the **LENS SHIFT** button while LENS SHIFT menu is displayed, or select EXIT and press the **▶** or **ENTER** button.

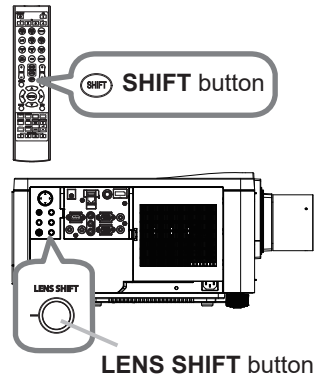

LENS SHIFT button

CENTERING

Select CENTERING in LENS SHIFT menu and press the **▶** or **ENTER** button to execute the CENTERING feature which adjusts the lens to the center. A message dialog is displayed for confirmation. Pressing the **▶** button performs CENTERING. You can also perform CENTERING in the standby mode by pressing the **INPUT** and **LENS SHIFT** buttons on the control panel for three seconds at the same time.



⚠ CAUTION ▶ Do not put your fingers or any other things around the lens. The moving lens could catch them in the space around the lens and result in an injury.

NOTE • While the lens is moving to the center, the menu disappears and an hourglass icon appears on the screen. CENTERING may take some time till the lens reaches the center.

- The projector may ignore operation by buttons while moving the lens.
- The CENTERING feature while the projector is in the standby mode is disabled if the STANDBY MODE item of SETUP menu is set to NETWORK(WOL) or SAVING. Perform CENTERING before the projector's power is turned off, or set the STANDBY MODE to NORMAL or QUICK START.
- The adjustable range of LENS SHIFT varies depending on the lens unit mounted on the projector to maintain picture quality. Therefore, LENS SHIFT adjustment may not reach the end of the indicator in the dialog. This is not a failure.

Adjusting the lens (continued)

Lens memory

This projector is equipped with memory functions for the lens adjustments (LENS SHIFT and LENS TYPE). Up to three sets of adjustments can be stored.

To use the lens memory feature, press the **LOAD** or **SAVE** button, or select LENS MEMORY in LENS SHIFT menu and press the ► or **ENTER** button. Then the LENS MEMORY dialog appears. The current lens adjustments are displayed on the "CURRENT" line. The adjustments already stored in the lens memory are displayed on the lines of SAVE and LOAD-1 to 3.

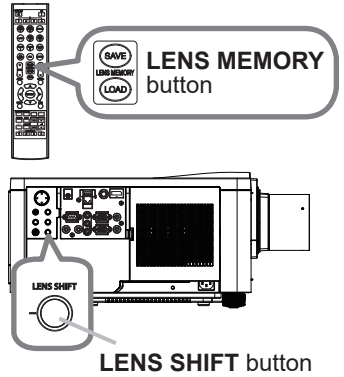

○ **SAVE:**

To store the current lens adjustments, select one of the "SAVE" options numbered 1 to 3 (number of the lens memory) and press the ► or **ENTER** button.

Remember that the current data being stored of a memory is lost by saving new data into the memory.

○ **LOAD:**

To recall stored adjustments, select one of the "LOAD" options numbered 1 to 3 (number of the lens memory) and press the ► or **ENTER** button.

Remember that the current adjusted condition is lost by loading data. If you want to keep the current adjustment, save it before performing a LOAD function.

○ **CLEAR LENS MEMORY:**

To clear the adjustment stored in a lens memory, select CLEAR LENS MEMORY and press the ► or **ENTER** button. A message dialog is displayed for confirmation. Press the ► button again to clear the lens memory.

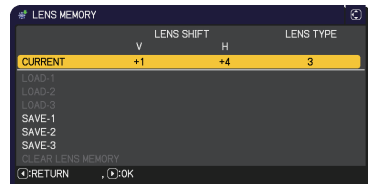

NOTE • The projector may ignore the operation by buttons while moving the lens.
• You can perform the SAVE or LOAD function using **LENS MEMORY** button.

Correcting the distortion

To correct the distortion of projected screen, you can select one of three options, KEYSTONE, PERFECT FIT, and WARPING. First press the **GEOMETRY** button to display the GEOMETRY CORRECTION menu, and point at one of the items with the ▲/▼ buttons.

KEYSTONE: Adjust the vertical and horizontal keystone.

PERFECT FIT: Adjust each of the screen corners and sides to correct the distortion.

WARPING: Project an image on several types of screen.

GEOMETRY
button



Use Keystone/Perfect Fit/Warping for adjustment. When one is selected, other items are not available.

Complete the following procedure for the item you selected.

NOTE • The menu or dialog automatically disappears after several seconds of inactivity. Press the **GEOMETRY** button again, or point the cursor at EXIT in the dialog and press the ► or **ENTER** button to end the operation and close the menu or dialog.

○ KEYSTONE:

When KEYSTONE is pointed at, pressing the ► or **ENTER** button displays the KEYSTONE dialog.

1. Select the vertical or horizontal keystone (⏏ / ⏎) with the ▲/▼ buttons.
2. Use the ◀/▶ buttons to adjust the keystone distortion.



NOTE • When the zoom adjustment is set to the TELE (telephoto focus), this function may be excessive. This function should be used when the zoom adjustment is set to the full WIDE (wide-angle focus).

- When the horizontal lens shift is not set to the center, this function may not work correctly.
- Point at RETURN in the dialog with the ▲/▼ buttons and press ◀ or **ENTER** button to return to the GEOMETRY CORRECTION menu.

Correcting the distortion (continued)

○ PERFECT FIT:

When PERFECT FIT is pointed at, pressing the ► or **ENTER** button displays the PERFECT FIT dialog.

This projector is equipped with a test pattern for PERFECT FIT. Select PATTERN with the ▲/▼ buttons, then press the ◀/▶ buttons to switch on and off.



1. Select SETUP with the ▲/▼ buttons and press the ► or **ENTER** button.
2. Select one of the corners or sides to be adjusted with the ▲/▼/◀/▶ buttons and press the **ENTER** or **INPUT** button.
3. Adjust the selected part as below.
 - To adjust a corner, use the ▲/▼/◀/▶ buttons to adjust the position of the corner.
 - To adjust the upper or lower side, use the ▲/▼ buttons to adjust the distortion of the side.
 - To adjust the left or right side, use the ◀/▶ buttons to adjust the distortion of the side.
 - To adjust another corner or side, press the **ENTER** or **INPUT** button and follow the procedure from step 2.

(continued on next page)

Correcting the distortion (continued)

4. This projector is equipped with a memory feature for PERFECT FIT adjustment. Up to three sets of adjustments can be stored.

● **LOAD:**

To recall stored adjustments, select one of the "LOAD" options numbered 1 to 3 (number of the memory) with the ▲/▼ buttons and press the ►, **ENTER** or **INPUT** button.

The current adjusted condition is lost by loading data. If you want to keep the current adjustment, save it before performing a LOAD function.

● **SAVE:**

To store the current PERFECT FIT adjustment, select one of the "SAVE" options numbered 1 to 3 (number of the memory) with the ▲/▼ buttons and press the ►, **ENTER** or **INPUT** button.

The current data being stored is lost by saving new data.

NOTE • The LOAD functions whose linked memories have no data are skipped.
• There may be some noise and the screen may flicker for a moment when loading data. This is not malfunction.

○ **WARPING:**

Projection on several types of screen can be performed by WARPING function. This function is operated by using dedicated PC tool, "Warping Tool". PC and projector are required to be connected with LAN cable to use this function.

You can get the PC tool from the our website.

Refer to Application Manual for operations.

Using the EDGE BLENDING features

1. Mode (Manual/Camera)

OFF: Disables the Blending function.

Manual: Allows you to adjust Blending Region or Blending Level by using menu.

Camera: Allows you to perform automatic adjustment by using Camera in Projector Blending Tool.

- Keystone/Perfect Fit/Warping are not selectable when Camera is selected in Blending.

2. Blending Region

2.1 Specifying Blending Region

Select one of the four sides with ▲/▼/◀/▶ buttons and press **ENTER** or **INPUT** button. Blending Region can be specified for left and right sides with ◀/▶ buttons and for top and bottom sides with ▲/▼ buttons.

Specify Blending Region for each projector.

Adjust them referring to the guide displayed during the adjustment of Blending Region.

* The minimum value of Blending Region is 200 dots.

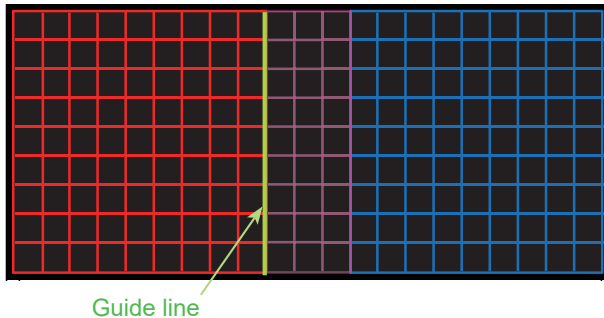

(continued on next page)

3. Cropping

When inputting the same image to each projector, The cropping function enables two projectors to cut out a part of input image and display one image on a large screen. The following patterns are supported.

2 x 1



1 x 2



2 x 2



3.1 Displaying Cropping Menu

Select CROPPING with ▲/▼ buttons and press ►, **ENTER** or **INPUT** button to display Cropping Menu.

3.2 Setting Cropping

Select MODE with ▲/▼ buttons and select ON with ◀/▶ buttons.

The input image is automatically cut out according to the settings of Blending Region.

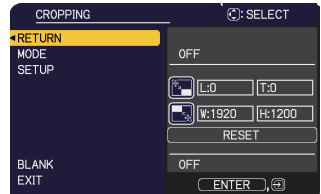

(continued on next page)

3.3 Adjusting Cropping Area

Adjust the Cropping Area when cutting out a part of input image.

Select SETUP with ▲/▼ buttons and press ►, **ENTER** or **INPUT** button.

* MODE is set to [OFF] temporarily and the guide of the Cropping Area is displayed.

Select [LT]/[WH] with ▲/▼ buttons and press the **ENTER** or **INPUT** button.

Move the guide display with ▲/▼/◀/▶ buttons to select the region of the screen to be cut out.

Press the **ENTER** or **INPUT** button and then press ◀ button to select SETUP, and MODE switches to ON automatically.

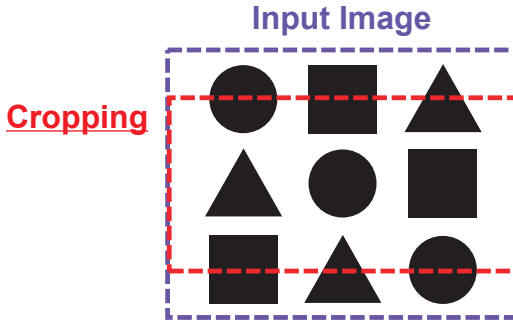

3.4 Adjust Cropping Area of the other projector.

Set the Cropping Area of the other projector with the same value as one projector.

The input image is automatically cut out according to the settings of the Blending Region.

* To keep input image from not being seen while setting up, set BLANK to ON.

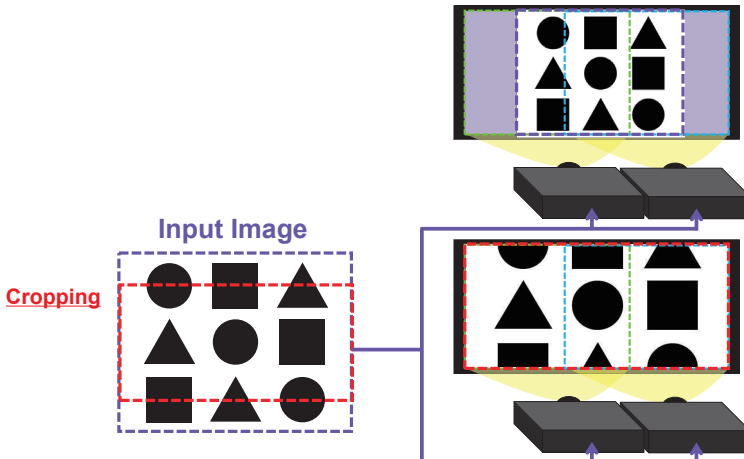

(continued on next page)

4. Selecting Blending Level

Select the BLENDING LEVEL with ▲/▼ buttons.

[1-25] can be selected with ◀/▶ buttons.

Adjust the brightness of the Blending Region according to the settings.

5. LIGHT OUTPUT

Adjusts the brightness of the projectors which are using Blending.

6. WHITE BALANCE

Adjusts the white balance of the whole screen.

6.1. OFFSET

Changes the color intensity on the whole tones.

6.2. GAIN

Mainly affects color intensity on the brighter tones.

7. BLACK LEVEL

Adjusts black color level of the projectors which are using Blending.

Adjusts the adjustment value of R/G/B at the same time when W is selected.

When each of R/G/B is selected, the adjustment value of R/G/B can be adjusted respectively.

NOTE • The positional deviation of the screen may occur after installing the projector over time. Perform the screen adjustment again to correct the positional deviation.

Using the magnify feature

1. Press the **MAGNIFY ON** button on the remote control.
The picture is magnified, and the MAGNIFY dialog appears on the screen. When the **MAGNIFY ON** button is pressed for the first time after the projector is turned on, the picture is zoomed by 1.5 times. On the dialog, triangle marks to show each direction are displayed.

2. The display magnification of the projector switches with every press of the **MAGNIFY ON** button.
 - For computer signals, RGB signals for HDMI™, HDBaseT™ and DisplayPort™, input signals from the LAN port
1.5 times → 2 times → 3 times → 4 times → 1 time
 - For video signals, Component signals for HDMI™, HDBaseT™ and DisplayPort™, SDI signals
1.5 times → 2 times → 1 time

3. While the triangles are displayed on the dialog, use the ▲/▼/◀/▶ cursor buttons to shift the magnifying area.

4. Press the **MAGNIFY OFF** button on the remote control to exit magnification.

NOTE • The MAGNIFY dialog automatically disappears in several seconds with no operation. The dialog appears again if the **MAGNIFY ON** button is pressed when the dialog has automatically disappeared.

- The magnification is automatically disabled when the displaying signal or its display condition is changed.
- While the magnification is active, the keystone distortion condition may vary. It is restored when the magnification is disabled.
- Some horizontal stripes might be visible on the image while magnification is active.
- This function is not available in the following cases:
 - A sync signal in the range not supported is input.
 - There is no input signal.

Temporarily freezing the screen

Press the **FREEZE** button on the remote control. The "FREEZE" indication appears on the screen (however, the indication does not appear when the OFF is selected for the OSD MESSAGE item in the SETUP (📖78), and the projector goes into the FREEZE mode, which the picture is frozen. To exit the FREEZE mode and restore the screen to normal, press the **FREEZE** button again.



- NOTE** • The projector automatically exits from the FREEZE mode when some control buttons are pressed.
- If the projector continues projecting a still image for a long time, the LCD panel might possibly be burned in. Do not leave the projector in the FREEZE mode for too long.
 - Images might appear degraded when this function is operated, but it is not a malfunction.

Temporarily shading the screen

Press the **SHUTTER** button on the control panel. Light source output is turned off. Refer to "Regarding the indicator lamps" (📖122) about the indicator when the shutter is closed. To open the shutter and restore the screen, press the **SHUTTER** button again.

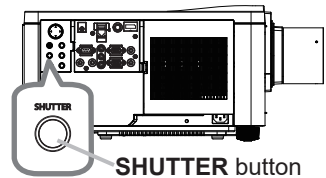

⚠ CAUTION ► If you want a blank screen while the light source is lit, use the shutter function above or the AV MUTE function (📖33). Any other action may cause the damage on the projector.

- NOTE** • The projector turns off automatically when the time set up by the SHUTTER TIMER passes (📖89).
- When turning off the power by the normal procedure, the shutter opens automatically.

PbyP (Picture by Picture) / PinP (Picture in Picture)

The PbyP / PinP is a function for displaying two different picture signals on a screen that is separated into main and sub areas for each signal.

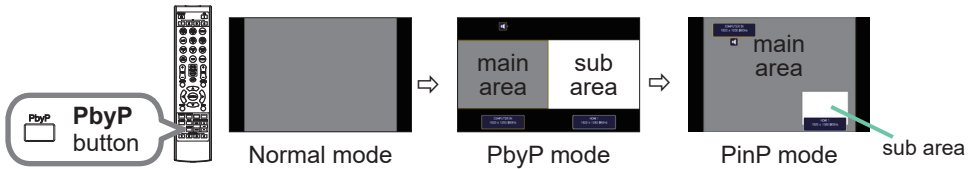

Press the **PbyP** button on the remote control. This activates the PbyP mode. Then, press the **PbyP** button again. The projector goes into PinP mode. The screen which is displayed before the **PbyP** button was pressed is displayed as the main area. Most of operations are effective for the main area only. To quit the PinP mode, press the **PbyP** button again.

- NOTE**
- If the **LAN** port is selected when the **PbyP** button is pressed, input from other port is displayed on the main area.
 - When in the PbyP / PinP mode, use the **MENU** button on the remote control or ▲/▼ buttons on the control panel to display the OSD menu.
 - Some functions that cannot be used when in the PbyP / PinP mode.
 - Normally a message is displayed when buttons that cannot be used are pressed (📖 120). However, the messages are not displayed for some unusable buttons.
 - The functions on the OSD menu that cannot be used are displayed in gray and cannot be selected.
 - When in the PbyP / PinP mode, image quality may deteriorate.

(continued on next page)

PbyP (Picture by Picture) / PinP (Picture in Picture) (continued)

○ Setting information

The setting information appears for several seconds when the PbyP / PinP function is started. Displays the input information for each area. A frame will be displayed around the main area and an audio mark indicating the audio output is also displayed.

The information can be redisplayed with the ◀/▶ buttons after it has been erased.

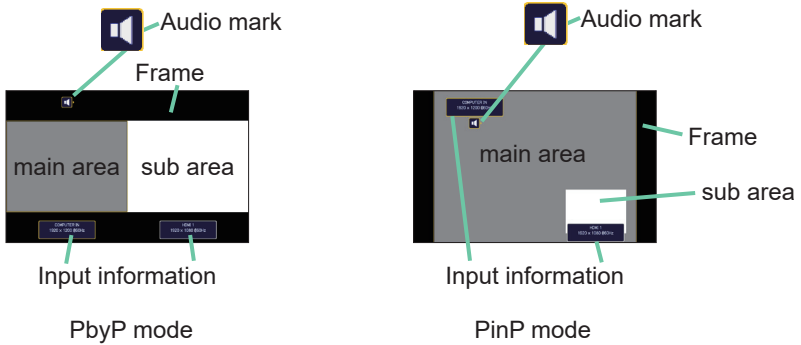

○ Changing the main area

The position of the main area can be toggled with the ◀/▶ buttons when the setting information is displayed on the screen. The frame and the audio mark move together with it.

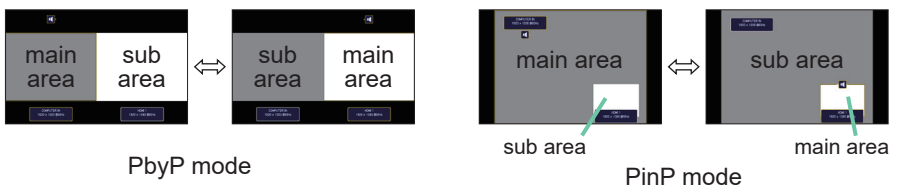

(continued on next page)

PbyP (Picture by Picture) / PinP (Picture in Picture) (continued)

○ Changing the picture input signal

Press any button to select an input port on the remote control or press the **INPUT** button on the control panel. A dialog box to select the input signal for the main area is displayed. Choose a signal using the **▲/▼** buttons. To change the signal in the sub area, switch temporarily across to the main area with the **◀/▶** buttons.

Displaying the same signal on the both areas is not allowed. Refer to the table for details on available input signal combinations. Any combinations marked with "X" cannot be selected.

Sub area \ Main area	COMPUTER IN	LAN	HDMI 1	HDMI 2	DisplayPort	HDBaseT	3G-SDI (MP-WU8801W/MP-WU8801B)	VIDEO
COMPUTER IN	X	X	O	O	O	O	O	X
LAN	X	X	X	X	X	X	X	X
HDMI 1	O	X	X	O	X	X	X	O
HDMI 2	O	X	O	X	O	O	O	O
DisplayPort	O	X	X	O	X	X	X	O
HDBaseT	O	X	X	O	X	X	X	O
3G-SDI (MP-WU8801W/MP-WU8801B)	O	X	X	O	X	X	X	O
VIDEO	X	X	O	O	O	O	O	X

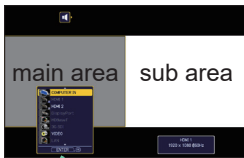

Input signal

PbyP mode



Input signal

sub area

PinP mode

(continued on next page)

PbyP (Picture by Picture) / PinP (Picture in Picture) (continued)

○ **PbyP / PinP SWAP function**

Press the **MY BUTTON** assigned the PbyP / PinP SWAP (📖90). The position of the area is exchanged without any setting change.

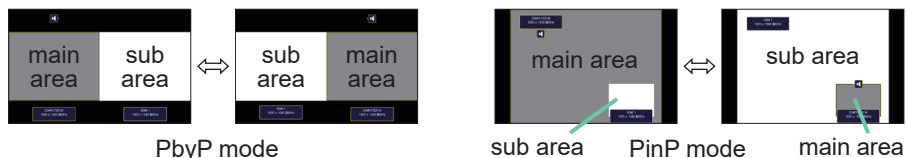

NOTE • For some signals, it may not be displayed correctly in the PbyP / PinP mode, even if it can be displayed properly in the normal mode.
 • PbyP/PinP is unavailable when other than OFF is selected in GEOMETRY CORRECTION > EDGE BLENDING > MODE.

○ **Changing the size of main area in PbyP mode**

Using ▲/▼ buttons on the remote control changes the size of main area in PbyP mode.

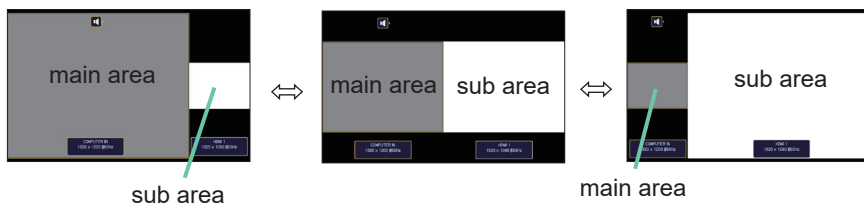

○ **Changing the position of sub area in PinP mode**

1. Select PinP POSITION in INPUT MENU (📖71).
2. Using ▲/▼ buttons on the remote control changes the position of sub area in PinP mode.

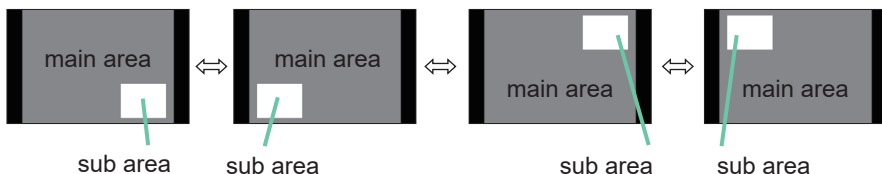

Using the menu function

This projector has the following menus:

PICTURE, IMAGE, INPUT, SETUP, AUDIO, SCREEN, OPTION, NETWORK, SECURITY and EASY MENU.

EASY MENU consists of functions often used, and the other menus are classified into each purpose and brought together as the **ADVANCED MENU**.

Each menu is operated using the same methods. While the projector is displaying any menu, the **MENU** button on the projector works as the cursor buttons. The basic operations of these menus are as follows.

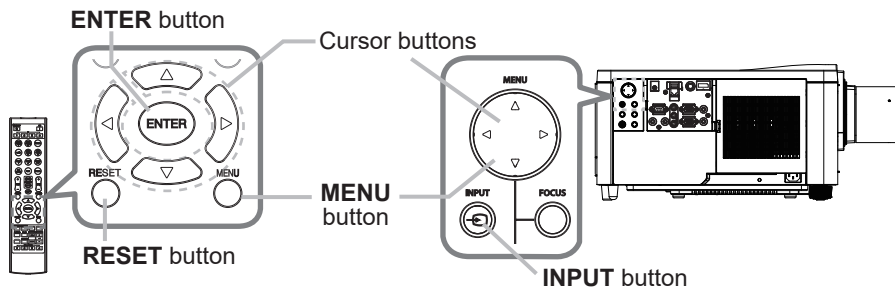

1. To start the MENU, press the **MENU** button. The MENU you last used (EASY or ADVANCED) appears. EASY MENU has priority to appear just after powered on.

2. In the **EASY MENU**

- (1) Use the **▲/▼** cursor buttons to select an item to operate. To change it to the **ADVANCED MENU**, select the **ADVANCED MENU**.
- (2) Use the **◀/▶** cursor buttons to operate the item.



In the **ADVANCED MENU**

- (1) Use the **▲/▼** cursor buttons to select a menu. To change it to the **EASY MENU**, select the **EASY MENU**. The items in the menu appear on the right side.
- (2) Press the **▶** cursor button or **ENTER** button to move the cursor to the right side. Then use the **▲/▼** cursor buttons to select an item to operate and press the **▶** cursor button or **ENTER** button to progress. The operation menu or dialog of the selected item appears.
- (3) Use the buttons as instructed in the OSD to operate the item.



(continued on next page)

Using the menu function (continued)

3. To close the MENU, press the **MENU** button again or select EXIT and press the ◀ cursor button or **ENTER** button. If you do not do anything, the dialog automatically disappears after about 30 seconds.

NOTE • Some functions cannot be performed when a certain input port is selected, or when a certain input signal is displayed.

- To reset the operation, press **RESET** button on the remote control during the operation. Note that some items (such as LANGUAGE, VOLUME) cannot be reset.
- In the **ADVANCED MENU**, when you want to return to the previous display, press the ◀ cursor button on the remote control.

Indication in OSD (On Screen Display)

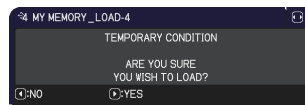
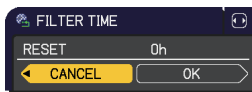

The meanings of the general words on the OSD are as follows.

Indication	Meaning
EXIT	Closes the OSD menu. It is the same as pressing the MENU button.
RETURN	Returns the menu to the previous menu.
CANCEL or NO	Cancels the operation in the present menu and returns to the previous menu.
OK or YES	Executes the prepared function or shifts the menu to the next menu.

Using the menu function (continued)

Menu items

The items contained in the menus are as below:

Menu	Items
EASY MENU (📖57)	ASPECT, KEYSTONE, PERFECT FIT, PICTURE MODE, LIGHT OUTPUT, INSTALLATION, RESET, FILTER TIME, LANGUAGE, ADVANCED MENU, EXIT
PICTURE (📖59)	BRIGHTNESS, CONTRAST, COLOR, TINT, SHARPNESS, PICTURE QUALITY, DYNAMIC BLACK, MY MEMORY
IMAGE (📖63)	ASPECT, OVER SCAN, V POSITION, H POSITION, H PHASE, H SIZE, AUTO ADJUST EXECUTE
INPUT (📖66)	PROGRESSIVE, VIDEO NR, COLOR SPACE, VIDEO FORMAT, DIGITAL SIGNAL FORMAT, DIGITAL RANGE, COMPUTER IN, FRAME LOCK, RESOLUTION, PbyP/PinP SETUP
SETUP (📖72)	GEOMETRY CORRECTION, LIGHT & FILTER, PICTURE POSITION, INSTALLATION, STANDBY MODE, COLOR UNIFORMITY, OSD MESSAGE, HDMI OUTPUT, STANDBY OUTPUT
AUDIO (📖80)	VOLUME, AUDIO SOURCE
SCREEN (📖81)	LANGUAGE, MENU POSITION, BLANK, AUTO BLANK, START UP, MyScreen, MyScreen Lock, SOURCE NAME, TEMPLATE, C.C.
OPTION (📖87)	SEARCH SKIP, AUTO SEARCH, DIRECT POWER ON, AUTO POWER ON, AUTO POWER OFF, SHUTTER TIMER, MY BUTTON, SCHEDULE, SERVICE
NETWORK (📖105)	NETWORK INFORMATION, WIRELESS NETWORK, NETWORK SETUP, MY IMAGE, EXTERNAL CONTROL, OTHER OPERATION
SECURITY (📖106)	ENTER PASSWORD, SECURITY PASSWORD CHANGE, MyScreen PASSWORD, PIN LOCK, TRANSITION DETECTOR, MY TEXT PASSWORD, MY TEXT DISPLAY, MY TEXT WRITING, SECURITY INDICATOR, STACK LOCK

EASY MENU

Select an item from the EASY menu using the ▲/▼ cursor buttons. Then perform it according to the following table.

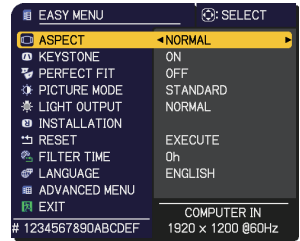

Item	Description
ASPECT	Using the ◀/▶ buttons switches the mode for aspect ratio. See the ASPECT item in IMAGE menu (📖63).
KEYSTONE	Pressing the ▶ button displays the KEYSTONE dialog. See the KEYSTONE item in SETUP menu (📖72).
PERFECT FIT	Pressing the ▶ button displays the PERFECT FIT dialog. See the PERFECT FIT item in SETUP menu (📖72).
PICTURE MODE	Using the ◀/▶ buttons switches the picture mode. The picture modes are combinations of GAMMA and COLOR TEMP settings. Choose a suitable mode according to the projected source. <ul style="list-style-type: none"> • Lines or other noise might appear on the screen when this function is operated, but it is not a malfunction. • DICOM SIM. is the projector's DICOM® ("Digital Imaging and Communication in Medicine") simulation mode. This mode simulates the DICOM standard, which is a standard applicable to digital communications in medicine, and can be useful for displaying medical images, such as X-rays photos. This projector is not a medical device and is not compliant to the DICOM standard, and neither the projector nor the DICOM SIM. mode should be used for medical diagnosis.

(continued on next page)

EASY MENU

Item	Description
LIGHT OUTPUT	<p>Pressing the ► button displays the dialog for light output. See the LIGHT OUTPUT item of the LIGHT & FILTER item in SETUP menu. (📖73)</p> <ul style="list-style-type: none"> • When the ambient temperature is around 35 to 45°C, the brightness of light source is reduced automatically. • The brightness of the light source may be reduced depending on the direction of the projection.
INSTALLATION	<p>Pressing the ► button displays the INSTALLATION dialog. See the INSTALLATION item in SETUP menu (📖75).</p>
RESET	<p>Selecting this item resets all of the EASY MENU items except the FILTER TIME and LANGUAGE. A dialog is displayed for confirmation. Selecting the OK using the ► button performs resetting.</p>
FILTER TIME	<p>The usage time of the air filter is shown in the menu. Selecting this item resets the filter time which counts usage time of the air filter. A dialog is displayed for confirmation. Selecting OK using the ► button initiates the reset. See the FILTER TIME item in SETUP menu (📖74).</p>
LANGUAGE	<p>Using the ◀/▶ buttons changes the display language. See the LANGUAGE item in SCREEN menu (📖81).</p>
ADVANCED MENU	<p>Press the ► or ENTER button to use the menu of PICTURE, IMAGE, INPUT, SETUP, AUDIO, SCREEN, OPTION, NETWORK or SECURITY.</p>
EXIT	<p>Press the ◀ or ENTER button to close the OSD menu.</p>

PICTURE menu

Select an item from the PICTURE menu using the ▲/▼ cursor buttons, and press the ► cursor button or **ENTER** button to execute the item. Then perform it according to the following table.

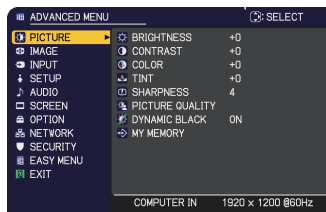

Item	Description
BRIGHTNESS	Using the ◀/▶ buttons adjusts the brightness. Dark ⇄ Light
CONTRAST	Using the ◀/▶ buttons adjusts the contrast. Weak ⇄ Strong
COLOR	Using the ◀/▶ buttons adjusts the strength of whole color. Weak ⇄ Strong
TINT	Using the ◀/▶ buttons adjusts the tint. Reddish ⇄ Greenish
SHARPNESS	Using the ◀/▶ buttons adjusts the sharpness. Weak ⇄ Strong <ul style="list-style-type: none"> • There may be some noise and/or the screen may flicker for a moment when an adjustment is made. This is not a malfunction.

(continued on next page)

Item	Description
PICTURE QUALITY	<p>Selecting this item displays the PICTURE QUALITY menu.</p> <p>Select an item using the ▲/▼ buttons, and press the ► button or the ENTER button on the remote control to execute the item.</p>
	<p>PICTURE MODE</p> <p>After selecting USER-1 / USER-2 / USER-3, the following features are adjustable.</p> <p>Gamma, Color Temp</p>
	<p>GAMMA</p> <p>This feature is only available when USER-1 / USER-2 / USER-3 is selected.</p> <p>Using the ▲/▼ buttons switches the gamma mode.</p>



(continued on next page)

Item	Description
<p>PICTURE QUALITY (continued)</p>	<p>GAMMA (continued)</p> <p>Selecting a mode whose name includes CUSTOM and then pressing the ► button or the ENTER button displays a dialog to help you in adjusting the mode. This function is useful when you want to change the brightness of particular tones. Choose an item using the ◀/▶ buttons, and adjust the level using the ▲/▼ buttons.</p> <ul style="list-style-type: none"> • Lines or other noise might appear on the screen when this function is operated, but it is not a malfunction.
	<p>COLOR TEMP</p> <p>This feature is only available when USER-1 / USER-2 / USER-3 is selected.</p> <p>Using the ▲/▼ buttons switches the color temperature mode. Selecting a mode whose name includes CUSTOM and then pressing the ► button or the ENTER button displays a dialog to aid you in adjusting the OFFSET and GAIN of the selected mode.</p> <p>OFFSET adjustments change the color intensity on the whole tones. GAIN adjustments mainly affect color intensity on the brighter tones. Choose an item using the ◀/▶ buttons, and adjust the level using the ▲/▼ buttons.</p> <ul style="list-style-type: none"> • Lines or other noise might appear on the screen when this function is operated, but it is not a malfunction.

(continued on next page)

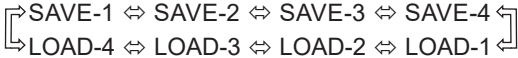
Item	Description
<p>PICTURE QUALITY (continued)</p>	<p>ACCENTUALIZER ACCENTUALIZER is a function to improve the legibility. Using the ◀/▶ buttons adjusts the sharpness. Weak ⇔ Strong</p> <ul style="list-style-type: none"> • There may be some noise and/or the screen may flicker for a moment when an adjustment is made. This is not a malfunction.
	<p>HDCR A function to show a clear picture in a bright room. Using the ◀/▶ buttons adjusts the contrast.</p>
	<p>COLOR MANAGEMENT A function to adjust color phase, color saturation, and brightness respectively for red, yellow, green, cyan, blue, and magenta.</p>
<p>DYNAMIC BLACK</p>	<p>Turn on/off the DYNAMIC BLACK function. Configures the projector to automatically adjust the contrast of the input image. When a dark video signal is input, the projector dynamically adjusts the picture contrast. This function may not work correctly when analog signals contain noise.</p>
<p>MY MEMORY</p>	<p>This projector has four memories for adjustment data (for all the items of the PICTURE menu). Selecting a function using the ▲/▼ buttons and pressing the ▶ or ENTER button performs each function.</p> <p style="text-align: center;">  </p> <p><u>LOAD-1, LOAD-2, LOAD-3, LOAD-4</u> Performing a LOAD function loads the data from the memory linked in the number included in the function's name, and adjusts the picture automatically depending on the data.</p> <ul style="list-style-type: none"> • The LOAD functions whose linked memory has no data are skipped. • Remember that the current adjusted condition is lost by loading data. To keep the current adjustment, save it before performing a LOAD function. • There may be some noise and the screen may flicker for a moment when loading data. This is not malfunction. • You can perform the LOAD function using MY BUTTON. See MY BUTTON item in OPTION menu (p.90). <p><u>SAVE-1, SAVE-2, SAVE-3, SAVE-4</u> Performing a SAVE function saves the current adjustment data into the memory linked in the number included in the function's name.</p> <ul style="list-style-type: none"> • Remember that the current data being stored of a memory is lost by saving new data into the memory.

Item	Description
OVER SCAN	<p>Using the ◀/▶ buttons adjusts the over-scan ratio. Small (It magnifies picture) ⇔ Large (It reduces picture)</p> <ul style="list-style-type: none"> • This item can't be selected for a computer signal of COMPUTER IN port and LAN port.
V POSITION	<p>Using the ◀/▶ buttons adjusts the vertical position. Down ⇔ Up</p> <ul style="list-style-type: none"> • Over-adjusting the vertical position may cause noise to appear on the screen. If this occurs, reset the vertical position to the default setting. Pressing the RESET button when the V POSITION is selected resets the V POSITION to the default setting. • When this function is performed on a video signal, the range of this adjustment depends on OVER SCAN (📺<i>above</i>) setting. You cannot adjust when OVER SCAN is set to 10. • This function is unavailable for a signal from the LAN, HDMI 1 / 2, HDBaseT, DisplayPort, or 3G-SDI port.
H POSITION	<p>Using the ◀/▶ buttons adjusts the horizontal position. Right ⇔ Left</p> <ul style="list-style-type: none"> • Over-adjusting the horizontal position may cause noise to appear on the screen. If this occurs, reset the horizontal position to the default setting. Pressing the RESET button when the H POSITION is selected resets the H POSITION to the default setting. • When this function is performed on a video signal, the range of this adjustment depends on OVER SCAN (📺<i>above</i>) setting. You cannot adjust when OVER SCAN is set to 10. • This function is unavailable for a signal from the LAN, HDMI 1 / 2, HDBaseT, DisplayPort, or 3G-SDI port.

(continued on next page)

Item	Description
H PHASE	<p>Using the ◀/▶ buttons adjusts the horizontal phase to eliminate flicker. Right ⇔ Left</p> <ul style="list-style-type: none"> • This item can be selected only for a computer signal or a component video signal. This function is unavailable for a signal from the LAN, HDMI 1 / 2, HDBaseT, DisplayPort, or 3G-SDI port.
H SIZE	<p>Using the ◀/▶ buttons adjusts the horizontal size. Small ⇔ Large</p> <ul style="list-style-type: none"> • This item can be selected only for a computer signal. This function is unavailable for a signal from the LAN, VIDEO, HDMI 1 / 2, HDBaseT, DisplayPort, or 3G-SDI port. • When this adjustment is excessive, the picture may not be displayed correctly. If this occurs, reset the adjustment by pressing the RESET button on the remote control during this operation. • Images might appear degraded when this function is operated, but it is not a malfunction.
AUTO ADJUST EXECUTE	<p>Selecting this item performs the automatic adjustment feature.</p> <p>For a computer signal The vertical position, the horizontal position and the horizontal phase are automatically adjusted. Make sure that the application window is set to its maximum size prior to attempting to use this feature. A dark picture may still be incorrectly adjusted. Use a bright picture when adjusting.</p> <p>For a video signal The video format best suited for the respective input signal is selected automatically. This function is available only when the AUTO is selected for the VIDEO FORMAT item in the INPUT menu (p.67). The vertical position and horizontal position are automatically set to the default.</p> <ul style="list-style-type: none"> • The automatic adjustment operation requires approx. 10 seconds. Note that it may not function correctly with some input. • When this function is performed for a video signal, an extra line may appear outside a picture. • When this function is performed for a computer signal, a black frame may be displayed on the edge of the screen, depending on the computer model. • The items adjusted by this function may vary when the FINE or DISABLE is selected for the AUTO ADJUST item of the SERVICE item in the OPTION menu (p.95).

INPUT menu

Select an item from the Input menu using the ▲/▼ cursor buttons, and press the ► cursor button or **ENTER** button to execute the item. Then perform it according to the following table.

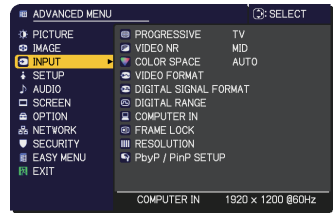

Item	Description
<p>PROGRESSIVE</p>	<p>Using the ▲/▼ buttons switches the progress mode. TV ⇄ FILM ⇄ OFF ↑—————↑</p> <ul style="list-style-type: none"> • This function works only for a video signal, component video signal (of 480i@60 or 576i@50 or 1080i@50/60), an HDMI™ signal (of 480i@60 or 576i@50 or 1080i@50/60) and HDBaseT™ signal (of 480i@60 or 576i@50 or 1080i@50/60). • When TV or FILM is selected, the screen image is sharp. FILM adapts to the 2-3 Pull-Down conversion system. But these may cause a certain defect (for example, jagged line) of the picture for a quick moving object. If this occurs, select OFF, even if the screen image loses sharpness.
<p>VIDEO NR</p>	<p>Using the ▲/▼ buttons switches the noise reduction mode. HIGH ⇄ MID ⇄ LOW ↑—————↑</p> <ul style="list-style-type: none"> • This function works only for a video signal, component video signal (of 480i@60 or 576i@50 or 1080i@50/60), an HDMI™ signal (of 480i@60 or 576i@50 or 1080i@50/60) and HDBaseT™ signal (of 480i@60 or 576i@50 or 1080i@50/60).
<p>COLOR SPACE</p>	<p>Using the ▲/▼ buttons switches the mode for color space.</p> <ul style="list-style-type: none"> • This item can be selected only for a computer signal (except for signals from the LAN port) and component video signal (except for signals from the 3G-SDI port). • The AUTO mode automatically selects the optimum mode. • The AUTO operation may not work correctly at some signals. If this occurs, select a suitable mode except AUTO.

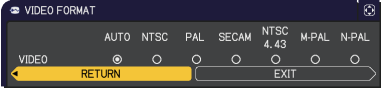
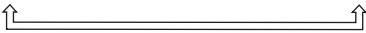

(continued on next page)

Item	Description
<p>VIDEO FORMAT</p>	<p>The video format for VIDEO port can be set. Using the ◀/▶ buttons switches the mode for video format.</p>  <p>AUTO ⇔ NTSC ⇔ PAL ⇔ SECAM N-PAL ⇔ M-PAL ⇔ NTSC4.43</p> <ul style="list-style-type: none"> • This item is used only for a video signal from the VIDEO port. • The AUTO mode automatically selects the optimum mode. • The AUTO operation may not work well for some signals. If the picture becomes unstable (for example, an irregular picture, lack of color), select the mode according to the input signal.
<p>DIGITAL SIGNAL FORMAT</p>	<p>Switches the signal format supported by HDMI1 / HDBaseT / DisplayPort. Select the DIGITAL SIGNAL FORMAT.</p> <p>4K ENHANCED* ⇔ 4K STANDARD ⇔ 2K COMPATIBLE</p>  <p>(* : Only HDMI 1 port is selectable.)</p> <p>4K ENHANCED : This mode supports 4K 50Hz/60Hz 4:4:4, 4:2:2, 4:2:0 format and 24Hz/25Hz/30Hz 4:4:4, 4:2:2 format. Select this when you use a device which supports 4K image signal described above. Select 4K STANDARD when picture or sound cannot be played correctly. Use a Premium High Speed HDMI Cable which supports 18Gbps when selecting 4K ENHANCED.</p> <p>4K STANDARD : This mode supports 4K 50Hz/60Hz 4:2:0 format and 24Hz/25Hz/30Hz 4:4:4, 4:2:2 format. Select this when you use a device not supporting 50Hz/60Hz 4:4:4, 4:2:2 format of 4K signal or when picture or sound cannot be played correctly after selecting 4K ENHANCED.</p>

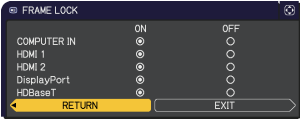
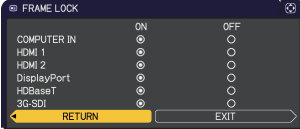
(continued on next page)

Item	Description
<p>COMPUTER IN</p>	<p>The computer input signal type for COMPUTER IN port can be set. Use the ◀/▶ buttons to select the computer input signal type.</p> <p style="text-align: center;">AUTO ↔ SYNC ON G OFF</p>  <ul style="list-style-type: none"> • Selecting the AUTO mode, you can input a sync on G signal or component video signal from the port. • In the AUTO mode, the picture may be distorted with certain input signals. If this occurs, remove the signal connector so that no signal is received and select the SYNC ON G OFF, and then reconnect the signal.
<p>FRAME LOCK</p>	<p>Set the frame lock function on/off for each port.</p> <div style="display: flex; justify-content: space-around;"> <div style="text-align: center;"> <p>MP-WU8701W/MP-WU8701B</p>  </div> <div style="text-align: center;"> <p>MP-WU8801W/MP-WU8801B</p>  </div> </div> <p>(1) Use the ▲/▼ buttons to select the input ports. (2) Use the ◀/▶ buttons to turn the frame lock function on/off .</p> <p style="text-align: center;">ON ↔ OFF</p> <ul style="list-style-type: none"> • When ON is selected, moving pictures are displayed more smoothly.

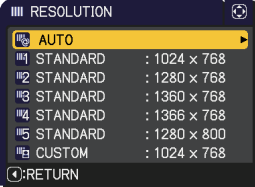
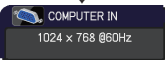
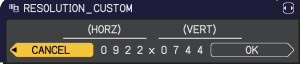
(continued on next page)

Item	Description
<p>RESOLUTION</p>	<p>The resolution for the COMPUTER IN input signal can be set on this projector.</p> <p>(1) In the INPUT menu select the RESOLUTION using the ▲/▼ buttons and press the ► button. The RESOLUTION menu is displayed.</p>  <p>(2) In the RESOLUTION menu select the resolution you wish to display using the ▲/▼ buttons. Selecting AUTO sets a resolution appropriate to the input signal.</p> <p>(3) Pressing the ► or ENTER button when selecting a STANDARD resolution automatically adjusts the horizontal and vertical positions, clock phase and horizontal size. The INPUT_INFORMATION dialog is displayed.</p>  <p>(4) To set a custom resolution, use the ▲/▼ buttons to select the CUSTOM and the RESOLUTION_CUSTOM box. Set the (HORZ) and (VERT) resolutions using the ▲/▼/◀/▶ buttons. This function may not support all resolutions.</p>  <p>(5) Move the cursor to OK on the screen and press the ► or ENTER button. The message "ARE YOU SURE YOU WISH TO CHANGE RESOLUTION?" appears. To save the setting, press the ► button. The horizontal and vertical positions, clock phase and horizontal size are automatically adjusted. The INPUT_INFORMATION dialog is displayed.</p>  <p>(6) To revert to the previous resolution without saving changes, move the cursor to CANCEL on screen and press the ◀ or ENTER button. The screen then returns to the RESOLUTION menu displaying the previous resolution.</p> <ul style="list-style-type: none"> • For some pictures, this function may not work well.

(continued on next page)

Item	Description
PbyP / PinP SETUP	<p>PinP POSITION Using ▲/▼ buttons on the remote control changes the position of sub area in PinP mode (📖 53).</p>
	<p>PbyP / PinP FRAME LOCK Select the screen that enables FRAME LOCK function when using PbyP or PinP. LEFT / PRIMARY: Enables FRAME LOCK function for input on left screen of PbyP or on primary area of PinP. RIGHT / SECONDARY: Enables FRAME LOCK function for input on right screen of PbyP or on secondary area of PinP.</p>

SETUP menu

Select an item from the Setup menu using the ▲/▼ cursor buttons, and press the ► cursor button or **ENTER** button to execute the item. Then perform it according to the following table.

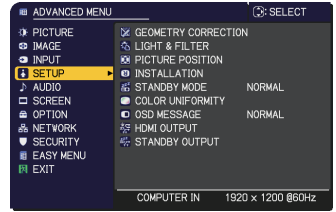

Item	Description
<p style="text-align: center;">GEOMETRY CORRECTION</p>	<p>KEystone Selecting this item displays the KEystone dialog. For details, see KEystone in Correcting the distortion (41).</p> <ul style="list-style-type: none"> • When the zoom adjustment is set to the TELE (telephoto focus), this function may be excessive. This function should be used when the zoom adjustment is set to the full WIDE (wide-angle focus). • When the horizontal lens shift is not set to the center, this function may not work correctly. • This function is unavailable when the screen is activated by PERFECT FIT (42), and WARPING (43).
	<p>PERFECT FIT Selecting this item displays the PERFECT FIT dialog. For details, see PERFECT FIT in Correcting the distortion (42).</p> <ul style="list-style-type: none"> • This function is unavailable when the screen is activated by KEystone (41), and WARPING (43).
	<p>WARPING Selecting this item displays the WARPING dialog. For details, see Application Manual of this feature.</p> <ul style="list-style-type: none"> • This function is unavailable when the screen is activated by KEystone (41) and PERFECT FIT (42).
	<p>EDGE BLENDING Selecting this item displays the EDGE BLENDING dialog. For details, see EDGE BLENDING feature (44 ~ 47).</p>



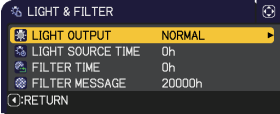

(continued on next page)

Item	Description
<p>GEOMETRY CORRECTION (continued)</p>	<p>PATTERN Select PATTERN with ▲/▼ buttons. Displayed pattern [Off/1/2/3/4/5/6] can be switched with ◀/▶ buttons. PATTERN 1: Frame PATTERN 2: Red Grid PATTERN 3: Green Grid PATTERN 4: Blue Grid PATTERN 5: Vertical 9 steps PATTERN 6: Horizontal 9 steps OFF: Displays the input signal.</p>
<p>LIGHT & FILTER</p>	<p>Selecting this item displays the LIGHT & FILTER menu. Select an item using the ▲/▼ buttons, and press the ▶ button or the ENTER button on the remote control to execute the item.</p>  <p>LIGHT OUTPUT Using the ▲/▼ buttons switches the LIGHT OUTPUT. NORMAL ↔ LONG LIFE 1 ↔ LONG LIFE 2 ↔ WHISPER ↑↔↔↔↑</p> <ul style="list-style-type: none"> • When the ambient temperature is around 35 to 45°C, the brightness of light source is reduced automatically. • When NORMAL is selected, you can change the brightness. • LONG LIFE 1 and LONG LIFE 2 are specialized modes for long life of the light source. They restrict the brightness of a light source and perform appropriate cooling for the long life of a light source. • WHISPER is a specialized mode for low noise. It restricts the brightness of a light source. • The brightness of the light source may be reduced depending on the direction of the projection. <p>LIGHT SOURCE TIME The light source time is the usage time of the light source.</p>

(continued on next page)

Item	Description
	<p>FILTER TIME Displays the usage time of the air filter, counted after the last resetting. Pressing the RESET button on the remote control or the ► button of the projector displays a dialog. To reset the filter time, select the OK using the ► button. CANCEL ⇨ OK</p> <ul style="list-style-type: none"> • Reset the filter time only when you have cleaned or replaced the air filter, for a suitable indication about the air filter. • For the air filter cleaning, see the section Cleaning and replacing the air filter (113).
<p>LIGHT & FILTER (continued)</p>	<p>FILTER MESSAGE Use the ▲/▼ button to set the timer for notifying by the message when to replace the filter unit After choosing an item except OFF, the message "REMINDER *** HRS PASSED" appears after the timer reaches the interval time set by this feature. When the OFF is chosen, the message does not appear. Use this feature to keep the air filter clean, setting the suitable time according to your environment of this projector.</p> <ul style="list-style-type: none"> • Clean the filter periodically. If the air filter becomes to be blocked by dust or other matter, the internal temperature rises, which could cause malfunction, or reduce the lifetime of the projector. • Be careful with the operating environment of the projector and the condition of the filter unit.

(continued on next page)

Item	Description
<p>PICTURE POSITION</p>	<p>Using the ▲/▼/◀/▶ cursor buttons selects the required picture position. The PICTURE POSITION is not changed if any of the following cases apply.</p> <ul style="list-style-type: none"> • There is no non-display area (black display or background display) or it is not displayed on the screen. • One of the following messages is displayed on the screen: "NO INPUT IS DETECTED" "SYNC IS OUT OF RANGE" "INVALID SCAN FREQ." • The BLANK or TEMPLATE function is selected.
<p>INSTALLATION</p>	<p>Pressing the ► button displays the dialog for changing the INSTALLATION setting.</p> <div style="display: flex; align-items: center; margin-bottom: 10px;">  <div style="margin-left: 10px;">FRONT / DESKTOP</div> </div> <div style="text-align: center; margin-bottom: 10px;">⇕</div> <div style="display: flex; align-items: center; margin-bottom: 10px;">  <div style="margin-left: 10px;">REAR / DESKTOP</div> </div> <div style="text-align: center; margin-bottom: 10px;">⇕</div> <div style="display: flex; align-items: center; margin-bottom: 10px;">  <div style="margin-left: 10px;">REAR / CEILING</div> </div> <div style="text-align: center; margin-bottom: 10px;">⇕</div> <div style="display: flex; align-items: center;">  <div style="margin-left: 10px;">FRONT / CEILING</div> </div> <p>Use the ▲/▼ buttons to select the required setting on the INSTALLATION dialog, and press the ENTER button of the remote control or the INPUT button of the projector to execute. If TRANSITION DETECTOR is ON and the INSTALLATION status is changed, the TRANSITION DETECTOR ON alarm (🔊109) is displayed when the projector is restarted.</p>

(continued on next page)

Item	Description
<p>STANDBY MODE</p>	<p>Using ▲/▼ buttons switches the standby mode setting.</p> <p>QUICK START: For quick start-up (Standby power increases). When the projector is set to QUICK START and in standby mode, POWER indicator blinks in Green 2 times for about 3 seconds. QUICK START is disabled in 30 minutes and the mode switches to NORMAL standby. In this case, POWER indicator lights in orange. Startup screen is not displayed when the projector is started in QUICK START. Fan operates while QUICK START is enabled.</p> <p>NORMAL: For using communication functions in the standby mode.</p> <p>NETWORK(WOL): For using Wake on LAN (WOL) function on wired network while reducing power consumption.</p> <p>SAVING: Reduces power consumption minimally.</p> <ul style="list-style-type: none"> • When NETWORK(WOL) or SAVING is selected, the following restrictions apply. <ul style="list-style-type: none"> - The RS-232C communication control except to turn the projector on are disabled while the projector is in the standby mode. If the COMMUNICATION TYPE in the COMMUNICATION menu is set to NETWORK BRIDGE, all of the RS-232C commands are disabled (P.100). - STANDBY OUTPUT is invalid. - The HDMI Link and HDBaseT™ functions are disabled while the projector is in the standby mode. - SCHEDULE function (Ex. POWER-ON) in the standby mode will not be operated. - It takes a while until the projector is available after starting up. - The CENTERING feature while the projector is in the standby mode is disabled if the STANDBY MODE item of SETUP menu is set to NETWORK(WOL) or SAVING (P.39). Perform CENTERING before the projector's power is turned off, or set the STANDBY MODE to NORMAL or QUICK START. • When NETWORK(WOL) is selected, only Wake on LAN (WOL) on wired LAN is accepted while the projector is in the standby mode. • This function is available only when OFF is selected for STACK MODE. • You cannot select NETWORK(WOL) when HDBaseT is selected in SERVICE menu - CONTROL TERMINAL - WIRED NETWORK.

(continued on next page)

Wake-On LAN (WOL) function

If you select NETWORK(WOL) in SETUP menu > STANDBY MODE, you can use the Wake-On LAN(WOL) function of wired network while saving power consumption in standby state.

Operation

Various communication functions can be used after the projector goes into NORMAL standby mode by receiving WOL Magic packet in standby state. However, the projector automatically goes back to NETWORK(WOL) standby mode with less power consumption if 10 minutes have passed after the projector goes into NORMAL standby mode by WOL Magic packet. It takes about 1 minute on a wired network or about 2 minutes on a wireless network until communication functions are available after WOL Magic packet has been received.

WOL Magic packet

Item	Specifications
Network	Wired network only
Protocol	UDP
Destination address	Broadcast address
Destination port number	Arbitrary
WOL Magic packet	A packet using MAC address of wired LAN of the projector (FF:FF:FF:FF:FF:FF(6 bytes)) followed by 102-byte data with MAC Address(6 bytes) repeated 16 times

(Example) WOL Magic packet for MAC Address: 01:02:03:04:05:06
 FF:FF:FF:FF:FF:FF: 01:02:03:04:05:06: 01:02:03:04:05:06: 01:02:03:04:05:06:
 01:02:03:04:05:06: 01:02:03:04:05:06: 01:02:03:04:05:06: 01:02:03:04:05:06:
 01:02:03:04:05:06: 01:02:03:04:05:06: 01:02:03:04:05:06: 01:02:03:04:05:06:
 01:02:03:04:05:06: 01:02:03:04:05:06: 01:02:03:04:05:06: 01:02:03:04:05:06:
 01:02:03:04:05:06:

NOTICE

Supported WOL Magic packet is a packet to be sent to broadcast address. General routers may not forward a packet of broadcast address to a device with a different network address by default. If you use a router like this, WOL function cannot be used for the projector that is not in the same network address. Consult with your network administrator about router settings. This function is available only in wired network and is not supported in wireless network.

Item	Description
<p>COLOR UNIFORMITY</p>	<p>Selects image level and region must be required corrected, and adjusts Color Balance. Divides the screen into nine regions and adjusts gain of R/G/B of each region.</p>
<p>OSD MESSAGE</p>	<p>Using the ▲/▼ buttons turns on/off the message function. NORMAL ↔ SILENT ↔ INHIBIT </p> <p>■SILENT : The following message functions do not work. “AUTO IN PROGRESS” while automatically adjusting “NO INPUT IS DETECTED” “SYNC IS OUT OF RANGE” “INVALID SCAN FREQ.” “NOT AVAILABLE” “Searching....” while searching for the input “Detecting....” while an input signal is detected The indication of the ZOOM displayed by changing *While operating from the remote control only. The indication of the FOCUS displayed by changing *While operating from the remote control only. The indication of the input signal displayed by changing The indication of the aspect ratio displayed by changing The indication of the PICTURE MODE displayed by changing The indication of the MY MEMORY displayed by changing The indication of “FREEZE” and “II” while freezing the screen by pressing the FREEZE button. The indication of the TEMPLATE displayed by changing. The indication of the LIGHT OUTPUT displayed by changing.</p> <p>■INHIBIT : All message functions do not work. The available buttons are as follows. STANDBY, ON</p>



(continued on next page)

Item	Description
<p>HDMI OUTPUT</p>	<p>To select the image output on the HDMI OUT in the normal operation.</p> <div style="border: 1px solid black; border-radius: 10px; padding: 5px;"> <p>NOTE • You cannot output image from HDMI OUT port while selecting DisplayPort.</p> </div>
<p>STANDBY OUTPUT</p>	<p><u>AUDIO OUT</u> To select the sound output in the standby mode.</p> <p><u>HDMI OUT</u> To select the image output on the HDMI OUT in the standby mode.</p> <p><u>MONITOR OUT</u> To select the image output on the MONITOR OUT in the standby mode.</p> <ul style="list-style-type: none"> • When the STANDBY MODE is set to NETWORK(WOL) or SAVING, the STANDBY OUTPUT menu cannot be operated.

AUDIO menu

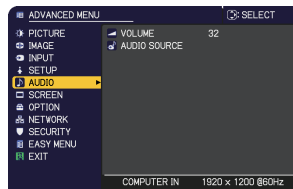



Select an item from the Audio menu using the ▲/▼ cursor buttons, and press the ► cursor button or the **ENTER** button to execute the item. Then perform it according to the following table.





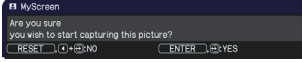

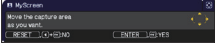
Item	Description								
VOLUME	Using the ◀/▶ buttons adjusts the volume of the audio output. Low ⇄ High								
AUDIO SOURCE	<p>While the image signal from the input port chosen in step (1) is projected, the audio signal from the input port selected in step (2) is output to the AUDIO OUT port.</p> <p>MP-WU8701W/MP-WU8701B MP-WU8801W/MP-WU8801B</p> <div style="display: flex; justify-content: space-around;">   </div> <p>(1) Choose a picture input port using the ▲/▼ buttons.</p> <p>(2) Select an audio input port or the mute icon using the ◀/▶ buttons. The icons indicate the following;</p> <table style="width: 100%; border: none;"> <tr> <td style="width: 50%;">No.1: AUDIO IN1 port</td> <td style="width: 50%;">No.2: AUDIO IN2 port</td> </tr> <tr> <td>No.3: HDMI 1 port</td> <td>No.4: HDMI 2 port</td> </tr> <tr> <td>No.5: DisplayPort port</td> <td>No.6: HDBaseT port</td> </tr> <tr> <td>No.7: LAN port</td> <td>⊗ : mutes the sound</td> </tr> </table> <ul style="list-style-type: none"> • C.C. is automatically activated when ⊗ is selected and an input signal containing C.C. is received. This function is available only when the signal is NTSC for VIDEO or COMPUTER IN, and when AUTO is selected for DISPLAY in the C.C. menu under the SCREEN menu (1186). • For the setting of AUDIO OUT, refer to AUDIO OUT of STANDBY OUTPUT in the SETUP menu. 	No.1: AUDIO IN1 port	No.2: AUDIO IN2 port	No.3: HDMI 1 port	No.4: HDMI 2 port	No.5: DisplayPort port	No.6: HDBaseT port	No.7: LAN port	⊗ : mutes the sound
No.1: AUDIO IN1 port	No.2: AUDIO IN2 port								
No.3: HDMI 1 port	No.4: HDMI 2 port								
No.5: DisplayPort port	No.6: HDBaseT port								
No.7: LAN port	⊗ : mutes the sound								

Item	Description
<p>AUTO BLANK</p>	<p>Using the ▲/▼ buttons switches the mode for the AUTO BLANK screen.</p> <p>BLUE ⇄ WHITE ⇄ BLACK</p> <p style="text-align: center;">↑—————↑</p> <ul style="list-style-type: none"> • To avoid remaining as an afterimage, displayed image changes to the designated blank color screen by AUTO BLANK after several minutes at the following conditions. - When MyScreen or ORIGINAL is displayed as BLANK screen. - When start-up screen is displayed.
<p>START UP</p>	<p>Using the ▲/▼ buttons switches the mode for the start-up screen. The start-up screen is a screen displayed when no signal or an unsuitable signal is detected.</p> <p>MyScreen ⇄ ORIGINAL ⇄ OFF</p> <p style="text-align: center;">↑—————↑</p> <p><u>MyScreen</u> : Screen can be registered by the MyScreen item (📖83).</p> <p><u>ORIGINAL</u> : Screen preset as the standard screen.</p> <p><u>OFF</u> : Plain black screen.</p> <ul style="list-style-type: none"> • To avoid the image burning into the screen, the START UP screen changes to the AUTO BLANK screen after several minutes. • When the ON is selected to the MyScreen PASSWORD item in the SECURITY menu (📖107), the START UP is fixed to MyScreen.

(continued on next page)

Item	Description
MyScreen	<p>You can capture an image for use as a MyScreen image which can be used as the BLANK screen and START UP screen. Display the image you want to capture before executing the following procedure.</p> <p>(1) Selecting this item displays a dialog titled "MyScreen". It asks you if you start capturing an image from the current screen.</p>  <p>Wait for the target image to be displayed, and press the ENTER or INPUT button when the image is displayed. The image freezes and the frame for capturing appears.</p> <p>To stop performing, press the RESET button on the remote control.</p> <p>(2) Using the ▲/▼/◀/▶ buttons adjusts the frame position.</p>  <p>Move the frame to the position of the image which you want to use. The frame may not be able to be moved for some input signals.</p>  <p>To start registration, press the ENTER or INPUT button on the remote control.</p>  <p>To restore the screen and return to the previous dialog, press the RESET button on the remote control.</p> <p>Registration may take several minutes.</p> <p>When the registration is completed, the registered screen and the following message is displayed for several seconds:</p> <p>"MyScreen registration is finished."</p> <p>If the registration failed, the following message is displayed:</p> <p>"A capturing error has occurred. Please try again."</p> <ul style="list-style-type: none"> • This function cannot be selected when ON is selected for the MyScreen Lock item (1084). • This function cannot be selected when ON is selected for the MyScreen PASSWORD item in SECURITY menu (1107). • This function is unavailable for a signal from the LAN, HDMI 1 / 2, DisplayPort, HDBaseT or 3G-SDI port.

(continued on next page)

Item	Description
<p>MyScreen Lock</p>	<p>Using the ▲/▼ buttons turns on/off the MyScreen lock function. ON ⇔ OFF</p> <p>When the ON is selected, the item MyScreen is locked. Use this function for protecting the current MyScreen.</p> <ul style="list-style-type: none"> This function cannot be selected when the ON is selected to the MyScreen PASSWORD item in SECURITY menu (107).
<p>SOURCE NAME</p>	<p>Each input port for this projector can have a name applied to it.</p> <ol style="list-style-type: none"> Use the ▲/▼ buttons on the SCREEN menu to select SOURCE NAME and press the ► or ENTER button. The SOURCE NAME menu is displayed. Use the ▲/▼ buttons on the SOURCE NAME menu to select the port to be named and press the ► button. The SOURCE NAME dialog is displayed. Right side of the menu is blank until a name is specified. MP-WU8701W/MP-WU8701B MP-WU8801W/MP-WU8801B <div style="display: flex; justify-content: space-around;">   </div> <ol style="list-style-type: none"> Select an icon you want to assign to the port in the SOURCE NAME dialog. The name assigned to the port is automatically switched according to your icon selection. Press the ENTER or INPUT button to determine your icon selection. Select a number you want to assign to the port along with the icon. You can select the number either from blank (no number assigned), 1, 2, 3, or 4. Then press the ENTER or INPUT button. If you want to modify the name assigned to the port, select CUSTOM NAME and press the ENTER or INPUT button. <p>MP-WU8701W/MP-WU8701B MP-WU8801W/MP-WU8801B</p> <div style="display: flex; justify-content: space-around;">   </div>

(continued on next page)

Item	Description
<p>SOURCE NAME (continued)</p>	<p>(6) The current name is displayed on the first line. Use the ▲/▼/◀/▶ buttons and the ENTER or INPUT button to select and enter characters. To erase one character at a time, press the RESET button or press the ◀ and INPUT button simultaneously. Also, if you move the cursor to DELETE or CLEAR ALL on screen and press the ENTER or INPUT button, one or all characters are erased. The name can be a maximum of 16 characters.</p> <p>(7) To change an already inserted character, press the ▲ button to move the cursor to the first line, and use the ◀/▶ buttons to move the cursor on the character to be changed. After pressing the ENTER or INPUT button, the character is selected. Then, follow the same procedure as described at the item (6) above.</p> <p>(8) To finish entering text, move the cursor to the OK on screen and press the ▶, ENTER or INPUT button. To revert to the previous name without saving changes, move the cursor to the CANCEL on screen and press the ◀, ENTER or INPUT button.</p>
<p>TEMPLATE</p>	<p>Using the ▲/▼ cursor buttons switches the mode for the template screen. Press the ▶ cursor (or the ENTER) button to display the selected template, and press the ◀ cursor button to close the displayed screen.</p>



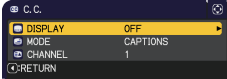

(continued on next page)

Item	Description
<p>C.C.</p>	<p>The C.C. is the function that displays a transcript or dialog of the audio portion of a video, files or other presentation or other relevant sounds. It must have NTSC format video or 480i@60 format component video source supporting C.C. feature to utilize this function.</p> <p>It may not work properly, depending on equipment or signal source. In this case, turn off the Closed Caption.</p> 
	<p>DISPLAY</p> <p>Select Closed Caption DISPLAY setting from following options using ▲/▼ buttons.</p> <p>AUTO ⇄ ON ⇄ OFF</p> <p style="text-align: center;">↑—————↓</p> <p><u>AUTO</u> : Closed Caption automatically appears when the input signal (C.C. compatible) from the port with the mute icon set at AUDIO SOURCE is selected.</p> <p><u>ON</u> : Closed Caption is on.</p> <p><u>OFF</u> : Closed Caption is off.</p> <ul style="list-style-type: none"> • The caption is not displayed when the OSD menu is active. • The Closed Caption is the function to display the dialogue, narration, and / or sound effects of a television program or other video sources. The Closed Caption availability depends upon broadcaster and/or content.
	<p>MODE</p> <p>Select Closed Caption MODE setting from following options using ▲/▼ buttons.</p> <p>CAPTIONS ⇄ TEXT</p> <p><u>CAPTIONS</u> : Display Closed Caption.</p> <p><u>TEXT</u> : Display Text data, which is for additional information such as news reports or a TV program guide. The information covers the entire screen. Not all of the C.C. program has Text information.</p>
	<p>CHANNEL</p> <p>Select Closed Caption CHANNEL from following options using ▲/▼ buttons.</p> <p>1 ⇄ 2 ⇄ 3 ⇄ 4</p> <p style="text-align: center;">↑—————↓</p> <p>1: Channel 1, primary channel / language</p> <p>2: Channel 2</p> <p>3: Channel 3</p> <p>4: Channel 4</p> <p>The channel data may vary, depending on the content. Some channel might be used for secondary language or empty.</p>

OPTION menu

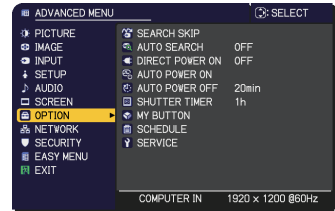
Select an item from the Option menu using the ▲/▼ cursor buttons, and press the ► cursor button or ENTER button to execute the item. Then perform it according to the following table.





Item	Description
<p>SEARCH SKIP</p>	<p>The ports can be set to be ignored in searching by the AUTO SEARCH function (see below) or in selecting by buttons on the control panel.</p> <p>MP-WU8701W/MP-WU8701B MP-WU8801W/MP-WU8801B</p> <div style="display: flex; justify-content: space-around;">   </div> <p>(1) Choose a picture input port using the ▲/▼ buttons. (2) Using the ◀/▶ buttons turns on/off the SEARCH SKIP function. NORMAL ⇔ SKIP</p> <p>The port that is set to SKIP is ignored.</p> <ul style="list-style-type: none"> • You cannot set SKIP to all ports at the same time. • This setting is not valid when in the PbyP / PinP mode (see 50).
<p>AUTO SEARCH</p>	<p>Using the ▲/▼ buttons turns on/off the automatic signal search function.</p> <p>ON ⇔ OFF</p> <p>When ON is selected, detecting no signal automatically cycles through input ports in the following order. The search is started from the current port. When an input is found, the projector stops searching and display the image.</p> <pre style="text-align: center;"> LAN ⇔ COMPUTER IN ⇔ HDMI 1 ↑ ↓ VIDEO HDMI 2 ↑ ↓ 3G-SDI* ⇔ HDBaseT ⇔ DisplayPort </pre>

* MP-WU8801W/MP-WU8801B only
 (continued on next page)

Item	Description
<p>DIRECT POWER ON</p>	<p>Using the ▲/▼ buttons turns on/off the DIRECT POWER ON function. ON ⇔ OFF</p> <p>When set to the ON, the light source in projector will be automatically turned on without the usual procedure (p.31), only when the projector is supplied with the power after the power was cut while the light source was on.</p> <ul style="list-style-type: none"> • This function does not work as long as the power has been supplied to the projector while the light source is off. • After turning the light source on by the DIRECT POWER ON function, if neither input nor operation is detected for about 20 minutes, the projector is turned off, even if the AUTO POWER OFF function (p.89) is disabled. <p>⚠ WARNING ▶ Be sure to confirm that the projector has been installed and connected safely even if it is turned on automatically.</p>
<p>AUTO POWER ON</p>	<p>When the projector is in the standby mode and detects the video signal input from external device, this function starts up the projector to display the image automatically on the screen. This function can be enabled by selecting an input referring to the displayed list.</p> <ul style="list-style-type: none"> • This function is unavailable when STANDBY MODE is set to NETWORK(WOL) or SAVING. • This function may work unintentionally by connected external device. <p>⚠ WARNING ▶ When this function is enabled, the projector may turn on unintentionally by operating the device connected to it. Be sure not to put anything on or around the projector. ▶ Be sure to confirm that the projector has been installed and connected safely even if it is turned on automatically.</p>

(continued on next page)

Item	Description
<p>AUTO POWER OFF</p>	<p>Using the ▲/▼ buttons adjusts the time to count down to automatically turn the projector off.</p> <p>Long (max. 99 minutes) ⇔ Short (min. 0 minute = DISABLE)</p> <div style="display: flex; justify-content: space-around; align-items: center;">   </div> <p>When the time is set to 0, the projector is not turned off automatically.</p> <p>When the time is set to 1 to 99, and when the passed time with no-signal or an unsuitable signal reaches at the set time, the light source is turned off.</p> <p>If one of the projector's buttons or the remote control buttons is pressed or one of the commands (except get commands) is transmitted to the CONTROL port during the corresponding time, the projector is not turned off.</p> <p>Refer to the section Turning off the power (31).</p>
<p>SHUTTER TIMER</p>	<p>Using the ▲/▼ buttons sets the time from closing the shutter to automatically turning the projector off.</p> <p>1h ⇔ 3h ⇔ 6h</p>  <ul style="list-style-type: none"> • The shutter opens automatically when turning the projector on again.

(continued on next page)

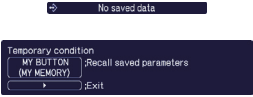
Item	Description
<p>MY BUTTON</p>	<p>This item is to assign one of the following functions to MY BUTTON (1 to 4) on the remote control (☞7).</p> <p>(1) Use the ▲/▼ buttons on the MY BUTTON menu to select a MY BUTTON (1-4).</p> <p>(2) Then using the ◀/▶ buttons sets one of the following functions to the chosen button.</p> <p>MY IMAGE: Displays the MY IMAGE menu. (☞5. My Image Function in the Network Guide)</p> <p>MESSENGER: Turns the messenger text displayed on the screen on/off (☞6. Messenger Function in the Network Guide). When there is no transferred text data to display, the message "NO MESSENGER DATA" appears.</p> <p>BLANK: Switches the BLANK function to on or off.</p> <p>SHUTTER: Turns the shutter closed and opened (☞49).</p> <p>PbyP / PinP SWAP: Swaps the picture on the right with one on the left in the PbyP mode. Swaps the primary picture and the secondary picture in the PinP mode. (☞50)</p> <p>PinP POSITION: Toggles the PinP position.</p> <p>INFORMATION: Displays SYSTEM_INFORMATION, INPUT_INFORMATION (☞104), WIRELESS_INFORMATION, WIRED_INFORMATION, OTHER_INFORMATION or nothing.</p> <p>MY MEMORY: Loads one of adjustment data stored (☞62). When more than two data are saved, the adjustment changes every time the MY BUTTON is pressed. When no data is saved in memory, the dialog "No saved data" appears.</p> <p>When the current adjustment is not saved to memory, the dialog as shown in the right appears.</p>  <p>To keep the current adjustment, press the ▶ button to exit. Otherwise loading a data overwrites the current adjusted condition.</p> <p>PICTURE MODE: Changes the PICTURE MODE (☞60).</p> <p>FILTER RESET: Displays the filter time reset confirmation dialogue (☞74).</p> <p>TEMPLATE: Makes the template pattern selected to the TEMPLATE item (☞85) appear or disappear.</p> <p>MUTE: Turns the audio mute on/off.</p> <p>RESOLUTION: Turns on/off the RESOLUTION dialog (☞70).</p> <p>LIGHT OUTPUT: Changes the LIGHT OUTPUT dialog (☞73).</p>

(continued on next page)

Item	Description								
<p>MY BUTTON (continued)</p>	<p><u>ACCENTUALIZER</u>: Turns on/off the ACCENTUALIZER dialog (P.62). <u>HDCR</u>: Turns on/off the HDCR dialog (P.62). <u>MY BUTTON</u>: Turn on/off the MY BUTTON dialog (P.90).</p>								
<p>SCHEDULE</p>	<p>■ How to setup the item</p> <ol style="list-style-type: none"> 1. Use the ▲/▼/◀/▶ cursor buttons to select or adjust. 2. Select OK to finish the settings. <div style="border: 1px solid black; border-radius: 10px; padding: 5px; margin: 10px 0;"> <p>NOTE • Refer to the actual on-screen display(OSD) for appropriate operation.</p> </div> <table border="1" style="width: 100%; border-collapse: collapse;"> <thead> <tr> <th data-bbox="303 523 521 561">Item</th> <th data-bbox="521 523 1034 561">Description</th> </tr> </thead> <tbody> <tr> <td data-bbox="303 561 521 655"> <p>DATE & TIME</p> </td> <td data-bbox="521 561 1034 655"> <p>Inputs the current date (year/month/day) and the time (24-hour clock) to set a reference time in the projector.</p> </td> </tr> <tr> <td data-bbox="303 655 521 775"> <p>SPECIFIC DATE</p> </td> <td data-bbox="521 655 1034 775"> <p>Specifies the date (month/day) if you execute only one specific day. You can set 10 different schedules from SPECIFIC DATE-1 to SPECIFIC DATE-10.</p> </td> </tr> <tr> <td data-bbox="303 775 521 895"> <p>PROGRAM EDIT</p> </td> <td data-bbox="521 775 1034 895"> <p>Sets what event to execute at what time of the day. One program can be set in one day, and up to 16 programs can be set. Up to 20 events can be set in one program.</p> </td> </tr> </tbody> </table> <p>■ Setting procedure</p> <ol style="list-style-type: none"> ① Determine the current date/time as reference in DATE AND TIME. ② Make a schedule of what event to execute at what time of the day in PROGRAM EDIT. ③ Select the date (one specific day: SPECIFIC DATE or the days of the week: every week) to be scheduled, then select a program. <p>Switch the screen of the days of the week and SPECIFIC DATE by vertical scroll. (Page 1 of 2: Days of the week, Page 2 of 2: SPECIFIC DATE)</p>	Item	Description	<p>DATE & TIME</p>	<p>Inputs the current date (year/month/day) and the time (24-hour clock) to set a reference time in the projector.</p>	<p>SPECIFIC DATE</p>	<p>Specifies the date (month/day) if you execute only one specific day. You can set 10 different schedules from SPECIFIC DATE-1 to SPECIFIC DATE-10.</p>	<p>PROGRAM EDIT</p>	<p>Sets what event to execute at what time of the day. One program can be set in one day, and up to 16 programs can be set. Up to 20 events can be set in one program.</p>
Item	Description								
<p>DATE & TIME</p>	<p>Inputs the current date (year/month/day) and the time (24-hour clock) to set a reference time in the projector.</p>								
<p>SPECIFIC DATE</p>	<p>Specifies the date (month/day) if you execute only one specific day. You can set 10 different schedules from SPECIFIC DATE-1 to SPECIFIC DATE-10.</p>								
<p>PROGRAM EDIT</p>	<p>Sets what event to execute at what time of the day. One program can be set in one day, and up to 16 programs can be set. Up to 20 events can be set in one program.</p>								

(continued on next page)

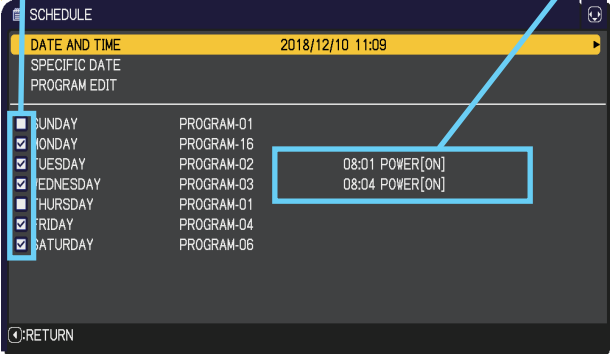
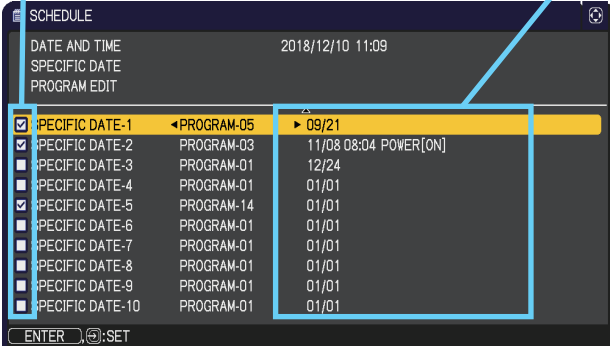
Item	Description
<p>SCHEDULE (continued)</p>	<p>■ How to activate (DATE AND TIME / SPECIFIC DATE) Place a checkmark in the box.</p> <p>Checkmark in the box</p> <p>Date and first setup info could be seen with the check mark.</p> 
	<p>1/2 page (Set the DATE(Year/Month/Date) and Time(24-hour scale).)</p> <p>Checkmark in the box</p> <p>Date and first setup info could be seen with the check mark.</p>  <p>2/2 page (Set specific date from 1 to 10.)</p> <p>Press the ▼ cursor button to move from 1/2 page to 2/2 page with the state of selecting "SATURDAY".</p>

(continued on next page)



Item	Description
<p>SCHEDULE (continued)</p>	<p>■ PROGRAM EDIT</p> <p>The TIME and EVENT for Program 1 to 16 can be edited.</p> <ul style="list-style-type: none"> • RETURN Select this to return to the top menu of the SCHEDULE. • SELECT Select from PROGRAM-01 to 16 to edit. Up to 20 events can be set in each program. • COPY TO The selected program (with the settings of TIME and EVENT) can be copied to other program. • APPLY Select this to apply and save all adjustments and settings.

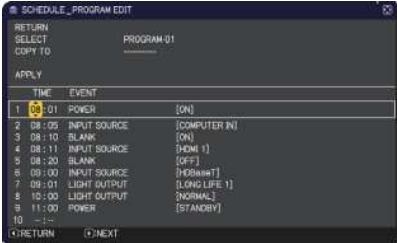

(continued on next page)

Item	Description
<p>SCHEDULE (continued)</p>	<p>■ How to edit the selected PROGRAM</p> <ol style="list-style-type: none"> 1. Select from 1 to 20 events. Use the ▲/▼ cursor buttons to select. Press ► cursor button to set the TIME and EVENT. 2. Use the ◀/▶ cursor buttons to select. 3. Use the ▲/▼ cursor buttons to adjust.  <p>EVENT can be selected as listed below.</p> <ul style="list-style-type: none"> ◦ POWER – ON, STANDBY ◦ INPUT SOURCE – "input source" channel ◦ MY IMAGE – IMAGE-1 to 4, IMAGE OFF ◦ MESSENGER – TEXT-1 to 12, TEXT OFF ◦ LIGHT OUTPUT – NORMAL, LONG LIFE 1, LONG LIFE 2, WHISPER ◦ BLANK – ON, OFF  <ol style="list-style-type: none"> 4. Press ► cursor button to finish the settings. 5. Select APPLY to save the settings. <div style="border: 1px solid black; border-radius: 15px; padding: 10px; margin-top: 10px;"> <p>NOTE • Refer to the on-screen display(OSD) for the appropriate operation.</p> <ul style="list-style-type: none"> • When the STANDBY MODE is set to NETWORK(WOL) or SAVING, SCHEDULE function at STANBY MODE (Ex:POWER-ON) will not be operated. </div>

(continued on next page)

Item	Description
SERVICE	<p>Selecting this item displays the SERVICE menu.</p> <p>Select an item using the ▲/▼ buttons, and press the ► button or the ENTER button on the remote control to execute the item.</p> 
	<p>ALTITUDE</p> <p>Using the ▲/▼ buttons switches the rotation speed of the cooling fans. If the projector is used at an altitude of about 1600 m or higher, select HIGH. Otherwise, select AUTO. Note that the projector is noisier when the HIGH is selected.</p> <p>HIGH ⇄ AUTO</p>
	<p>AUTO ADJUST</p> <p>Using the ▲/▼ buttons to select one of the mode. When the DISABLE is selected, the automatic adjustment feature is disabled.</p> <p>FINE ⇄ FAST ⇄ DISABLE</p>  <p>FINE: Finer tuning including H.SIZE adjustment. FAST: Faster tuning, setting H.SIZE to prearranged data for the input signal.</p> <ul style="list-style-type: none"> Depending on conditions, such as input image, signal cable to the projector, environment around the projector, and so on, the automatic adjustment may not work correctly. If this occurs, choose DISABLE to disable the automatic adjustment, and make the adjustment manually.
	<p>GHOST</p> <p>Adjust the settings using the ▲/▼ buttons to eliminate ghosting.</p>

(continued on next page)

Item	Description
<p>SERVICE (continued)</p>	<p>LENS TYPE</p> <p>(1) Select the lens type currently used using the ▲/▼ buttons and press the ► or ENTER button. If AUTO is selected, the projector determines the lens type automatically.</p> <p>(2) A message dialog is displayed for confirmation. Press the ► or ENTER button to save the lens type.</p> <ul style="list-style-type: none"> • This setting has an influence on the keystone distortion and so on. • The lens type determined by the projector is displayed on the right of "AUTO". • If the projector cannot determine the lens type automatically when this item is set to AUTO, "UNKNOWN LENS" is displayed on the right of "AUTO". • For information about the optional lens, contact your dealer.
	<p>LENS LOCK</p> <p>Using the ▲/▼ buttons turns on/off the lens lock feature. When ON is selected, the buttons (ZOOM, ZOOM + / -, FOCUS, FOCUS + / -, SHIFT, LENS SHIFT, LENS MEMORY) are locked.</p> <p>ON ⇄ OFF</p>

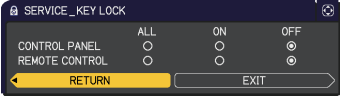
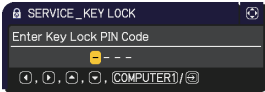
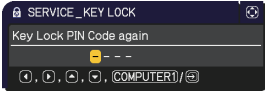

(continued on next page)

Item	Description
<p>SERVICE (continued)</p>	<p>KEY LOCK</p> <p>(1) Use the ▲/▼ buttons to choose the operations control. CONTROL PANEL ⇄ REMOTE CONTROL</p> <p>(2) Use the ◀/▶ buttons to select ALL, ON or OFF. ALL ⇄ ON ⇄ OFF</p>  <p>If you select ALL, all key functions are disabled. Selecting ON in Step 2 locks the buttons except STANDBY/ON on the operations control selected in Step 1. Selecting OFF releases the locked buttons on the operations control selected in Step 1.</p> <ul style="list-style-type: none"> • Use this function to prevent tampering or accidental operation. • It's not possible to disable both options at the same time. • If you select ALL, the screen for setting a PIN code appears. Set it as follows. <ol style="list-style-type: none"> Setting a PIN code <ol style="list-style-type: none"> When using the ◀/▶ button to select ALL, a confirmation message appears. Press the ▶ button to display the Enter Key Lock PIN Code box. Input a 4 part PIN code using the ▲/▼/◀/▶, INPUT, or ↵ button. <p>The Key Lock PIN Code again box will appear.</p> <p>Reenter the same PIN code. This will complete the PIN code registration.</p> <p>If there is no key input for about 55 seconds while the Enter Key Lock PIN Code box or the Key Lock PIN Code again box is displayed, the menu will close.</p> <ul style="list-style-type: none"> • Write down the PIN code so as not to forget it.  

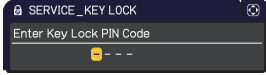
(continued on next page)

Item	Description
<p>SERVICE (continued)</p>	<p>2. Disabling the PIN code lock function If you unlock this item by locked keys, enter registered PIN code while OSD is not displayed. The SECURITY indicator blinks while entering the PIN code. If you unlock this item by unlocked keys, follow the steps below. Unlocked keys: If REMOTE CONTROL is set to ALL, they are control panel. If CONTROL PANEL is set to ALL, they are remote control.</p> <p>When you press the ► button while ALL is set, the Enter Key Lock PIN Code box appears. The PIN code lock function is disabled when the registered PIN code is entered.</p> <p>If an incorrect PIN code is input, the dialog box will be displayed again.</p> 

(continued on next page)

Item	Description
<p>SERVICE (continued)</p>	<p>REMOTE RECEIV.</p> <p>(1) Select a remote sensor using the ▲/▼ button. FRONT ⇄ REAR ⇄ HDBaseT </p> <p>(2) Switch it using the ◀/▶ button. ON ⇄ OFF</p> <ul style="list-style-type: none"> • When one sensor is turned off, the other cannot be turned off.
	<p>REMOTE FREQ.</p> <p>(1) Use the ▲/▼ button to change the projector's remote sensor frequency setting (📖4, 29). 1:NORMAL ⇄ 2:HIGH</p> <p>(2) Use the ◀/▶ button to change the projector's remote sensor on or off. ON ⇄ OFF</p> <p>If the remote control does not function correctly, disable either of them.</p> <ul style="list-style-type: none"> • You cannot disable both options at the same time.
	<p>REMOTE ID</p> <p>This menu is displayed when selecting this item and pressing any of the ID 1-4 buttons of the optional remote control. Use the ▲/▼ buttons on the REMOTE ID menu to select ID and press the ▶ button.</p> <p>ALL ⇄ 1 ⇄ 2 ⇄ 3 ⇄ 4 </p> <p>The projector is controlled by the remote control whose ID button is set the same number as this number. When the ALL is selected, the projector is controlled by a remote control irrespective of the ID setting.</p> <ul style="list-style-type: none"> • Available only in optional remote control.

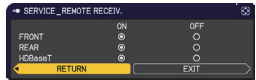

(continued on next page)

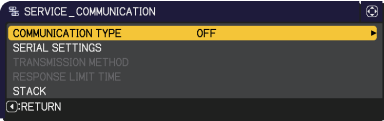
Item	Description	
<p>SERVICE (continued)</p>	<p>COMMUNICATION</p>	<p>Selecting this item displays COMMUNICATION menu. In this menu, you can configure the serial communication settings of the projector using the CONTROL port.</p>  <ul style="list-style-type: none"> • Select an item using the cursor buttons ▲/▼. Then pressing the ► button opens the submenu for the setting item you selected. Or, pressing the ◀ button instead of the ► button makes the menu back to the previous one without changing the setup. Each submenu can be operated as described above. • For the function of serial communication, refer to the Network Guide.
		<p>COMMUNICATION TYPE</p> <p>Select the communication type for transmission using the CONTROL port.</p> <p>NETWORK BRIDGE: Select this type, if it is required to control an external device as a network terminal, using this projector from the computer. The CONTROL port does not accept RS-232C commands (☞ 7. Network Bridge Function in the Network Guide).</p> <p>OFF: Select this mode to receive RS-232C commands using the CONTROL port.</p> <ul style="list-style-type: none"> • OFF is the default setting. • When you select the NETWORK BRIDGE, check the item, TRANSMISSION METHOD (☞ 101).

(continued on next page)

Item	Description	
SERVICE (continued)	COMMUNICATION (continued)	<p>SERIAL SETTINGS Select the serial communication condition for the CONTROL port.</p> <p>BAUD RATE 4800bps ⇔ 9600bps ⇔ 19200bps ⇔ 38400bps ↑—————↑</p> <p>PARITY NONE ⇔ ODD ⇔ EVEN ↑—————↑</p>
		<p>TRANSMISSION METHOD Select the transmission method for communication by the NETWORK BRIDGE from the CONTROL port.</p> <p>HALF-DUPLEX ⇔ FULL-DUPLEX</p> <p><u>HALF-DUPLEX</u>: This method lets the projector make two way communication, but only one direction, either transmitting or receiving data, is allowed at a time.</p> <p><u>FULL-DUPLEX</u>: This method lets the projector make two way communication, transmitting and receiving data at the same time.</p> <ul style="list-style-type: none"> • HALF-DUPLEX is selected as the default setting. • If you select HALF-DUPLEX, check the setting of the item RESPONSE LIMIT TIME (📖102).



(continued on next page)

Item	Description	
<p style="text-align: center;">SERVICE (continued)</p>	<p style="text-align: center;">COMMUNICATION (continued)</p>	<p>RESPONSE LIMIT TIME Select the time period to wait for receiving response data from other device communicating by the NETWORK BRIDGE and the HALF-DUPLEX through the CONTROL port.</p> <p style="text-align: center;">OFF ⇔ 1s ⇔ 2s ⇔ 3s </p> <p>OFF: Select this mode if it is not required to check the responses from the device that the projector sends data to. In this mode, the projector can send out data from the computer continuously.</p> <p>1s /2s /3s: Select the time period to keep the projector waiting for response from the device that the projector sends data to. While waiting a response, the projector does not send out any data from the CONTROL port.</p> <ul style="list-style-type: none"> • This menu is available only when the NETWORK BRIDGE is selected for the COMMUNICATION TYPE and the HALF-DUPLEX is selected for the TRANSMISSION METHOD (101). • OFF is selected as the default setting.
		<p>STACK Selecting this item displays the STACK menu. For more information, see the Instant Stack Guide.</p> <ul style="list-style-type: none"> • When STACK MODE is set to MAIN or SUB, the other items in COMMUNICATION menu are invalid.
	<p style="text-align: center;">CONTROL TERMINAL</p>	<p>WIRED NETWORK Selects whether to use LAN or HDBaseT port. LAN ⇔ HDBaseT</p> <div style="border: 2px solid black; border-radius: 15px; padding: 10px;"> <p>NOTE • Only the LAN or HDBaseT port can be used for the connection to the network. Switch it according to the environment.</p> <ul style="list-style-type: none"> • You cannot operate CONTROL TERMINAL when NETWORK(WOL) is selected in SETUP menu - STANDBY MODE. </div>

(continued on next page)

Item	Description	
SERVICE (continued)	REMOTE CONTROL OUT	<p>Switches REMOTE CONTROL OUT port.</p> <p>1) Use the ▲ / ▼ buttons to select switching mode. REMOTE CONTROL: Switches ON/OFF of the signal of an infrared remote control or a wired remote control. HDBaseT: Switches ON/OFF of the remote control signal from HDBaseT.</p> <p>2) Use the ◀/▶ buttons to switch ON/OFF. ON ⇔ OFF</p> <p>The projector or the projector connected to REMOTE CONTROL OUT may not operate correctly if they are operated from multiple remote controls at the same time.</p>
	HDMI OUT RESOLUTION	<p>Selects the device to refer to the resolution information of HDMI output. EXTERNAL DEVICE ⇔ PROJECTOR</p> <ul style="list-style-type: none"> • When EXTERNAL DEVICE is selected, the resolution of the signal input to the projector and signal output from the projector may be restricted by the maximum resolution of the connected device such as projector or monitor. • When PROJECTOR is selected, the image from the device connected to HDMI OUT may not be displayed normally.

(continued on next page)

Item	Description
<p>SERVICE (continued)</p>	<p>INFORMATION</p> <p>Selecting this item displays a dialog titled “INPUT_INFORMATION”. It shows the information about the current input.</p> <div style="display: flex; justify-content: space-around; align-items: center;">    </div> <ul style="list-style-type: none"> • The “FRAME LOCK” message on the dialog means the frame lock function is working. • This item cannot be selected for no signal and sync out. • When the MY TEXT DISPLAY is set to ON, the MY TEXT is displayed together with the input information in the INPUT_INFORMATION box (111).
	<p>FACTORY RESET</p> <p>Selecting OK using the ► button performs this function. By this function, all menu items are collectively returned to the initial setting. Note that the items LIGHT SOURCE TIME, FILTER TIME, LANGUAGE, AUTO BLANK, FILTER MESSAGE, STANDBY MODE, COMMUNICATION, SCHEDULE, CONTROL TERMINAL, REMOTE CONTROL OUT, NETWORK and SECURITY settings are not reset.</p> <p>CANCEL ⇨ OK</p>

NETWORK menu

See the **Network Guide** for details of NETWORK operation.

Remember that incorrect network settings on this projector may cause trouble on the network. Consult with your network administrator before connecting to an existing access point on your network.

SECURITY menu

This projector is equipped with security functions. From the SECURITY menu, items shown in the table below can be performed.

To use SECURITY menu: User registration is required before using the security functions.

Enter to the SECURITY menu

1. Press the ► button. The ENTER PASSWORD box is displayed.
2. Use the ▲/▼/◀/▶ buttons to enter the registered password. The factory default password is as follows.
2416

This password can be changed (see below). Move the cursor to the right side of the ENTER PASSWORD box and press the ► button to display the SECURITY menu.

- It is strongly recommended the factory default password to be changed as soon as possible.
- If an incorrect password is input, the ENTER PASSWORD box is displayed again. If incorrect password is input three times, the projector turns off. Afterwards the projector then turns off every time an incorrect password is input.

3. Items shown in the table below can be performed.

If you have forgotten your password

(1) While the ENTER PASSWORD box is displayed, press and hold the **RESET** button on the remote control for approximately three seconds or press and hold the **INPUT** button for three seconds while pressing the ► button on the projector.



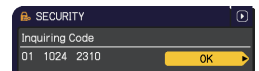
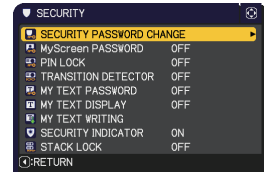
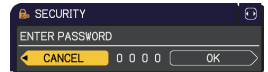
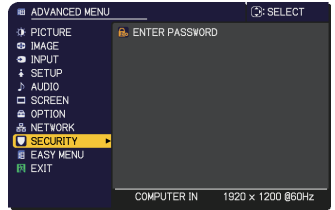

(2) The 10 digit Inquiring Code is displayed. Contact your dealer with the 10 digit Inquiring Code. Your password is sent after your user registration information is confirmed.

- If there is no key input for approximately 55 seconds while the Inquiring Code is displayed, the menu closes. If necessary, repeat the process from (1).



Item	Description
<p>SECURITY PASSWORD CHANGE</p>	<ol style="list-style-type: none"> (1) Use the ▲/▼ buttons on the SECURITY menu to select SECURITY PASSWORD CHANGE and press the ► button to display the ENTER NEW PASSWORD box. (2) Use the ▲/▼/◀/▶ buttons to enter the new password. (3) Move the cursor to the right side of the ENTER NEW PASSWORD box and press the ► button to display the NEW PASSWORD AGAIN box, enter the same password again. (4) Move the cursor to the right side of the NEW PASSWORD AGAIN box and press the ► button and the NOTE NEW PASSWORD box is displayed for approximately 30 seconds. Make note of the password during this time. Pressing the ENTER button on the remote control or ► button on the projector closes the NOTE NEW PASSWORD box. <ul style="list-style-type: none"> • Do not forget your password.

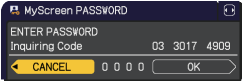

(continued on next page)

Item	Description
<p>MyScreen PASSWORD</p>	<p>The MyScreen PASSWORD function can be used to prohibit access to the MyScreen function and prevent the currently registered MyScreen image from being overwritten.</p> <p>1 Turning on the MyScreen PASSWORD</p> <p>1-1 Use the ▲/▼ buttons on the SECURITY menu to select MyScreen PASSWORD and press the ► button to display the MyScreen PASSWORD on/off menu.</p>  <p>1-2 Use the ▲/▼ buttons on the MyScreen PASSWORD on/off menu to select ON. The ENTER NEW PASSWORD box (small) is displayed.</p>  <p>1-3 Use the ▲/▼/◀/▶ buttons to enter the password. Move the cursor to the right side of the ENTER NEW PASSWORD box (small) and press the ► button to display the NEW PASSWORD AGAIN box, enter the same PASSWORD again.</p>  <p>1-4 Move the cursor to the right side of the NEW PASSWORD AGAIN box and press the ► button to display the NOTE NEW PASSWORD box for approximately 30 seconds. Make note of the password during this time.</p>  <p>Pressing the ENTER button on the remote control or ► button on the projector returns to MyScreen PASSWORD on/off menu.</p> <p>When a password is set for MyScreen:</p> <ul style="list-style-type: none"> • The MyScreen registration function (and menu) are unavailable. • The MyScreen Lock menu is unavailable. • The START UP setting is locked on MyScreen (and the menu is unavailable). <p>Turning the MyScreen PASSWORD off allows normal operation of these functions.</p> <ul style="list-style-type: none"> • Do not forget your MyScreen PASSWORD. <p>2 Turning off the MyScreen PASSWORD</p> <p>2-1 Follow the procedure in 1-1 to display the MyScreen PASSWORD on/off menu.</p> <p>2-2 Select OFF to display the ENTER PASSWORD box (large). Enter the registered password and the screen returns to the MyScreen PASSWORD on/off menu.</p>  <p>If an incorrect PASSWORD is entered, the menu closes. If necessary, repeat the process from 2-1.</p> <p>3 If you have forgotten your password</p> <p>3-1 Follow the procedure in 1-1 to display the MyScreen PASSWORD on/off menu.</p> <p>3-2 Select OFF to display the ENTER PASSWORD box (large). The 10 digit Inquiring Code is displayed inside the box.</p> <p>3-3 Contact your dealer with the 10 digit Inquiring Code. Your password is sent after your user registration information is confirmed.</p>

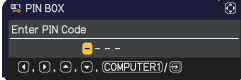
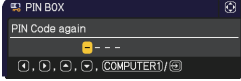
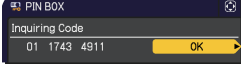

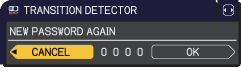
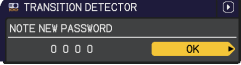
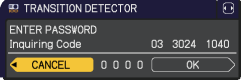

(continued on next page)

Item	Description
<p>PIN LOCK</p>	<p>PIN LOCK is a function which prevents the projector from being used unless a registered Code is input.</p> <p>1 Turning on the PIN LOCK</p> <p>1-1 Use the ▲/▼ buttons on the SECURITY menu to select PIN LOCK and press the ► button or the ENTER button to display the PIN LOCK on/off menu.</p>  <p>1-2 Use the ▲/▼ buttons on the PIN LOCK on/off menu to select ON and the Enter PIN Code box is displayed.</p>  <p>1-3 Input a four part PIN code using the ▲/▼/◀/▶, COMPUTER 1 or INPUT button. The PIN Code again box appears. Reenter the same PIN code. This completes the PIN code registration.</p>  <ul style="list-style-type: none"> • If there is no key input for approximately 55 seconds while the Enter PIN Code box or the PIN Code again box is displayed, the menu closes. If necessary, repeat the process from 1-1. <p>Anytime the projector is restarted after AC power is turned off, the Enter PIN Code box is displayed. Enter the registered PIN code. The projector can be used after entering the registered PIN code. If an incorrect PIN code is input, the Enter PIN code box is displayed again. If an incorrect PIN code is input three times, the projector turns off. Afterwards the projector turns off every time an incorrect PIN code is input. The projector also turns off if there is no key input for approximately five minutes while the Enter PIN code box is displayed. This function activates only when the projector is started after AC power is turned off.</p> <ul style="list-style-type: none"> • Do not forget your PIN code. <p>2 Turning off the PIN LOCK</p> <p>2-1 Follow the procedure in 1-1 to display the PIN LOCK on/off menu.</p> <p>2-2 Use the ▲/▼ buttons to select OFF and the Enter PIN Code box is displayed.</p> <p>Enter the registered PIN code to turn the PIN LOCK function off. If an incorrect PIN code is input three times, the projector turns off.</p> <p>3 If you have forgotten your PIN code</p> <p>3-1 While the Enter PIN code box is displayed, press and hold the RESET button for three seconds or press and hold the INPUT button for three seconds while pressing the ► button on the projector. The 10 digit Inquiring Code is displayed.</p> <ul style="list-style-type: none"> • If there is no key input for approximately five minutes while the Inquiring Code is displayed, the projector turns off.  <p>3-2 Contact your dealer with the 10 digit Inquiring Code. Your PIN code is sent after your user registration information is confirmed.</p>

(continued on next page)

Item	Description
<p>TRANSITION DETECTOR</p>	<p>If this function is set to ON and the vertical angle of the projector or the INSTALLATION setting is different from the previous recorded setting, the TRANSITION DETECTOR ON alarm is displayed and the input signal is not displayed.</p> <ul style="list-style-type: none"> To display the signal again, set this function OFF. After approximately five minutes of displaying the TRANSITION DETECTOR ON alarm, the light source turns off. <p>1 Turning on the TRANSITION DETECTOR</p> <p>1-1 Use the ▲/▼ buttons on the SECURITY menu to select TRANSITION DETECTOR and press the ► or the ENTER button to display the TRANSITION DETECTOR on/off menu.</p>  <p>1-2 Use the ▲/▼ buttons on the TRANSITION DETECTOR on/off menu to select ON. Selecting ON saves the setting of the current angle and the INSTALLATION setting. The ENTER NEW PASSWORD box (small) is displayed.</p> <p>1-3 Use the ▲/▼/◀/▶ buttons to enter a password. Move the cursor to the right side of the ENTER NEW PASSWORD box (small) and press the ► button to display the NEW PASSWORD AGAIN box, enter the same password again.</p> <p>1-4 Move the cursor to the right side of the NEW PASSWORD AGAIN box and press the ► button to display the NOTE NEW PASSWORD box for about 30 second. Make note of the password. Pressing the ENTER button on the remote control or the ► button on the projector returns to the TRANSITION DETECTOR on/off menu.</p> <ul style="list-style-type: none"> Do not forget your TRANSITION DETECTOR password. This function activates only when the projector is started after turning off the AC power. This feature may not function properly if the projector is not in a stable position when ON is selected. <p>2 Turning off the TRANSITION DETECTOR</p> <p>2-1 Follow the procedure in 1-1 to display the TRANSITION DETECTOR on/off menu.</p> <p>2-2 Select OFF to display the ENTER PASSWORD box (large). Enter the registered password and the screen returns to the TRANSITION DETECTOR on/off menu.</p>   <p>ENTER NEW PASSWORD box (small)</p>   <p>If an incorrect password is entered, the menu closes. If necessary, repeat the process from 2-1.</p> <p>3 If you have forgotten your password</p> <p>3-1 Follow the procedure in 1-1 to display the TRANSITION DETECTOR on/off menu.</p> <p>3-2 Select OFF to display the ENTER PASSWORD box (large). The 10 digit Inquiring Code is displayed inside the box.</p>  <p>ENTER PASSWORD box (large)</p> <p>3-3 Contact your dealer with the 10 digit Inquiring Code. Your password is sent after your user registration information is confirmed.</p>

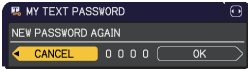
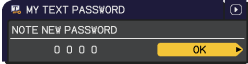
(continued on next page)

Item	Description
<p>MY TEXT PASSWORD</p>	<p>The MY TEXT PASSWORD function can prevent the MY TEXT from being overwritten. When the password is set for the MY TEXT;</p> <ul style="list-style-type: none"> • The MY TEXT DISPLAY menu is unavailable, which can prohibit changing the DISPLAY setting. • The MY TEXT WRITING menu is unavailable, which can prevent the MY TEXT from being overwritten. <p>1 Turning on the MY TEXT PASSWORD</p> <p>1-1 Use the ▲/▼ buttons on the SECURITY menu to select the MY TEXT PASSWORD and press the ► button to display the MY TEXT PASSWORD on/off menu.</p>  <p>1-2 Use the ▲/▼ buttons on the MY TEXT PASSWORD on/off menu to select ON. The ENTER NEW PASSWORD box (small) is displayed.</p>  <p>1-3 Use the ▲/▼/◀/▶ buttons to enter the password. Move the cursor to the right side of the ENTER NEW PASSWORD box (small) and press the ► button to display the NEW PASSWORD AGAIN box, and then enter the same password again.</p>  <p>1-4 Move the cursor to the right side of the NEW PASSWORD AGAIN box and press ► button to display the NOTE NEW PASSWORD box for about 30 seconds. Make note of the password.</p>  <p>Pressing the ENTER button on the remote control or ► button on the projector returns to the MY TEXT PASSWORD on/off menu.</p> <p>2 Turning off the MY TEXT PASSWORD</p> <p>2-1 Follow the procedure in 1-1 to display the MY TEXT PASSWORD on/off menu.</p> <p>2-2 Select OFF to display the ENTER PASSWORD box (large). Enter the registered password and the screen returns to the MY TEXT PASSWORD on/off menu.</p>  <p>If an incorrect password is input, the menu closes. If necessary, repeat the process from 2-1</p> <p>3 If you have forgotten your password</p> <p>3-1 Follow the procedure in 1-1 to display the MY TEXT PASSWORD on/off menu.</p> <p>3-2 Select OFF to display the ENTER PASSWORD box (large). The 10 digit inquiring code is displayed inside the box.</p> <p>3-3 Contact your dealer with the 10 digit inquiring code. Your password is sent after your user registration information is confirmed.</p>

(continued on next page)

Item	Description
<p>MY TEXT DISPLAY</p>	<p>(1) Use the ▲/▼ buttons on the SECURITY menu to select the MY TEXT DISPLAY and press the ► or ENTER button to display the MY TEXT DISPLAY on/off menu.</p> <p>(2) Use the ▲/▼ buttons on the MY TEXT DISPLAY on/off menu to select on or off.</p> <p>ON ⇔ OFF</p> <p>When it is set ON, the MY TEXT is displayed on the START UP screen and the INPUT_INFORMATION when the INFORMATION on the SERVICE menu is chosen.</p> <ul style="list-style-type: none"> • This function is available only when the MY TEXT PASSWORD function is set to the OFF.
<p>MY TEXT WRITING</p>	<p>(1) Use the ▲/▼ buttons on the SECURITY menu to select the MY TEXT WRITING and press the ► button. The MY TEXT WRITING dialog is displayed.</p> <p>(2) The current MY TEXT is displayed on the first three lines. If not yet written, the lines is blank.</p> <p>Use the ▲/▼/◀/▶ buttons and the ENTER or INPUT button to select and enter characters. To erase 1 character at one time, press the RESET button or press the ◀ and INPUT button at the same time. If you move the cursor to DELETE or CLEAR ALL on screen and press the ENTER or INPUT button, one or all characters are erased. The MY TEXT can be input up to 24 characters on each line.</p> <p>(3) To change an already inserted character, press the ▲/▼ button to move the cursor to one of the first three lines, and use the ◀/▶ buttons to move the cursor on the character to be changed.</p> <p>After pressing the ENTER or INPUT button, the character is selected. Then, follow the same procedure as described at the item (2) above.</p> <p>(4) To finish entering text, move the cursor to the OK on screen and press the ►, ENTER or INPUT button. To revert to the previous MY TEXT without saving changes, move the cursor to the CANCEL on screen and press the ◀, ENTER or INPUT button.</p> <ul style="list-style-type: none"> • The MY TEXT WRITING function is available only when the MY TEXT PASSWORD function is set to OFF.

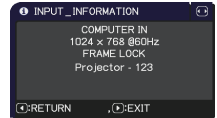
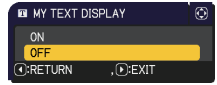

(continued on next page)

Item	Description
SECURITY INDICATOR	Selecting this item displays the SECURITY INDICATOR dialog. Use the ▲/▼ buttons to select ON or OFF. ON ⇄ OFF When ON is selected while PIN LOCK or TRANSITION DETECTOR is ON, it is notified by lighting/blinking of indicator in the standby mode. (📖108, 109). Refer to "Regarding the indicator lamps" (📖123) about the indicator.
STACK LOCK	Selecting this item displays the STACK LOCK dialog. For more information, see the Instant Stack Guide .

Maintenance

Cleaning and replacing the air filter

Check and clean the air filter periodically. When the indicators or a message prompts you to clean the air filter, comply with it as soon as possible.

1. Turn the projector off, and unplug the power cord. Allow the projector to sufficiently cool down.
2. Use a vacuum cleaner on and around the filter cover.
3. Pick and pull up the filter cover knobs to take it off.
4. Press up slightly the bottom side knobs to unlock the bottom side of the air filter, and take it off.

The air filter consists of two parts.

5. Press down around the interlocking parts to unlock, then separate the two parts. Use a vacuum cleaner for both sides of the air filter. If the air filter is damaged or heavily soiled, replace it with the new one. Request for an air filter with the following type number from your dealer when purchasing a new one.

Type number: **UX43481**
6. Use a vacuum cleaner for the filter vent of the projector.
7. Put back the air filter and filter cover into their place.
8. Turn the projector on and reset the filter time using the **FILTER TIME** item in the **EASY MENU**.
 - (1) Press the **MENU** button to display a menu.
 - (2) Point at the **FILTER TIME** using the **▲/▼** buttons, then press the **▶** button. A dialog will appear.
 - (3) Press the **▶** button to select "OK" on the dialog. It performs resetting the filter time.

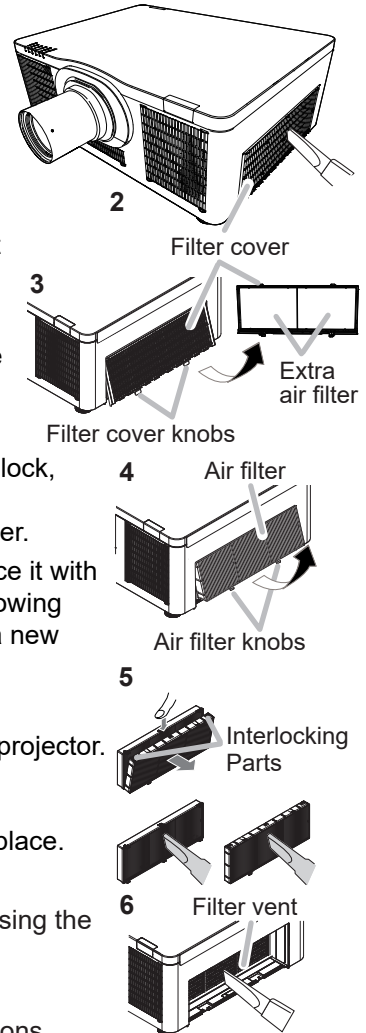

(continued on next page)

Cleaning and replacing the air filter (continued)

- ⚠ WARNING** ▶ Before taking care of the air filter, make sure the power cord is not plugged in, then allow the projector to cool sufficiently.
- ▶ Use only the air filter of the specified type. Do not use the projector without the air filter or the filter cover. It could result in a fire or malfunction to the projector.
 - ▶ Clean the air filter periodically. If the air filter becomes clogged by dust or the like, internal temperatures rise and could cause a fire, a burn or malfunction to the projector.

- NOTE**
- Replace the air filter when it is damaged or heavily soiled.
 - Reset the filter time only when you have cleaned or replaced the air filter, for a suitable indication about the air filter.
 - The projector may display the message such as the “CHECK THE AIR FLOW” or turn off the projector, to prevent the internal heat level rising.

Inserting or replacing the internal clock battery

This product has an internal clock. The battery for the internal clock is not contained at the time of factory shipment. When you use the function that requires the internal clock (📅"Event Scheduling" in the **Network Guide**), install a new battery according to the following procedure.

Use the following type of battery.

MAXELL, Part No. CR2032 or CR2032H

1. Turn the projector off, and unplug the power cord.
 1. Allow the projector to cool sufficiently.
2. Turn the battery cover fully counterclockwise using a coin or the like, and pick the cover up to remove it.
3. Pry up the old battery using a flathead screwdriver or the like to take it out. Do not use any metal tools. While prying it up, put a finger lightly on the battery since it may pop out of the holder.
4. Insert the new battery or replace the battery with a new one.
 1. Slide the battery in under the plastic claw, and push it into the holder until it clicks.
5. Place the battery cover in place, then turn it clockwise using such as coins to fix.

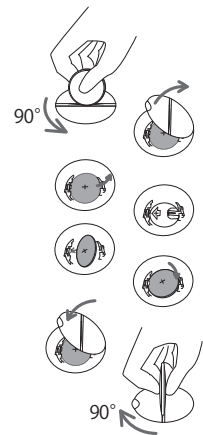
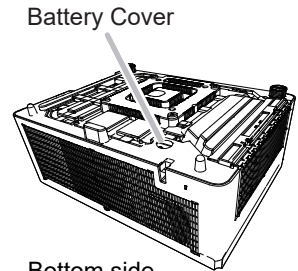

⚠WARNING ► Always handle the batteries with care and use them only as directed. Battery may explode if mistreated. Do not recharge, disassemble or dispose of in fire.

Improper use may result in cracking or leakage, which could result in fire, injury and/or pollution of the surrounding environment.

- Be sure to use only the batteries specified.
- Make sure the plus and minus terminals are correctly aligned when loading a battery.
- Keep a battery away from children and pets. If swallowed consult a physician immediately for emergency treatment.
- Do not short circuit or solder a battery.
- Do not allow a battery in a fire or water. Keep batteries in a dark, cool and dry place.
- If you observe battery leakage, wipe out the leakage and then replace a battery. If the leakage adheres to your body or clothes, rinse well with water immediately.
- Obey the local laws on disposing a battery.

NOTE • The internal battery is required to be replaced when the time is off soon after setting date and time.

Other care

Inside of the projector

To ensure the safe use of your projector, have it cleaned and inspected by your dealer every year.

Caring for the lens

If the lens is flawed, soiled or fogged, it could cause deterioration of display quality. Take care of the lens, being cautious of handling.

1. Turn the projector off, and unplug the power cord. Allow the projector to cool sufficiently.
2. After making sure that the projector is cool adequately, lightly wipe the lens with a commercially available lens-cleaning wipe. Do not touch the lens directly with your hand.
 - Use commercially available lens tissue to clean the lens (used to clean cameras, eyeglasses, etc.).
 - If the lens is heavily soiled, wipe it with a cloth moistened with little water.
 - Never use polishing agents, detergents, chemicals, or solvents such as benzine or thinner.
 - Excepting for lens, use a soft cloth to clean. When excessively soiled, dilute a neutral detergent in water, wet and wring out the soft cloth.

Caring for the cabinet and remote control

Incorrect care could have adverse influence such as discoloration, peeling paint, etc.

1. Turn the projector off, and unplug the power cord. Allow the projector to cool sufficiently.
2. After making sure that the projector is cool adequately, lightly wipe with gauze or a soft cloth.
If the projector is extremely dirty, dip a soft cloth in water or a neutral cleaner diluted in water, and wipe lightly after wringing well. Then, wipe lightly with a soft, dry cloth.

⚠ WARNING ▶ Make sure the power cord is not plugged in, and allow the projector to cool sufficiently. The high temperature state of the projector could cause a burn and/or malfunction to the projector.

▶ Do not clean or service the inside of the projector. Doing is so dangerous.

▶ Avoid wetting the projector or inserting liquids in the projector. It could result in a fire, an electric shock, and/or malfunction to the projector.

- Do not put anything containing water, cleaners or chemicals near the projector.
- Do not use aerosols or sprays.

⚠ CAUTION ▶ Incorrect care of the projector could cause not only an injury but adverse influence such as discoloration, peeling paint, etc.

▶ Do not use cleaners or chemicals other than those specified in this manual.

▶ Do not polish or wipe with hard objects.

NOTICE ▶ Do not directly touch the lens surface with hands.

Troubleshooting



If an abnormal operation should occur, stop using the projector immediately.

⚠ WARNING ▶ Never use the projector if abnormal operations such as smoke, strange odor, excessive sound, damaged casing or elements or cables, penetration of liquids or foreign matter, and so on should occur. In such cases, immediately disconnect the power plug from the power outlet. After making sure that the smoke or odor has stopped, contact to your dealer or service company.

If a problem occurs with the projector, the following checks and measures are recommended before requesting repair.
If this does not resolve the problem, contact your dealer or service company. They tell you what warranty condition is applied.



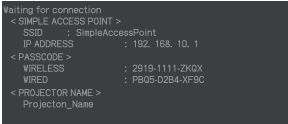

Related messages

When some messages appear, check and deal with it according to the following table. Although these messages automatically disappear after several minutes, they reappear when the power is turned on.

Message	Description
	<p>There is no input signal. Confirm the signal input connection, and the status of the signal source.</p>
	<p>Projector is waiting for an image file. Check the hardware connection, settings on the projector and network-related settings. The computer-Projector network connection might be disconnected. Re-connect them.</p>
	



(continued on next page)

Related messages (continued)

Message	Description
 <p>COMPUTER IN SYNC IS OUT OF RANGE 48kHz 60Hz</p>	<p>The horizontal or vertical frequency of the input signal is not within the specified range. Confirm the specs for your projector or the signal source specs.</p>
 <p>COMPUTER IN INVALID SCAN FREQ.</p>	<p>An improper signal is input. Confirm the specs for your projector or the signal source specs.</p>
 <p>CHECK THE AIR FLOW</p>	<p>The internal temperature is rising. Turn the power off, and allow the projector to cool down at least 20 minutes. After having confirmed the following items, turn the power ON again.</p> <ul style="list-style-type: none"> • Is there blockage of the air passage aperture? • Is the air filter dirty? • Use the unit within the usage temperature parameters (0°C to 40°C or 45°C ( User's Manual (concise))). • Is the exhaust air (hot/cold) from peripheral equipments blowing against the ventilation opening of projector?

(continued on next page)



Related messages (continued)

Message	Description
	<p>A note of precaution when cleaning the air filter. Immediately turn the power off, and clean or change the air filter referring to the Cleaning and replacing the air filter section of this manual. After you have cleaned or changed the air filter, reset the filter time (📖74, 113).</p>
	<p>The button operation is not available. Check the button you want to use (📖7).</p>

Regarding the indicator lamps

The indicators may differ from this manual, check and deal with it according to the following table.

The indicators are described as below.

		
Lit Steady light	Blinking	Off

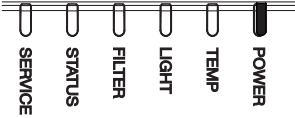
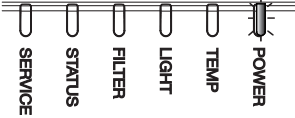
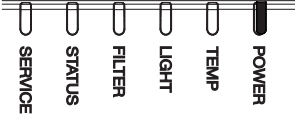
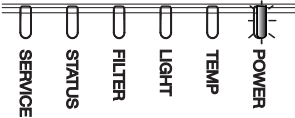
Indicator Status	Description
<p style="text-align: center;">Orange</p> 	<p>The projector is in a standby state. Refer to the section "Power on/off".</p>
<p style="text-align: center;">Green</p> 	<p>The projector is warming up. Wait for the projector to warm up.</p>
<p style="text-align: center;">Green</p> 	<p>The projector is in an on state. Ordinary operations may be performed.</p>
<p style="text-align: center;">Orange</p> 	<p>The projector is cooling down. Wait for the projector to cool down.</p>

(continued on next page)

Regarding the indicator lamps (continued)

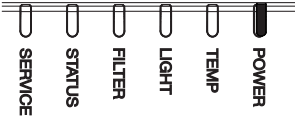
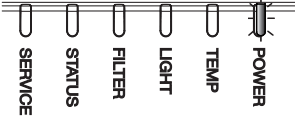
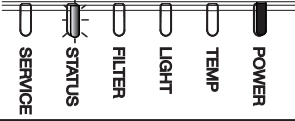
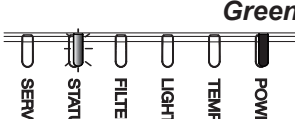
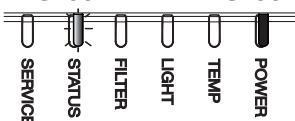
Indicator Status	Description
<p>Blinking In Green 1 time</p> 	<p>At least 1 "Power ON" schedule is saved to the projector. Refer to Schedule Settings section of User's Manual - Network Guide.</p>
<p>Normally lighting in Orange. Blinking In Green 2 times for approx. 3 seconds.</p> 	<p>STANDBY MODE is set to QUICK START. Refer to STANDBY MODE. (76)</p>
<p>Blinking In Green 2 times Green</p> 	<p>Blank(black) or AV Mute(black) is on. Press any button on the remote control or on the control panel to disable Blank or AV Mute.</p>
<p>Blinking In Green 3 times Green</p> 	<p>The shutter is closed. Press the SHUTTER button on the remote control or on the control panel to open the shutter.</p>
<p>Green Green</p> 	<p>The projector received the remote control signal when ALL is selected for REMOTE CONTROL in KEY LOCK. CONTROL PANEL was operated when ALL is selected for CONTROL PANEL in KEY LOCK.</p>

(continued on next page)

Regarding the indicator lamps (continued)

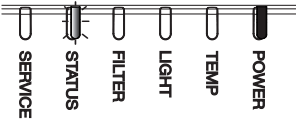
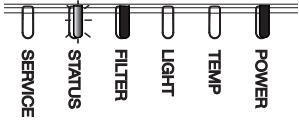
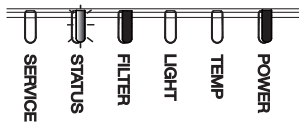
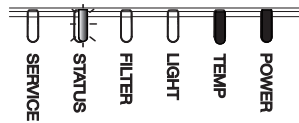
Indicator Status	Description
<p>Blinking In Green 1 time</p> <p style="text-align: right;">Orange</p> 	<p>PIN LOCK or TRANSITION DETECTOR function is active.</p> <p>See SECURITY menu > PIN LOCK or TANSITION DETECTOR(108, 109, 112).</p> <p>If the same indication is displayed after the remedy, contact your dealer or service company.</p>
<p>Blinking In Red 1 time</p> <p style="text-align: center;">Red Green</p> 	<p>It is time to clean the air filter.</p> <p>Turn the power off immediately, and clean or change the air filter referring to the section Cleaning and replacing the air filter. After cleaning or changing the air filter, reset the filter time.</p> <p>After the remedy, restart the projector.</p>
<p>Blinking In Red 2 ~ 3 times</p> <p style="text-align: center;">Red Green</p> 	<p>The air filter is clogged or dirty. (113)</p> <p>Check and clean the air filter.</p> <p>Make sure the power cord is not plugged in, then allow the projector to cool sufficiently.</p> <p>See the section "The interior portion has become heated" (124).</p> <div style="border: 1px solid black; padding: 5px; margin-top: 10px;"> <p>NOTE • The FILTER indicator might light up in red when something blocks the intake vents even though the air filter is clean.</p> <ul style="list-style-type: none"> • The FILTER indicator might light up differently from other indicators or display messages related to cleaning the air filter. <p>Follow the prompt that is displayed earlier.</p> </div>
<p>Blinking In Red 1 time</p> <p style="text-align: center;">Red Green</p> 	<p>The internal temperature is rising.</p> <p>Turn the power off, and allow the projector to cool down at least 20 minutes. After having confirmed the following items, turn the power on again.</p> <ul style="list-style-type: none"> • Is there blockage of the air passage aperture? • Is the air filter dirty? • Does the peripheral temperature exceed 45°C?

(continued on next page)

Regarding the indicator lamps (continued)

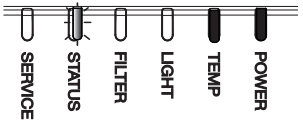
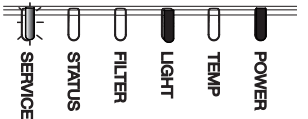
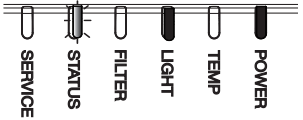
Indicator Status	Description
<p>Blinking In Red 2 ~ 6 times</p> <p style="text-align: center;">Red Red</p> 	<p>The interior portion has become heated. Turn the power off, and allow the projector to cool down at least 20 minutes. After the projector has sufficiently cooled down, confirm the following items, and then turn the power on again.</p> <ul style="list-style-type: none"> • Is there blockage of the air passage aperture? • Is the air filter dirty? • Does the peripheral temperature exceed 45°C? • Is the setting for ALTITUDE appropriate? • Is the exhaust air (hot/cold) from peripheral equipments blowing against the ventilation opening of projector? <p>For details on ALTITUDE, refer to ALTITUDE of SERVICE in the OPTION menu. If the projector is used with a wrong setting, it may cause damage to the projector itself or the parts inside.</p>
<p>Blinking In Red 1 ~ 5 times</p> <p style="text-align: center;">Red or Green</p> 	<p>The light source does not light or the illuminance system is operating in degraded mode, and there is a possibility that interior portion has become heated. Turn the power off, and allow the projector to cool down at least 20 minutes. After the projector has sufficiently cooled down, confirm the following items, and then turn the power on again.</p> <ul style="list-style-type: none"> • Is there blockage of the air passage aperture? • Is the air filter dirty? • Does the peripheral temperature exceed 45°C?
<p>Blinking In Red 1 time</p> <p style="text-align: center;">Red Red</p> 	<p>Lens unit is not installed. Make sure that the lens unit is installed correctly, and turn on the projector again.</p>

(continued on next page)

Regarding the indicator lamps (continued)

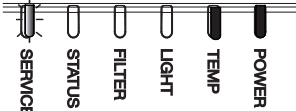
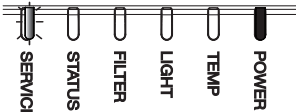
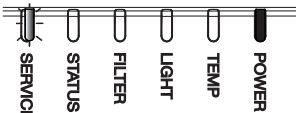
Indicator Status	Description
<p>Blinking In Red 1 ~ 11 times Red or Red Green</p>  <p>The diagram shows six indicator lamps labeled SERVICE, STATUS, FILTER, LIGHT, TEMP, and POWER. The SERVICE lamp is shown with a vertical line through it, indicating it is blinking. The other lamps are shown as solid vertical bars.</p>	<p>The cooling fan is not operating. Turn the power off, and allow the projector to cool down at least 20 minutes. After the projector has sufficiently cooled down, confirm that no foreign matter has become caught in the fan, and so on and then turn the power on again. If the same indication is displayed after the remedy, contact your dealer or service company.</p>
<p>Blinking In Orange 1 time Orange or Green</p>  <p>The diagram shows six indicator lamps labeled SERVICE, STATUS, FILTER, LIGHT, TEMP, and POWER. The SERVICE lamp is shown with a vertical line through it, indicating it is blinking. The other lamps are shown as solid vertical bars.</p>	<p>Lens shift does not work correctly. Turn off the projector and install the lens unit correctly. Remove obstacles if they are around the lens. If the same indication is displayed after the remedy, contact your dealer or service company.</p>
<p>Blinking In Orange 2 ~ 6 times Green</p>  <p>The diagram shows six indicator lamps labeled SERVICE, STATUS, FILTER, LIGHT, TEMP, and POWER. The SERVICE lamp is shown with a vertical line through it, indicating it is blinking. The other lamps are shown as solid vertical bars.</p>	<p>There is a possibility that the interior portion has become overcooled.</p> <ul style="list-style-type: none"> Use the unit within the temperature range. WHISPER: 0 to 45°C Other than WHISPER: 0 to 40°C
<p>Other than those above</p>	<p>Other error has occurred.</p> <ul style="list-style-type: none"> Use the unit within the temperature range. WHISPER: 0 to 45°C Other than WHISPER: 0 to 40°C <p>If the same indication is displayed after the remedy, contact your dealer or service company.</p>

Regarding the indicator lamps (continued)

NOTE • When the interior portion has become overheated, for safety purposes, the projector is automatically shut down, and the indicator lamps may also be turned off. In such a case, disconnect the power cord, and wait at least 20 minutes. After the projector has sufficiently cooled down, turn the power on again.

Resetting all settings

When it is difficult to correct wrong settings, the FACTORY RESET function of SERVICE item in OPTION menu (📖104) can reset all settings (except settings such as LANGUAGE, AUTO BLANK, LIGHT SOURCE TIME, FILTER TIME, FILTER MESSAGE, STANDBY MODE, COMMUNICATION, SCHEDULE, CONTROL TERMINAL, REMOTE CONTROL OUT, SECURITY and NETWORK) to the factory default.

Issues that may be easy to be mistaken for machine defects

An issue may be confused with a machine defect, check and deal with it according to the following table.

Issue	Cases not involving a machine defect	Reference page
Power does not come on.	<p>The electrical power cord is not plugged in. Correctly connect the power cord.</p>	27
	<p>The main power source has been interrupted during operation such as by a power outage (blackout), etc. Disconnect the power plug from the power outlet, and allow the projector to cool down at least 20 minutes, then turn the power on again.</p>	27
Operations other than power on/off are not available.	<p>OSD MESSAGE is set to INHIBIT. Press the OSD MSG button on the remote control for more than 3 seconds to display the OSD MESSAGE dialog, then change the setting.</p>	36
Neither sounds nor pictures are output.	<p>The signal cables are not correctly connected. Correctly connect the connection cables.</p>	13 ~ 23
	<p>Signal source does not correctly work. Correctly set up the signal source device by referring to the manual of the source device.</p>	-
	<p>The input changeover settings are mismatched. Select the input signal, and correct the settings.</p>	34
	<p>AV MUTE function is working. Press AV MUTE button on the remote control.</p>	33
	<p>The shutter is closed. Check if the shutter is closed by checking the indicator. Press the SHUTTER button on the control panel if the shutter is closed. Refer to "Regarding the indicator lamps" about the indicator.</p>	49, 122

(continued on next page)

Issues that may be easy to be mistaken for machine defects (continued)

Issue	Cases not involving a machine defect	Reference page
Sound does not come out.	<p>The signal cables are not correctly connected. Correctly connect the audio cables.</p>	13 ~ 23
	<p>The volume is adjusted to an extremely low level. Adjust the volume to a higher level using the menu function or the remote control.</p>	33, 80
	<p>The AUDIO SOURCE setting is not correct. Correctly set the AUDIO SOURCE in AUDIO menu.</p>	80
	<p>The Sound checkbox in LiveViewer is disabled. If you have selected LAN, check the Sound checkbox in the Option menu of LiveViewer.</p>	-
No pictures are displayed.	<p>The signal cables are not correctly connected. Correctly connect the connection cables.</p>	13 ~ 23
	<p>The brightness is adjusted to an extremely low level. Adjust BRIGHTNESS to a higher level using the menu function.</p>	59
	<p>The computer cannot detect the projector as a plug and play monitor. Make sure that the computer can detect a plug and play monitor using another plug and play monitor.</p>	13

(continued on next page)

Issues that may be easy to be mistaken for machine defects (continued)

Issue	Cases not involving a machine defect	Reference page
The remote control does not work.	<p>The batteries in the remote control are near the end. Replace the batteries.</p>	28
	<p>The ID numbers set in the projector and the remote control are different. Press the ID button with the same ID number as the projector, then perform the desired operation. The ID number set in the projector can be displayed by pressing any of the ID buttons on the remote control for three seconds while the light source is on.</p>	29
Video screen display freezes.	<p>The FREEZE function is working. Press FREEZE button to restore the screen to normal.</p>	49
Colors have a faded-out appearance, or color tone is poor.	<p>Color settings are not correctly adjusted. Perform picture adjustments by changing the COLOR TEMP, COLOR and/or TINT settings, using the menu functions.</p>	59, 61
	<p>COLOR SPACE setting is not suitable. Change the COLOR SPACE setting.</p>	66
Pictures appear dark.	<p>The brightness and/or contrast are adjusted to an extremely low level. Adjust BRIGHTNESS and/or CONTRAST settings to a higher level using the menu function.</p>	59
	<p>The projector is operating in LONG LIFE 1, LONG LIFE 2 or WHISPER. Set LIGHT OUTPUT in the LIGHT & FILTER menu to NORMAL(100).</p>	73
	<p>The light source is approaching the end of its product lifetime. Contact your local dealer.</p>	–
	<p>When the internal temperature is high (even if the ambient temperature is lower than 35°C), the brightness of light source might be reduced automatically. Clean or replace the air filter.</p>	113
	<p>Fan or light source may be in failure. Contact your local dealer.</p>	123, 124

(continued on next page)

Issues that may be easy to be mistaken for machine defects (continued)

Issue	Cases not involving a machine defect	Reference page
Pictures appear blurry.	<p>The lens cover is attached. Remove the lens cover.</p>	-
	<p>Either the focus and/or horizontal phase settings are not properly adjusted. Adjust the focus using the FOCUS + / - buttons on the remote control or FOCUS button and ◀/▶ cursor buttons on the projector, and/or H PHASE using the menu function.</p>	38, 65
	<p>The lens is dirty or misty. Clean the lens referring to the section Caring for the lens.</p>	116
Some kind of image degradation such as flickering or stripes appear on screen.	<p>When the projector is operating in LONG LIFE 1, LONG LIFE 2 or WHISPER, flickering may appear on screen. Set LIGHT OUTPUT in the LIGHT & FILTER menu to NORMAL(100).</p>	73
	<p>The OVER SCAN ratio is too big. Adjust OVER SCAN in the IMAGE menu smaller.</p>	64
	<p>Excessive VIDEO NR. Change the setting of VIDEO NR in the INPUT menu.</p>	66
	<p>The FRAME LOCK function cannot work on the current input signal. Set FRAME LOCK in the INPUT menu to OFF.</p>	69
RS-232C does not work.	<p>The SAVING/NETWORK(WOL) function is working. Select NORMAL or QUICK START for STANDBY MODE item in the SETUP menu.</p>	76
	<p>The COMMUNICATION TYPE for the CONTROL port is set to NETWORK BRIDGE. Select OFF for COMMUNICATION TYPE item in the OPTION - SERVICE - COMMUNICATION menu.</p>	100

(continued on next page)

Issues that may be easy to be mistaken for machine defects (continued)

Issue	Cases not involving a machine defect	Reference page
Network does not work.	<p>The SAVING/NETWORK(WOL) function is working. Select NORMAL or QUICK START for STANDBY MODE item in the SETUP menu.</p>	76
	<p>The same network address is set for both wireless and wired LAN. Change the network address setting for wireless or wired LAN.</p>	-
Displayed image is partially dark.	<p>Blending Region is set. Set all Blending Region to OFF or set Blending – Mode to OFF.</p>	44
The IR and RS-232C does not work on HDBaseT connection.	<p>The SAVING/NETWORK(WOL) function is working. Select NORMAL or QUICK START for STANDBY MODE item in the SETUP menu.</p>	76
HDBaseT connection does not work.	<p>The SAVING/NETWORK(WOL) function is working. Select NORMAL or QUICK START for STANDBY MODE item in the SETUP menu.</p>	76
	<p>The connected equipment may not be supported by HDBaseT. Refer to User's manual (detailed) for connection.</p>	14
IR and LAN does not work via HDBaseT.	<p>Check if the IR setting is OFF under HDBaseT. EASY MENU > ADVANCED MENU > OPTION > SERVICE > REMOTE RECEIV.</p>	99
	<p>Check if the LAN setting is HDBaseT. EASY MENU > ADVANCED MENU > OPTION>SERVICE>CONTROL TERMINAL > WIRED NETWORK</p>	-

(continued on next page)

Issues that may be easy to be mistaken for machine defects (continued)

Issue	Cases not involving a machine defect	Reference page
LAN does not work, if LAN is connected to the projector while having an input signal from HDBaseT.	<p>Check if the LAN setting is HDBaseT. EASY MENU > ADVANCED MENU > OPTION>SERVICE>CONTROL TERMINAL > WIRED NETWORK</p>	-
	<p>This projector is compatible with 100BASE-T only. Check the specification of the connected equipments.</p>	-
	<p>If the LAN cable is connected with the hub, try to change the connected port at the hub</p>	-
	<p>If the LAN cable is connected directly to the computer, try to connect to other computer</p>	-
No image is displayed via HDBaseT.	<p>Check the LAN cable if it is CAT5e certified or higher.</p>	-
	<p>Try to change the LAN cable.</p>	-
	<p>If the LAN cable is connected with more than three extension connector, the transmission of 100 meters may fail.</p>	-
	<p>Check if the extension connector is compatible with CAT5e. All LAN cable and extension connector connected with HDBaseT port must be CAT5e certified.</p>	-
No image is displayed via 3G-SDI. (MP-WU8801W/MP-WU8801B only).	<p>Check if it is connected with a cable of 5CFB or greater, or Belden 1694A or greater.</p>	-
	<p>Check if a cable with a length of 100m or less is used.</p>	-
	<p>Try to change the cable.</p>	-
	<p>Check if a supported signal format is input.</p>	-

(continued on next page)

Issues that may be easy to be mistaken for machine defects (continued)

Issue	Cases not involving a machine defect	Reference page
No image is displayed via DisplayPort.	Check if DisplayPort cables conforming to the DisplayPort standard is used for connection.	–
	When the projector is connected to the computer with an early type of chipset or graphics card that supports the DisplayPort, the projector and/or computer may not operate normally.	–
	The problem may be solved by upgrading the driver of graphic accelerator of the computer to the latest version.	–
	Turn off the projector and the external device, and turn on again.	–
	Check if the supported signal format is input.	–
NETWORK BRIDGE function does not work.	<p>The NETWORK BRIDGE function is turned off. Select NETWORK BRIDGE for COMMUNICATION TYPE item in the OPTION - SERVICE - COMMUNICATION menu.</p>	100

(continued on next page)

Issues that may be easy to be mistaken for machine defects (continued)

Issue	Cases not involving a machine defect	Reference page
Schedule function does not work.	<p>The SAVING/NETWORK(WOL) function is working. Select NORMAL or QUICK START for STANDBY MODE item in the SETUP menu.</p>	76
	<p>The internal clock has been reset. Once you turn off the projector in the SAVING/NETWORK(WOL) mode or the AC power, the current date and time setting is reset. Check the DATE AND TIME setting in OPTION-SCHEDULE.</p>	-
STANDBY OUTPUT (AUDIO OUT, HDMI OUT, MONITOR OUT) does not work with standby mode.	<p>Check if SAVING/NETWORK(WOL) is set in SETUP - STANDBY MODE. Set NORMAL or QUICK START in the menu above. If the signal is not output yet, check if a desirable item is set in SETUP - STANDBY OUTPUT.</p>	76, 79
The signal from HDMI OUT is not output in the external device.	<p>Check if PROJECTOR is set in OPTION - SERVICE - HDMI OUT RESOLUTION. Set EXTERNAL DEVICE in the menu above. If the signal is not output yet, check the supported resolution of the external device.</p>	103
The signal from HDMI OUT is not output in other connected projectors.	<p>Check if EXTERNAL DEVICE is set in OPTION - SERVICE - HDMI OUT RESOLUTION. Set PROJECTOR in the menu above.</p>	103

(continued on next page)

Issues that may be easy to be mistaken for machine defects (continued)

Issue	Cases not involving a machine defect	Reference page
<p>When the projector is connected to the network, it powers off and on as described below.</p> <p>Powers off ←</p> <p>↓</p> <p>POWER</p> <p>indicator blinks in orange a few times</p> <p>↓</p> <p>Goes into standby mode</p>	<p>Disconnect the LAN cable and check that the projector is working properly.</p> <p>If this issue occurs after connecting to the network, there may be a loop between two Ethernet switching hubs within the network.</p> <ul style="list-style-type: none"> - Two or more Ethernet switching hubs are in a network. - Two of the hubs are doubly connected by LAN cables. - This double connection forms a loop between the two hubs. <p>Such a loop may have an adverse effect on the projector as well as the other network devices.</p> <p>Check the network connection and remove the loop by disconnecting the LAN cables such that there is only one connecting cable between two hubs.</p>	<p>—</p>

NOTE • Although bright spots or dark spots may appear on the screen, this is a unique characteristic of liquid crystal displays, and it does not constitute or imply a machine defect.

Specifications

See the **Specifications** in the **User's Manual (concise)** which is a book.

End User License Agreement for the Product Software

- Software in the projector consists of the plural number of independent software modules and there exist our copyright and/or third party copyrights for each of such software modules.
- Read “End User License Agreement for the Product Software” which is separated document.