

Projector

PX1005QL-W/PX1005QL-B

User's Manual

Please visit our web site for User's Manual in the latest version.
https://www.nec-display.com/dl/en/pj_manual/lineup.html

Model No.
NP-PX1005QL-W/NP-PX1005QL-B

- Apple, Mac, and MacBook are trademarks of Apple Inc. registered in the U.S. and other countries.
- Microsoft, Windows, Windows Vista, Internet Explorer, .NET Framework and PowerPoint are either a registered trademark or trademark of Microsoft Corporation in the United States and/or other countries.
- Cinema Quality Picture logo, AccuBlend, NaViSet, and Virtual Remote are trademarks or registered trademarks of NEC Display Solutions, Ltd. in Japan, in the United State and other countries.
- The terms HDMI and HDMI High-Definition Multimedia Interface, and the HDMI Logo are trademarks or registered trademarks of HDMI Licensing Administrator, Inc. in the United States and other countries.



- DisplayPort and DisplayPort Compliance Logo are trademarks owned by the Video Electronics Standards Association in the United States and other countries.



- HDBaseT™ and the HDBaseT Alliance logo are trademarks of the HDBaseT Alliance.



- DLP®, DLP logo and BrilliantColor are trademarks or registered trademarks of Texas Instruments in the United States and other countries.
- PJLink trademark and logo are trademarks applied for registration or are already registered in Japan, the United States of America and other countries and areas.
- Blu-ray is a trademark of Blu-ray Disc Association
- CRESTRON and CRESTRON ROOMVIEW are trademarks or registered trademarks of Crestron Electronics, Inc. in the United States and other countries.
- Ethernet is either a registered trademark or trademark of Fuji Xerox Co., Ltd.
- Extron and XTP are registered trademarks of RGB Systems, Inc. in the United States.
- Other product and company names mentioned in this user's manual may be the trademarks or registered trademarks of their respective holders.
- Virtual Remote Tool uses WinI2C/DDC library, © Nicomsoft Ltd.

NOTES

- (1) The contents of this user's manual may not be reprinted in part or whole without permission.
- (2) The contents of this user's manual are subject to change without notice.
- (3) Great care has been taken in the preparation of this user's manual; however, should you notice any questionable points, errors or omissions, please contact us.
- (4) Notwithstanding article (3), NEC will not be responsible for any claims on loss of profit or other matters deemed to result from using the Projector.

Important Information

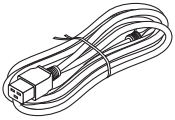

Please use the power cord supplied with this projector. If the supplied power cord does not satisfy requirements of your country's safety standard, and voltage and current for your region, make sure to use the power cord that conforms to and satisfies them.

- The power cord you use must be approved by and comply with the safety standards of your country. Please refer to the page [145](#) about the power cord specification.

Rated voltage by country is listed below for your reference. For selecting an appropriate power cord, please check rated voltage for your region by yourself.

AC 230 V : European countries
AC 120 V : North America

Safety Cautions

Precautions

Please read this manual carefully before using your NEC projector and keep the manual handy for future reference.

CAUTION



To turn off main power, be sure to remove the plug from power outlet.

The power outlet socket should be installed as near to the equipment as possible, and should be easily accessible.

CAUTION



TO PREVENT SHOCK, DO NOT OPEN THE CABINET.

THERE ARE HIGH-VOLTAGE COMPONENTS INSIDE.

REFER SERVICING TO QUALIFIED SERVICE PERSONNEL.



This symbol warns the user that uninsulated voltage within the unit may be sufficient to cause electrical shock. Therefore, it is dangerous to make any kind of contact with any part inside of the unit.



This symbol alerts the user that important information concerning the operation and maintenance of this unit has been provided.

The information should be read carefully to avoid problems.

WARNING: TO PREVENT FIRE OR SHOCK, DO NOT EXPOSE THIS UNIT TO RAIN OR MOISTURE.

DO NOT USE THIS UNIT'S PLUG WITH AN EXTENSION CORD OR IN AN OUTLET UNLESS ALL THE PRONGS CAN BE FULLY INSERTED.

Machine Noise Information Regulation - 3. GPSGV,

The highest sound pressure level is less than 70 dB (A) in accordance with EN ISO 7779.

Disposing of your used product



In the European Union

EU-wide legislation as implemented in each Member State requires that used electrical and electronic products carrying the mark (left) must be disposed of separately from normal household waste. This includes projectors and their electrical accessories. When you dispose of such products, please follow the guidance of your local authority and/or ask the shop where you purchased the product.

After collecting the used products, they are reused and recycled in a proper way. This effort will help us reduce the wastes as well as the negative impact to the human health and the environment at the minimum level. The mark on the electrical and electronic products only applies to the current European Union Member States.

Outside the European Union

If you wish to dispose of used electrical and electronic products outside the European union, please contact your local authority and ask for the correct method of disposal.



For EU: The crossed-out wheeled bin implies that used batteries should not be put to the general household waste! There is a separate collection system for used batteries, to allow proper treatment and recycling in accordance with legislation.

According to the EU directive 2006/66/EC, the battery can't be disposed improperly. The battery shall be separated to collect by local service.

WARNING

This equipment is compliant with Class A of CISPR 32. In a residential environment this equipment may cause radio interference.

RF Interference (for USA only)

WARNING

- The Federal Communications Commission does not allow any modifications or changes to the unit EXCEPT those specified by NEC Display Solutions of America, Inc. in this manual. Failure to comply with this government regulation could void your right to operate this equipment.
- This equipment has been tested and found to comply with the limits for a Class A digital device, pursuant to Part 15 of the FCC Rules. These limits are designed to provide reasonable protection against harmful interference when the equipment is operated in a commercial environment. This equipment generates, uses, and can radiate radio frequency energy and, if not installed and used in accordance with the installation manual, may cause harmful interference to radio communications. Operation of this equipment in a residential area is likely to cause harmful interference in which case the user will be required to correct the interference at his own expense.
- This device complies with Part 15 of FCC Rules. Operation is subject to the following two conditions.
(1) This device may not cause harmful interference, and (2) this device must accept any interference received, including interference that may cause undesired operation.

Important Safeguards

These safety instructions are to ensure the long life of your projector and to prevent fire and shock. Please read them carefully and heed all warnings.

WARNING



- When the projector is damaged, cooling fluids may come out of internal part. Should this happen, immediately turn off the AC supply to the projector and contact your dealer. DO NOT touch and drink the cooling fluid. When the cooling fluids are swallowed or contacted with your eyes, please consult medical attention immediately. If you touch the cooling fluid with your hand, rinse your hands well under running water.

Installation

- Do not place the projector in the following conditions:
 - on an unstable cart, stand, or table.
 - near water, baths, or damp rooms.
 - in direct sunlight, near heaters, or heat radiating appliances.
 - in a dusty, smoky or steamy environment.
 - on a sheet of paper or cloth, rugs or carpets.
- Do not install and store the projector in the below circumstances. Failure to do so may cause of malfunction.
 - In powerful magnetic fields
 - In corrosive gas environment
 - Outdoors
- If you wish to have the projector installed on the ceiling:
 - Do not attempt to install the projector yourself.
 - The projector must be installed by qualified technicians in order to ensure proper operation and reduce the risk of bodily injury.
 - In addition, the ceiling must be strong enough to support the projector and the installation must be in accordance with any local building codes.
 - Please consult your dealer for more information.

WARNING

- Do not cover the lens with the lens cap or equivalent while the projector is on. Doing so can lead to melting of the cap due to the heat emitted from the light output.
- Do not place any objects, which are easily affected by heat, in front of the projector lens. Doing so could lead to the object melting from the heat that is emitted from the light output.

The below pictogram indicated on the cabinet means the precaution for avoiding to place objects in front of the projector lens.



This projector can be installed any angle within vertical and horizontal 360° range, however, life of optical parts will be shortened in the following installation state:

- When the projector is installed on which lens faces downward.
- When the intake vent on the projector side faces downward in the portrait installation. (→ page 131)

For portrait installation, install the projector with the intake vent at the bottom. Observe precautions for portrait installation.

* A customized stand is required to be attached to the projector. (→ page 132)

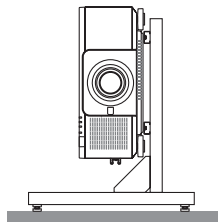

Fire and Shock Precautions

- Ensure that there is sufficient ventilation and that vents are unobstructed to prevent the build-up of heat inside your projector. Allow enough space between your projector and a wall. (→ page xi)
- Do not try to touch the exhaust vent on the rear side (when seen from the front) as it can become heated while the projector is turned on and immediately after the projector is turned off. Parts of the projector may become temporarily heated if the projector is turned off with the POWER button or if the AC power supply is disconnected during normal projector operation.
Use caution when picking up the projector.

Important Information

- Prevent foreign objects such as paper clips and bits of paper from falling into your projector. Do not attempt to retrieve any objects that might fall into your projector. Do not insert any metal objects such as a wire or screwdriver into your projector. If something should fall into your projector, disconnect it immediately and have the object removed by a qualified service personnel.
- Do not place any objects on top of the projector.
- Do not touch the power plug during a thunderstorm. Doing so can cause electrical shock or fire.
- The projector is designed to operate on a power supply of 110-240V AC 50/60 Hz. Ensure that your power supply fits this requirement before attempting to use your projector.
- Make sure to mount the power cord stopper before attempting to use your projector. Please refer to page 15 about the power cord stopper.
- Do not look into the light source using optical instruments (such as magnifying glasses and mirrors). Visual impairment could result.
- When turning on the projector, ensure that nobody is facing towards the lens in the path of the light emitted from the laser. Do not look into the lens while the projector is on. Serious damage to your eyes could result. The following label, that is indicated at the lens-mounting-section on the projector cabinet, describes this projector is categorized in the risk group 2 of IEC 62471-5: 2015. As with any bright light source, do not stare into the beam, RG2 IEC 62471-5: 2015.

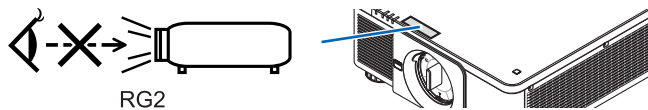

- Perform the adjustment from behind or from the side of the projector. Adjusting from the front could expose your eyes to strong light which could injure them.
- Keep any items (magnifying glass etc.) out of the light path of the projector. The light path being projected from the lens is extensive, therefore any kind of abnormal objects that can redirect light coming out of the lens, can cause an unpredictable outcome such as a fire or injury to the eyes.
- Do not place any objects, which are easily affected by heat, in front of a projector exhaust vent. Doing so could lead to the object melting or getting your hands burned from the heat that is emitted from the exhaust vent.
- Handle the power cord carefully. A damaged or frayed power cord can cause electric shock or fire.
 - Do not use any power cord other than the one supplied with the projector.
 - Do not bend or tug the power cord excessively.
 - Do not place the power cord under the projector, or any heavy object.
 - Do not cover the power cord with other soft materials such as rugs.
 - Do not heat the power cord.
 - Do not handle the power plug with wet hands.
- Turn off the projector, unplug the power cord and have the projector serviced by a qualified service personnel under the following conditions:
 - When the power cord or plug is damaged or frayed.
 - If liquid has been spilled into the projector, or if it has been exposed to rain or water.
 - If the projector does not operate normally when you follow the instructions described in this user's manual.
 - If the projector has been dropped or the cabinet has been damaged.
 - If the projector exhibits a distinct change in performance, indicating a need for service.
- Disconnect the power cord and any other cables before carrying the projector.
- Turn off the projector and unplug the power cord before cleaning the cabinet.
- Turn off the projector and unplug the power cord if the projector is not to be used for an extended period of time.
- When using a LAN cable:
 - For safety, do not connect to the terminal for peripheral device wiring that might have excessive voltage.
- Do not use the malfunctioned projector. It may cause of not only electric shock or fire but also serious damage to your eye sight.
- Do not let children to operate the projector by themselves. If the projector is operated by children, adults need to attend and keep their eyes on children.
- If damage or malfunction of the projector is found, immediately stop to use it and consult your dealer for repair.
- Never disassemble, repair, and remodel by end users. If these are performed by end users, it may cause of serious problem on users' safety.
- Consult your dealer for disposing the projector. Never disassemble the projector before disposing it.

CAUTION

- Keep hands away from the lens mounting portion while performing a lens shift. Failure to do so could result in fingers being pinched by the moving lens.
- Do not use the tilt-foot for purposes other than originally intended. Misuses such as gripping the tilt-foot or hanging on the wall can cause damage to the projector.
- Select [HIGH] in Fan mode if you continue to use the projector for consecutive days. (From the menu, select [SETUP] → [INSTALLATION(1)] → [FAN MODE] → [HIGH].)
- Do not unplug the power cord from the wall outlet or projector when the projector is powered on. Doing so can cause damage to the AC IN terminal of the projector and (or) the prong plug of the power cord.
To turn off the AC power supply when the projector is powered on, use the projector's main power switch, a power strip equipped with a switch, or a breaker.
- When moving the projector, make sure you have at least two people. Attempting to move the projector alone could result in back pain or other injuries.

Caution on Handling the Optional Lens

When shipping the projector with the lens, remove the lens before shipping the projector. Always attach the dust cap to the lens whenever it is not mounted on the projector. The lens and the lens shift mechanism may encounter damage caused by improper handling during transportation.

Do not hold the lens part when carrying the projector.

Doing so could cause the focus ring to rotate, resulting in accidental dropping of the projector.

In the condition the projector is no lens mounted, do not put your hands in the lens mount opening for carrying the projector.

For mounting, replacing, and cleaning the lens, make sure to power off the projector and disconnect the power cord. Failure to do so can result in eye injury, electric shock, or burn injuries.

Keep hands away from the lens mounting portion while performing a lens shift. Failure to do so could result in fingers being pinched by the moving lens.

Cable information

CAUTION

For HDMI, DisplayPort, BNC, LAN, and RS232C, please use a shielded cable.
Use of other cables may cause interference with radio and television reception.

Precautions when installing or replacing the lens unit sold separately (LENS CALIBRATION)

After installing or replacing the lens unit, press either the CALIBRATION button on the main unit or the INFO/L-CALIB. button while pressing the CTL button on the remote control to carry out [LENS CALIBRATION]. (→ page 17, 105)
By carrying out [LENS CALIBRATION], the adjustment range of the zoom, focus, and shift of the [LENS MEMORY] is calibrated.

Contact your dealer to install and replace the lens unit.

Remote Control Precautions

- Handle the remote control carefully.
- If the remote control gets wet, wipe it dry immediately.
- Avoid excessive heat and humidity.
- Do not short, heat, or take apart batteries.
- Do not throw batteries into fire.
- If you will not be using the remote control for a long time, remove the batteries.
- Ensure that you have the batteries' polarity (+/-) aligned correctly.
- Do not use new and old batteries together, or use different types of batteries together.
- Dispose of used batteries according to your local regulations.

Light Module

1. A light module containing multiple laser diodes is equipped in the product as the light source.
2. These laser diodes are sealed in the light module. No maintenance or service is required for the performance of the light module.
3. End user is not allowed to replace the light module.
4. Contact qualified distributor for light module replacement and further information.

Laser Safety Caution

• For USA

This product is classified as Class 3R of IEC 60825-1 Second edition 2007-03

Complies with FDA performance standards for laser products except for deviations pursuant to Laser Notice No. 50, dated June 24, 2007.

For other regions

This product is classified as Class 1 of IEC 60825-1 Third edition 2014-05 and EN 60825-1 Third edition 2014-08.

This product is classified as RG2 of IEC 62471-5 First edition 2015-06.

Obey the laws and regulations of your country in relation to the installation and management of the device.

- Outline of laser emitted from the built-in light module:
 - Wave length: 450–460 nm
 - Maximum power: 380 W
- Radiation pattern from the protective housing:
 - Wave length: 450–460 nm
 - Maximum laser radiation output: 0.253 mJ
 - Pulse duration: 0.5 ms
 - Repetition frequency: 240 Hz
- The laser module is equipped in this product. Use of controls or adjustments of procedures other than those specified herein may result in hazardous radiation exposure.

 **CAUTION**

- Use of controls or adjustments or performance of procedures other than those specified herein may result in hazardous radiation exposure.

 **CAUTION – CLASS 3R OF IEC 60825-1 SECOND EDITION LASER PRODUCT**

LASER LIGHT – AVOID DIRECT EYE EXPOSURE

Laser light radiation range

The figure below shows the maximum radiation range of the laser light.
(unit: degree)

Applicable lens unit: NP16FL-4K/NP17ZL-4K/NP18ZL-4K/NP19ZL-4K/NP20ZL-4K/NP21ZL-4K/NP31ZL-4K
Horizontal angle H

Lens	Zoom	
	Tele	Wide
NP16FL-4K	—	32.6
NP17ZL-4K	15.5	21.6
NP18ZL-4K	12.3	16.0
NP19ZL-4K	7.7	12.6
NP20ZL-4K	5.3	7.9
NP21ZL-4K	3.4	5.4
NP31ZL-4K	27.6	33.2

Vertical angle V

Lens	Zoom	
	Tele	Wide
NP16FL-4K	—	19.7
NP17ZL-4K	8.9	12.5
NP18ZL-4K	7.0	9.1
NP19ZL-4K	4.3	7.1
NP20ZL-4K	3.0	4.5
NP21ZL-4K	1.9	3.0
NP31ZL-4K	16.4	20.2

Applicable lens unit: NP39ML-4K

Horizontal angle H

Lens	Zoom	
	Tele	Wide
NP39ML-4K	—	53.0

Vertical angle V

Lens	Tele	Zoom	
		Wide	
		V1	V2
NP39ML-4K	—	9.5	18.8

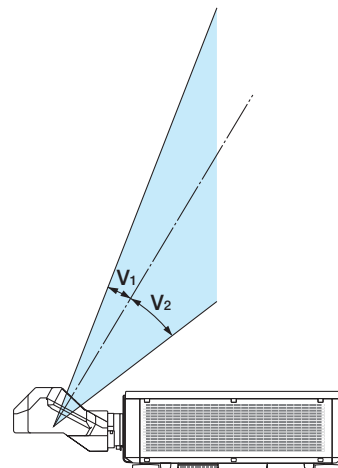
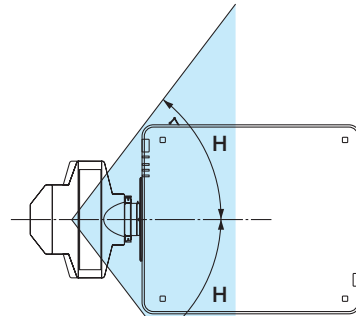
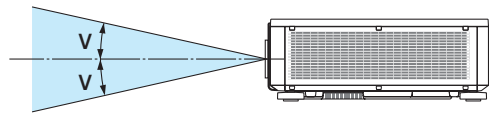
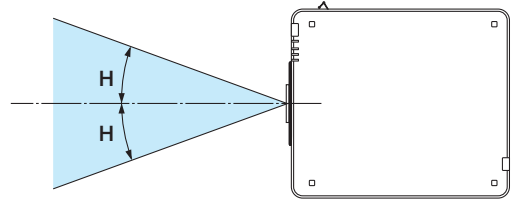

Important Information

- These labels of the LASER PRODUCT in CLASS 3R conforming to IEC 60825-1 Second edition, and in Class 1 conforming to IEC 60825-1 Third edition are stuck on the below indicated positions.

Label 1



Label 2

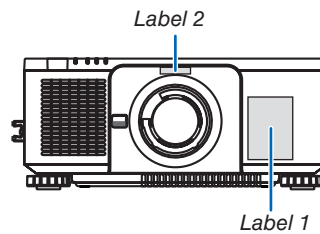

• Manufacturer's ID Label

(For PX1005QL-W)

<p>NEC MODEL No. NP-PX1005QL-W 110-240V ~ 50/60Hz 12.5A - 5.5A</p> <p>THIS DEVICE COMPLIES WITH PART 15 OF THE FCC RULES. OPERATION IS SUBJECT TO THE FOLLOWING TWO CONDITIONS: (1) THIS DEVICE MAY NOT CAUSE HARMFUL INTERFERENCE, AND (2) THIS DEVICE MUST ACCEPT ANY INTERFERENCE RECEIVED, INCLUDING INTERFERENCE THAT MAY CAUSE UNDESIRABLE OPERATION.</p> <p>CAN ICES-3(A)/NMB-3(A)</p> <p>Complies with FDA performance standards for laser products except for deviations pursuant to Laser Notice No.50, dated June 24, 2007.</p> <p>THIS CABINET IS CONSTRUCTED OF PLASTIC (PC).</p> <p>Contact address for EMEA NEC Display Solutions Europe GmbH Landshuter Allee 12-14 80637 Munich, Germany</p> <p>Производитель Модель NP-PX1005QL-W 110-240 В ~, 50/60 Гц, 12.5-5.5 А Сделано в Китае</p>		<p>제품명: 프로젝터 모델명: NP-PX1005QL-W 제조/국가: 델타 비디오 디스플레이 시스템 (우징) 리미티드 / 중국 입력전압: 110-240V ~, 50/60Hz, 12.5A - 5.5A 생산일: 일련번호에 표기 인증 서비스 센터 전화 번호: 080-022-1155 (호스팅IT주식회사) *본 리본과 전화번호는 국내 규정 내에서 특별한 목적으로 로안 사용되어야 합니다.</p> <p>Tegangan dan Frekuensi: 110-240V ~ 50/60Hz Produksi China</p>		<p>CAUTION : TO PREVENT ELECTRIC SHOCK, DO NOT OPEN TOP COVER. NO USER-SERVICEABLE PARTS INSIDE. ATTENTION : AFIN DE PREVENIR UN CHOC ELECTRIQUE NE PAS ENLEVER LE COUVERCLE S'ADRESSER A UN REPARATEUR COMPETENT. ACHTUNG : ZUR VERMEIDUNG EINES ELEKTRISCHEN SCHLAGES, OFFNEN SIE DAS GEHÄUSE NICHT SELBST. IN DIESEM GERÄT SIND KEINE TEILE ENTHALTEN, DIE VOM NUTZER GEWARTET WERDEN KÖNNEN. ZUR TRENNUNG VOM NETZ IST DER NETZSTECKER AUS DER STECKDOSE ZU ZIEHEN! ВНИМАНИЕ : ВО ИЗБЕЖАНИЕ УДАРА ЭЛЕКТРИЧЕСКИМ ТОКОМ НЕ ОТКРЫВАЙТЕ ВЕРХНЮЮ КРЫШКУ. ВНУТРИ НЕТ ДЕТАЛЕЙ, ОБСЛУЖИВАЕМЫХ ПОЛЬЗОВАТЕЛЕМ. 주의 : 전기충격 방지를 위해 캐비닛을 열지 마십시오. 내부에는 사용자를 위한 서비스가능 부품이 들어있지 않습니다.</p> <p>注意 : 請勿打開頂蓋, 小心高壓電擊。機內並無用戶可服務零件。 警告使用者 : 此為甲類資訊技術設備。於居住環境中使用時, 可能會造成射頻擾動。在此種情況下, 使用者會被要求採取某些適當的對策。</p> <p>投影机 型號 NP-PX1005QL-W 額定輸入電流: 12.5A 至 5.5A 電源: 110-240V 交流電, 50/60Hz 生產國別: 中國 NEC Display Solutions, Ltd. 4-2B, Mita 1-chome, Minato-ku, Tokyo, Japan MADE IN CHINA</p>	
--	--	---	--	---	--

(For PX1005QL-B)

<p>NEC MODEL No. NP-PX1005QL-B 110-240V ~ 50/60Hz 12.5A - 5.5A</p> <p>THIS DEVICE COMPLIES WITH PART 15 OF THE FCC RULES. OPERATION IS SUBJECT TO THE FOLLOWING TWO CONDITIONS: (1) THIS DEVICE MAY NOT CAUSE HARMFUL INTERFERENCE, AND (2) THIS DEVICE MUST ACCEPT ANY INTERFERENCE RECEIVED, INCLUDING INTERFERENCE THAT MAY CAUSE UNDESIRABLE OPERATION.</p> <p>CAN ICES-3(A)/NMB-3(A)</p> <p>Complies with FDA performance standards for laser products except for deviations pursuant to Laser Notice No.50, dated June 24, 2007.</p> <p>THIS CABINET IS CONSTRUCTED OF PLASTIC (PC).</p> <p>Contact address for EMEA NEC Display Solutions Europe GmbH Landshuter Allee 12-14 80637 Munich, Germany</p> <p>Производитель Модель NP-PX1005QL-B 110-240 В ~, 50/60 Гц, 12.5-5.5 А Сделано в Китае</p>		<p>제품명: 프로젝터 모델명: NP-PX1005QL-B 제조/국가: 델타 비디오 디스플레이 시스템 (우징) 리미티드 / 중국 입력전압: 110-240V ~, 50/60Hz, 12.5A - 5.5A 생산일: 일련번호에 표기 인증 서비스 센터 전화 번호: 080-022-1155 (호스팅IT주식회사) *본 리본과 전화번호는 국내 규정 내에서 특별한 목적으로 로안 사용되어야 합니다.</p> <p>Tegangan dan Frekuensi: 110-240V ~ 50/60Hz Produksi China</p>		<p>CAUTION : TO PREVENT ELECTRIC SHOCK, DO NOT OPEN TOP COVER. NO USER-SERVICEABLE PARTS INSIDE. ATTENTION : AFIN DE PREVENIR UN CHOC ELECTRIQUE NE PAS ENLEVER LE COUVERCLE S'ADRESSER A UN REPARATEUR COMPETENT. ACHTUNG : ZUR VERMEIDUNG EINES ELEKTRISCHEN SCHLAGES, OFFNEN SIE DAS GEHÄUSE NICHT SELBST. IN DIESEM GERÄT SIND KEINE TEILE ENTHALTEN, DIE VOM NUTZER GEWARTET WERDEN KÖNNEN. ZUR TRENNUNG VOM NETZ IST DER NETZSTECKER AUS DER STECKDOSE ZU ZIEHEN! ВНИМАНИЕ : ВО ИЗБЕЖАНИЕ УДАРА ЭЛЕКТРИЧЕСКИМ ТОКОМ НЕ ОТКРЫВАЙТЕ ВЕРХНЮЮ КРЫШКУ. ВНУТРИ НЕТ ДЕТАЛЕЙ, ОБСЛУЖИВАЕМЫХ ПОЛЬЗОВАТЕЛЕМ. 주의 : 전기충격 방지를 위해 캐비닛을 열지 마십시오. 내부에는 사용자를 위한 서비스가능 부품이 들어있지 않습니다.</p> <p>注意 : 請勿打開頂蓋, 小心高壓電擊。機內並無用戶可服務零件。 警告使用者 : 此為甲類資訊技術設備。於居住環境中使用時, 可能會造成射頻擾動。在此種情況下, 使用者會被要求採取某些適當的對策。</p> <p>投影机 型號 NP-PX1005QL-B 額定輸入電流: 12.5A 至 5.5A 電源: 110-240V 交流電, 50/60Hz 生產國別: 中國 NEC Display Solutions, Ltd. 4-2B, Mita 1-chome, Minato-ku, Tokyo, Japan MADE IN CHINA</p>	
--	--	---	--	---	--

Position of the Manufacturer's ID Label

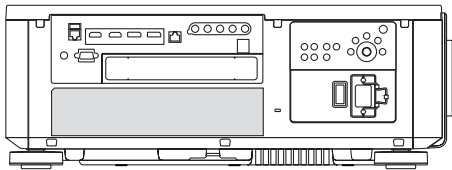

About Copyright of original projected pictures:

Please note that using this projector for the purpose of commercial gain or the attraction of public attention in a venue such as a coffee shop or hotel and employing compression or expansion of the screen image with the following functions may raise concern about the infringement of copyrights which are protected by copyright law: [ASPECT RATIO], [KEYSTONE], Magnifying feature and other similar features.

Clearance for Installing the Projector

Allow ample clearance between the projector and its surroundings as shown below.

The high temperature exhaust coming out of the device may be sucked into the device again.

Avoid installing the projector in a place where air movement from the HVAC is directed at the projector.

Heated air from the HVAC can be taken in by the projector's intake vent. If this happens, the temperature inside the projector will rise too high causing the over-temperature protector to automatically turn off the projector's power.

- Concerning to the portrait projection, please refer "Portrait projection" on page 131.

Example 1 – If there are walls on both sides of the projector.

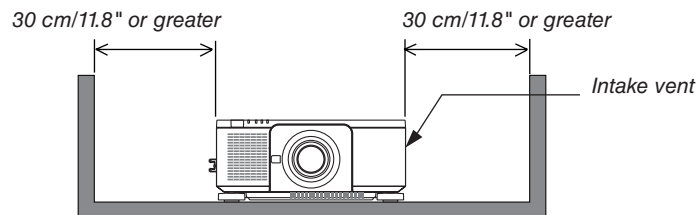

NOTE:

- The drawing shows the proper clearance required for the left and right of the projector assuming sufficient clearance has been kept for the front, back and top of the projector.

Example 2 – If there is a wall behind the projector.

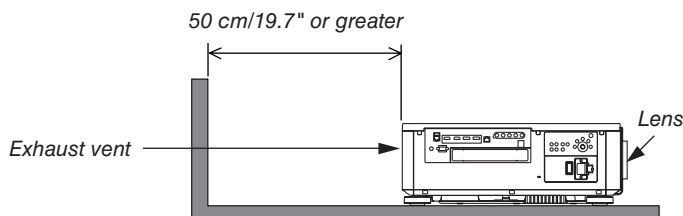

NOTE:

- The drawing shows the proper clearance required for the back of the projector assuming sufficient clearance has been kept for the right, left and top of the projector.

Table of Contents

Important Information	i
1. Introduction	1
❶ What's in the Box?	1
❷ Introduction to the Projector.....	3
❸ Part Names of the Projector	6
❹ Part Names of the Remote Control.....	10
2. Projecting an Image (Basic Operation)	13
❶ Flow of Projecting an Image	13
❷ Connecting Your Computer/Connecting the Power Cord	14
❸ Turning on the Projector.....	16
❹ Selecting a Source	19
❺ Adjusting the Picture Size and Position	22
❻ Turning off the Projector	33
❼ After Use	34
3. Convenient Features	35
❶ Turn off the light of the projector (LENS SHUTTER).....	35
❷ Turning off the Image (AV-MUTE)	35
❸ Turning Off the On-Screen Menu (On-Screen Mute)	35
❹ Shift the On-Screen Menu displaying position.....	36
❺ Freezing a Picture.....	37
❻ Magnifying a Picture	38
❼ Adjustment of luminance (brightness) and energy-saving effect	39
❽ Correcting Horizontal and Vertical Keystone Distortion [CORNERSTONE].....	43
❾ Preventing the Unauthorized Use of the Projector [SECURITY].....	46
❿ Controlling the Projector by Using an HTTP Browser	49
⓫ Storing Changes for Lens Shift, Zoom, and Focus [LENS MEMORY].....	57
4. Multi-Screen Projection	63
5. Using On-Screen Menu	70
❶ Using the Menus.....	70
❷ Menu Elements.....	71
❸ List of Menu Items	72
❹ Menu Descriptions & Functions [INPUT]	78
❺ Menu Descriptions & Functions [ADJUST]	82
❻ Menu Descriptions & Functions [DISPLAY]	94
❼ Menu Descriptions & Functions [SETUP]	100
❽ Menu Descriptions & Functions [INFO.]	123

6. Installation and Connections	127
1 Mounting a lens (sold separately)	127
2 Connecting to Other Equipment	129
3 Portrait projection (vertical orientation)	131
4 Stacking projectors	133
7. Maintenance	136
1 Cleaning the Lens	136
2 Cleaning the Cabinet	136
8. Appendix	137
1 Throw distance and screen size	137
2 Mounting the Optional Board (sold separately)	141
3 Compatible Input Signal List	143
4 Specifications	145
5 Cabinet Dimensions	148
6 Pin assignments and signal names of main terminals	149
7 About the ASCII Control Command	151
8 Changing the Background Logo (Virtual Remote Tool)	153
9 Troubleshooting	154
10 PC Control Codes and Cable Connection	161
11 Troubleshooting Check List	162

1. Introduction

① What's in the Box?

Make sure your box contains everything listed. If any pieces are missing, contact your dealer. Please save the original box and packing materials if you ever need to ship your projector.

Projector

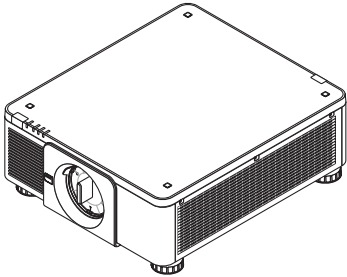

Dust cap for lens

* The projector is shipped without a lens. For the types of lens and throw distances, see page 137.



Remote control
(7N901041)

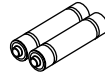

AA alkaline batteries
(x2)

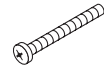

Lens theft prevention screw (79TM1071)
This screw makes it difficult to remove the lens mounted on the projector. (→ page 128)

Power cord × 3

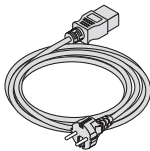

(79TM1021)

For Europe/Asia/South America

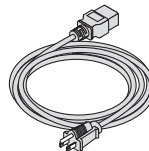

(79TQ1001 for AC 120 V)

For North America

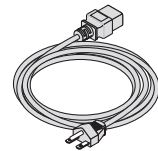

(79TQ1011 for AC 200 V)



4 Stacking holders (79TM1101)

When stacking projectors (double stacking), the tilt foot of the upper projector will be placed onto these stacking holders. (→ page 133)

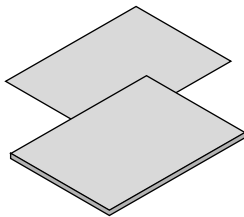

- Important Information (7N8N9041)
- Quick Setup Guide (For North America: 7N8N9051) (For Other countries than North America: 7N8N9051 and 7N8N9061)
- Security Sticker (Use this sticker when security password is set on.)

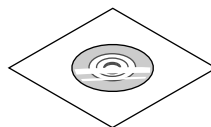

NEC Projector CD-ROM
User's manual (PDF)
(7N952731)

For North America only

Limited warranty

For customers in Europe:

You will find our current valid Guarantee Policy on our Web Site:

<https://www.nec-display-solutions.com>

Removing/Attaching the Dust Cap

To remove the dust cap from the projector, push the tongue at the top left outward and pull the knob at the center of the cap.

To attach the dust cap to the projector, locate the catch on the lower end of the dust cap and place it into the opening of the projector with the point of a triangle mark (▽) facing downward (① in the figure below), and then push the upper end of the dust cap against the projector to place the catches into the slot while clutching the handle (② in the figure below).

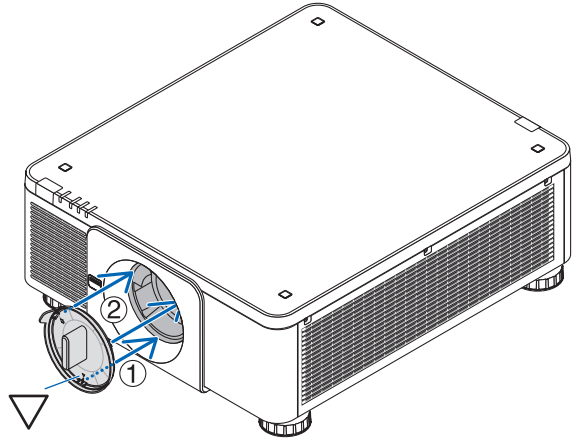
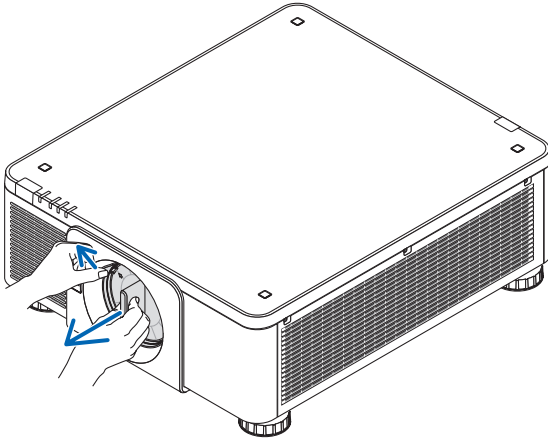

② Introduction to the Projector

This section introduces you to your new projector and describes the features and controls.

General

- **Single-chip DLP projector with high resolution and high brightness**

Realized to project the image in the resolution 3840 × 2160 pixels (4K UHD), the aspect ratio in 16:9, and the brightness in 10000 lumens.

- **Superior dust-proof structure**

Adapted the cycle cooling system for cooling down the optical parts. By this system, air in the light source is cooled down and circulated. As the result, the optical parts are not exposed to the open air and enable to keep brightness without contamination by dust.

* Can not prevent contamination by dust completely.

Light source • Brightness

- **A long-life laser diode is equipped in the light module**

The product can be operated at low cost because the laser light source can be used for a long time without requiring replacement or maintenance.

- **Brightness can be adjusted within a wide range**

Unlike with ordinary light sources, the brightness can be adjusted from 20 to 100% in 1% increments.

- **[CONSTANT BRIGHTNESS] mode**

Brightness normally decreases with use, but by selecting [CONSTANT BRIGHTNESS] mode, sensors inside the projector detect and automatically adjust the output, thereby maintaining constant brightness throughout the life of the light module.

However, if brightness output is set at the maximum, brightness will decrease with use.

Installation

- **Wide range of optional lenses selectable according to the place of installation**

This projector supports 8 types of optional lenses, providing a selection of lenses adapted to a variety of places of installation and projection methods.

In addition, the lenses can be mounted and removed in one touch.

Note that no lens is mounted upon shipment from the factory. Please purchase optional lenses separately.

- **This projector can be installed any angle within vertical and horizontal 360° range, however, life of optical parts will be shorten in the following installation state:**

- When the projector is installed on which lens faces downward.
- When the intake vent on the projector side faces downward in the portrait installation.

- **Double stackable for high light output projection**

By stacking 2 projectors, increased brightness on a large screen is possible.

- **Power lens control for quick and easy adjustment**

By using buttons on the projector or the remote control, zoom, focus, and position (lens shift) can be adjusted.

Videos

- **High quality pictures using Cinema Quality Picture technology**

The device displays high-resolution pictures with its rich gradation expression capability and by improving the contrast in the picture boundary area using the development technology for digital cinema projectors and the unique NEC video processor for image processing.



- **A variety of input terminals such as HDMI, DisplayPort, HDBaseT, SDI, etc.**

The projector is equipped with HDMI (1/2), DisplayPort (1/2), HDBaseT, SDI (1/2/3/4) input terminals. Moreover, You can install optional boards (sold separately) to SLOT.

The projector's HDMI input terminals and DisplayPort input terminals support HDCP.

HDBaseT, promoted and advanced by the HDBaseT Alliance, is a consumer electronic (CE) and commercial connectivity technology.

- **Slot for optional board**

This projector has a slot for optional boards (sold separately).

Network

- **Supports wired LAN**

Equips the LAN and HDBaseT (RJ-45) ports. Utilizing a wired LAN connected with these ports, it enables to control the projector by a computer.

- **Convenient utility software (User Supportware)**

This projector supports our utility software (NaViSet Administrator 2, Virtual Remote Tool, etc.).

NaViSet Administrator 2 helps you control the projector by a computer via wired LAN connection.

Virtual Remote Tool helps you perform operations by a virtual remote control such as projector's power on or off and signal selection via wired LAN connection. Moreover, it has function to send an image to the projector and register it as the logo data.

Please visit our web site for downloading each software.

URL: <https://www.nec-display.com/dl/en/index.html>

- **CRESTRON ROOMVIEW and Extron XTP compatibility**

The projector supports CRESTRON ROOMVIEW and Extron XTP, allowing multiple devices connected in the network to be managed and controlled from a computer. Moreover, it enables to output and control image via an Extron XTP transmitter connected with the projector.

Energy-saving

- **Energy-saving design with a standby power consumption of 0.33 W (110-130 V AC) / 0.35 W (200-240 V AC)**

When the on-screen menu's standby mode is set to "NORMAL", the power consumption in the standby mode activating the Power Management is 0.88 W (110-130 V AC) / 0.92 W (200-240 V AC) and 0.33 W (110-130 V AC) / 0.35 W (200-240 V AC) when LAN is ineffective.

- **"REF. LIGHT MODE" for low power consumption and "Carbon Meter" display**

The projector is equipped with the "REF. LIGHT MODE" for reducing power consumption during use. Furthermore, the power-saving effect when the "REF. LIGHT MODE" is set is converted into the amount of reductions of CO₂ emissions and this is indicated on the confirmation message displayed when the power is turned off and at "Information" on the on-screen menu (CARBON METER).

About this user's manual

The fastest way to get started is to take your time and do everything right the first time. Take a few minutes now to review the user's manual. This may save you time later on. At the beginning of each section of the manual you'll find an overview. If the section doesn't apply, you can skip it.

3 Part Names of the Projector

Front/Top

The lens is sold separately. The description below is for when the NP18ZL-4K lens is mounted.

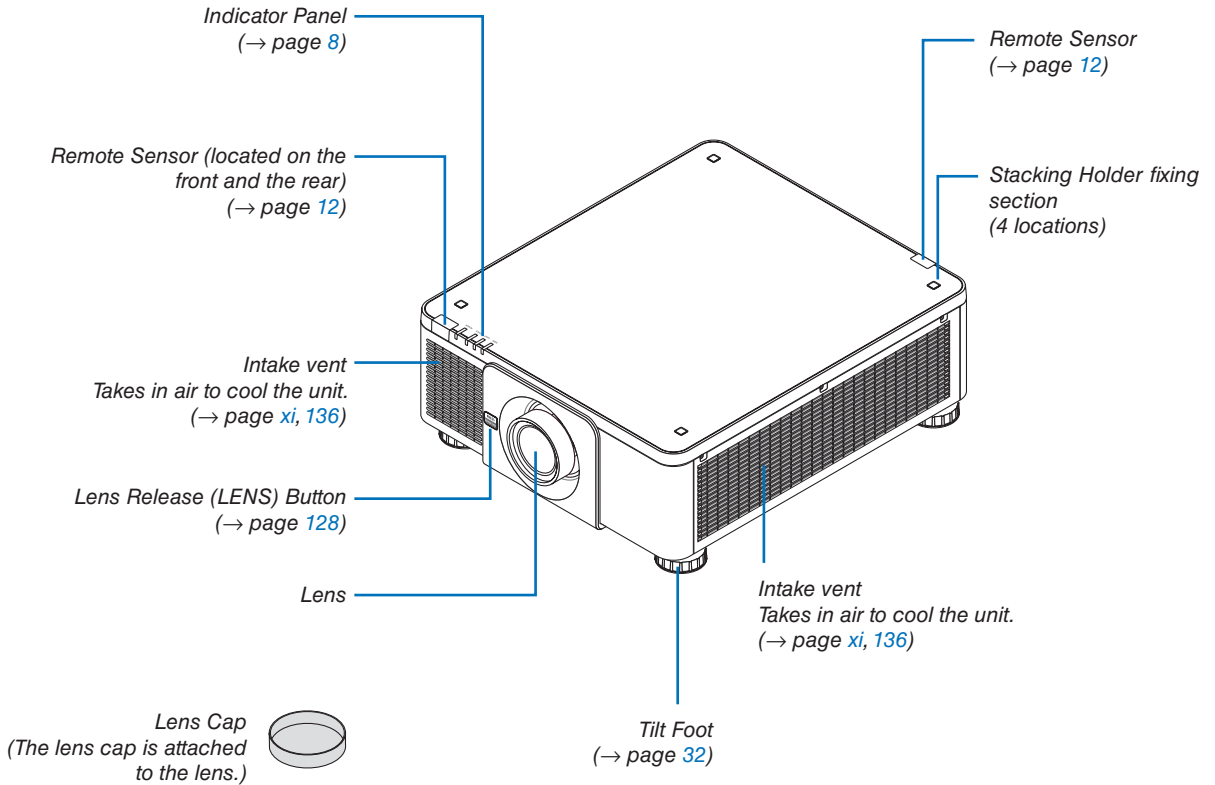

Rear

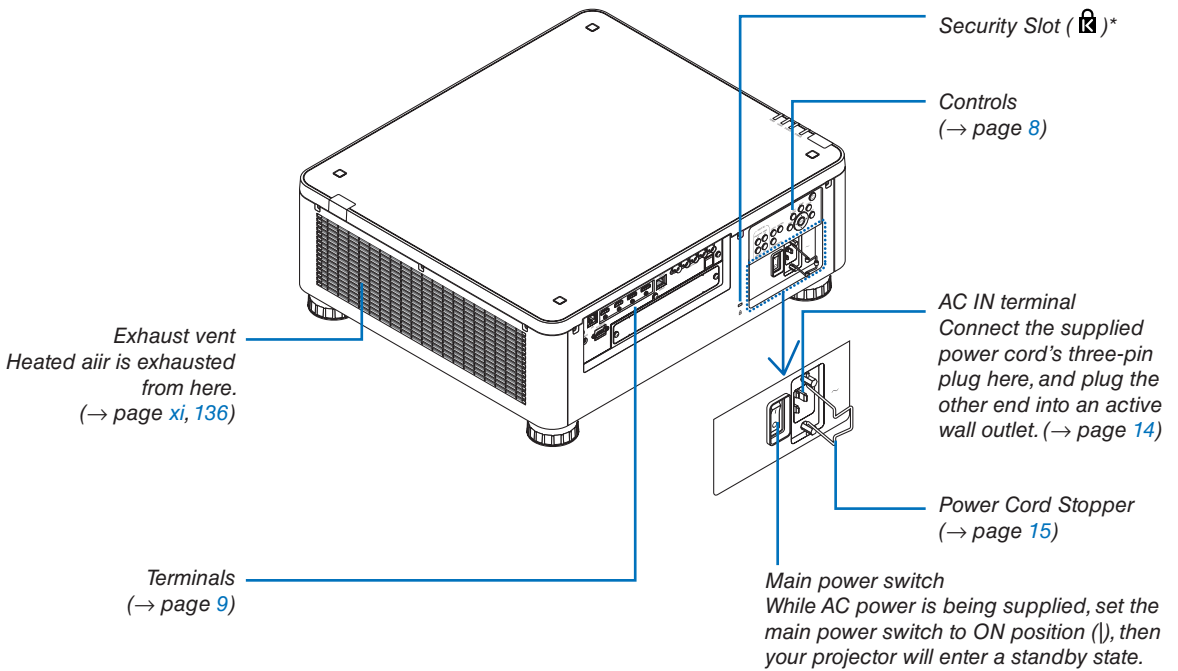

* Security and theft protection lock compatible with Kensington security cables/equipment. For products, visit Kensington's website.

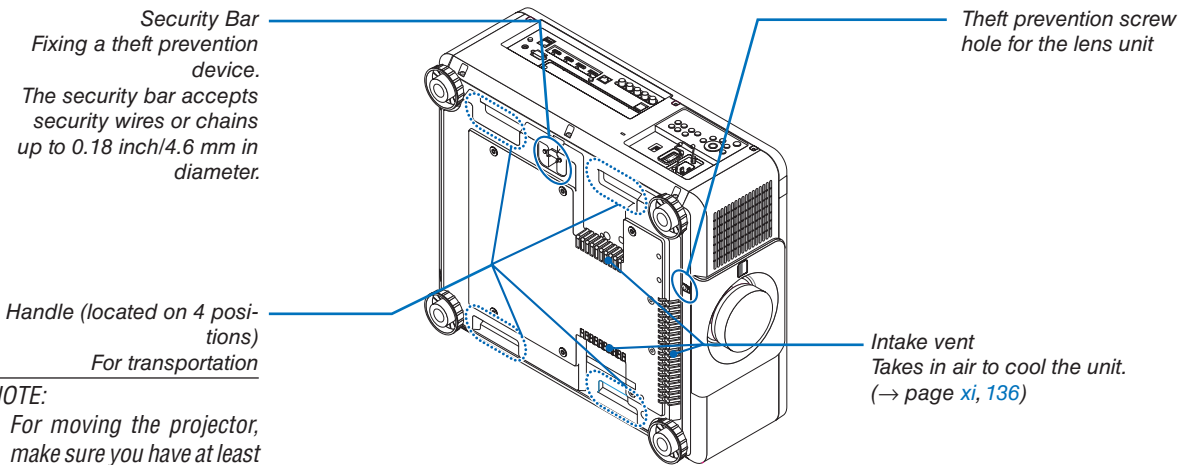

NOTE:

- For moving the projector, make sure you have at least two people. At the same time, do not grip and hold the projector other than by these handles. Attempting to move the projector alone could result in back pain or other injuries.

Controls/Indicator Panel

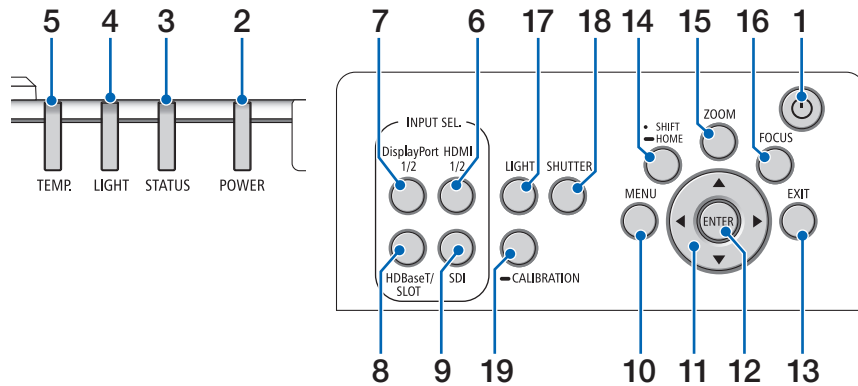

1. **⏻ (POWER) Button**

(→ page 17, 33)

2. **POWER Indicator**

(→ page 17, 33, 154)

3. **STATUS Indicator**

(→ page 154)

4. **LIGHT Indicator**

(→ page 154)

5. **TEMP. Indicator**

(→ page 41, 156)

6. **HDMI 1/2 Button**

(→ page 19)

7. **DisplayPort 1/2 Button**

(→ page 19)

8. **HDBaseT/SLOT Button**

(→ page 19)

9. **SDI Button**

(→ page 19)

10. **MENU Button**

(→ page 70)

11. **▲▼◀▶ Buttons**

(→ page 70)

12. **ENTER Button**

(→ page 70)

13. **EXIT Button**

(→ page 70)

14. **SHIFT/HOME Button**

(→ page 23)

15. **ZOOM Button**

(→ page 31)

16. **FOCUS Button**

(→ page 26)

17. **LIGHT Button**

(→ page 39)

18. **SHUTTER Button**

(→ page 35)

19. **CALIBRATION Button**

(→ page 17, 105)

Terminals Features

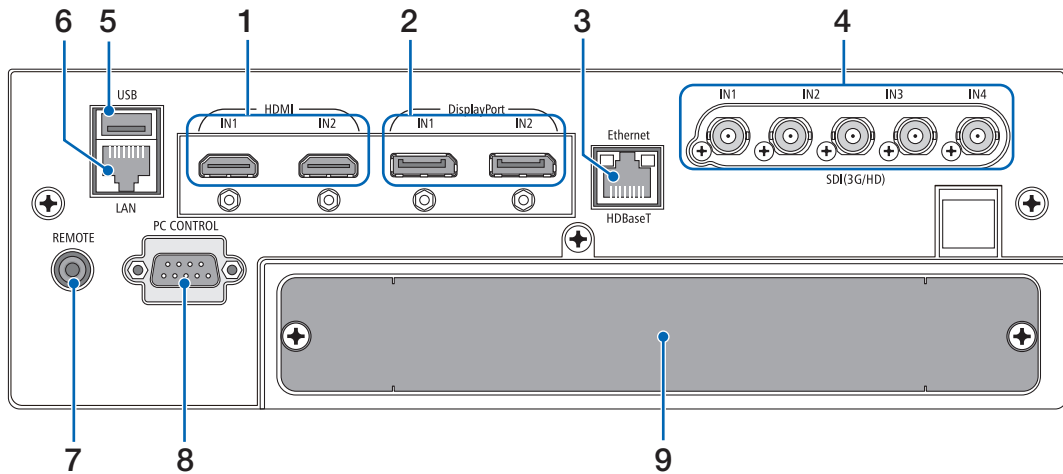

1. **HDMI1 IN/HDMI2 IN Terminal [HDMI IN1/IN2] (Type A)**
(→ page 129)
2. **DisplayPort1 IN/DisplayPort2 IN Terminal [DisplayPort IN1/IN2] (DisplayPort 20 Pin)**
(→ page 129)
3. **HDBaseT Port [Ethernet/HDBaseT] (RJ-45)**
(→ page 129)
4. **SDI1/SDI2/SDI3/SDI4 IN Terminal [SDI(3G/HD) IN1/IN2/IN3/IN4] (BNC)**
(→ page 129)
5. **USB Port (Type A)**
(For future expansion. This port allows for power supply.)
6. **LAN port [LAN] (RJ-45)**
The port for controlling the projector from a PC via a network. Connect the projector and the PC with a shielded twisted pair (STP) cable of Category 5e or higher (sold commercially).
7. **REMOTE Terminal (Stereo Mini)**
Use this jack for wired remote control of the projector using a commercially available remote cable with $\varnothing 3.5$ stereo mini-plug (without resistance).
Connect the projector and the supplied remote control using a commercially available wired remote control cable.
(→ page 12)

NOTE:

- When a remote control cable is connected to the REMOTE terminal, infrared remote control operations cannot be performed.
- Power cannot be supplied from the REMOTE terminal to the remote control.
- When [HDBaseT] is selected in the [REMOTE SENSOR] and the projector is connected to a commercially-available transmission device that supports HDBaseT, remote control operations in infra-red cannot be carried out if transmission of remote control signals has been set up in the transmission device. However, remote control using infrared rays can be carried out when the power supply of the transmission device is switched off.

8. **PC CONTROL Port (D-Sub 9 Pin)**
Use this port to connect a PC or control system. This enables you to control the projector using serial communication protocol. Use a shielded RS232C cable (sold commercially). If you are writing your own program, typical PC control codes are on page 161.
9. **SLOT**
(→ page 141)

4 Part Names of the Remote Control

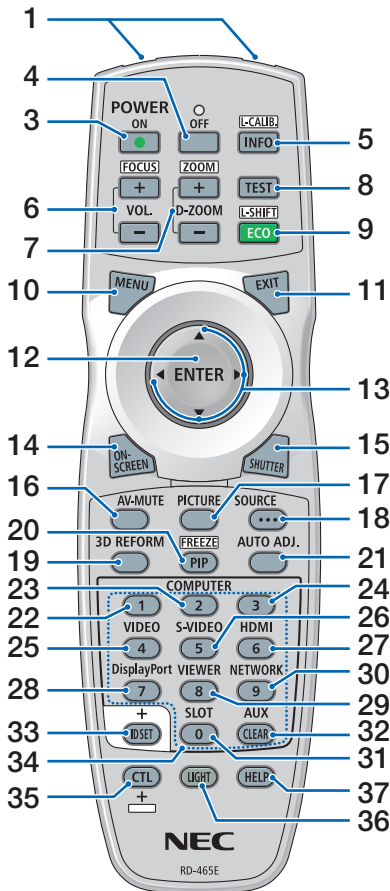

1. Infrared Transmitter
(→ page 12)

2. Remote Jack
Connect a commercially available remote cable here for wired operation. (→ page 12)

3. POWER ON Button
(→ page 17)

4. POWER OFF Button
(→ page 33)

5. INFO/L-CALIB. Button
Display the [SOURCE(1)] screen of the on-screen menu. (→ page 123)
[LENS CALIBRATION] of the lens unit is carried out when you press the CTL button at the same time. (→ page 17, 105)

6. VOL./FOCUS +/- Buttons
(The VOL. button function cannot be used with this series of projectors.) (→ page 26)

7. D-ZOOM/ZOOM +/- Buttons
(→ page 38, 31)

8. TEST Button
(→ page 78)

9. ECO/L-SHIFT Button
(→ page 39, 25)

10. MENU Button
(→ page 70)

11. EXIT Button
(→ page 70)

12. ENTER Button
(→ page 70)

13. ▲▼◀▶ Button
(→ page 70)

14. ON-SCREEN Button
(→ page 35)

15. SHUTTER Button
(→ page 35)

16. AV-MUTE Button
(→ page 35)

17. PICTURE Button
(→ page 82, 85)

18. SOURCE Button
(→ page 20)

19. 3D REFORM Button
(→ page 43)

20. PIP/FREEZE Button
(The PIP button function cannot be used with this series of projectors.) (→ page 37)

21. AUTO ADJ. Button
When projecting the HDMI, DisplayPort, HDBaseT, SDI or SLOT screen, the conditions are automatically adjusted to an optimum state.

22, 23, 24. COMPUTER 1/2/3 Button
(not available on this series of projectors)

25. VIDEO Button
(not available on this series of projectors)

26. S-VIDEO Button
(not available on this series of projectors)

27. HDMI Button
(→ page 19)

28. DisplayPort Button
(→ page 19)

29. VIEWER Button
(not available on this series of projectors)

30. NETWORK Button
(→ page 19)

31. SLOT Button
(→ page 19)

32. AUX Button
(→ page 19)

33. ID SET Button
(→ page 111)

34. Numeric (0 to 9/CLEAR) Buttons
(→ page 111)

35. CTL Button
This button is used in conjunction with other buttons, similar to a CTRL key on a computer.

36. LIGHT Button
This button is used to turn on the backlight for the remote control buttons.

The backlight will turn off if no button operation is made for 10 seconds.

37. HELP Button
(→ page 123)

Battery Installation

1. Press the catch and remove the battery cover.
2. Install new ones (AA). Ensure that you have the batteries' polarity (+/-) aligned correctly.
3. Slip the cover back over the batteries until it snaps into place.

NOTE:

- Do not mix different types of batteries or new and old batteries.

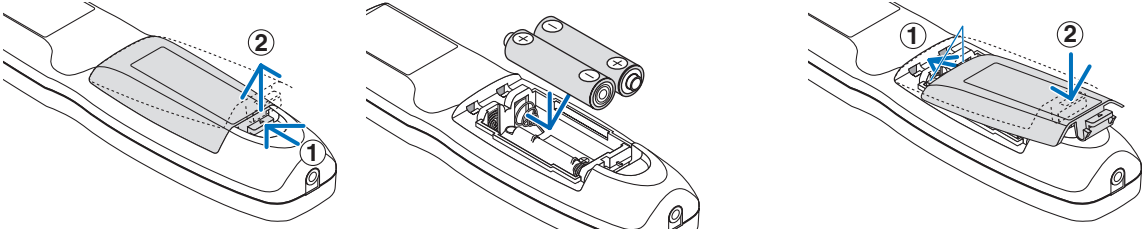

Remote Control Precautions

- Handle the remote control carefully.
- If the remote control gets wet, wipe it dry immediately.
- Avoid excessive heat and humidity.
- Do not short, heat, or take apart batteries.
- Do not throw batteries into fire.
- If you will not be using the remote control for a long time, remove the batteries.
- Ensure that you have the batteries' polarity (+/-) aligned correctly.
- Do not use new and old batteries together, or use different types of batteries together.
- Dispose of used batteries according to your local regulations.

Operating Range for Wireless Remote Control

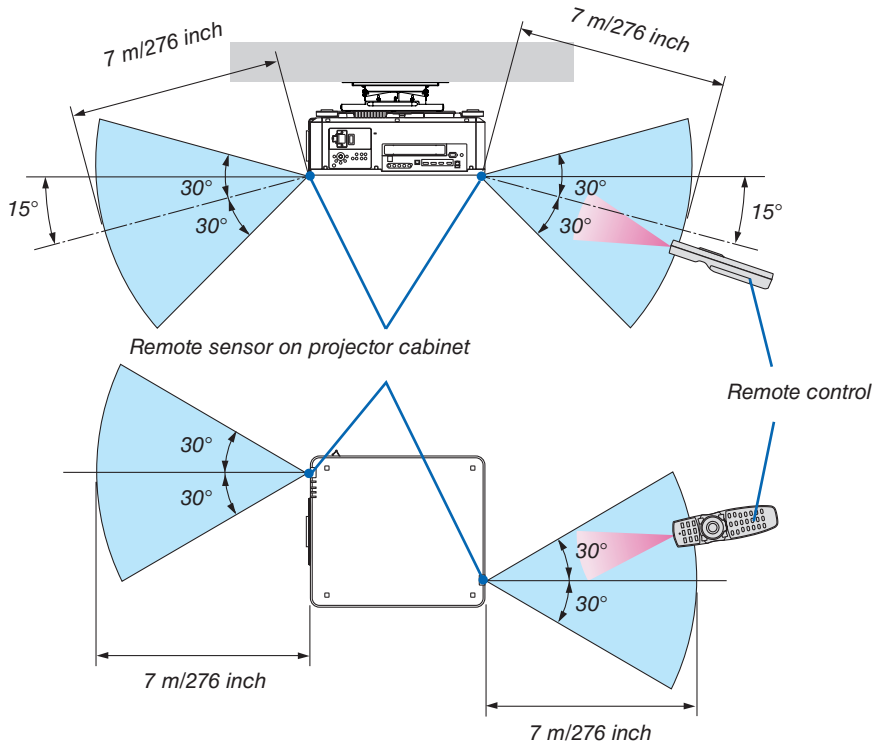

- The infrared signal operates by line-of-sight up to a distance of above meters and within a 60-degree angle of the remote sensor on the projector cabinet.
- The projector will not respond if there are objects between the remote control and the sensor, or if strong light falls on the sensor. Weak batteries will also prevent the remote control from properly operating the projector.

Using the Remote Control in Wired Operation

Connect one end of the remote cable to the REMOTE terminal and the other end to the remote jack on the remote control.

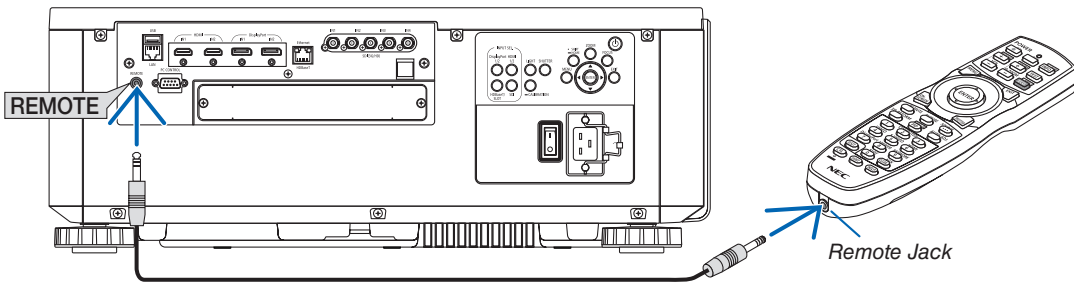

NOTE:

- When a remote cable is inserted into the REMOTE terminal, the remote control does not work for infrared wireless communication.
- Power will not be supplied to the remote control by the projector via the REMOTE jack. Battery is needed when the remote control is used in wired operation.

2. Projecting an Image (Basic Operation)

This section describes how to turn on the projector and to project a picture onto the screen.

① Flow of Projecting an Image

Step 1

- *Connecting your computer / Connecting the power cord (→ page 14)*



Step 2

- *Turning on the projector (→ page 16)*



Step 3

- *Selecting a source (→ page 19)*



Step 4

- *Adjusting the picture size and position (→ page 22)*
- *Correcting keystone distortion [CORNERSTONE] (→ page 43)*



Step 5

- *Adjusting a picture*



Step 6

- *Making a presentation*



Step 7

- *Turning off the projector (→ page 33)*



Step 8

- *After use (→ page 34)*

② Connecting Your Computer/Connecting the Power Cord

1. Connect your computer to the projector.

This section will show you a basic connection to a computer. For information about other connections, see “6-2. Connecting to Other Equipment” on page 129.

Connect the HDMI output terminal of the computer to the HDMI1 or HDMI2 input terminal of the unit.

2. Connect the supplied power cord to the projector.

WARNING

MAKE SURE TO TAKE THE GROUND CONNECTION FOR THE DEVICE.
TO PREVENT FIRE OR SHOCK, DO NOT EXPOSE THIS UNIT TO RAIN OR MOISTURE.
DO NOT USE THIS UNIT'S PLUG WITH AN EXTENSION CORD OR IN AN OUTLET UNLESS ALL THE PRONGS CAN BE FULLY INSERTED.

Important Information:

- When plugging in or unplugging the supplied power cord, make sure that the main power switch is pushed to the off [O] position. Failure to do so may cause damage to the projector.
- Do not use a three-phase power supply. Doing so may cause malfunction.

First connect the supplied power cord's three-pin plug to the AC IN terminal of the projector, and then connect the other plug of the supplied power cord in the wall outlet. Do not use any plug converter.

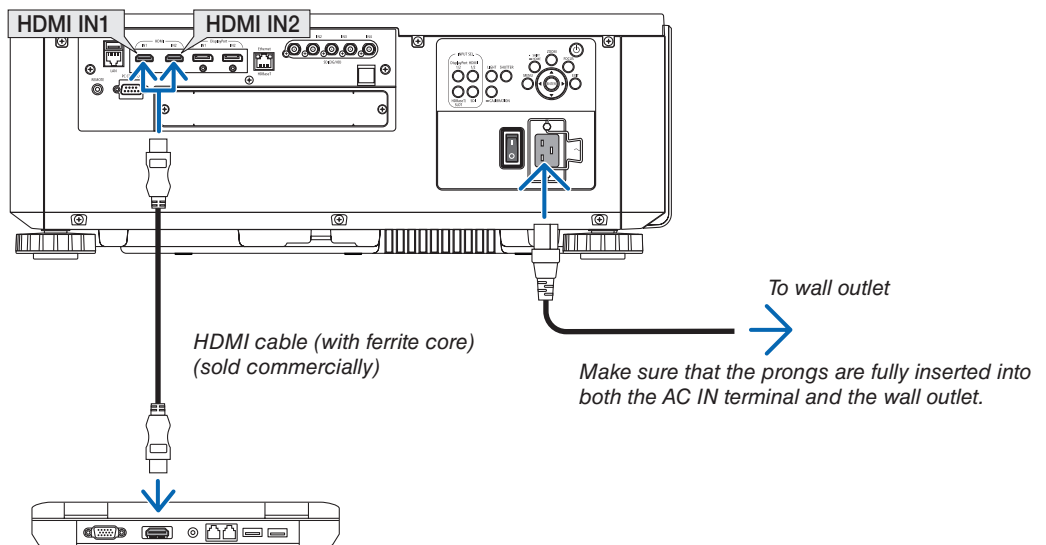

CAUTION:

Parts of the projector may become temporarily heated if the projector is turned off with the POWER button or if the AC power supply is disconnected during normal projector operation.
Use caution when picking up the projector.

2. Projecting an Image (Basic Operation)

Using the Supplied Power Cords

Select the power cord suitable for your country or region.

For Europe/Asia/South America

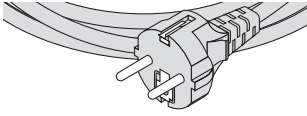

For North America

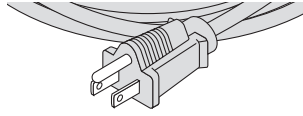

(120 V)

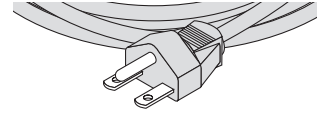

(200 V)

Using the Power Cord Stopper

To prevent the power cord from accidentally removing from the AC IN of the projector, attach the power cord stopper to clamp the power cord.

CAUTION

- To prevent the power cord from coming loose, make sure that all the prongs of the power cord are fully inserted into the AC IN terminal of the projector before using the power cord stopper to fix the power cord. A loose contact of the power cord may cause a fire or electric shock.

Attaching the power cord stopper

1. *Raise up the power cord stopper and lay it over the power cord.*

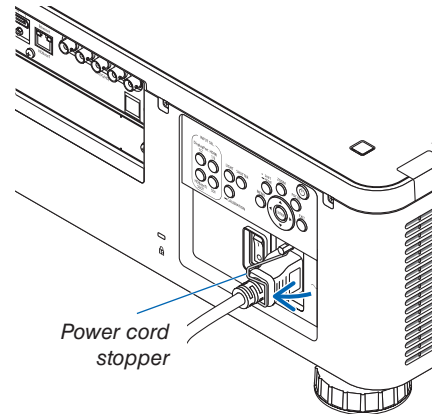

Power cord stopper

- *For releasing the stopper, raise up the stopper and lay it down to the opposite side.*

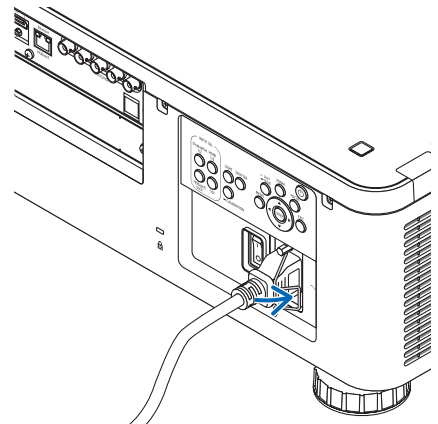

③ Turning on the Projector

NOTE:

- The projector has two power switches: A main power switch and a POWER button (POWER ON and OFF on the remote control)

• Turning on the projector:

1. Press the main power switch to the ON position (I).

The projector will go into standby mode.

2. Press the POWER button .

The projector will become ready to use.

• Turning off the projector:

1. Press the POWER button.

The confirmation message will be displayed.

2. Press the POWER button again.

The projector will go into standby mode.

3. Press the main power switch to the OFF position (O).

The projector will be turned off.

1. Remove the lens cap from the lens unit.

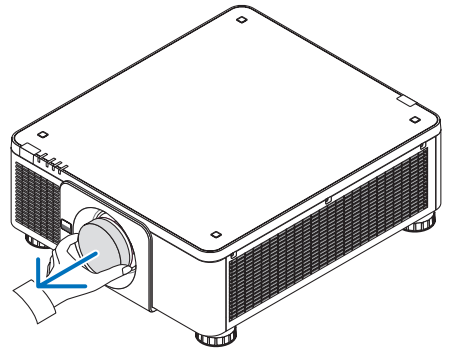

2. Press the main power switch to the ON position (I).

POWER indicator lights up in green. If there is no operation from the unit or communication from the connected device, the unit will go into the standby state after a while. (When the standby mode is set to "Normal")

(→ page 120)

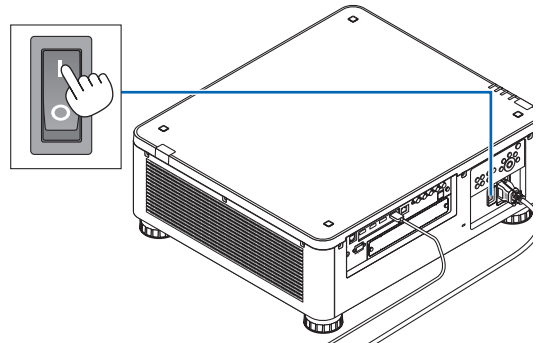

2. Projecting an Image (Basic Operation)

3. Press the  (POWER) button on the projector cabinet or the POWER ON button on the remote control.

WARNING

The projector produces a strong light. When turning on the power, make sure no one within projection range is looking at the lens.

The POWER indicator goes from a steady green light to a flashing blue light, and the picture is projected on the screen.

TIP:

- When the message "PROJECTOR IS LOCKED! ENTER YOUR PASSWORD." is displayed, it means that the [SECURITY] feature is turned on. (→ page 46)

After you turn on your projector, ensure that the computer or video source is turned on.

NOTE:

- The blue screen ([BLUE] background) is displayed when no signal is being input (by factory default menu settings).

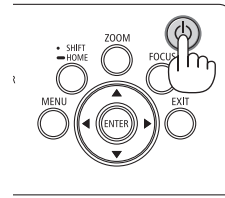

Sleep

Blinking

Power On

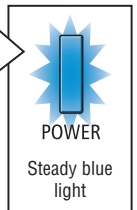
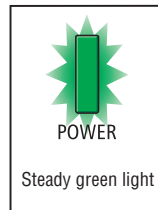

Performing Lens Calibration

After installation or replacement of the lens, be sure to perform [LENS CALIBRATION] by pressing and holding the CALIBRATION button on the projector cabinet for at least two seconds or by holding the CTL button and pressing the INFO/L-CALIB. button on the remote control. Perform [LENS CALIBRATION] also when trouble is found on the lens shift motion. Calibration corrects the adjustable zoom, shift, and focus range. If calibration is not performed, you may not be able to get the best focus and zoom even if you adjust the focus and zoom for the lens. While performing Lens Calibration, the STATUS indicator flashes in green twice per cycle.

- The following lenses need calibration:
NP16FL-4K, NP17ZL-4K, NP18ZL-4K, NP19ZL-4K, NP20ZL-4K, NP21ZL-4K, NP31ZL-4K

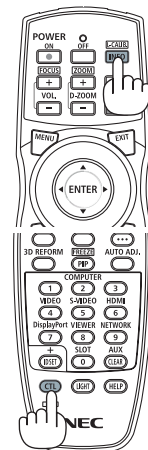
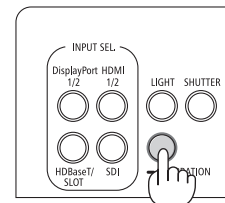

2. Projecting an Image (Basic Operation)

Note on Startup screen (Menu Language Select screen)

When you first turn on the projector, you will get the Startup menu. This menu gives you the opportunity to select one of the 30 menu languages.

To select a menu language, follow these steps:

1. Use the ▲, ▼, ◀ or ▶ button to select one of the 30 languages from the menu.

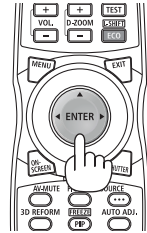
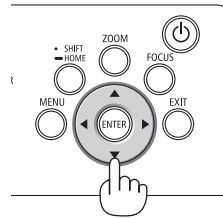

2. Press the ENTER button to execute the selection.

After this has been done, you can proceed to the menu operation.

If you want, you can select the menu language later.
(→ [LANGUAGE] on page 74 and 100)

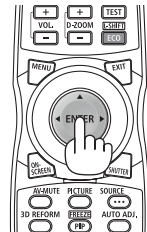
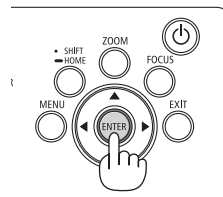

NOTE:

- If the message, [PLEASE SET "DATE AND TIME".] is shown, please set the current date and time. (→ page 110)
- In the case this message is not shown, the [DATE AND TIME SETTING] is recommended to complete.
- If one of the following things happens, the projector will not turn on.
 - If the internal temperature of the projector is too high, the projector detects abnormal high temperature. In this condition the projector will not turn on to protect the internal system. If this happens, wait for the projector's internal components to cool down.
 - If the STATUS indicator lights orange with the power button pressed, it means that the [CONTROL PANEL LOCK] is turned on. Cancel the lock by turning it off. (→ page 110)
- While the POWER indicator is blinking blue in short cycles, the power cannot be turned off by using the power button. (While the POWER indicator is blinking blue in long cycles, the OFF TIMER is functioned and the power can be turned off.)

4 Selecting a Source

Selecting the computer or video source

NOTE:

- Turn on the computer or video source equipment connected to the projector.

Using the Direct button

Press the Direct button on the projector cabinet or remote control. Select the input according to the connection terminal.

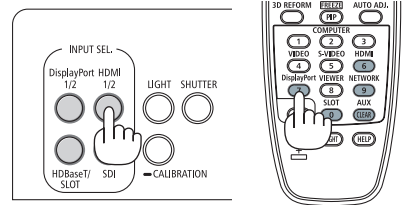

Input connector	Button on the projector cabinet	Button on the remote control	Note
HDMI1/2 IN	HDMI 1/2	HDMI	Switches between HDMI1 and HDMI2 each time it is pressed.
DisplayPort 1/2 IN	DisplayPort 1/2	DisplayPort	Switches between DisplayPort1 and DisplayPort2 each time it is pressed.
SDI 1/2/3/4 IN	SDI	AUX	Switches between SDI1, SDI2, SDI3 and SDI4 each time it is pressed.
HDBaseT	HDBaseT/SLOT	NETWORK	Each time the button of the projector cabinet is pressed, the mode switches between HDBaseT and SLOT.
SLOT	HDBaseT/SLOT	SLOT	Each time the button of the projector cabinet is pressed, the mode switches between HDBaseT and SLOT.

2. Projecting an Image (Basic Operation)

Detecting the Signal Automatically

Press the SOURCE button for 1 second or longer. The projector will search for the available input source and display it. The input source will change as follows:

HDMI1 → HDMI2 → DisplayPort1 → DisplayPort2 → HDBaseT → SDI1 → SDI2 → SDI3 → SDI4 → SLOT.....

TIP:

- If no input signal is present, the input will be skipped.
- Press it briefly to display the [INPUT] screen.

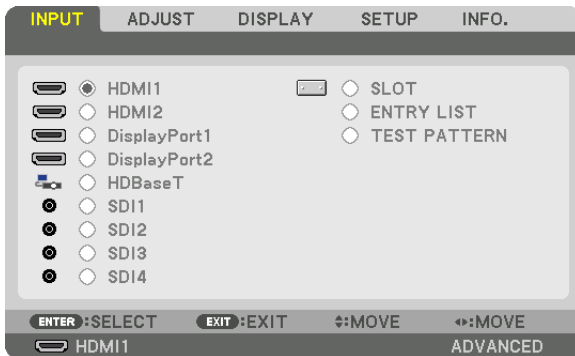
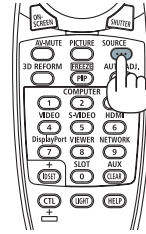

Press the ▼/▲ buttons to match the target input terminal and then press the ENTER button to switch the input. To delete the menu display in the [INPUT] screen, press the MENU or EXIT button.

Selecting Default Source

You can set a source as the default source so that it will be displayed each time the projector is turned on.

1. Press the MENU button.

The menu will be displayed.

2. Press the ► button to select [SETUP] and press the ▼ button or the ENTER button to select [MENU(1)].

3. Press the ► button to select [SOURCE OPTIONS(1)].

4. Press the ▼ button to select [DEFAULT INPUT SELECT] and press the ENTER button.

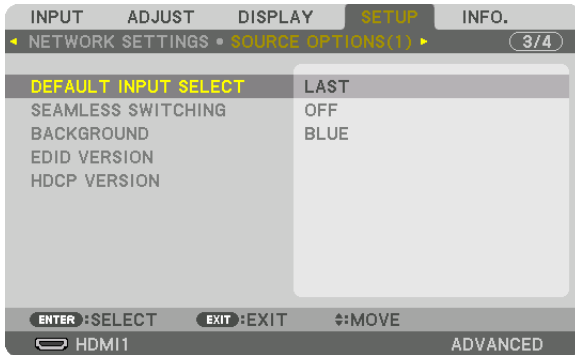

The [DEFAULT INPUT SELECT] screen will be displayed.

(→ page 118)

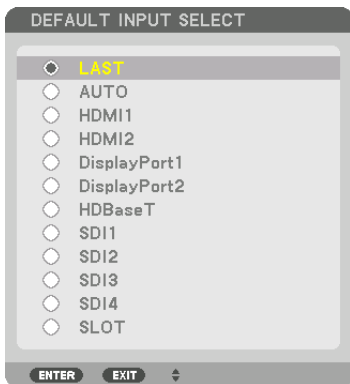

5. Select a source as the default source, and press the ENTER button.

6. Press the EXIT button three times to close the menu.

7. Restart the projector.

The source you selected in step 5 will be projected.

TIP:

- When the projector is in Standby mode, applying a computer signal from a computer will power on the projector and simultaneously project the computer's image.

([AUTO POWER ON SELECT] → page 120)

5 Adjusting the Picture Size and Position

In this chapter drawings and cables are omitted for clarity.

Adjusting the projected image's vertical and horizontal position
[Lens shift]
(→ page 23)

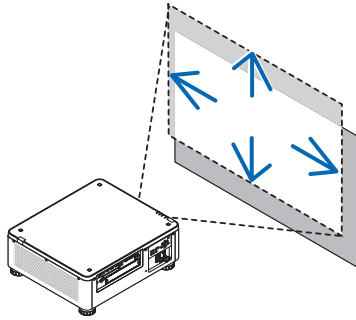

Adjusting the focus
[Focus]
(→ page 26)

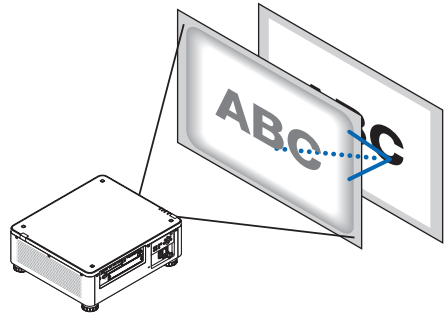

Finely adjusting the size of an image
[Zoom]
(→ page 31)

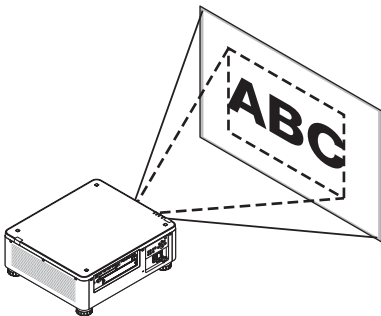

Adjusting the projected image's height and horizontal tilt
[Tilt foot] *1
(→ page 32)

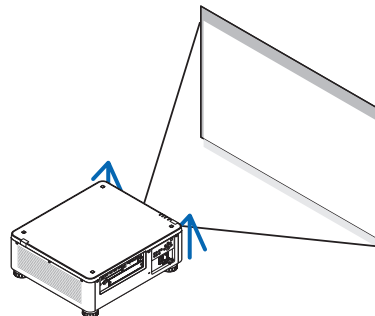

NOTE*1:

- Adjust the projected image's height using the tilt foot when you want to project the image at a position higher than the lens shift adjustment range.

TIP:

- Built-in test patterns can be conveniently used for adjusting the picture size and position. (→ page 78)
A press of the TEST button will display the test pattern. The ◀ or ▶ button can select one test pattern. To close the test pattern, change the source to another.

2. Projecting an Image (Basic Operation)

Adjusting the vertical position of a projected image (Lens shift)

CAUTION

- Perform the adjustment from behind or from the side of the projector. Performing adjustment from the front could expose your eyes to strong light which could injure them.
- Keep hands away from the lens mounting portion while performing a lens shift. Failure to do so could result in fingers being pinched by the moving lens.

NOTE:

- The lens shift function is not available on the projector with either NP16FL-4K or NP39ML-4K lens installed.
For using NP16FL-4K, set back the lens to the home position.
For using NP39ML-4K, select [SETUP] → [INSTALLATION(2)] → [LENS POSITION] → [TYPE] on the onscreen menu, the lens will be moved to the appropriate position automatically.
- Shifting the lens to the maximum in oblique angle will cause the edges of the image to become dark or will cause dark shadows.

Adjusting with buttons on the cabinet

1. Press the **SHIFT/HOME** button.

The [LENS SHIFT] screen will be displayed.

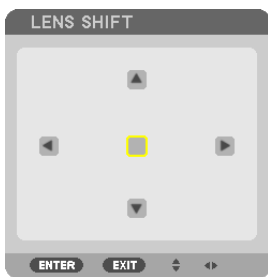

2. Projecting an Image (Basic Operation)

2. Press the ▼▲◀ or ▶ button.

Use the ▼▲▶ buttons to move the projected image.

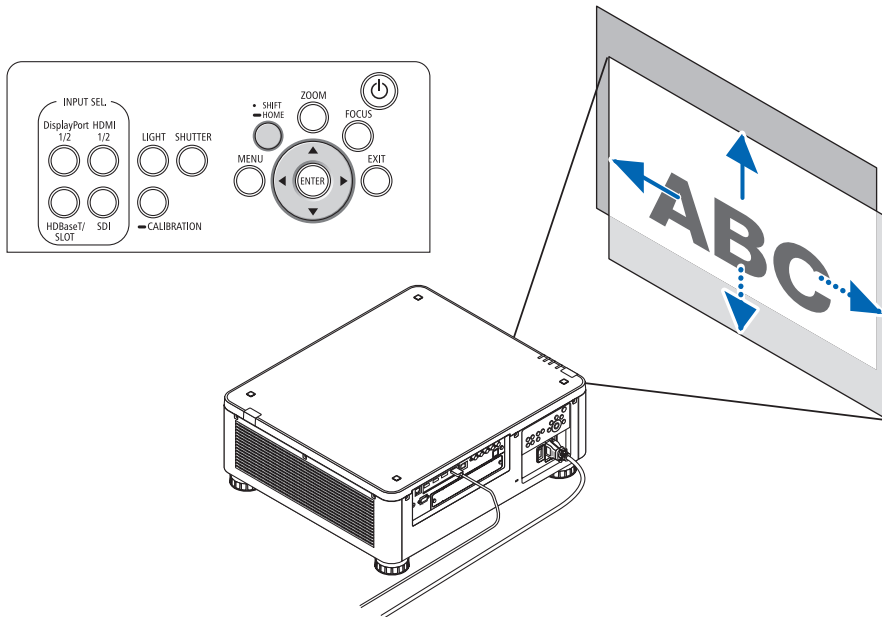

- *Returning the lens shift position to the home position*

Press and hold the SHIFT/HOME button for 2 seconds to return the lens shift position to the home position (nearly center position)

2. Projecting an Image (Basic Operation)

Adjusting with the remote control

1. Hold the CTL button and press the ECO/L-SHIFT button.

The [LENS SHIFT] screen will be displayed.

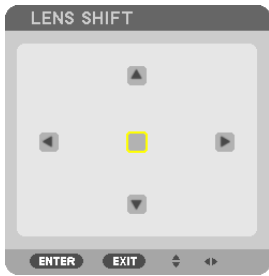

2. Press the ▼▲◀▶ or ▶ button.

Use the ▼▲◀▶ buttons to move the projected image.

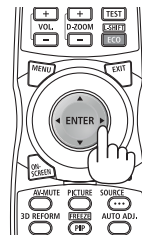
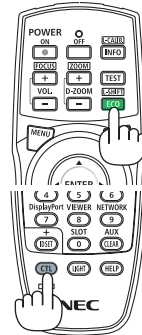

NOTE:

Lens Calibration

If the power of the projector is wrongly shut down during the motion of lens shift, it may shift the home position of the lens and may cause malfunction. The STATUS indicator flashed in Orange to inform this kind of trouble occurrence. In this case, perform lens calibration.

Lens calibration procedures

1. Power on the projector.
2. Press the (CALIBRATION) button on the control panel over 2 seconds or keep pressing the CTL button and press the INFO/L-CALIB. button on the remote control.

Calibration is performed.

TIP:

- The diagram below shows the lens shift adjustment range (projection mode: desktop front). To raise the projection position higher than this, adjust by the tilt foot. (→ page 32)

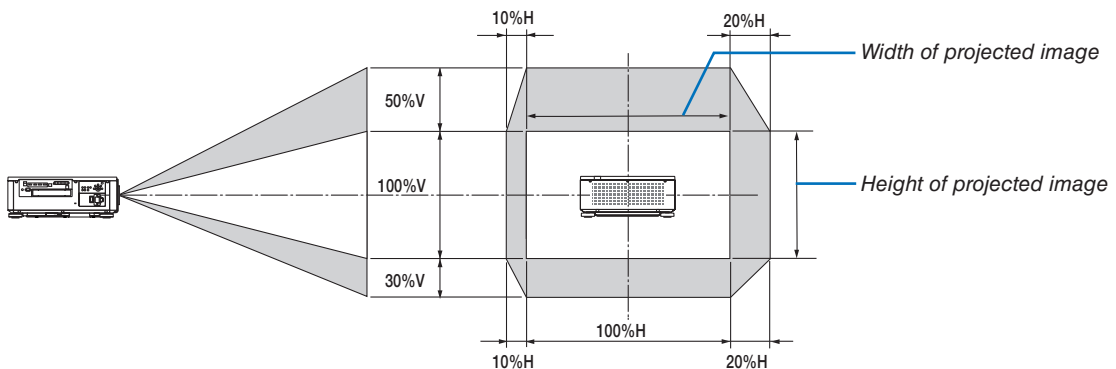

Description of symbols: V indicates vertical (height of the projected image), H indicates horizontal (width of the projected image).

2. Projecting an Image (Basic Operation)

Focus

Recommend to perform the focus adjustment after leaving the projector under the state the TEST PATTERN has been projected for over 30 minutes.

Please refer to page 81 in the User's Manual about the TEST PATTERN.

Applicable lens unit: NP16FL-4K/NP17ZL-4K/NP18ZL-4K/NP19ZL-4K/NP20ZL-4K/NP21ZL-4K

1. Press the FOCUS button.

The FOCUS adjustment bar will be displayed on.



2. Press ◀▶ buttons to adjust focus.

- On the remote control, while pressing on the CTL button, press on VOL/FOCUS (+) or (-) button.
- ◀ or ▶ buttons on the remote control are also available to adjust FOCUS while the FOCUS adjustment bar is displayed on.

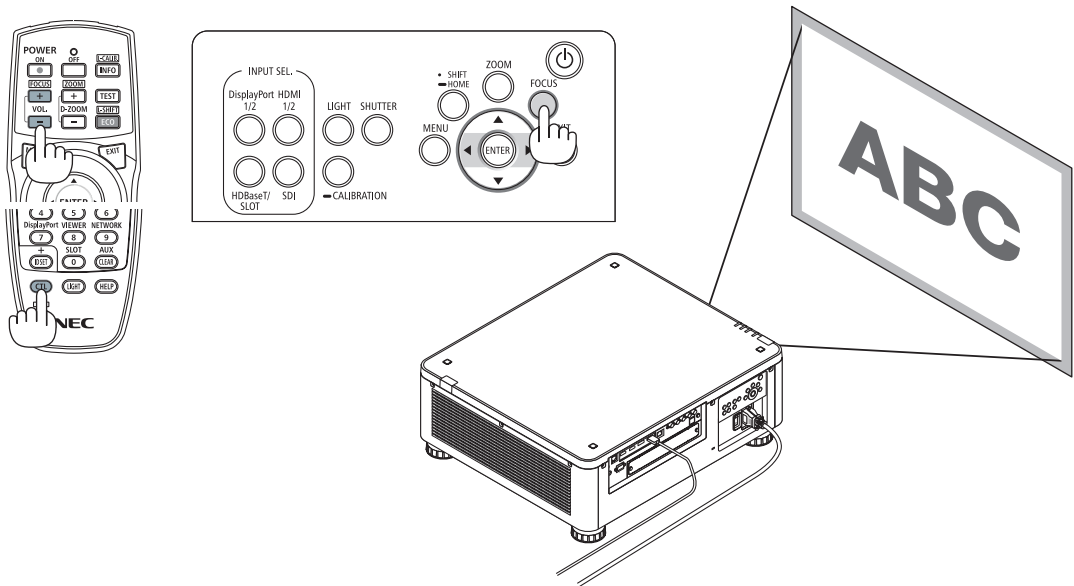

TIP:

- To obtain the best focus, perform the following (for permanent installation)

Preparation: Warm up the projector for one hour.

1. Use the FOCUS button and the ◀▶ buttons to make sure you obtain the best focus. If you do not, move the projector back and forth.
2. Select the [TEST PATTERN] from the menu and display the test pattern. (→ page 78)
 - You can also use the TEST button on the remote control to display the test pattern.
3. Press the FOCUS button to display the focus adjustment bar, then press the ◀ button until the pixel lattice of the test pattern cannot be seen any more.
 - The FOCUS adjustment bar displaying position can be shifted or be turned off temporarily. (→ page 36)
4. Keep pressing the ▶ button until you obtain the best focus.
If you adjust beyond the best focal point, go back to step 3 and repeat the procedures.

2. Projecting an Image (Basic Operation)

Applicable lens unit: NP31ZL-4K

1. Focus on the projected image around the optical axis. (Powered focus)

Press the FOCUS button to display the focus adjustment bar. Press the ◀▶ button to adjust the focus near the optical axis.



- On the remote control, while pressing on the CTL button, press on VOL/FOCUS (+) or (-) button.
- ◀ or ▶ buttons on the remote control are also available to adjust FOCUS while the FOCUS adjustment bar is displayed on.

The drawing below shows an example when the projected image is shifted upward. In this case the optical axis is at the bottom edge of the projected image.

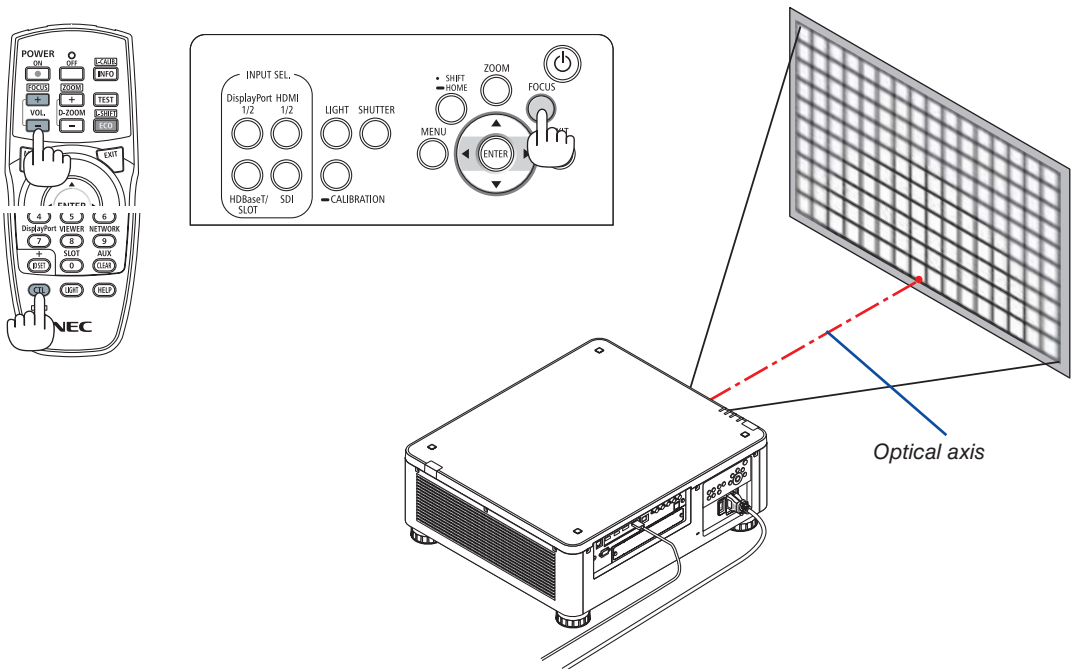

- * When the lens is at the center position, the optical axis is at the center of the image. In this case, adjust the focus at the center of the projected image.

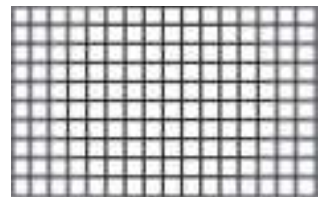

2. Projecting an Image (Basic Operation)

2. Adjust the focus at the edges of the projected image. (Manual focus)

Turn the edge focus ring clockwise or counterclockwise.

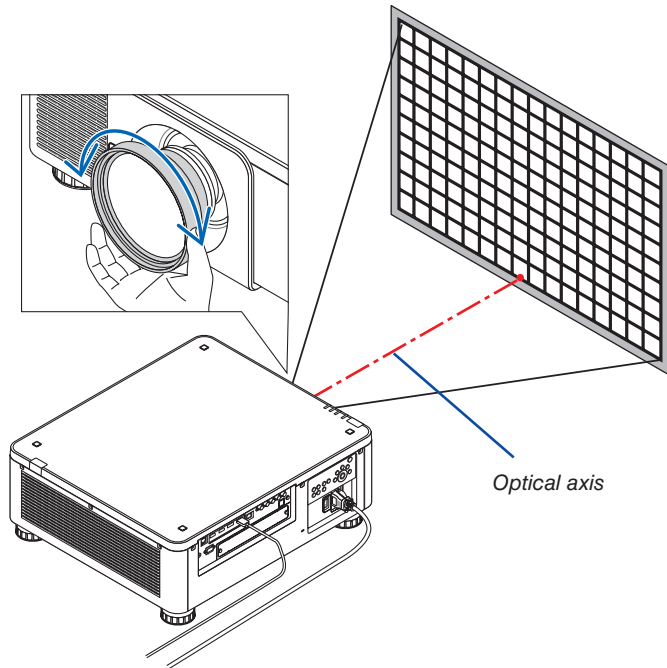

This completes adjusting the projected image's overall focus.

NOTE:

- The NP31ZL-4K supports the Lens Memory function, which allows you to store adjusted value for Lens Shift, Zoom, and Focus. If you accidentally move the Edge focus ring (drawing shown below) after having stored adjusted values, the adjusted values stored in the Lens Memory will not be correctly applied.

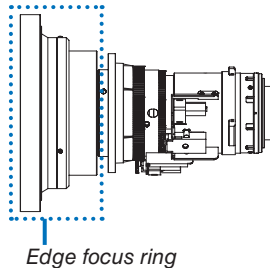

After having removed the lens from the projector and mounted it back, call up the adjusted values stored in the Lens Memory and then follow Step 2 in the procedure above to adjust the focus at the edges of the projected image again.

2. Projecting an Image (Basic Operation)

TIP:

- To obtain the best focus, perform the following (for permanent installation)

Preparation: Warm up the projector for one hour.

1. Press the FOCUS button and the ◀▶ buttons to check the adjustable focus range. For checking it by the remote control, press and hold the CTL button and press VOL./FOCUS +/- button. If the projector in use is not within the adjustable focus range, move the projector back and forth.

2. Select the [TEST PATTERN] from the menu and display the test pattern. (→ page 78)

- For displaying the test pattern by the remote control, press TEST button.

3. Press the FOCUS button to display the Focus Adjustment Bar, then press the < button until the pixel lattice of the test pattern cannot be seen any more.

- The FOCUS adjustment bar displaying position can be shifted or be turned off temporarily. (→ page 36)

4. Keep pressing the ▶ button until you obtain the best focus.

For obtaining the best focus by the remote control, press the VOL./FOCUS + button while holding to press the CTL button.

If you adjust beyond the best focal point, go back to step 3 and repeat the procedures.

5. Turn the edge focus ring clockwise or counterclockwise to adjust the focus at the edges of the projected image.

Applicable lens unit: NP39ML-4K

1. Focus on the projected image around the optical axis. (Powered focus)

Press the FOCUS button to display the focus adjustment bar. Press the ◀▶ button to adjust the focus near the optical axis.



- On the remote control, while pressing on the CTL button, press on VOL/FOCUS (+) or (-) button.
- ◀ or ▶ buttons on the remote control are also available to adjust FOCUS while the FOCUS adjustment bar is displayed on.

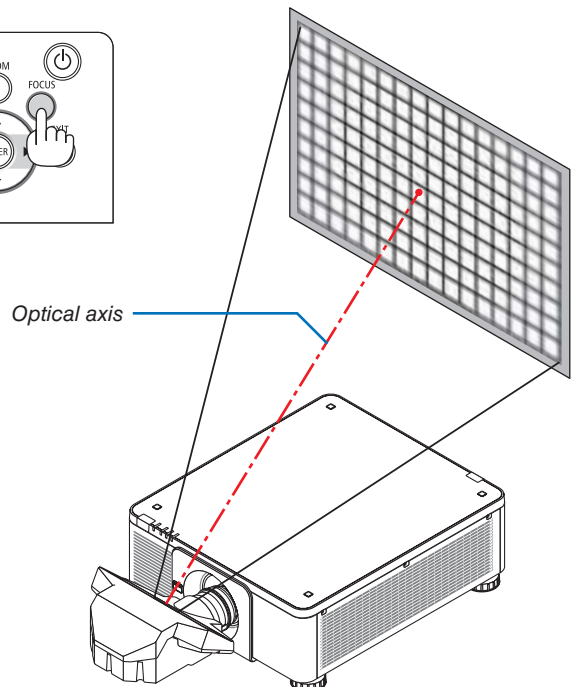
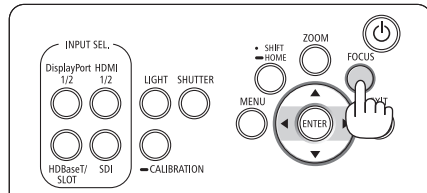
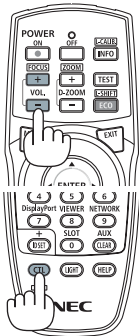

2. Projecting an Image (Basic Operation)

2. Adjust the focus at the edges of the projected image.

Press the ZOOM button to display the zoom adjustment bar. Press the ◀▶ button to adjust the focus around the screen.



Focus around the optical axis set at step 1 is remained unchanged.

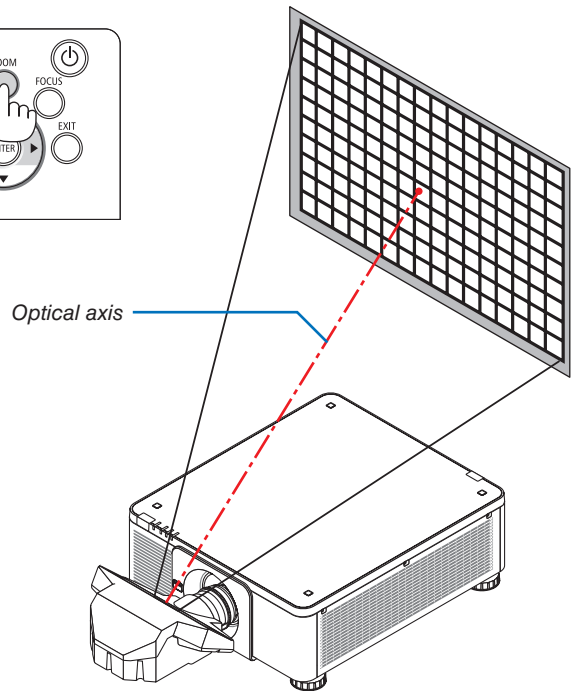
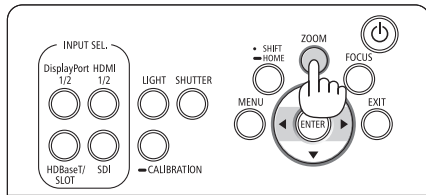
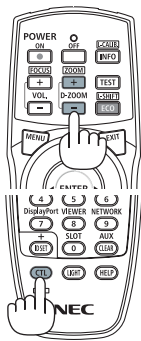

3. Repeat steps 1 and 2 until the optimal focus can be obtained on whole image.

TIP:

- To obtain the best focus, perform the following (for permanent installation)

Preparation: Warm up the projector for one hour.

- Use the FOCUS button and the ◀▶ buttons to make sure you obtain the best focus. If you do not, move the projector back and forth.
 - Select the [TEST PATTERN] from the menu and display the test pattern. (→ page 78)
 - You can also use the TEST button on the remote control to display the test pattern.
 - Press the FOCUS button to display the Focus Adjustment Bar, then press the ◀ button until the pixel lattice of the test pattern cannot be seen any more.
 - The FOCUS adjustment bar displaying position can be shifted or be turned off temporarily. (→ page 36)
 - Keep pressing the ▶ button until you obtain the best focus.

If you adjust beyond the best focal point, go back to step 3 and repeat the procedures.
 - Press the ZOOM button to display the zoom adjustment bar and press the ◀▶ button to adjust the focus around the screen.

Press the D-ZOOM/ZOOM +/- button holding to press the CTL button for adjusting it by the remote control.
- Repeat steps 1 to 5 until the optimal focus can be obtained on whole image.

Zoom

Applicable lens units: NP17ZL-4K/NP18ZL-4K/NP19ZL-4K/NP20ZL-4K/NP21ZL-4K/NP31ZL-4K

1. Press the ZOOM button.

The ZOOM adjustment bar will be displayed on.



2. Press ◀▶ buttons to adjust zoom.

- On the remote control, while pressing on the CTL button, press the D-ZOOM/ZOOM (+) or (-) button.

The zoom is adjusted.

- ◀ or ▶ buttons on the remote control are available to adjust ZOOM while the ZOOM adjustment bar is displayed on.

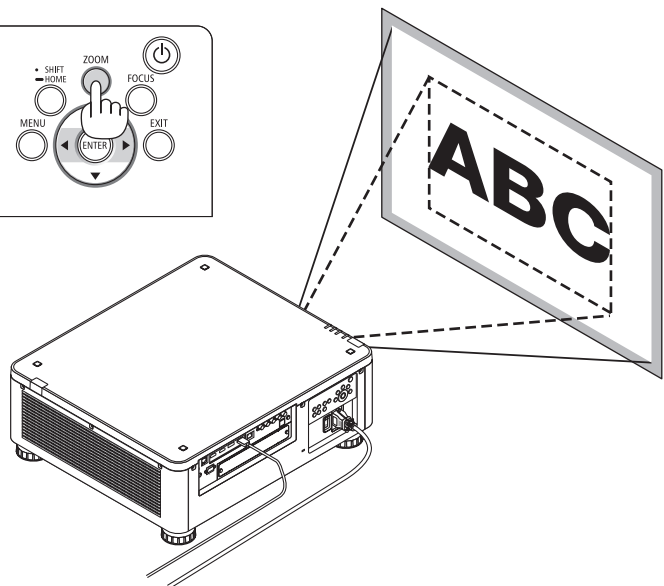
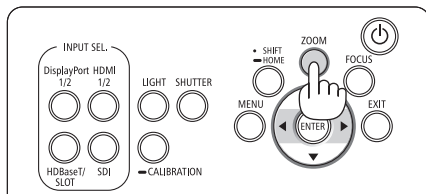
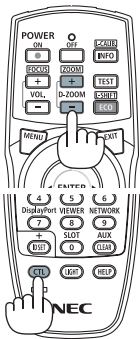

Adjusting the Tilt Foot

1. The position to project image may be adjusted by the tilt foot positioned at four corners of the cabinet bottom.

The tilt foot height can be adjusted by its turn.

“To adjust the height of the projected image”

The height of the projected image is adjusted by turning either front or rear tilt foot.

“If the projected image is tilted”

If the projected image is tilted, turn either left or right tilt foot to adjust the image so that it is level.

- If the projected image is distorted, see “3-8 Correcting Horizontal and Vertical Keystone Distortion [CORNERSTONE]” (→ page 43) and “[GEOMETRIC CORRECTION]” (→ page 94).
- The tilt foot can be lengthened by a maximum of 48 mm.
- The tilt foot can be used to tilt the projector by a maximum of 6°.

NOTE:

- Do not lengthen the tilt foot any more than 50 mm/1.9". Doing so will make the tilt feet's mount section unstable and could cause the tilt feet to come off the projector.
- Pay attention to lengthen or shorten two tilt foot at front at the same time. Same for the rear foot, otherwise, the weight of the projector is loaded on one side and it may cause of damage to it.
- Do not use the tilt foot for any purpose other than adjusting the projector's projection angle.
Handling the tilt foot improperly, such as carrying the projector by grasping the tilt foot or hooking it onto a wall using the tilt foot, could damage the projector.
- Please check level of the lens unit When the lens unit NP39ML-4K is installed on since the lens unit may slightly incline in left or right.

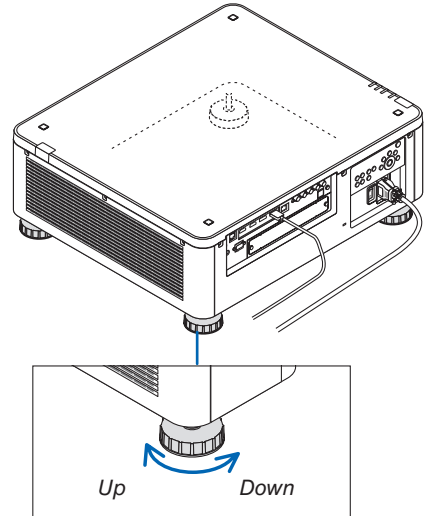
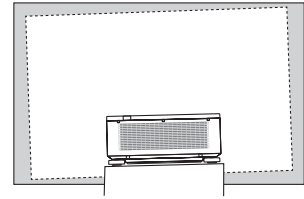

Tilt foot
(there is one more in the rear)

6 Turning off the Projector

1. Press the  (POWER) button on the projector cabinet or the POWER OFF button on the remote control.

The [POWER OFF / ARE YOU SURE ? / CARBON SAVINGS-SESSION 0.000[g-CO2]] message will appear.

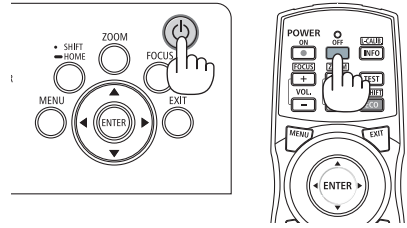

2. Press one among the ENTER, the , and the POWER OFF button.

The light source will be turned off and the power supply will be cut. The projector will go to sleep state and the POWER indicator will light in green. If no operation is performed on the projector and no signal is input to the projector, the projector will be in standby state. (In the state, the standby mode is NORMAL.)

- If you do not want to turn off, select [NO] by ◀▶ button and press ENTER.
3. Make sure the projector is in **STANDBY MODE**, then turn off the main power switch (○ OFF)

The POWER indicator will go off and the main power will turn off.

- While the POWER indicator is blinking blue in short cycles, the power cannot be turned off.

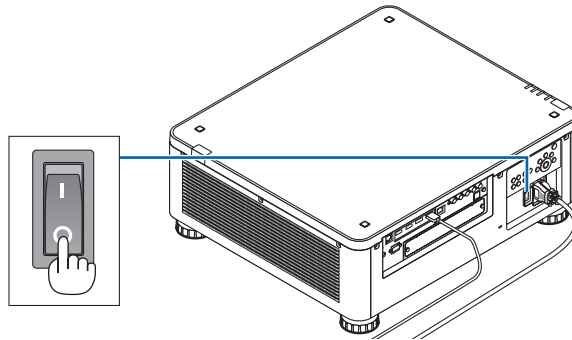
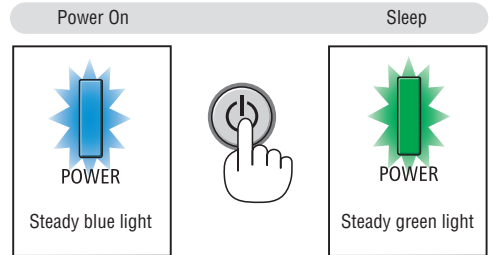

CAUTION:

Parts of the projector may temporarily overheat if the projector is turned off with the main power switch or the AC power supply is disconnected while the projector is in operation or the cooling fan is running. Handle with care.

NOTE:

- *Do not unplug the power cord from the projector or from the power outlet while an image is being projected. Doing so could deteriorate the projector's AC IN terminal or the power plug's contact. To turn off the AC power supply when the projector is powered on, use the projector's main power switch, a power strip equipped with a switch, or a breaker.*
 - *Do not turn off the main power switch or disconnect the AC power supply within 10 seconds of making adjustments or setting changes and closing the menu. Doing so can cause loss of adjustments and settings.*
-

7 After Use

Preparation: Make sure that the projector is turned off.

- 1. Unplug the power cord.**
- 2. Disconnect any other cables.**
- 3. Mount the lens cap on the lens.**
- 4. Before moving the projector, screw in the tilt foot if they have been lengthened.**

3. Convenient Features

1 Turn off the light of the projector (LENS SHUTTER)

Press the SHUTTER button.

The light source will turn off temporarily.

Press again to allow the screen to become illuminated again.

- You can set the projection light to gradually fade in or out.

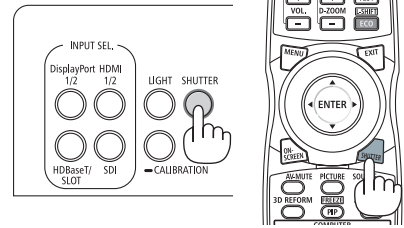

2 Turning off the Image (AV-MUTE)

Press the AV-MUTE button to turn off the image for a short period of time.

Press again to restore the image.

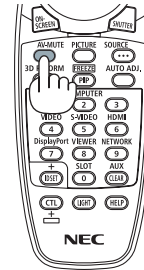

TIP:

- The video will disappear but not the menu display.

3 Turning Off the On-Screen Menu (On-Screen Mute)

A press of the ON-SCREEN button on the remote control will hide the on-screen menu, the source display and other messages. Press again to restore them.

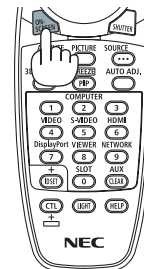

TIP:

- To confirm that the on-screen mute is turned on, press the MENU button. If the on-screen menu is not displayed even though you press the MENU button, it means the on-screen mute is turned on.
- The on-screen mute is maintained even when the projector is turned off,
- Holding down the MENU button on the projector cabinet for at least 10 seconds will turn off the on-screen mute.

④ Shift the On-Screen Menu displaying position

1. Press the **MENU** button.

The On-Screen Menu will be displayed on.

2. Move the cursor by the **▶** button to the **[SETUP]** and then press the **ENTER** button.

The cursor will move to the **[MENU(1)]**.

3. Move the cursor by the **▶** button to the **[MENU(2)]**.

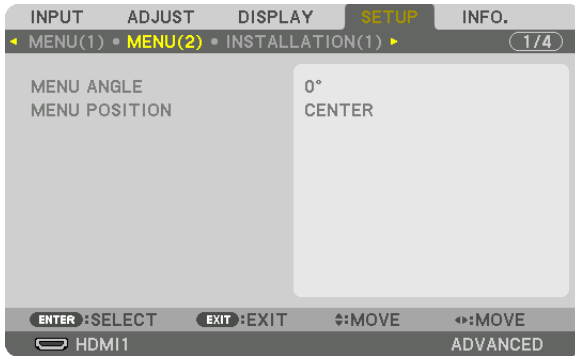

4. Move the cursor by the **▼** button to the **[MENU POSITION]** and then press the **ENTER**.

The On-Screen Menu will go into the **[MENU POSITION]** select screen.

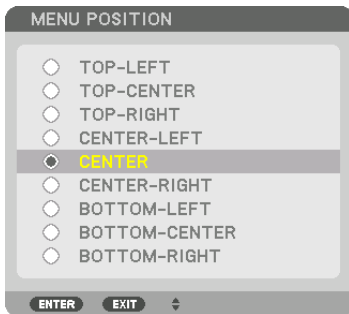

5. Press the **▼▲** button, select the menu position, and press the **ENTER** button.

For finishing the setting on the On-Screen Menu, press the **MENU** button on the remote control.

TIP:

- The display position of the menu is saved even when the power supply of the projector is turned off.
- When you change the **[MENU ANGLE]**, the display position of the menu returns to the original state when it was first shipped from the factory.
- This function does not influence to the display position of input terminal information and message.

5 Freezing a Picture

Hold the CTL button and press the PIP/FREEZE button to freeze a picture.
Press again to resume motion.

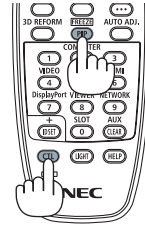

NOTE:

- *The image is frozen but the original video is still playing ahead.*
-

6 Magnifying a Picture

You can magnify the picture up to four times.

NOTE:

- Depending on an input signal, the maximum magnification may be less than four times, or the function may be restricted.

To do so:

1. Press the D-ZOOM (+) button to magnify the picture.

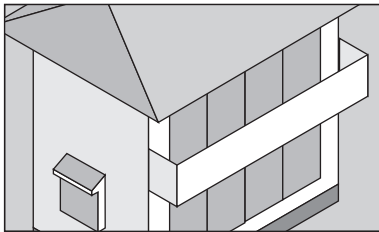
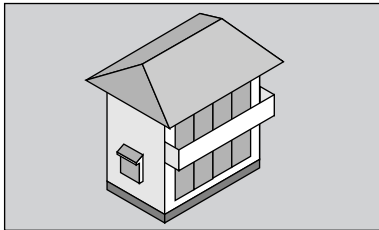

2. Press the ▲▼◀▶ button.

The area of the magnified image will be moved

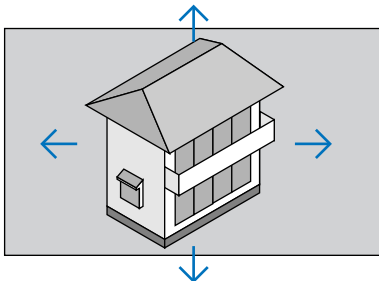

3. Press the D-ZOOM (-) button.

Each time the D-ZOOM (-) button is pressed, the image is demagnified.









NOTE:

- The image will be magnified or demagnified at the center of the screen.
- Displaying the menu will cancel the current magnification.

7 Adjustment of luminance (brightness) and energy-saving effect

You can adjust the output of the unit to a range of 20 - 100% (in increments of 1%) and control the brightness after adjustment to keep it constant. Also, set the [REF. LIGHT MODE] to ECO1 or ECO2 to reduce the brightness and operating sound. By saving energy consumption, the CO2 emission from this projector can be reduced. There are two ways to set the light mode.

Function name	Description	Page												
REF. LIGHT MODE	The adjustment values of the [REF. LIGHT MODE] and brightness are saved as a setting common to all input signals. Valid when the [MODE] (→ page 82) is set to [STANDARD].	103												
	<table border="1"> <thead> <tr> <th>REF. LIGHT MODE</th> <th>Icon at the bottom of the menu</th> <th>Description</th> </tr> </thead> <tbody> <tr> <td>NORMAL</td> <td></td> <td>100% brightness The screen will be brightly lit.</td> </tr> <tr> <td>ECO1</td> <td></td> <td>Brightness will be at about 80%. The cooling fan will also slow down accordingly. Lower power consumption</td> </tr> <tr> <td>ECO2</td> <td></td> <td>Brightness will be at about 50%. The cooling fan will also slow down accordingly. Lower power consumption considerably</td> </tr> </tbody> </table>	REF. LIGHT MODE	Icon at the bottom of the menu	Description	NORMAL		100% brightness The screen will be brightly lit.	ECO1		Brightness will be at about 80%. The cooling fan will also slow down accordingly. Lower power consumption	ECO2		Brightness will be at about 50%. The cooling fan will also slow down accordingly. Lower power consumption considerably	
REF. LIGHT MODE	Icon at the bottom of the menu	Description												
NORMAL		100% brightness The screen will be brightly lit.												
ECO1		Brightness will be at about 80%. The cooling fan will also slow down accordingly. Lower power consumption												
ECO2		Brightness will be at about 50%. The cooling fan will also slow down accordingly. Lower power consumption considerably												
LIGHT MODE	Adjust the brightness and save it for each input signal. Valid when the [MODE] (→ page 82) is set to [PROFESSIONAL].	84												

Display the LIGHT MODE screen

1. Press LIGHT button on the cabinet.

- In another way, press ECO/L-SHIFT button on the remote control.

When [STANDARD] is selected for [MODE]

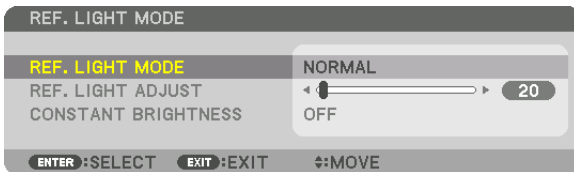

The [REF. LIGHT MODE] screen will be displayed.

When [PROFESSIONAL] is selected for [MODE]

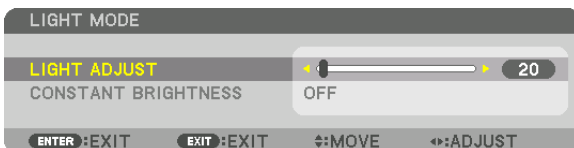

The [LIGHT MODE] screen will be displayed.

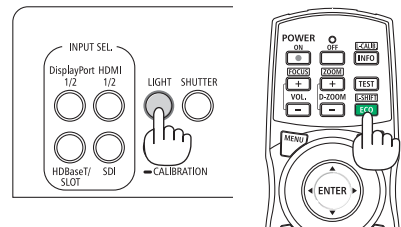

Perform LIGHT ADJUST

An explanation is given here using the [REF. LIGHT MODE] screen.

1. Press the ▼ button to adjust the cursor to [REF. LIGHT ADJUST].

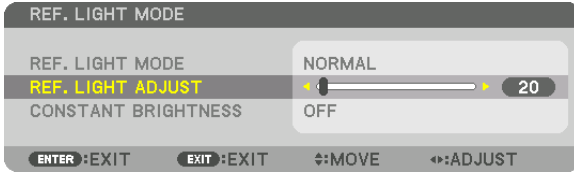

2. Press the ◀▶ button to adjust.

To keep the brightness after adjustment constant, set [CONSTANT BRIGHTNESS] to [ON].

Press the MENU button to cancel the menu screen.

TIP:

- Brightness normally decreases with use, but by selecting [CONSTANT BRIGHTNESS] mode, sensors inside the projector detect brightness and automatically adjust the output, thereby maintaining a constant brightness throughout the life of the light module. However, if output is already at its maximum, brightness will decrease with use.

Change [REF. LIGHT MODE]

1. With the cursor adjusted to [REF. LIGHT MODE], press the ENTER button.

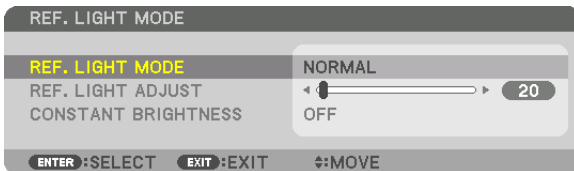

The [REF. LIGHT MODE] selection screen will be displayed.

2. Use the ▼▲ buttons to make a selection, and press the ENTER button.

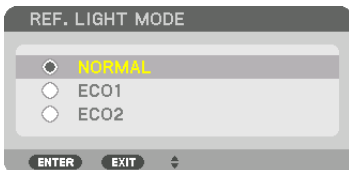

The display will return to the [REF. LIGHT MODE] screen and the selected option will be applied.



Press the MENU button to return to the original screen.

3. Convenient Features

NOTE:

- The light module hours used can be checked in [USAGE TIME] on the menu. Select [INFO.] → [USAGE TIME].
- After a lapse of 1 minute from when the projector displays a blue, black or logo screen, [REF. LIGHT MODE] will automatically switch to [ECO].
- This projector equips the sensor to detect atmospheric pressure and temperature and the projector controls the power based on the detected values. When the projector is used in high altitude and high temperature, the light source brightness becomes lower regardless of the setting for LIGHT MODE. This is called “Forced ECO MODE”. Please refer the below table for the conditions and output power in Forced ECO MODE.

Altitudes	Atmospheric temperature		
	5–30°C (41–86°F)	31–36°C (87–96°F)	37–40°C (98–104°F)
1600–3000 m (5500–10000 ft)	100%	90%	70%
600–1600 m (2000–5500 ft)	100%	90%	80%
0–600 m (0–2000 ft)	100%		80%

- When the projector is in the Forced ECO MODE, the picture brightness decreases slightly and the TEMP. indicator lights orange. At the same time the Thermometer symbol [] is displayed at the bottom of the menu. When in the Forced ECO MODE, the light mode does not change even if the LIGHT MODE setting is changed. When the atmospheric pressure sensor detects height over 600 m, the HIGH symbol [] will be displayed at the bottom of the menu.

Checking Energy-Saving Effect [CARBON METER]

This feature will show energy-saving effect in terms of CO₂ emission reduction (kg) when the projector's [LIGHT MODE] is set to either [ECO1] or [ECO2]. This feature is called as [CARBON METER].

There are two messages: [TOTAL CARBON SAVINGS] and [CARBON SAVINGS-SESSION]. The [TOTAL CARBON SAVINGS] message shows the total amount of CO₂ emission reduction from the time of shipment up to now. You can check the information on [USAGE TIME] from [INFO.] of the menu. (→ page 123)

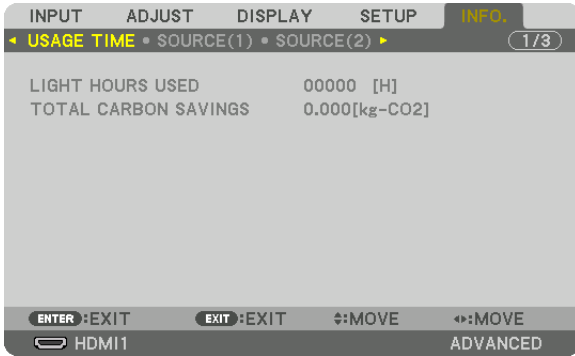

The [CARBON SAVINGS-SESSION] message shows the amount of CO₂ emission reduction between the time of changing to LIGHT MODE immediately after the time of power-on and the time of power-off. The [CARBON SAVINGS-SESSION] message will be displayed in the [POWER OFF/ ARE YOU SURE ?] message at the time of power-off.

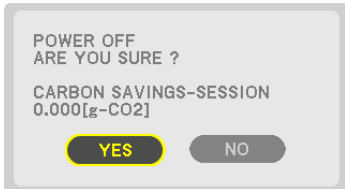

TIP:

- The formula shown below is used to calculate the amount of CO₂ emission reduction. Amount of CO₂ emission reduction = (Power consumption in [NORMAL] [REF. LIGHT MODE] – Power consumption in current setting) × CO₂ conversion factor. * When an energy-saving [LIGHT MODE] is selected, or the Lens Shutter is used, there will be a further reduction in CO₂ emission.
- * Calculation for amount of CO₂ emission reduction is based on an OECD publication “CO₂ Emissions from Fuel Combustion, 2008 Edition”.
- The [TOTAL CARBON SAVINGS] is calculated based on savings recorded in 15 minutes intervals.
- This formula will not apply to the power consumption which is not affected by whether [REF. LIGHT MODE] is turned on or off.

⑧ Correcting Horizontal and Vertical Keystone Distortion [CORNERSTONE]

Use the [CORNERSTONE] feature to correct keystone (trapezoidal) distortion to make the top or bottom and the left or right side of the screen longer or shorter so that the projected image is rectangular.

1. Project an image so that the screen is smaller than the area of the raster.

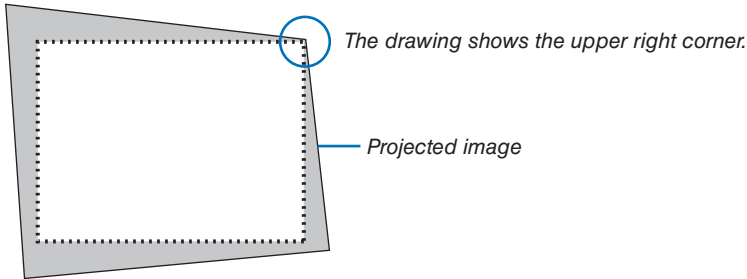

2. Pick up any one of the corners and align the corner of the image with a corner of the screen.

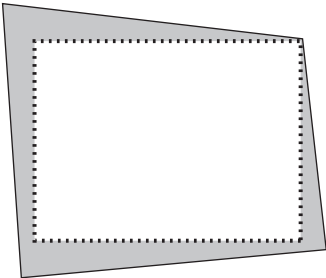

3. Press the 3D REFORM button.

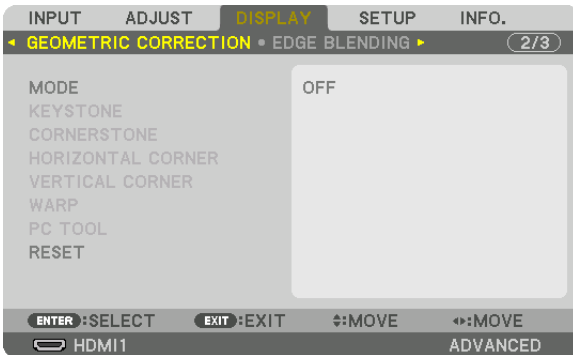

Display the [GEOMETRIC CORRECTION] screen of the on-screen menu.

4. Move the cursor onto [MODE] by ▼ button and press the ENTER.

The mode selection screen will displayed on.

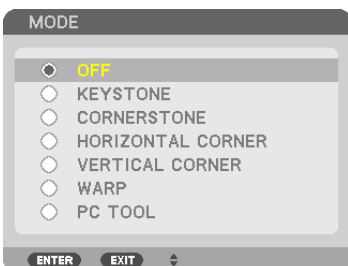

5. Press the **▼** button to align with the [CORNERSTONE] and then press the ENTER button.



The drawing shows the upper left icon (▼) is selected.

The screen will switch to the [CORNERSTONE] screen.

6. Use the **▲▼◀▶** button to select one icon (▲) which points in the direction you wish to move the projected image frame.
7. Press the ENTER button.
8. Use the **▲▼◀▶** button to move the projected image frame as shown on the example.

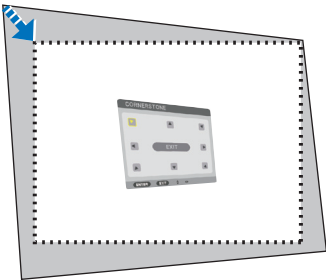

9. Press the ENTER button.
10. Use the **▲▼◀▶** button to select another icon which points in the direction.

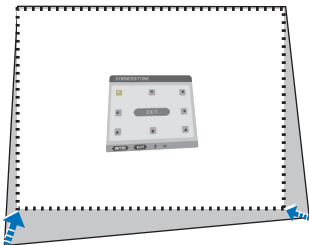

11. Repeat steps from 7 to 10 to complete the cornerstone adjustment.
12. On the [CORNERSTONE] screen, select [EXIT] or press the EXIT button on the remote control.

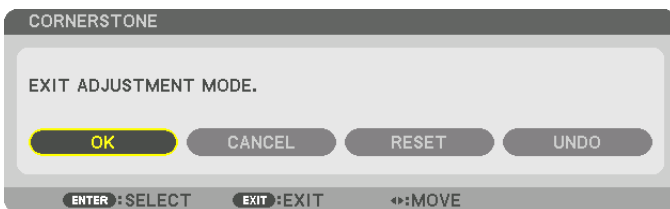

The confirmation screen is displayed.

13. Press the **◀** or **▶** button to highlight the [OK] and press the ENTER button.

This completes the [CORNERSTONE] correction.

- Returning to the [CORNERSTONE] screen, select [CANCEL] and press the ENTER button.

NOTE:

- *Even if the installation angle is changed when the projector is turned on again, the correction values in the previous time has been maintained.*
 - *Carry out either one of the following actions to clear the adjustment value of [CORNERSTONE].*
 - *In Step 12, select [RESET] and then press the ENTER button.*
 - *In the state [CORNERSTONE] has been selected for [MODE] in the [GEOMETRIC CORRECTION]:*
 - *Press the 3D REFORM button for 2 or more seconds.*
 - *Run [GEOMETRIC CORRECTION] → [RESET] in the on-screen menu.*
 - *Using CORNERSTONE correction can cause the image to be slightly blurred because the correction is made electronically.*
-

9 Preventing the Unauthorized Use of the Projector [SECURITY]

A keyword can be set for your projector using the Menu to avoid operation by an unauthorized user. When a keyword is set, turning on the projector will display the Keyword input screen. Unless the correct keyword is entered, the projector cannot project an image.

- The [SECURITY] setting cannot be cancelled by using the [RESET] of the menu.

To enable the Security function:

1. Press the **MENU** button.

The menu will be displayed.

2. Press the **▶** button twice to select [SETUP] and press the **▼** button or the **ENTER** button to select [MENU(1)].



3. Press the **▶** button to select [CONTROL].

4. Press the **▼** button three times to select [SECURITY] and press the **ENTER** button.

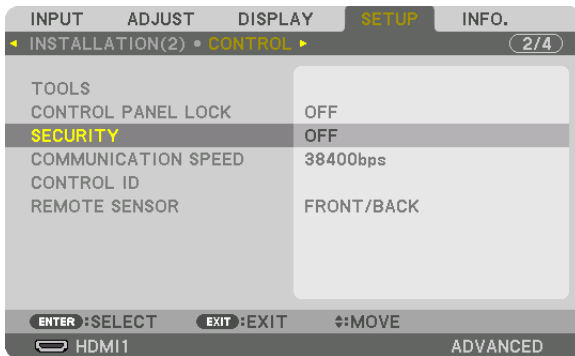

The OFF/ON menu will be displayed.

5. Press the **▼** button to select [ON] and press the **ENTER** button.



The [SECURITY KEYWORD] screen will be displayed.

6. Type your keyword in a combination of the four **▲▼◀▶** buttons and press the **ENTER** button.

NOTE:

- A keyword must be 4 to 10 digits in length.

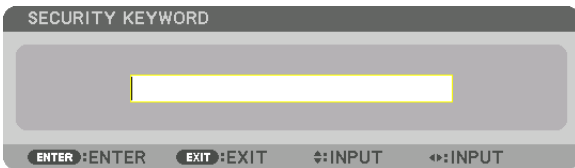

The [CONFIRM KEYWORD] screen will be displayed.

NOTE:

- Make a note of your password and store it in a safe place.

7. Type your keyword in the same combination of ▲▼◀▶ buttons and press the ENTER button.

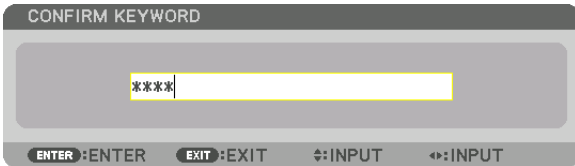

The confirmation screen will be displayed.

8. Select [YES] and press the ENTER button.



The SECURITY function has been enabled.

To turn on the projector when [SECURITY] is enabled:

1. Press the  button.

- If using the remote control, press the POWER ON button.

The projector will be turned on and display a message to the effect that the projector is locked.

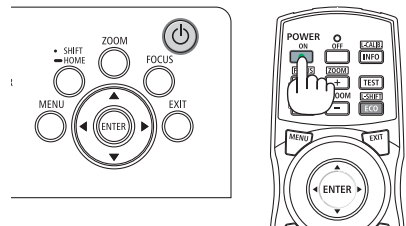

2. Press the MENU button.

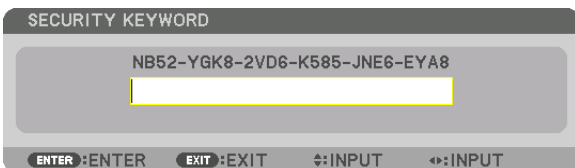

3. Type in the correct keyword and press the ENTER button. The projector will display an image.

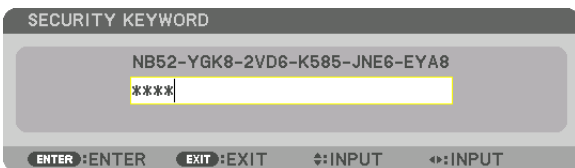

NOTE:

- The security disable mode is maintained until the main power is turned off or unplugging the power cord.

To disable the SECURITY function:

1. Press the MENU button.

The menu will be displayed.

2. Select [SETUP] → [CONTROL] → [SECURITY] and press the ENTER button.

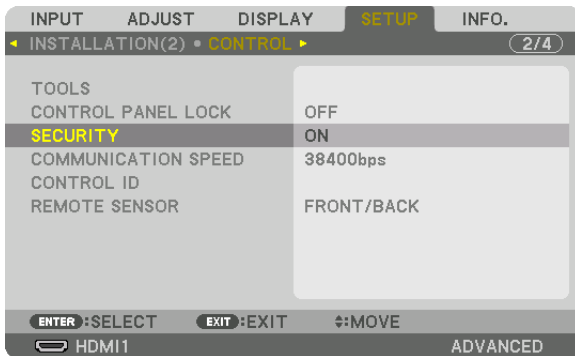

The OFF/ON menu will be displayed.

3. Select [OFF] and press the ENTER button.

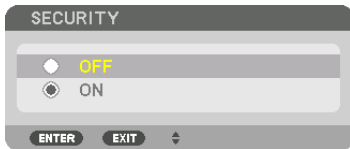

The SECURITY KEYWORD screen will be displayed.

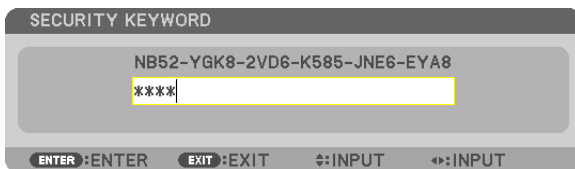

4. Type in your keyword and press the ENTER button.

When the correct keyword is entered, the SECURITY function will be disabled.

NOTE:

- If you forget your keyword, contact your dealer. Your dealer will provide you with your keyword in exchange for your request code. Your request code is displayed in the Keyword Confirmation screen. In this example [NB52-YGK8-2VD6-K585-JNE6-EYA8] is a request code.
-

10 Controlling the Projector by Using an HTTP Browser

Overview

Using the web browser on the computer, the HTTP server screen of the projector can be displayed to operate the projector.

Possible operations on the HTTP server screen

- Configure the settings required for connecting the projector to the network (wired LAN). (NETWORK SETTINGS)
- Configure the email notification. (ALERT MAIL)
When the projector is connected to a network (wired LAN), notifications on various errors are sent to the email address that has been set up.
- Operate the projector.
Operations such power on/off of the projector, input terminal switchover, picture control, and lens control etc. can be carried out.
- Configure the [PJLink PASSWORD], [AMX BEACON], and [CRESTRON] etc.

To view the HTTP server screen

1. **Connect the projector to the computer with a LAN cable sold commercially. (→ page 9)**
2. **Select [SETUP] → [NETWORK SETTINGS] → [WIRED LAN] in the on-screen menu to configure the network settings. (→ page 114)**
3. **Start up the web browser on your computer and enter the address or URL in the input field.**
Specify the address or URL as “http://<IP Address of Projector>/index.html”.
The basic HTTP server screen will be displayed.

TIP:

- The factory setting IP address is [DHCP ON].

NOTE:

- To use the projector in a network, consult with your network administrator about network settings.
 - The display's or button's response can be slowed down or operation may not be accepted depending the settings of your network. Should this happen, consult your network administrator. The projector may not respond if its buttons are repeatedly pressed in rapid intervals. Should this happen, wait a moment and repeat. If you still can't get any response, turn off and back on the projector.
 - If the PROJECTOR NETWORK SETTINGS screen does not appear in the web browser, press the Ctrl+F5 keys to refresh your web browser (or clear the cache).
 - This projector uses “JavaScript” and “Cookies” and the browser should be set to accept these functions. The setting method will vary depending on the version of browser. Please refer to the help files and the other information provided in your software.
-

Preparation before Use

Connect the projector to a commercially available LAN cable before engaging in browser operations. (→ page 9)
Operation with a browser that uses a proxy server may not be possible depending on the type of proxy server and the setting method. Although the type of proxy server will be a factor, it is possible that items that have actually been set will not be displayed depending on the effectiveness of the cache, and the contents set from the browser may not be reflected in operation. It is recommended that a proxy server not be used unless it is unavoidable.

Handling of the Address for Operation via a Browser

Regarding the actual address that is entered for the address or entered to the URL column when operation of the projector is via a browser, the host name can be used as it is when the host name corresponding to the IP address of the projector has been registered to the domain name server by a network administrator, or the host name corresponding to the IP address of the projector has been set in the “HOSTS” file of the computer being used.

Example 1: When the host name of the projector has been set to “pj.nec.co.jp”, access is gained to the network setting by specifying
http://pj.nec.co.jp/index.html
for the address or the entry column of the URL.

Example 2: When the IP address of the projector is “192.168.73.1”, access is gained to the network setting by specifying
http://192.168.73.1/index.html
for the address or the entry column of the URL.

PROJECTOR ADJUSTMENT

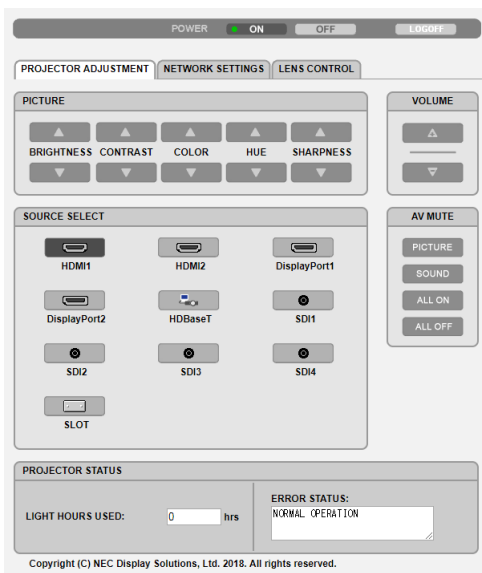

POWER: This controls the power of the projector.

ON Power is switched on.

OFF Power is switched off.

VOLUME: Not available on this series of projectors.

AV-MUTE: This controls the mute function of the projector.

PICTURE ON Mutes the video.

PICTURE OFF Cancels the video muting.

SOUND ON Not available on this series of projectors.

SOUND OFF Not available on this series of projectors.

ALL ON Mutes the video functions.

ALL OFF Cancels the muting of the video functions.

PICTURE: Controls the video adjustment of the projector.

BRIGHTNESS ▲..... Increases the brightness adjustment value.

BRIGHTNESS ▼..... Decreases the brightness adjustment value.

CONTRAST ▲..... Increases the contrast adjustment value.

CONTRAST ▼..... Decreases the contrast adjustment value.

COLOR ▲..... Increases the color adjustment value.

COLOR ▼..... Decreases the color adjustment value.

HUE ▲..... Increases the hue adjustment value.

HUE ▼..... Decreases the hue adjustment value.

SHARPNESS ▲..... Increases the sharpness adjustment value.

SHARPNESS ▼..... Decreases the sharpness adjustment value.

SOURCE SELECT: This switches the input connector of the projector.

HDMI1 Switches to the HDMI 1 IN terminal.

HDMI2 Switches to the HDMI 2 IN terminal.

DisplayPort1 Switches to the DisplayPort1 IN terminal.

DisplayPort2 Switches to the DisplayPort2 IN terminal.

HDBaseT..... Switch to image input sent from a transmission device that supports HDBaseT.

SDI1 Switches to the SDI1 IN terminal.

SDI2 Switches to the SDI2 IN terminal.

SDI3 Switches to the SDI3 IN terminal.

SDI4 Switches to the SDI4 IN terminal.

SLOT..... The projector switches to video input from the optional board when an optional board (sold separately) is equipped on.

PROJECTOR STATUS: This displays the condition of the projector.

LIGHT HOURS USED Displays how many hours the light module has been used.

ERROR STATUS..... Displays the status of errors occurring within the projector.

LOG OFF: Logging off your projector and returning to the authentication screen (LOGON screen).

NETWORK SETTINGS

http://<IP Address of Projector (Basic)>/index.html

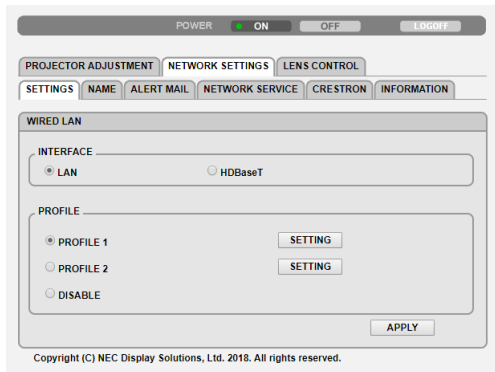

• SETTINGS

WIRED LAN

INTERFACE	Select [LAN] for connecting LAN by wire thru the LAN port. Select [HDBaseT] for connecting LAN by wire thru the HDBaseT IN/Ethernet port.
SETTING	Set for wired LAN.
PROFILE 1/PROFILE 2	Two settings can be set for wired LAN connection. Select PROFILE 1 or PROFILE 2.
DISABLE	Turn off wired LAN connection. The POWER indicator that is informing the STANDBY state will start to blink in orange long interval (→ page 154).
DHCP ON	Automatically assign IP address, subnet mask, and gateway to the projector from your DHCP server.
DHCP OFF	Set IP address, subnet mask, and gateway to the projector assigned by your network administrator.
IP ADDRESS	Set your IP address of the network connected to the projector.
SUBNET MASK	Set your subnet mask number of the network connected to the projector.
GATEWAY	Set the default gateway of the network connected to the projector.
AUTO DNS ON	DHCP server will automatically assign IP address of DNS server connected to the projector.
AUTO DNS OFF	Set your IP address assigned by your network administrator.
DNS	Set your IP address of DNS server connected to the projector.
SAVE	Click this button to save your settings to the projector's memory.
APPLY	Apply your settings to wired LAN.

• NAME

PROJECTOR NAME	Enter a name for your projector so that your computer can identify the projector. A projector name must be 16 characters or less. TIP: Projector name will not be affected even when [RESET] is done from the menu.
HOST NAME	Enter the hostname of the network connected to the projector. A host name must be 16 or less.
DOMAIN NAME	Enter the domain name of the network connected to the projector. A domain name must be 60 characters or less.
SAVE	Click this button to save your settings to the projector's memory.

• ALERT MAIL

ALERT MAIL	This option will notify various errors to your computer via e-mail when using wired LAN. Placing a checkmark will turn on the Alert Mail feature. Clearing a checkmark will turn off the Alert Mail feature. Sample of a message to be sent from the projector: Subject: [Projector] Projector Information THE COOLING FAN HAS STOPPED. [INFORMATION] PROJECTOR NAME: xxxxx LIGHT HOURS USED: xxxx[H]
SENDER'S ADDRESS	Enter sender's address.
SMTP SERVER NAME	Enter the SMTP server name to be connected to the projector.
RECIPIENT'S ADDRESS 1, 2, 3	Enter your recipient's address. Up to three addresses can be entered.
TEST MAIL	Send a test mail to check whether your settings are correct or not <i>NOTE:</i> <ul style="list-style-type: none"> • If you execute a test, you may not receive an Alert mail. Should this happen, check if network settings are correct. • If you entered an incorrect address in a test, you may not receive an Alert mail. Should this happen, check if the Recipient's Address is correct.
SAVE	Click this button to save your settings to the projector's memory.

• NETWORK SERVICE

PJLink PASSWORD	Set a password for PJLink*. A password must be 32 characters or less. Do not forget your password. However, if you forget your password, consult with your dealer.
HTTP PASSWORD	Set a password for HTTP server. A password must be 10 characters or less. When a password is set up, you will be prompted for your user name (arbitrary) and password during LOGON.
AMX BEACON	Turn on or off for detection from AMX Device Discovery when connecting to the network supported by AMX's NetLinX control system. <i>TIP:</i> <i>When using a device that supports AMX Device Discovery, all AMX NetLinX control system will recognize the device and download the appropriate Device Discovery Module from an AMX server. Placing a checkmark will enable detecting the projector from AMX Device Discovery. Clearing a checkmark will disable detecting the projector from AMX Device Discovery.</i>
Extron XTP	Set for connecting this projector to the Extron XTP transmitter. Placing a checkmark will enable to connect with the XTP transmitter. Clearing a checkmark will disable to connect with the XTP transmitter.
SAVE	Click this button to save your settings to the projector's memory.

NOTE:

- If you forget your password, contact your dealer. Please check 24 digits serial number (XXXX-XXXX-XXXX-XXXX-XXXX-XXXX) displayed on the column for the password.

***What is PJLink?**

PJLink is a standardization of protocol used for controlling projectors of different manufacturers. This standard protocol is established by Japan Business Machine and Information System Industries Association (JBMIA) in 2005. The projector supports all the commands of PJLink Class 1. Setting of PJLink will not be affected even when [RESET] is done from the menu.

• CRESTRON

ROOMVIEW for managing from the computer.

DISABLE	Disables ROOMVIEW.
ENABLE	Enables ROOMVIEW.

CRESTRON CONTROL for managing from the controller.

DISABLE	Disables CRESTRON CONTROL.
ENABLE	Enables CRESTRON CONTROL.
IP ADDRESS	Set your IP address of CRESTRON SERVER.
IP ID	Set your IP ID of CRESTRON SERVER.
SAVE	Click this button to save your settings to the projector's memory.

TIP:

- The CRESTRON settings are required only for use with CRESTRON ROOMVIEW. For more information, visit <http://www.crestron.com>

• INFORMATION

WIRED LAN	Display a list of settings of wired LAN connection.
UPDATE	Reflect settings when they are changed.

LENS CONTROL



• CONTROL

FOCUS	◀▶	Adjust FOCUS of the projected image.
ZOOM	◀▶	Finely adjusting the size of an image.
SHIFT	▼▲◀▶	Adjust the projected image's vertical and horizontal position.
	HOME	Return the lens shift position to the home position.
SHUTTER		Turn off the light source temporarily.
⊘ SHUTTER		Turn on the light source.
CALIB.		Correct the adjustable zoom, focus and lens shift range.

• LENS MEMORY

STORE	Store the current adjusted values in memory for each input signal.
MOVE	Applies the adjusted values of LENS SHIFT, ZOOM, and FOCUS to the current signal.
RESET	Return the adjusted values to the last condition.

• REF. LENS MEMORY

PROFILE1/PROFILE2	Select a stored [PROFILE] number.
STORE	Store each adjusted value of LENS SHIFT, ZOOM and FOCUS for the selected profile as the common values for every input signal.
MOVE	Move the lens to the stored values of LENS SHIFT, ZOOM, and FOCUS for the selected profile.

3. Convenient Features

RESET		Reset selected [REF. LENS MEMORY] for the selected [PROFILE] to the default factory settings.
LOAD BY SIGNAL	OFF	If input signal is switched, the lens will not shift to the lens shift, zoom and focus values for the selected [PROFILE] number.
	ON	If input signal is switched, the lens will shift to the lens shift, zoom and focus values for the selected [PROFILE] number. If no adjusted values have been stored to [LENS MEMORY], the lens will apply [REF. LENS MEMORY] adjusted values. Alternatively, if no adjusted values have been stored to [REF. LENS MEMORY], the unit will return to the default factory settings.
FORCED MUTE	OFF	Not turn off the image during lens shift.
	ON	Turn off the image during lens shift.

• SHUTTER SETTINGS

POWER ON SHUTTER	OPEN	When the power is turned on, the light source turns on and the picture is projected.
	CLOSE	When the power is turned on, the light source does not turn on.
PICTURE MUTE SHUTTER	OPEN	The light source remains on when the picture is turned off for switching the input terminals.
	CLOSE	The light source turns off when the picture is turned off for switching the input terminals.
FADE IN TIME		Set how long the light will take to fade in after pressing the SHUTTER button.
FADE OUT TIME		Set how long the light will take to fade out after pressing the SHUTTER button.

① Storing Changes for Lens Shift, Zoom, and Focus [LENS MEMORY]

The adjusted values can be stored in projector memory when using the LENS SHIFT, ZOOM and FOCUS buttons of the projector. Adjusted values can be applied to the signal you selected. This will eliminate the need to adjust lens shift, focus, and zoom at the time of source selection. There are two ways to save adjusted values for lens shift, zoom, and focus.

Function name	Description	page
REF. LENS MEMORY	Adjusted values common to all input signals. At the time of installation, two kinds of adjusted values can be stored. If no adjusted values are stored in [LENS MEMORY], adjusted values from the selected profile ([REF. LENS MEMORY]) will be applied for lens adjustment.	→ page 105
LENS MEMORY	Adjusted values for each input signal. Use the adjusted values for the signal with a different aspect ratio or resolution. The adjusted values can be applied at the time of source selection.	→ page 92

NOTE:

- For using the lens unit NP16FL-4K, NP17ZL-4K, NP18ZL-4K, NP19ZL-4K, NP20ZL-4K, NP21ZL-4K, and NP31ZL-4K, be sure to carry out [LENS CALIBRATION] after replacing the lens unit. (→ page [17](#), [105](#))
- For the lens unit, NP16FL-4K, the storable value as [LENS MEMORY] feature is for [FOCUS] only.
- The [LENS MEMORY] feature is not available for the lens unit, NP39ML-4K.

To store your adjusted values in [REF. LENS MEMORY]:

1. Press the **MENU** button.



The menu will be displayed.

2. Press the **▶** button to select [SETUP] and press the **ENTER** button.

3. Press the **▶** button to select [INSTALLATION(2)].



4. Press the **▼** button to select [REF. LENS MEMORY] and press the **ENTER** button.

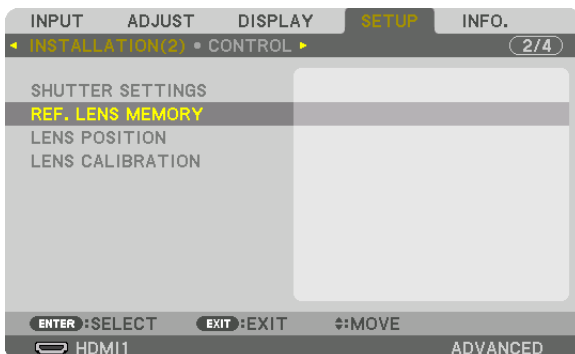

The [REF. LENS MEMORY] screen will be displayed.

5. Make sure [PROFILE] is highlighted, then press the ENTER button.

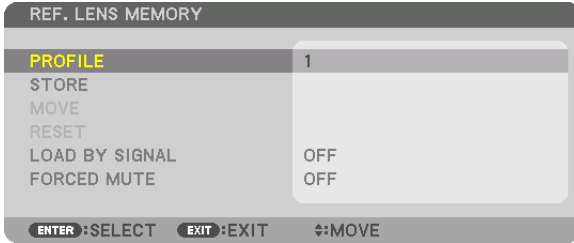

The [PROFILE] selection screen appears.

6. Press the ▼/▲ buttons to select the [PROFILE] number, then press the ENTER button.



Return to the [REF. LENS MEMORY] settings screen.

7. Select [STORE] and press the ENTER button.



The confirmation screen will be displayed.

8. Press the ◀ button to select and [YES] and press the ENTER button.

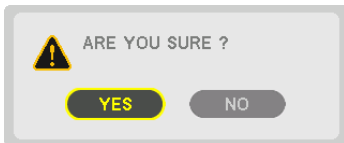

Select a [PROFILE] number and save the adjusted [LENS SHIFT], [ZOOM], and [FOCUS] values to it.

- To turn off the image during the lens shift, set [FORCED MUTE] to [ON]. (→ page 105)

9. Press the MENU button.

The menu will be closed.

TIP:

- To store adjusted values for each input source, use the Lens Memory function. (→ page 92)

To call up your adjusted values from [REF. LENS MEMORY]:

1. Press the **MENU** button.



The menu will be displayed.

2. Press the **▶** button to select [SETUP] and press the **ENTER** button.

3. Press the **▶** button to select [INSTALLATION(2)].

4. Press the **▼** button to select [REF. LENS MEMORY] and press the **ENTER** button.

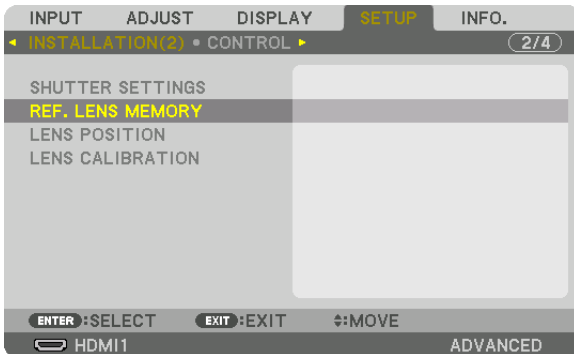

The [REF. LENS MEMORY] screen will be displayed.

5. Make sure [PROFILE] is highlighted, then press the **ENTER** button.

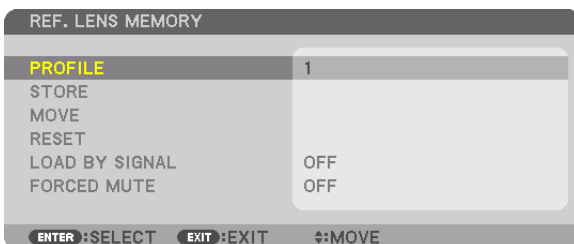

The [PROFILE] selection screen appears.

6. Press the **▼/▲** buttons to select the [PROFILE] number, then press the **ENTER** button.



Return to the [REF. LENS MEMORY] settings screen.

7. Select [MOVE] and press the ENTER button.

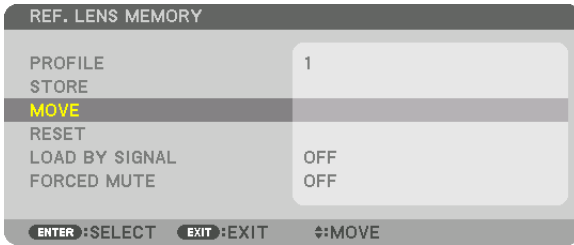

The lens will shift based on the adjusted values stored in the selected [PROFILE].

8. Press the ◀ button to select and [YES] and press the ENTER button.

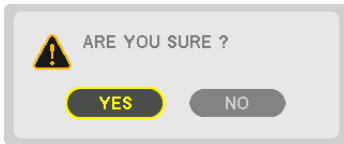

The adjusted values will be applied to the current signal. .

9. Press the MENU button.

The menu will be closed.

- TIP:**
- To call up the stored values from [LENS MEMORY]:
 - From the menu, select [ADJUST] → [LENS MEMORY] → [MOVE] and press the ENTER button.



The confirmation screen will be displayed.

- Press the ◀ button to select and [YES] and press the ENTER button.

During projection, if the adjusted values for an input signal have been saved, the lens will shift. If not, the lens will shift according to the adjusted values stored in the selected [REF. LENS MEMORY] [PROFILE] number.

- To automatically apply the stored values at the time of source selection:
 - From the menu, select [SETUP] → [REF. LENS MEMORY] → [LOAD BY SIGNAL] and press the ENTER button.



- Press the ▼ button to select and [ON] and press the ENTER button.

This will move the lens automatically to the position at the time of source selection according to the adjusted values.

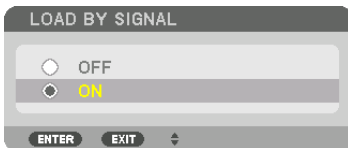

-
- NOTE:**
- The Lens Memory function may not produce a completely aligned image (due to tolerances in the lenses) using the adjusted values stored in the projector. After calling up and applying the stored values from the Lens Memory function, finely adjust the lens shift, zoom and focus to produce the best possible image.
-

4. Multi-Screen Projection

A high resolution video can be projected on an even bigger screen by combining multiple projectors on the left, right, top and bottom.

This projector is equipped with an “EDGE BLENDING Function” that makes the edges (boundaries) of the projection screen indistinguishable.

NOTE:

- For projector throw distances, refer to “Throw distance and screen size” on page 137.
- Before performing the Edge Blending function, place the projector in the correct position so that the image becomes square in the appropriate size, and then make optical adjustments (lens shift, focus, and zoom).
- Adjust the brightness of each projector using [REF. LIGHT ADJUST] under [REF. LIGHT MODE]. After adjusting the brightness, you can keep the set brightness level by turning ON the [CONSTANT BRIGHTNESS] mode. Also, set the colors of the various projectors to match using [REF. WHITE BALANCE].

Before explaining use of the Edge Blending function

This section explains the case for “Example: Placing two projectors side by side”. As shown, the projected image on the left is referred to as “Projector A” and the projected image on the right is referred to as “Projector B”. Unless otherwise specified hereinafter, the “projector” is used to mean both A and B.

Example: Placing two projectors side by side

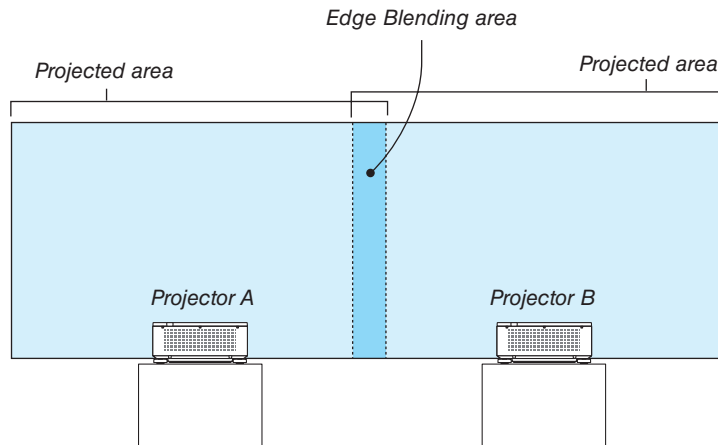

Things to note when installing projectors

- Leave 30 cm or over space between each projectors and between the intake vent and the wall for installing projectors side by side, so that air intake of the projectors are not obstructed. When the air intake and discharge outlet are obstructed, the temperature inside the projector will rise and this may result in a malfunction.

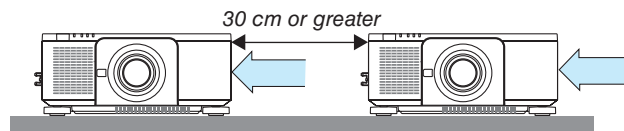

- Two projectors can be stacked on top of each other (STACK setting). (→ page 133) Do not attempt to directly stack three or more projectors. When the projectors are piled up on top of one another, they may fall down, resulting in damage and failure.

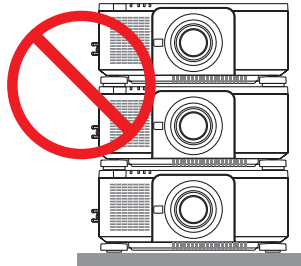

- Installation example when using 3 or more projectors
The following installation is recommended when installing a combination of 3 or more projectors for multi-screen projection.
[Installation example]

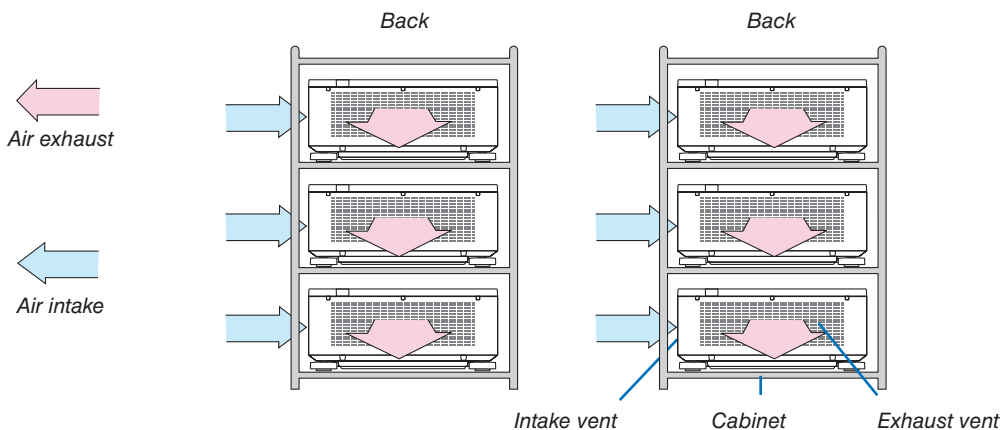

WARNING

Please request the dealer for special installation services such as when mounting the projector to the ceiling. Never carry out the installation by yourself. The projector may fall down and result in injury. Please use a sturdy cabinet that can withstand the weight of the projector for the installation. Please do not pile up the projectors directly on top of one another.

NOTE:

- For the range of the projection distance, please refer to the Appendix "Throw distance and screen size". (→ page 137)

Preparation:

- Turn on the projector and display a signal.
- When performing settings or adjustments using one remote control, enable the [CONTROL ID] for assigning ID to each projector so as not to activate the other projectors. (→ page 111)

Setting the overlap of projection screens

① Enable [EDGE BLENDING].

1. Press the MENU button.

The menu will be displayed.

2. Select [DISPLAY] → [EDGE BLENDING].

The [EDGE BLENDING] screen will be displayed. Align the cursor with [MODE] and then press the ENTER button. The mode screen will be displayed.

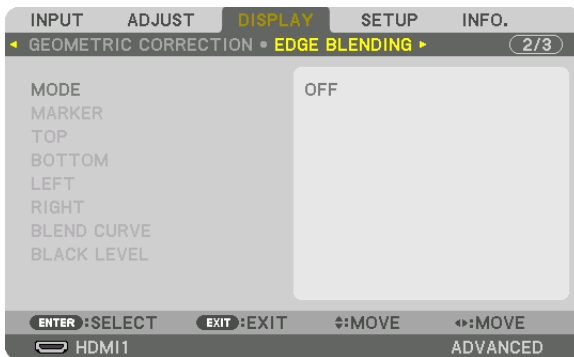

3. Select [MODE] → [ON] and press the ENTER button.

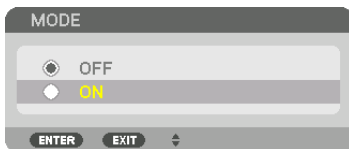

This enables the Edge Blending function. The following menu items are available: [MARKER], [TOP], [BOTTOM], [LEFT], [RIGHT], [BLEND CURVE], and [BLACK LEVEL]

4. Select [RIGHT] for Projector A and [LEFT] for Projector B.

Press the ENTER button.

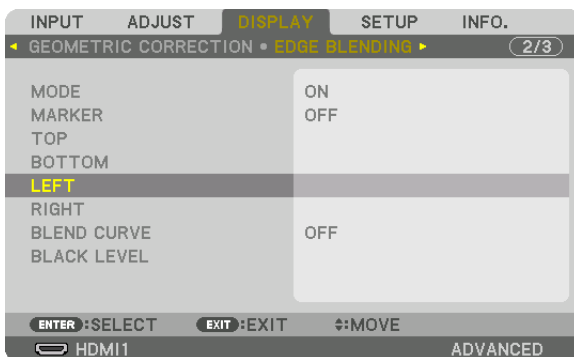

The following items are available:
[CONTROL], [RANGE], and [POSITION]

5. Select [CONTROL] → [ON] and press the ENTER button.

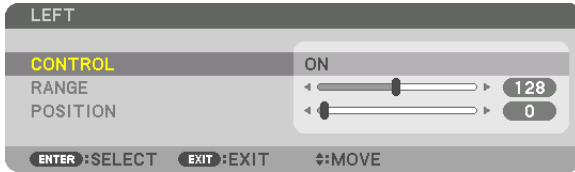

Each [TOP], [BOTTOM], [LEFT], [RIGHT], and [BLACK LEVEL] has its own [CONTROL], [RANGE], and [POSITION].

- For Projector A, set the [CONTROL] for the [TOP], [LEFT] and [BOTTOM] to [OFF]. Similarly for Projector B, set the [CONTROL] for the [TOP], [RIGHT] and [BOTTOM] to [OFF].

② Adjust [RANGE] and [POSITION] to determine an area of overlapped edges of images projected from each projector.

Turning on [MARKER] will display markers in magenta and green.

The magenta marker is used for [RANGE] and green one for [POSITION].

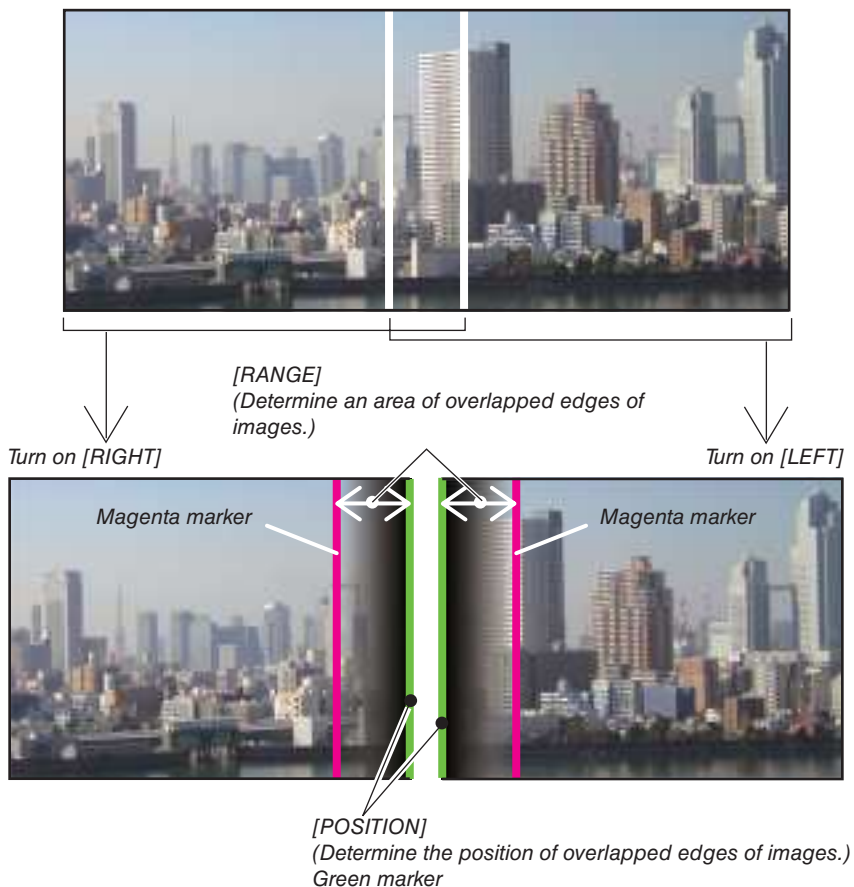

* The 2 screens are separated in the diagram for explanatory purposes.

1 Adjust [RANGE].

Use the ◀ or ▶ button to adjust the overlapped area.

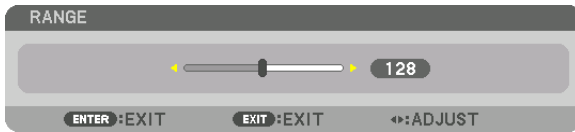

TIP:

- Adjust to overlap one projector's marker with the other projector's marker.

2 Adjust [POSITION].

Use the ◀ or ▶ button to align one edge with the other edge of overlapped images.

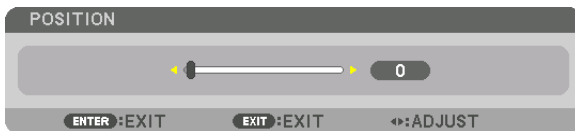

TIP:

- When displaying a signal with a different resolution, perform the Edge Blending function from the start.
- Setting of [MARKER] will not be saved and return to [OFF] when the projector is turned off.
- To display or hide the marker while the projector is running, turn on or off [MARKER] from the menu.

[BLEND CURVE]

Adjust the brightness of the overlapped section on the screens. According to the necessity, adjust the brightness of the overlapped section on the screens by the [BLEND CURVE] AND [BLACK LEVEL].

- Set the [MODE] to [ON] for selecting [BLEND CURVE] and [BLACK LEVEL].

Selecting an option for the [BLEND CURVE]

By controlling the graduation of the overlapped section on the screens, it makes the border on the projected screens inconspicuous. Select the optimal option among nine.

1. On the On-Screen Menu, move the cursor onto the [DISPLAY] → [EDGE BLENDING] → [BLEND CURVE] and then press the ENTER. The option setting screen for the [BLEND CURVE] is displayed on.

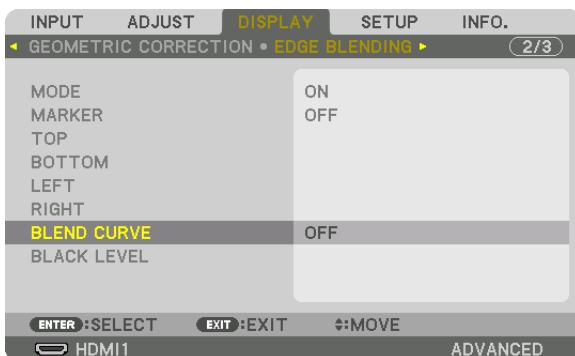

2. Select one option among nine by ▲ or ▼.

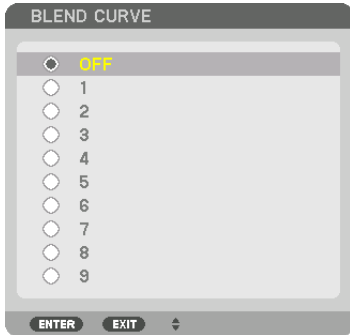

Black Level Adjustment

This adjusts the black level of the overlapping area and the non-overlapping area of the multi-screen (EDGE BLENDING). Adjust the intensity of the brightness and tone of the black color.

NOTE:

- This function is enabled only when [MODE] is turned on.
Adjustable area varies depending on what combination of [TOP], [BOTTOM], [LEFT] and [RIGHT] are turned on.

Example: Adjusting the Black Level when placing two projectors side by side

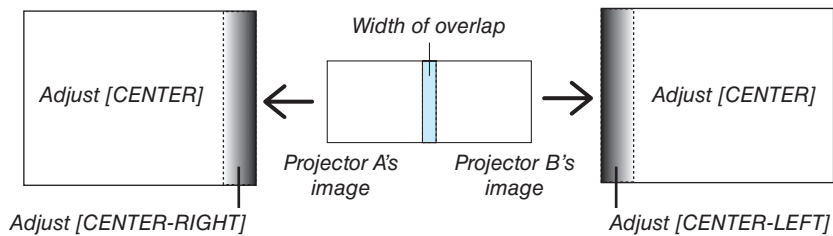

1. Select [DISPLAY] → [EDGE BLENDING] → [BLACK LEVEL] and press the ENTER button.

The screen will switch to the black level adjustment screen.

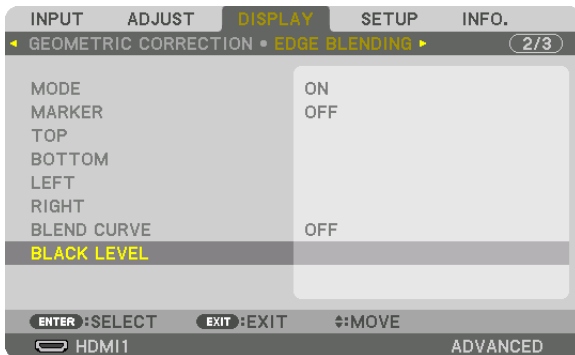

2. Use the ◀, ▶, ▼ or ▲ button to select an item and use the ◀ or ▶ to adjust the black level (intensity and tone).

Do this for the other projector if necessary.

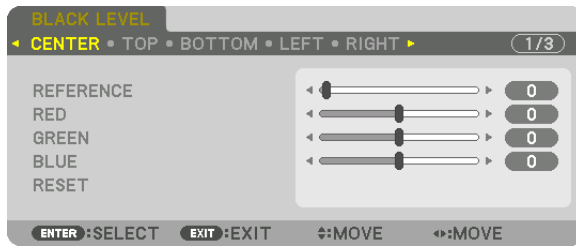

9-segmented portions for Black Level adjustment

The black level of the center projector is adjusted as shown in the figure.

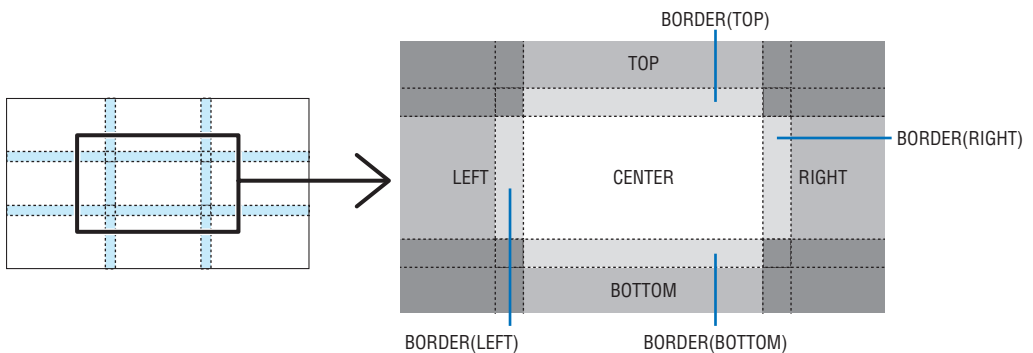

The black level of the lower left projector is adjusted as shown in the figure.

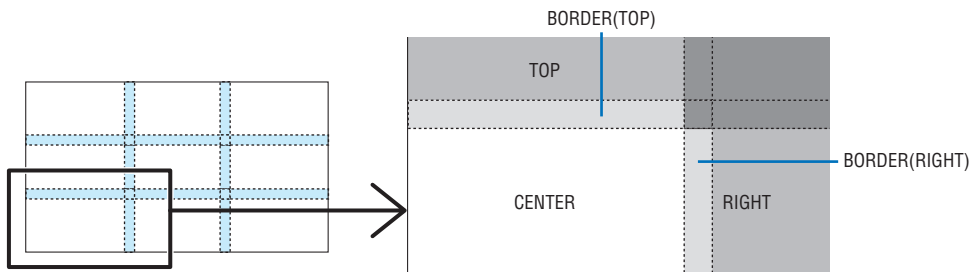

TIP:

- The number of black level division screens changes depending on the number of edge blending positions selected (top, bottom, right, left). In addition, when the top / bottom and left / right ends are selected, the corner division screen appears.
- The edge blending width is the width set in the range and the corner is formed by the intersecting area of the top / bottom ends or left / right ends.
- The [BLACK LEVEL] can be adjusted to make it brighter only.

5. Using On-Screen Menu

① Using the Menus

NOTE:

- The on-screen menu may not be displayed correctly depending on input signal and the projector setting.

1. Press the **MENU** button on the remote control or the projector cabinet to display the menu.

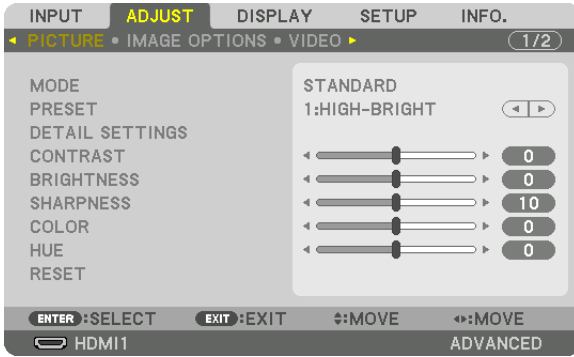

NOTE:

- The commands such as **ENTER**, **EXIT**, **▲▼**, **◀▶** in the bottom show available buttons for your operation.

2. Press the **◀▶** buttons on the remote control or the projector cabinet to display the submenu.
3. Press the **ENTER** button on the remote control or the projector cabinet to highlight the top item or the first tab.
4. Use the **▲▼** buttons on the remote control or the projector cabinet to select the item you want to adjust or set.

You can use the **◀▶** buttons on the remote control or the projector cabinet to select the tab you want.

5. Press the **ENTER** button on the remote control or the projector cabinet to display the submenu window.
6. Adjust the level or turn the selected item on or off by using the **▲▼◀▶** buttons on the remote control or the projector cabinet.

Changes are stored until adjusted again.

7. Repeat steps 2-6 to adjust an additional item, or press the **EXIT** button on the remote control or the projector cabinet to quit the menu display.

NOTE:

- When a menu or message is displayed, several lines of information may be lost, depending on the signal or settings.

8. Press the **MENU** button to close the menu.

To return to the previous menu, press the **EXIT** button.

2 Menu Elements

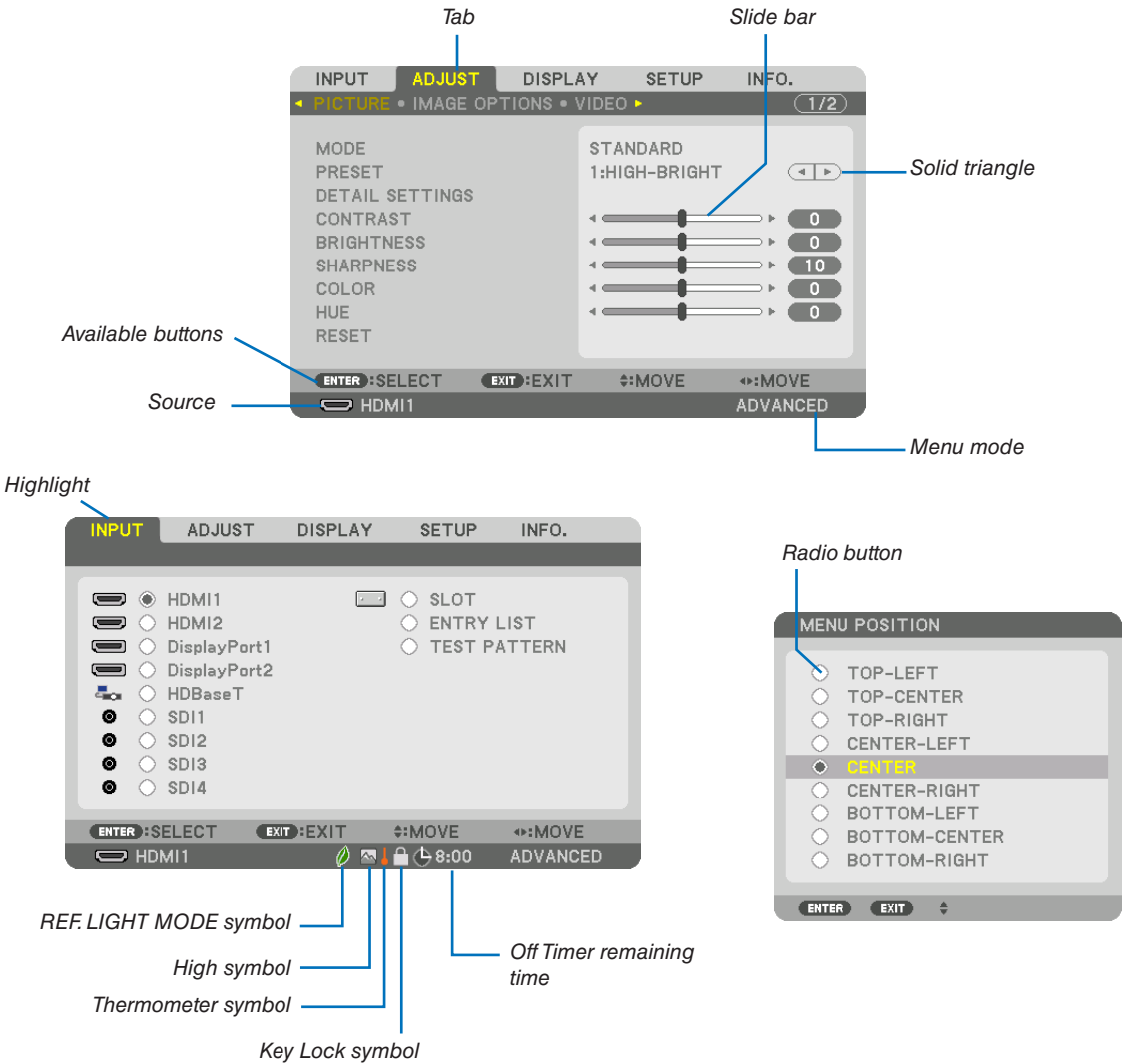

Menu windows or dialog boxes typically have the following elements:

- Highlight.....Indicates the selected menu or item.
- Solid triangleIndicates further choices are available. A highlighted triangle indicates the item is active.
- Tab.....Indicates a group of features in a dialog box. Selecting on any tab brings its page to the front.
- Radio button.....Use this round button to select an option in a dialog box.
- SourceIndicates the currently selected source.
- Menu modeIndicates the current menu mode: BASIC or ADVANCED.
- Off Timer remaining time....Indicates the remaining countdown time when the [OFF TIMER] is preset.
- Slide barIndicates settings or the direction of adjustment.
- REF. LIGHT MODE symbol...Indicates the [REF. LIGHT MODE] is set to [ECO1] or [ECO2].
- Thermometer symbolIndicates the projector is in the Forced ECO MODE.
- High symbolIndicates the built-in atmospheric pressure sensor detects height over 600 m.
- Key Lock symbolIndicates the [CONTROL PANEL LOCK] is enabled.

3 List of Menu Items

• Basic menu items are indicated by shaded area.

Some menu items are not available depending on the input source.

Menu Item	Default	Options			
INPUT	HDMI1				
	HDMI2				
	DisplayPort1				
	DisplayPort2				
	HDBaseT				
	SDI1				
	SDI2				
	SDI3				
	SDI4				
	SLOT				
	ENTRY LIST				
TEST PATTERN					
ADJUST	MODE	STANDARD	STANDARD, PROFESSIONAL		
	PRESET	*	AUTO, HIGH-BRIGHT, PRESENTATION, VIDEO, MOVIE, GRAPHIC, sRGB, DICOM SIM., EDGE BLENDING		
	DETAIL SETTINGS	GENERAL			
		REFERENCE		*	HIGH-BRIGHT, PRESENTATION, VIDEO, MOVIE, GRAPHIC, sRGB, DICOM SIM., EDGE BLENDING
		GAMMA CORRECTION* ¹	SELECT REFERENCE		DYNAMIC, NATURAL, BLACK DETAIL
		SCREEN SIZE* ²		*	LARGE, MEDIUM, SMALL
		COLOR TEMPERATURE* ³		*	
		DYNAMIC CONTRAST		*	OFF, ON
		LIGHT MODE	LIGHT ADJUST CONSTANT BRIGHTNESS	OFF	OFF, ON
		Brilliant Color		*	OFF, MEDIUM, HIGH
		WHITE BALANCE			
		CONTRAST R		0	
		CONTRAST G		0	
		CONTRAST B		0	
		BRIGHTNESS R		0	
		BRIGHTNESS G		0	
		BRIGHTNESS B		0	
		COLOR CORRECTION			
	RED		0	HUE, SATURATION	
	GREEN		0	HUE, SATURATION	
	BLUE		0	HUE, SATURATION	
	YELLOW		0	HUE, SATURATION	
	MAGENTA		0	HUE, SATURATION	
	CYAN		0	HUE, SATURATION	
	CONTRAST		50		
	BRIGHTNESS		50		
	SHARPNESS		10		
	COLOR		50		
	HUE		0		
	RESET				
	IMAGE OPTIONS	HORIZONTAL		*	
		VERTICAL		*	
		BLANKING		*	TOP, BOTTOM, LEFT, RIGHT
OVERSCAN		AUTO	AUTO, 0[%], 5[%], 10[%]		
ASPECT RATIO		AUTO	(HDTV/SDTV) AUTO, NORMAL, 4:3, LETTERBOX, WIDE SCREEN, ZOOM, FULL		
VIDEO	NOISE REDUCTION		OFF	OFF, LOW, MEDIUM, HIGH	
	DEINTERLACE		NORMAL	NORMAL, MOVIE, STILL	
	CONTRAST ENHANCEMENT	MODE GAIN	AUTO	OFF, AUTO, NORMAL	
	SIGNAL TYPE		AUTO	AUTO, RGB, REC601, REC709, REC2020	
	VIDEO LEVEL		AUTO	AUTO, NORMAL, ENHANCED, SUPER WHITE	
	HDR MODE* ⁴		AUTO	AUTO, OFF, ON	

* The asterisk (*) indicates that the default setting varies depending on the signal.
^{*1} The [GAMMA CORRECTION] item is available when an item other than [DICOM SIM.] is selected for [REFERENCE].
^{*2} The [SCREEN SIZE] item is available when [DICOM SIM.] is selected for [REFERENCE].
^{*3} When [HIGH-BRIGHT] is selected in [REFERENCE], the [COLOR TEMPERATURE] is not available.
^{*4} The [HDR MODE] item is available exclusively for 4K signal.

5. Using On-Screen Menu

Menu Item		Default	Options		
ADJUST	LENS MEMORY	STORE			
		MOVE			
		RESET			
DISPLAY	GEOMETRIC CORRECTION	MODE	OFF, KEYSTONE, CORNERSTONE, HORIZONTAL CORNER, VERTICAL CORNER, WARP		
		KEYSTONE	HORIZONTAL		
			VERTICAL		
			TILT		
			THROW RATIO		
		CORNERSTONE	TOP-LEFT, TOP, TOP-RIGHT, LEFT, RIGHT, BOTTOM-LEFT, BOTTOM, BOTTOM-RIGHT		
		HORIZONTAL CORNER	TOP-LEFT, TOP, TOP-RIGHT, LEFT, RIGHT, BOTTOM-LEFT, BOTTOM, BOTTOM-RIGHT		
		VERTICAL CORNER	TOP-LEFT, TOP, TOP-RIGHT, LEFT, RIGHT, BOTTOM-LEFT, BOTTOM, BOTTOM-RIGHT		
	WARP	TOP-LEFT, TOP, TOP-RIGHT, LEFT, RIGHT, BOTTOM-LEFT, BOTTOM, BOTTOM-RIGHT			
	RESET				
	EDGE BLENDING	MODE	OFF	OFF, ON	
		MARKER	OFF	OFF, ON	
		TOP	CONTROL	ON	OFF, ON
			RANGE		
			POSITION		
		BOTTOM	CONTROL	ON	OFF, ON
			RANGE		
			POSITION		
		LEFT	CONTROL	ON	OFF, ON
			RANGE		
			POSITION		
		RIGHT	CONTROL	ON	OFF, ON
			RANGE		
			POSITION		
		BLEND CURVE	5	OFF, 1, 2, 3, 4, 5, 6, 7, 8, 9	
	BLACK LEVEL	CENTER		REFERENCE, RED, GREEN, BLUE, RESET	
		TOP			
BOTTOM					
LEFT					
RIGHT					
BORDER(TOP)					
BORDER(BOTTOM)					
BORDER(LEFT)					
BORDER(RIGHT)					
PICTURE SETTING	MODE	OFF	OFF, ZOOM		
	ZOOM	HORIZONTAL ZOOM			
		VERTICAL ZOOM			
		HORIZONTAL POSITION			
		VERTICAL POSITION			

5. Using On-Screen Menu

Menu Item		Default	Options		
SETUP	MENU(1)	LANGUAGE	ENGLISH ENGLISH, DEUTSCH, FRANÇAIS, ITALIANO, ESPAÑOL, SVENSKA, 日本語 DANSK, PORTUGUÊS, ČEŠTINA, MAGYAR, POLSKI, NEDERLANDS, SUOMI NORSK, TÜRKÇE, РУССКИЙ, عربي, Ελληνικά, 简体中文, 한국어 ROMÂNĂ, HRVATSKA, БЪЛГАРСКИ, INDONESIA, हिन्दी, ไทย, نوبينور, 繁體中文, Tiếng Việt		
		COLOR SELECT	COLOR	COLOR, MONOCHROME	
		INPUT DISPLAY	ON	OFF, ON	
		MESSAGE DISPLAY	ON	OFF, ON	
		ID DISPLAY	ON	OFF, ON	
		DISPLAY TIME	AUTO 45 SEC	MANUAL, AUTO 5 SEC, AUTO 15 SEC, AUTO 45 SEC	
	MENU(2)	MENU ANGLE	0°	0°, 90°, 270°	
		MENU POSITION	CENTER	TOP-LEFT, TOP-CENTER, TOP-RIGHT, CENTER-LEFT, CENTER, CENTER-RIGHT, BOTTOM-LEFT, BOTTOM-CENTER, BOTTOM-RIGHT	
	INSTALLATION(1)	ORIENTATION	DESKTOP FRONT	DESKTOP FRONT, CEILING REAR, DESKTOP REAR, CEILING FRONT	
		SCREEN TYPE	FREE	FREE, 4:3 SCREEN, 16:9 SCREEN, 16:10 SCREEN	
		FAN MODE	AUTO	AUTO, HIGH	
		REF. LIGHT MODE	REF. LIGHT MODE	NORMAL	NORMAL, ECO1, ECO2
			REF. LIGHT ADJUST		
			CONSTANT BRIGHTNESS	OFF	OFF, ON
		REF. WHITE BALANCE	CONTRAST R		
			CONTRAST G		
			CONTRAST B		
			BRIGHTNESS R		
	BRIGHTNESS G				
		BRIGHTNESS B			
	INSTALLATION(2)	SHUTTER SETTINGS	POWER ON SHUTTER	OPEN	OPEN, CLOSE
			PICTURE MUTE SHUTTER	OPEN	OPEN, CLOSE
			FADE IN TIME		0-10 SEC
			FADE OUT TIME		0-10 SEC
		REF. LENS MEMORY	PROFILE	1	1, 2
			STORE		
			MOVE		
			RESET		
			LOAD BY SIGNAL	OFF	OFF, ON
		FORCED MUTE	OFF	OFF, ON	
LENS POSITION		HOME			
TYPE			NP39ML		
LENS CALIBRATION					

5. Using On-Screen Menu

Menu Item		Default	Options					
SETUP	CONTROL	TOOLS	ADMINISTRATOR MODE	MENU MODE	ADVANCED	ADVANCED, BASIC		
			NOT SAVE SETTING VALUES	OFF	OFF, ON			
			NEW PASSWORD					
			CONFIRM PASSWORD					
			PROGRAM TIMER	SETTINGS	ENABLE	OFF	OFF, ON	
					EDIT	ACTIVE	OFF	OFF, ON
						DAY	SUN	SUN, MON, TUE, WED, THU, FRI, SAT, MON-FRI, MON-SAT, EVERY DAY
						TIME		
						FUNCTION	POWER	POWER, INPUT
						ADVANCED SETTINGS		
						POWER	OFF	OFF, ON
						INPUT	HDMI1	HDMI1, HDMI2, DisplayPort1, DisplayPort2, HDBaseT, SDI1, SDI2, SDI3, SDI4, SLOT
					REPEAT	OFF	OFF, ON	
					DELETE			
					UP			
					DOWN			
					BACK			
			DATE AND TIME SETTINGS	TIME ZONE SETTINGS	UTC		-12:00, -11:30, -11:00, -10:30, -10:00, -09:30, -09:00, -08:30, -08:00, -07:30, -07:00, -06:30, -06:00, -05:30, -05:00, -04:30, -04:00, -03:30, -03:00, -02:30, -02:00, -01:30, -01:00, -00:30, 00:00, +00:30, +01:00, +01:30, +02:00, +02:30, +03:00, +03:30, +04:00, +04:30, +05:00, +05:30, +06:00, +06:30, +07:00, +07:30, +08:00, +08:30, +09:00, +09:30, +10:00, +10:30, +11:00, +11:30, +12:00, +12:30, +13:00	
					DATE MM/DD/YYYY			
				DATE AND TIME SETTINGS	TIME HH:MM			
					INTERNET TIME SERVER		OFF, ON	
					IP ADDRESS			
					UPDATE			
				SUMMER TIME SETTINGS	ENABLE		OFF, ON	
					MON(START)		1, 2, 3, 4, 5, 6, 7, 8, 9, 10, 11, 12	
					DAY(START)		FIRST WEEK, SECOND WEEK, THIRD WEEK, FOURTH WEEK, LAST WEEK	
							SUN, MON, TUE, WED, THU, FRI, SAT	
					TIME(START)			
					MON(EXIT)		1, 2, 3, 4, 5, 6, 7, 8, 9, 10, 11, 12	
					DAY(EXIT)		FIRST WEEK, SECOND WEEK, THIRD WEEK, FOURTH WEEK, LAST WEEK	
							SUN, MON, TUE, WED, THU, FRI, SAT	
			TIME(EXIT)					
			TIME DIFFERENCE		+01:00, +00:30, -00:30, -01:00			
			CONTROL PANEL LOCK		OFF	OFF, ON		
			SECURITY		OFF	OFF, ON		
			COMMUNICATION SPEED		38400bps	4800bps, 9600bps, 19200bps, 38400bps, 115200bps		
			CONTROL ID	CONTROL ID NUMBER	1	1-254		
				CONTROL ID	OFF	OFF, ON		
			REMOTE SENSOR		FRONT/BACK	FRONT/BACK, FRONT, BACK, HDBaseT		

5. Using On-Screen Menu

Menu Item		Default	Options			
SETUP	NETWORK SETTINGS	WIRED LAN	INTERFACE	LAN, HDBaseT		
			PROFILES	PROFILE 1, PROFILE 2		
			DHCP	OFF, ON		
			IP ADDRESS			
			SUBNET MASK			
			GATEWAY			
			AUTO DNS	OFF, ON		
			DNS CONFIGURATION			
			RECONNECT			
		PROJECTOR NAME	PROJECTOR NAME	PJ-*****		
		DOMAIN	HOST NAME	pj-*****		
			DOMAIN NAME			
		ALERT MAIL	ALERT MAIL	OFF, ON		
			HOST NAME	pj-*****		
			DOMAIN NAME			
			SENDER'S ADDRESS			
			SMTP SERVER NAME			
			RECIPIENT'S ADDRESS 1			
			RECIPIENT'S ADDRESS 2			
			RECIPIENT'S ADDRESS 3			
			TEST MAIL			
		NETWORK SERVICE	HTTP SERVER	NEW PASSWORD		
				CONFIRM PASSWORD		
			PJLink	NEW PASSWORD		
				CONFIRM PASSWORD		
				CLASS	CLASS1, CLASS2	
				DESTINATION		
			CRESTRON	ROOMVIEW	OFF, ON	
				CRESTRON CONTROL (ENABLE, CONTROLLER IP ADDRESS, IP ID)		
				AMX BEACON	OFF, ON	
				Extron XTP	OFF, ON	
		SOURCE OPTIONS(1)	DEFAULT INPUT SELECT		LAST	LAST, AUTO, HDMI1, HDMI2, DisplayPort1, DisplayPort2, HDBaseT, SDI1, SDI2, SDI3, SDI4, SLOT
			BACKGROUND		BLUE	BLUE, BLACK, LOGO
	EDID VERSION		HDMI1	MODE1	MODE1, MODE2	
			HDMI2	MODE1	MODE1, MODE2	
	HDCP VERSION		HDMI1	HDCP2.2	HDCP2.2, HDCP1.4	
			HDMI2	HDCP2.2	HDCP2.2, HDCP1.4	
		HDBaseT	HDCP1.4	HDCP2.2, HDCP1.4		
	POWER OPTIONS	STANDBY MODE		NORMAL	NORMAL, SLEEP	
		DIRECT POWER ON		OFF	OFF, ON	
		AUTO POWER ON SELECT		OFF	OFF, HDMI1, HDMI2, DisplayPort1, DisplayPort2, HDBaseT, SDI1, SDI2, SDI3, SDI4, SLOT	
		AUTO POWER OFF		OFF	OFF, 0:05, 0:10, 0:15, 0:20, 0:30, 1:00	
		OFF TIMER		OFF	OFF, 0:30, 1:00, 2:00, 4:00, 8:00, 12:00, 16:00	
		SLOT POWER	PROJECTOR ON	ON	OFF, ON	
			PROJECTOR STANDBY	ENABLE	DISABLE, ENABLE	
	RESET	CURRENT SIGNAL				
		ALL DATA				
ALL DATA (INCLUDING ENTRY LIST)						

5. Using On-Screen Menu

Menu Item		Default	Options
INFO.	USAGE TIME	LIGHT HOURS USED	
		TOTAL CARBON SAVINGS	
	SOURCE(1)	INPUT TERMINAL	
		RESOLUTION	
		HORIZONTAL FREQUENCY	
		VERTICAL FREQUENCY	
		SYNC POLARITY	
		SCAN TYPE	
		SOURCE NAME	
	ENTRY NO.		
	SOURCE(2)	SIGNAL TYPE	
		BIT DEPTH	
		VIDEO LEVEL	
	WIRED LAN	IP ADDRESS	
		SUBNET MASK	
		GATEWAY	
		MAC ADDRESS	
		DNS	
	VERSION	FIRMWARE	
		DATA	
		FIRMWARE2	
	OTHERS	DATE TIME	
		PROJECTOR NAME	
		MODEL NO.	
		SERIAL NUMBER	
	HDBaseT	CONTROL ID* ⁵	
		SIGNAL QUALITY	
		OPERATION MODE	
		LINK STATUS	
		HDMI STATUS	

*5 [CONTROL ID] will be displayed when [CONTROL ID] has been set up.

4 Menu Descriptions & Functions [INPUT]

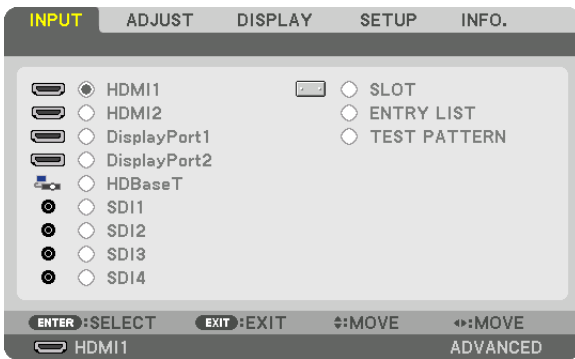

HDMI1

This projects the video of the device connected to the HDMI 1 IN terminal.

HDMI2

This projects the video of the device connected to the HDMI 2 IN terminal.

DisplayPort1

This projects the video of the device connected to the DisplayPort1 IN terminal.

DisplayPort2

This projects the video of the device connected to the DisplayPort2 IN terminal.

HDBaseT

Projecting the HDBaseT signal.

SDI1

This projects the video of the device connected to the SDI1 IN terminal.

SDI2

This projects the video of the device connected to the SDI2 IN terminal.

SDI3

This projects the video of the device connected to the SDI3 IN terminal.

SDI4

This projects the video of the device connected to the SDI4 IN terminal.

SLOT

Projects the picture via the optional board (sold separately) inserted into the SLOT.

ENTRY LIST

Displays a list of signals. See the following pages.

TEST PATTERN

Closes the menu and switches to the test pattern screen.

Select the pattern using the ◀▶ buttons.

Using the Entry List

The projected signals can be registered in the Entry list. Also, when you perform image settings, lens memory registration, etc., the adjustment value of the signal is automatically registered in the Entry list of this unit. The (adjustment values of) registered signals can be loaded from the Entry List whenever necessary. When recalling a registered signal, the video can be displayed faster compared to an unregistered signal.

However, only up to 100 patterns can be registered in the Entry List. When 100 patterns have been registered in the Entry List, an error message is then displayed and no additional patterns can be registered. You should thus delete (adjustment values of) signals that are no longer needed.

Displaying the Entry list

1. Press the MENU button.

The menu will be displayed.

2. Press the ◀ or ▶ button to select [INPUT].

The INPUT list will be displayed.

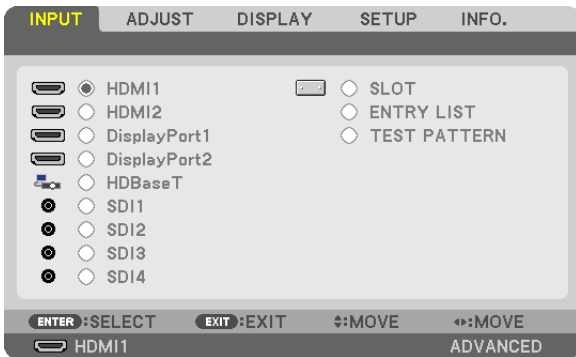

3. Use the ◀, ▶, ▲, or ▼ to select [ENTRY LIST] and press the ENTER button.

The ENTRY LIST windows will be displayed.

If the ENTRY LIST window is not displayed, switch the menu to [ADVANCED].

To switch the menu between [ADVANCED] and [BASIC], select [SETUP] → [CONTROL] → [TOOLS] → [ADMINISTRATOR MODE] → [MENU MODE]. (→ page 106)

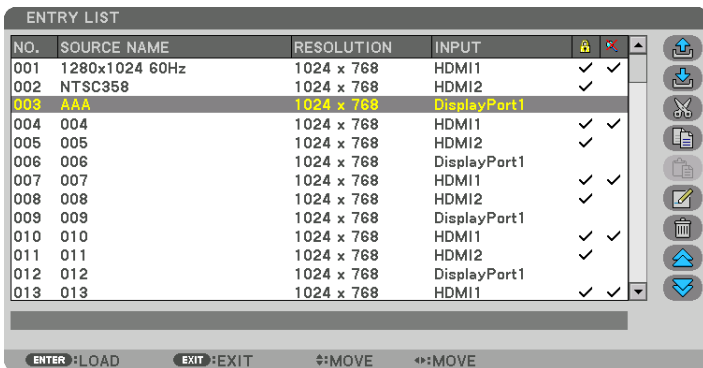

Entering the currently projected signal into the Entry List [ (STORE)]

1. Press the ▲ or ▼ button to select any number.
2. Press the ◀ or ▶ button to select [ (STORE)] and press the ENTER button.

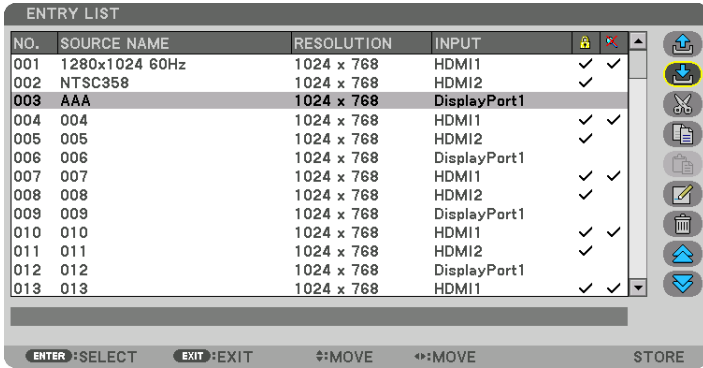

Calling up a signal from the Entry List [ (LOAD)]



Press the ▲ or ▼ button to select a signal and press the ENTER button.

Editing a signal from the Entry List [ (EDIT)]

1. Press the ▲ or ▼ button to select a signal you wish to edit.
2. Press the ◀, ▶, ▲, or ▼ button to select [ (EDIT)] and press the ENTER button.

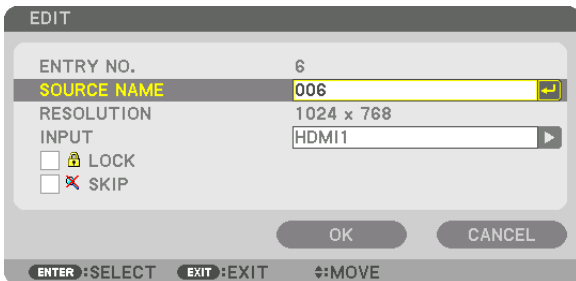
The EDIT window will be displayed.



SOURCE NAME	Enter a signal name. Up to 18 alphanumeric characters can be used.
INPUT	The input terminal can be changed.
 LOCK	Set so that the selected signal cannot be deleted when [ (ALL DELETE)] is executed. The changes made after LOCK execution cannot be saved.
 SKIP	Set so that the selected signal will be skipped during auto search.

3. Set the above items and select [OK] and press the ENTER button.

NOTE:

- The input terminal cannot be changed to the currently projected signal.

Cutting a signal from the Entry List [(CUT)]

1. Press the ▲ or ▼ button to select a signal you wish to delete.
2. Press the ◀, ▶, ▲, or ▼ button to select [ (CUT)] and press the ENTER button.

The signal will be deleted from the Entry List and the deleted signal will be displayed on the clipboard at the bottom of the Entry List.



NOTE:

- The currently projected signal cannot be deleted.
- When the locked signal is selected, it will be displayed in gray which indicates it is not available.

TIP:

- Data on the clipboard can be passed onto the Entry List.
- Data on the clipboard will not be lost after the Entry List is closed.

Copying and pasting a signal from the Entry List [(COPY)] / [(PASTE)]

1. Press the ▲ or ▼ button to select a signal you wish to copy.
2. Press the ◀, ▶, ▲, or ▼ button to select [ (COPY)] and press the ENTER button.
The copied signal will be displayed on the clipboard at the bottom of the Entry List.
3. Press the ◀ or ▶ button to move to the list.
4. Press the ▲ or ▼ button to select a signal.
5. Press the ◀, ▶, ▲, or ▼ button to select [ (PASTE)] and press the ENTER button.

Data on the clipboard will be pasted to the signal.

Deleting all the signals from the Entry List [(ALL DELETE)]

1. Press the ◀, ▶, ▲, or ▼ button to select [ (ALL DELETE)] and press the ENTER button.
The confirmation message will be displayed.
2. Press the ◀ or ▶ button to select [YES] and press the ENTER button.

NOTE:

- The locked signal cannot be deleted.

Using Test Pattern [TEST PATTERN]

Displays the test pattern for adjusting distortion on the screen and the focus at the time of the projector setup. Once the [TEST PATTERN] on the onscreen menu is selected, the pattern for adjustment will be displayed on. If you find distortion on the pattern, adjust the projector installation angle or correct distortion by pressing the Geometric. button on the remote. If the focus adjustment is required, press the FOCUS button on the remote control for displaying the FOCUS adjustment screen and then adjust FOCUS by ◀ or ▶ button. Recommend to perform the focus adjustment after leaving the projector under the state the TEST PATTERN has been projected for over 30 minutes. Press EXIT button to close the test pattern and return to the menu.

5 Menu Descriptions & Functions [ADJUST] [PICTURE]

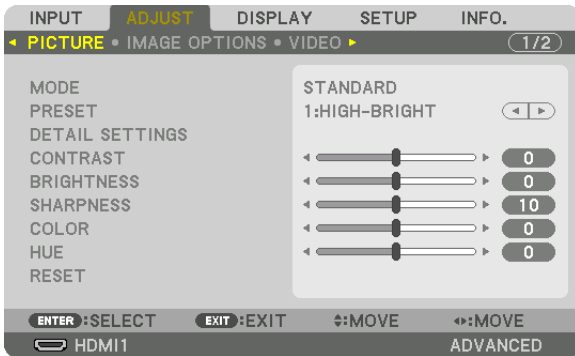

[MODE]

This function allows you to determine how to save settings for [DETAIL SETTINGS] of [PRESET] for each input.

STANDARD..... Saves settings for each item of [PRESET] (Preset 1 through 8)

PROFESSIONAL..... Saves all the settings of [PICTURE] for each input.

NOTE:

- When [TEST PATTERN] is displayed, [MODE] cannot be selected.

[PRESET]

This function allows you to select optimized settings for your projected image.

You can adjust neutral tint for yellow, cyan or magenta.

There are seven factory presets optimized for various types of images. You can also use [DETAIL SETTINGS] to set user adjustable settings to customize each gamma or color.

Your settings can be stored in [PRESET 1] to [PRESET 8].

AUTO Automatically distinguish the optimal setting for the input signal.

HIGH-BRIGHT Recommended for use in a brightly lit room.

PRESENTATION Recommended for making a presentation using a PowerPoint file.

VIDEO Recommended for typical TV program viewing.

MOVIE Recommended for movies.

GRAPHIC Recommended for graphics.

sRGB Standard color values

DICOM SIM. Recommended for DICOM simulation format.

EDGE BLENDING ... Recommended for edge blending.

NOTE:

- The [DICOM SIM.] option is for training/reference only and should not be used for actual diagnosis.
- DICOM stands for Digital Imaging and Communications in Medicine. It is a standard developed by the American College of Radiology (ACR) and the National Electrical Manufacturers Association (NEMA).
The standard specifies how digital image data can be moved from system to system.

[DETAIL SETTINGS]

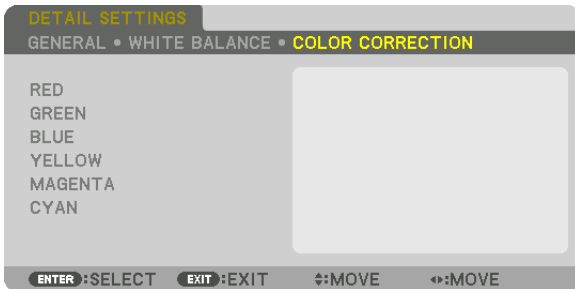
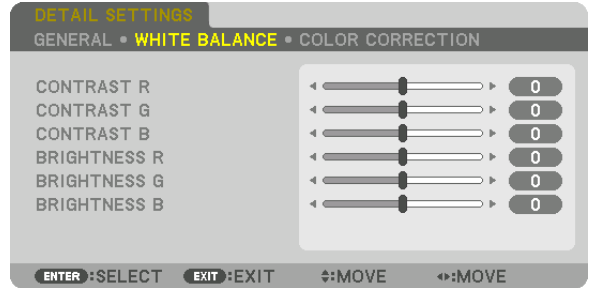
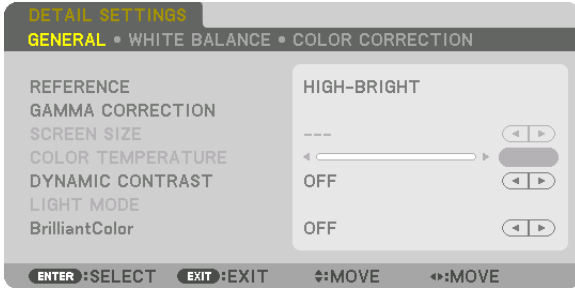

[GENERAL]

Storing Your Customized Settings [REFERENCE]

This function allows you to store your customized settings in [PRESET 1] to [PRESET 8]. First, select a base preset mode from [REFERENCE], then set [GAMMA CORRECTION] and [COLOR TEMPERATURE].

- HIGH-BRIGHT Recommended for use in a brightly lit room.
- PRESENTATION Recommended for making a presentation using a PowerPoint file.
- VIDEO Recommended for typical TV program viewing.
- MOVIE Recommended for movies.
- GRAPHIC Recommended for graphics.
- sRGB Standard color values.
- DICOM SIM. Recommended for DICOM simulation format.
- EDGE BLENDING ... Recommended for edge blending.

Selecting Gamma Correction Mode [GAMMA CORRECTION]

Each mode in [SELECT] corrects color tone of projected image and is recommended for:

- DYNAMIC Creates a high-contrast picture.
- NATURAL..... Natural reproduction of the picture.
- BLACK DETAIL..... Emphasizes detail in dark areas of the picture.

In [REFERENCE], it adjusts corrected value for projected image. Higher value means deeper correction.

NOTE:

- This function is not available when [DICOM SIM.] is selected for [DETAIL SETTINGS].

Selecting Screen Size for DICOM SIM [SCREEN SIZE]

This function will perform gamma correction appropriate for the screen size.

- LARGE For screen size of 300"
- MEDIUM For screen size of 200"
- SMALL For screen size of 100"

NOTE:

- This function is available only when [DICOM SIM.] is selected for [DETAIL SETTINGS].

Adjusting Color Temperature [COLOR TEMPERATURE]

This option allows you to select the color temperature of your choice. A value from 5000K to 10500K can be set.

NOTE:

- When [HIGH-BRIGHT] is selected in [REFERENCE], this function is not available.
- When [PRESENTATION] is selected for [REFERENCE], the COLOR TEMPERATURE adjustment changes to 3 levels: 0, 1 and 2.

Adjusting Brightness and Contrast [DYNAMIC CONTRAST]

If [ON] is selected, the most optimal contrast ratio is used according to the picture.

NOTE:

- Depending on the conditions, projector settings such as [DYNAMIC CONTRAST] may not be able to be selected.

Adjusting Brightness [LIGHT MODE]

Adjust the brightness of the projector and save it for each input signal. (→ page 39)
 With the [REF. LIGHT MODE] set to [NORMAL], the adjustment will be valid if the PICTURE [MODE] is set to [PROFESSIONAL].

LIGHT ADJUST		Brightness can be adjusted in 1% increments from 20 to 100%.
CONSTANT BRIGHTNESS	OFF	[CONSTANT BRIGHTNESS] mode will be canceled.
	ON	<p>Maintains the brightness that is in effect at the time [ON] is selected. Unless [OFF] is selected, the same settings will remain in effect even when the projector is turned off.</p> <ul style="list-style-type: none"> • To re-adjust the brightness, first turn this setting OFF before making further adjustments. <p>NOTE:</p> <ul style="list-style-type: none"> • [CONSTANT BRIGHTNESS] mode is a function used to maintain the brightness at a constant level. Color will not be fixed. • The [CONSTANT BRIGHTNESS] setting will not be saved for each input signal.

[Brilliant Color]

Selects the brightness of the color white.
 Selecting options from [MEDIUM] to [HIGH] increases the brightness of the color white.

NOTE:

- If under [REFERENCE], [HIGH-BRIGHT] or [PRESENTATION] are selected, [BrilliantColor] cannot be changed.

Adjusting White Balance [WHITE BALANCE]

This allows you to adjust the white balance. Contrast for each color (RGB) to adjust the white level of the screen; Brightness for each color (RGB) is used to adjust the black level of the screen.

[COLOR CORRECTION]

Corrects the color for all signals.

Adjusts the tone for the colors red, green, blue, yellow, magenta and cyan.

RED	HUE	+ Direction	Magenta direction
		- Direction	Yellow direction
	SATURATION	+ Direction	Vivid
		- Direction	Weak
GREEN	HUE	+ Direction	Yellow direction
		- Direction	Cyan direction
	SATURATION	+ Direction	Vivid
		- Direction	Weak
BLUE	HUE	+ Direction	Cyan direction
		- Direction	Magenta direction
	SATURATION	+ Direction	Vivid
		- Direction	Weak
YELLOW	HUE	+ Direction	Red direction
		- Direction	Green direction
	SATURATION	+ Direction	Vivid
		- Direction	Weak
MAGENTA	HUE	+ Direction	Blue direction
		- Direction	Red direction
	SATURATION	+ Direction	Vivid
		- Direction	Weak
CYAN	HUE	+ Direction	Green direction
		- Direction	Blue direction
	SATURATION	+ Direction	Vivid
		- Direction	Weak

[CONTRAST]

Adjusts the intensity of the image according to the incoming signal.

[BRIGHTNESS]

Adjusts the brightness level or the back raster intensity.

[SHARPNESS]

Controls the detail of the image.

[COLOR]

Increases or decreases the color saturation level.

[HUE]

Varies the color level from +/- green to +/- blue. The red level is used as reference.

NOTE:

- When [TEST PATTERN] is displayed, [CONTRAST], [BRIGHTNESS], [SHARPNESS], [COLOR] and [HUE] cannot be adjusted.

[RESET]

The settings and adjustments for [PICTURE] will be returned to the factory default settings with the exception of the following; Preset numbers and [REFERENCE] within the [PRESET] screen.

The settings and adjustments under [DETAIL SETTINGS] within the [PRESET] screen that are not currently selected will not be reset.

[IMAGE OPTIONS]

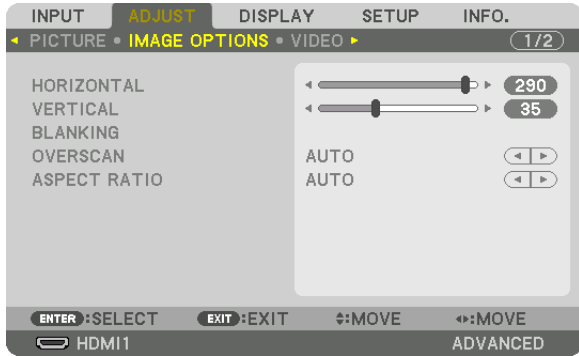

Adjusting Horizontal/Vertical Position [HORIZONTAL/VERTICAL]

Adjusts the image location horizontally and vertically.

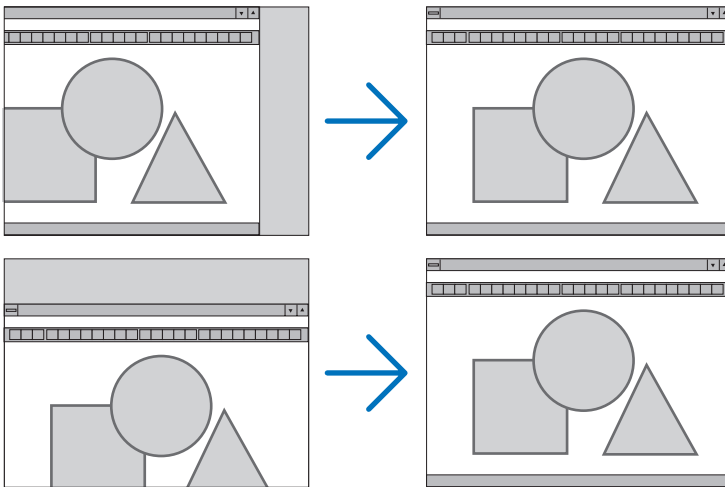

- The adjustments for [HORIZONTAL] and [VERTICAL] will be stored in memory for the current signal. The next time you project the signal with the same resolution, horizontal and vertical frequency, its adjustments will be called up and applied.
To delete adjustments stored in memory, from the menu, you select [SETUP] → [RESET] → [CURRENT SIGNAL] and reset the adjustments.

[BLANKING]

Adjusts the display range (blanking) at the top, bottom, left and right edges of the input signal.

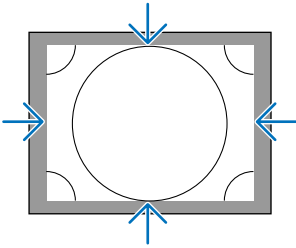

Selecting Overscan Percentage [OVERSCAN]

Select overscan percentage (Auto, 0%, 5% and 10%) for signal.

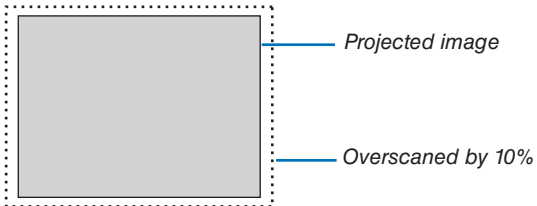

NOTE:

- The [OVERSCAN] item is not available:
 - when [NATIVE] is selected for [ASPECT RATIO].
-

Selecting the Aspect Ratio [ASPECT RATIO]

Use this function to select the screen's lateral:longitudinal aspect ratio.
The projector automatically identifies the signal being input and sets the optimum aspect ratio.

For Computer signal

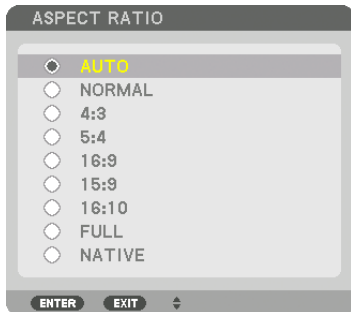

For HDTV/SDTV signals

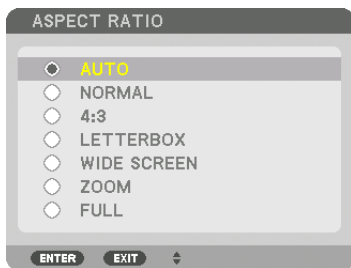

	Resolution	Aspect Ratio
VGA	640 × 480	4:3
SVGA	800 × 600	4:3
XGA	1024 × 768	4:3
WXGA	1280 × 768	15:9
WXGA	1280 × 800	16:10
HD(FWXGA)	1366 × 768	approx. 16:9
WXGA+	1440 × 900	16:10
SXGA	1280 × 1024	5:4
SXGA+	1400 × 1050	4:3
WXGA++	1600 × 900	16:9
UXGA	1600 × 1200	4:3
WSXGA+	1680 × 1050	16:10
FHD(1080P)	1920 × 1080	16:9
WUXGA	1920 × 1200	16:10
WQXGA	2560 × 1600	16:10
4K	3840 × 2160	16:9
4K	4096 × 2160	19:7

Options	Function
AUTO	The projector will automatically determine the incoming signal and display it in its aspect ratio. The projector may erroneously determine the aspect ratio depending on its signal. If this occurs, select the appropriate aspect ratio from the following.
NORMAL	The image is displayed in its original aspect ratio of its input signal..
4:3	The image is displayed in 4:3 aspect ratio.
5:4	The image is displayed in 5:4 aspect ratio
16:9	The image is displayed in 16:9 aspect ratio

5. Using On-Screen Menu

Options	Function
15:9	The image is displayed in 15:9 aspect ratio
16:10	The image is displayed in 16:10 aspect ratio
NATIVE	<p>The projector displays the current image in its true resolution when the incoming computer signal has a lower or higher resolution than the projector's native resolution. (→ page 3)</p> <p>When the incoming computer signal has a higher resolution than the projector's native resolution, the center of an image will be displayed.</p> <div data-bbox="569 415 1001 556" style="text-align: center;"> </div>
LETTER BOX	<p>The image of a letterbox signal (16:9) is stretched equally in the horizontal and vertical directions to fit the screen.</p> <div data-bbox="569 656 1001 788" style="text-align: center;"> </div>
WIDE SCREEN	<p>The image of a squeeze signal (16:9) is stretched left and right in 16:9.</p> <div data-bbox="569 859 1001 991" style="text-align: center;"> </div>
ZOOM	<p>The image of a squeeze signal (16:9) is stretched left and right in 4:3. Parts of the displayed image are cropped at the left and right edges and therefore not visible.</p> <div data-bbox="583 1081 994 1213" style="text-align: center;"> </div>
FULL	Project to full screen size.

[VIDEO]

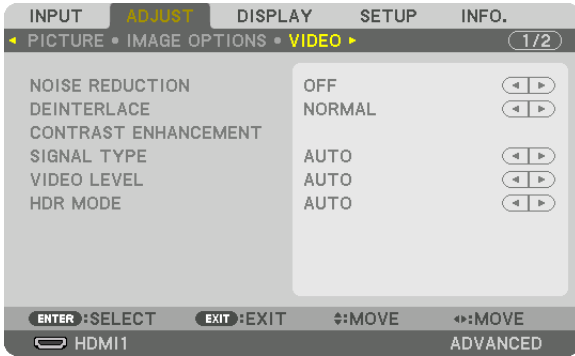

Using Noise Reduction [NOISE REDUCTION]

When projecting a video image, you can use the [NOISE REDUCTION] function to reduce the screen noise (roughness and distortion). Depending on the noise level, the noise reduction effect can be set to [OFF], [LOW], [MEDIUM] or [HIGH]. [NOISE REDUCTION] can be selected for SDTV, HDTV signal input.

Selecting Interlaced Progressive Conversion Process Mode [DEINTERLACE]

This function allows you to select an interlaced-to-progressive conversion process for video signals.

- NORMAL..... Automatically distinguishes a moving image from a static image to create a distinct image. Please select [MOVIE] if there are any obvious jitter and noises.
- MOVIE Select when projecting moving images. This is suitable for signals with a lot of jitter and noise.
- STILL..... Select when projecting static images. The video will flicker when a moving image is projected.

[CONTRAST ENHANCEMENT]

Using the characteristics of the human eye, a picture quality with a sense of contrast and resolution is achieved.

- OFF Suite vision is switched off.
- AUTO Contrast and picture quality are automatically improved using the suite vision function.
- NORMAL..... Adjust the gain manually.

[SIGNAL TYPE]

Selection of RGB and component signals. Normally, this is set to [AUTO]. Please change the setting if the color of the image remains unnatural.

- AUTO Automatically distinguishes RGB and component signals.
- RGB Switches to the RGB input.
- REC601 Switches to the component signal conforming to the ITU-R BT.601 standard.
Setting appropriate to SDTV images.
- REC709 Switches to the component signal conforming to the ITU-R BT.709 standard.
Setting appropriate to HDTV images.
- REC2020 Switches to the component signal conforming to the ITU-R BT.2020 standard.
Setting appropriate to 4K images.

[VIDEO LEVEL]

Selection of the video signal level when connecting an external device to the HDMI 1 IN terminal, HDMI 2 IN terminal, DisplayPort1 IN terminal, DisplayPort2 IN terminal, and HDBaseT IN terminal of the projector.

- AUTO The video level is switched automatically based on the information from the device outputting the signal.
Depending on the connected device, this setting may not be made properly. In this case, switch to [NORMAL] or [ENHANCED] from the menu and view with the optimum setting.
- NORMAL This disables the enhanced mode.
- ENHANCED This improves the image's contrast, expressing the dark and light sections more dynamically.
- SUPER WHITE The video contrast is improved and the dark areas appear more dynamic.

[HDR MODE]

- AUTO Automatically distinguishes HDR signal.
- OFF Projects the image based on the input signal
- ON Projects the image conforming to the HDR signal

NOTE:

- *These options are available exclusively for 4K signal.*
-

Using the Lens Memory Function [LENS MEMORY]



This function serves to store the adjusted values for each input signal when using the LENS SHIFT, ZOOM and FOCUS buttons of the projector. Adjusted values can be applied to the signal you selected. This will eliminate the need to adjust lens shift, focus, and zoom at the time of source selection.

- STORE Stores the current adjusted values in memory for each input signal.
- MOVE Applies the adjusted values to the current signal.
- RESET..... Returns the adjusted values to the last condition.

NOTE:

- Lens memory adjustments will be automatically registered the ENTRY LIST. These lens memory adjustments can be loaded from the ENTRY LIST. (→ page 79)
Note that performing [CUT] or [ALL DELETE] in the ENTRY LIST will delete lens memory adjustments as well as source adjustments. This deletion will not take effect until other adjustments is loaded.
- For storing each adjustment of lens shift, zoom and focus as common value for all input signal, store them as reference lens memory.

To store your adjusted values in [LENS MEMORY]:

1. **Project the connected device signal you want to adjust.**
2. **Adjust the projecting image of position, size and focus by the L-SHIFT, ZOOM +/-, and FOCUS +/- buttons.**
 - Adjustment can be performed by the remote control. Please refer to “5 Adjusting the Picture Size and Position” on page 22.
 - Slight adjustment by moving the projector position and by the tilt foot is not subject of [LENS MEMORY].
3. **Move the cursor on [STORE] and press ENTER.**

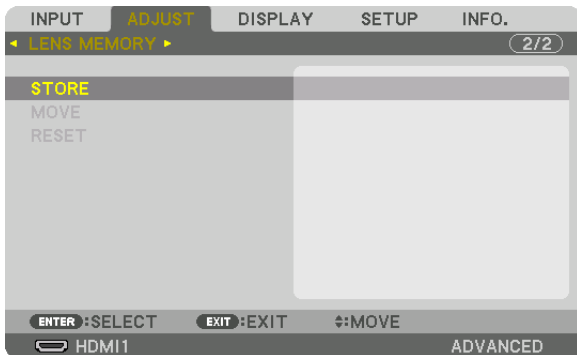

4. **Move the cursor on [YES] and press ENTER.**

To call up the adjusted values from [LENS MEMORY]:

1. From the menu, select [ADJUST] → [LENS MEMORY] → [MOVE] and press the ENTER button.



The confirmation screen will be displayed.

2. Press the ◀ button to select and [YES] and press the ENTER button.

To automatically apply the adjusted values at the time of source selection:

1. From the menu, select [SETUP] → [INSTALLATION(2)] → [REF. LENS MEMORY] → [LOAD BY SIGNAL] and press the ENTER button.



2. Press the ▼ button to select and [ON] and press the ENTER button.

This will move the lens automatically to the position at the time of source selection according to the adjusted values.

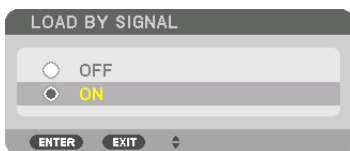

NOTE:

- The Lens Memory function may not produce a completely aligned image (due to tolerances in the lenses) using the adjusted values stored in the projector. After calling up and applying the adjusted values from the Lens Memory function, finely adjust the lens shift, zoom and focus to produce the best possible image.
-

⑥ Menu Descriptions & Functions [DISPLAY] [GEOMETRIC CORRECTION]

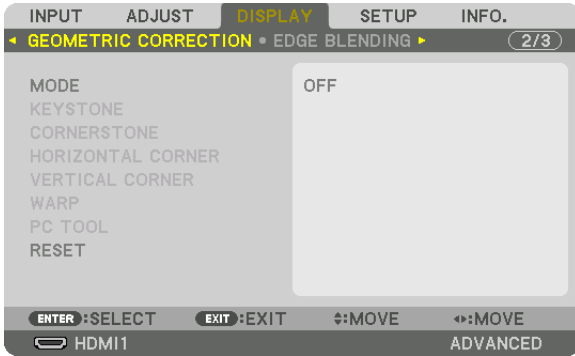

MODE

Set pattern for correcting distortion. If [OFF] is selected, the [GEOMETRIC CORRECTION] becomes ineffective. If you need to change the [MENU ANGLE], make sure to change it before performing the [GEOMETRIC CORRECTION]. If [MENU ANGLE] is changed after performing the [GEOMETRIC CORRECTION], corrected values will be reset to the default values.

KEYSTONE

Correct distortion in horizontal and vertical directions.

HORIZONTAL..... Adjustments when projecting from a diagonal direction to the screen.

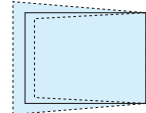

VERTICAL..... Adjustments when projecting from the top or bottom direction to the screen.

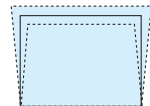

TILT Adjusts the distortion when performing trapezoidal correction with the screen moved in the vertical direction using the lens shift.

THROW RATIO..... Adjusts according to the projection ratio of the optional lens used.

Model name of lens unit	Adjustment range
NP16FL-4K	7-8
NP17ZL-4K	12-18
NP18ZL-4K	17-23
NP19ZL-4K	21-37
NP20ZL-4K	34-55
NP21ZL-4K	50-85
NP31ZL-4K	7-10
NP39ML-4K	4

NOTE:

- When power is supplied to the device, the adjustment value of the [KEYSTONE] used previously is retained even if the gradient of the device is changed.
- As electrical correction is carried out by [KEYSTONE], the brightness may be reduced or the screen quality may deteriorate sometimes.

CORNERSTONE

Display the 4-point correction screen and adjust the trapezoidal distortion of the projection screen.

Please refer to “**8** Correcting Horizontal and Vertical Keystone Distortion [CORNERSTONE]” (→ page 43) for details on the operation.

HORIZONTAL CORNER/VERTICAL CORNER

Distortion correction for corner projection such as wall surfaces.

HORIZONTAL CORNER

..... Performs correction for projection onto a wall lying at an angle to the horizontal direction.

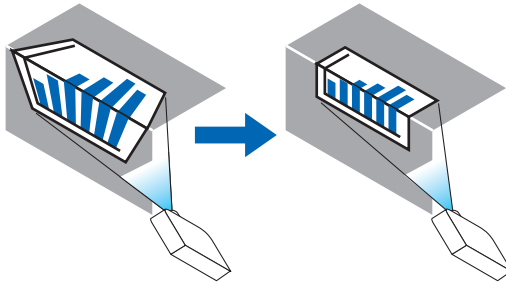

* Reverse angle correction is also possible.

VERTICAL CORNER

..... Performs correction for projection onto a wall lying at an angle to the vertical direction.

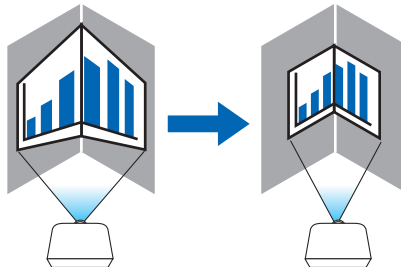

* Reverse angle correction is also possible.

NOTE:

- When the maximum adjustment range is exceeded, distortion adjustment is disabled. Set up the projector at an optimal angle as the deterioration in the image quality increases as the distortion adjustment volume gets larger.
 - Please note that the image will go out of focus due to the difference in the distance between the upper and lower or left and right sides and the center of the screen for projections cutting across corners. Lenses with short focal points are also not recommended for projections cutting across corners as the image will go out of focus.
-

Adjustment method

1. Align the cursor with the [HORIZONTAL CORNER] or [VERTICAL CORNER] of the [GEOMETRIC CORRECTION] menu and then press the ENTER button.

The adjustment screen will be displayed.

2. Press the ▼▲◀▶ buttons to align the cursor (yellow box) with the target adjustment point and then press the ENTER button.

The cursor will change into an adjustment point (yellow in color).

3. Press the ▼▲◀▶ buttons to adjust the corners or sides of the screen and then press the ENTER button.

The adjustment point will go back to being a cursor (yellow box).

Explanation of screen transition

- The adjustment points of the four corners (a, c, f and h in the drawing) will move independently.
- The following adjustment points differ at the [HORIZONTAL CORNER] and [VERTICAL CORNER].
 HORIZONTAL CORNER: When Point b in the drawing is moved, and the upper side and Point g are moved, the lower side will move in a parallel manner.
 VERTICAL CORNER: When Point d in the drawing is moved, and the left side and Point e are moved, the right side will move in a parallel manner.

[Adjustment points of the [HORIZONTAL CORNER] screen and movement points of the projection screen]

Point b will be displaced in a parallel manner at the same time as Points a, b, c

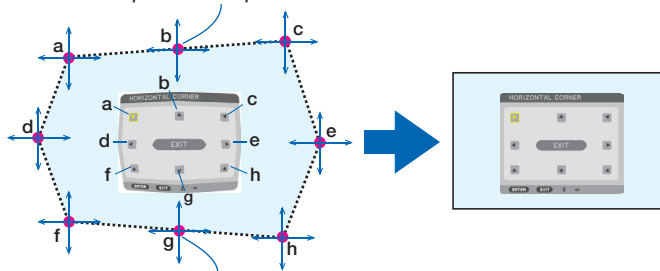

Point g will be displaced in a parallel manner at the same time as Points f, g, h

[Adjustment points of the [VERTICAL CORNER] screen and movement points of the projection screen]

Point d will be displaced in a parallel manner at the same time as Points a, d, f

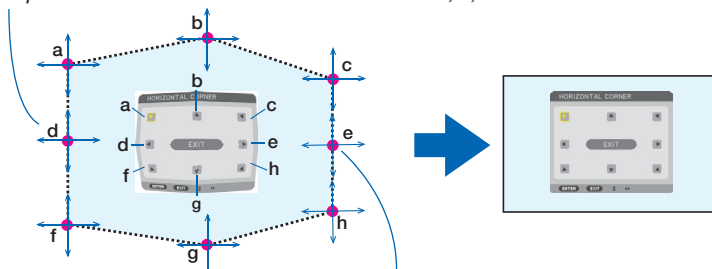

Point e will be displaced in a parallel manner at the same time as Points f, g, h

4. Start from Step 2 onwards to adjust the other points.
5. When the adjustment is completed, press the ▼▲◀▶ buttons to align the cursor with the [EXIT] in the adjustment screen and then press the ENTER button.

Switch to the [GEOMETRIC CORRECTION] menu screen.

WARP

Correct projected image distortion on a specific surface as a column or a sphere.

NOTE:

- When the maximum adjustment range is exceeded, distortion adjustment is disabled. Set up the projector at an optimal angle since the more the adjustment volume gets large, the more image quality gets deterioration.
- Please note that the image will go out of focus due to the difference in the distance between peripheries and the center of the screen for projections cutting across corners as on a column or a sphere. Lenses with short focal points are also not recommended for projections cutting across corners as the image will go out of focus.

Adjustment method

1. **Align the cursor with the [WARP] of the [GEOMETRIC CORRECTION] menu and then press the ENTER.**

Adjustment screen will be displayed on.

2. **Press the ▼▲◀▶ buttons to align the cursor (blue box) with the target adjustment point and then press the ENTER.**

The cursor will change into an adjustment point (yellow in color).

3. **Press the ▼▲◀▶ buttons to adjust the corners or sides of the screen and then press the ENTER.**

The cursor will back to yellow box.

Explanation for correcting distortion

- Eight adjustment points can be moved independently.
- For left and right sides, use ◀▶ buttons for adjusting the range of distortion, and ▼/▲ buttons for adjusting the distortion peak.
- For top and bottom sides, use ▼/▲ buttons for adjusting the range of distortion, and ◀▶ buttons for adjusting the distortion peak.
- For corners, use ▼▲◀▶ buttons for moving positions.

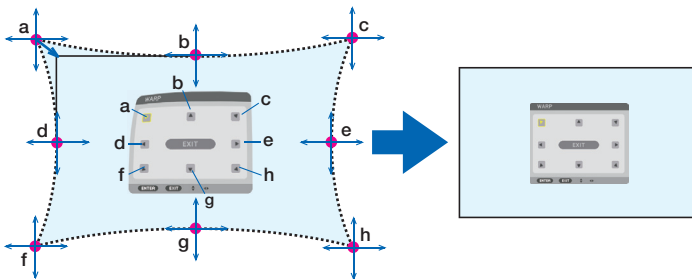

4. **For adjusting other points, repeat Step2 onwards.**

5. **When the adjustment is completed, move the cursor onto the [EXIT] on the adjustment screen and press the ENTER.**

The screen will be switched to the [GEOMETRIC CORRECTION] menu.

The adjustment completion screen will be displayed on.

6. **Press ◀ or ▶ button to move the cursor onto [OK] then press [ENTER].**

The adjusted values for WARP are stored and the screen display goes back to the [GEOMETRIC CORRECTION].

RESET

Reset the adjustment value that has been selected in [GEOMETRIC CORRECTION] (return to the initial value). It becomes ineffective when [OFF] is selected for [MODE].

- The adjusted value can be reset also by pressing the 3D REFORM button for two seconds or longer on the remote control.

[EDGE BLENDING]

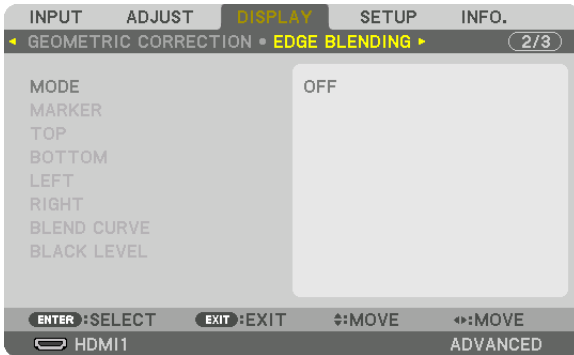

This adjusts the edges (boundaries) of the projection screen when projecting high resolution videos using a combination of several projectors in the up, down, left and right positions.

MODE

This enables or disables the EDGE BLENDING function.

When [MODE] is set to [ON], the [MARKER], [TOP], [BOTTOM], [LEFT], [RIGHT], [BLACK LEVEL] and [BLEND CURVE] settings can be adjusted.

MARKER

Set whether to display marker or not when adjusting the range and display position. When turned on, a magenta marker for adjusting the range adjustment and a green marker for adjusting the display position will be displayed.

TOP/BOTTOM/LEFT/RIGHT

This selects the EDGE BLENDING locations on the left, right, top and bottom on the screen.

The following settings can be adjusted when an item is selected. (→ page 65)

CONTROL Enable TOP, BOTTOM, LEFT and RIGHT functions.

RANGE..... Adjust the range (width) of the edge blending.

POSITION Adjust the display position of the edge blending.

BLEND CURVE

Set brightness for the [EDGE BLENDING] sections. (→ page 67)

BLACK LEVEL

Adjust the black level of the [EDGE BLENDING] section. (→ page 68)

[PICTURE SETTING]

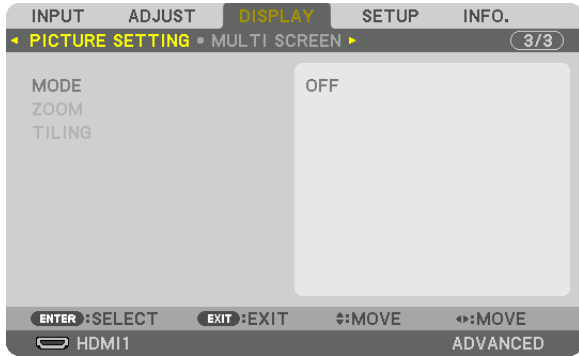

This sets the division conditions for reducing or enlarging the image area and displaying it in the desired position or for projecting using a combination of several projectors.

MODE	OFF	Use the projector in a standalone state.
	ZOOM	This adjusts the position and width of the video area that you wish to divide. The edge blending width will also be automatically set to that width.
ZOOM	HORIZONTAL ZOOM	This enlarges the video area in the horizontal direction.
	VERTICAL ZOOM	This enlarges the video area in the vertical direction.
	HORIZONTAL POSITION	This shifts the video area in the horizontal direction.
	VERTICAL POSITION	This shifts the video area in the vertical direction.

7 Menu Descriptions & Functions [SETUP]

[MENU(1)]



Selecting Menu Language [LANGUAGE]

You can choose one of 30 languages for on-screen instructions.

NOTE:

- Your setting will not be affected even when [RESET] is done from the menu.

Selecting Menu Color [COLOR SELECT]

You can choose between two options for menu color: COLOR and MONOCHROME.

Turning On / Off Source Display [INPUT DISPLAY]

This option turns on or off input name display such as HDMI1 to be displayed on the top right of the screen.

Turning messages on and off [MESSAGE DISPLAY]

This option selects whether or not to display projector messages at the bottom of the projected image. Even when "OFF" is selected, the security lock warning is displayed. The security lock warning turns off when the security lock is canceled.

Turning ON/OFF Control ID [ID DISPLAY]

This option turns on or off the ID number which is displayed when the ID SET button on the remote control is pressed. (→ page 111)

Selecting Menu Display Time [DISPLAY TIME]

This option allows you to select how long the projector waits after the last touch of a button to turn off the menu. The preset choices are [MANUAL], [AUTO 5 SEC], [AUTO 15 SEC], and [AUTO 45 SEC]. The [AUTO 45 SEC] is the factory preset.

[MENU(2)]

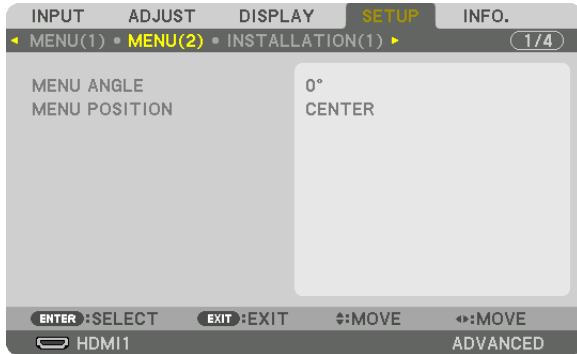

[MENU ANGLE]

Select the direction for displaying the menu.

[MENU POSITION]

Shift the menu displaying position. You can choose from 9 locations.

TIP

- The display position of the menu is saved even when the power supply of the projector is turned off.
- When you change the [MENU ANGLE], the display position of the menu returns to the original state when it was first shipped from the factory.
- Input terminal and message displaying position are not influenced by the [MENU POSITION].

[INSTALLATION(1)]

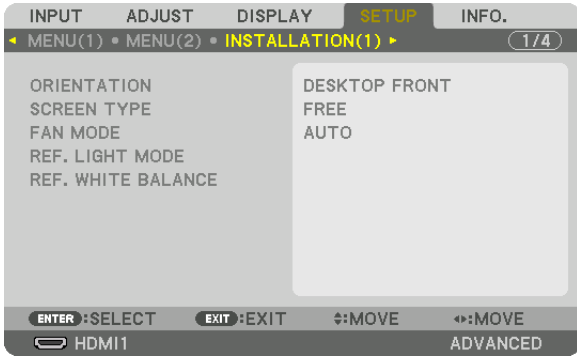

Selecting Projector Orientation [ORIENTATION]

This reorients your image for your type of projection. The options are: desktop front projection, ceiling rear projection, desktop rear projection, and ceiling front projection.

NOTE:

- Please consult the dealer if you require special installation services e.g. when mounting the projector to a ceiling. Never install the projector on your own. This may result in the projector falling down and causing injury to people.

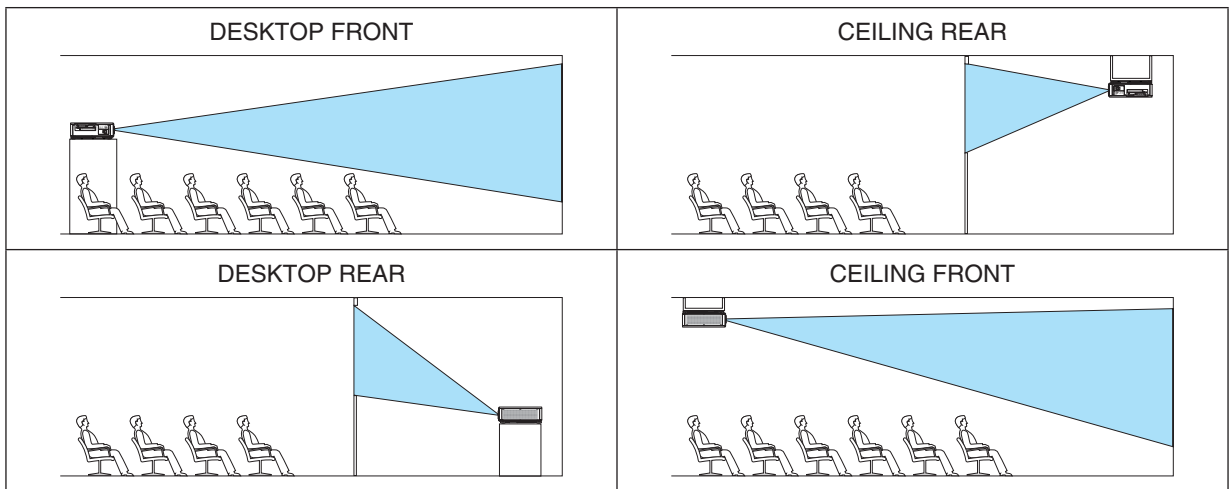

Selecting Aspect Ratio and Position for Screen [SCREEN TYPE]

Sets the aspect ratio of the projection screen.

- FREE..... The ratio of panel is selected. Select this when projecting 17:9 screen (4K).
- 4:3 SCREEN..... For a screen with a 4:3 aspect ratio
- 16:9 SCREEN..... For a screen with a 16:9 aspect ratio
- 16:10 SCREEN..... For a screen with a 16:10 aspect ratio

NOTE:

- After changing the screen type, check the setting of [ASPECT RATIO] in the menu. (→ page 88)

Selecting Fan Mode [FAN MODE]

Fan Mode is used to set the speed of the internal cooling fan.

- AUTO Standard mode supplying superior quietness.
- HIGH Output the maximum cooling power for prolong life of parts.

- If you use the projector continuously for several days, please make sure to set [HIGH] for [FAN MODE].

NOTE:

- Your setting will not be affected even when [RESET] is done from the menu.

[REF. LIGHT MODE]

Adjust this when you want to use the unit with a lower brightness or when you want to save energy (→ page 39). This can also be used to adjust the brightness between the different projectors when using a combination of multiple projectors.

REF. LIGHT MODE	NORMAL	The light module luminance (brightness) will become 100% and the screen will turn bright.
	ECO1	By controlling the brightness and fan speed according to the selected setting, energy can be saved and motion noise and the power consumption can be lowered. Can be selected when [CONSTANT BRIGHTNESS] mode is set to [OFF].
	ECO2	
REF. LIGHT ADJUST		Brightness can be adjusted in 1% increments from 20 to 100%.
CONSTANT BRIGHTNESS	OFF	[CONSTANT BRIGHTNESS] mode will be canceled.
	ON	Maintains the brightness that is in effect at the time [ON] is selected. Unless [OFF] is selected, the same settings will remain in effect even when the projector is turned off. <ul style="list-style-type: none"> • To re-adjust the brightness, first turn this setting OFF before making further adjustments. <p>NOTE:</p> <ul style="list-style-type: none"> • [CONSTANT BRIGHTNESS] mode is a function used to maintain the brightness at a constant level. Color will not be fixed.

TIP:

- When using multi-screen projection, it is recommended to adjust the brightness to a slightly lower level, then setting the [CONSTANT BRIGHTNESS] mode to [ON].

[REF. WHITE BALANCE]

This feature allows you to adjust the white balance for all signals. The white and black levels of the signal are adjusted for optimum color reproduction.

- CONTRAST R/CONTRAST G/CONTRAST B
..... These adjust the picture's white color.
- BRIGHTNESS R/BRIGHTNESS G/BRIGHTNESS B
..... These adjust the picture's black color.

[INSTALLATION(2)]

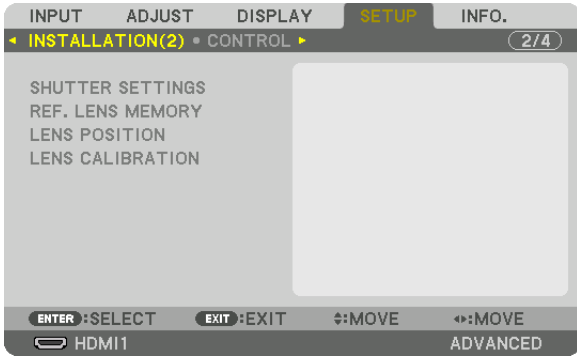

[SHUTTER SETTINGS]

Enabling and disabling the lens shutter function. You can also set how long the light will take to fade in and fade out when either the SHUTTER button.

POWER ON SHUT- TER	OPEN	When the power is turned on, the light source comes on and the picture is projected.
	CLOSE	The light source does not come on when the power is turned on. When the SHUTTER button is pressed, the shutter is released and the light source is turned on.
PICTURE MUTE SHUTTER	OPEN	The light source is still on when the picture is turned off for switching the input terminals.
	CLOSE	The light source turns off when the picture is turned off for switching the input terminals.
FADE IN TIME	Set how long the light will take to fade in after the SHUTTER button is pressed. The time can be set from 0 to 10 seconds in increments of 1 second.	
FADE OUT TIME	Set how long the light will take to fade out after the SHUTTER button is pressed. The time can be set from 0 to 10 seconds in increments of 1 second.	

Using the Reference Lens Memory [REF. LENS MEMORY]

This function serves to store the adjusted values common to all input sources when using the LENS SHIFT, ZOOM and FOCUS buttons of the projector or the remote control. The adjusted values stored in memory can be used as a reference to the current.

PROFILE Select a stored [PROFILE] number.

STORE Stores the current adjusted values in memory as a reference.

MOVE Applies the adjusted reference values stored in [STORE] to the current signal.

RESET..... Reset selected [PROFILE] number [REF. LENS MEMORY] to the factory default settings.

LOAD BY SIGNAL .. When you switch signals the lens will shift to the lens shift, zoom, and focus values for the selected [PROFILE] number.

If no adjusted values have been saved to [LENS MEMORY], the lens will apply [REF. LENS MEMORY] adjusted values. Alternatively, if no adjusted values have been saved to [REF. LENS MEMORY], the unit will return to factory default settings.

FORCED MUTE To turn off the image during lens shift, select [ON].

NOTE:

- Adjusted values in [REF. LENS MEMORY] will not be returned to default when performing [CURRENT SIGNAL] or [ALL DATA] for [RESET] from the menu.
 - To store adjusted values for each input source, use the Lens Memory function. (→ page 92)
-

[LENS POSITION]

Move the lens position.

HOME Set back the lens to the home position.

TYPE..... Select this for using the lens unit NP39ML-4K. The lens position will be adjusted to the appropriate position.

[LENS CALIBRATION]

The adjustment range of the zoom, focus, and shift of the [LENS MEMORY] is calibrated.

Be sure to carry out [LENS CALIBRATION] after replacing the lens.

Applicable lens unit: NP16FL-4K/NP17ZL-4K/NP18ZL-4K/NP19ZL-4K/NP20ZL-4K/NP21ZL-4K/NP31ZL-4K

[CONTROL]

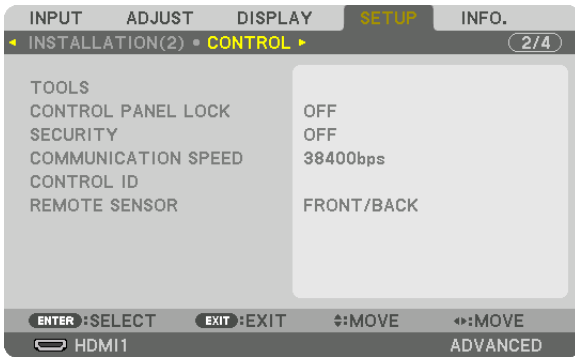

TOOLS

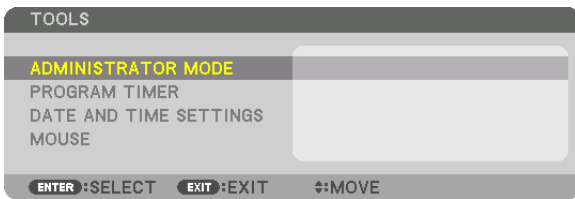

ADMINISTRATOR MODE

This allows you to select MENU MODE, save settings, and set a password for the administrator mode.

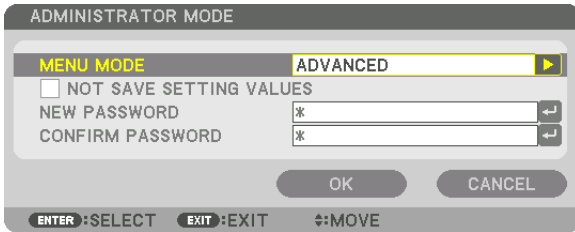

MENU MODE	Select either [BASIC] or [ADVANCED] menu. (→ page 72)	—
NOT SAVE SETTING VALUES	Placing a check mark will not save your projector settings. Clear this check box to save your projector settings.	—
NEW PASSWORD/CONFIRM PASSWORD	Assign a password for the administrator mode.	Up to 10 alphanumeric characters

PROGRAM TIMER

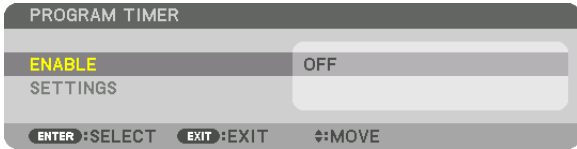

This option turns on/standby the projector and changes video signals automatically at a specified time.

NOTE:

- Before using [PROGRAM TIMER], make sure that the [DATE AND TIME] feature is set. (→ page 110)
 Make sure that the projector is in the standby condition with the POWER cable connected.
 The projector has a built-in clock. The clock will keep working for about a month after the main power is turned off. If the main power is not supplied to the projector for a month or more, it requires to set [DATE AND TIME SETTINGS] feature again.

Setting a new program timer

1. On the PROGRAM TIMER screen, use the ▲ or ▼ button to select [SETTINGS] and press the ENTER button.

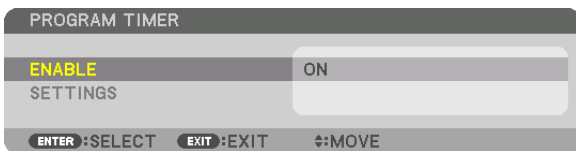

The [PROGRAM LIST] screen will be displayed.

2. Select a blank program number and press the ENTER button.

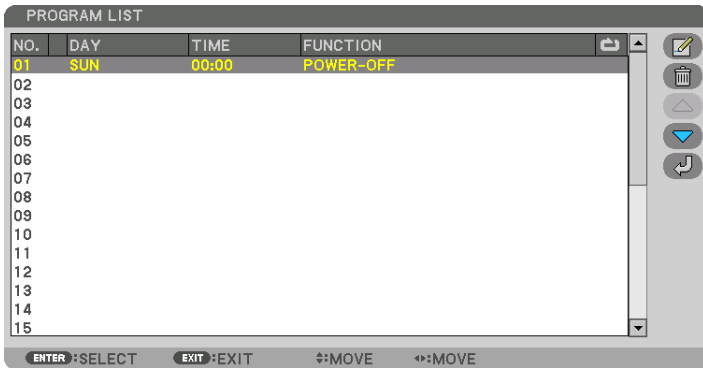

The [EDIT] screen will be displayed.

3. Make settings for each item as required.

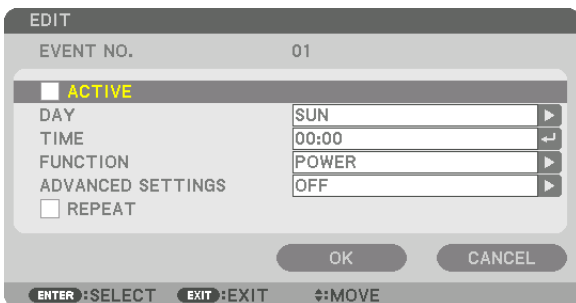

ACTIVE Place a check mark to enable the program.

DAY..... Select days of the week for the program timer. To execute the program from Monday to Friday, select [MON-FRI]. To execute the program in everyday basis, select [EVERYDAY].

TIME Set the time to execute the program. Enter time in 24-hour format.

FUNCTION Select a function to be executed. Selecting [POWER] will allow you to turn on or off the projector by setting [ADVANCED SETTINGS]. Selecting [INPUT] will allow you to select an input terminal by setting [ADVANCED SETTINGS]. Selecting [LIGHT MODE] will allow you to select [LIGHT MODE] by setting [ADVANCED SETTINGS].

ADVANCED SETTINGS

..... Select one option for the selected item in [FUNCTION].

REPEAT..... Place a check mark to repeat the program continuing basis. To use the program this week only, clear the check mark.

4. Select [OK] and press the ENTER button.

This will complete the settings.

You will be returned to the [PROGRAM LIST] screen.

5. Select [↶] (BACK) and press the ENTER button.

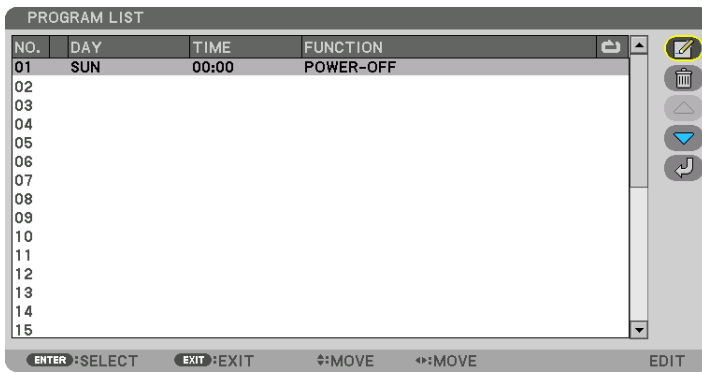

You will be returned to the [PROGRAM TIMER] screen.

6. Select [EXIT] and press the ENTER button.

You will be returned to the [TOOLS] screen.

NOTE:

- Up to 30 different timer settings can be programmed.
- The Program Timer is executed on a set time basis, not in a program basis.
- Once the program not marked with a check in [REPEAT] has been executed, the check mark in the [ACTIVE] check box will be cleared automatically and the program will be disabled.
- When the on-time and the off-time set for the same time, the off-time setting will take preference.
- When two different sources are set for the same time, the larger program number will take preference.
- The on-time setting will not be executed while the cooling fans are running or an error is occurring.
- If the off-time setting is expired under the condition in which the power off is not possible, the off-timer setting will not be executed until the power off becomes possible.
- Programs not marked with a check mark in [ACTIVE] of the [EDIT] screen will not be executed even if the Program Timer is enabled.
- When the projector is turned on by using the program timer and if you want to turn off the projector, set the off-time or do it manually so as not to leave the projector on for a long period of time.

Activating the program timer

1. Select **[ENABLE]** on the **[PROGRAM TIMER]** screen and press the **ENTER** button.

The selection screen will be displayed.

2. Press the **▼** button to align the cursor with **[ON]** and then press the **ENTER** button.

Return to the [PROGRAM TIMER] screen.

NOTE:

- When the effective settings of the **[PROGRAM TIMER]** have not been set to **[ON]**, the program will not be executed even if the **[ACTIVE]** items in the program list have been ticked.
 - Even when the effective settings of the **[PROGRAM TIMER]** are set to **[ON]**, the **[PROGRAM TIMER]** will not work until the **[PROGRAM TIMER]** screen is closed.
-

Editing the programmed settings

1. On the **[PROGRAM LIST]** screen, select a program you want to edit and press the **ENTER** button.

2. Change the settings on the **[EDIT]** screen.

3. Select **[OK]** and press the **ENTER** button.

The programmed settings will be changed.

You will be returned to the [PROGRAM LIST] screen.

Changing the order of programs

1. On the **[PROGRAM LIST]** screen, select a program whose order you want to change and press the **►** button.

2. Press the **▼** button to select **▲** or **▼**.

3. Press the **ENTER** button a few times to select a row to which you wish to move the program.

The order of the programs will be changed.

Deleting the programs

1. On the **[PROGRAM LIST]** screen, select a program number you want to delete and press the **►** button.

2. Press the **▼** button to select **[ (DELETE)]**.

3. Press the **ENTER** button.

The confirmation screen will be displayed.

4. Select **[YES]** and press the **ENTER** button.

The program will be deleted.

This will complete deleting the program.

DATE AND TIME SETTINGS

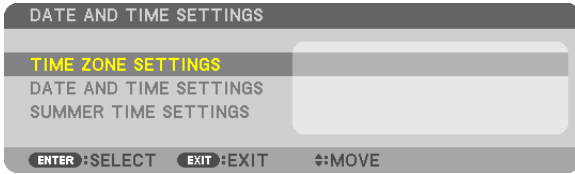

You can set the current time, month, date, and year.

NOTE:

- The projector has a built-in clock. The clock will keep working for about a month after the main power is turned off. If the main power is off for a month or more, the built-in clock will cease. If the built-in clock ceases, set the date and time again. The built-in clock will not cease while in the standby mode. In order to activate the built-in clock continuously even when the projector is not used, leave it in the standby state not plugging off the power cable.

TIME ZONE SETTINGS..... Select your time zone.

DATE AND TIME SETTINGS Set your current date (MM/DD/YYYY) and time (HH:MM).

INTERNET TIME SERVER: If you place a check mark, the projector’s built-in clock will be synchronized with an Internet time server in every 24 hours and at the time of projector’s startup.

UPDATE: Synchronizes the projector’s built-in clock immediately. The UPDATE button is not available unless the INTERNET TIME SERVER check box is turned on.

SUMMER TIME SETTINGS If you place a check mark, the clock for daylight saving will be enabled.

Disabling the Cabinet Buttons [CONTROL PANEL LOCK]

This option turns on or off the CONTROL PANEL LOCK function.

NOTE:

- How to cancel the [CONTROL PANEL LOCK]
When the [CONTROL PANEL LOCK] is set to [ON], press the EXIT button on the cabinet for 1 second or longer to cancel the [CONTROL PANEL LOCK] setting.

TIP:

- When the [CONTROL PANEL LOCK] is turned on, a key lock icon [] will be displayed at the bottom right of the menu.
- This CONTROL PANEL LOCK does not affect the remote control functions.

Enabling Security [SECURITY]

This feature turns on or off the SECURITY function.

Unless the correct keyword is entered, the projector cannot project an image. (→ page 46)

NOTE:

- Your setting will not be affected even when [RESET] is done from the menu.

Selecting Communication Speed [COMMUNICATION SPEED]

This feature sets the communication speed for the PC Control port (D-Sub 9P). Make sure to set the appropriate speed for the device to connect.

NOTE:

- Select [38400bps] or less when using our utility software “NaViSet Administrator 2”.
- Your selected communication speed will not be affected even when [RESET] is done from the menu.

Setting ID to the Projector [CONTROL ID]

You can operate multiple projectors separately and independently with the single remote control that has the CONTROL ID function. If you assign the same ID to all the projectors, you can conveniently operate all the projectors together using the single remote control. To do so, you have to assign an ID number to each projector.

CONTROL ID NUMBER Select a number from 1 to 254 you wish to assign to your projector.

CONTROL ID Select [OFF] to turn off the CONTROL ID setting and select [ON] to turn on the CONTROL ID setting.

NOTE:

- When [ON] is selected for [CONTROL ID], the projector cannot be operated by using the remote control that does not support the CONTROL ID function. (In this case the buttons on the projector cabinet can be used.)
- Your setting will not be affected even when [RESET] is done from the menu.
- Pressing and holding the ENTER button on the projector cabinet for 10 seconds will display the menu for canceling the Control ID.

Assigning or Changing the Control ID

1. Turn on the projector.

2. Press the ID SET button on the remote control.

The CONTROL ID screen will be displayed.



If the projector can be operated with the current remote control ID, the [ACTIVE] will be displayed. If the projector cannot be operated with the current remote control ID, the [INACTIVE] will be displayed. To operate the inactive projector, assign the control ID used for the projector by using the following procedure (Step 3).

3. Press one of numeric keypad buttons while pressing and holding the ID SET button on the remote control.

Example:

To assign “3”, press the “3” button on the remote control.

No ID means that all the projectors can be operated together with a single remote control. To set “No ID”, enter “000” or press the CLEAR button.

TIP: The range of IDs is from 1 to 254.

4. Release the ID SET button.

The updated CONTROL ID screen will be displayed.

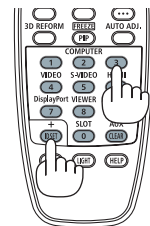

NOTE:

- The IDs can be cleared in a few days after the batteries are run down or removed.
- Accidentally pressing any one of the buttons of the remote control will clear currently specified ID with batteries removed.

Turning On or Off Remote Sensor [REMOTE SENSOR]

This option determines which remote sensor on the projector is enabled in wireless mode. The options are: FRONT/BACK, FRONT, BACK, and HDBaseT*.

NOTE:

- *The remote control of the projector will not be able to receive signals if the power supply of the HDBaseT transmission device connected to the projector is switched on when this has been set to "HDBaseT".*
-

TIP:

- *If the remote control system does not function when direct sunlight or strong illumination strikes the remote control sensor of the projector, change to other option.*

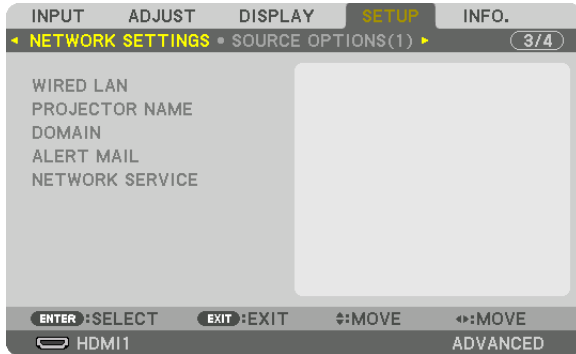
[NETWORK SETTINGS]*Important:*

- Consult with your network administrator about these settings.
- When using a wired LAN, connect the Ethernet cable (LAN cable) to the LAN port on the projector. (→ page 9)
- Please use a shielded twisted pair (STP) cable of Category 5e or higher for the LAN cable (sold commercially).

TIP:

- The network settings you make will not be affected even when [RESET] is done from the menu.

Hints on How to Set Up LAN Connection**To set up the projector for a LAN connection:**

Select [WIRED LAN] → [PROFILES] → [PROFILE 1] or [PROFILE 2].

Two settings can be set for wired LAN.

Next turn on or off for [DHCP], [IP ADDRESS], [SUBNET MASK], and [GATEWAY] and select [OK] and press the ENTER button. (→ page 114)

To recall LAN settings stored in the profile number:

Select [PROFILE 1] or [PROFILE 2] for wired LAN, and then select [OK] and press the ENTER button. (→ page 114)

To connect a DHCP server:

Turn on [DHCP] for wired LAN. Select [ON] and press the ENTER button. To specify IP address without using the DHCP server, turn off [DHCP]. (→ page 114)

To receive error messages via e-mail:

Select [ALERT MAIL], and set [SENDER'S ADDRESS], [SMTP SERVER NAME], and [RECIPIENT'S ADDRESS]. Last, select [OK] and press the ENTER button. (→ page 116)

WIRED LAN

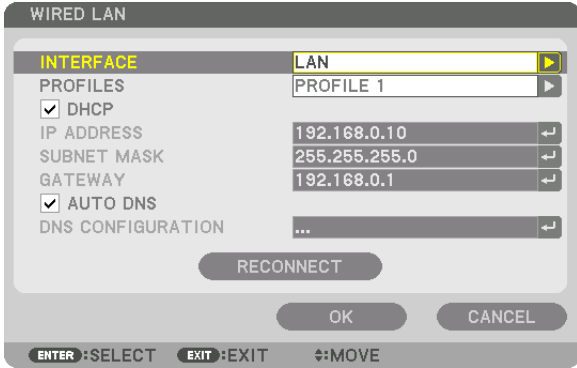

INTERFACE	Select [LAN] for using the LAN port for connecting to the wired LAN. Select [HDBaseT] for using the HDBaseT port for connecting to the wired LAN. The control from the connected device will be disabled if no signal is sent and received for three minutes if the projector is connected to wired LAN thru the HDBaseT. For refusing this, set the standby mode to [SLEEP] in advance.	—
PROFILES	<ul style="list-style-type: none"> The settings for the wired LAN can be recorded in the projector memory in two ways. Select [PROFILE 1] or [PROFILE 2] and then do settings for [DHCP] and the other options. After doing this, select [OK] and press the ENTER button. This will store your settings in memory. To recall the settings from memory: After selecting [PROFILE 1] or [PROFILE 2] from the [PROFILES] list. Select [OK] and press the ENTER button. Select [DISABLE] when not connecting to a wired LAN 	—
DHCP	Place a check mark to automatically assign an IP address to the projector from your DHCP server. Clear this check box to register the IP address or subnet mask number obtained from your network administrator.	—
IP ADDRESS	Set your IP address of the network connected to the projector when [DHCP] is turned off.	Up to 12 numeric characters
SUBNET MASK	Set your subnet mask number of the network connected to the projector when [DHCP] is turned off.	Up to 12 numeric characters
GATEWAY	Set the default gateway of the network connected to the projector when [DHCP] is turned off.	Up to 12 numeric characters
AUTO DNS	Place a check mark to automatically assign the IP address of your DNS server connected to the projector from your DHCP server. Clear this check box to set the IP address of your DNS server connected to the projector.	Up to 12 numeric characters
DNS CONFIGURATION	Set the IP address of your DNS server on the network connected to the projector when [AUTO DNS] is cleared.	Up to 12 numeric characters
RECONNECT	Retry to connect the projector to a network. Try this if you have changed [PROFILES].	—

PROJECTOR NAME

PROJECTOR NAME	Set a unique projector name.	Up to 16 alphanumeric characters and symbols
----------------	------------------------------	--

DOMAIN

Set a host name and domain name of the projector.

HOST NAME	Set a host name of the projector.	Up to 16 alphanumeric characters
DOMAIN NAME	Set a domain name of the projector.	Up to 60 alphanumeric characters

ALERT MAIL

ALERT MAIL	<p>This option will notify your computer of error messages via e-mail when using wireless or wired LAN. Placing a checkmark will turn on the Alert Mail feature. Clearing a checkmark will turn off the Alert Mail feature.</p> <p>Sample of a message to be sent from the projector:</p> <div style="border: 1px solid black; padding: 5px;"> <p>Subject: [Projector] Projector Information THE COOLING FAN HAS STOPPED. [INFORMATION] PROJECTOR NAME: xxxxx LIGHT HOURS USED: xxx[H]</p> </div>	—
HOST NAME	Type in a host name.	Up to 16 alphanumeric characters
DOMAIN NAME	Type in a domain name of the network connected to the projector.	Up to 60 alphanumeric characters
SENDER'S ADDRESS	Specify the sender's address.	Up to 60 alphanumeric characters and symbols
SMTP SERVER NAME	Type in the SMTP server name to be connected to the projector.	Up to 60 alphanumeric characters
RECIPIENT'S ADDRESS 1, 2, 3	Type in your recipient's address.	Up to 60 alphanumeric characters and symbols
TEST MAIL	<p>Send a test mail to check if your settings are correct.</p> <p><i>NOTE:</i></p> <ul style="list-style-type: none"> • If you entered an incorrect address in a test, you may not receive an Alert mail. Should this happen, check if the Recipient's Address is correctly set. • Unless any one of the [SENDER'S ADDRESS], [SMTP SERVER'S NAME] or [RECIPIENT'S ADDRESS 1-3] is selected, [TEST MAIL] is not available. • Be sure to highlight [OK] and press the ENTER button before executing [TEST MAIL]. 	—

NETWORK SERVICE

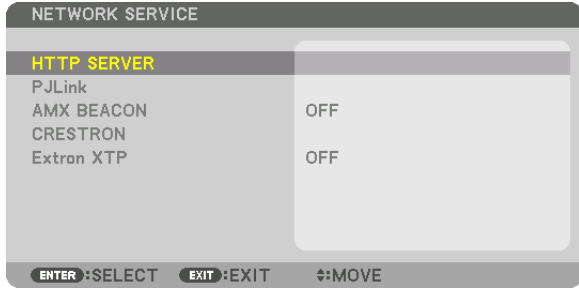

HTTP SERVER	Set a password for your HTTP server.	Up to 10 alphanumeric characters
PJLink	<p>Configure the settings for using PJLink. PASSWORD..... Set the password. CLASS To use functions with PJLink Class 2 specifications, set [CLASS 2]. DESTINATION When the CLASS is set to "CLASS 2", input the IP address of the destination.</p> <hr/> <p><i>NOTE:</i></p> <ul style="list-style-type: none"> • Do not forget your password. However, if you forget your password, consult with your dealer. • What is PJLink? <i>PJLink is a standardization of protocol used for controlling projectors of different manufacturers. This standard protocol is established by Japan Business Machine and Information System Industries Association (JBMA) in 2005. The projector supports all the commands of PJLink Class 1.</i> • Setting of PJLink will not be affected even when [RESET] is done from the menu. 	Up to 32 alphanumeric characters
AMX BEACON	<p>Turn on or off for detection from AMX Device Discovery when connecting to the network supported by AMX's NetLinX control system.</p> <p><i>TIP:</i></p> <ul style="list-style-type: none"> • When using a device that supports AMX Device Discovery, all AMX NetLinX control system will recognize the device and download the appropriate Device Discovery Module from an AMX server. <p>Placing a checkmark will enable detecting the projector from AMX Device Discovery. Clearing a checkmark will disable detecting the projector from AMX Device Discovery.</p>	—
CRESTRON	<p>ROOMVIEW: Turn on or off when controlling the projector from your PC. CRESTRON CONTROL: Turn on or off when controlling the projector from your controller.</p> <ul style="list-style-type: none"> • CONTROLLER IP ADDRESS: Enter your IP address of CRESTRON SERVER. • IP ID: Enter your IP ID of CRESTRON SERVER. 	Up to 12 numeric characters
Extron XTP	Set for connecting this projector to the Extron XTP transmitter. ON will enable to connect with the XTP transmitter. OFF will disable to connect with the XTP transmitter.	—

*TIP: The CRESTRON settings are required only for use with CRESTRON ROOMVIEW.
 For more information, visit <http://www.crestron.com>*

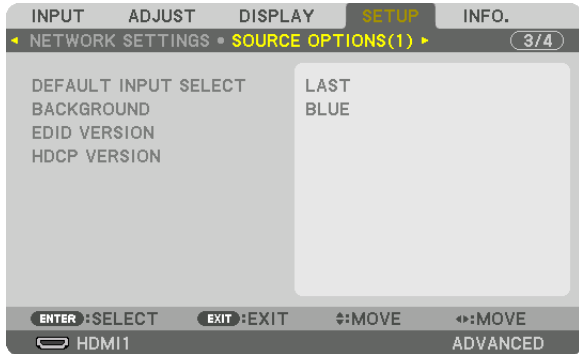
[SOURCE OPTIONS(1)]**Selecting Default Source [DEFAULT INPUT SELECT]**

You can set the projector to default to any one of its inputs each time the projector is turned on.

- LAST Sets the projector to default to the previous or last active input each time the projector is turned on.
- AUTO Searches for an active source in order of HDMI1 → HDMI2 → DisplayPort1 → DisplayPort2 → HDBaseT → SDI1 → SDI2 → SDI3 → SDI4 → SLOT and displays the first found source.
- HDMI1 Displays the digital source from the HDMI 1 IN connector every time the projector is turned on.
- HDMI2 Displays the digital source from the HDMI 2 IN connector every time the projector is turned on.
- DisplayPort1 Displays the digital source from the DisplayPort1 IN connector every time the projector is turned on.
- DisplayPort2 Displays the digital source from the DisplayPort2 IN connector every time the projector is turned on.
- HDBaseT Project the HDBaseT signal.
- SDI1 Displays the digital source from the SDI1 IN terminal every time the projector is turned on.
- SDI2 Displays the digital source from the SDI2 IN terminal every time the projector is turned on.
- SDI3 Displays the digital source from the SDI3 IN terminal every time the projector is turned on.
- SDI4 Displays the digital source from the SDI4 IN terminal every time the projector is turned on.
- SLOT Displays the picture via the optional board (sold separately) inserted into the SLOT.

Selecting a Color or Logo for Background [BACKGROUND]

Use this feature to display a blue/black screen or logo when no signal is available. The default background is [BLUE].

NOTE:

- To change the image displayed as the logo, see page 153.

[EDID VERSION]

Switch the EDID version for the HDMI 1 IN and HDMI 2 IN terminals.

MODE1 Supports general signal

MODE2 Supports 4K signal

Select this mode for displaying 4K image using the device supporting 4K

NOTE:

- *If image and sound can not be output in [MODE2], switch to [MODE1].*
-

[HDCP VERSION]

Switch the HDCP version for the HDMI 1 IN, HDMI 2 IN and HDBaseT IN/Ethernet terminals.

HDCP2.2 Automatically switch the mode HDCP2.2 and HDCP1.4

HDCP1.4 Forcedly perform transmission with HDCP1.4

[POWER OPTIONS]

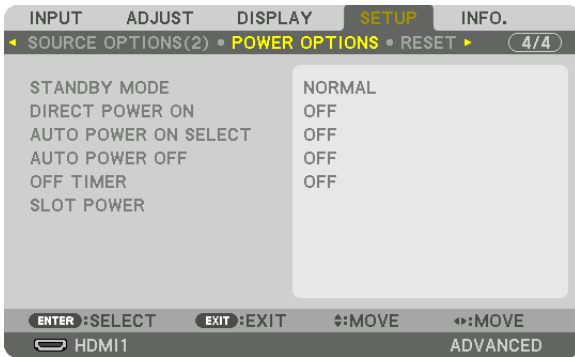

[STANDBY MODE]

Select the standby setting after turning off the power supply of the unit.

- NORMAL..... Automatically transit the standby state and control consumption power based on the projector setting and the state of the connected device. (→ page 157)
- SLEEP Maintain the state of sleep. Consumption power becomes higher than the setting of NORMAL. Select this when a commercially available HDBaseT compatible transmission device is always connected to the HDBaseT port for use.

TIP:

- The [STANDBY MODE] setting is not changed by [RESET].
- Consumption power in the STANDBY MODE is excluded from the calculation for carbon saving.

Enabling Direct Power On [DIRECT POWER ON]

Turns the projector on automatically when the power cable is inserted into an active power outlet. This eliminates the need to always use the POWER button on the remote control or projector cabinet.

Turning On the Projector by Detecting Input Signal [AUTO POWER ON SELECT]

Under the state of standby, the projector automatically detects and projects synchronizing signal input from the selected terminals by this function.

- OFF AUTO POWER ON SELECT function becomes inactive.
- HDMI1, HDMI2, DisplayPort1, DisplayPort2, HDBaseT, SDI1, SDI2, SDI3, SDI4, SLOT
..... When the projector detects the computer signal input from the selected terminal, automatically it will be turned ON and will project the computer screen.

NOTE:

- If you want to activate this AUTO POWER ON SELECT function after powering OFF the projector, interrupt signal from input terminals or pull out the computer cable from the projector and wait for over 3 seconds and then input signal from the selected terminal.
- The HDBaseT port, SDI 1 / SDI 2 / SDI 3 / SDI 4 IN terminal and SLOT can be used only when the unit is in the sleep mode. (→ page 157)

Enabling Power Management [AUTO POWER OFF]

When this option is selected you can enable the projector to automatically turn off (at the selected time: 0:05, 0:10, 0:15, 0:20, 0:30, 1:00) if there is no signal received by any input or if no operation is performed.

Using Off Timer [OFF TIMER]

1. **Select your desired time between 30 minutes and 16 hours: OFF, 0:30, 1:00, 2:00, 4:00, 8:00, 12:00, 16:00.**
2. **Press the ENTER button on the remote control.**
3. **The remaining time starts counting down and it is displayed at the bottom of the On-Screen Menu.**
4. **The projector will turn off after the countdown is complete.**

NOTE:

- *To cancel the preset time, set [OFF] for the preset time or turn off the power.*
 - *When the remaining time reaches 3 minutes before the projector is turned off, the [THE PROJECTOR WILL TURN OFF WITHIN 3 MINUTES] message will be displayed on the bottom of the screen.*
-

Setting for the Optional Board [SLOT POWER]

When using the optional board installed in the slot, set the following options.

PROJECTOR ON This feature will turn on or off the power to the optional board.

OFF: Forcibly turn off the power to the optional board installed in the slot.

ON: Turn on the power to the optional board installed in the slot.

PROJECTOR STANDBY

..... This feature will automatically enable or disable the optional board installed in the slot when the projector is in standby.

DISABLE: Select this option to disable the optional board in the projector standby.

ENABLE: Select this option to enable the optional board in the projector standby.

Returning to Factory Default [RESET]

The RESET feature allows you to change adjustments and settings to the factory preset for a (all) source (s) except the following:

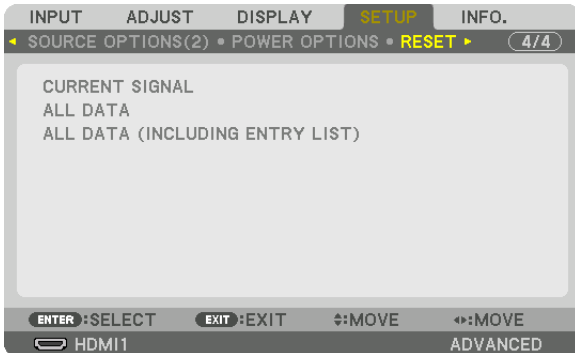

[CURRENT SIGNAL]

Resets the adjustments for the current signal to the factory preset levels.

The items that can be reset are: [PRESET], [CONTRAST], [BRIGHTNESS], [COLOR], [HUE], [SHARPNESS], [ASPECT RATIO], [HORIZONTAL], [VERTICAL], [CLOCK], [PHASE], and [OVERSCAN].

[ALL DATA]

Reset all the adjustments and settings for all the signals to the factory preset.

All items can be reset **EXCEPT** [ENTRY LIST], [GEOMETRIC CORRECTION], [EDGE BLENDING], [PICTURE SETTING], [LANGUAGE], [SCREEN TYPE], [FAN MODE], [REF. WHITE BALANCE], [REF. LENS MEMORY], [ADMINISTRATOR MODE], [DATE AND TIME SETTINGS], [CONTROL PANEL LOCK], [SECURITY], [COMMUNICATION SPEED], [CONTROL ID], [NETWORK SETTINGS], [BACKGROUND], [EDID VERSION], [HDCP VERSION], [OFF TIMER], [LIGHT HOURS USED].

[ALL DATA (INCLUDING ENTRY LIST)]

Reset all the adjustments and settings for all the signals including the [ENTRY LIST] to the factory preset except [GEOMETRIC CORRECTION], [EDGE BLENDING], [PICTURE SETTING], [LANGUAGE], [SCREEN TYPE], [FAN MODE], [REF. WHITE BALANCE], [REF. LENS MEMORY], [ADMINISTRATOR MODE], [DATE AND TIME SETTINGS], [CONTROL PANEL LOCK], [SECURITY], [COMMUNICATION SPEED], [CONTROL ID], [NETWORK SETTINGS], [BACKGROUND], [EDID VERSION], [HDCP VERSION], [OFF TIMER], [LIGHT HOURS USED].

Also deletes all the signals in the [ENTRY LIST] and returns to the factory preset.

NOTE:

- Locked signals in Entry List cannot be reset.
-

8 Menu Descriptions & Functions [INFO.]

Displays the status of the current signal and light module usage. This item has ten pages. The information included is as follows:

TIP:

- Pressing the **HELP** button on the remote control will show the [INFO.] menu items.

[USAGE TIME]

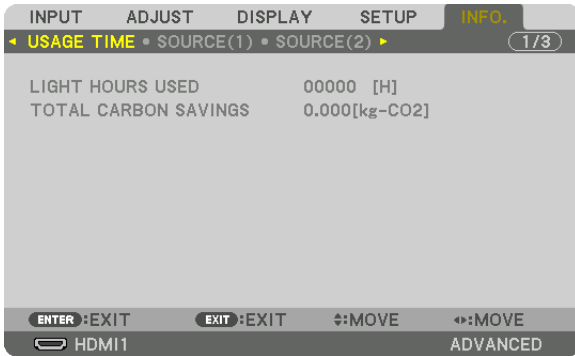

[LIGHT HOURS USED] (H)

[TOTAL CARBON SAVINGS] (kg-CO2)

- [TOTAL CARBON SAVINGS]

This displays the estimated carbon saving information in kg. The carbon footprint factor in the carbon saving calculation is based on the OECD (2008 Edition). (→ page 42)

[SOURCE(1)]



INPUT TERMINAL
HORIZONTAL FREQUENCY
SYNC POLARITY
SOURCE NAME

RESOLUTION
VERTICAL FREQUENCY
SCAN TYPE
ENTRY NO.

[SOURCE(2)]

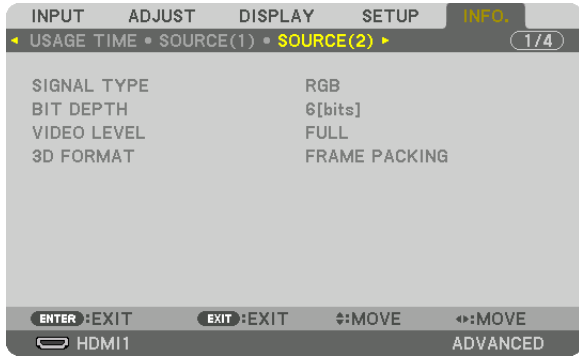

SIGNAL TYPE
VIDEO LEVEL

BIT DEPTH

[WIRED LAN]

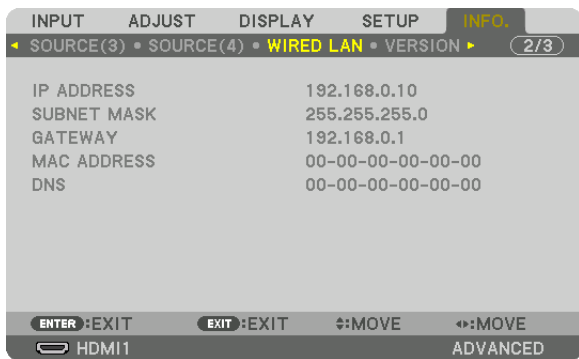

IP ADDRESS
GATEWAY
DNS

SUBNET MASK
MAC ADDRESS

[VERSION]



FIRMWARE
FIRMWARE2

DATA

[OTHERS]

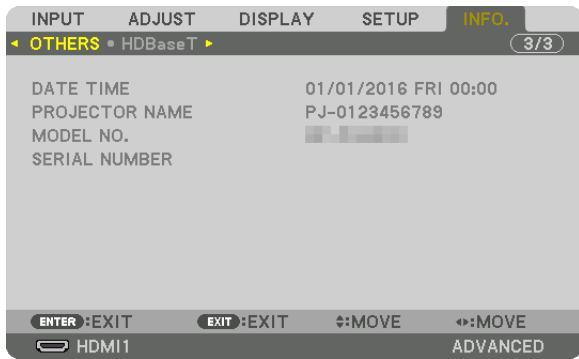

DATE TIME
MODEL NO.

PROJECTOR NAME
SERIAL NUMBER

[HDBaseT]

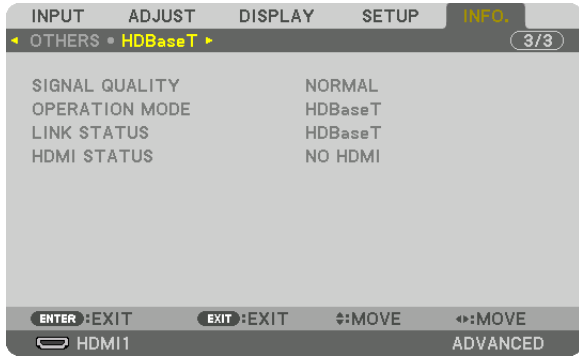

SIGNAL QUALITY
LINK STATUS

OPERATION MODE
HDMI STATUS

6. Installation and Connections

① Mounting a lens (sold separately)

This projector can be used with 8 kinds of optional lenses (sold separately). The descriptions here are for the NP18ZL-4K (standard zoom) lens. Mount other lenses in the same manner. See page 147 for lens options.

Important:

- For using the following option lenses, be sure to carry out [LENS CALIBRATION] after replacing the lens. (→ page 17, 105)

The following lenses need calibration:

NP16FL-4K, NP17ZL-4K, NP18ZL-4K, NP19ZL-4K, NP20ZL-4K, NP21ZL-4K, NP31ZL-4K

WARNING

(1) Turn off the power and wait for the cooling fan to stop, (2) turn off the main power switch, (3) disconnect the power cord and wait for the unit to cool before mounting or removing the lens. Failure to do so can result in eye injury, electric shock, or burn injuries.

NOTE:

- The projector and lenses are made of precision parts. Do not subject them to shock or excessive forces.
- Remove the separately sold lens when moving the projector. If not, the lens could be subject to shock while the projector is being moved, damaging the lens and the lens shift mechanism.
- When dismantling the lens from the projector, return the lens position to the home position before turning off the power. Failure to do so may prevent the lens from being mounted or dismantled because of narrow space between the projector and the lens.
- Never touch the lens surface while the projector is operating.
- Be very careful not to let dirt, grease, etc., on the lens surface and not to scratch the lens surface.
- Perform these operations on a flat surface over a piece of cloth, etc., to prevent the lens from getting scratched.
- When leaving the lens off the projector for long periods of time, mount the dust cap on the projector to prevent dust or dirt from getting inside. If the lens remains detached from the projector for long periods of time, dust may collect within the optical unit and damage the lens, causing deterioration of projected image.
- Lenses other than specified in this manual cannot be mounted on this projector.

Mounting the lens

1. Remove the dust cap from the projector.

Push the tongue at the top left outward and pull the knob at the center of the cap.

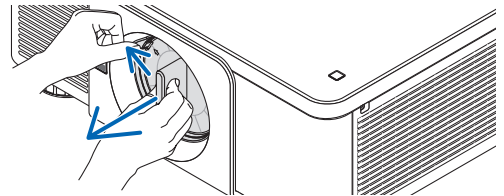

2. Remove the lens cap on the back of the lens.

- The lens NP18ZL-4K is used as an example.

NOTE:

- Make sure to remove the lens cap at the unit back side. If the lens unit with the lens cap remaining on is installed on the projector, it may cause of malfunction.

3. Hold the lens unit aligning the labelled arrow on the unit coming top and insert the unit to the projector.

Insert the lens slowly all the way in, keeping the positioning slit at the same angle.

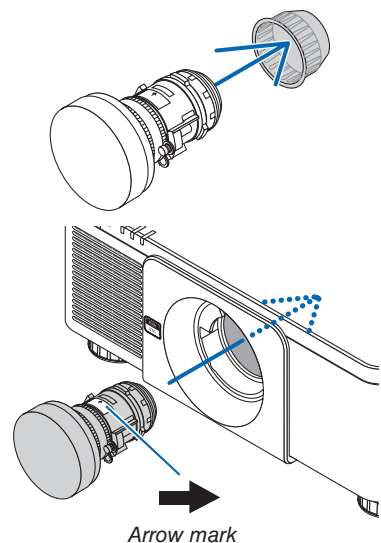

6. Installation and Connections

4. Turn the lens unit rightward until click is heard.

The lens is now fastened onto the projector.

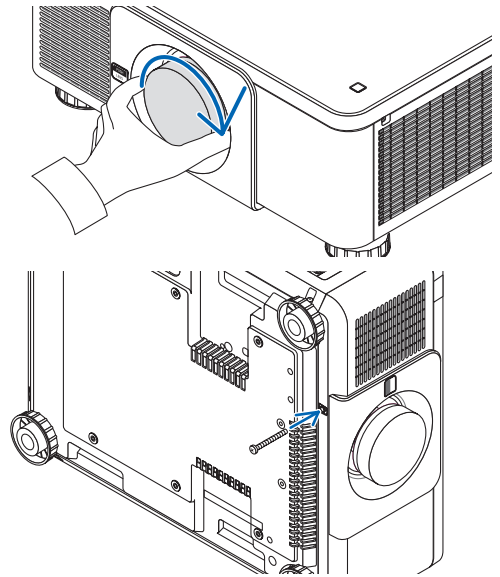

TIP:

- **Mounting the lens theft prevention screw**
Fasten the lens theft prevention screw included with the projector to the bottom of the projector so that the lens cannot be removed easily.

Removing the lens

Before removing the lens:

1. Turn on the projector and display an image. (→ page 16)
2. Press and hold the **SHIFT/HOME** button over 2 seconds.
The lens position will be moved to the home position.
3. Turn off the main power switch, and then unplug the power cord.
4. Wait until the projector cabinet is cool enough to handle.

1. While pressing the **LENS** release button on the projector's front panel fully in, turn the lens counterclockwise.

The lens comes off.

NOTE:

- If the lens cannot be removed when the **LENS** release button is pressed, check whether the lens theft prevention screw is mounted.

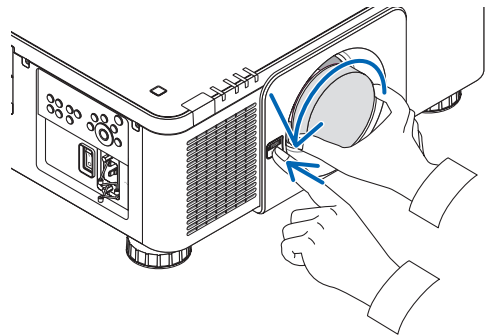

2. After slowly pulling the lens off the projector, release the **LENS** release button.

- After removing the lens, mount the lens caps (front and back) included with the lens before storing the lens.
- If no lens is going to be mounted on the projector, mount the dust cap included with the projector.

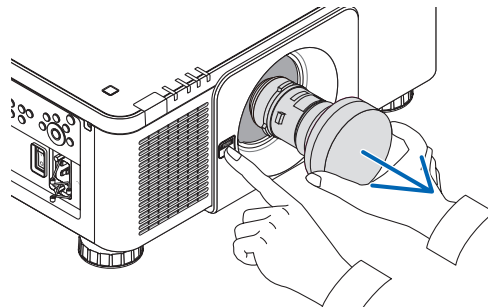

② Connecting to Other Equipment

Below is an example of connections to external equipment.

No connection cables are included with this unit. Use the appropriate cables for the connections.

⚠ CAUTION

For HDMI, DisplayPort, BNC and LAN, please use a shielded cable.
Use of other cables may cause interference with radio and television reception.

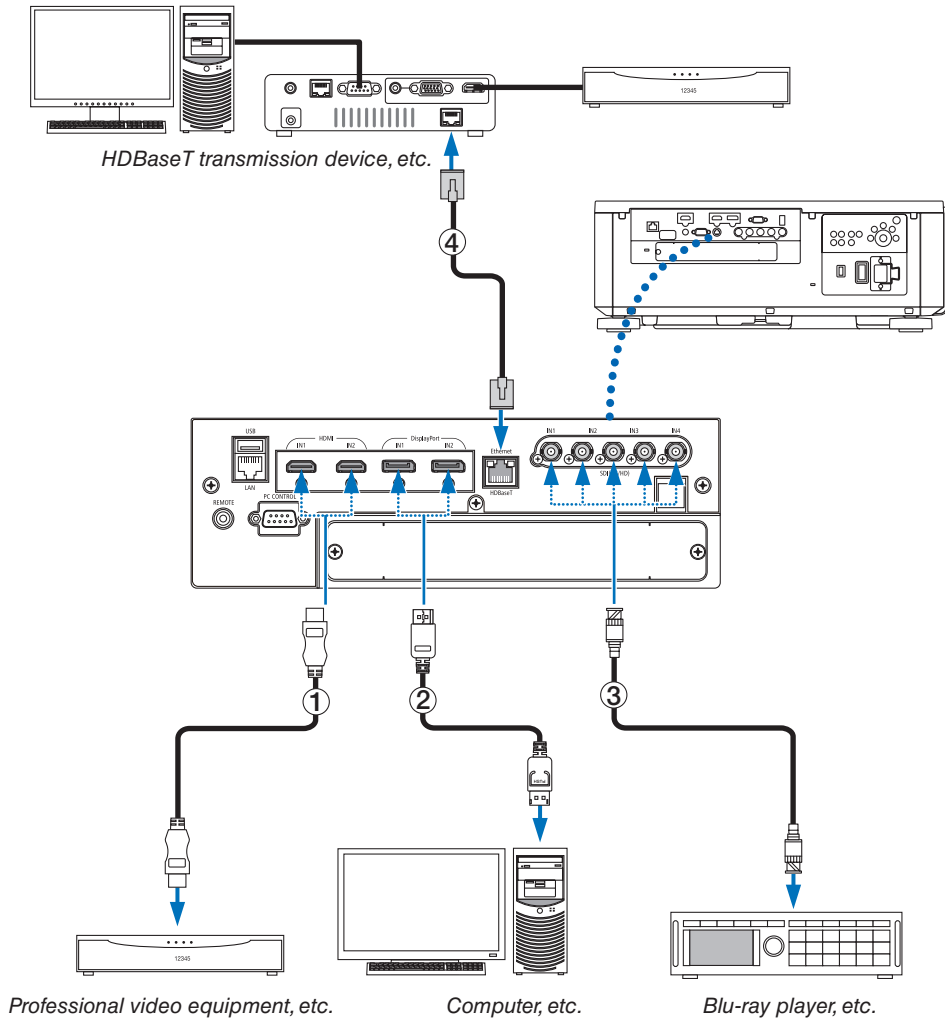

① HDMI cable (not supplied)

- Use a certified High Speed HDMI® Cable or High Speed HDMI® Cable with Ethernet.
- When connecting the HDMI 1 IN or HDMI 2 IN connector of the projector to the Blu-ray player, the projector's video level can be made settings in accordance with the Blu-ray player's video level. In the menu select [ADJUST] → [VIDEO] → [VIDEO LEVEL] and make necessary settings.

② DisplayPort cable (not supplied)

- Use a certified DisplayPort cable.



③ BNC cable (not supplied)

- Use cables that are 5C-FB or higher (5C-FB, 7C-FB, etc.) or Belden 1694A or higher. In addition, use cables with a cable length 100m or less.
- The length of cables that can be used may differ, depending on the signal.

④ LAN cable (not supplied)

- Please use a shielded twisted pair (STP) cable of Category 5e or higher for the LAN cable (sold commercially).
- The HDBaseT port of the projector supports HDMI signals (HDCP) from transmission devices, control signals from external devices (serial, LAN) and remote control signals (IR commands).
- The maximum transmission distance over the LAN cable is 100 m. (the maximum distance is 70 m for a 4K signal)
- Please do not use other transmission equipment between the projector and transmission equipment. The picture quality may be degraded as a result.
- This projector is not guaranteed to work with all HDBaseT transmission devices sold commercially.

After turning on the power of the unit, select the input according to the connection terminal.

Input connector	Button on the projector cabinet	Button on the remote control	Note
HDMI1/2 IN	HDMI 1/2	HDMI	Switches between HDMI1 and HDMI2 each time it is pressed.
DisplayPort 1/2 IN	DisplayPort 1/2	DisplayPort	Switches between DisplayPort1 and DisplayPort2 each time it is pressed.
SDI 1/2/3/4 IN	SDI	AUX	Switches between SDI1, SDI2, SDI3 and SDI4 each time it is pressed.
HDBaseT	HDBaseT/SLOT	NETWORK	Each time the button of the projector cabinet is pressed, the mode switches between HDBaseT and SLOT.

③ Portrait projection (vertical orientation)

This projector can be installed vertically to display computer images in portrait orientation.

The menu displaying position can be shifted by selecting the [SETUP] → [MENU(2)] → [MENU ANGLE].

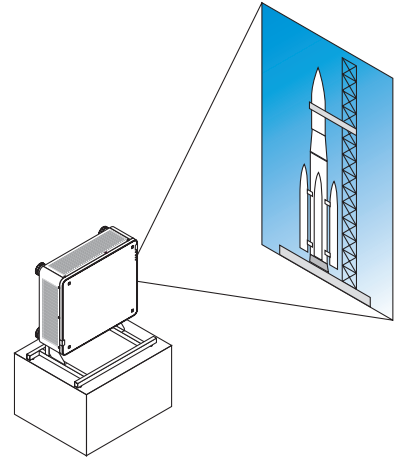

Precautions during installation

- Please do not install the projector in a vertical orientation on top of the floor or table on its own. If not, the projector may fall over, resulting in injury, damage or malfunction.
- A stand for supporting the projector needs to be made for this purpose to keep intake air flow securely and preventive measure of falling over. The stand must be designed such that the center of gravity of the projector is located well within the legs of the stand. If not, the projector may fall over and result in injury, damage and malfunction.
- If the projector is installed on which the intake vent facing down, optical part life may be shorten.

Design and manufacturing conditions for the stand

Please hire an installation service provider (for a fee) for the design and manufacture of a customized stand to be used for portrait projection. Please ensure that the design complies with the following conditions:

- There are 3 ventilation holes at the bottom of the projector. These holes should remain unobstructed.
- Use the 6 screw holes at the back of the projector to secure it to the stand.
Screw hole center dimension: 300×300 (pitch = 150) mm
Screw hole dimension on the projector: M4 with the maximum depth 16 mm
4 of the legs can be unscrewed for removal.
- Horizontal adjustment mechanism (for example, bolts and nuts in 4 places)
- Please design the stand so that it does not easily topple over.

Reference drawings

* The drawing showing the dimensional requirements is not an actual stand design drawing.

(Unit: mm)

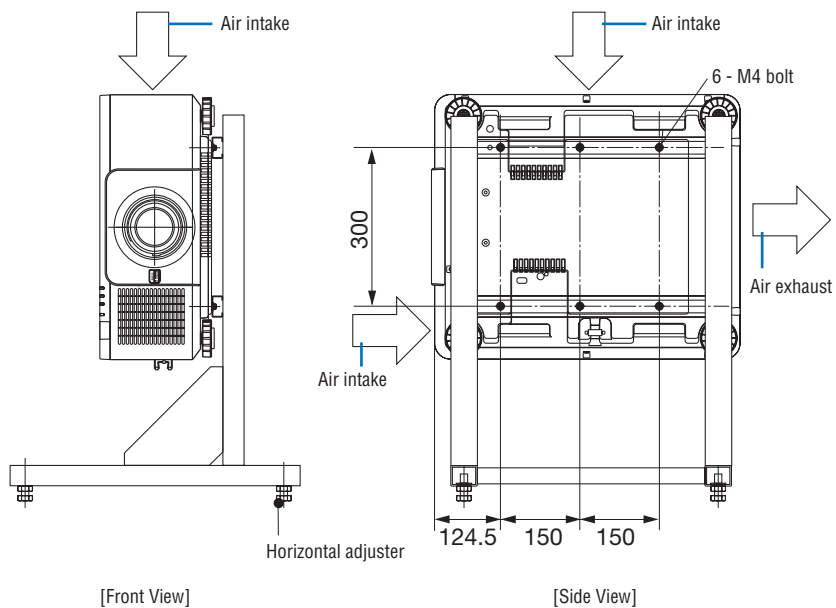

4 Stacking projectors

The projected image brightness can be doubled by gravity stacking up to two projectors without external support. This is called “Stacking Projection”.

2 projectors can be stacked on top of each other for “Stacking” setup.

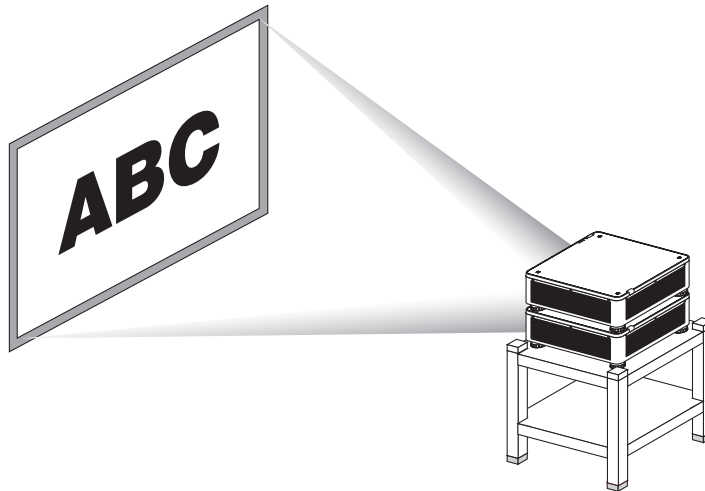

CAUTION:

- A minimum of two persons are required to carry the projector. Otherwise the projector may tumble or drop, causing personal injury.
- Grip the handles for moving the projector.

NOTE:

- Projectors with different model numbers cannot be gravity stacked.
Optional lenses with the same model numbers must be used for stacking projection.
- For stacking projectors, attach the supplied four stacking holders to the top of the lower projector. (→ [next page](#))
- It does not support overlay accuracy by stacked projectors. Precise images as small texts and detailed graphics can not be clearly read or seen.
- Use a commercially available distribution amplifier to both the primary (upper) and the secondary (lower) projectors to distribute signal to two outputs of the two projectors.
- Notes for stacking
 - Ask your service person for setting up and adjusting projectors.
 - Set up the projectors in a place or structure in a way with sufficient strength to support the combined weight of the two projectors. The single projector with a lens weighs up to approximately 34 kg/ 75 lbs.
 - To prevent the projectors from falling, fasten them in a way to withstand earthquakes.
 - Double stacking will cause room temperature to increase. Ventilate the room well.
 - Do not attempt to stack projectors on the ceiling. Gravity stacking cannot be done on the ceiling.
 - Warm up the projectors for one hour before the desired projection is obtained.
 - Make sure that the position of the upper projector does not exceed its specifications. When setting up the two projectors, adjustable height range for the tilt foot on the upper projector is added to the total adjustable range.
 - Set up the projectors so that the projected image shows as little geometric distortions as possible. The lens is different in geometric distortion between wide(+) and tele (-) for zoom.
 - Adjust the horizontal lens shift to the lens center.

Attaching Stacking Holders

Attach three stacking holders to three locations on the top of the lower projector.

Preparation:

Tools required are Phillips screwdriver (plus-head) and four stacking holders packaged with the projector. Loosen the tilt foot (four locations) of the projector.

1. Remove rubber caps and screws at four locations.

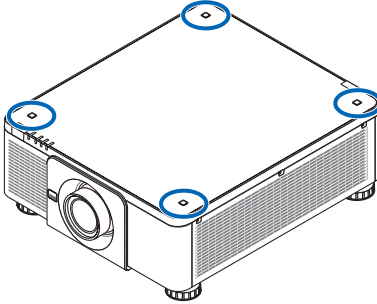

(1) Use your tweezers or nail to pinch and pull up the rubber cap.

(2) Remove the screw from a square hole.

(1)



(2)

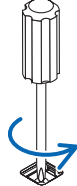

2. Attach the three stacking holders at four locations.

(1) Place a stacking holder in a square hole.

(2) Use the screw removed at Step 1 to fix the stacking holder in the square hole.

(3) Put the rubber cap removed at Step 1 back into the square hole.

- Snap the tabs on both of the rubber cap into the slits on both sides in the square hole.

(1)

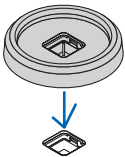

(2)

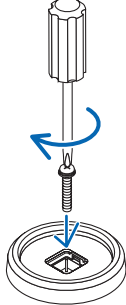

(3)

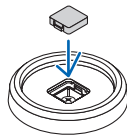

3. Put another projector on the first projector.

Put each tilt foot of the upper projector on the stacking holders (four locations).

- Each tilt foot has a rubber. Place each tilt foot rubber on stacking holders (four locations).

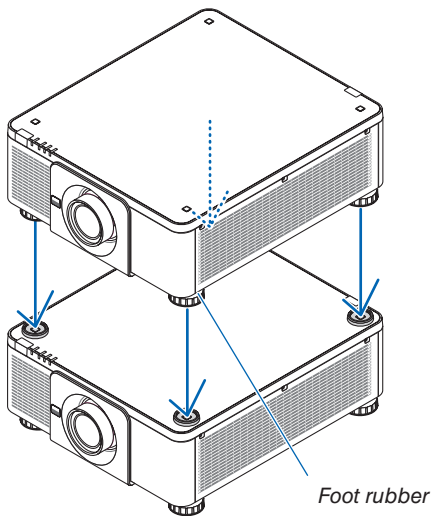

TIP:

- To remove the stacking holders, perform the above steps in reverse order.

7. Maintenance

① Cleaning the Lens

- Turn off the projector before cleaning.
- Use a blower or lens paper to clean the lens, and be careful not to scratch or mar the lens.

WARNING

- Please do not use a spray containing flammable gas to remove dust attached to the lens, etc. Doing so may result in fires.
- Do not look into the lens while the projector is on. Serious damage to your eyes could result.

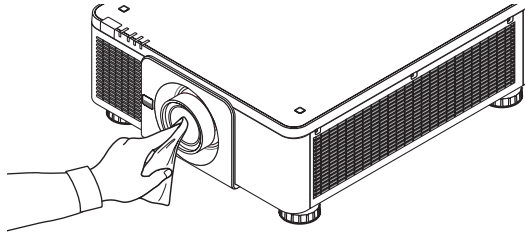

② Cleaning the Cabinet

Turn off the projector, and unplug the projector before cleaning.

- Use a dry soft cloth to wipe dust off the cabinet.
If heavily soiled, use a mild detergent.
- Never use strong detergents or solvents such as alcohol or thinner.
- When cleaning the ventilation slits or the speaker using a vacuum cleaner, do not force the brush of the vacuum cleaner into the slits of the cabinet.

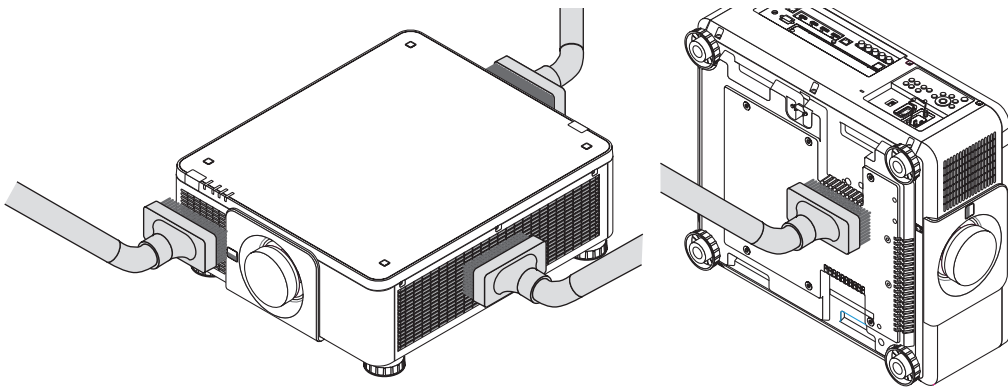

Vacuum the dust off the ventilation slits.

- Poor ventilation caused by dust accumulation in ventilation openings (also at the bottom of the projector) can result in overheating and malfunction. These areas should be cleaned regularly.
- Do not scratch or hit the cabinet with your fingers or any hard objects
- Contact your dealer for cleaning the inside of the projector.

NOTE:

- Do not apply volatile agent such as insecticide on the cabinet, the lens, or the screen. Do not leave a rubber or vinyl product in prolonged contact with it. Otherwise the surface finish will be deteriorated or the coating may be stripped off.

8. Appendix

① Throw distance and screen size

This projector can be used with 8 kinds of optional lenses (sold separately). Refer to the information on this page and use a lens suited for the installation environment (screen size and throw distance). For instructions on mounting the lens, see page 127.

Lens types and throw distance

Applicable lens unit: NP16FL-4K/NP17ZL-4K/NP18ZL-4K/NP19ZL-4K/NP20ZL-4K/NP21ZL-4K/NP31ZL-4K

(Unit: inch)

Screen size	Lens unit model name						
inch	NP16FL-4K	NP17ZL-4K	NP18ZL-4K	NP19ZL-4K	NP20ZL-4K	NP21ZL-4K	NP31ZL-4K
50	32	53 – 77	73 – 97	95 – 159	152 – 232	224 – 356	32 – 40
70	46	75 – 108	104 – 137	134 – 223	215 – 326	319 – 503	45 – 57
100	67	109 – 155	150 – 197	192 – 320	310 – 468	460 – 724	65 – 82
120	80	131 – 187	180 – 237	231 – 385	373 – 563	554 – 871	78 – 98
150	101	164 – 234	226 – 297	290 – 482	468 – 705	696 – 1092	98 – 123
180	121	197 – 281	271 – 357	349 – 579	562 – 847	837 – 1312	118 – 148
200	135	219 – 313	302 – 396	388 – 644	625 – 942	932 – 1459	132 – 165
250	169	274 – 391	378 – 496	485 – 806	783 – 1179	1168 – 1827	165 – 206
300	205	330 – 470	454 – 596	583 – 968	941 – 1416	1404 – 2195	199 – 248

(Unit: m)

Screen size	Lens unit model name						
inch	NP16FL-4K	NP17ZL-4K	NP18ZL-4K	NP19ZL-4K	NP20ZL-4K	NP21ZL-4K	NP31ZL-4K
50	0.8	1.4 – 1.9	1.9 – 2.5	2.4 – 4.0	3.9 – 5.9	5.7 – 9.0	0.8 – 1.0
70	1.2	1.9 – 2.7	2.6 – 3.5	3.4 – 5.7	5.5 – 8.3	8.1 – 12.8	1.1 – 1.4
100	1.7	2.8 – 3.9	3.8 – 5.0	4.9 – 8.1	7.9 – 11.9	11.7 – 18.4	1.7 – 2.1
120	2.0	3.3 – 4.7	4.6 – 6.0	5.9 – 9.8	9.5 – 14.3	14.1 – 22.1	2.0 – 2.5
150	2.6	4.2 – 5.9	5.7 – 7.5	7.4 – 12.2	11.9 – 17.9	17.7 – 27.7	2.5 – 3.1
180	3.1	5.0 – 7.1	6.9 – 9.1	8.9 – 14.7	14.3 – 21.5	21.3 – 33.3	3.0 – 3.8
200	3.4	5.6 – 7.9	7.7 – 10.1	9.8 – 16.4	15.9 – 23.9	23.7 – 37.1	3.3 – 4.2
250	4.3	7.0 – 9.9	9.6 – 12.6	12.3 – 20.5	19.9 – 29.9	29.7 – 46.4	4.2 – 5.2
300	5.2	8.4 – 11.9	11.5 – 15.1	14.8 – 24.6	23.9 – 36.0	35.6 – 55.7	5.0 – 6.3

TIP:

Calculation of the throw distance from the screen size

NP16FL-4K lens throw distance (m) = $H \times 0.76$: 32"/0.8 m (min.) to 205"/5.2 m (max.)

NP17ZL-4K lens throw distance (m) = $H \times 1.24$ to $H \times 1.78$: 53"/1.4 m (min.) to 470"/11.9 m (max.)

NP18ZL-4K lens throw distance (m) = $H \times 1.71$ to $H \times 2.25$: 73"/1.9 m (min.) to 596"/15.1 m (max.)

NP19ZL-4K lens throw distance (m) = $H \times 2.20$ to $H \times 3.67$: 95"/2.4 m (min.) to 968"/24.6 m (max.)

NP20ZL-4K lens throw distance (m) = $H \times 3.54$ to $H \times 5.36$: 152"/3.9 m (min.) to 1416"/36.0 m (max.)

NP21ZL-4K lens throw distance (m) = $H \times 5.25$ to $H \times 8.28$: 224"/5.7 m (min.) to 2195"/55.7 m (max.)

NP31ZL-4K lens throw distance (m) = $H \times 0.74$ to $H \times 0.93$: 32"/0.8 m (min.) to 248"/6.3 m (max.)

"H" (Horizontal) refers to the screen width.

* Figures differ by several % with the table above because the calculation is approximate.

Ex.: Throw distance when projecting on a 100" screen using the NP18ZL-4K lens:

According to the "Screen Size (for reference)" table (→ page 139), H (screen width) = 87.1"/221.3 cm (approx. 2.21 m).

The throw distance is $87.1"/2.21 \text{ m} \times 1.71$ to $87.1"/2.21 \text{ m} \times 2.25 = 149"/3.8 \text{ m}$ to $196"/5.0 \text{ m}$ (because of the zoom lens).

Projection range for the different lenses

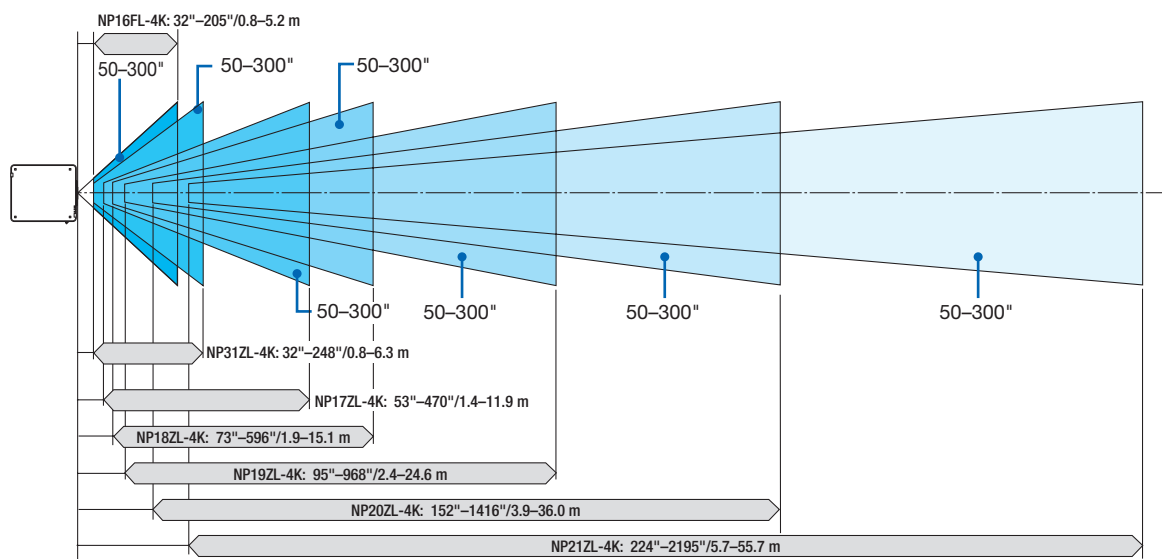

Applicable lens unit: NP39ML-4K

(Unit: inch)

Screen size (inch)	Throw distance L1	L2	H1	H2
100	33	-0.4	80	30
120	39	6	94	35
150	48	15	116	43
200	63	30	153	55
250	78	45	190	68
300	93	60	227	80
350	109	75	264	92

(Unit: m)

Screen size (inch)	Throw distance L1	L2	H1	H2
100	0.83	-0.01	2.02	0.77
120	0.99	0.15	2.40	0.90
150	1.22	0.38	2.96	1.09
200	1.60	0.76	3.90	1.40
250	1.99	1.15	4.83	1.72
300	2.37	1.53	5.77	2.03
350	2.76	1.92	6.71	2.35

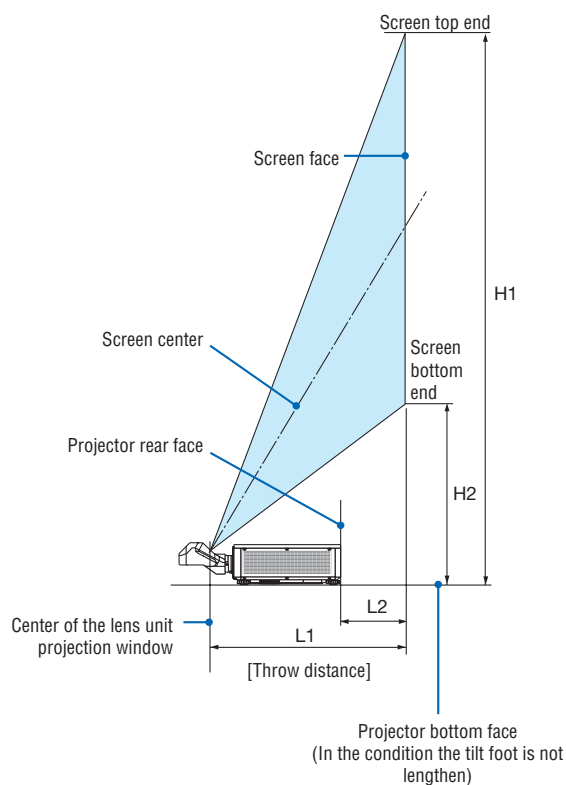

TIP:

Calculation of the throw distance from the screen size
 NP39ML-4K lens throw distance (m) = $H \times 0.38 : 33 \div 0.8 \text{ m (min.)}$
 to $109 \div 2.8 \text{ m (max.)}$

"H" (Horizontal) refers to the screen width.

* Figures differ by several % with the table above because the calculation is approximate.

Tables of screen sizes and dimensions

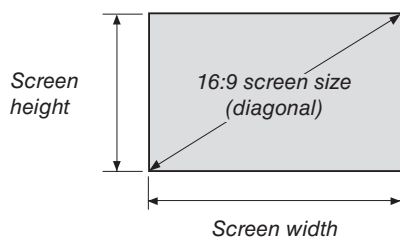

Size (inches)	Screen width		Screen height	
	(inches)	(cm)	(inches)	(cm)
40	34.8	88.5	19.6	49.9
50	43.5	110.6	24.5	62.3
60	61.0	154.9	34.4	87.3
90	78.4	199.2	44.2	112.2
100	87.1	221.3	49.1	124.7
120	104.6	265.6	58.9	149.6
150	130.7	331.9	73.6	187.0
180	156.8	398.3	88.3	224.4
200	174.3	442.6	98.2	249.4
220	191.7	486.8	108.0	274.3
250	217.8	553.2	122.7	311.7
280	243.9	619.6	137.4	349.1
300	261.4	663.9	147.2	374.0
320	278.8	708.1	157.1	399.0
350	304.9	774.5	171.8	436.4
400	348.5	885.2	196.3	498.7
450	392.0	995.8	220.9	561.1
500	435.6	1106.5	245.4	623.4

Lens shifting range

This projector is equipped with a lens shift function for adjusting the position of the projected image by using the LENS SHIFT buttons (→ page 23). The lens can be shifted within the range shown below.

NOTE:

- Please do not use the lens shift function when projecting portrait images. Please use it with the lens in the center when one among the lens units, NP16FL-4K, NP17ZL-4K, NP18ZL-4K, NP19ZL-4K, NP20ZL-4K, NP21ZL-4K or NP31ZL-4K is fixed on. For using the lens unit NP39ML-4K, select [TYPE] for [LENS POSITION] in [INSTALLATION(2)] in [SETUP] on the onscreen menu for moving the lens at the appropriate position.

Legend: V “Vertical” refers to the screen height and H “Horizontal” refers to the screen width. The lens shift range is expressed as a ratio of height and width, respectively.

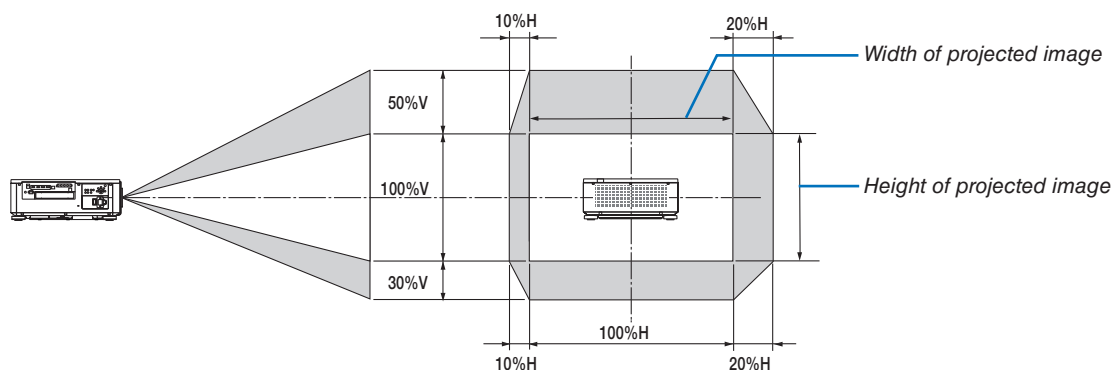

* The lens shift range is the same for ceiling installation.

(Example) When using to project on a 150" screen

According to the “Table of screen sizes and dimensions” (→ page 139), $H = 130.7''/331.9 \text{ cm}$, $V = 73.6''/187.0 \text{ cm}$.

Adjustment range in the vertical direction: the projected image can be moved upwards $0.5 \times 73.6''/187.0 \text{ cm} \approx 36.8''/93.5 \text{ cm}$, downwards approximately $0.3 \times 73.6''/187.0 \text{ cm} \approx 22.1''/56.1 \text{ cm}$ (when the lens is at the center position).

Adjustment range in the horizontal direction: the projected image can be moved to the left $0.1 \times 130.7''/331.9 \text{ cm} \approx 13.1''/33.2 \text{ cm}$, to the right approximately $0.2 \times 130.7''/331.9 \text{ cm} \approx 26.1''/66.4 \text{ cm}$.

* Figures differ by several % because the calculation is approximate.

② Mounting the Optional Board (sold separately)

CAUTION

Before mounting or removing the optional board, be sure to turn off the projector, wait for the fans to stop and turn off the main power switch.

Tool needed: Phillips screwdriver (plus-head)

1. Turn off the main power switch of the projector.

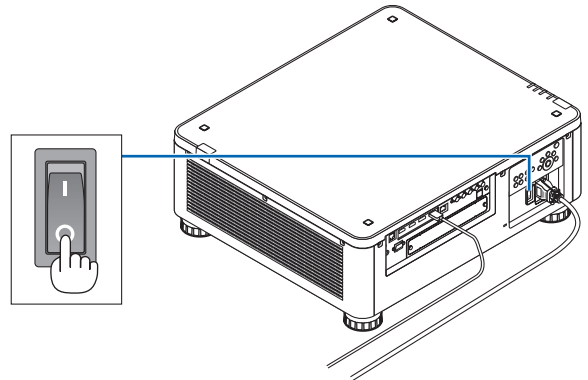

2. Loosen the two screws on the SLOT cover of the terminals.

Remove the two screws and the SLOT cover.

NOTE:

- Keep the two screws and the slot cover.

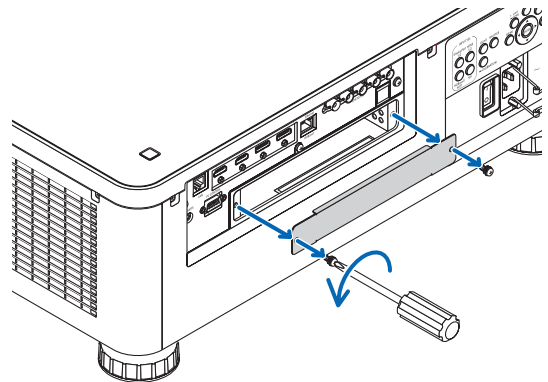

3. Insert the optional board into the slot.

Make sure that the board is inserted into the slot in the correct orientation.

Incorrect orientation may cause miscommunication between the optional board and projector.

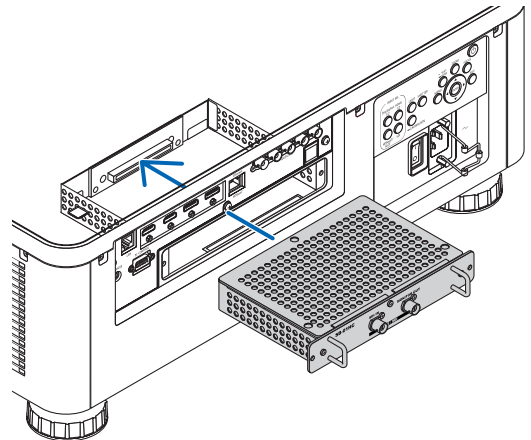

4. Tighten the two screws on both sides of the slot.

- Be sure to tighten the screws.

This will complete installation of the optional board.

To select the optional board source, select SLOT as the input.

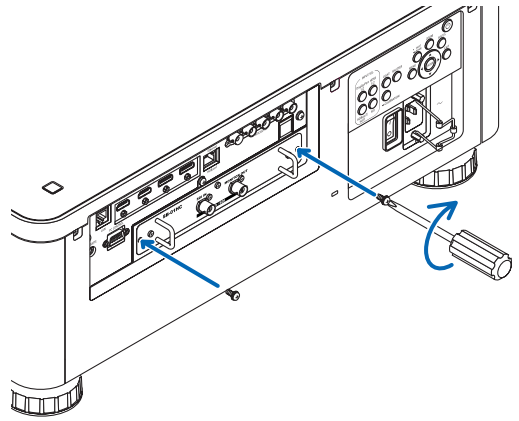

NOTE:

- Mounting the optional board may cause the fans to run in the standby mode for the purpose of cooling depending on the optional board. The fan speed may also increase in order to cool the projector properly. Both of these instances are considered normal and not a malfunction of the projector.

③ Compatible Input Signal List

HDMI

Signal	Resolution (dots)	Aspect Ratio	Refresh Rate (Hz)
VGA	640 × 480	4 : 3	60
SVGA	800 × 600	4 : 3	60
XGA	1024 × 768	4 : 3	60
HD	1280 × 720	16 : 9	60
WXGA	1280 × 768	15 : 9	60
	1280 × 800	16 : 10	60
	1366 × 768 *1	16 : 9	60
Quad-VGA	1280 × 960	4 : 3	60
SXGA	1280 × 1024	5 : 4	60
SXGA+	1400 × 1050	4 : 3	60
WXGA+	1440 × 900	16 : 10	60
WXGA++	1600 × 900	16 : 9	60
WSXGA+	1680 × 1050	16 : 10	60
UXGA	1600 × 1200	4 : 3	60
Full HD	1920 × 1080	16 : 9	60
WUXGA	1920 × 1200	16 : 10	60 (Reduced Blanking)
2K	2048 × 1080	17 : 9	60
WQHD	2560 × 1440	16 : 9	60
iMac 27"			
WQXGA	2560 × 1600	16 : 10	60 (Reduced Blanking)
4K	3840 × 2160 *2	16 : 9	23.98/24/25/29.97/30/50/60
	4096 × 2160	17 : 9	23.98/24/25/29.97/30/50/60
HDTV(1080p)	1920 × 1080	16 : 9	50/60
HDTV(1080i)	1920 × 1080	16 : 9	50/60
HDTV (720p)	1280 × 720	16 : 9	50/60
SDTV (480i/p)	720/1440 × 480	4:3 / 16:9	60
SDTV (576i/p)	720/1440 × 576	4:3 / 16:9	50

HDBaseT

Signal	Resolution (dots)	Aspect Ratio	Refresh Rate (Hz)
VGA	640 × 480	4 : 3	60
SVGA	800 × 600	4 : 3	60
XGA	1024 × 768	4 : 3	60
HD	1280 × 720	16 : 9	60
WXGA	1280 × 768	15 : 9	60
	1280 × 800	16 : 10	60
	1366 × 768 *1	16 : 9	60
Quad-VGA	1280 × 960	4 : 3	60
SXGA	1280 × 1024	5 : 4	60
SXGA+	1400 × 1050	4 : 3	60
WXGA+	1440 × 900	16 : 10	60
WXGA++	1600 × 900	16 : 9	60
WSXGA+	1680 × 1050	16 : 10	60
UXGA	1600 × 1200	4 : 3	60
Full HD	1920 × 1080	16 : 9	60
WUXGA	1920 × 1200	16 : 10	60 (Reduced Blanking)
2K	2048 × 1080	17 : 9	60
WQHD	2560 × 1440	16 : 9	60
iMac 27"			
WQXGA	2560 × 1600	16 : 10	60 (Reduced Blanking)
4K	3840 × 2160 *2	16 : 9	23.98/24/25/29.97/30
	4096 × 2160	17 : 9	23.98/24/25/29.97/30
HDTV(1080p)	1920 × 1080	16 : 9	50/60
HDTV(1080i)	1920 × 1080	16 : 9	50/60
HDTV (720p)	1280 × 720	16 : 9	50/60
SDTV (480i/p)	720/1440 × 480	4:3 / 16:9	60
SDTV (576i/p)	720/1440 × 576	4:3 / 16:9	50

DisplayPort

Signal	Resolution (dots)	Aspect Ratio	Refresh Rate (Hz)
VGA	640 × 480	4 : 3	60
SVGA	800 × 600	4 : 3	60
XGA	1024 × 768	4 : 3	60
HD	1280 × 720	16 : 9	60
WXGA	1280 × 768	15 : 9	60
	1280 × 800	16 : 10	60
	1366 × 768 *1	16 : 9	60
Quad-VGA	1280 × 960	4 : 3	60
SXGA	1280 × 1024	5 : 4	60
SXGA+	1400 × 1050	4 : 3	60
WXGA+	1440 × 900	16 : 10	60
WXGA++	1600 × 900	16 : 9	60
WSXGA+	1680 × 1050	16 : 10	60
UXGA	1600 × 1200	4 : 3	60
Full HD	1920 × 1080	16 : 9	60
WUXGA	1920 × 1200	16 : 10	60 (Reduced Blanking)
2K	2048 × 1080	17 : 9	60
WQHD	2560 × 1440	16 : 9	60
iMac 27"			
WQXGA	2560 × 1600	16 : 10	60 (Reduced Blanking)
4K	3840 × 2160 *2	16 : 9	23.98/24/25/29.97/30/50/60
	4096 × 2160	17 : 9	23.98/24/25/29.97/30/50/60
HDTV(1080p)	1920 × 1080	16 : 9	50/60
HDTV (720p)	1280 × 720	16 : 9	50/60
SDTV (480i/p)	720/1440 × 480	4:3 / 16:9	60
SDTV (576i/p)	720/1440 × 576	4:3 / 16:9	50

SDI

Signal	Resolution (dots)	Aspect Ratio	Refresh Rate (Hz)
HD-SDI (1035i)	1920 × 1035	16 : 9	60
HD-SDI (1080i)	1920 × 1080	16 : 9	50/60
HD-SDI (1080p)	1920 × 1080	16 : 9	24pSF
HD-SDI (1080p)	1920 × 1080	16 : 9	24/25/30
HD-SDI (720p)	1280 × 720	16 : 9	24/25/30/50/60
3G-SDI (1080p)	1920 × 1080	16 : 9	50/60
3G-SDI (1080p)	1920 × 1080	16 : 9	24/25/30
3G-SDI (1080p)	1920 × 1080	16 : 9	24pSF
3G-SDI (1080i)	1920 × 1080	16 : 9	50/60
Quad SDI	3840 × 2160 *2	16 : 9	24/25/30/50/60
Quad SDI	4096 × 2160	17 : 9	24/25/30/50/60

*1 The projector may fail to display these signals correctly when [AUTO] is selected for [ASPECT RATIO] in the on-screen menu. The factory default is [AUTO] for [ASPECT RATIO]. To display these signals, select [16:9] for [ASPECT RATIO].

*2 Native resolution

- Signals exceeding the projector's resolution are handled with Advanced AccuBlend.
- With Advanced AccuBlend, the size of characters and ruled lines may be uneven and colors may be blurred.
- Upon shipment, the projector is set for signals with standard display resolutions and frequencies, but adjustments may be required depending on the type of computer.

4 Specifications

Model name		PX1005QL-W/PX1005QL-B	
Method		Single DLP® chip	
Specifications of main parts			
DMD panel	Size	0.66" (aspect ratio: 16:9)	
	Pixels ^(*)	4,150,047 (2716 dots × 1528 lines)	
	Projection lenses	Please refer to the specifications of option lens (→ page 147)	
	Light source	Laser Diode	
Optical device		Optical isolation by dichroic mirror, combining by dichroic prism	
Display resolution		8,294,400 (3840 dots × 2160 lines)	
Light output ^(*) ^(*)		10000 lm	
Contrast ratio ^(*) (all white/all black)		10,000:1 with dynamic contrast	
Screen size (throw distance)		Please refer to the "Throw distance and screen size" (→ page 137)	
Color reproducibility		10-bit color processing (approx. 1.07 billion colors)	
Scanning frequency	Horizontal	Digital: 15 kHz, 24 to 153 kHz, conforming to VESA standards	
	Vertical	Digital: 24, 25, 30, 48 Hz, 50 to 85 Hz, 100, 120 Hz conforming to VESA standards	
Main adjustment functions		Power zoom, power focus, power lens shift, input signal switching (HDMI/DisplayPort/SDI/HDBaseT/SLOT), auto image adjustment, picture magnification, muting (video), power on/standby, on-screen display/selection, etc.	
Max. display resolution (horizontal × vertical)		Digital: 4096 × 2160 (handled with Advanced AccuBlend)	
Input/output terminals			
HDMI	Video input	HDMI® Connector type A × 2 Deep Color (color depth): 8-/10-/12-bit compatible Colorimetry: RGB, YCbCr444, YCbCr422, YCbCr420, REC2020, REC709, REC601 Supports HDCP ^(*) , 4K and HDR	
DisplayPort	Video input	DisplayPort × 2 Data rate: 5.4 Gbps/2.7 Gbps/1.62 Gbps No. lanes: 1 lane/2 lanes/4 lanes Deep Color (color depth): 8-/10-/12-bit compatible Colorimetry: RGB, YCbCr444, YCbCr422, REC709, REC601 Supports HDCP ^(*) , 4K	
Ethernet/HDBaseT port	Video input	RJ-45 × 1, 100BASE-TX Deep Color (color depth): 8-/10-/12-bit compatible Colorimetry: RGB, YCbCr444, YCbCr422, YCbCr420, BT2020, REC709, REC601 Supports HDCP ^(*) , 4K	
SDI (3G/HD)	Video input	BNC × 4 Input signals: SMPTE259M, SMPTE292M, SMPTE424M Colorimetry: RGB, YCbCr444, YCbCr422	
PC control terminal		D-Sub 9-pin × 1	
USB port		USB type A × 1	
LAN port		RJ-45 × 1, Supports 10BASE-T/100BASE-TX	
Remote terminal		Stereo mini jack × 1	
SLOT		For mounting separately sold options	
Usage environment ^(*)		Operating temperature: 41 to 104°F (5 to 40°C) Operating humidity: 20 to 80% (with no condensation) Storage temperature: 14 to 140°F (-10 to 60°C) Storage humidity: 20 to 80% (with no condensation) Operating altitude: 0 to 3000 m/10,000 feet	
Power supply		110-240 V AC, 50/60Hz	
Power consumption	REF.	NORMAL	1181 W (110-130 V)/1222 W (200-240 V)
	LIGHT	ECO1	1002 W (110-130 V)/977 W (200-240 V)
	MODE	ECO2	658 W (110-130 V)/646 W (200-240 V)
	STAND-BY	Link-up	0.88 W (110-130 V)/0.92 W (200-240 V)
		Link-down	0.33 W (110-130 V)/0.35 W (200-240 V)
Rated input current		12.5 A-5.5 A	
Power cord specification		15 A or higher ^(*)	
External dimensions		19.7" (width) × 8.3" (height) × 22.7" (depth)/500 (width) × 211 (height) × 577 (depth) mm (not including protruding parts) 19.7" (width) × 8.5" (height) × 23.0" (depth)/500 (width) × 216 (height) × 583 (depth) mm (including protruding parts)	
Weight		68.8 lbs/31.2 kg (not including lens)	

- *1 Effective pixels are more than 99.99%.
 - *2 This is the light output value that results from setting the [REF. LIGHT MODE] to [NORMAL] and setting the [PRESET] to [HIGH-BRIGHT] while using the NP18ZL-4K lens (sold separately).
The light output value is lower when setting the [REF. LIGHT MODE] to [ECO1] or [ECO2]. ([ECO1]: about 80%, [ECO2]: about 50%). If any other mode is selected as the [PRESET] mode, the light output value may drop slightly.
 - *3 Compliance with ISO21118-2012
 - *4 If you are unable to view material via the HDMI input, DisplayPort input and HDBaseT input, this does not necessarily mean the projector is not functioning properly. With the implementation of HDCP technology, there may be cases in which certain content is protected with HDCP and might not be displayed due to the decision/intention of the HDCP community (Digital Content Protection, LLC).
Video: Deep Color, 8/10/12-bit
HDMI: Supports HDCP 1.4/2.2
DisplayPort: Supports HDCP 1.4
HDBaseT: Supports HDCP 1.4/2.2
 - *5 Depending on the altitude and temperature, the projector goes into "Forced ECO MODE".
 - *6 In UK, use a BS-approved power cord with molded plug having a black (16A) fuse installed for use with this projector.
- These specifications and the product's design are subject to change without notice.

For additional information visit:

US: <https://www.necdisplay.com/>

Europe: <https://www.nec-display-solutions.com/>

Global: <https://www.nec-display.com/global/index.html>

For information on our optional accessories, visit our website or see our brochure.

Option lens (sold separately)

NP16FL-4K	Power focus throw ratio 0.76:1, F1.85, f = 11.6 mm
NP17ZL-4K	Power zoom and focus throw ratio 1.24–1.78:1, F1.85–2.50, f = 18.7–26.5 mm
NP18ZL-4K	Power zoom and focus throw ratio 1.71–2.25:1, F1.70–1.90, f = 26.0–34.0 mm
NP19ZL-4K	Power zoom and focus throw ratio 2.20–3.67:1, F1.86–2.48, f = 32.9–54.2 mm
NP20ZL-4K	Power zoom and focus throw ratio 3.54–5.36:1, F1.85–2.41, f = 52.8–79.1 mm
NP21ZL-4K	Power zoom and focus throw ratio 5.25–8.28:1, F1.85–2.48, f = 78.5–121.9 mm
NP31ZL-4K	Power zoom and focus throw ratio 0.74–0.93:1, F1.96–2.30, f = 11.3–14.1 mm
NP39ML-4K	Power focus Throw ratio 0.38:1, F2.0, f = 5.64 mm

5 Cabinet Dimensions

Unit: mm (inch)

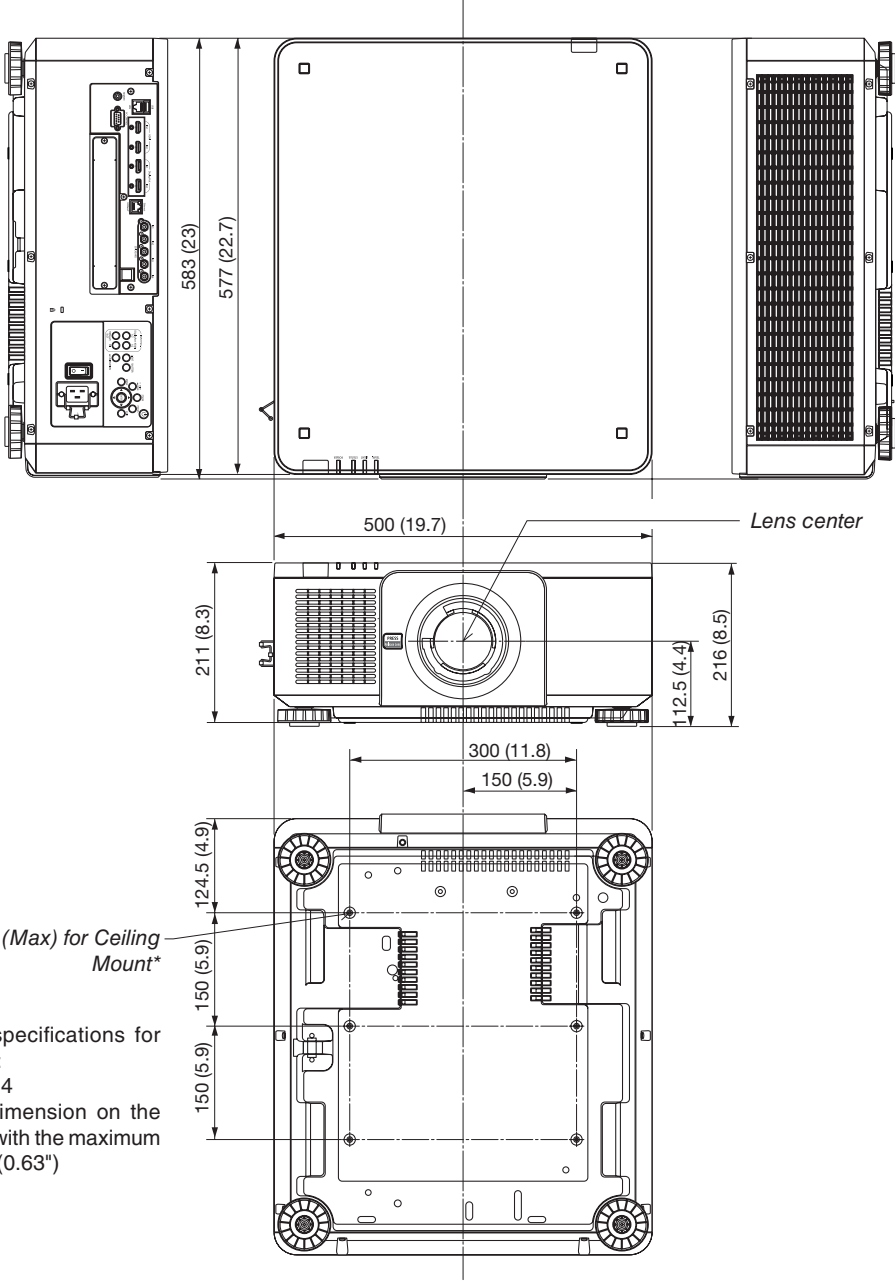

6-M4 x L16 (Max) for Ceiling Mount*

* The screws specifications for Ceiling Mount:
Screw type: M4
Screw hole dimension on the projector: M4 with the maximum depth 16 mm (0.63")

CAUTION

Do not attempt to mount the projector on a ceiling yourself. The projector must be installed by qualified technicians in order to ensure proper operation and reduce the risk of bodily injury. In addition, the ceiling must be strong enough to support the projector and the installation must be in accordance with any local building codes. Please consult your dealer for more information.

6 Pin assignments and signal names of main terminals

HDMI IN 1/2 Terminal (Type A)

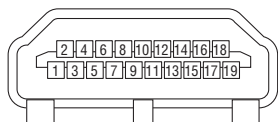

Pin No.	Signal	Pin No.	Signal
1	TMDS Data 2+	11	TMDS Clock Shield
2	TMDS Data 2 Shield	12	TMDS Clock-
3	TMDS Data 2-	13	CEC
4	TMDS Data 1+	14	Disconnection
5	TMDS Data 1 Shield	15	SCL
6	TMDS Data 1-	16	SDA
7	TMDS Data 0+	17	DDC/CEC grounding
8	TMDS Data 0 Shield	18	+5 V power supply
9	TMDS Data 0-	19	Hot plug detection
10	TMDS Clock +		

DisplayPort IN 1/2 Terminal

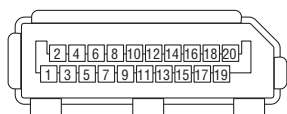

Pin No.	Signal	Pin No.	Signal
1	Main link lane 3-	11	Grounding 0
2	Grounding 3	12	Main link lane 0+
3	Main link lane 3+	13	Configuration 1
4	Main link lane 2-	14	Configuration 2
5	Grounding 2	15	Supplementary channel +
6	Main link lane 2+	16	Grounding 4
7	Main link lane 1-	17	Supplementary channel -
8	Grounding 1	18	Hot plug detection
9	Main link lane 1+	19	Return
10	Main link lane 0-	20	+3.3 V power supply

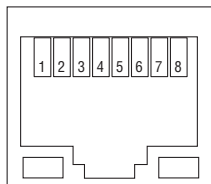
Ethernet/HDBaseT Port (RJ-45)

Pin No.	Signal
1	TxD+/HDBT0+
2	TxD-/HDBT0-
3	RxD+/HDBT1+
4	Disconnection/HDBT2+
5	Disconnection/HDBT2-
6	RxD-/HDBT1-
7	Disconnection/HDBT3+
8	Disconnection/HDBT3-

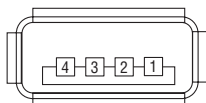
USB Port (Type A)

Pin No.	Signal
1	V _{BUS}
2	D-
3	D+
4	Grounding

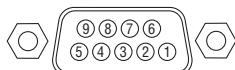
PC CONTROL Port (D-Sub 9 Pin)

Pin No.	Signal
1	Unused
2	RxD reception data
3	TxD transmission data
4	Unused
5	Grounding
6	Unused
7	RTS transmission request
8	CTS transmission allowed
9	Unused

7 About the ASCII Control Command

This device supports the common ASCII Control Command for controlling our projector and monitor. Please visit our web site for detailed information about the command.

https://www.nec-display.com/dl/en/pj_manual/lineup.html

HOW TO CONNECT WITH AN EXTERNAL DEVICE

There are two methods to connect the projector with an external device such as a computer.

1. Connection thru the serial port.
Connects the projector to a computer by a serial cable (straight cable).
2. Connection via network (LAN/HDBaseT)
Connects the projector to a computer by a LAN cable.
Concerning to the type of LAN cable, please ask to your network administrator.

CONNECTION INTERFACE

1. Connection thru the serial port.

Communication Protocol

Item	Information
Baud rate	115200/38400/19200/9600/4800 bps
Data length	8 bits
Parity bit	No parity
Stop bit	1 bit
Flow control	None
Communications procedure	Full duplex

2. Connection via network

Communication Protocol (Connection via LAN)

Item	Information
Communication speed	Set automatically (10/100 Mbps)
Supported standard	IEEE802.3 (10BASE-T) IEEE802.3u (100BASE-TX, Auto-Negotiation)

Use the TCP port number 7142 for transmitting and receiving command.

Communication Protocol (Connection via HDBaseT)

Item	Information
Communication speed	100 Mbps
Supported standard	IEEE802.3u (100BASE-TX, Auto-Negotiation)

Use the TCP port number 7142 for transmitting and receiving command.

PARAMETERS FOR THIS DEVICE

Input command

Input terminal	Response	Parameter
HDMI1	hdmi1	hdmi1 or hdmi
HDMI2	hdmi2	hdmi2
DisplayPort1	displayport1	displayport1 or displayport
DisplayPort2	displayport2	displayport2
HDBaseT	hdbaset	hdbaset or hdbaset1
SDI1	sdi1	sdi1 or sdi
SDI2	sdi2	sdi2
SDI3	sdi3	sdi3
SDI4	sdi4	sdi4
SLOT	slot	slot or slot1

Status command

Response	Error Status
error:temp	Temperature error
error:fan	Fan trouble
error:light	Light source trouble
error:lens	Lens trouble
error:system	System trouble

8 Changing the Background Logo (Virtual Remote Tool)

This will help you perform operations such as projector's power on or off and signal selection via a LAN connection. It is also used to send an image to the projector and register it as the logo data of the projector. After registering it, you can lock the logo to prevent it from changing.

Control Functions

Power On/Off, signal selection, picture freeze, picture mute, Logo transfer to the projector, and remote control operation on your PC.

Virtual Remote screen



Remote Control Window

Use this button for changing the background logo.



Toolbar

For getting the Virtual Remote Tool, please visit our web site and download it:

<https://www.nec-display.com/dl/en/index.html>

NOTE:

- Remote Control Window is not available for changing the background logo.
Please see the HELP menu of the Virtual Remote Tool about how to display the Toolbar.
- Logo data (graphics) that can be sent to the projector with Virtual Remote Tool has the following restrictions: (Only via serial or LAN connection)
 - * File size: Within 512 kilobytes
 - * Image size: Within the resolution of the projector
 - * File format: PNG (Full color)
- Logo data (image) sent using the Virtual Remote Tool will be displayed in the center with the surrounding area in black.
- To put the default "NEC logo" back in the background logo, you need to register it as the background logo by using the image file (Logo\NEC_logo2018_3840x2160.png) included on the supplied NEC Projector CD-ROM.

9 Troubleshooting





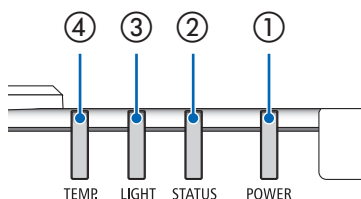































This section helps you resolve problems you may encounter while setting up or using the projector.



















Feature of each indicator



- ① POWER indicator
This indicator informs the power status of the projector.
- ② STATUS indicator
This indicator lights/blinks when a button is pressed while the CONTROL PANEL LOCK function is utilized, or while performing the lens calibration and specific operations.
- ③ LIGHT indicator
This indicator informs the state of light source, used time of the light source, and the status of REF. LIGHT MODE.
- ④ TEMP. indicator
This is the temperature indicator informing temperature trouble when the ambient temperature is too high/low.

















Indicator Message (Status message)

POWER	STATUS	LIGHT	TEMP.	Projector status
 Off	 Off	 Off	 Off	Power is off
 Orange (Blink*1)	 Off	 Off	 Off	In the state of Standby (Standby mode is NORMAL and the network is ready).
 Orange (Blink*2)	 Off	 Off	 Off	In the state of Standby (Standby mode is NORMAL and the network is unavailable).
 Orange (Light)	 Off	 Off	 Off	In the state of Standby (Standby mode is NORMAL and the network is available)
 Orange (Blink*3)	 Off	 Off	 Off	ON time as the program timer is activated. (In the state of Standby)
 Green (Light)	 Off	 Off	 Off	In the state of Sleep
 Green (Blink*3)	 Off	 Off	 Off	ON time as the program timer is activated. (In the state of Sleep)
 Blue (Light)	 Off	 Green (Light)	 Off	Powered state (REF. LIGHT MODE is NORMAL or ECO1)
 Blue (Light)	 Off	 Green (Blink*3)	 Off	Powered state (REF. LIGHT MODE is ECO2)

POWER	STATUS	LIGHT	TEMP.	Projector status
Status varies	 Orange (Blink*4)	Status varies	 Off	Lens calibration implement request.
 Blue (Light)	 Green (Blink*4)	 Status varies	 Off	Performing the lens calibration
 Blue (Light)	 Status varies	 Off	 Off	Shutter function is activating
 Blue (Blink*3)	 Off	 Status varies	 Off	OFF Timer is activated, OFF time as the program timer is activated (Powered state)
 Blue (Blink*5)	 Off	 Off	 Off	Preparing for powering ON

*1 Repetition to light on for 1.5 seconds / off for 1.5 seconds
 *2 Repetition to light on for 1.5 seconds / off for 7.5 seconds
 *3 Repetition to light on for 2.5 seconds / off for 0.5 seconds
 *4 Repetition to light on for 0.5 seconds / off for 0.5 seconds / on for 0.5 seconds / off for 2.5 seconds
 *5 Repetition to light on for 0.5 seconds / off for 0.5 seconds

Indicator Message (Error message)

POWER	STATUS	LIGHT	TEMP.	Projector status	Procedure
 Blue (Light)	 Orange (Light)	Status varies	 Off	A button has been pressed while the KEY LOCK is activated.	The projector's keys are locked. The setting must be canceled to operate the projector. (→ page 110)
				ID numbers for the projector and the remote control do not match.	Check the control IDs (→ page 111)
 Blue (Light)	 Off	 Orange (Light)	 Orange (Light)	Temperature problem (In the Forced ECO)	Ambient temteprature is high. Lower the room temperature.
 Red (Blink* ⁵)	 Off	 Off	 Off	Temperature problem	Ambient temperature is out of the operation temperature. Check if any obstruction stays near the exhaust vent.
 Red (Blink* ⁵)	 Red (Light)	 Red (Light)	 Off	Lens mounting error/Lens problem	Lens is not mounted properly. Mout it (→ see page 127). If the indicator message is remain unchanged even if
 Red (Light)	Status varies	Status varies	 Off	Error requiring service support	Contact your dealer or service person- nel. Make sure to check and inform indicator status for asking to repair.

*1 Repetition to light on for 1.5 seconds / off for 1.5 seconds

*2 Repetition to light on for 1.5 seconds / off for 7.5 seconds

*3 Repetition to light on for 2.5 seconds / off for 0.5 seconds

*4 Repetition to light on for 0.5 seconds / off for 0.5 seconds / on for 0.5 seconds / off for 2.5 seconds

*5 Repetition to light on for 0.5 seconds / off for 0.5 seconds

- When the thermal protector is activated:

When inside temperature of the projector becomes too high or low, the POWER indicator start to red blink in a short cycle. After this happened, the thermal protector will activate and the projector may be turned off.

In this case, please take the below measures:

- Pull out the power plug from the wall inlet.
- Place the projector in cool place if it has been placed in high ambient temperature.
- Clean the exhaust vent if dust has accumulated on.
- Leave the projector for about one hour until inside temperature gets lower.

Explanation on the POWER indicator and standby state
In the state the selected PROFILE for WIRED LAN is available.

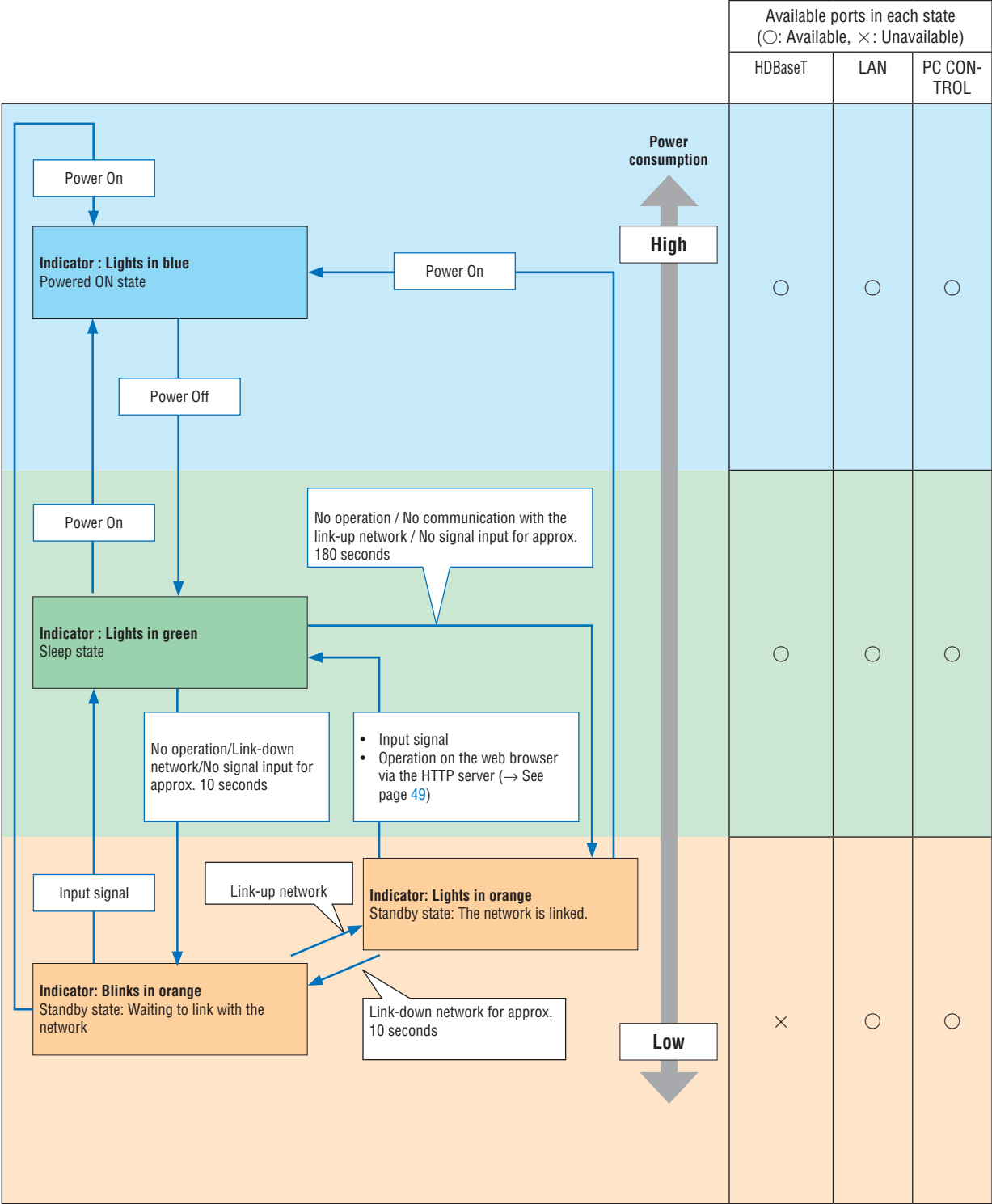

In the state the selected PROFILE for WIRED LAN is unavailable.

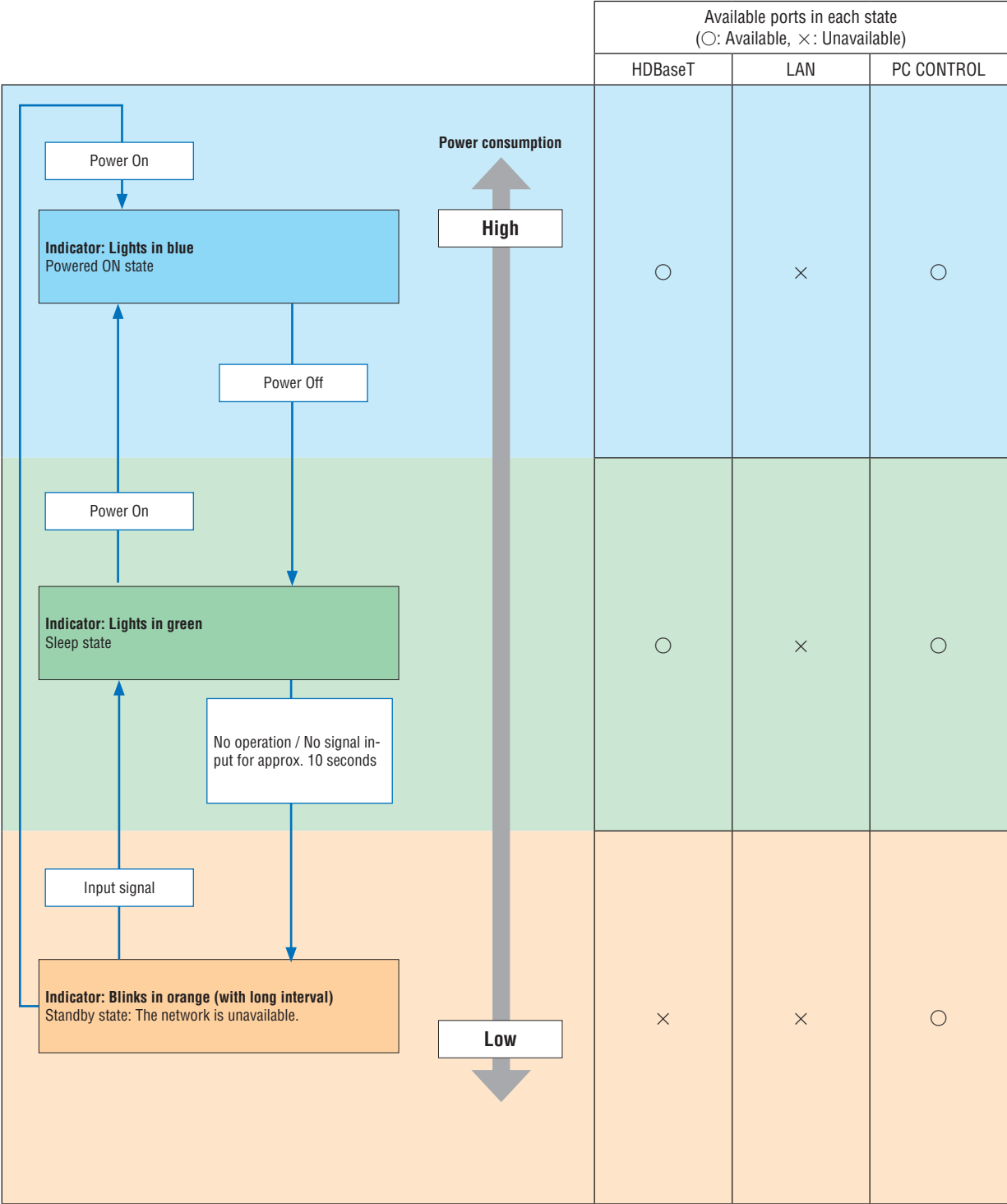

Common Problems & Solutions

(→ “POWER/STATUS/LIGHT/TEMP. Indicator” on page 154.)

Problem	Check These Items
Does not turn on or shut down	<ul style="list-style-type: none"> • Check that the power cord is plugged in and that the power button on the projector cabinet or the remote control is on. (→ pages 14, 16) • Check to see if the projector has overheated. If there is insufficient ventilation around the projector or if the room where you are presenting is particularly warm, move the projector to a cooler location. • The light module may fail to light. Wait a full minute and then turn on the power again. • In case it's hard to think the trouble is not caused on the above mentioned conditions, unplug the power cord from the outlet. Then wait 5 minutes before plugging it in again.
Will turn off	<ul style="list-style-type: none"> • Ensure that the [OFF TIMER], [AUTO POWER OFF] or [PROGRAM TIMER] is off. (→ page 107, 121)
No picture	<ul style="list-style-type: none"> • Check if the appropriate input is selected. (→ page 19) If there is still no picture, press the SOURCE button or one of the source buttons again. • Ensure your cables are connected properly. • Use menus to adjust the brightness and contrast. (→ page 85) • Check that the SHUTTER (lens shutter) or AV MUTE (image off) buttons are not pressed. • Check the [POWER ON SHUTTER] in the onscreen menu is not set to [CLOSE]. • Reset the settings or adjustments to factory preset levels using the [RESET] in the Menu. (→ page 122) • Enter your registered keyword if the Security function is enabled. (→ page 46) • If the HDMI IN 1/2 or the DisplayPort IN 1/2 signal cannot be displayed, try the following. <ul style="list-style-type: none"> - Reinstall your driver for the video card built in your computer, or use the updated driver. For reinstalling or updating your driver, refer to the user guide accompanied with your computer or video card, or contact the support center for your computer manufacturer. Install the updated driver or OS on your own responsibility. We are not liable for any trouble and failure caused by this installation. • Signals may not be supported depending on the HDBaseT transmission device. IR and RS232C cannot be used in certain cases as well. • Be sure to connect the projector and notebook PC while the projector is in standby mode and before turning on the power to the notebook PC. In most cases the output signal from the notebook PC is not turned on unless connected to the projector before being powered up. <ul style="list-style-type: none"> * If the screen goes blank while using your remote control, it may be the result of the computer's screen-saver or power management software. • See also the page 160.
Picture suddenly becomes dark	<ul style="list-style-type: none"> • Check if the projector is in the Forced ECO mode because of too high ambient temperature.
Color tone or hue is unusual	<ul style="list-style-type: none"> • Adjust [HUE] in [PICTURE]. (→ page 85)
Image isn't square to the screen	<ul style="list-style-type: none"> • Reposition the projector to improve its angle to the screen. (→ page 22) • Use the Keystone correction function to correct the trapezoid distortion. (→ page 43)
Picture is blurred	<ul style="list-style-type: none"> • Adjust the focus. (→ page 26) • Reposition the projector to improve its angle to the screen. (→ page 22) • Ensure that the distance between the projector and screen is within the adjustment range of the lens. (→ page 137) • Has the lens been shifted by an amount exceeding the guaranteed range? (→ page 140) • Condensation may form on the lens if the projector is cold, brought into a warm place and is then turned on. Should this happen, let the projector stand until there is no condensation on the lens.
Remote control does not work	<ul style="list-style-type: none"> • Install new batteries. (→ page 11) • Make sure there are no obstacles between you and the projector. • Stand within 22 feet (7 m) of the projector. (→ page 12)
Indicator is lit or blinking	<ul style="list-style-type: none"> • See the POWER/STATUS/LIGHT/TEMP. Indicator. (→ page 154)

For more information contact your dealer.

If there is no picture, or the picture is not displayed correctly.

- Power on process for the projector and the PC.

Be sure to connect the projector and notebook PC while the projector is in standby mode and before turning on the power to the notebook PC.

In most cases the output signal from the notebook PC is not turned on unless connected to the projector before being powered up.

NOTE:

- *You can check the horizontal frequency of the current signal in the projector's menu under Information. If it reads "0kHz", this means there is no signal being output from the computer. (→ page 123 or go to next step)*

- Enabling the computer's external display.

Displaying an image on the notebook PC's screen does not necessarily mean it outputs a signal to the projector. When using a PC compatible laptop, a combination of function keys will enable/disable the external display. Usually, the combination of the "Fn" key along with one of the 12 function keys gets the external display to come on or off. For example, NEC laptops use Fn + F3, while Dell laptops use Fn + F8 key combinations to toggle through external display selections.

- Non-standard signal output from the computer

If the output signal from a notebook PC is not an industry standard, the projected image may not be displayed correctly. Should this happen, deactivate the notebook PC's LCD screen when the projector display is in use. Each notebook PC has a different way of deactivate/reactivate the local LCD screens as described in the previous step. Refer to your computer's documentation for detailed information.

- Image displayed is incorrect when using a Mac

When using a Mac with the projector, set the DIPswitch of the Mac adapter (not supplied with the projector) according to your resolution. After setting, restart your Mac for the changes to take affect.

For setting display modes other than those supported by your Mac and the projector, changing the DIP switch on a Mac adapter may bounce an image slightly or may display nothing. Should this happen, set the DIP switch to the 13" fixed mode and then restart your Mac. After that, restore the DIP switches to a displayable mode and then restart the Mac again.

NOTE:

- *A Video Adapter cable manufactured by Apple Computer is needed for a MacBook which does not have a mini D-Sub 15-pin terminal.*

- Mirroring on a MacBook

* When using the projector with a MacBook, output may not be set to the display resolution of the unit unless "mirroring" is off on your MacBook. Refer to owner's manual supplied with your Mac computer for mirroring.

- Folders or icons are hidden on the Mac screen

Folders or icons may not be seen on the screen. Should this happen, select [View] → [Arrange] from the Apple menu and arrange icons.

10 PC Control Codes and Cable Connection

PC Control Codes

Function	Code Data							
POWER ON	02H	00H	00H	00H	00H	02H		
POWER OFF	02H	01H	00H	00H	00H	03H		
INPUT SELECT HDMI1	02H	03H	00H	00H	02H	01H	A1H	A9H
INPUT SELECT HDMI2	02H	03H	00H	00H	02H	01H	A2H	AAH
INPUT SELECT DisplayPort1	02H	03H	00H	00H	02H	01H	A6H	AEH
INPUT SELECT DisplayPort2	02H	03H	00H	00H	02H	01H	A7H	AFH
INPUT SELECT HDBaseT	02H	03H	00H	00H	02H	01H	20H	28H
INPUT SELECT SDI1	02H	03H	00H	00H	02H	01H	C4H	CCH
INPUT SELECT SDI2	02H	03H	00H	00H	02H	01H	C5H	CDH
INPUT SELECT SDI3	02H	03H	00H	00H	02H	01H	C6H	CEH
INPUT SELECT SDI4	02H	03H	00H	00H	02H	01H	C7H	CFH
INPUT SELECT SLOT	02H	03H	00H	00H	02H	01H	ABH	B3H
PICTURE MUTE ON	02H	10H	00H	00H	00H	12H		
PICTURE MUTE OFF	02H	11H	00H	00H	00H	13H		

NOTE:

- Contact your local dealer for a full list of the PC Control Codes if needed.

Cable Connection

Communication Protocol

Baud rate38400 bps
 Data length8 bits
 ParityNo parity
 Stop bit.....One bit
 X on/off.....None
 Communications procedure.....Full duplex

NOTE:

- Depending on the equipment, a lower baud rate may be recommended for long cable runs.

PC Control Terminal (D-SUB 9P)

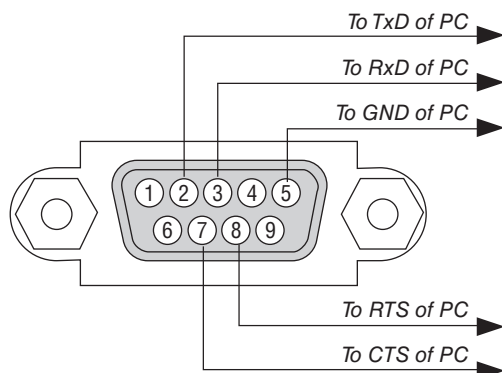

NOTE:

- Pins 1, 4, 6 and 9 are not used.
- Jumper "Request to Send" and "Clear to Send" together on both ends of the cable to simplify cable connection.
- For long cable runs it is recommended to set communication speed within projector menus to 9600 bps.

11 Troubleshooting Check List

Before contacting your dealer or service personnel, check the following list to be sure repairs are needed also by referring to the “Troubleshooting” section in your user’s manual. This checklist below will help us solve your problem more efficiently.

* Print this page and the next page for your check.

Frequency of occurrence always sometimes (How often? _____) other (_____)

Power

- No power (POWER indicator does not light blue). See also “Status Indicator (STATUS)”.
- Power cord’s plug is fully inserted into the wall outlet.
- No power even though you press and hold the POWER button.
- The main power switch is in the “ON (I)” position.
- Shut down during operation.
 - Power cord’s plug is fully inserted into the wall outlet.
 - [AUTO POWER OFF] is turned off (only models with the [AUTO POWER OFF] function).
 - [OFF TIMER] is turned off (only models with the [OFF TIMER] function).

Video and Audio

- No image is displayed from your PC or video equipment to the projector.
 - Still no image even though you connect the projector to the PC first, then start the PC.
 - Enabling your notebook PC’s signal output to the projector.
 - *A combination of function keys will enable/disable the external display. Usually, the combination of the “Fn” key along with one of the 12 function keys turns the external display on or off.*
 - No image (blue or black background, no display).
 - Still no image even though you press the AUTO ADJUST button.
 - Still no image even though you carry out [RESET] in the projector’s menu.
 - Signal cable’s plug is fully inserted into the input terminal
 - A message appears on the screen.
(_____)
 - The source connected to the projector is active and available.
 - Still no image even though you adjust the brightness and/or the contrast.
 - Input source’s resolution and frequency are supported by the projector.
- Image is too dark.
 - Remains unchanged even though you adjust the brightness and/or the contrast.
- Image is distorted.
 - Image appears to be trapezoidal (unchanged even though you carry out the [KEYSTONE] adjustment).
- Parts of the image are lost.
 - Still unchanged even though you press the AUTO ADJUST button.
 - Still unchanged even though you carry out [RESET] in the projector’s menu.
- Image is shifted in the vertical or horizontal direction.
 - Horizontal and vertical positions are correctly adjusted on a computer signal.
 - Input source’s resolution and frequency are supported by the projector.
 - Some pixels are lost.
- Image is flickering.
 - Still unchanged even though you press the AUTO ADJUST button.
 - Still unchanged even though you carry out [RESET] in the projector’s menu.
 - Image shows flickering or color drift on a computer signal.
 - Still unchanged even though you change [FAN MODE] from [HIGH] to [AUTO].
- Image appears blurry or out of focus.
 - Still unchanged even though you checked the signal’s resolution on PC and changed it to projector’s native resolution.
 - Still unchanged even though you adjusted the focus.

Other

- Remote control does not work.
 - No obstacles between the sensor of the projector and the remote control.
 - Projector is placed near a fluorescent light that can disturb the infrared remote controls.
 - Batteries are new and are not reversed in installation.
- Buttons on the projector cabinet do not work (only models with the [CONTROL PANEL LOCK] function)
 - [CONTROL PANEL LOCK] is not turned on or is disabled in the menu.
 - Still unchanged even though you press and hold the EXIT button for a minimum of 10 seconds.

In the space below please describe your problem in detail.

Information on application and environment where your projector is used

Projector

Model number:

Serial No.:

Date of purchase:

Light module operating time (hours):

Eco Mode: OFF ON

Information on input signal:

Horizontal synch frequency [] kHz

Vertical synch frequency [] Hz

Synch polarity H (+) (-)

V (+) (-)

Synch type Separate Composite

Sync on Green

STATUS Indicator:

Steady light Orange Green

Flashing light [] cycles

Remote control model number:

Installation environment

Screen size: inch

Screen type: White matte Beads Polarization
 Wide angle High contrast

Throw distance: feet/inch/m

Orientation: Ceiling mount Desktop

Power outlet connection:

Connected directly to wall outlet

Connected to power cord extender or other (the number of connected equipment _____)

Connected to a power cord reel or other (the number of connected equipment _____)

Computer

Manufacturer:

Model number:

Notebook PC / Desktop

Native resolution:

Refresh rate:

Video adapter:

Other:

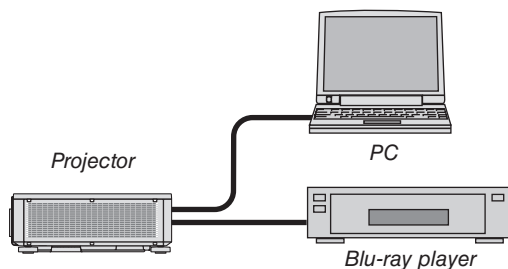

Signal cable

NEC standard or other manufacturer's cable?

Model number: Length: inch/m

Distribution amplifier

Model number:

Switcher

Model number:

Adapter

Model number:

Video equipment

VCR, Blu-ray player, Video camera, Video game or other

Manufacturer:

Model number:

NEC