

Projector

PE455UL/PE455WL/PE505XL

User's Manual

Please visit our web site for User's Manual in the latest version.
https://www.nec-display.com/dl/en/pj_manual/lineup.html

Model No. NP-PE455UL/NP-PE455WL/NP-PE505XL

Table of Contents

Introduction	iii
Important Information	iv
1. Check the product overview, supplied items and part names	1
1-1. Introduction to the Projector	1
1-2. What's in the Box?	4
1-3. Part Names of the Projector	5
1-4. Part Names of the Remote Control	10
2. Projecting an Image (Basic Operation)	15
2-1. Flow of Projecting an Image	15
2-2. Connecting Your Computer/Connecting the Power Cord	16
2-3. Turning on the Projector	18
2-4. Selecting a Source	20
2-5. Adjusting the Picture Size and Position	22
2-6. Correcting Keystone Distortion [KEYSTONE]	28
2-7. Optimizing Computer Signal Automatically	32
2-8. Turning Up or Down Volume	32
2-9. Turning off the Projector	33
2-10. When Moving the Projector	34
3. Convenient Features	35
3-1. Turning off the Image and Sound	35
3-2. Freezing a Picture	35
3-3. Magnifying a Picture	36
3-4. Changing Eco Mode/Checking Energy-Saving Effect	37
3-5. Correcting distortion of projected image	39
3-6. Preventing the Unauthorized Use of the Projector [SECURITY]	45
4. Using On-Screen Menu	48
4-1. Using the Menus	48
4-2. List of Menu Items	50
4-3. Menu Descriptions & Functions [INPUT]	54
4-4. Menu Descriptions & Functions [ADJUST]	55
4-5. Menu Descriptions & Functions [SETUP]	63
4-6. Menu Descriptions & Functions [INFO.]	80
4-7. Menu Descriptions & Functions [RESET]	82

5. Making Connections	83
5-1. Connecting Your Computer	83
5-2. Connecting to a DVD player and other AV devices	86
5-3. Connecting to a Wired LAN	88
5-4. Connecting to a Wireless LAN (Optional: NP05LM series)	89
5-5. Portrait projection (vertical orientation)	92
6. Using the VIEWER	95
6-1. Things you can do with the VIEWER	95
6-2. Projecting the pictures on a USB memory (basic operation)	96
6-3. Slide screen operations	100
6-4. File list screen operations	101
6-5. Option menu	103
6-6. Changing the logo data (background image)	104
7. Connecting to a Network	106
7-1. Things you can do by connecting the projector to a network	106
7-2. Connecting to MultiPresenter	107
7-3. NETWORK SETTINGS	109
7-4. HTTP server function	115
8. Maintenance	119
8-1. Cleaning the Lens	119
8-2. Cleaning the Cabinet	120
9. Appendix	121
9-1. Setting Up the Screen and the Projector	121
9-2. Compatible Input Signal List	131
9-3. Specifications	133
9-4. Cabinet Dimensions	136
9-5. Pin assignments and signal names of main terminals	137
9-6. PC Control Codes and Cable Connection	139
9-7. About the ASCII Control Command	141
9-8. Troubleshooting	143
9-9. Indicator Message	146
9-10. Setting the date and time in the projector	150
9-11. Troubleshooting Check List	152
9-12. REGISTER YOUR PROJECTOR! (for residents in the United States, Canada, and Mexico)	154

Introduction

Thank you for purchasing the NEC projector.

This projector can be connected to computers, video devices, etc. to project images sharply onto a screen.

Please read this manual carefully before using your projector and keep the manual handy for future reference.

Read this user's manual if you have any doubts about operation or if you believe the projector may be faulty.

NOTES



- (1) The contents of this user's manual may not be reprinted in part or whole without permission.
- (2) The contents of this user's manual are subject to change without notice.
- (3) Great care has been taken in the preparation of this user's manual; however, should you notice any questionable points, errors or omissions, please contact us.
- (4) Notwithstanding article (3), NEC will not be responsible for any claims on loss of profit or other matters deemed to result from using the Projector.

Important Information









About the symbols

To ensure safe and proper use of the product, this manual uses a number of symbols to prevent injury to you and others as well as damage to property.

The symbols and their meanings are described below. Be sure to understand them thoroughly before reading this manual.

 WARNING	Failing to heed this symbol and handling the product erroneously could result in accidents leading to death or major injury.
 CAUTION	Failing to heed this symbol and handling the product erroneously could result in personal injury or damage to surrounding property.

Examples of symbols

	This symbol indicates you should be careful of electric shocks.
	This symbol indicates you should be careful of high temperatures.
	This symbol indicates something that must be prohibited.
	This symbol indicates something that must not be got wet.
	This symbol indicates you should not touch with wet hands.
	This symbol indicates something that must not be disassembled.
	This symbol indicates things you must do.
	This symbol indicates that the power cord should be unplugged from the power outlet.

Safety Cautions

WARNING



BE SURE TO DO

Handling the power cord

- Please use the power cord supplied with this projector. If the supplied power cord does not satisfy requirements of your country's safety standard, and voltage and current for your region, make sure to use the power cord that conforms to and satisfies them.

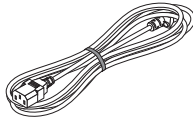

- The power cord you use must be approved by and comply with the safety standards of your country. Please refer to the page [134](#) about the power cord specification.

Rated voltage by country is listed below for your reference. For selecting an appropriate power cord, please check rated voltage for your region by yourself.

AC 230 V	European countries
AC 120 V	North America









PROHIBITION



**HAZARDOUS
VOLTAGE**

- The power cord included with this projector is exclusively for use with this projector. For safety, do not use it with other devices.
- Handle the power cord with care. Damaging the cord could lead to fire or electric shock.
 - Do not place heavy objects on the cord.
 - Do not place the cord under the projector.
 - Do not cover the cord with a rug, etc.
 - Do not scratch or modify the cord.
 - Do not bend, twist or pull the cord with excessive force.
 - Do not apply heat to the cord.

Should the cord be damaged (exposed core wires, broken wires, etc.), ask your dealer to replace it.
- Do not touch the power plug should you hear thunder. Doing so could result in electric shock.

 <p>BE SURE TO DO</p>  <p>PROHIBITION</p>  <p>DO NOT WET</p>  <p>UNPLUG THE POWER CORD</p>	<p>Installing the Projector</p> <ul style="list-style-type: none"> • This projector is designed to be used with a 100–240 V AC, 50/60 Hz power supply. Before using the projector, check that the power supply to which the projector is to be connected meets these requirements. • Use a power outlet as the projector's power supply. Do not connect the projector directly to electrical light wiring. Doing so is dangerous. • Do not use in places such as those described below. Doing so could lead to fire or electric shock. <ul style="list-style-type: none"> - Shaky tables, inclined surfaces or other unstable places - Near heating appliances or places with heavy vibrations - Outdoors or humid or dusty places - Places exposed to oil smoke or steam - Near cooking appliances, humidifiers, etc. • Do not use in places such as those described below where the projector could get wet. Doing so could lead to fire or electric shock. <ul style="list-style-type: none"> - Do not use in the rain or snow, on a seashore or waterfront, etc. - Do not use in a bathroom or shower room. - Do not place vases or potted plants on the projector. - Do not place cups, cosmetics or medicines on the projector. <p>Should water, etc. get inside the projector, first turn off the projector's power, then unplug the power cord from the power outlet and contact your dealer.</p> • Do not insert or drop metal or combustible objects or other foreign materials into the projector from the vents. Doing so could lead to fire or electric shock. Be particularly careful if there are children in the home. Should a foreign object get inside the projector, first turn off the projector's power, then unplug the power cord from the power outlet and contact your dealer.
 <p>UNPLUG THE POWER CORD</p>	<p>Unplug the power cord if the projector malfunctions.</p> <ul style="list-style-type: none"> • Should the projector emit smoke or strange odors or sounds, or if the projector has been dropped or the cabinet broken, turn off the projector's power, then unplug the power cord from the power outlet. Failure to do so could not only lead to fire or electric shock, it could also result in vision impairment. Contact your dealer for repairs. <p>Never try to repair the projector on your own. Doing so is dangerous.</p>
 <p>DO NOT DISASSEMBLE</p>	<p>Do not disassemble the projector.</p> <ul style="list-style-type: none"> • Do not remove or open the projector's cabinet. Also, do not modify the projector. There are high voltage areas in the projector. Modifying the projector could lead to fire, electric shock or leakage of laser beams. <p>Have qualified service personnel perform inspection, adjustments and repairs of the interior.</p>



CAUTION

Installing suspended from the ceiling

- Should special works be required, for example to suspend the projector from the ceiling, consult your dealer.
Never try to install the projector yourself in such cases. The projector could drop and cause injury.
Suspending the projector from the ceiling requires sufficient ceiling strength to support the projector, and the building standards laws in your particular country must be followed.
It is also necessary to take measures to prevent the projector from dropping in anticipation of a malfunction occurring in the projector, ceiling mounting device and installation location.
- When installed suspended from the ceiling, etc. do not hang from the projector. The projector could drop and cause injury.
- When installing suspended from the ceiling, use a power outlet that is within reach so the power cord can be easily plugged and unplugged.



PROHIBITION









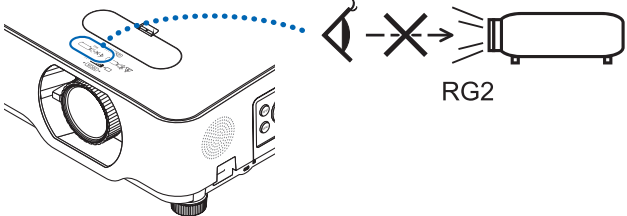

CAUTION
FOR HIGH
TEMPERATURE





Do not place objects in front of the lens while the projector is operating.

- Do not leave the lens cap on the lens while the projector is operating. The lens cap could get hot and be warped.
- Do not place objects in front of the lens that obstruct the light while the projector is operating. The object could get hot and be broken or catch fire.
- The below pictogram indicated on the cabinet means the precaution for avoiding to place objects in front of the projector lens.



<p style="text-align: center;">  PROHIBITION </p>	<p>About the projector's light source</p> <ul style="list-style-type: none"> • Do not look into the projector's lens. Strong light that could damage your eyes is projected when the projector is operating. Be especially careful when children are around. • Do not look at the projected light using optical devices (magnifying glasses, reflectors, etc.). Doing so could result in vision impairment. • Check that there is no one looking at the lens within the projection range before turning on the projector. • Do not allow children to operate the projector alone. When a child is operating the projector an adult should always be present and watch the child carefully. • The below pictogram, that is indicated near the lens on the cabinet, describes this projector is categorized in the risk group 2 of IEC 62471-5:2015. As with any bright light source, do not stare into the beam, RG2 IEC 62471-5:2015. 
<p style="text-align: center;">  PROHIBITION </p>	<p>When cleaning the projector</p> <ul style="list-style-type: none"> • Do not use flammable gas sprays to remove dust from the lens, cabinet, etc. Doing so could lead to fire.

 CAUTION	
 BE SURE TO DO	<p>Connecting the power cord to earth</p> <ul style="list-style-type: none"> This equipment is designed to be used in the condition of the power cord connected to earth. If the power cord is not connected to the earth, it may cause electric shock. Please make sure the power cord is earthed properly. Do not use a 2-core plug converter adapter.
 BE SURE TO DO  DO NOT TOUCH WITH WET HANDS  UNPLUG THE POWER CORD	<p>Handling the power cord</p> <ul style="list-style-type: none"> When connecting the power cord to the projector's AC IN terminal, make sure the connector is fully and firmly inserted. Loose connection of the power cord could lead to fire or electric shock. Do not connect or disconnect the power cord with wet hands. Doing so could result in electric shock. When cleaning the projector, for safety purposes unplug the power cord from the power outlet beforehand. When moving the projector, first be sure to turn off the power, unplug the power cord from the power outlet and check that all connection cables connecting the projector to other devices have been disconnected. When planning not to use the projector for long periods of time, always unplug the power cord from the power outlet.
 PROHIBITION	<p>Do not use on networks subject to overvoltage.</p> <ul style="list-style-type: none"> Connect the projector's LAN port to a network for which there is no risk of overvoltage being applied. Overvoltage applied to the LAN port could result in electric shock.
 BE SURE TO DO	<p>Lens shift, focus and zoom operations</p> <ul style="list-style-type: none"> When shifting the lens or adjusting the focus or zoom, do so from either behind or to the side of the projector. If these operations are performed from the front, your eyes could be exposed to strong light and get injured. Keep your hands away from the lens area when performing the lens shift operation. If not, your fingers could get caught in the gap between the cabinet and the lens.

 <p>PROHIBITION</p>	<p>Handling batteries</p> <ul style="list-style-type: none"> • Handle batteries with caution. Failure to do so could lead to fire, injury or contamination of the surroundings. <ul style="list-style-type: none"> - Do not short-circuit or take apart batteries or dispose of them in flames. - Do not use batteries other than those specified. - Do not use new batteries together with old ones. - When inserting batteries, pay attention to the polarities (+ and – directions), and be sure to insert them as indicated. • Contact your dealer or local authorities when disposing of batteries.
 <p>PROHIBITION</p>  <p>CAUTION FOR HIGH TEMPERATURE</p>	<p>About the vents</p> <ul style="list-style-type: none"> • Do not obstruct the projector's vents. Also, do not place such soft objects as paper or cloths underneath the projector. Doing so could lead to fire. Leave sufficient space between the place where the projector is installed and its surroundings (as a general rule, at least 10 cm/4 inches for the intake vent, 20 cm/8 inches for the exhaust vent). • Do not touch the exhaust vent area while projecting or immediately after projecting images. The exhaust vent area may be hot at this time and touching it could cause burns.
 <p>PROHIBITION</p>	<p>Moving the projector</p> <ul style="list-style-type: none"> • When moving the projector, do not hold the lens section. The focus ring could turn, causing the projector to drop and resulting in injury. Also, if you put your hand on the gap between the cabinet and the lens, the projector may be damaged, falling and causing injury.
 <p>BE SURE TO DO</p>	<p>Inspecting the projector and cleaning the inside</p> <ul style="list-style-type: none"> • Consult with your dealer about once per year for cleaning of the inside of the projector. Dust could accumulate inside of the projector if it is not cleaned for extended periods of time, leading to fires or malfunction.

Laser Safety Caution

WARNING

CLASS 2 OF IEC 60825-1 SECOND EDITION LASER PRODUCT

- LASER RADIATION - DO NOT STARE INTO BEAM.
- Use of controls or adjustments or performance of procedures other than those specified herein may result in hazardous radiation exposure.

• For USA

This product is classified as Class 2 of IEC 60825-1 Second edition 2007-03.

Complies with FDA performance standards for laser products except for deviations pursuant to Laser Notice No. 50, dated June 24, 2007.

For other regions

This product is classified as Class 1 of IEC 60825-1 Third edition 2014-05 and RG2 of IEC 62471-5 First edition 2015-06.

Obey the laws and regulations of your country in relation to the installation and management of the device.

- Outline of laser emitted from the built-in light module:
 - Wave length: 449–461 nm
 - Maximum power: 82.5 W
- Radiation pattern from the protective housing:
 - Wave length: 449–461 nm
 - Maximum laser radiation output: 66.6 mW
- The laser module is equipped in this product. Use of controls or adjustments of procedures other than those specified herein may result in hazardous radiation exposure.

Light Module

- A light module containing multiple laser diodes is equipped in the product as the light source.
- These laser diodes are sealed in the light module. No maintenance or service is required for the performance of the light module.
- End user is not allowed to replace the light module.
- Contact qualified distributor for light module replacement and further information.

- The caution and the explanatory labels of the LASER PRODUCT in CLASS 2 conforming to IEC 60825-1 Second edition, and in Class 1 conforming to IEC 60825-1 Third edition are stuck on the below indicated positions.

For USA

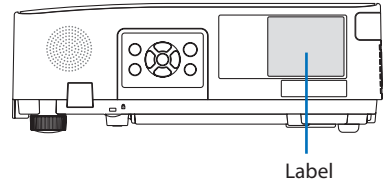

For other regions



Laser light radiation range

The figure below shows the maximum radiation range of the laser light.

Horizontal angle (unit: degree)

Zoom	Lens position		
	Right most	Center (Reference value)	Left most
	HR	HC	HL
Wide	33.0	22.3	33.0
Tele	21.8	14.2	21.8

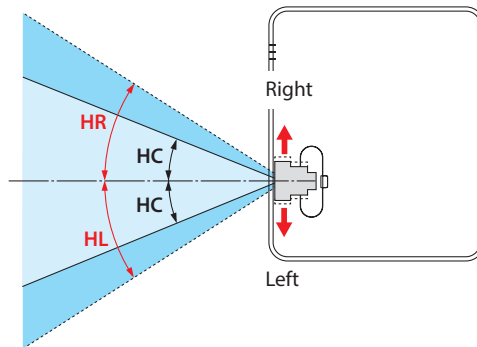

Vertical angle (unit: degree)

Zoom	Lens position	
	Upper most	Center (Reference value)
	VU	VC
Wide	29.5	14.4
Tele	19.2	9.0

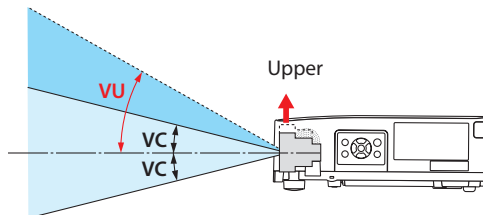

Cable information

Use shielded cables or cables attached ferrite cores so as not to interfere with radio and television reception.

For details, please refer to “5. Making Connections” in this user’s manual.

FCC Information (for USA only)

WARNING

- The Federal Communications Commission does not allow any modifications or changes to the unit EXCEPT those specified by NEC Display Solutions of America, Inc. in this manual. Failure to comply with this government regulation could void your right to operate this equipment.
- This equipment has been tested and found to comply with the limits for a Class B digital device, pursuant to Part 15 of the FCC Rules. These limits are designed to provide reasonable protection against harmful interference in a residential installation. This equipment generates, uses, and can radiate radio frequency energy and, if not installed and used in accordance with the instructions, may cause harmful interference to radio communications. However, there is no guarantee that interference will not occur in a particular installation.

If this equipment does cause harmful interference to radio or television reception, which can be determined by turning the equipment off and on, the user is encouraged to try to correct the interference by one or more of the following measures:

- Reorient or relocate the receiving antenna.
- Increase the separation between the equipment and receiver.
- Connect the equipment into an outlet on a circuit different from that to which the receiver is connected.
- Consult the dealer or an experienced radio / TV technician for help.

Supplier’s declaration of conformity (for USA only)

This device complies with Part 15 of FCC Rules. Operation is subject to the following two conditions.

(1) This device may not cause harmful interference, and (2) this device must accept any interference received, including interference that may cause undesired operation.

U.S.Responsible Party:	NEC Display Solutions of America, Inc.
Address:	3250 Lacey Rd, Ste 500 Downers Grove, IL 60515
Telephone Number:	630-467-3000
Type of Product:	Projector
Equipment Classification:	Class B Peripheral
Model Number:	NP-PE455UL/NP-PE455WL/NP-PE505XL



Disposing of your used product



In the European Union

EU-wide legislation as implemented in each Member State requires that used electrical and electronic products carrying the mark (left) must be disposed of separately from normal household waste. This includes projectors and their electrical accessories. When you dispose of such products, please follow the guidance of your local authority and/or ask the shop where you purchased the product.

After collecting the used products, they are reused and recycled in a proper way. This effort will help us reduce the wastes as well as the negative impact to the human health and the environment at the minimum level.

The mark on the electrical and electronic products only applies to the current European Union Member States.

Outside the European Union

If you wish to dispose of used electrical and electronic products outside the European union, please contact your local authority and ask for the correct method of disposal.



For EU: The crossed-out wheeled bin implies that used batteries should not be put to the general household waste! There is a separate collection system for used batteries, to allow proper treatment and recycling in accordance with legislation.

According the EU directive 2006/66/EC, the battery can't be disposed improperly. The battery shall be separated to collect by local service.

(for Germany only)

Machine Noise Information Regulation - 3. GPSGV,

The highest sound pressure level is less than 70 dB (A) in accordance with EN ISO 7779.

Information of the AUDIO OUT mini jack

The AUDIO OUT mini jack does not support earphone/headphone terminal.

Cautions for ensuring the projector's performance

- Do not install in places subject to vibrations or shocks.
If installed in places where the vibrations from power sources and the like are conveyed, or in vehicles or on vessels, etc. the projector could be affected by vibrations or shocks that may damage internal parts and lead to malfunction.
Install in a place not subject to vibrations or shocks.
- Do not install near high voltage power lines or power sources.
The projector may be affected by interference if it is installed near a high voltage power line or a power source.
- Do not install or store in such places as those described below. Doing so could lead to malfunction.
 - Places where strong magnetic fields are generated
 - Places where corrosive gases are generated
- If intense light like laser beams enters from the lens, it could lead to malfunction.
- Consult your dealer before using in places where much cigarette smoke or dust is present.
- When the same still image is projected for a long period of time with a computer, etc. the pattern of the image may remain on the screen after the projection is stopped, but it will disappear after a while. This happens due to the properties of liquid crystal panels, and is not a malfunction. We recommend using a screensaver on the computer side.
- When using the projector at altitudes of about 1,600 m/5,200 feet or higher, be sure to set the [FAN MODE] to [HIGH ALTITUDE]. If not, the inside of the projector may get hot, leading to malfunction.
- When the projector is used at high altitudes (places where the atmospheric pressure is low), it may be necessary to replace the optical parts (light source, etc.) sooner than usual.
- About moving the projector
 - Be sure to mount the included lens cap to protect the lens from scratches.
 - Do not subject the projector to vibrations or strong shocks.
The projector could be damaged otherwise.
- Do not use the tilt feet for purposes other than adjusting the projector's tilt.
Improper handling, such as carrying the projector by the tilt feet or using it leaned against a wall, could lead to malfunction.
- Do not touch the surface of the projection lens with bare hands.
Fingerprints or dirt on the surface of the projection lens will be enlarged and projected on the screen. Do not touch the surface of the projection lens.
- Do not unplug the power cord from the projector or the power outlet while projecting. Doing so could cause deterioration of the projector's AC IN terminal or power plug contact. To interrupt the AC power supply while images are being projected, use a power strip switch, a breaker, etc.
- About handling of the remote control
 - The remote control will not work if the projector's remote signal sensor or the remote control's signal transmitter is exposed to strong light or if there are obstacles between them that obstruct the signals.
 - Operate the remote control from within 7 meters from the projector, pointing it at the projector's remote signal sensor.
 - Do not drop the remote control or handle it improperly.
 - Do not let water or other liquids get on the remote control. Should the remote control get wet, wipe it off immediately.
 - Avoid using in hot and humid places as far as possible.
 - When planning not to use the remote control for long periods of time, remove both batteries.

- Take measures to prevent external light from shining on the screen. Make sure only the light from the projector shines on the screen. The less external light on the screen, the higher the contrast and the more beautiful the images.
- About screens
Images will not be clear if there is dirt, scratches, discoloration, etc. on your screen. Handle the screen with care, protecting it from volatile substances, scratches and dirt.

Clearance for Installing the Projector

When installing the projector, keep sufficient space around it, as described below. If not, the hot exhaust emitted from the projector may be taken back in.

Also, make sure no wind from an air-conditioner hits the projector.

The projector's heat control system may detect an abnormality (temperature error) and automatically shut off the power.

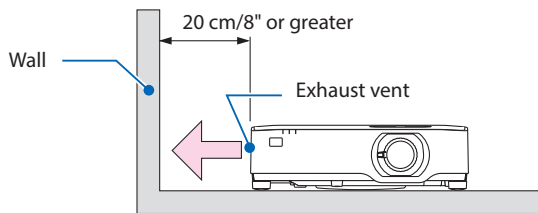

NOTE:

- In the above figure, it is assumed that there is sufficient space above the projector. There is also an intake vent on the back. Leave about 10 cm or more space behind, and even more space for installing the cables.

Precautions for Ceiling Installation

Do not install the projector in the following places. Attached substances such as oil, chemicals and moisture may cause deformation or cracks of the cabinet, corrosion of the metal parts, or malfunction.

- Outdoors and places with humid or dust
- Places exposed to oil smoke or steam
- Places where corrosive gases are generated

About Copyright of original projected pictures:

Please note that using this projector for the purpose of commercial gain or the attraction of public attention in a venue such as a coffee shop or hotel and employing compression or expansion of the screen image with the following functions may raise concern about the infringement of copyrights which are protected by copyright law.

[ASPECT RATIO], [KEYSTONE], Magnifying feature and other similar features.

Power management function

The projector has power management functions. To reduce power consumption, the power management functions (1 and 2) are factory preset as shown below. To control the projector from an external device via a LAN or serial cable connection, use the on-screen menu to change the settings for 1 and 2.

1. STANDBY MODE (Factory preset: NORMAL)

To control the projector from an external device, select [NETWORK STANDBY] or [SLEEP] for [STANDBY MODE]. (→ page 76)

2. AUTO POWER OFF (Factory preset: 1 hour)

To control the projector from an external device, select [OFF] for [AUTO POWER OFF]. (→ page 78)

Model Number of Wireless LAN unit

Wireless LAN unit is an optional item.

To find the appropriate model to your area, please visit the company website:

URL: <https://www.nec-display.com/global/support/index.html>

Trademarks

- MultiPresenter is a trademark or registered trademark of NEC Display Solutions, Ltd. in Japan and other countries.
- Apple, Mac, MacBook, and iMac are trademarks of Apple Inc. registered in the U.S. and other countries.
- Microsoft, Windows, and PowerPoint are either a registered trademark or trademark of Microsoft Corporation in the United States and/or other countries.
- The terms HDMI and HDMI High-Definition Multimedia Interface, and the HDMI Logo are trademarks or registered trademarks of HDMI Licensing Administrator, Inc. in the United States and other countries.



- PLink trademark and logo are trademarks applied for registration or are already registered in Japan, the United States of America and other countries and areas.
- Wi-Fi® is a registered trademark of the Wi-Fi Alliance®. WPA™, WPA2™ are trademarks of the Wi-Fi Alliance®.
- Blu-ray is a trademark of Blu-ray Disc Association.
- CRESTRON and CRESTRON ROOMVIEW are trademarks or registered trademarks of Crestron Electronics, Inc. in the United States and other countries.
- Other product names and company logos mentioned in this user's manual may be the trademarks or registered trademarks of their respective holders.
- GPL/LGPL Software Licenses

The product includes software licensed under GNU General Public License (GPL), GNU Lesser General Public License (LGPL), and others.

For more information on each software, see "readme.pdf" inside the "about GPL&LGPL" folder on the supplied CD-ROM.

1. Check the product overview, supplied items and part names

1-1. Introduction to the Projector

This section introduces you to your new projector and describes the features and controls.

General

- **Liquid crystal type high brightness/high resolution projector**

Model name	Brightness	Resolution	Aspect ratio
PE455UL	4,500 lm	WUXGA (1920 × 1200 pixels)	16:10
PE455WL	4,500 lm	WXGA (1280 × 800 pixels)	16:10
PE505XL	5,000 lm	XGA (1024 × 768 pixels)	4:3

- **A proprietary sealed structure that achieves highly dust-proof performance**

Due to its excellent dust-proof performance, the projector is not equipped with a filter. Filter replacement is therefore unnecessary.

- **Silent design utilizing a sealed structure**

A silent design with no irritating fan noise even in a quiet conference room or classroom.

Light source • Brightness

- **A long-life laser diode is equipped in the light module**

The product can be operated at low cost because the laser light source can be used for a long time without requiring replacement or maintenance.

- **Brightness can be adjusted within a wide range**

Unlike with ordinary light sources, the brightness can be adjusted from 30 to 100% (PE455WL: 33 to 100%) in 1% increments.

- **[CONSTANT BRIGHTNESS] mode**

Brightness normally decreases with use, but by selecting [CONSTANT BRIGHTNESS] mode, the projector automatically controls the output from the light module according to the light module used time for maintaining constant brightness.

Installation

- **360° installation and portrait projection**

The projector can be installed at any angle from 0° to 360° in both the vertical and horizontal direction. When installing the projector in a tilted position, use brackets of sufficient strength. Portraits can also be projected with the projection screen tilted 90°. Be sure to assemble and install a dedicated stand.

- **Lens shift mechanism for adjusting the position of the projected image easily**

The position of the projected image is moved by turning the two dials on the projector cabinet top, one for the vertical direction and another for the horizontal direction.

- **Correct projected image distortion on specially shaped surfaces**

Distortion when projecting on specially shaped surfaces (cylindrical or spherical surfaces, for example) can be corrected using our Geometric Correction Tool application.

Videos

- **Wide range of input terminals (HDMI × 2, etc.)**

The projector is equipped with a variety of input terminals: HDMI (× 2), Computer (analog), etc. HDMI input terminal on this product supports HDCP.

- **[VIEWER] function to project still images saved in a USB memory**

When you insert a commercially available USB memory containing the picture into the USB port of the projector (Type A), the images on the USB can be projected by the unit. By doing this, you can make a presentation without using a personal computer.

- **Seamless switch function for smoother screen changes when switching the signal**

When the input connector is switched, the image displayed before switching is held so that that the new image can be switched to without a break due to absence of a signal.

Network

- **Compatible with wired LAN / wireless LAN**

Equipped with a LAN port (RJ-45), the projector can be connected to a wired LAN to transmit images from a computer to this unit or to control this unit from the computer. In addition, when a wireless LAN unit sold separately is attached to the unit, the unit can be connected to a wireless LAN.

- **CRESTRON ROOMVIEW compatibility**

The projector supports CRESTRON ROOMVIEW, allowing multiple devices connected in the network to be managed and controlled from a computer.

- **Compatible with the MultiPresenter application**

This projector is compatible with the NEC MultiPresenter application, so multi-screen projection is possible via the network (wired LAN/wireless LAN).

Energy-saving

- **0.11 W (100-130 V AC)/0.16 W (200-240 V AC) in standby condition with energy saving technology**

Selecting [NORMAL] for [STANDBY MODE] from the menu can put the projector in power-saving mode.

NORMAL: 0.11 W (100-130 V AC)/0.16 W (200-240 V AC)

NETWORK STANDBY: 1.6 W (100-130 V AC)/1.8 W (200-240 V AC)

- **[ECO MODE] for low power consumption and [CARBON METER] display**

The projector is equipped with a [ECO MODE] for reducing power consumption during use. Furthermore, the power-saving effect when the [ECO MODE] is set is converted into the amount of reductions of CO₂ emissions and this is indicated on the confirmation message displayed when the power is turned off and at [INFO.] on the on-screen menu ([CARBON METER]).

1. Check the product overview, supplied items and part names

1-2. What's in the Box?

Make sure your box contains everything listed. If any pieces are missing, contact your dealer. Please save the original box and packing materials if you ever need to ship your projector.

Projector

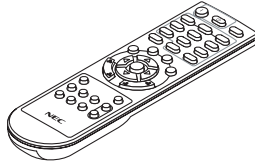
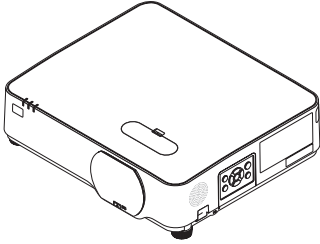

Remote control
(7N901261)

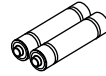

Batteries (AAA × 2)

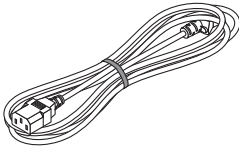

Power cord
(US: 7N080236/7N080242)
(EU: 7N080022/7N080028)

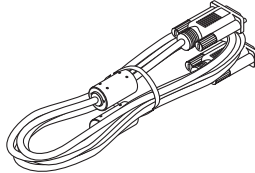

Computer cable (VGA)
(7N520089)

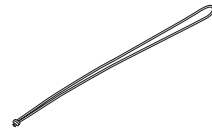

Lens cap strap

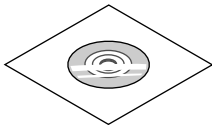

NEC Projector CD-ROM
(7N952911)

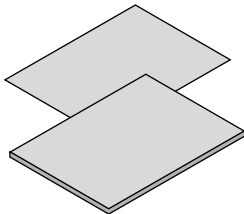

- **Important Information**
(7N8N9901)
- **Quick Setup Guide**
(For North America: 7N8N9881)
(For Other countries than North America: 7N8N9881 and 7N8N9891)
- **Security Sticker**
(Use this sticker when security password is set on.)

For North America only

- **Limited warranty**

For customers in Europe:

You will find our current valid Guarantee Policy on our Web Site:

<https://www.nec-display-solutions.com>

1-3. Part Names of the Projector

Front

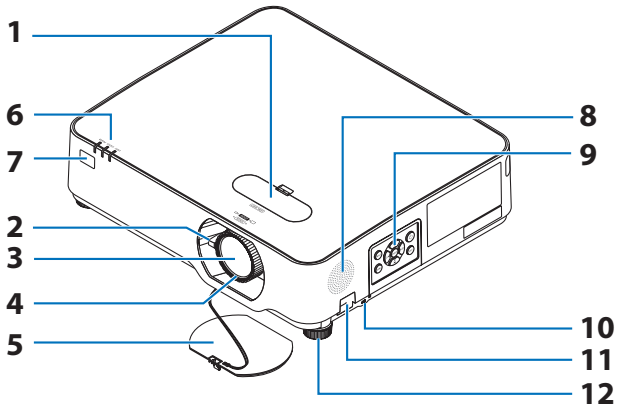

1. Lens shift cover

(→ page 23)

2. Zoom Lever

(→ page 26)

3. Lens

4. Focus Ring

(→ page 25)

5. Lens Cap

6. Indicators

(→ page 8, 146)

7. Remote Sensor

(→ page 14)

8. Monaural Speaker

9. Controls

(→ page 8)

10. Security Slot (🔒)

11. Security chain opening

Attach an anti-theft device.

The security chain opening accepts security wires or chains up to 0.18 inch/4.6 mm in diameter.

12. Tilt Foot

(→ page 27)

TIP:

- Security and theft protection lock compatible with Kensington security cables/equipment. For products, visit Kensington's website.
-

Mounting the lens cap strap

1. Insert the tip of the strap into the lens cap mount hole and pass the knot through.

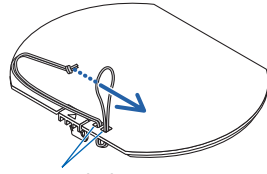

Lens cap mount hole

2. Insert the knot into the strap mount hole (large) on the bottom of the projector, then press it into the narrow (small) hole.

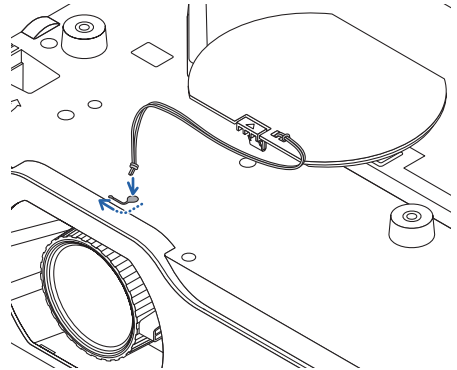

Rear

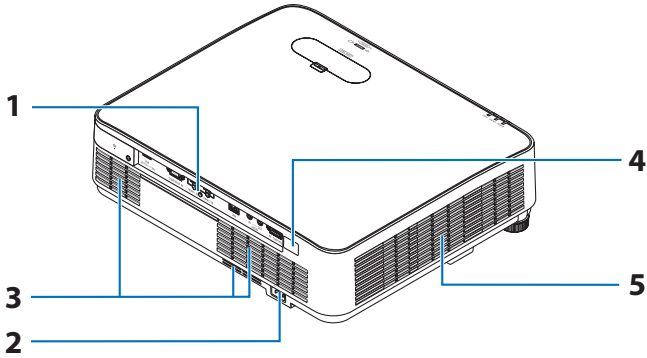

1. Terminal Panel

(→ page 9)

2. AC Input

Connect the supplied power cord's three-pin plug here, and plug the other end into an active wall outlet.

(→ page 16)

3. Intake Vent

4. Remote Sensor

(→ page 14)

5. Exhaust Vent

Controls/Indicators

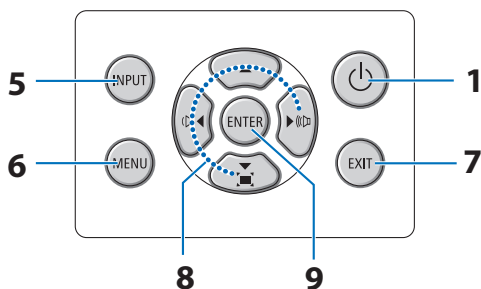
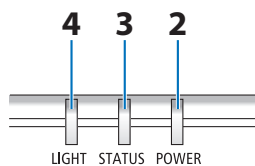

1.  **(POWER) Button**
(→ page 18, 33)
2. **POWER Indicator**
(→ page 16, 18, 33, 146)
3. **STATUS Indicator**
(→ page 146)
4. **LIGHT Indicator**
(→ page 146)
5. **INPUT Button**
(→ page 20)
6. **MENU Button**
(→ page 48)
7. **EXIT Button**
(→ page 48)
8. **▲▼◀▶ / Volume Buttons ◀▶ / Keystone Button ▼**
(→ page 28, 32, 48)
9. **ENTER Button**
(→ page 48)

Terminal Panel Features

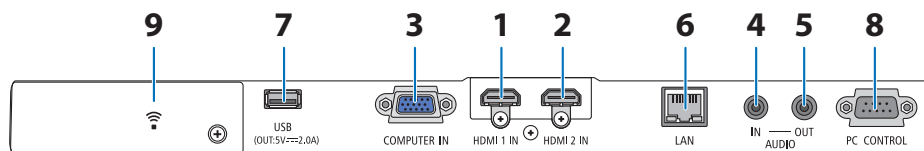

1. HDMI 1 IN Terminal (Type A)

(→ page 84, 85, 87)

2. HDMI 2 IN Terminal (Type A)

(→ page 84, 85, 87)

3. COMPUTER IN/ Component Input Terminal (Mini D-Sub 15 Pin)

(→ page 84, 86)

4. AUDIO IN Mini Jack (Stereo Mini)

(→ page 84, 86)

5. AUDIO OUT Mini Jack (Stereo Mini)

Audio signal of the image projected from the projector is output.

When audio equipment is connected, the projector speaker is disabled.

6. LAN Port (RJ-45)

(→ page 88)

7. USB Port (Type A)

Connect the USB memory. When picture data is saved in a USB memory, the picture can be projected with the [VIEWER] of the projector.

(→ page 95)

In addition, a 5 V/2.0 A power supply can be supplied for expansion use.

8. PC CONTROL Port (D-Sub 9 Pin)

Use this port to connect a PC or control system. This enables you to control the projector using serial communication protocol. If you are writing your own program, typical PC control codes are on page 139.

9. Wireless LAN cover ()

There are two terminals behind the cover.

- USB (Wireless LAN) Port
(→ page 90)
- SERVICE Port (USB Type B)
(for service purpose only)

1-4. Part Names of the Remote Control

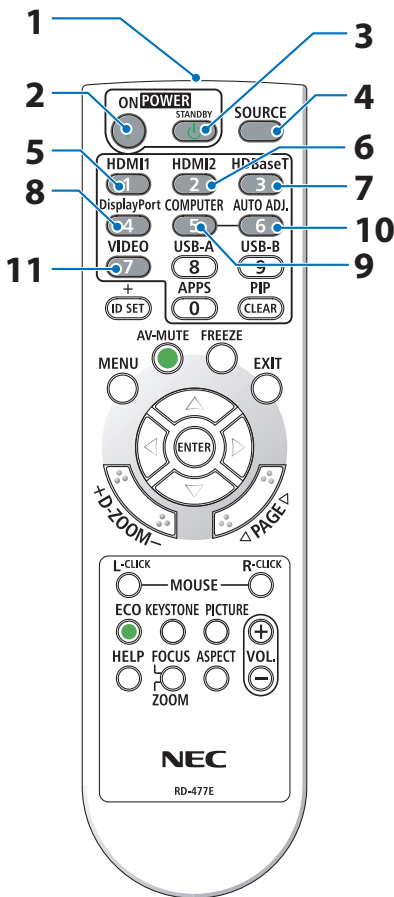

- 1. Infrared Transmitter**
(→ page 14)
- 2. POWER ON Button**
(→ page 18)
- 3. POWER STANDBY Button**
(→ page 33)
- 4. SOURCE Button**
(→ page 20)
- 5. HDMI1 Button**
(→ page 20)
- 6. HDMI2 Button**
(→ page 20)
- 7. HDBaseT Button**
(This button does not work in this series of projectors)
- 8. DisplayPort Button**
(This button does not work in this series of projectors)
- 9. COMPUTER Button**
(→ page 20)
- 10. AUTO ADJ. Button**
(→ page 32)
- 11. VIDEO Button**
(This button does not work in this series of projectors)

1. Check the product overview, supplied items and part names

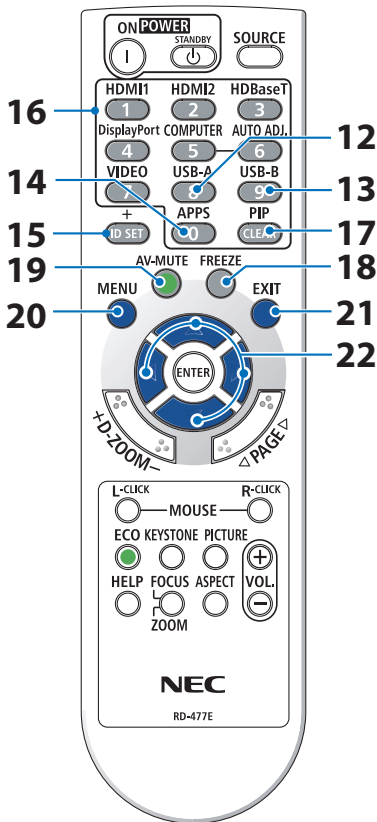

12. USB-A Button

(→ page 20, 96)

13. USB-B Button

(This button does not work in this series of projectors)

14. APPS Button

(→ page 20, 107)

15. ID SET Button

(→ page 73)

16. Numeric Keypad Button/CLEAR Button

(→ page 73)

17. PIP Button

(This button does not work in this series of projectors)

18. FREEZE Button

(→ page 35)

19. AV-MUTE Button

(→ page 35)

20. MENU Button

(→ page 48)

21. EXIT Button

(→ page 48)

22. ▲▼◀▶ Button

(→ page 36, 48)

1. Check the product overview, supplied items and part names

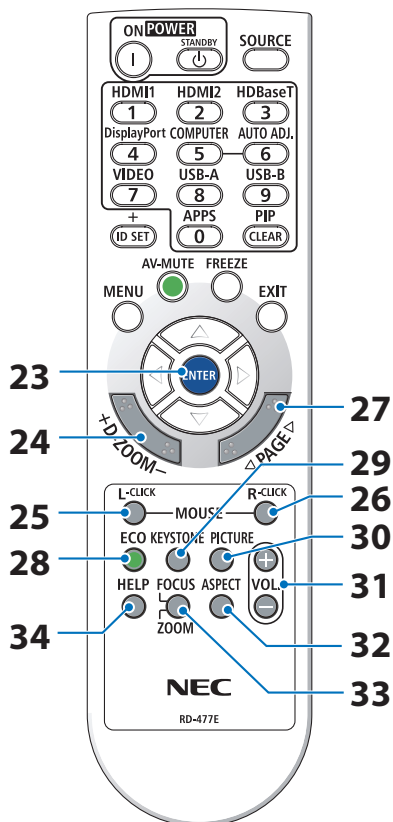

23. ENTER Button

(→ page 48)

24. D-ZOOM (+)(-) Button

(→ page 36)

25. MOUSE L-CLICK Button

(This button does not work in this series of projectors)

26. MOUSE R-CLICK Button

(This button does not work in this series of projectors)

27. PAGE ∇/Δ Button

(→ page 100, 102)

28. ECO Button

(→ page 37)

29. KEYSTONE Button

(→ page 28, 39)

30. PICTURE Button

(→ page 55, 58)

31. VOL. (+)(-) Button

(→ page 32)

32. ASPECT Button

(→ page 61)

33. FOCUS/ZOOM Button

(This button does not work in this series of projectors)

34. HELP Button

(→ page 80)

Battery Installation

1. Press firmly and slide the battery cover off.

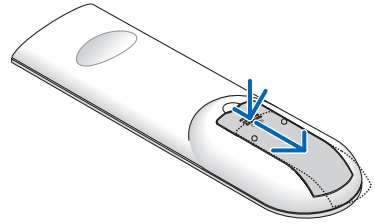

2. Install new batteries (AAA). Ensure that you have the batteries' polarity (+/-) aligned correctly.

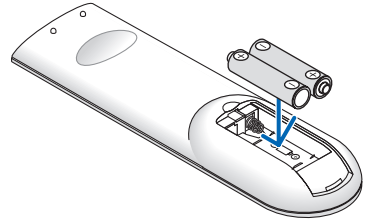

3. Slip the cover back over the batteries until it snaps into place. Do not mix different types of batteries or new and old batteries.

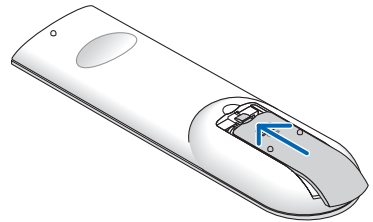

Remote Control Precautions

- Handle the remote control carefully.
- If the remote control gets wet, wipe it dry immediately.
- Avoid excessive heat and humidity.
- Do not short, heat, or take apart batteries.
- Do not throw batteries into fire.
- If you will not be using the remote control for a long time, remove the batteries.
- Ensure that you have the batteries' polarity (+/-) aligned correctly.
- Do not use new and old batteries together, or use different types of batteries together.
- Dispose of used batteries according to your local regulations.

Operating Range for Wireless Remote Control

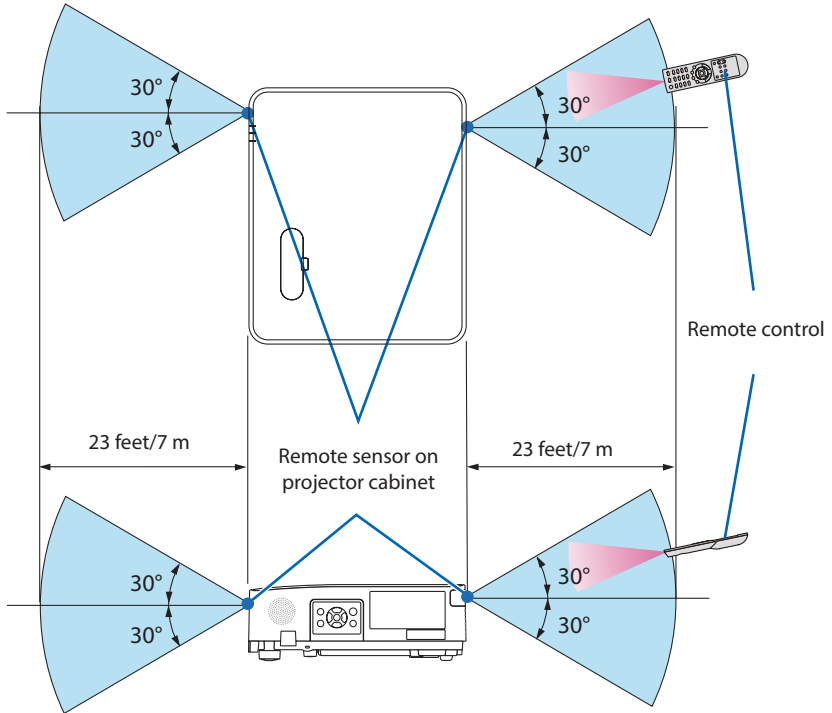

- The infrared signal operates by line-of-sight up to a distance of about 23 feet/7 m and within a 60-degree angle of the remote sensor on the projector cabinet.
- The projector will not respond if there are objects between the remote control and the sensor, or if strong light falls on the sensor. Weak batteries will also prevent the remote control from properly operating the projector.

2. Projecting an Image (Basic Operation)

This section describes how to turn on the projector and to project a picture onto the screen.

2-1. Flow of Projecting an Image

Step 1

- **Connecting your computer / Connecting the power cord** (→ [page 16](#))



Step 2

- **Turning on the projector** (→ [page 18](#))



Step 3

- **Selecting a source** (→ [page 20](#))



Step 4

- **Adjusting the picture size and position** (→ [page 22](#))
- **Correcting keystone distortion [KEYSTONE]** (→ [page 28](#))



Step 5

- **Adjusting a picture and sound**
 - Optimizing a computer signal automatically (→ [page 32](#))
 - Turning up or down volume (→ [page 32](#))



Step 6

- **Making a presentation**



Step 7

- **Turning off the projector** (→ [page 33](#))



Step 8

- **When Moving the Projector** (→ [page 34](#))

2-2. Connecting Your Computer/Connecting the Power Cord

1. Connect your computer to the projector.

This section will show you a basic connection to a computer. For information about other connections, see “5. Making Connections” on page 83.

Connect the computer cable (VGA) between the projector’s COMPUTER IN terminal and the computer’s port (mini D-Sub 15 Pin). Turn two thumb screws of both terminals to fix the computer cable (VGA).

2. Connect the supplied power cord to the projector.

First connect the supplied power cord’s three-pin plug to the AC IN terminal of the projector, and then connect another plug of the supplied power cord directly in the wall outlet. Do not use any plug converter.

CAUTION:

This equipment is designed to be used in the condition of the power cord connected to earth. If the power cord is not connected to the earth, it may cause electric shock. Please make sure the power cord is earthed properly.

When the power cord is connected, the POWER indicator of this projector flashes orange and the unit goes into the standby mode. (In the state, [STANDBY MODE] is [NORMAL].)

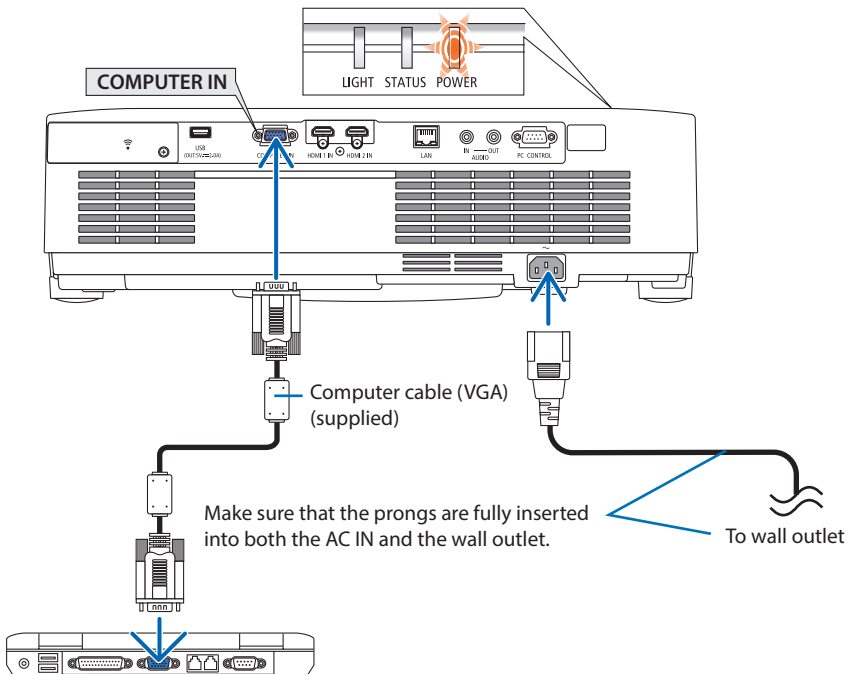

**CAUTION:**

Parts of the projector may become temporarily heated if the projector is turned off with the POWER button. Be careful to handle the projector.

2-3. Turning on the Projector

WARNING

The projector produces a strong light. When turning on the power, make sure no one within projection range is looking at the lens.

1. Remove the lens cap.

With the lens cap's stopper pressed up, pull forward and off.

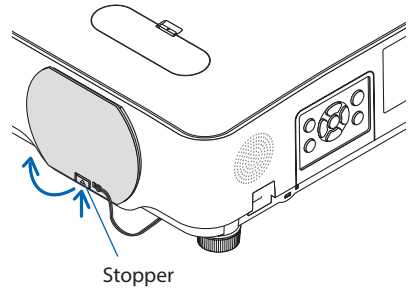

2. Press the (POWER) button on the projector cabinet or the POWER ON button on the remote control.

The POWER indicator lights blue and the image is projected on the screen.

TIP:

- When the message "PROJECTOR IS LOCKED ! ENTER YOUR KEYWORD." is displayed, it means that the [SECURITY] feature is turned on. (→ page 46)

After you turn on your projector, ensure that the computer or video source is turned on.

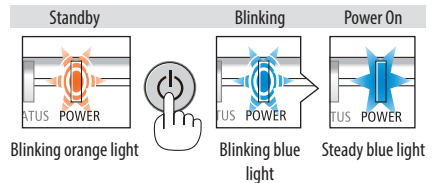
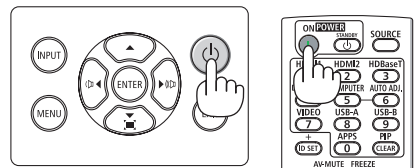

NOTE:

- When no input signal is present, the no-signal guidance is displayed (factory menu setting).

Note on Startup screen (Menu Language Select screen)

When you first turn on the projector, you will get the Startup menu. This menu gives you the opportunity to select one of the 30 menu languages.

To select a menu language, follow these steps:

1. Use the ▲, ▼, ◀ or ▶ button to select one of the 30 languages from the menu.

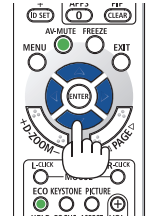
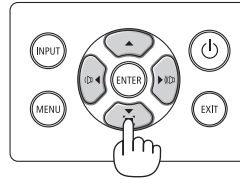

2. Press the ENTER button to execute the selection.

After this has been done, you can proceed to the menu operation.

If you want, you can select the menu language later.

(→ [LANGUAGE] on pages 51 and 65)

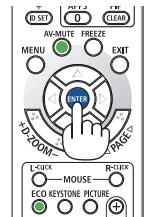
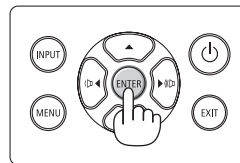

NOTE:

- If one of the following things happens, the projector will not turn on.
 - If the internal temperature of the projector is too high, the projector detects abnormal high temperature. In this condition the projector will not turn on to protect the internal system. If this happens, wait for the projector's internal components to cool down.
 - If the STATUS indicator lights orange with the power button pressed, it means that the [CONTROL PANEL LOCK] is turned on. Cancel the lock by turning it off. (→ page 71)
- While the POWER indicator is blinking blue in short cycles, the power cannot be turned off by using the power button.

2-4. Selecting a Source

Selecting the computer or video source

NOTE:

- Turn on the computer or video source equipment connected to the projector.

Detecting the Signal Automatically

Press the INPUT button once. The projector will search for the available input source and display it. The input source will change as follows:

[HDMI1] → [HDMI2] → [COMPUTER] → [USB-A] → [LAN]

- With the [INPUT] screen displayed, you can press the INPUT button a few times to select the input source.

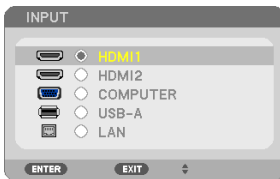

- Press the SOURCE button when using the remote control.

TIP:

- If no input signal is present, the input will be skipped.

Using the Remote Control

Press any one of the HDMI1, HDMI2, COMPUTER, USB-A, or APPS buttons.

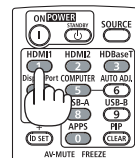
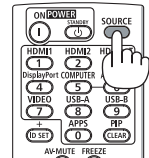
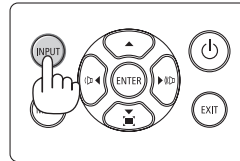

Selecting Default Source

You can so that it will be displayed each time the projector is turned on.

1. Press the MENU button.

The menu will be displayed.

2. Press the ► button twice to select [SETUP] and the ▼ button or the ENTER button to select [GENERAL].

3. Press the ► button five times to select [OPTIONS(2)].

4. Press the ▼ button five times to select [DEFAULT INPUT SELECT] and press the ENTER button.

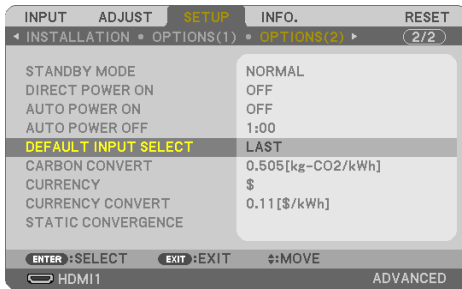

The [DEFAULT INPUT SELECT] screen will be displayed.

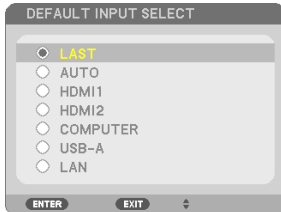

5. Select a source as the default source, and press the ENTER button.

6. Press the EXIT button a few times to close the menu.

7. Restart the projector.

The source you selected in step 5 will be projected.

TIP:

- When the projector and computer are connected and the projector is in standby, it is possible to turn on the projector's power and project the computer's screen automatically by detecting the computer signals or HDMI signals issued from the computer. ([AUTO POWER ON] → page 77)
- On Windows 7, a combination of the Windows and P keys allows you to set up external display easily and quickly.

2-5. Adjusting the Picture Size and Position

Use the lens shift dial, the adjustable tilt foot level, the zoom lever/zoom ring and the focus ring to adjust the picture size and position.

In this chapter drawings and cables are omitted for clarity.

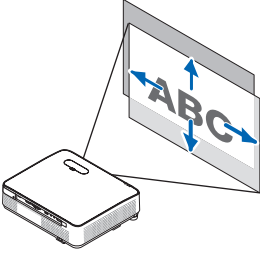
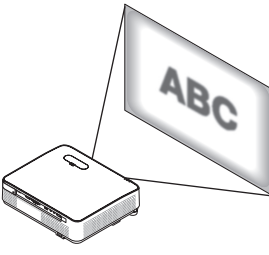
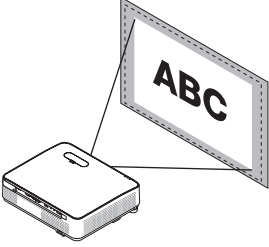
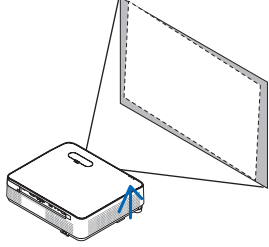
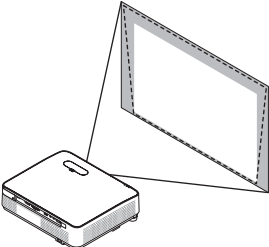
<p>Adjusting the projected image's vertical and horizontal position [Lens shift] (→ page 23)</p> 	<p>Adjusting the focus [Focus ring] (→ page 25)</p> 
<p>Finely adjusting the size of an image [Zoom lever] (→ page 26)</p> 	<p>Adjusting the projected image's height and horizontal tilt [Tilt foot] (→ page 27)</p> 
<p>Correcting the keystone distortion [Keystone] (→ page 28)</p> 	

Adjusting the vertical position of a projected image (Lens shift)

CAUTION

Perform the adjustment from behind or from the side of the projector. Adjusting from the front could expose your eyes to strong light which could injure them.

1. Open the lens shift cover.

Open with the cover's stopper pushed forward.

- The lens shift cover cannot be removed.

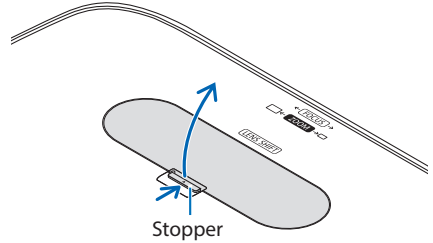

2. Turn the lens shift dials clockwise or counterclockwise.

Vertical dial

Turn this clockwise or counterclockwise to adjust the projection position in the vertical direction.

Horizontal dial

Turn this clockwise or counterclockwise to adjust the projection position in the horizontal direction.

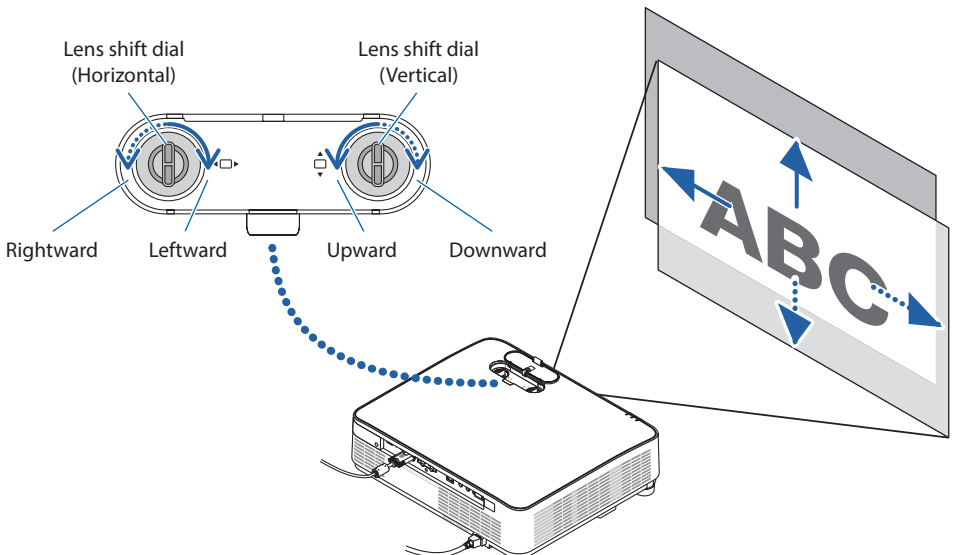

2. Projecting an Image (Basic Operation)

NOTE:

- The dials can be turned more than one full turn, but the projection position cannot be moved more than the range indicated on the following page. Do not force to turn the dials. Doing so may damage the dials.
- If the lens is shifted to the maximum in the diagonal direction, the edges of the screen will be dark or shaded.
- The vertical shift adjustment must be finished with an image shifted upward. If you finish the vertical shift adjustment with an image shifted down, the zoom/focus adjustments or strong shaking may cause a projected image to slightly shift down.

3. Close the lens shift cover.

Insert the cover's 2 (two) hooks into the grooves in the projector, then close the cover.

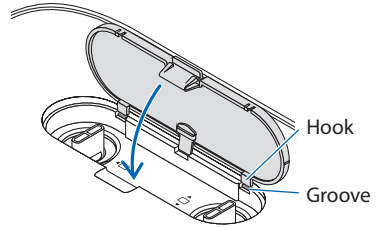

TIP:

- The diagram below shows the lens shift adjustment range ([ORIENTATION]: [DESKTOP FRONT]).
- For the lens shift adjustment range regarding the [CEILING FRONT] projection, see page 128.

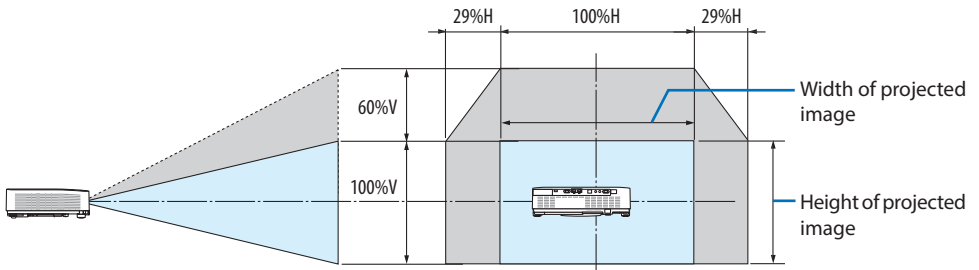

Description of symbols: V indicates vertical (height of the projected image), H indicates horizontal (width of the projected image).

Focus

Use the focus ring to obtain the best focus.

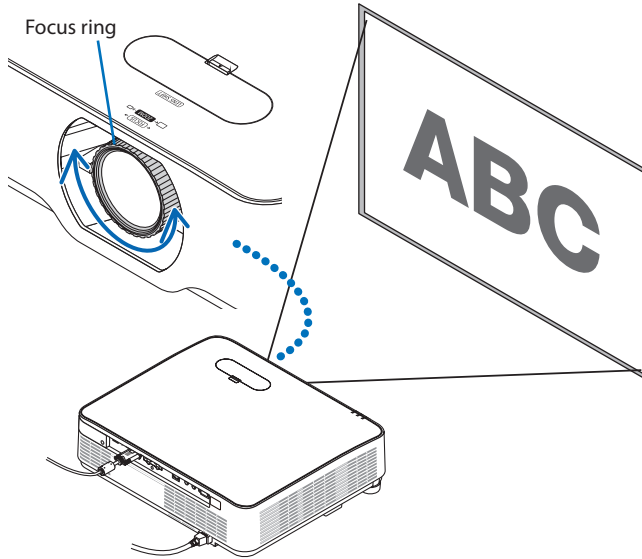

NOTE:

- Recommend to perform the focus adjustment after leaving the projector under the state the TEST PATTERN has been projected for over 30 minutes.

Please refer to page [73](#) about the TEST PATTERN.

Zoom

Turn the zoom lever clockwise and counterclockwise.

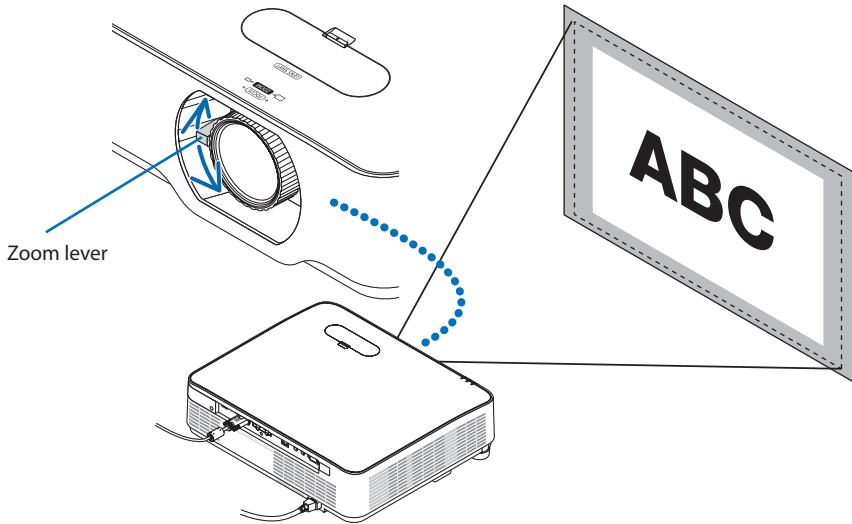

Adjusting the tilt (Tilt foot)

Adjusting the left and right tilt.

1. Turn the left and right tilt feet to adjust.

The tilt feet lengthen and shorten when turned.

The height of the projected image is adjusted by turning the left and right tilt feet.

If the projected image is tilted, turn one of the tilt feet to adjust the image so that it is level.

- If the projected image is distorted, see “2-6 Correcting Keystone Distortion [KEystone]” (→ page 28).
- The tilt feet can be lengthened by a maximum of 15 mm/0.6".
- The tilt feet can be used to tilt the projector by a maximum of 2°.

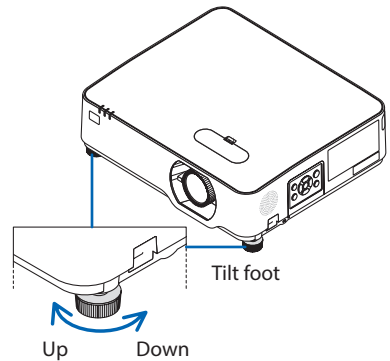
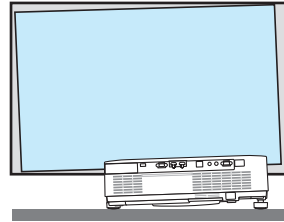

NOTE:

- Do not lengthen the tilt feet any more than 15 mm/0.6". Doing so will make the tilt feet's mount section unstable and could cause the tilt feet to come off the projector.
- Do not use the tilt feet for any purpose other than adjusting the projector's projection angle. Handling the tilt feet improperly, such as carrying the projector by grasping the tilt feet or hooking it onto a wall using the tilt feet, could damage the projector.

2-6. Correcting Keystone Distortion [KEYSTONE]

When the projector is not exactly perpendicular to the screen, keystone distortion occurs. For correcting this distortion, you can use the “Keystone” function, a digital technology that can adjust for keystone-type distortion, resulting in a crisp, square image.

The following procedure explains how to use the [KEYSTONE] screen from the menu to correct trapezoidal distortions when the projector is placed diagonally to the screen.

Before performing KEYSTONE correction

The [KEYSTONE] correction has four features, [KEYSTONE HORIZONTAL], [KEYSTONE VERTICAL], [PINCUSHION LEFT/RIGHT], [PINCUSHION TOP/BOTTOM], and [CORNERSTONE]. If the value of either [CORNERSTONE] or [PINCUSHION] has corrected, [KEYSTONE HORIZONTAL] and [KEYSTONE VERTICAL] are disabled. In this case, RESET the corrected values and restart to correct distortion.

1. Press the ▼ button on the projector cabinet.

The [GEOMETRIC CORRECTION] screen will be displayed on the screen.

- Press the KEYSTONE button when using the remote control.

2. Move the cursor onto [MODE] by ▼ button and press the ENTER.

The mode selection screen will displayed on.

3. Select [KEYSTONE] and press the ENTER.

Go back to display the [GEOMETRIC CORRECTION] screen of the on-screen menu.

4. Press the ▼ button to align with the [KEYSTONE] and then press the ENTER button.

The screen will switch to the [KEYSTONE] screen.

- See page 42 for [PINCUSHION].
- See page 39 for [CORNERSTONE].

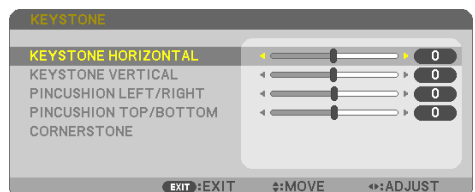
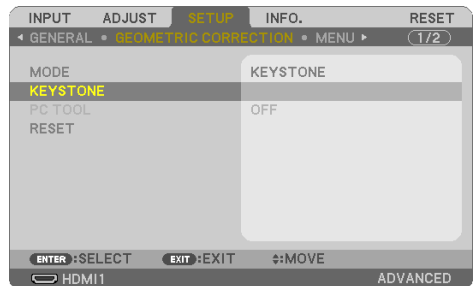
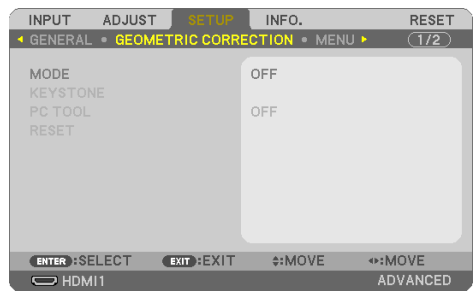

2. Projecting an Image (Basic Operation)

5. Press the ▼ button to select [KEYSTONE VERTICAL] and then use the ◀ or ▶ so that the left and right sides of the projected image are parallel.

- Adjust the vertical keystone distortion.

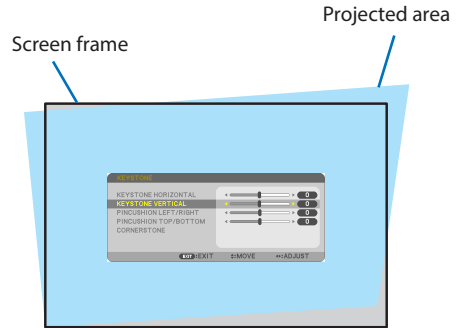

6. Align the left (or right) side of the screen with the left (or right) side of the projected image.

- Use the shorter side of the projected image as the base.
- In the right example, use the left side as the base.



7. Press the ▲ button to select [KEYSTONE HORIZONTAL] and then use the ◀ or ▶ so that the top and bottom sides of the projected image are parallel.

- Adjust the horizontal keystone distortion.

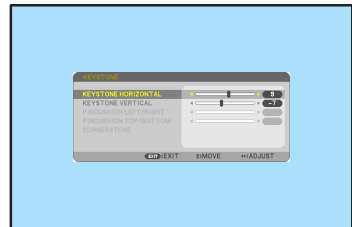

8. Repeat steps 5 and 7 to correct keystone distortion.

9. After completing Keystone correction, press the EXIT button a few times to turn off the menu.



NOTE:

- Even when the projector is turned on, the last used correction values are applied.
 - The KEYSTONE feature can cause an image to be slightly blurred because the correction is made electronically.
-

To return the keystone adjustments to default:

1. Display the [GEOMETRIC CORRECTION] screen, and make sure [KEYSTONE] is selected at [MODE].
2. Press the ▼ button to select [RESET] and press the ENTER button.



3. Press the ◀ or ▶ button to select [YES] and press the ENTER button.



The adjustments will be reset.

NOTE:

- All adjusted values set in the [KEYSTONE] adjustment are reset to initial values.
-

2-7. Optimizing Computer Signal Automatically

Adjusting the Image Using Auto Adjust

Optimizing a computer image automatically. (COMPUTER)

Press the AUTO ADJ. button on the remote control to optimize a computer image automatically.

This adjustment may be necessary when you connect your computer for the first time.

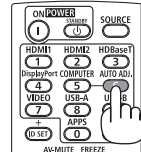

Poor picture



Normal picture

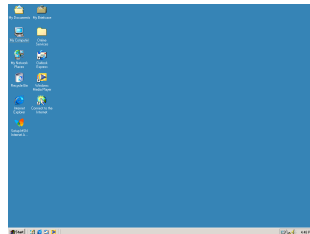

NOTE:

Some signals may take time to display or may not be displayed correctly.

- If the Auto Adjust operation cannot optimize the computer signal, try to adjust [HORIZONTAL], [VERTICAL], [CLOCK], and [PHASE] manually. (→ page 59, 60)

2-8. Turning Up or Down Volume

Sound level from the speaker or audio output can be adjusted.

When no menus appear, the ◀ and ▶ buttons on the projector cabinet work as a volume control.

- On the remote control, press the VOL. (+) or (–) button.

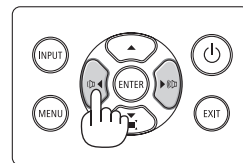

NOTE:

- Volume control is not available with the ◀ or ▶ button when an image is magnified by using the D-ZOOM (+) button, when the menu is displayed, or when the VIEWER or LAN is displayed.

TIP:

- The [BEEP] sound volume cannot be adjusted. To turn off the [BEEP] sound, from the menu, select [SETUP] → [OPTIONS(1)] → [BEEP] → [OFF].

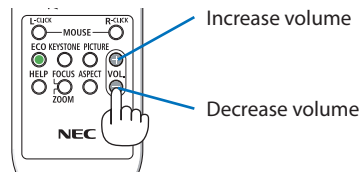

2-9. Turning off the Projector

To turn off the projector:

1. First, press the  (POWER) button on the projector cabinet or the STANDBY button on the remote control.

The confirmation message will be displayed.

- The confirmation message displayed when the power is turned off indicates the amount of CO₂ reduction this session (→ page 38).

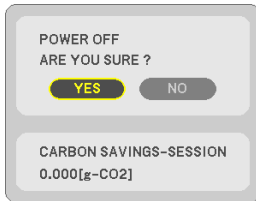
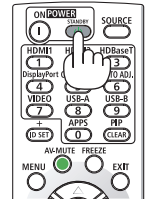
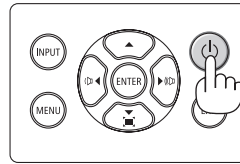

2. Secondly, press the ENTER button or press the  (POWER) or the STANDBY button again.

When the light source turns off, the power turns off too (standby mode).

When the projector goes into the standby mode, the POWER indicator of the unit flashes orange. (In the state, [STANDBY MODE] is [NORMAL].)

3. Mount the lens cap.

Insert the cap's 2 (two) hooks into the grooves of the projector, then press at the bottom of the lens cap. The stopper is secured to the projector.

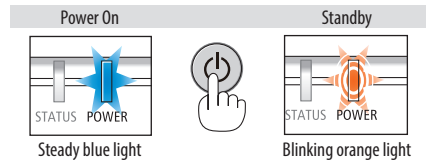
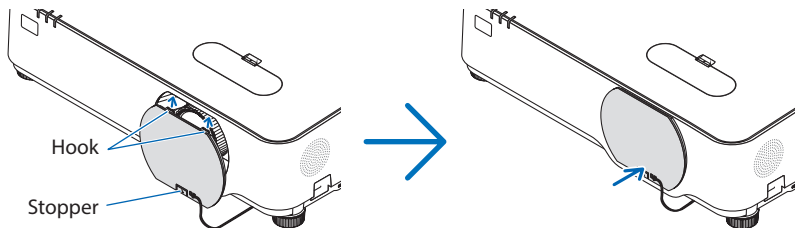



CAUTION:

Parts of the projector may become temporarily heated if the projector is turned off with the POWER button.
Be careful to handle the projector.

NOTE:

- While the POWER indicator is blinking blue in short cycles, the power cannot be turned off.
 - Do not unplug the power cord from the projector or from the power outlet while an image is being projected. Doing so could deteriorate the projector's AC IN terminal or the power plug's contact. To turn off the AC power while an image is being projected, use the power strip's switch, the breaker, etc.
 - Do not disconnect the AC power supply to the projector within 10 seconds of making adjustment or setting changes and closing the menu. Doing so can cause loss of adjustments and settings.
-

2-10. When Moving the Projector

Preparation: Make sure that the projector is turned off.

- 1. Unplug the power cord.**
- 2. Disconnect any other cables.**
 - Remove the USB memory if it is inserted into the projector.

3. Convenient Features

3-1. Turning off the Image and Sound

Press the AV-MUTE button to turn off the image and sound for a short period of time. Press again to restore the image and sound.

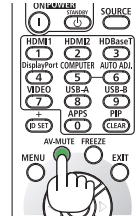

NOTE:

- Even though the image is turned off, the menu still remains on the screen.
-

3-2. Freezing a Picture

Press the FREEZE button. If the image of a DVD player, etc., is being projected, the video switches to a still image. Press the FREEZE button again to resume the video.

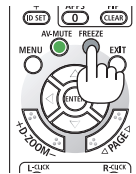

NOTE:

- The image is frozen but the original video is still playing back.
-

3-3. Magnifying a Picture

You can enlarge the picture up to four times.

NOTE:

- The maximum magnification may be less than four times depending on the signal.

To do so:

1. Press the D-ZOOM (+) button to magnify the picture.

To move the magnified image, use the ▲, ▼, ◀ or ▶ button.

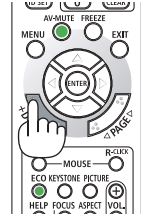
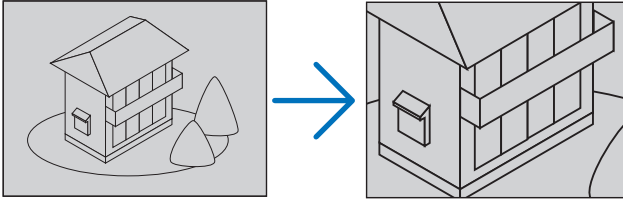

2. Press the ▲▼◀▶ button.

The area of the magnified image will be moved.

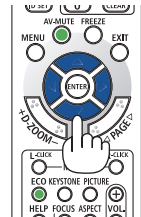
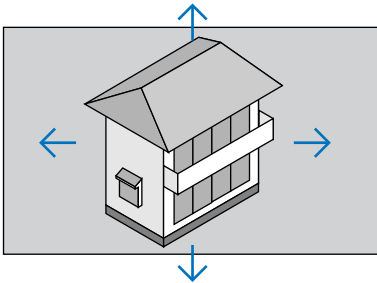

3. Press the D-ZOOM (-) button.

Each time the D-ZOOM (-) button is pressed, the image is reduced.

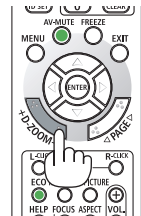





NOTE:

- The image will be magnified or demagnified at the center of the screen.
- Displaying the menu will cancel the current magnification.

3-4. Changing Eco Mode/Checking Energy-Saving Effect

Using Eco Mode [ECO MODE]

Two eco modes can be selected according to the purpose of use for the projector.

[ECO MODE]	Icon at the bottom of the menu	Description	Status of LIGHT indicator
[OFF]		100% brightness The screen will be brightly lit.	 Steady green light
[ECO]		Brightness will be at about 60% (PE455WL: 67%). The cooling fan will also slow down accordingly. Lower power consumption	 Blinking green light
[LONG LIFE]		Brightness will be at about 50% (PE455WL: 56%). This setting accords priority to prolonging the life of the light module.	

To turn on the [ECO MODE], do the following:

1. Press the ECO Button on the remote control to display [ECO MODE] screen.

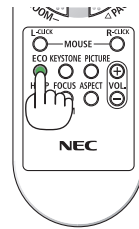

2. Use the ▼▲ buttons to select, then press the ENTER button.

The [ECO MODE] selection screen turns off and the projector switches to the selected mode.

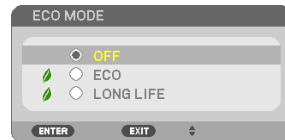

NOTE:

- The [ECO MODE] can be changed by using the menu.
Select [SETUP] → [GENERAL] → [LIGHT MODE] → [ECO MODE].
- The [LIGHT HOURS USED] can be checked in [USAGE TIME]. Select [INFO.] → [USAGE TIME].
- After a lapse of 1 minute from when the projector displays no-signal guidance, a blue, black or logo screen, the projector goes into [LONG LIFE] automatically. The projector will return to its original setting once a signal is accepted.
- If the projector inside temperature becomes high caused on the high room temperature, the projector may decrease the brightness temporarily for protecting itself. This is a protective function called [FORCED ECO MODE]. When the projector is in the [FORCED ECO MODE], the thermometer symbol [] is indicated at the right bottom of the screen. When the projector inside temperature goes down by cooling the room, the [FORCED ECO MODE] will be released and the projector will be back to the original setting state.

Checking Energy-Saving Effect [CARBON METER]

This feature will show energy-saving effect in terms of CO₂ emission reduction (kg) when the projector's [ECO MODE] is set to [ECO] or [LONG LIFE]. This feature is called as [CARBON METER].

There are two messages: [TOTAL CARBON SAVINGS] and [CARBON SAVINGS-SESSION]. The [TOTAL CARBON SAVINGS] message shows the total amount of CO₂ emission reduction from the time of shipment up to now. You can check the information on [USAGE TIME] from [INFO.] of the menu. (→ page 80)

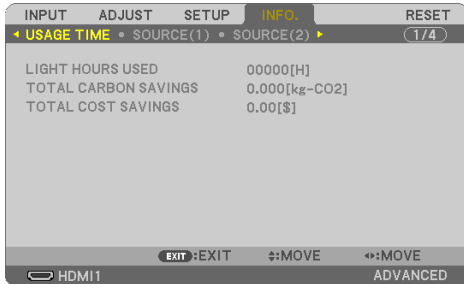

The [CARBON SAVINGS-SESSION] message shows the amount of CO₂ emission reduction between the time of changing to ECO MODE immediately after the time of power-on and the time of power-off. The [CARBON SAVINGS-SESSION] message will be displayed in the [POWER OFF / ARE YOU SURE ?] message at the time of power-off.

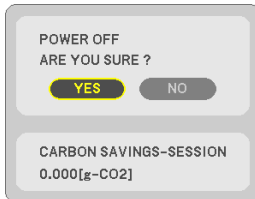

TIP:

- The formula as shown below is used to calculate the amount of CO₂ emission reduction.
Amount of CO₂ emission reduction = (Power consumption in [OFF] for [ECO MODE] – Power consumption in [ECO]/[LONG LIFE] for [ECO MODE]) × CO₂ conversion factor.
* Calculation for amount of CO₂ emission reduction is based on an OECD publication “CO₂ Emissions from Fuel Combustion, 2008 Edition”.
- The [TOTAL CARBON SAVINGS] is calculated based on savings recorded in 15 minutes intervals.
- This formula will not apply to the power consumption which is not affected by whether [ECO MODE] is turned on or off.

3-5. Correcting distortion of projected image

Use the [CORNERSTONE] and [PINCUSHION] features to correct keystone (trapezoidal) distortion to make the top or bottom and the left or right side of the screen longer or shorter so that the projected image is rectangular.

Before performing correction

The [KEystone] correction has features, [KEYSTONE HORIZONTAL], [KEYSTONE VERTICAL], [PINCUSHION LEFT/RIGHT], [PINCUSHION TOP/BOTTOM], and [CORNERSTONE]. If the value of either [CORNERSTONE] or [PINCUSHION] has corrected, [KEYSTONE HORIZONTAL] and [KEYSTONE VERTICAL] are disabled. In this case, RESET the corrected values and restart to correct distortion.

Cornerstone

1. Press the ▼ button with no menu displayed.

The [GEOMETRIC CORRECTION] screen will be displayed.

- Press the KEYSTONE button when using the remote control.

2. Move the cursor onto [MODE] by ▼ button and press the ENTER.

The mode selection screen will be displayed on.

3. Select [KEYSTONE] and press the ENTER.

Go back to display the [GEOMETRIC CORRECTION] screen of the on-screen menu.

4. Press the ▼ button to align with the [KEYSTONE] and then press the ENTER button.

The screen will switch to the [KEYSTONE] screen.

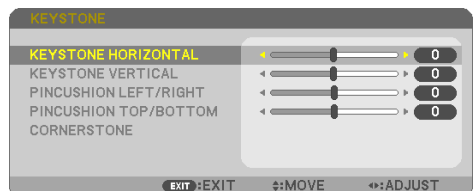
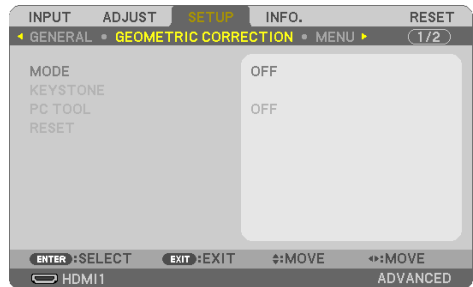

5. Press the ▼ button to select [CORNERSTONE] and press the ENTER button.

The [CORNERSTONE] screen will be displayed.

- * The drawing shows the upper left icon (▼) is selected.

6. Project an image so that the screen is smaller than the area of the raster.

7. Pick up any one of the corners and align the corner of the image with a corner of the screen.

- * The drawing shows the upper right corner.

8. Use the ▲▼◀▶ button to select one icon (▲) which points in the direction you wish to move the projected image frame.

TIP:

- If either [CORNERSTONE] or [PINCUSHION] is adjusted, the options [KEystone VERTICAL] and [KEystone HORIZONTAL] become unavailable. In this case, RESET the corrected values and restart to correct distortion.

9. Press the ENTER button.

10. Use the ▲▼◀▶ button to move the projected image frame as shown on the example.

11. Press the ENTER button.

12. Use the ▲▼◀▶ button to select another icon which points in the direction.

On the Cornerstone adjustment screen, select [EXIT] or press the EXIT button on the remote control.

The confirmation screen is displayed.



Projected image

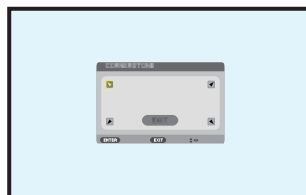
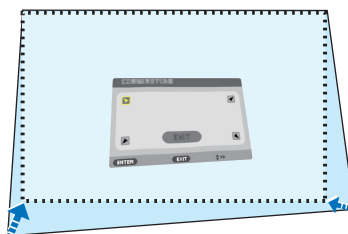
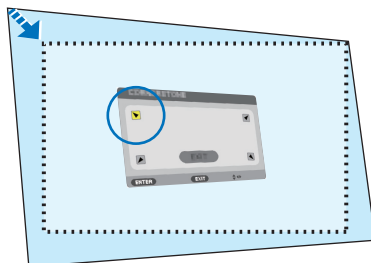
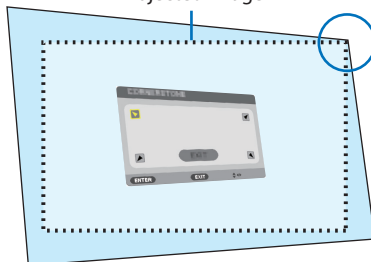

13. Press the ◀ or ▶ button to highlight the [OK] and press the ENTER button.

This completes the Cornerstone correction.

- Selecting [CANCEL] will return to the adjustment screen without saving changes (Step 3).
- Selecting [RESET] will return to the factory default.
- Selecting [UNDO] will exit without saving changes.

14. Press the EXIT button a few times to turn off the menu.

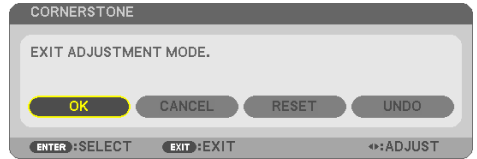

Pincushion

By this feature, it enables to adjust left and right side or top and bottom side independently for reforming pincushion distortion.

1. Press the ▼ button with no menu displayed.

The [GEOMETRIC CORRECTION] screen will be displayed.

- Press the KEYSTONE button when using the remote control.

2. Move the cursor onto [MODE] by ▼ button and press the ENTER.

The mode selection screen will displayed on.

3. Select [KEYSTONE] and press the ENTER.

Go back to display the [GEOMETRIC CORRECTION] screen of the on-screen menu.

4. Press the ▼ button to align with the [KEYSTONE] and then press the ENTER button.

The screen will switch to the [KEYSTONE] screen.

5. Press the ▼ or ▲ button to select [PINCUSHION LEFT/RIGHT] or [PINCUSHION TOP/BOTTOM].

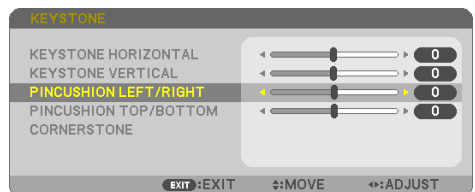
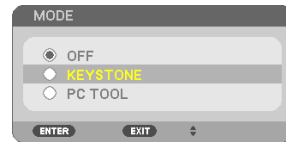
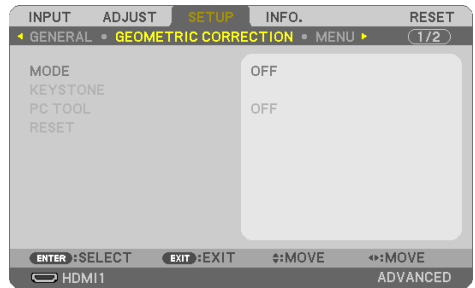

6. Press the ◀ or ▶ button to correct distortion.

NOTE:

- The [PINCUSHION LEFT/RIGHT] or [PINCUSHION TOP/BOTTOM] item is not available when [KEystone HORIZONTAL], [KEystone VERTICAL] or [CORNERSTONE] is activated.
- Before performing correction, set the lens shift to the center position.

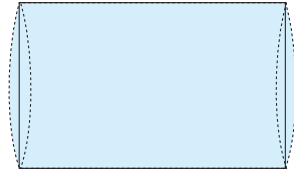

7. After completing [PINCUSHION] adjustment, press the EXIT button a few times to turn off the menu.

NOTE:

- Even when the projector is turned on, the last used correction values are applied.
 - [PINCUSHION] and [CORNERSTONE] corrections can cause the image to be slightly blurred because the correction is made electronically.
-

Reset the keystone and pincushion adjustment to the default value

1. Display the [GEOMETRIC CORRECTION] screen, and make sure [KEystone] is selected at [MODE].
2. Press the ▼ button to select [RESET] and press the ENTER button.



- Confirmation message is displayed on.
3. Move the cursor onto [YES] using either ◀ or ▶ button and then press the ENTER.



NOTE:

- All adjusted values set in the [KEystone] adjustment are reset to initial values.

TIP:

- Distortion when projecting on specially shaped surfaces (cylindrical or spherical surfaces, for example) can be corrected using our Geometric Correction Tool application. Please download Geometric Correction Tool from our web site.
<https://www.nec-display.com/dl/en/index.html>

3-6. Preventing the Unauthorized Use of the Projector [SECURITY]

A keyword can be set for your projector using the Menu to avoid operation by an unauthorized user. When a keyword is set, turning on the projector will display the Keyword input screen. Unless the correct keyword is entered, the projector cannot project an image.

- The [SECURITY] setting cannot be cancelled by using the [RESET] of the menu.

To enable the Security function:

1. Press the MENU button.

The menu will be displayed.

2. Press the ► button twice to select [SETUP] and press the ▼ button or the ENTER button to select [GENERAL].

3. Press the ► button to select [INSTALLATION].

4. Press the ▼ button three times to select [SECURITY] and press the ENTER button.

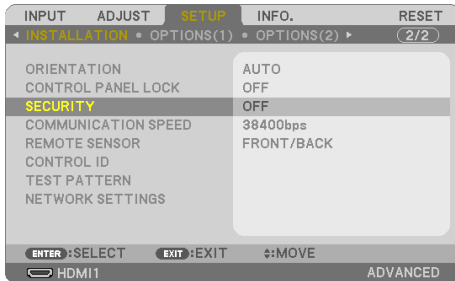

The [OFF/ON] menu will be displayed.

5. Press the ▼ button to select [ON] and press the ENTER button.



The [SECURITY KEYWORD] screen will be displayed.

6. Type in a combination of the four ▲▼◀▶ buttons and press the ENTER button.

NOTE:

- A keyword must be 4 to 10 digits in length.



The [CONFIRM KEYWORD] screen will be displayed.

7. Type in the same combination of ▲▼◀▶ buttons and press the ENTER button.



The confirmation screen will be displayed.

8. Select [YES] and press the ENTER button.

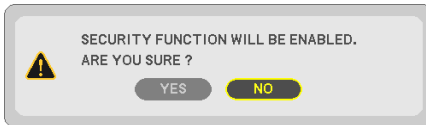

The [SECURITY] function has been enabled.

To turn on the projector when [SECURITY] is enabled:

1. Press the POWER button.

The projector will be turned on and display a message to the effect that the projector is locked.

2. Press the MENU button.



3. Type in the correct keyword and press the ENTER button. The projector will display an image.



NOTE:

- The security disable mode is maintained until the main power is turned off or unplugging the power cord.

To disable the [SECURITY] function:**1. Press the MENU button.**

The menu will be displayed.

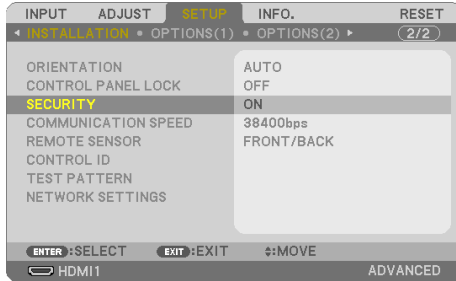
2. Select [SETUP] → [INSTALLATION] → [SECURITY] and press the ENTER button.

The [OFF/ON] menu will be displayed.

3. Select [OFF] and press the ENTER button.

The [SECURITY KEYWORD] screen will be displayed.

**4. Type in your keyword and press the ENTER button.**

When the correct keyword is entered, the [SECURITY] function will be disabled.

NOTE:

- If you forget your keyword, contact your dealer. Your dealer will provide you with your keyword in exchange for your request code. Your request code is displayed in the Keyword Confirmation screen. In this example [K992-45L8-JNGJ-4XU9-1YAT-EEA2] is a request code.

4. Using On-Screen Menu

4-1. Using the Menus

NOTE:

- The on-screen menu may not be displayed correctly while interlaced motion video image is projected.
-

- 1. Press the MENU button on the remote control or the projector cabinet to display the menu.**



NOTE:

- The commands such as ENTER, EXIT, ▲▼, ◀▶ in the bottom show available buttons for your operation.
-

- 2. Press the ◀▶ buttons on the remote control or the projector cabinet to display the submenu.**
- 3. Press the ENTER button on the remote control or the projector cabinet to highlight the top item or the first tab.**
- 4. Use the ▲▼ buttons on the remote control or the projector cabinet to select the item you want to adjust or set.**

You can use the ◀▶ buttons on the remote control or the projector cabinet to select the tab you want.

- 5. Press the ENTER button on the remote control or the projector cabinet to display the submenu window.**
- 6. Adjust the level or turn the selected item on or off by using the ▲▼◀▶ buttons on the remote control or the projector cabinet.**

Changes are stored until adjusted again.

- 7. Repeat steps 2–6 to adjust an additional item, or press the EXIT button on the remote control or the projector cabinet to quit the menu display.**
-

NOTE:

- When a menu or message is displayed, several lines of information may be lost, depending on the signal or settings.
-

- 8. Press the MENU button to close the menu.**
To return to the previous menu, press the EXIT button.

Menu Elements

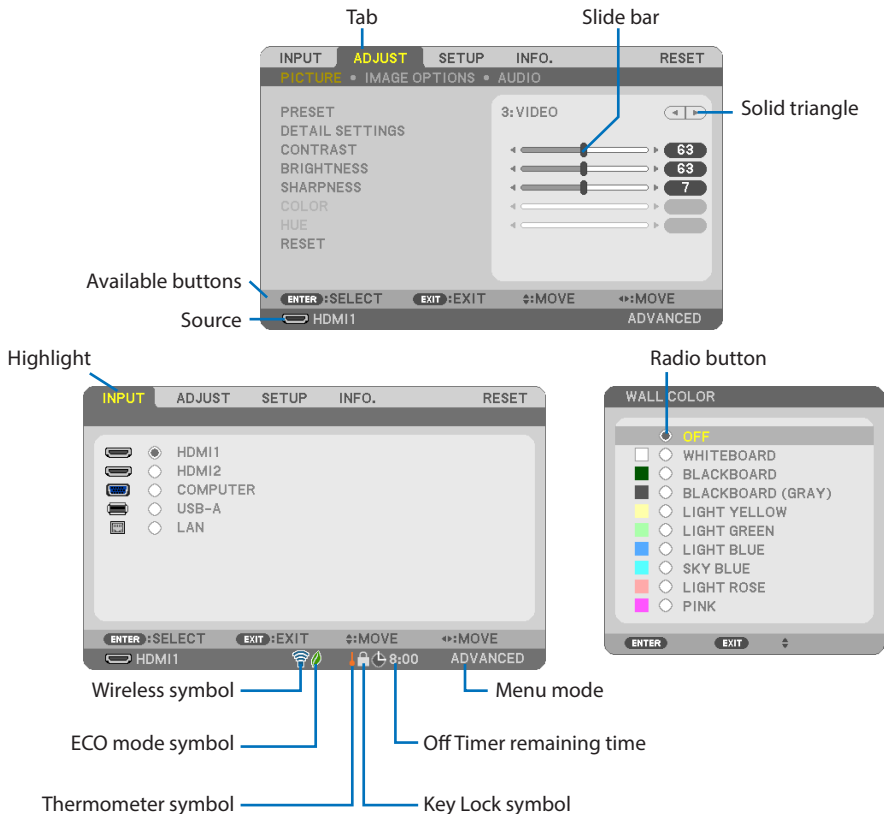

Menu windows or dialog boxes typically have the following elements:

Highlight	Indicates the selected menu or item.
Solid triangle	Indicates further choices are available. A highlighted triangle indicates the item is active.
Tab	Indicates a group of features in a dialog box. Selecting on any tab brings its page to the front.
Radio button	Use this round button to select an option in a dialog box.
Source	Indicates the currently selected source.
Off Timer remaining time	Indicates the remaining countdown time when the [OFF TIMER] is preset.
Slide bar	Indicates settings or the direction of adjustment.
ECO mode symbol	Indicates [ECO MODE] is set.
Key Lock symbol	Indicates the [CONTROL PANEL LOCK] is enabled.
Thermometer symbol	Indicates the projector is in the state of the [FORCED ECO MODE].
Wireless symbol	Indicate the wireless LAN connection is enabled.
Menu mode	Indicate the [ADVANCED] menu or [BASIC] menu.

4-2. List of Menu Items

Some menu items are not available depending on the input source. The below listed menu items are on the advanced menu. The mark (B) is added to the items on the basic menu.

Shaded characters (■) represent default settings.

Menu Item		Options			
INPUT	HDMI1	(B)			
	HDMI2	(B)			
	COMPUTER	(B)			
	USB-A	(B)			
	LAN	(B)			
ADJUST	PICTURE	PRESET	1-7		
		DETAIL SETTINGS	GENERAL	REFERENCE	HIGH-BRIGHT, PRESENTATION, VIDEO, MOVIE, GRAPHIC, sRGB, DICOM SIM.
				GAMMA CORRECTION	DYNAMIC, NATURAL, BLACK DETAIL
				SCREEN SIZE	LARGE, MEDIUM, SMALL
				COLOR TEMPERATURE	
				DYNAMIC CONTRAST	OFF, ON
				IMAGE MODE	STILL, MOVIE
		WHITE BALANCE	CONTRAST R		
			CONTRAST G		
			CONTRAST B		
			BRIGHTNESS R		
			BRIGHTNESS G		
		IMAGE OPTIONS	BRIGHTNESS B		
			CONTRAST		(B)
			BRIGHTNESS		(B)
			SHARPNESS		(B)
			COLOR		(B)
	HUE		(B)		
	RESET		(B)		
	CLOCK				
	PHASE				
	HORIZONTAL				
	VERTICAL				
	OVERSCAN		AUTO, 0[%], 5[%], 10[%]		
	ASPECT RATIO		AUTO, 4:3, 16:9, 15:9, 16:10, LETTERBOX, NATIVE		
	POSITION*				
	AUDIO	VOLUME	(B)		

* This function is not available for PE455UL/PE455WL.

4. Using On-Screen Menu

Menu Item		Options		
SETUP	GENERAL	WALL COLOR (B)	OFF, WHITEBOARD, BLACKBOARD, BLACKBOARD (GRAY), LIGHT YELLOW, LIGHT GREEN, LIGHT BLUE, SKY BLUE, LIGHT ROSE, PINK	
		LIGHT MODE (B)	ECO MODE	OFF, ECO, LONG LIFE
			ADJUST	
			CONSTANT BRIGHTNESS	OFF, ON
		OFF TIMER (B)	OFF, 0:30, 1:00, 2:00, 4:00, 8:00, 12:00, 16:00	
		DATE AND TIME SETTINGS		
		ADMINISTRATOR MODE (B)	MENU MODE	ADVANCED, BASIC
			NOT SAVE SETTING VALUES	OFF, ON
			KEYWORD	OFF, ON
		LANGUAGE (B)	ENGLISH, DEUTSCH, FRANÇAIS, ITALIANO, ESPAÑOL, SVENSKA, 日本語 DANSK, PORTUGUÊS, ČESTINA, MAGYAR, POLSKI, NEDERLANDS, SUOMI NORSK, TÜRKÇE, РУССКИЙ, عربي, ΕΛΛΗΝΙΚΑ, 简体中文, 한국어, TIẾNG VIỆT ROMÂNĂ, HRVATSKI, БЪЛГАРСКИ, INDONESIA, हिन्दी, ไทย, ئۇيغۇر, 繁體中文	
		GEOMETRIC CORRECTION	MODE	OFF, KEYSTONE, PC TOOL
			KEYSTONE	KEYSTONE HORIZONTAL
	KEYSTONE VERTICAL			
	PINCUSHION LEFT/RIGHT			
	PINCUSHION TOP/BOTTOM			
	CORNERSTONE			
	PC TOOL	OFF, 1, 2, 3		
	RESET			
	MENU	COLOR SELECT	COLOR, MONOCHROME	
		INPUT DISPLAY	OFF, ON	
		ID DISPLAY	OFF, ON	
		ECO MESSAGE	OFF, ON	
		DISPLAY TIME	MANUAL, AUTO 5 SEC, AUTO 15 SEC, <u>AUTO 45 SEC</u>	
		BACKGROUND	BLUE, BLACK, LOGO	
	INSTALLATION	ORIENTATION	AUTO, DESKTOP FRONT, CEILING REAR, DESKTOP REAR, CEILING FRONT	
		CONTROL PANEL LOCK	OFF, ON	
		SECURITY	OFF, ON	
		COMMUNICATION SPEED	4800bps, 9600bps, 19200bps, 38400bps	
		REMOTE SENSOR	FRONT/BACK, FRONT, BACK	
		CONTROL ID	CONTROL ID NUMBER	1-254
			CONTROL ID	OFF, ON
		TEST PATTERN		
		NETWORK SETTINGS		

		Menu Item	Options	
SETUP	OPTIONS(1)	SEAMLESS SWITCHING	OFF, ON	
		FAN MODE	AUTO, HIGH ALTITUDE	
		SIGNAL SELECT	COMPUTER	RGB/COMPONENT, RGB, COMPONENT
		WXGA MODE		OFF, ON
		DEINTERLACE		OFF, ON
		VIDEO LEVEL	HDMI1	AUTO, NORMAL, ENHANCED
			HDMI2	AUTO, NORMAL, ENHANCED
		AUDIO SELECT	HDMI1	HDMI1, COMPUTER
			HDMI2	HDMI2, COMPUTER
			LAN	LAN, COMPUTER
			BEEP	OFF, ON
	OPTIONS(2)	STANDBY MODE		NORMAL, NETWORK STANDBY, SLEEP
		DIRECT POWER ON		OFF, ON
		AUTO POWER ON		OFF, AUTO, HDMI1, HDMI2, COMPUTER
		AUTO POWER OFF		OFF, 0:05, 0:10, 0:15, 0:20, 0:30, 1:00
		DEFAULT INPUT SELECT		LAST, AUTO, HDMI1, HDMI2, COMPUTER, USB-A, LAN
		CARBON CONVERT		
		CURRENCY		\$, €, JPY, RMB¥
		CURRENCY CONVERT		
		STATIC CONVERGENCE*	HORIZONTAL R	
			HORIZONTAL G	
			HORIZONTAL B	
			VERTICAL R	
	VERTICAL G			
	VERTICAL B			
INFO.	USAGE TIME	(B)	LIGHT HOURS USED	
			TOTAL CARBON SAVINGS	
			TOTAL COST SAVINGS	
	SOURCE(1)	(B)	SOURCE NAME	
			SOURCE INDEX	
			HORIZONTAL FREQUENCY	
			VERTICAL FREQUENCY	
			SYNC TYPE	
			SYNC POLARITY	
	SOURCE(2)	(B)	SIGNAL TYPE	
			VIDEO TYPE	
			BIT DEPTH	
			VIDEO LEVEL	
	WIRED LAN		IP ADDRESS	
			SUBNET MASK	
			GATEWAY	
MAC ADDRESS				

* This function is not available for PE455WL/PE505XL.

4. Using On-Screen Menu

		Menu Item	Options	
INFO.	WIRELESS LAN	IP ADDRESS		
		SUBNET MASK		
		GATEWAY		
		MAC ADDRESS		
		SSID		
		NETWORK TYPE		
		SECURITY		
		CHANNEL		
		SIGNAL LEVEL		
	VERSION(1)	(B) FIRMWARE		
		DATA		
	VERSION(2)	(B) FIRMWARE2		
		DATA2		
	OTHERS	(B)	DATE TIME	(B)
			PROJECTOR NAME	(B)
			HOST NAME	(B)
			MODEL NO.	(B)
			SERIAL NUMBER	(B)
			LAN UNIT TYPE	
			CONTROL ID (when [CONTROL ID] is set)	(B)
	CONDITIONS		INTAKE TEMPERATURE	
EXHAUST TEMPERATURE				
INSTALLATION POSITION				
X-AXIS				
Y-AXIS				
Z-AXIS				
RESET	CURRENT SIGNAL			
	ALL DATA			

4-3. Menu Descriptions & Functions [INPUT]



[HDMI1] and [HDMI2]

Selects the HDMI compatible equipment connected to your HDMI 1 IN or HDMI 2 IN terminal.

[COMPUTER]

Selects the computer connected to your COMPUTER IN terminal signal.

NOTE:

- When the component input signal is connected to the COMPUTER IN terminal, select [COMPUTER].
-

[USB-A]

Start the [VIEWER].

Project the data of the USB memory set in this machine.

[LAN]

Display the start-up screen of MultiPresenter.

Selects a signal from the LAN port (RJ-45) or the installed USB wireless LAN unit (optional).

4-4. Menu Descriptions & Functions [ADJUST]

[PICTURE]

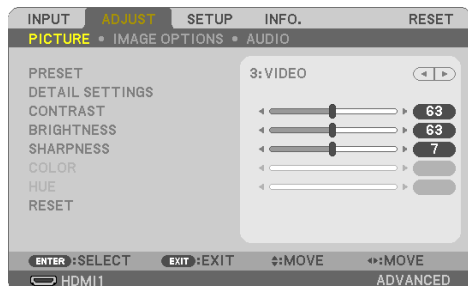

[PRESET]

This function allows you to select optimized settings for your projected image.

You can adjust neutral tint for yellow, cyan or magenta.

There are seven factory presets optimized for various types of images. You can also use [DETAIL SETTINGS] to set user adjustable settings to customize each gamma or color.

Your settings can be stored in [PRESET] 1 to [PRESET] 7.

HIGH-BRIGHT	Recommended for use in a brightly lit room.
PRESENTATION	Recommended for making a presentation using a PowerPoint file.
VIDEO	Recommended for typical TV program viewing.
MOVIE	Recommended for movies.
GRAPHIC	Recommended for graphics.
sRGB	Standard color values
DICOM SIM.	Recommended for DICOM simulation format.

NOTE:

- The [DICOM SIM.] option is for training/reference only and should not be used for actual diagnosis.
- DICOM stands for Digital Imaging and Communications in Medicine. It is a standard developed by the American College of Radiology (ACR) and the National Electrical Manufacturers Association (NEMA).

The standard specifies how digital image data can be moved from system to system.

[DETAIL SETTINGS]

This function allows you to store your customized settings in [PRESET 1] to [PRESET 7]. First, select a base preset mode from [REFERENCE], then set [GAMMA CORRECTION], [SCREEN SIZE], [COLOR TEMPERATURE], [DYNAMIC CONTRAST], [IMAGE MODE], and [COLOR ENHANCEMENT].

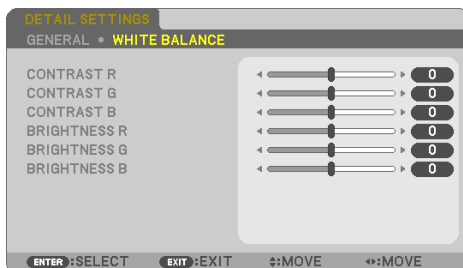
**Storing Your Customized Settings [REFERENCE]**

Select a mode to serve as the basis for the [DETAIL SETTINGS].

Selecting Gamma Correction Mode [GAMMA CORRECTION]

Each mode is recommended for:

DYNAMIC	Creates a high-contrast picture.
NATURAL	Natural reproduction of the picture.
BLACK DETAIL	Emphasizes detail in dark areas of the picture.

NOTE:

- This function is not available when [DICOM SIM.] is selected for [REFERENCE].

Selecting Screen Size for DICOM SIM. [SCREEN SIZE]

This function will perform gamma correction appropriate for the screen size.

LARGE	For screen size of 150"
MEDIUM	For screen size of 100"
SMALL	For screen size of 50"

NOTE:

- This function is available only when [DICOM SIM.] is selected for [REFERENCE].

Adjusting Color Temperature [COLOR TEMPERATURE]

Adjust the balance of the colors (R, G, B) to optimize the color reproducibility.

A color temperature with a high numerical value becomes bluish white while one with a low numerical value becomes reddish white.

A value between 5000 K and 10500 K can be set in 100 K units.

NOTE:

- When [HIGH-BRIGHT] is selected in [REFERENCE], this function is not available.

Adjusting Brightness and Contrast [DYNAMIC CONTRAST]

If [ON] is selected, the most optimal contrast ratio is used according to the picture.

NOTE:

- When [CONSTANT BRIGHTNESS] is activated, [DYNAMIC CONTRAST] cannot be selected.
- This function is not available when [DICOM SIM.] is selected for [REFERENCE].

Selecting Still Image Mode or Movie Mode [IMAGE MODE]

This function allows you to select the still image mode or the movie mode.

STILL	This mode is for a still image.
MOVIE	This mode is for a movie.

NOTE:

- This function is available only when [HIGH-BRIGHT] is selected for [REFERENCE].

Enhancing the Color [COLOR ENHANCEMENT]

This allows you to adjust the color density of the image.

The color of the image will become deeper in the order of [LOW], [MEDIUM], and [HIGH] as the displayed image will become darker.

With [OFF] selected, the [COLOR ENHANCEMENT] function will not work.

NOTE:

- This function is not available when [sRGB] or [DICOM SIM.] is selected for [REFERENCE].

Adjusting White Balance [WHITE BALANCE]

This allows you to adjust the white balance. Contrast for each color (RGB) to adjust the white level of the screen; Brightness for each color (RGB) is used to adjust the black level of the screen.

NOTE:

- When [WHITE BALANCE] is in operation, the actual color tone differs from the value of the [COLOR TEMPERATURE].

[CONTRAST]

Adjusts the intensity of the image according to the incoming signal.

[BRIGHTNESS]

Adjusts the brightness level or the back raster intensity.

[SHARPNESS]

Controls the detail of the image.

[COLOR]

Increases or decreases the color saturation level.

[HUE]

Varies the color level from +/- green to +/- blue. The red level is used as reference.

Input signal	CONTRAST	BRIGHTNESS	SHARPNESS	COLOR	HUE
COMPUTER/HDMI (RGB)	Yes	Yes	Yes	No	No
COMPUTER/HDMI (COMPONENT)	Yes	Yes	Yes	Yes	Yes
USB-A, LAN	Yes	Yes	Yes	No	No

Yes = Adjustable, No = Not adjustable

[RESET]

The settings and adjustments for [PICTURE] will be returned to the factory settings with the exception of the following; Preset numbers and [REFERENCE] within the [PRESET] screen.

The settings and adjustments under [DETAIL SETTINGS] within the [PRESET] screen that are not currently selected will not be reset.

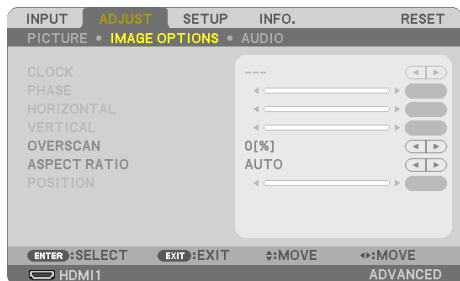
[IMAGE OPTIONS]**Adjusting Clock and Phase [CLOCK/PHASE]**

This allows you to manually adjust [CLOCK] and [PHASE].

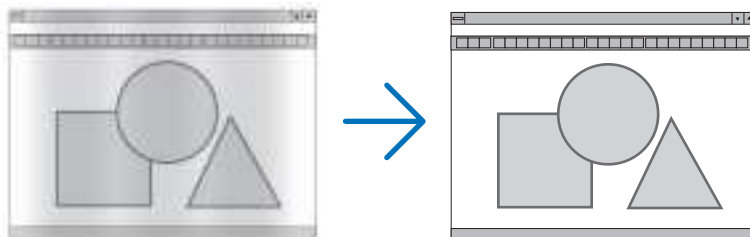

CLOCK	Use this item to fine tune the computer image or to remove any vertical banding that might appear. This function adjusts the clock frequencies that eliminate the horizontal banding in the image. This adjustment may be necessary when you connect your computer for the first time.
-------	--

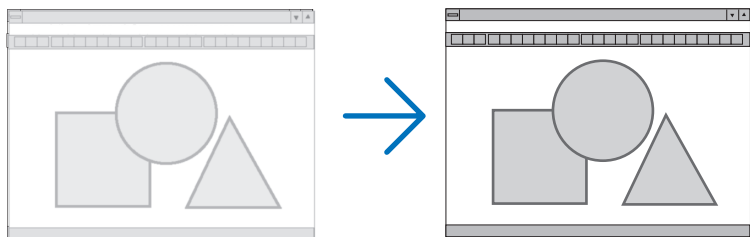

PHASE	Use this item to adjust the clock phase or to reduce video noise, dot interference or cross talk. (This is evident when part of your image appears to be shimmering.) Use [PHASE] only after the [CLOCK] is complete.
-------	---

Adjusting Horizontal/Vertical Position [HORIZONTAL/VERTICAL]

Adjusts the image location horizontally and vertically.

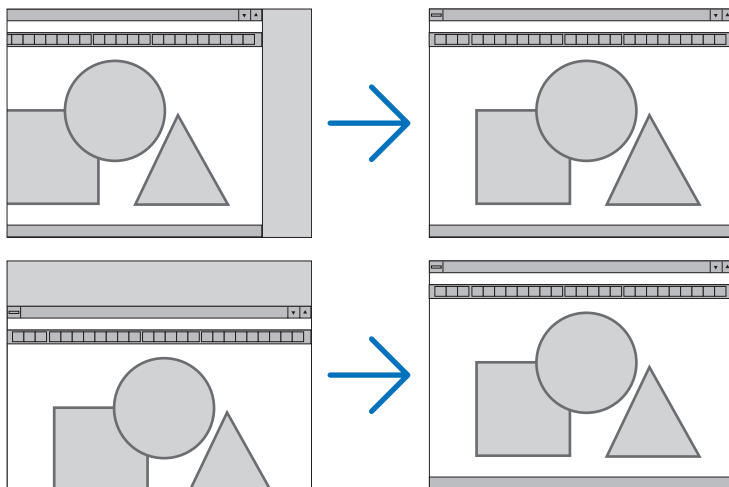

NOTE:

- [CLOCK], [PHASE], [HORIZONTAL] and [VERTICAL] can only be selected when inputting analog signals.
- An image can be distorted during the adjustment of [CLOCK] and [PHASE]. This is not malfunction.
- The adjustments for [CLOCK], [PHASE], [HORIZONTAL], and [VERTICAL] will be stored in memory for the current signal. The next time you project the signal with the same resolution, horizontal and vertical frequency, its adjustments will be called up and applied. To delete adjustments stored in memory, from the menu, you select [RESET] → [CURRENT SIGNAL] or [ALL DATA] and reset the adjustments.

Selecting Overscan Percentage [OVERSCAN]

This allows you to set the appropriate overscan for an incoming signal.

When [AUTO] is selected, the over-scan that is most suitable for the input signal is carried out and displayed.

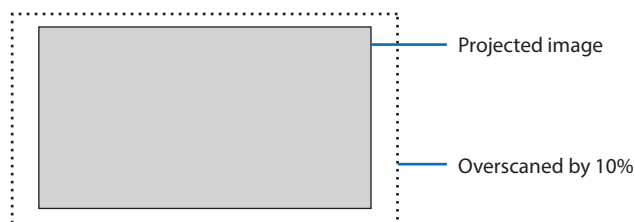

NOTE:

- The [OVERSCAN] item cannot be selected when VIDEO signals are used or when [NATIVE] is selected for [ASPECT RATIO].

Selecting Aspect Ratio [ASPECT RATIO]

The term “aspect ratio” refers to the ratio of width to height of a projected image. The projector automatically determines the incoming signal and displays it in its appropriate aspect ratio.

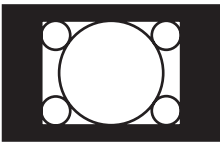
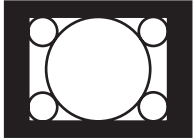
Options	Function
AUTO	The projector will automatically determine the incoming signal and display it in its aspect ratio. The projector may erroneously determine the aspect ratio depending on its signal. If this occurs, select the appropriate aspect ratio from the following.
4:3	The image is displayed in 4:3 aspect ratio.
16:9	The image is displayed in 16:9 aspect ratio.
15:9	The image is displayed in 15:9 aspect ratio.
16:10	The image is displayed in 16:10 aspect ratio.
LETTERBOX	The image of a letterbox signal is stretched equally in the horizontal and vertical directions to fit the screen. Parts of the displayed image are cropped at the top and bottom edges and therefore not visible.
NATIVE	<p>The projector displays the current image in its true resolution when the incoming computer signal has a lower resolution than the projector's native resolution.</p> <div style="display: flex; justify-content: space-between; align-items: flex-start;"> <div style="width: 60%;"> <p>[Example 1] When the incoming signal with the resolution of 800×600 is displayed on the PE455UL/PE455WL:</p>  </div> <div style="width: 35%; text-align: center;">  </div> </div> <p>[Example 2] When the incoming signal with the resolution of 800×600 is displayed on the PE505XL:</p>
	<p>NOTE:</p> <ul style="list-style-type: none"> When a non-computer signal is displayed, the [NATIVE] is not available. When a signal with a higher resolution than the projector's native resolution is displayed, [NATIVE] is not available.

TIP:

- This table shows typical resolutions and aspect ratios that most computers support.

	Resolution	Aspect Ratio
VGA	640×480	4:3
SVGA	800×600	4:3
XGA	1024×768	4:3
WXGA	1280×768	15:9
WXGA	1280×800	16:10
WXGA+	1440×900	16:10
SXGA	1280×1024	5:4
SXGA+	1400×1050	4:3
UXGA	1600×1200	4:3
Full HD	1920×1080	16:9
WUXGA	1920×1200	16:10
4K	3840×2160	16:9

Adjusting the Vertical Position of Image [POSITION] (not available on PE455UL/PE455WL)

(only when [16:9], [15:9], or [16:10] is selected for [ASPECT RATIO])

When [16:9], [15:9], or [16:10] is selected in [ASPECT RATIO], the image is displayed with black borders on the top and bottom.

You can adjust the vertical position from the top to the bottom of the black area.

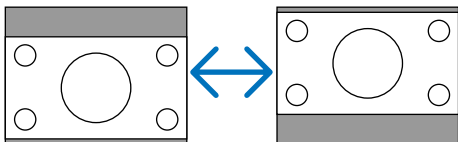

[AUDIO]

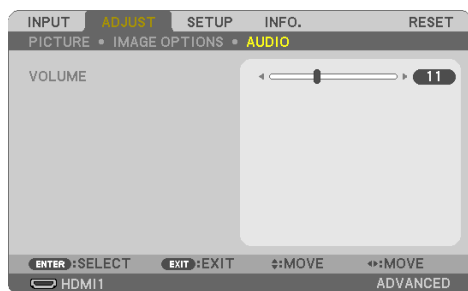

Turning Up or Down Sound

Adjusts the volume of the projector speaker and AUDIO OUT (Stereo Mini Jack).

TIP:

- When no menus appear, the ◀ and ▶ buttons on the projector cabinet and the VOL. +/- buttons on the remote control work as a volume control. (→ page 32)

4-5. Menu Descriptions & Functions [SETUP]

[GENERAL]

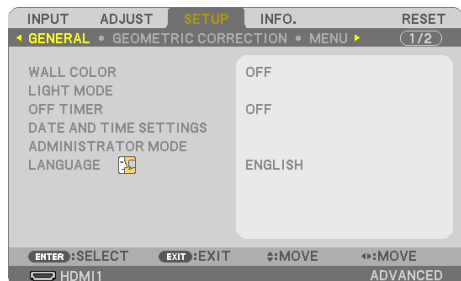

Using the Wall Color Correction [WALL COLOR]

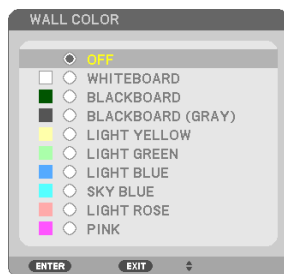

This function allows for quick adaptive color correction in applications where the screen material is not white.

NOTE:

- Selecting [WHITEBOARD] reduces brightness.

Eco mode selection and brightness adjustment [LIGHT MODE]

Adjusting the energy savings settings and the brightness of each projector in multi-screen projection. For energy savings settings, see page 37 “3-4 Changing Eco Mode/Checking Energy-Saving Effect”.

ECO MODE	OFF	The light module luminance (brightness) will be at the setup brightness for [ADJUST].
	ECO	By controlling the brightness and fan speed, energy can be saved and motion noise and the power consumption can be lowered.
	LONG LIFE	The mode optimizes the service life of the light module.
ADJUST		Brightness can be adjusted in 1% increments from 30 to 100% (PE455WL: 33 to 100%). When several projectors are used for multi-screen projection, the brightness can be adjusted individually on each projector. The adjustment is valid when [ECO MODE] is set to [OFF].
CONSTANT BRIGHTNESS	OFF	[CONSTANT BRIGHTNESS] mode will be canceled.
	ON	Maintains the brightness that is in effect at the time [ON] is selected. Unless [OFF] is selected, the same settings will remain in effect even when the projector is turned off. <ul style="list-style-type: none"> To re-adjust the brightness, first turn this setting OFF before making further adjustments.
		NOTE: <ul style="list-style-type: none"> [CONSTANT BRIGHTNESS] mode is a function used to maintain the brightness at a constant level. Color will not be fixed.

NOTE:

- [CONSTANT BRIGHTNESS] can be selected if [ECO MODE] is set to [OFF] and [ADJUST] is set to 50 to 70% (PE455WL: 56 to 77%).
- When [CONSTANT BRIGHTNESS] is set to [ON], [ECO MODE] and [ADJUST] cannot be selected.

TIP:

- Brightness normally decreases with use, but by selecting [CONSTANT BRIGHTNESS] mode, the projector automatically adjust the output based on the projector used time, thereby maintaining a constant brightness throughout the life of the light module. However, if output is already at its maximum, brightness will decrease with use.

Using Off Timer [OFF TIMER]

1. Select your desired time between 30 minutes and 16 hours: OFF, 0:30, 1:00, 2:00, 4:00, 8:00, 12:00, 16:00.
2. Press the ENTER button on the remote control.
3. The remaining time starts counting down.
4. The projector will turn off after the countdown is complete.

NOTE:

- To cancel the preset time, set [OFF] for the preset time or turn off the power.
 - When the remaining time reaches 3 minutes before the projector is turned off, the [THE PROJECTOR WILL TURN OFF WITHIN 3 MINUTES.] message will be displayed on the bottom of the screen.
-

Setting the date and time [DATE AND TIME SETTINGS]

Display the start-up screen of MultiPresenter (→ page 150)

Configuring the menu settings [ADMINISTRATOR MODE]

This allows you to select [MENU MODE], save settings, and set a [KEYWORD] for the [ADMINISTRATOR MODE].

MENU MODE	Select either [BASIC] or [ADVANCED] menu. (→ page 50)
NOT SAVE SETTING VALUES	When [ON] is selected, the values of the items configured in the on-screen menu will not be saved.
KEYWORD	Assign a password for the administrator mode. Enter the password using the ▲▼◀▶ buttons and press the ENTER button. (Up to 10 alphanumeric characters)

Selecting Menu Language [LANGUAGE]

You can choose one of 30 languages for on-screen instructions.

NOTE:

- Your setting will not be affected even when [RESET] is done from the menu.
-

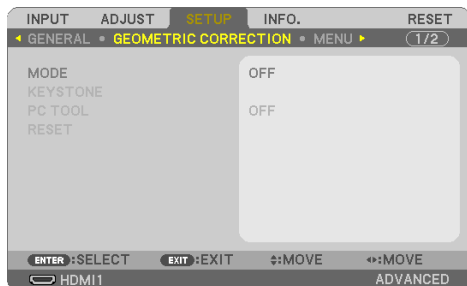
[GEOMETRIC CORRECTION]**[MODE]**

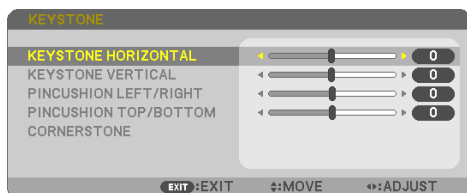

Set pattern for correcting distortion. If [OFF] is selected, the [GEOMETRIC CORRECTION] becomes ineffective.



Correcting Keystone Distortion Manually [KEYSTONE]

You can correct horizontal or vertical keystone, pincushion LEFT/RIGHT or TOP/BOTTOM, or cornerstone distortion manually.

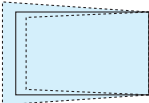
NOTE:

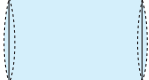
- [KEYSTONE HORIZONTAL] and [KEYSTONE VERTICAL] can be adjusted at once.
- To change from one item to another item, reset the first item.
- Adjustment values will be overwritten. They will not be deleted even when the projector is turned off.
- Using [KEYSTONE], [PINCUSHION] and [CORNERSTONE] correction can cause the image to be slightly blurred because the correction is made electronically.

KEYSTONE HORIZONTAL	Corrects horizontal keystone distortion. (→ page 28)	
KEYSTONE VERTICAL	Corrects vertical keystone distortion. (→ page 28)	
PINCUSHION LEFT/RIGHT	Corrects pincushion distortion at the left or right side. (→ page 42)	

PINCUSHION TOP/BOTTOM	Corrects pincushion distortion at the top or bottom side. (→ page 42)	
CORNERSTONE	Fits a projected image within the border of the screen easily by align the four corner of an image to the ones of the screen. (→ page 39)	

TIP:

- Adjustable range of the [KEYSTONE] and the [CORNERSTONE]:

Horizontal Direction	Vertical Direction
Approx. $\pm 30^\circ$ (Max)	Approx. $\pm 30^\circ$ (Max)

Adjustable range may be narrower depending on input signal.

[PC TOOL]

Recall the geometric correction data that is registered in the projector beforehand.
The geometric correction data using our Geometric Correction Tool application (→ page 44) is registered here.

NOTE:

- As electrical correction is carried out in geometric correction, the brightness may be affected and the picture quality may be degraded.

[RESET]

Resets the item selected at [MODE] on the [GEOMETRIC CORRECTION] screen.
The operation differs depending on the mode selected at [MODE].

MODE	Operation
KEYSTONE	All the [KEYSTONE] adjustments are reset to their initial values.
PC TOOL	Turns off the [PC TOOL] setting. The registered data will not be reset.
OFF	Resetting is invalid.

TIP:

- Resetting can be executed by pressing and holding the KEYSTONE button on the remote control for over 2 seconds.

[MENU]**Selecting Menu Color [COLOR SELECT]**

You can choose between two options for menu color: [COLOR] and [MONOCHROME].

Turning On / Off Input Display [INPUT DISPLAY]

This option turns on or off input name display such as [COMPUTER] to be displayed on the top right of the screen.

When no input signal is present, the no-signal guidance prompting you to check for an available input will be displayed at the center of the screen. When the [USB-A] or [LAN] item is selected for [INPUT], the no-signal guidance will not be displayed.

Turning On/Off Control ID [ID DISPLAY]

This option turns on or off the ID number which is displayed when the ID SET button on the remote control is pressed.

Turning On/Off Eco Message [ECO MESSAGE]

This option turns on or off the following messages when the projector is turned on.

The [ECO MESSAGE] prompts the user to save energy. When [OFF] is selected for [ECO MODE], you will get a message to prompt you to set [ECO MODE].

To close the message, press any one of the buttons. The message will disappear if no button operation is done for 30 seconds.

Selecting Menu Display Time [DISPLAY TIME]

This option allows you to select how long the projector waits after the last touch of a button to turn off the menu. The preset choices are [MANUAL], [AUTO 5 SEC], [AUTO 15 SEC], and [AUTO 45 SEC]. The [AUTO 45 SEC] is the factory preset.

Selecting a Color or Logo for Background [BACKGROUND]

When the HDMI1, HDMI2, or COMPUTER input terminal is selected, select the desired background when there is no input signal.

BLUE	The background color is blue
BLACK	The background color is black
LOGO	Display an image as the background

NOTE:

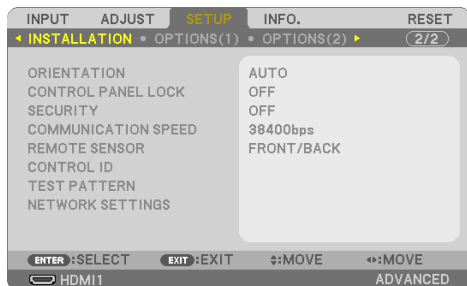

- When [INPUT DISPLAY] is turned on, the no-signal guidance prompting you to check for an available input will be displayed at the center of the screen regardless of its selection.
 - To change the background image to be displayed as a [LOGO], see page 104.
 - Your setting will not be affected even when [RESET] is done from the menu.
-

[INSTALLATION]**Selecting Projector Orientation [ORIENTATION]**

This reorients your image for your type of projection. The options are: desktop front projection, ceiling rear projection, desktop rear projection, and ceiling front projection.

⚠ WARNING

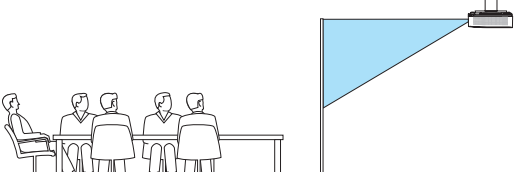
- Should special works be required, for example to suspend the projector from the ceiling, consult your dealer.
Never try to install the projector yourself in such cases. The projector could drop and cause injury.

AUTO	When the light module is turned ON, the inner sensor of the projector detects its installation state either [DESKTOP FRONT] or [CEILING FRONT] and then switch its projection method
DESKTOP FRONT	
CEILING REAR	
DESKTOP REAR	

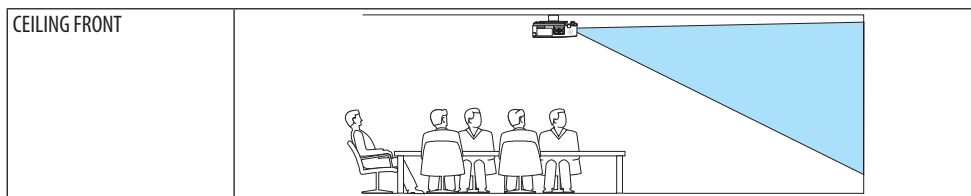

Disabling the Cabinet Buttons [CONTROL PANEL LOCK]

This option turns on or off the [CONTROL PANEL LOCK] function.

NOTE:

- This [CONTROL PANEL LOCK] does not affect the remote control functions.
- How to release the [CONTROL PANEL LOCK]
 1. When the projector is projecting image or in the sleep mode, press and hold the INPUT button on the projector cabinet for about 10 seconds. The [CONTROL PANEL LOCK] will be released.
 2. When the projector is in the standby mode, press and hold the POWER button on the projector cabinet. It enables to power on the projector. After checking the projector is projecting image, perform the previous step 1.

TIP:

- When the [CONTROL PANEL LOCK] is turned on, a key lock icon [] will be displayed at the bottom right of the menu.

Enabling Security [SECURITY]

This feature turns on or off the [SECURITY] function.

Unless the correct keyword is entered, the projector cannot project an image. (→ page 45)

NOTE:

- Your setting will not be affected even when [RESET] is done from the menu.

Selecting Communication Speed [COMMUNICATION SPEED]

This feature sets the baud rate of the PC Control port (D-Sub 9P). It supports data rates from 4800 to 38400 bps. The default is 38400 bps. Select the appropriate baud rate for your equipment to be connected (depending on the equipment, a lower baud rate may be recommended for long cable runs).

NOTE:

- Your selected communication speed will not be affected even when [RESET] is done from the menu.

Turning On or Off Remote Sensor [REMOTE SENSOR]

Set the remote control sensors on the projector's front and rear panels. The options are: [FRONT/BACK], [FRONT], and [BACK].

TIP:

- If the remote control system does not function when direct sunlight or strong illumination strikes the remote control sensor of the projector, change another option.
 - The remote control sensor on the back of the projector cannot be used when the separately sold cable cover is mounted on the projector.
-

Setting ID to the Projector [CONTROL ID]

You can operate multiple projectors separately and independently with the single remote control that has the [CONTROL ID] function. If you assign the same ID to all the projectors, you can conveniently operate all the projectors together using the single remote control. To do so, you have to assign an ID number to each projector.

CONTROL ID NUMBER	Select a number from 1 to 254 you wish to assign to your projector.
CONTROL ID	Select [OFF] to turn off the [CONTROL ID] setting and select [ON] to turn on the [CONTROL ID] setting.

NOTE:

- When [ON] is selected for [CONTROL ID], the projector cannot be operated by using the remote control that does not support the CONTROL ID function. (In this case the buttons on the projector cabinet can be used.)
 - Your setting will not be affected even when [RESET] is done from the menu.
 - Pressing and holding the ENTER button on the projector cabinet for 10 seconds will display the menu for canceling the Control ID.
-

Assigning or Changing the Control ID

1. Turn on the projector.
2. Press the ID SET button on the remote control.

The [CONTROL ID] screen will be displayed.



If the projector can be operated with the current remote control ID, the [CONTROL ID (ACTIVE)] will be displayed. If the projector cannot be operated with the current remote control ID, the [CONTROL ID (INACTIVE)] will be displayed. To operate the inactive projector, assign the [CONTROL ID] used for the projector by using the following procedure (Step 3).

3. Press one of numeric keypad buttons while pressing and holding the ID SET button on the remote control.

Example:

To assign "3", press the "3" button on the remote control.

No ID means that all the projectors can be operated together with a single remote control. To set "No ID", enter "000" or press the CLEAR button.

TIP:

- The range of IDs is from 1 to 254.

4. Release the ID SET button.

The updated [CONTROL ID] screen will be displayed.

NOTE:

- The IDs can be cleared in a few days after the batteries are run down or removed.
- Accidentally pressing any one of the buttons of the remote control will clear currently specified ID with batteries removed.

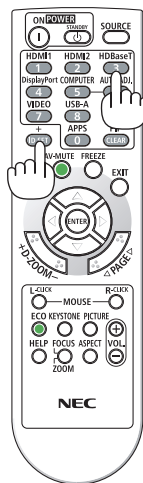
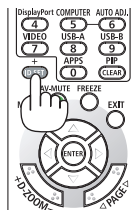

Using Test Pattern [TEST PATTERN]

Displays the test pattern for adjusting distortion on the screen and the focus at the time of the projector setup. Once the [TEST PATTERN] on the onscreen menu is selected, the pattern for adjustment will be displayed on. If you find distortion on the pattern, adjust the projector installation angle or correct distortion by pressing the KEYSTONE button on the remote. If the focus adjustment is required, control the focus lever. Recommend to perform the focus adjustment after leaving the projector under the state the TEST PATTERN has been projected for over 30 minutes. Press EXIT button to close the test pattern and return to the menu.

Setting the network [NETWORK SETTINGS]

This function display the [NETWORK SETTINGS] menu. (→ page 109)

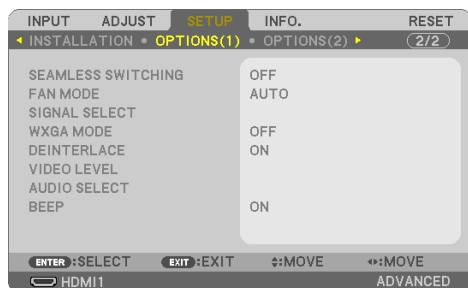
[OPTIONS(1)]**Switching the displayed image smoothly [SEAMLESS SWITCHING]**

When the input connector is switched, the image displayed before switching is held to switch to the new image without a break due to absence of a signal.

Selecting Fan Mode [FAN MODE]

[FAN MODE] is used to set the speed of the internal cooling fan.

AUTO	The built-in fans automatically run at a variable speed according to the internal temperature.
HIGH ALTITUDE	The built-in fans run at a high speed. Select this option when using the projector at altitudes approximately 5200 feet/1600 meters or higher.

NOTE:

- Set [FAN MODE] to [HIGH ALTITUDE] when using the projector at altitudes approximately 5200 feet/1600 meters or higher.
- Using the projector at altitudes approximately 5200 feet/1600 meters or higher without setting to [HIGH ALTITUDE] can cause the projector to overheat and the protector could shut down. If this happens, wait a couple minutes and turn on the projector.
- Using the projector at altitudes approximately 5200 feet/1600 meters or higher can shorten the life of optical components such as the light module.
- Your setting will not be affected even when [RESET] is done from the menu.

Selecting Signal Format [SIGNAL SELECT]

This selects the signal to be input in the COMPUTER IN Terminal. Normally, this is set to [RGB/COMPONENT]. Change the setting if the color of the picture is unnatural.

RGB/COMPONENT	Automatically distinguishes RGB and component signals.
RGB	Switches to the RGB input.
COMPONENT	Switches to the component input.

Enabling or Disabling WXGA Mode [WXGA MODE]

Selecting [ON] will give priority to WXGA (1280 × 768)/WUXGA (1920 × 1200) signals in recognizing an input signal.

When [WXGA MODE] is set to [ON], XGA (1024 × 768)/UXGA (1600 × 1200) signals may not be recognized. In this case, select [OFF].

NOTE:

- The [ON] is selected at the time of shipment.

Enabling the deinterlace [DEINTERLACE]

Turns on or off the deinterlace function for a telecine signal.

OFF	Select this option if there is any jitter or artifacts in video.
ON	Default standard setting.

NOTE:

- This function is not available for HDTV (progressive) and computer signals.

Setting HDMI1 or HDMI2 [VIDEO LEVEL]

Make the settings for each video level when connecting HDMI equipment.

Select [AUTO] to automatically detect video level. If automatic detection may not work well, select [NORMAL] to disable the [ENHANCED] feature of your HDMI equipment or select [ENHANCED] to improve image contrast and increase detail in the dark areas.

Setting Audio [AUDIO SELECT]

This selects the audio inputs of the HDMI 1 IN terminal, HDMI 2 IN terminal, and LAN port of the unit. When inputting analog audio, connect the audio output terminal of the connected device to the AUDIO IN terminal of the unit and set the audio input selection to [COMPUTER].

Enabling Key Sound and Error Sound [BEEP]

This feature turns on or off the button sound or alarm when an error occurs or the following operations are performed.

TIP:

- Volume control for [BEEP] is disabled. AV-MUTE button is not effective to stop beeping sound. If you want to activate BEEP function, set [BEEP] to [OFF].

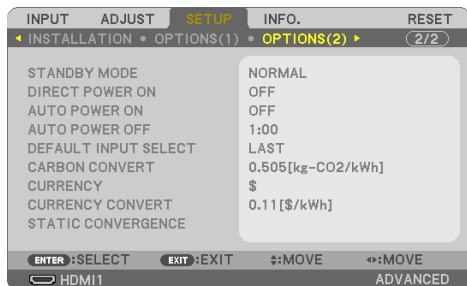
[OPTIONS(2)]**Selecting Power-saving in [STANDBY MODE]**

Set the mode after turning off the power of the projector.

NORMAL	The projector will go into the standby mode, lowering the power consumption. The POWER indicator flashes in orange. When [NORMAL] is selected, only the following buttons and feature will work: POWER button on the projector cabinet and the remote control, powering on from PC Control command, and [AUTO POWER ON].	Power consumption: Low
NETWORK STANDBY	The projector goes into the network standby mode. The power supply of the projector can be turned on using a wired LAN (LAN port). The POWER indicator lights up in orange. When [NETWORK STANDBY] is selected, only the following buttons, terminals, and features will work: POWER button on the projector cabinet and the remote control, powering on from PC Control command, [AUTO POWER ON], [NETWORK SERVICE].	Power consumption: Medium
SLEEP	The projector is maintained in the sleep mode. POWER indicator lights up in green.	Power consumption: High

Important:

- When [NETWORK STANDBY] has been set for [STANDBY MODE] and the LAN has been in link-down condition for 3 minutes, [STANDBY MODE] will transit into [NORMAL] automatically for the purpose to save the consumption power.
- When [NETWORK STANDBY] is selected, [AUTO POWER OFF] will turn in grey and be disabled and [0:15] will be selected automatically for [AUTO POWER OFF].
- In the below conditions, setting of the [STANDBY MODE] is disabled and the projector will go into the SLEEP mode*.

* Sleep mode refers the mode without functional restrictions by the [STANDBY MODE].

When [STANDBY MODE] → [NETWORK STANDBY] is selected

- When [NETWORK SERVICE] → [AMX BEACON] → [ON] is selected
- When [NETWORK SERVICE] → [CRESTRON] → [Crestron Control] → [ON] is selected
- When [NETWORK SETTINGS] → [WIRELESS LAN] → Except for [DISABLE] and mounting the wireless LAN unit to the projector
- When the signal is input to the computer, HDMI 1 IN or HDMI 2 IN terminals

TIP:

- Even when [NORMAL] is selected for [STANDBY MODE], power on or off can be done by using the PC CONTROL port. However, in the [NORMAL] mode, ASCII CONTROL COMMAND cannot be used. When using ASCII CONTROL COMMAND, set it to [NETWORK STANDBY] or [SLEEP].
- The power consumption in the standby mode will not be included in calculating CO₂ emission reduction.
- Your setting will not be affected even when [RESET] is done from the menu.

Enabling Direct Power On [DIRECT POWER ON]

Turns the projector on automatically when the power cord is inserted into an active power outlet. This eliminates the need to always use the POWER button on the remote control or projector cabinet.

Turning On the Projector By Applying Computer Signal [AUTO POWER ON]

When the projector is in Standby mode, applying a computer or HDMI signal from a computer connected to the COMPUTER IN input, HDMI 1 IN, or HDMI 2 IN input will power on the projector and simultaneously project the image.

This functionality eliminates the need to always use the POWER button on the remote control or the projector cabinet to power on the projector.

To use this function, first connect a computer to the projector and the projector to an active AC input.

OFF	The AUTO POWER ON function will not work.
AUTO	The projector's power turns on and the image is projected automatically when computer or HDMI signals are detected. If more than one device is connected to the projector and the input signals cannot be detected correctly, select the input terminal (HDMI1, HDMI2 or COMPUTER).
HDMI1	Signal detection is performed for the selected input terminal.
HDMI2	When a signal is detected, the projector's power turns on automatically and the image is projected.
COMPUTER	

NOTE:

- This function will not be available under the following conditions:
 - when a component signal is applied to the COMPUTER IN terminal
 - when a Sync on Green RGB signal or composite sync signal is applied
- To enable the [AUTO POWER ON] after changing to the sleep mode turning off the projector, wait 30 seconds and input a computer or HDMI signal.
If a computer or HDMI signal is still present when the projector is turned off, the [AUTO POWER ON] will not work and the projector remains in standby mode.
- Depending on the projector in use, the [AUTO POWER ON] may not work properly.
In this case, set [STANDBY MODE] to [NETWORK STANDBY].

Enabling Power Management [AUTO POWER OFF]

When this option is selected you can enable the projector to automatically turn off (at the selected time: 0:05, 0:10, 0:15, 0:20, 0:30, 1:00) if there is no signal received by any input or if no operation is performed.

Selecting Default Source [DEFAULT INPUT SELECT]

You can set the projector to default to any one of its inputs each time the projector is turned on.

LAST	Sets the projector to default to the previous or last active input each time the projector is turned on.
AUTO	Searches for an active source in order of [HDMI1] → [HDMI2] → [COMPUTER] → [USB-A] → [LAN] and displays the first found source.
HDMI1	Displays the digital source from the HDMI 1 IN terminal every time the projector is turned on.
HDMI2	Displays the digital source from the HDMI 2 IN terminal every time the projector is turned on.
COMPUTER	Displays the computer signal from the COMPUTER IN terminal every time the projector is turned on.
USB-A	Display the [VIEWER].
LAN	Displays a signal from LAN port (RJ-45) or the USB Wireless LAN Unit.

Setting carbon footprint factor [CARBON CONVERT]

Adjusts the carbon footprint factor in the carbon saving calculation. The initial setting is 0.505[kg-CO₂/kWh] based on the CO₂ Emissions from Fuel Combustion (2008 Edition) published by OECD.

Selecting your currency [CURRENCY]

Displays electricity pricing (available in 4 currency units).

\$	US Dollar
€	EU Euro
JP¥	Japanese Yen
RMB¥	Chinese Yuan

Changing currency setting and currency convert setting [CURRENCY CONVERT]

Changes currency setting and currency convert setting for CARBON METER.

The initial setting are as follows:

US Dollar	0.11 [\$/kWh]
EU Euro	0.19 [€/kWh]
Japanese Yen	20 [¥/kWh]
Chinese Yuan	0.48 [¥/kWh]

The initial settings for US dollar, EU Euro, and Japanese Yen are based on “Energy Prices and Taxes (second quarter 2010)” published by OECD.

The initial setting for Chinese Yuan is based on “Chinese Data File (2010)” published by JETRO.

Adjusting the color shift of the screen [STATIC CONVERGENCE]

This features allows you to adjust for color deviation in the picture.

This can be adjusted in units of ± 1 pixel in the horizontal direction for [HORIZONTAL R], [HORIZONTAL G] and [HORIZONTAL B], in the vertical direction for [VERTICAL R], [VERTICAL G] and [VERTICAL B].

NOTE:

- This function is not available for PE455WL/PE505XL.

4-6. Menu Descriptions & Functions [INFO.]

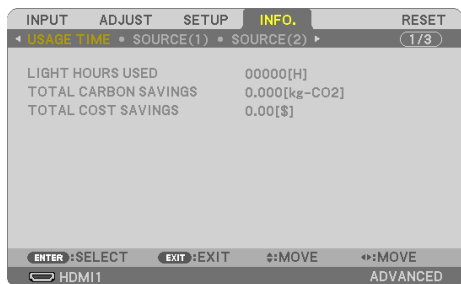

Displays the status of the current signal and light module usage. This item has nine pages. The information included is as follows:

TIP:

- Pressing the HELP button on the remote control will show the [INFO.] menu items.

[USAGE TIME]

[LIGHT HOURS USED] (H)

[TOTAL CARBON SAVINGS] (kg-CO2)

[TOTAL COST SAVINGS]

- [TOTAL CARBON SAVINGS]

This displays the estimated carbon saving information in kg. The carbon footprint factor in the carbon saving calculation is based on the OECD (2008 Edition). (→ page 38)

[SOURCE(1)]

[SOURCE NAME]

[HORIZONTAL FREQUENCY]

[SYNC TYPE]

[SCAN TYPE]

[SOURCE INDEX]

[VERTICAL FREQUENCY]

[SYNC POLARITY]

[SOURCE(2)]

[SIGNAL TYPE]

[BIT DEPTH]

[VIDEO TYPE]

[VIDEO LEVEL]

[WIRED LAN]

[IP ADDRESS]

[GATEWAY]

[SUBNET MASK]

[MAC ADDRESS]

[WIRELESS LAN]

[IP ADDRESS]

[GATEWAY]

[SSID]

[SECURITY]

[SIGNAL LEVEL]

[SUBNET MASK]

[MAC ADDRESS]

[NETWORKTYPE]

[CHANNEL]

[VERSION(1)]

[FIRMWARE] Version

[DATA] Version

[VERSION(2)]

[FIRMWARE2] Version

[DATA2] Version

[OTHERS]

[DATE TIME]

[HOST NAME]

[SERIAL NUMBER]

[CONTROL ID] (when [CONTROL ID] is set)

[PROJECTOR NAME]

[MODEL NO.]

[LAN UNIT TYPE]

[CONDITIONS]

[INTAKE TEMPERATURE]

[INSTALLATION POSITION]

[Y-AXIS]

[EXHAUST TEMPERATURE]

[X-AXIS]

[Z-AXIS]

About the X-AXIS, Y-AXIS and Z-AXIS CONDITIONS

(NOTE) Arrow direction of the Z-AXIS in the figure represents the top of the projector.

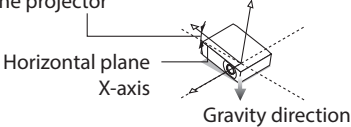
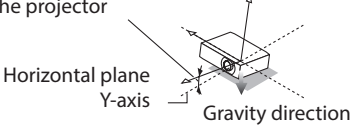
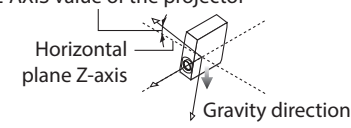
X-AXIS	Display the projector image at an angle of $-100 - +100$ degrees to the horizontal in the X-axis direction.	<p>X-AXIS value of the projector</p>  <p>Horizontal plane X-axis Gravity direction</p>
Y-AXIS	Display the projector image at an angle of $-100 - +100$ degrees to the horizontal in the Y-axis direction.	<p>Y-AXIS value of the projector</p>  <p>Horizontal plane Y-axis Gravity direction</p>
Z-AXIS	Display the projector image at an angle of $-100 - +100$ degrees to the vertical in the Z-axis direction.	<p>Z-AXIS value of the projector</p>  <p>Horizontal plane Z-axis Gravity direction</p>

4-7. Menu Descriptions & Functions [RESET]

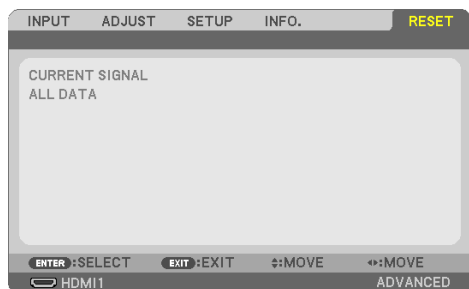

Returning to Factory Default [RESET]

The [RESET] feature allows you to change adjustments and settings to the factory preset for a (all) source(s) except the following:

[CURRENT SIGNAL]

Resets the adjustments for the current signal to the factory preset levels.

The items that can be reset are: [PRESET], [CONTRAST], [BRIGHTNESS], [COLOR], [HUE], [SHARPNESS], [ASPECT RATIO], [HORIZONTAL], [VERTICAL], [CLOCK], [PHASE], and [OVERSCAN].

[ALL DATA]

Reset all the adjustments and settings for all the signals to the factory preset.

All items can be reset **EXCEPT** [KEystone HORIZONTAL], [KEystone VERTICAL], [PINCUSHION], [PC TOOL], [DATE AND TIME SETTINGS], [ADMINISTRATOR MODE], [LANGUAGE], [BACKGROUND], [ORIENTATION], [SECURITY], [COMMUNICATION SPEED], [CONTROL ID], [NETWORK SETTINGS], [FAN MODE], [STANDBY MODE], [CARBON CONVERT], [CURRENCY], [CURRENCY CONVERT], [STATIC CONVERGENCE], [LIGHT HOURS USED], [TOTAL CARBON SAVINGS], [TOTAL COST SAVINGS], [PROJECTOR NAME], [WIRED LAN], and [WIRELESS LAN].

5. Making Connections

NOTE:

- Use the attached specified cables with this projector so as not to interfere with radio and television reception.
For HDMI, LAN, RS-232C and AUDIO, please use a shielded signal cable.
For 15-pin mini D-Sub, please use a shielded signal cable with ferrite core.
Use of other cables and adapters may cause interference with radio and television reception.
-

5-1. Connecting Your Computer

Computer cables and HDMI can be used to connect to a computer. The HDMI cable is not enclosed with the projector. Please get ready a suitable cable for the connection.

NOTE:

- Signals supported by Plug & Play (DDC2)



INPUT		
COMPUTER IN	HDMI 1 IN	HDMI 2 IN
analog	digital	digital
Yes	Yes	Yes

NOTE:

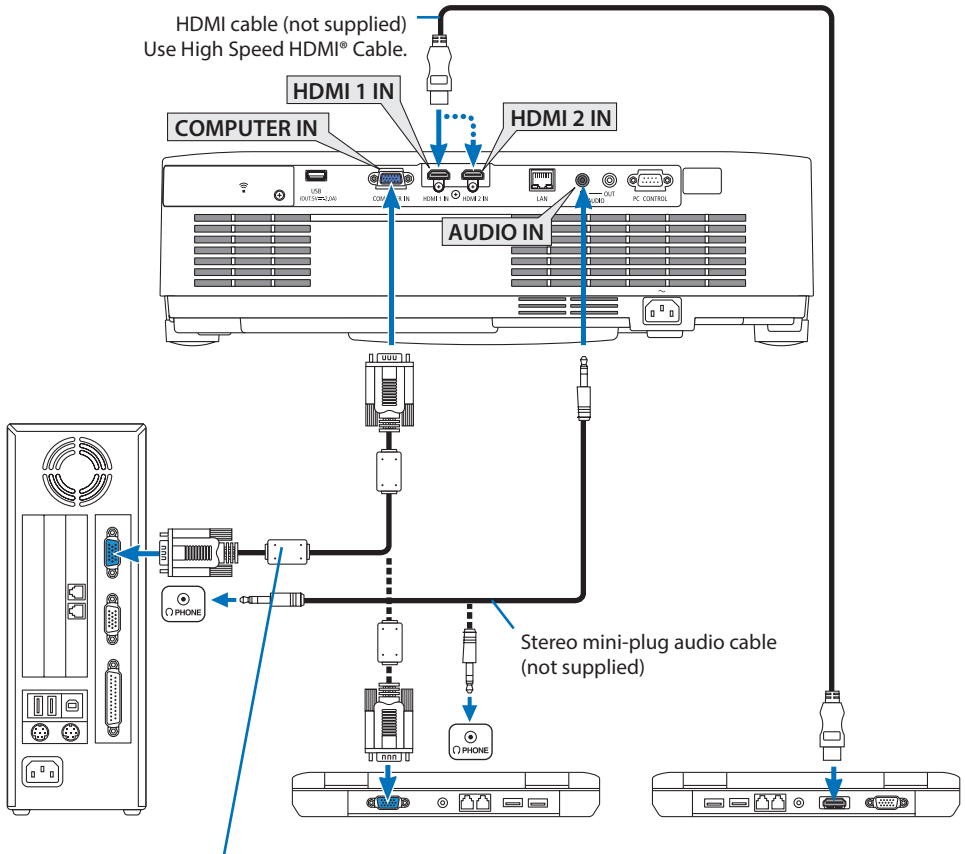
- The projector is not compatible with video decoded outputs of the NEC ISS-6020 switcher.
 - An image may not be displayed correctly when a Video source is played back via a commercially available scan converter.
This is because the projector will process a video signal as a computer signal at the default setting. In that case, do the following.
 - * When an image is displayed with the lower and upper black portion of the screen or a dark image is not displayed correctly:
Project an image to fill the screen and then press the AUTO ADJ. button on the remote control.
-



- Select the source name for its appropriate input terminal after turning on the projector.

Input terminal	INPUT button on the projector cabinet	Button on the remote control
HDMI 1 IN	 HDMI1	HDMI1
HDMI 2 IN	 HDMI2	HDMI2
COMPUTER IN	 COMPUTER	COMPUTER

Cautions when using a DVI signal

- When the computer has a DVI output terminal, use a commercially available converter cable to connect the computer to the projector's HDMI 1 IN or HDMI 2 IN terminal (only digital video signals can be input).
 - Only digital video signals can be input.

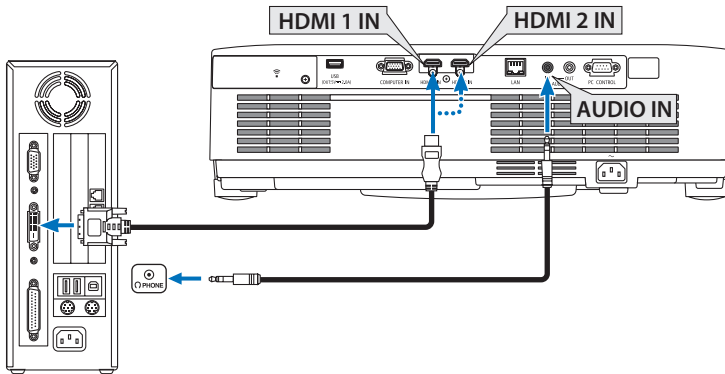

Connect the audio output of the computer to the projector's AUDIO IN terminal. In this case, switch the [HDMI1] or [HDMI2] setting at [SETUP] → [OPTIONS(1)] → [AUDIO SELECT] the on-screen menu to [COMPUTER]. (→ page 75)

NOTE:

When Viewing a DVI Digital Signal

- Turn off the power of the computer and projector before connecting.
- When a video deck is connected via a scan converter, etc., the display may not be correct during fast-forwarding and rewinding.
- Use a DVI-to-HDMI cable compliant with DDWG (Digital Display Working Group) DVI (Digital Visual Interface) revision 1.0 standard. The cable should be within 197"/5 m long.
- Turn off the projector and the PC before connecting the DVI-to-HDMI cable.
- To project a DVI digital signal: Connect the cables, turn the projector on, then select the HDMI input. Finally, turn on your PC. Failure to do so may not activate the digital output of the graphics card resulting in no picture being displayed. Should this happen, restart your PC.
- Do not disconnect the DVI-to-HDMI cable while the projector is running. If the signal cable has been disconnected and then reconnected, an image may not be correctly displayed. Should this happen, restart your PC.
- The COMPUTER video input terminals support Windows Plug and Play.
- A Mac signal adapter (commercially available) may be required to connect a Mac computer.

5-2. Connecting to a DVD player and other AV devices

Connecting Component Input

Connection for component signal. Signal from the color difference signal output terminal on DVD players (DVD video output) and the YPbPr output terminal on the Hi-vision video can be projected. Recommend to connect the terminal for audio output on the DVD player to the audio components.

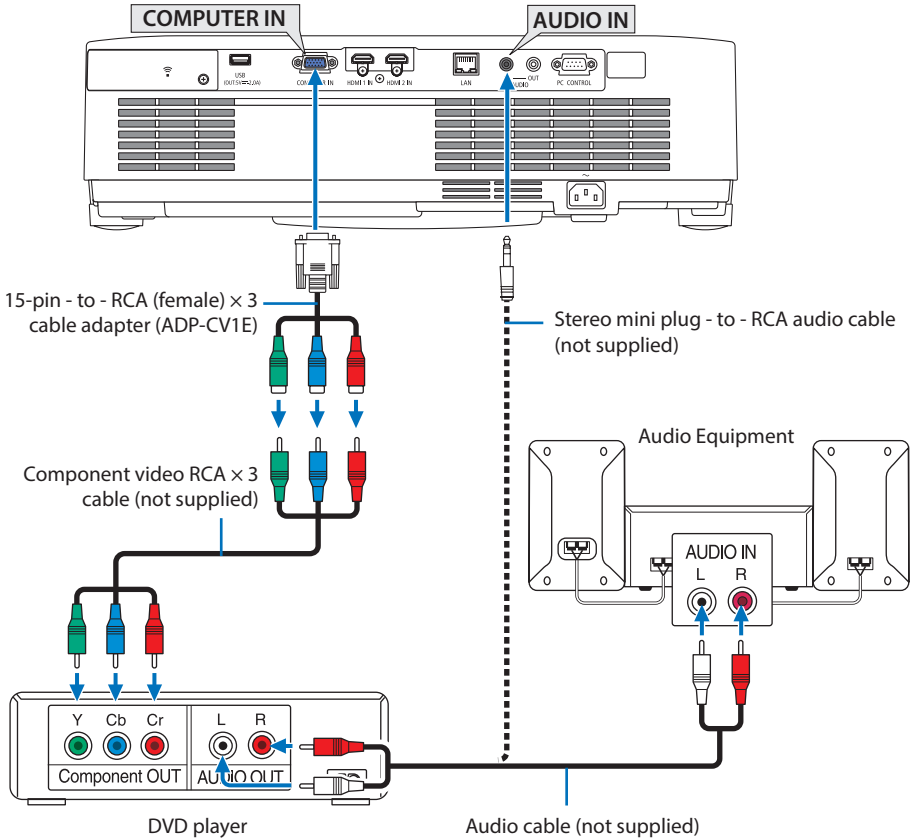

- Select the source name for its appropriate input terminal after turning on the projector.

Input terminal	INPUT button on the projector cabinet	Button on the remote control
COMPUTER IN	COMPUTER	COMPUTER

NOTE:

- Refer to your DVD player's owner's manual for more information about your DVD player's video output requirements.

Connecting HDMI Input

You can connect the HDMI output of your DVD player, hard disk player, Blu-ray player, or notebook type PC to the HDMI IN terminal of your projector.

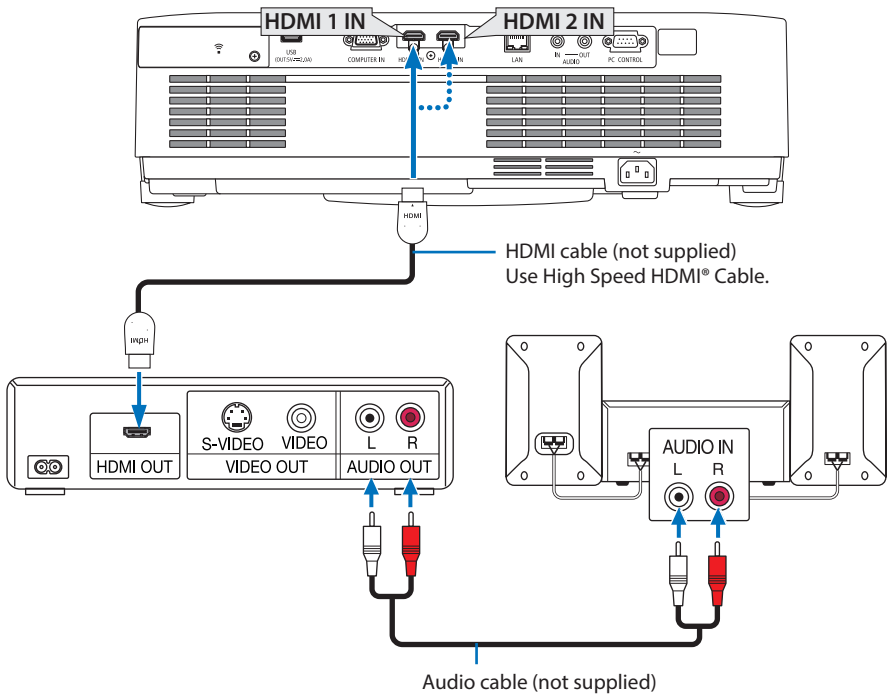

- Select the source name for its appropriate input terminal after turning on the projector.

Input terminal	INPUT button on the projector cabinet	Button on the remote control
HDMI 1 IN	HDMI1	HDMI1
HDMI 2 IN	HDMI2	HDMI2

- When connecting the HDMI 1 IN terminal (or HDMI 2 IN terminal) of the projector to the DVD player, the projector's video level can be made settings in accordance with the DVD player's video level. In the menu select [HDMI SETTINGS] → [VIDEO LEVEL] and make necessary settings.
- If the HDMI input's sound is not output, check if [HDMI1] and [HDMI2] are set [HDMI1] and [HDMI2] correctly the on-screen menu [SETUP] → [OPTIONS(1)] → [AUDIO SELECT]. (→ page 75)

5-3. Connecting to a Wired LAN

When the projector is connected to a wired LAN, you can use the web browser on a computer to control the projector using the HTTP server function.

For more information, see "7. Connecting to a Network" (→ page 106).

Example of LAN connection

Example of wired LAN connection

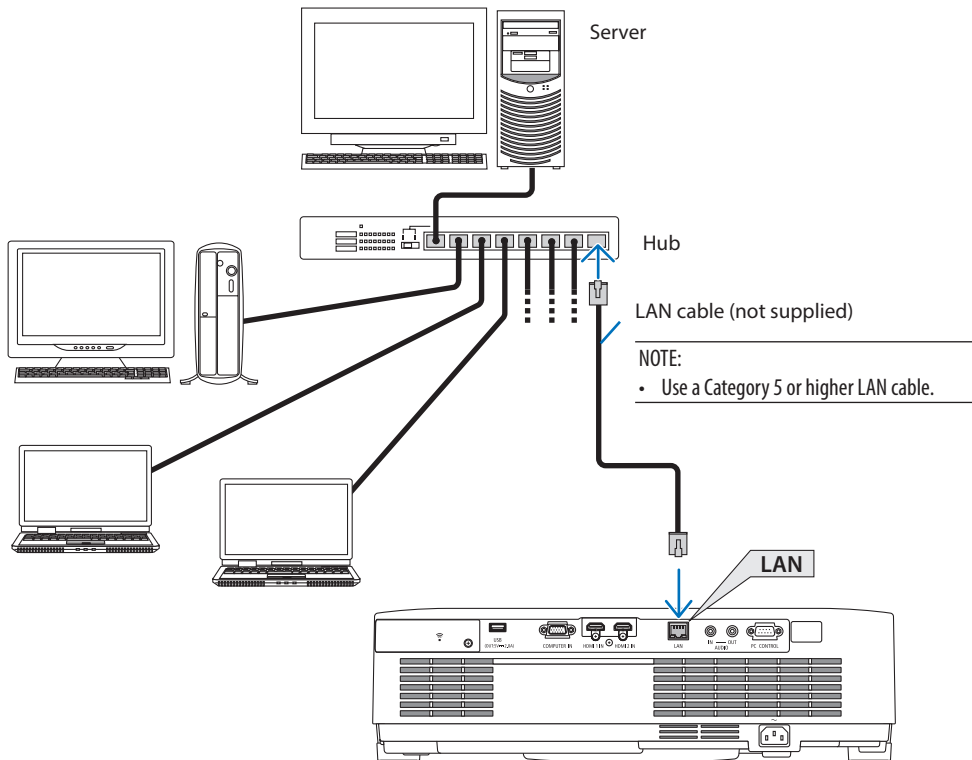

5-4. Connecting to a Wireless LAN (Optional: NP05LM series)

The USB Wireless LAN Unit also provides a wireless LAN connection. To use a wireless LAN connection, you are required to assign an IP address to the projector.

For more information, see "7. Connecting to a Network" (→ page 106).

Important:

- If you use the projector with the USB Wireless LAN Unit in the area where the use of wireless LAN equipment is prohibited, remove the USB Wireless LAN Unit from the projector.
- Buy the appropriate USB Wireless LAN Unit for your country or area.

NOTE:

- Do not press the button on the USB Wireless LAN Unit. The button does not work with this model.
- Your computer's wireless LAN adapter (or unit) must be complied with Wi-Fi (IEEE802.11a/b/g/n) standard.

Example of wireless LAN connection

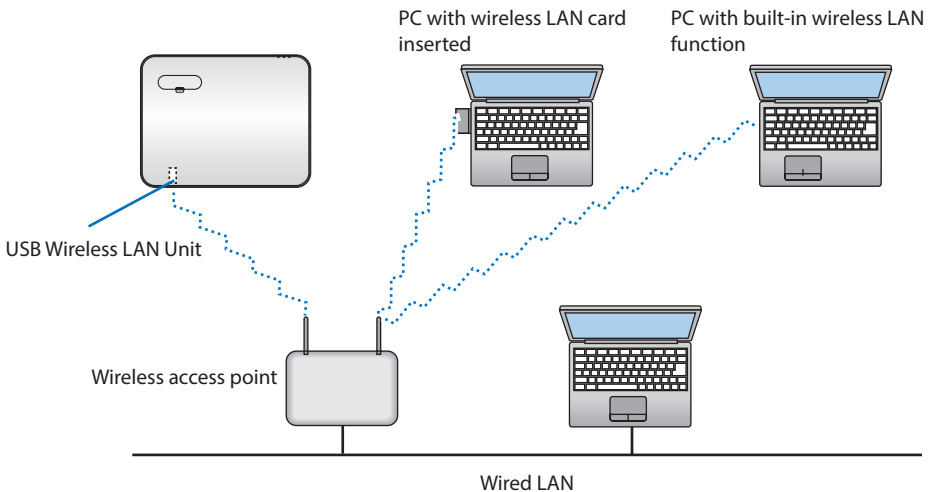

Attaching the USB Wireless LAN Unit

NOTE:

- The USB Wireless LAN Unit must be inserted into the USB Wireless LAN Unit port in the correct direction. It cannot be inserted in the reverse direction. If the USB Wireless LAN Unit is inserted in the reverse direction with excessive force applied, the USB port may break.
- Before touching the USB Wireless LAN Unit, touch a metallic object (such as a door knob or aluminum window frame) to discharge the static electricity from your body.
- Always insert or remove the USB Wireless LAN unit when the main power is turned off. Failure to do so may cause projector malfunction or damage to the USB wireless LAN unit. If the projector will not work correctly, turn off the projector, disconnect the power cord, and then connect it again.
- Do not insert other USB devices into the USB (wireless LAN) port in the wireless LAN cover. Do not insert the USB Wireless LAN unit into the USB port.

NOTE:

- When the cable cover is attached, remove it before inserting the USB Wireless LAN Unit.

1. Press the POWER button to turn off the projector and set it into standby condition, and disconnect the power cord.

2. Remove the wireless LAN cover.

- (1) Turn the screw counterclockwise until it turns freely.

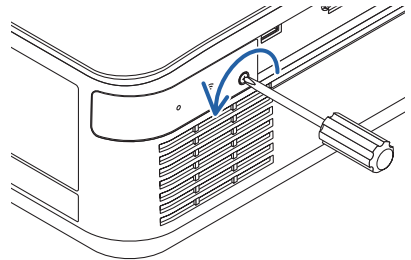

- (2) Hold the head of the screw and remove.

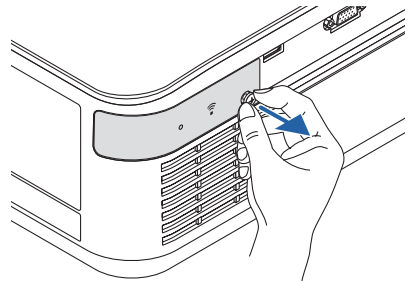

3. Insert the wireless LAN unit into the USB (wireless LAN) port with the side containing the indicator facing up.

- Slowly slide the wireless LAN unit left and right, up and down, checking the insertion slot as you push the unit in.

NOTE:

- Do not force to insert the USB Wireless LAN Unit.

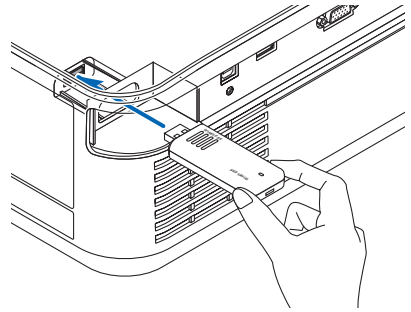

4. Mount the wireless LAN cover.

- (1) Insert the hook on the back of the cover into the groove in the projector and close the wireless LAN cover.

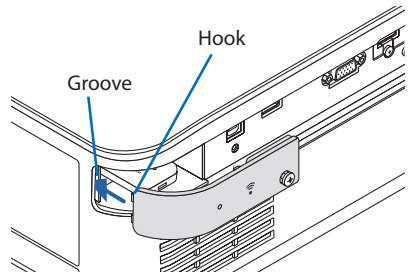

- (2) Turn the screw clockwise to tighten it.

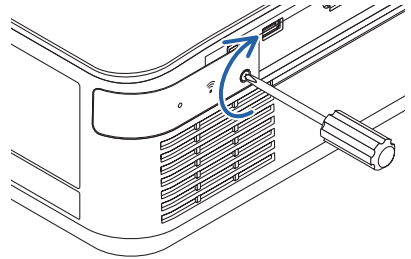

- * **To remove the USB Wireless LAN Unit, disconnect the power cord and use the above procedure.**

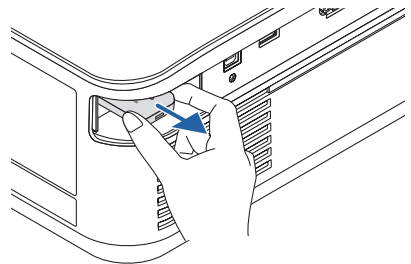

5-5. Portrait projection (vertical orientation)

Portrait screens from a computer can be projected by installing the projector in a vertical orientation.

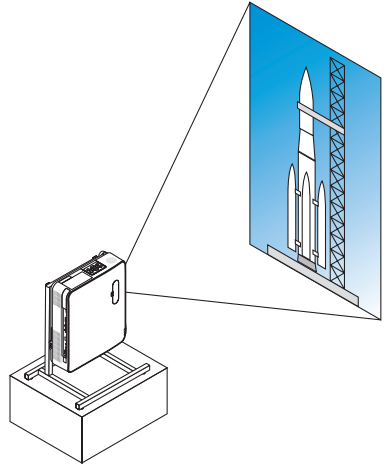

Precautions during installation

- Please do not install the projector in a vertical orientation on top of the floor or table on its own. The intake vent or the exhaust vent may be obstructed, resulting in the projector getting warm and the possibility of fire and malfunction occurring.
- A stand for supporting the projector needs to be made for this purpose. In this case, the stand must be designed such that the center of gravity of the projector is located well within the legs of the stand. If not, the projector may fall over and result in injury, damage and malfunction.
- Take measures to prevent the projector from falling in anticipation of a malfunction occurring in the projector or stand.

Design and manufacturing conditions for the stand

Please engage an installation service provider for the design and manufacture of the customized stand to be used for portrait projection. Please ensure that the following are complied with when designing the stand.

1. Installation facing the exhaust vent downward, maintain a distance of at least 200 mm between the projector exhaust vent and the floor.
Do not obstruct the intake vent at the rear of the projector.
2. Use the four screw holes on the bottom face of the projector to secure it to the stand.
Screw hole center dimension: 200 × 250 mm
Screw hole dimension on the projector: M4 with a maximum depth of 8 mm.
 - * Please design the stand such that the rear legs on the bottom face of the projector do not contact the stand. The tilt foot can be turned and removed.
3. Horizontal adjustment mechanism (for example, bolts and nuts in four locations)
4. Please design the stand such that it does not topple over easily.

Reference drawings

* The drawing showing the dimensional requirements is not an actual stand design drawing.

(Unit: mm)

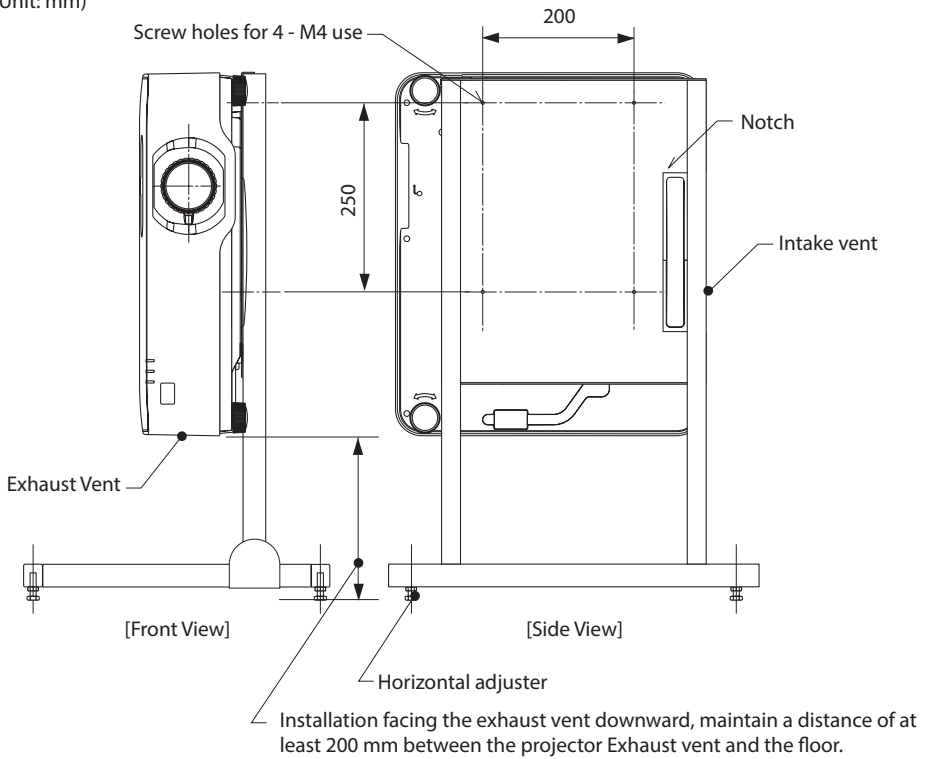

6. Using the VIEWER

6-1. Things you can do with the VIEWER

The [VIEWER] has the following features.

- When you insert a commercially available USB memory containing the picture into the USB port of the projector (Type A), the images on the USB can be projected by the unit. By doing this, you can make a presentation without using a personal computer.
- The types of images that can be projected in the [VIEWER] are JPEG and PNG.
- Thumbnails can be displayed in the [VIEWER], allowing you to quickly select a picture to be projected.
- When projecting multiple pictures continuously ([SLIDESHOW]), the pictures may be switched manually (manual playback) or automatically ([AUTO PLAY]). The interval for changing the pictures can also be modified during [AUTO PLAY].
- The projection order can be specified by the picture file name, file type, date and size, and the ascending/descending order can be selected.
- The orientation of the picture can be rotated in units of 90°.
- You can change the screen of the input terminal in a signal-less state (background logo) or the background image of the MultiPresenter start-up screen (MultiPresenter logo). You can also set a password to prohibit third parties from changing the pictures. (→ page 104)

NOTE:

- When the [VIEWER] (slide screen, file list screen) is being displayed, keystone correction using the ▼ buttons is not possible. To perform keystone correction when the [VIEWER] is being displayed, press the MENU button 2 times to display the on-screen menu.
- When the [VIEWER] is being displayed, the FREEZE button on the remote controller does not work.
- When you select [RESET] → [ALL DATA] in the on-screen menu, the option menu settings of the [VIEWER] return to the default state when shipped from the factory.
- About USB memory
 - Format the USB memory used by the [VIEWER] of the projector in the FAT32 format or FAT16 format.
 - The projector cannot recognize a USB memory that has been formatted in the NTFS format.
 - Check the file system format if the USB memory inserted into the projector is not recognized.
 - Refer to the instruction manual or the help file of the Windows you are using for details on how to format a USB memory.
 - The USB port of the projector does not guarantee that all USB memories commercially available will work.
- About compatible images
 - The following pictures can be projected by the [VIEWER].

JPEG	Extension	jpg, jpe, jpeg (case insensitive)
	Format	Baseline, progressive
	Color	RGB, grayscale
	Resolution	Baseline: Maximum 10000 × 10000 (pixel) Progressive: Maximum 2000 × 2000 (pixel)
	EXIF	EXIF information (rotation/thumbnail, etc.) is not supported.
PNG	Extension	png (case insensitive)
	Format	Normal, interlace
	Color	RGB, index color, grayscale
	Resolution	Normal: Maximum 10000 × 10000 (pixel) Interlace: Maximum 2000 × 2000 (pixel)

6-2. Projecting the pictures on a USB memory (basic operation)

This section explains the basic operations of the [VIEWER]. This is the operating procedure when the option menu (→ page 103) of the [VIEWER] is in the default state when shipped from the factory.

① Start the [VIEWER]

1. Turn on the projector.
2. Insert a USB memory into the USB-A port of the projector.

NOTE:

- To remove a USB memory from the projector, press the MENU button in the file list screen or [DRIVE LIST] screen and select [REMOVE USB DEVICE]. (→ Page 98 "Remove the USB memory")

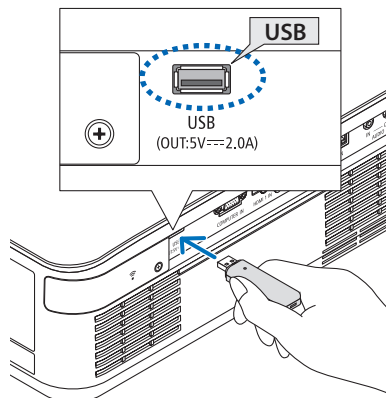

3. Press the INPUT button.

The [INPUT] screen is displayed.

- Press the SOURCE button when using the remote control.

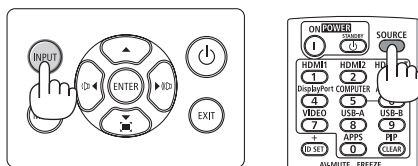

4. Press the INPUT button a few times and move the cursor to [USB-A].

- Every time the INPUT button is pressed briefly, the cursor moves to the next input terminal.
- Move the cursor to [USB-A] and wait for a while for the [VIEWER] to start and the [DRIVE LIST] screen on the USB memory to be projected.



5. Check that the cursor is moved to [USB 1] and press the ENTER button.

The file list screen will be displayed.



6. Move the cursor to the folder or image file with the ▲▼◀▶ buttons and press the ENTER button.

- When a folder is selected, the file list screen for the folder is displayed.
- If an image file is selected, the slide screen will be displayed.



7. Move the cursor to the image file in the file list screen, then press the ENTER button.

The slide screen will be displayed.



8. Press the ► button.

The next image will be projected.



9. Press the ◀ button.

The previous image will be projected.

10. Press the MENU button.

The control bar will be displayed.

- Press the MENU button while the control bar is being displayed to display the [INPUT] screen. When you press the MENU button again, the [INPUT] screen disappears.
- When you press the EXIT button while the control bar is being displayed, the control bar disappears.



11. Press the ► button to move the cursor to , then press the ENTER button.

The picture will rotate clockwise by 90°.

- Every time you press the ENTER button in this state, the picture rotates 90° clockwise.

12. Press the ► button to move the cursor to , then press the ENTER button.

The control bar disappears.

13. Press the EXIT button.

The display changes to the file list screen.

- You can also move the cursor to  with the control bar of the step 10 and press the ENTER button to change the file list screen.
- To return to the slide screen from the file list screen, move the cursor to the picture to be displayed in the slideshow and press the ENTER button.



② Remove the USB memory

1. Press the MENU button in the file list screen.

A pop-up menu will be displayed at the bottom left of the screen.

- Press the MENU button while the pop-up menu is being displayed to display the [INPUT] screen. When you press the MENU button again, the [INPUT] screen disappears.
- When you press the EXIT button while the pop-up menu is being displayed, the pop-up menu disappears.

2. Move the cursor to [REMOVE USB DEVICE] and press the ENTER button.

A confirmation message will be displayed in the center of the screen.

3. To remove the USB memory, press the ◀ button to move the cursor to [OK] and press the ENTER button.

The message displayed in the center of the screen changes.

4. Press the ENTER button.

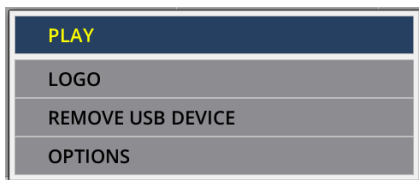

5. Remove the USB memory from the projector.

NOTE:

- If you remove a USB memory from the projector without executing [REMOVE USB DEVICE] in the menu, the operation of the unit may become unstable. In that case, turn off the power of the unit once and unplug the power cord from the outlet.

Subsequently, wait for about 3 minutes before connecting the power cord to the socket and turning on the power of the unit.

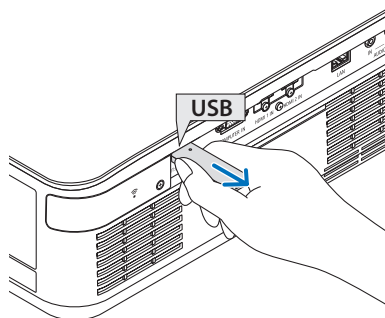

③ End the [VIEWER]

1. Press the MENU button in the slide screen or file list screen.

A control bar or a pop-up menu will be displayed.



2. Press the MENU button again.

The [INPUT] screen is displayed.

3. Move the cursor to an input terminal other than [USB-A] and press the ENTER button.

The [VIEWER] will end.

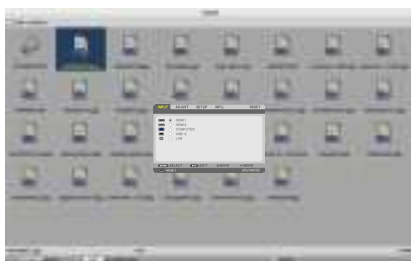

TIP:

- When using the remote controller, press the HDMI1 button etc. to end the [VIEWER].

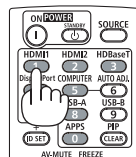

6-3. Slide screen operations

The following operations can be performed on the slide screen.



Button name	Description
▶, PAGE ▾	Project the next picture.
◀, PAGE △	Project the previous picture.
ENTER	Display the pointer (→). The pointer moves when you press the ▼▲◀▶ button. If you press the ENTER button again, the pointer disappears.
EXIT	Switch to the file list screen.
MENU	Display the control bar.

On the control bar, press the ◀ / ▶ button to move the yellow cursor and press the ENTER button at the desired item. The function of each item is as follows.

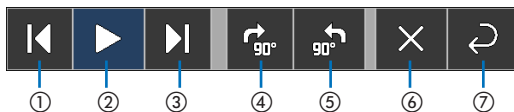

Items on the control bar	Description
① Back	Project the previous picture.
② Play / Stop	Start automatic playback of the slideshow. Or stop the slide show.
③ Next	Project the next picture.
④ Rotate 90° to the right	Rotate the picture clockwise by 90°.
⑤ Rotate 90° to the left	Rotate the picture counter-clockwise by 90°.
⑥ End	Turn off the control bar.
⑦ Return to the file list screen	Switch to the thumbnail screen.

6-4. File list screen operations

How to view the file list screen

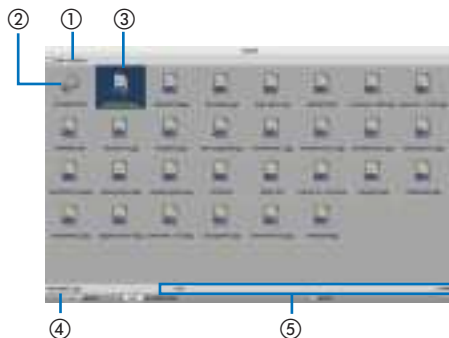

Display name	Description
①Path	Display the path of the projected folder. When a USB memory is inserted, the drive name is displayed as [USB].
②To the upper level	Return to the folder at the upper (parent) level.
③Picture or folder (icon display or) thumbnail display	Display pictures and folders as icons or thumbnails (zoom out).
④File name of the selected picture	Display the file name of the picture corresponding to the cursor.
⑤Information display	<ul style="list-style-type: none"> • When the cursor is on a picture, the order of the picture (the number out of all the pictures), the latest date and time the picture was updated, and the file size are displayed. • When the cursor is on a folder, the update date and time of the folder is displayed. • When the cursor is on a drive, the free space of the drive is displayed.

File list screen operations

Button name	Description
▼▲◀▶	Move the cursor.
ENTER	<ul style="list-style-type: none"> If the cursor is on a picture, the display switches to the slide screen. If the cursor is on a folder, the files in the folder are displayed. If the cursor is on [UP DIRECTORY], the display returns to the folder in the upper (parent) level.
EXIT	Return to the folder at the upper (parent) level.
MENU	Display the following pop-up menu.
PAGE ▾	Display the next file list screen.
PAGE △	Display the previous file list screen.

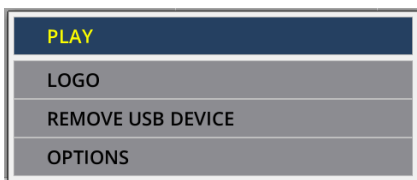

Menu item	Description
PLAY	Start the slideshow.
LOGO	Change the screen of the input terminal in a signal-less state (background logo) or the background image of the MultiPresenter start-up screen (MultiPresenter logo).
REMOVE USB DEVICE	Disable the use of the USB memory inserted in the projector. Execute this menu item before removing the USB memory from the projector.
OPTIONS	Display the option menu. (→ next page)

6-5. Option menu

Menu item	Description	When shipped from the factory
PLAY MODE	Select the display mode of the slide screen. MANUAL: Switch the picture manually. AUTOMATIC: Switch the picture automatically according to the interval setting.	MANUAL
INTERVAL	Set the display interval when playing a slideshow automatically. Selectable range: Set the interval from 5–300 (seconds) by 1 second increment.	5 (seconds)
REPEAT	Repeat the slideshow. <ul style="list-style-type: none"> • OFF: Do not repeat. End the slideshow after the last picture is displayed. • ON: Repeat. Return to the first picture after the last picture is displayed. 	OFF
START	Set the screen to be displayed when the USB-A terminal is selected. <ul style="list-style-type: none"> • SLIDE: Display the slide screen. • THUMBNAILS: Display the list screen. 	SLIDE
THUMBNAILS	Set whether to display the thumbnails of picture files displayed in the file list screen. <ul style="list-style-type: none"> • OFF: Display as icons. • ON: Display as thumbnails. <p>Example</p> 	OFF
SORT	Set the sort order when the file list is displayed. <ul style="list-style-type: none"> • NAME (ABC.)/NAME (ZYX.): Display in the order of the character codes of the files and folder names. • EXT. (ABC.)/EXT. (ZYX.): Display in the order of the character codes of the extensions. • DATE (NEW)/DATE (OLD): Display the file update date/time in ascending or descending order. • SIZE (BIG)/SIZE (SMALL): Display in ascending or descending order of file size. 	NAME (ABC.)

TIP:

• About “Save Setting”

Save each setting immediately after pressing the Confirm button. However, the value set in [SORT] is maintained until the power is turned off, returning to [NAME (ABC.)] the next time the power is turned on.

6-6. Changing the logo data (background image)

- You can change the screen of the input terminal in a signal-less state (background logo) or the background image of the MultiPresenter start-up screen (MultiPresenter logo).
- You can also set a password to prohibit third parties from changing the pictures.
- You can set pictures that satisfy all of the following conditions.

Format	JPEG or PNG pictures that can be displayed with the [VIEWER]
Resolution	Below the panel resolution of the projector PE455UL: WUXGA (1920 × 1200) PE455WL: WXGA (1280 × 800) PE505XL: XGA (1024 × 768)
File size	1 megabyte or less

1. **Display the file list screen.**
2. **Move the cursor to the picture to set in the background logo or the MultiPresenter logo and press the MENU button.**

The pop-up menu will be displayed.

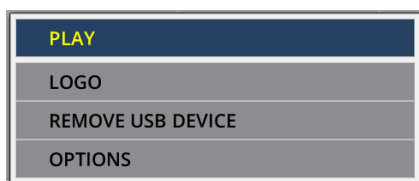

3. **Move the cursor to [LOGO] and press the ENTER button.**

The sub-menu will be displayed.



① Setting the background logo or MultiPresenter logo

1. **Move the cursor to [SET TO BACKGROUND LOGO] or [SET TO MultiPresenter LOGO] in the sub-menu and press the ENTER button.**
 - If a [LOGO PASSWORD] has been set, enter the [LOGO PASSWORD] when the [LOGO PASSWORD] input screen appears.
 - A screen to confirm whether to change the logo or not is displayed.
2. **Move the cursor to [YES] and press the ENTER button.**

② Initializing the background logo or MultiPresenter logo

1. **Move the cursor to [RESET BACKGROUND LOGO] or [RESET MultiPresenter LOGO] and press the ENTER button.**
 - If a [LOGO PASSWORD] has been set, enter the [LOGO PASSWORD] when the [LOGO PASSWORD] input screen appears.
 - A screen to confirm whether to initialize the logo or not is displayed.
2. **Move the cursor to [YES] and press the ENTER button.**

③ Set a password so that the logo will not be changed without authorization

This section explains the procedure for setting the password for the first time.

1. Move the cursor to [LOGO PASSWORD] in the sub-menu and press the ENTER button.

The [PASSWORD SETTINGS] screen is displayed.

2. Move the cursor to [NEW PASSWORD] and press the ENTER button.

- The character input screen will be displayed. Enter the password using the ▲▼◀▶ buttons and press the ENTER button.
- Only 1–10 alphanumeric characters are allowed to be used in the password.
- When the password is entered, it will be indicated by asterisks in the entry field.

3. Move the cursor to [CONFIRM NEW PASSWORD] and press the ENTER button.

- Enter the same password again.

4. Move the cursor to [OK] on the password setting screen and press the ENTER button.

The [LOGO PASSWORD] will be set.

TIP:

- How to erase the set [LOGO PASSWORD]
 - ① Move the cursor to [LOGO PASSWORD] in the sub-menu and press the ENTER button.
 - ② Press the ENTER button in the [ENTER PASSWORD] screen.
 - ③ Enter the password, move the cursor to [OK] and press the ENTER button.
The [PASSWORD SETTINGS] screen will be displayed.
 - ④ Move the cursor to [NEW PASSWORD] and press the ENTER button.
 - Move the cursor to [OK] without entering anything in the character input screen and press the ENTER button.
 - ⑤ Move the cursor to [CONFIRM NEW PASSWORD] and press the ENTER button.
 - Move the cursor to [OK] without entering anything in the character input screen and press the ENTER button.
 - ⑥ Move the cursor to [OK] in the password setting screen and press the ENTER button.
The set [LOGO PASSWORD] will now be deleted.
-

7. Connecting to a Network

7-1. Things you can do by connecting the projector to a network

- You can send screen images via a wired LAN/wireless LAN from a terminal installed with our MultiPresenter app to the projector and project them onto a screen.

See our company's website for more details about MultiPresenter.

<https://www.nec-display.com/dl/en/soft/multipresenter/index.html>

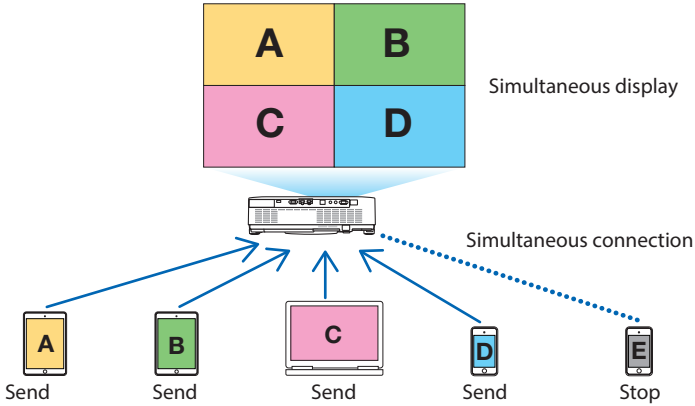

- When connecting the projector using a wireless LAN, you can set the following 3 profiles under the [NETWORK SETTINGS] in the menu.

Profile name	Description
INTELLIGENT CONNECTION	Easily connect computers or tablet terminals installed with MultiPresenter to the projector in a peer-to-peer connection.
INFRASTRUCTURE	Connect the projector to an existing access point and connect computers or tablet terminals installed with MultiPresenter to the projector.
SIMPLE ACCESS POINT	Turn the projector into the [SIMPLE ACCESS POINT] to connect computers or tablet terminals installed with MultiPresenter to the projector.

- Multiple computers or tablet terminals can be connected at the same time. A maximum of 16 units can be connected in the [FREE] mode and a maximum of 50 units can be connected in the [MANAGED] mode.
- Using the web browser of a computer and tablet terminal connected to a wired LAN/wireless LAN, you can connect to the projector's HTTP server to control the projector or configure the [NETWORK SETTINGS].
- By configuring the network service settings of the projector, AMX beacon, HTTP server logon password, PJLink, ALERT MAIL, CRESTRON, etc., can be used.

7-2. Connecting to MultiPresenter

Preparations:

- When connecting the projector to a wired LAN, connect a LANcable to the unit. (→ page 88)
- When connecting the projector to a wireless LAN, install a separately-sold LAN unit in the unit. (→ page 90)
- Configure the [NETWORK SETTINGS] of the projector. (→ page 109)
- Install the MultiPresenter app in the computer or tablet terminal.

<https://www.nec-display.com/dl/en/soft/multipresenter/index.html>

The procedure is described here for each wireless LAN profile [INTELLIGENT CONNECTION], [INFRASTRUCTURE], and [SIMPLE ACCESS POINT].

① When connecting with an [INTELLIGENT CONNECTION]

- 1. Turn on the power of the projector and press the APPS button on the remote controller.**

The start-up screen of MultiPresenter is displayed.

- 2. Start MultiPresenter.**

The target device screen is displayed.

- 3. Enter the 4-digit PIN code displayed in the start-up screen in the target device screen.**

When connection with the projector is completed, the screen of the computer or tablet terminal is projected on the screen.



② When connecting with [INFRASTRUCTURE]

- 1. Turn on the power of the projector and press the APPS button on the remote controller.**
The start-up screen of MultiPresenter is displayed.
- 2. Connect the projector and your computer or tablet terminal to the same network.**

NOTE:

- Check with the network administrator for the “connection information” of the network to be connected.
-

3. Start MultiPresenter.

The target device screen is displayed.

- 4. Enter the 4-digit PIN code displayed in the start-up screen in the target device screen.**
When connection with the projector is completed, the screen of the computer or tablet terminal is projected on the screen.

③ When connecting with a [SIMPLE ACCESS POINT]

- 1. Turn on the power of the projector and press the APPS button on the remote controller.**
The start-up screen of MultiPresenter is displayed.
- 2. Connect your computer or tablet terminal to the access point matching the “SSID” displayed in the start-up screen.**

3. Start MultiPresenter.

The target device screen is displayed.

- 4. Enter the 4-digit PIN code displayed in the start-up screen in the target device screen.**
When connection with the projector is completed, the screen of the computer or tablet terminal is projected on the screen.

7-3. NETWORK SETTINGS

Move the cursor to [ NETWORK SETTINGS] at the bottom right of the start-up screen and press the ENTER button to display the [NETWORK SETTINGS] screen.

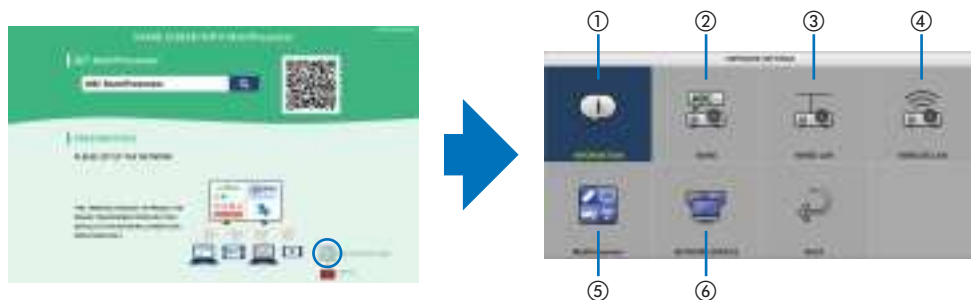

① INFORMATION

Displays information regarding the wired LAN and wireless LAN of the projector.

- To return to the [NETWORK SETTINGS] screen, press the EXIT button.

② NAME

Sets the [PROJECTOR NAME] and [HOST NAME].

Item name	Description
PROJECTOR NAME	Set the [PROJECTOR NAME]. <ul style="list-style-type: none"> • Initial value: "PJ-XXXXXXXXXX" The initial value "PJ-XXXXXXXXXX" represents the "PJ-" + "Serial Number". • Allowable characters: Alphanumeric symbols (including space) • Number of characters: 1–16 characters
HOST NAME	Set the [HOST NAME]. <ul style="list-style-type: none"> • Initial value: "pj-XXXXXXXXXX" The initial value "pj-XXXXXXXXXX" represents the "pj-" + "Serial Number". • Allowable characters: Alphanumeric, "-" <hr/> NOTE: <ul style="list-style-type: none"> • You can not enter "-" at the beginning or end of the [HOST NAME]. <hr/> <ul style="list-style-type: none"> • Number of characters: 1–16 characters

③ WIRED LAN

Configure the profile of the wired LAN, DHCP, IP address, subnet mask, gateway, DNS and so on.

- When using a wired LAN, set the profile to [ENABLE] and configure the necessary settings.
- If you are not using a wired LAN, set the profile to [DISABLE].
- Once you have configured the settings, move the cursor to [OK] and press the ENTER button.

④ WIRELESS LAN

Configure the wireless LAN settings.

Item name	Description
PROFILE	<p>There are 4 wireless LAN profiles as shown below.</p> <ul style="list-style-type: none"> • DISABLE (initial value) • INTELLIGENT CONNECTION • SIMPLE ACCESS POINT • INFRASTRUCTURE <p>The settings of profiles are different from each other. This will be explained later.</p>

[DISABLE]

Disable the [WIRELESS LAN] of the projector.

[INTELLIGENT CONNECTION]

Compared to connecting with [INFRASTRUCTURE] or the [SIMPLE ACCESS POINT], it is easier to connect computers or tablet terminals installed with MultiPresenter to the projector.

Item name	Description
PROFILE	INTELLIGENT CONNECTION
MODE	<p>Select the wireless mode (IEEE802.11b/g/n or IEEE802.11a/n).</p> <ul style="list-style-type: none"> • Initial value: IEEE802.11b/g/n
CHANNEL	<p>Set the wireless channel.</p> <ul style="list-style-type: none"> • Initial value: AUTOMATIC
SECURITY TYPE	<p>Set the [SECURITY TYPE] ([DISABLE] or [WPA2-PSK]).</p> <ul style="list-style-type: none"> • Initial value: DISABLE <p>NOTE:</p> <ul style="list-style-type: none"> • When the [PIN TYPE] set in the MultiPresenter settings is a [ONE-TIME], the [SECURITY TYPE] cannot be specified as it will be applied automatically.
SECURITY KEY	<p>Set the encryption key.</p> <ul style="list-style-type: none"> • Initial value: Blank • Allowable characters: Alphanumeric symbols (including space) • Number of characters: 8–63 characters <p>When a [SECURITY KEY] is set, a number of asterisks "*" equivalent to the number of characters is displayed.</p> <p>NOTE:</p> <ul style="list-style-type: none"> • When the [PIN TYPE] set in the MultiPresenter settings is a [ONE-TIME], the [SECURITY KEY] cannot be set as it will be set automatically.

[SIMPLE ACCESS POINT]

Turn the projector into the [SIMPLE ACCESS POINT] to connect computers or tablet terminals installed with MultiPresenter to the projector.

Item name	Description
PROFILE	SIMPLE ACCESS POINT
MODE	Select the wireless mode (IEEE802.11b/g/n or IEEE802.11a/n). <ul style="list-style-type: none"> Initial value: IEEE802.11b/g/n
CHANNEL	Set the wireless channel. <ul style="list-style-type: none"> Initial value: AUTOMATIC
SSID	Set the SSID. <ul style="list-style-type: none"> Initial value: "AP-XXXXXXXXXX" The initial value "AP-XXXXXXXXXX" represents the "AP-" + "Serial Number". Allowable characters: Alphanumeric symbols (including space) Number of characters: 1–32 characters
SECURITY TYPE	Set the [SECURITY TYPE] ([DISABLE] or [WPA2-PSK]). <ul style="list-style-type: none"> Initial value: DISABLE
SECURITY KEY	Set the encryption key. <ul style="list-style-type: none"> Initial value: Blank Allowable characters: Alphanumeric symbols (including space) Number of characters: 8–63 When the character [SECURITY KEY] is set, a number of asterisks "*" equivalent to the number of characters is displayed.

[INFRASTRUCTURE]

Connect the projector to an existing access point.

Item name	Description
PROFILE	INFRASTRUCTURE
DHCP, IP ADDRESS, SUBNET MASK, GATEWAY, AUTO DNS, DNS ADDRESS	Set the [DHCP], [IP ADDRESS], [SUBNET MASK], [GATEWAY], [AUTO DNS], and [DNS ADDRESS].
SITE SURVEY	Perform a site survey to search for access points. The [SSID] and [SECURITY TYPE] are set according to the selected access point.
SSID	Set the SSID. <ul style="list-style-type: none"> Initial value: NECPJ Allowable characters: Alphanumeric symbols (including space) Number of characters: 1–32 characters
SECURITY TYPE	Set the [SECURITY TYPE] ([DISABLE], [WPA2-PSK], or [WPA/WPA2-PSK]). <ul style="list-style-type: none"> Initial value: DISABLE
SECURITY KEY	Set the encryption key. <ul style="list-style-type: none"> Initial value: Blank Allowable characters: Alphanumeric symbols (including space) Number of characters: 8–63 characters When a [SECURITY KEY] is set, a number of asterisks "*" equivalent to the number of characters is displayed.

⑤ MultiPresenter

Set the MultiPresenter operation.

Item name	Description
MODE	<p>Select [FREE] mode or [MANAGED] mode.</p> <p>When you are in the [MANAGED] mode, you can change the split pattern of the screen by pressing the ENTER button on the remote controller of the projector while projecting the MultiPresenter screen.</p> <ul style="list-style-type: none"> Initial value: FREE <hr/> <p>NOTE:</p> <ul style="list-style-type: none"> The [MODE] setting is applied when all connections are cut off.
PIN TYPE	<p>Select [ONE-TIME] or [STATIC].</p> <ul style="list-style-type: none"> Initial value: ONE-TIME A [ONE-TIME] PIN code will be generated automatically, so the [PIN CODE] cannot be entered for the next item. For [STATIC], enter an arbitrary PIN code.
PIN CODE	<p>Enter a PIN code for [STATIC].</p> <ul style="list-style-type: none"> Initial value: 4-digit random number Allowable characters: Numeral Number of characters: 4 characters (0000–9999)
UTILIZE PIN CODE AS CONNECTION PASSWORD	<p>Select not to use the PIN code as a password ([OFF]), or to use the PIN code as a password ([ON]).</p> <ul style="list-style-type: none"> Initial value: ON
COMMUNICATION SPEED LIMIT	<p>Set the upper limit of the communication speed that MultiPresenter uses for transmission.</p> <ul style="list-style-type: none"> Initial value: DISABLE
START-UP SCREEN	
GET APPS GUIDE	<p>Select whether or not to display the [GET MultiPresenter] display on the start-up screen.</p> <ul style="list-style-type: none"> Initial value: ON (display)
STEP TO CONNECT	<p>Select whether or not to display the connection procedure on the start-up screen.</p> <ul style="list-style-type: none"> Initial value: ON (display)
CONNECTION INFORMATION	<p>Select whether or not to display the connection information on the start-up screen.</p> <ul style="list-style-type: none"> Initial value: ON (display)
MultiPresenter SCREEN	
CONNECTION INFORMATION	<p>Select whether or not to display the connection information in the screen when MultiPresenter is connected.</p> <ul style="list-style-type: none"> Initial value: ON (display)

⑥ NETWORK SERVICE

Configure the [AMX BEACON], [HTTP SERVER], [PJLink], [ALERT MAIL], [CRESTRON] and other settings.

Item name	Description	
AMX BEACON	Select whether or not to transmit AMX beacons. • Initial value: OFF (do not transmit)	
HTTP SERVER	Set the password to log into the projector's HTTP server. • Initial value: Blank • Allowable characters: Alphanumeric symbols • Number of characters: 0–10 characters When a password is set, a number of asterisks "*" equivalent to the number of characters is displayed.	
PJLink	Set the PJLink password.	
	PASSWORD SETTINGS	Set the PJLink password. • Initial value: Blank • Allowable characters: Alphanumeric characters • Number of characters: 0–32 characters When a password is set, a number of asterisks "*" equivalent to the number of characters is displayed.
ALERT MAIL	Set alert mail and perform a transmission test.	
	ALERT MAIL	Select whether or not to send an alert mail when an alert target event occurs in the projector. • Initial value: OFF (do not transmit)
	SENDER'S ADDRESS	Set the sender's address when sending E-mail from the projector. • Initial value: Blank • Allowable characters: Alphanumeric characters, symbols • Number of characters: 0–60 characters
	SMTP SERVER NAME	Set the SMTP server of the network to connect to the projector. • Initial value: Blank • Allowable characters: Alphanumeric characters, symbols • Number of characters: 0–60 characters
	RECIPIENT'S ADDRESS 1/2/3	Set the destination address to send E-mail from the projector (maximum 3). • Initial value: Blank • Allowable characters: Alphanumeric characters, symbols • Number of characters: 0–60 characters
	TEST MAIL	Send a test mail according to the settings.

Item name	Description	
CRESTRON	Set the CRESTRON function.	
	Crestron Room View	
	Crestron Room View	Select whether to use Crestron Room View or not. <ul style="list-style-type: none"> • Initial value: OFF (do not use)
	Crestron Control	
	Crestron Control	Select whether to use Crestron Control or not. <ul style="list-style-type: none"> • Initial value: OFF (do not use)
	IP ADDRESS	Set the Crestron Control's IP address. <ul style="list-style-type: none"> • Initial value: 192.168.0.100 • Allowable characters: Alphanumeric, period • Number of characters: 7–15 characters
IP ID	Set the Crestron Control's IP ID. <ul style="list-style-type: none"> • Initial value: 5 • Allowable characters: Alphanumeric • Input character range: 3–65535 • Number of characters: 1–5 characters 	

7-4. HTTP server function

Overview

The HTTP Server function provides settings and operations for:

- Setting for wired/wireless network (NETWORK SETTINGS)
To use wireless LAN connection, the optional USB Wireless LAN Unit is required. (→ page 90)
To use wired/wireless LAN connection, connect the projector to the computer with a commercially available LAN cable. (→ page 88)
- Setting Alert Mail (ALERT MAIL)
When the projector is connected to a wired/wireless network, the light source usage time or error messages will be sent via e-mail.
- Operating the projector
Power on/off, selecting input, volume control and picture adjustments are possible.
- Configure the [AMX BEACON], [HTTP SERVER], [PJLink], [ALERT MAIL], [CRESTRON] and other settings.

How to access to the HTTP server:

- **Start the Web browser on the computer via the network connected to the projector and enter the following URL :**
http://<the projector's IP address>/index.html

TIP:

- The factory setting IP address is [DHCP: ON].
-

NOTE:

- To use the projector in a network, consult with your network administrator about network settings.
 - The display's or button's response can be slowed down or operation may not be accepted depending the settings of your network. Should this happen, consult your network administrator. The projector may not respond if its buttons are repeatedly pressed in rapid intervals. Should this happen, wait a moment and repeat. If you still can't get any response, turn off and back on the projector.
 - If the [NETWORK SETTINGS] screen does not appear in the web browser, press the Ctrl+F5 keys to refresh your web browser (or clear the cache).
 - This device uses "JavaScript" and "Cookies" and the browser should be set to accept these functions. The setting method will vary depending on the version of browser. Please refer to the help files and the other information provided in your software.
-

Preparation before Use

Connect the projector to a commercially available LAN cable before engaging in browser operations. (→ page 88)

Operation with a browser that uses a proxy server may not be possible depending on the type of proxy server and the setting method. Although the type of proxy server will be a factor, it is possible that items that have actually been set will not be displayed depending on the effectiveness of the cache, and the contents set from the browser may not be reflected in operation. It is recommended that a proxy server not be used unless it is unavoidable.

Handling of the Address for Operation via a Browser

Regarding the actual address that is entered for the address or entered to the URL column when operation of the projector is via a browser, the host name can be used as it is when the host name corresponding to the IP address of the projector has been registered to the domain name server by a network administrator, or the host name corresponding to the IP address of the projector has been set in the "HOSTS" file of the computer being used.

Example 1: When the host name of the projector has been set to "pj.nec.co.jp", access is gained to the network setting by specifying

<http://pj.nec.co.jp/index.html>

for the address or the entry column of the URL.

Example 2: When the IP address of the projector is "192.168.73.1", access is gained to the network setting by specifying

<http://192.168.73.1/index.html>

for the address or the entry column of the URL.

PROJECTOR ADJUSTMENT

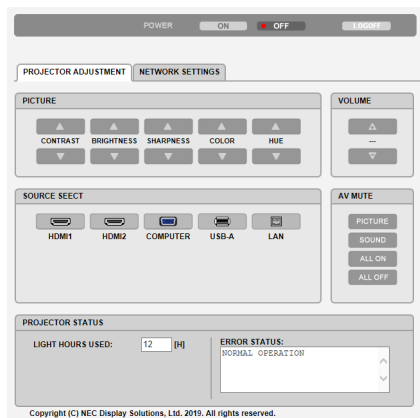

POWER	This controls the power of the projector.	
	ON	Power is switched on.
VOLUME	OFF	Power is switched off.
	This controls the volume of the projector.	
	▲	Increases the volume adjustment value.
AV-MUTE	▼	Decreases the volume adjustment value.
	This controls the mute function of the projector.	
	PICTURE ON	Mutes the video.
	PICTURE OFF	Cancels the video muting.
	SOUND ON	Mutes the audio.
	SOUND OFF	Cancels the audio muting.
	ALL ON	Mutes each of the video, and audio functions.
ALL OFF	Cancels the muting of each of the video, and audio functions.	

PICTURE	Controls the video adjustment of the projector.	
	CONTRAST ▲	Increases the contrast adjustment value.
	CONTRAST ▼	Decreases the contrast adjustment value.
	BRIGHTNESS ▲	Increases the brightness adjustment value.
	BRIGHTNESS ▼	Decreases the brightness adjustment value.
	SHARPNESS ▲	Increases the sharpness adjustment value.
	SHARPNESS ▼	Decreases the sharpness adjustment value.
	COLOR ▲	Increases the color adjustment value.
	COLOR ▼	Decreases the color adjustment value.
	HUE ▲	Increases the hue adjustment value.
	HUE ▼	Decreases the hue adjustment value.
<ul style="list-style-type: none"> The functions that can be controlled will vary depending on the signal being input to the projector. (→ page 58) 		
SOURCE SELECT	This switches the input terminal of the projector.	
	HDMI1	Switches to the HDMI 1 IN terminal
	HDMI2	Switches to the HDMI 2 IN terminal.
	COMPUTER	Switches to the COMPUTER IN terminal.
	USB-A	Switches to the data on the USB memory device.
	LAN	Switches to a LAN signal.
PROJECTOR STATUS	This displays the condition of the projector.	
	LIGHT HOURS USED	Displays how many hours the light module has been used.
	ERROR STATUS	Displays the status of errors occurring within the projector.
LOG OFF	Logging off your projector and returning to the authentication screen (LOGON screen).	

NETWORK SETTINGS

For details on each of the [NETWORK SETTINGS], see “7-3. NETWORK SETTINGS” (→ page 109).

POWER ON OFF

PROJECTOR ADJUSTMENT NETWORK SETTINGS

SETTINGS NAME ALERT MAIL NETWORK SERVICE CRESTRON INFORMATION

PIN

PIN TYPE : ONE-TIME

PIN CODE : 3293

UTILIZE PIN CODE AS PASSWORD FOR CONNECTING WITH MultiPresenter.

WIRED LAN

DISABLE

ENABLE

WIRELESS LAN

DISABLE

INFRASTRUCTURE

SIMPLE ACCESS POINT

INTELLIGENT CONNECTION

Copyright (C) NEC Display Solutions, Ltd. 2019. All rights reserved.

8. Maintenance

8-1. Cleaning the Lens

- Turn off the projector before cleaning.
- The projector has a plastic lens. Use a commercially available plastic lens cleaner.
- Do not scratch or mar the lens surface as a plastic lens is easily scratched.
- Never use alcohol or glass lens cleaner as doing so will cause damage to the plastic lens surface.

 **WARNING**

- Do not use a spray containing flammable gas to remove dust attached to the lens, etc. Doing so may result in fire.

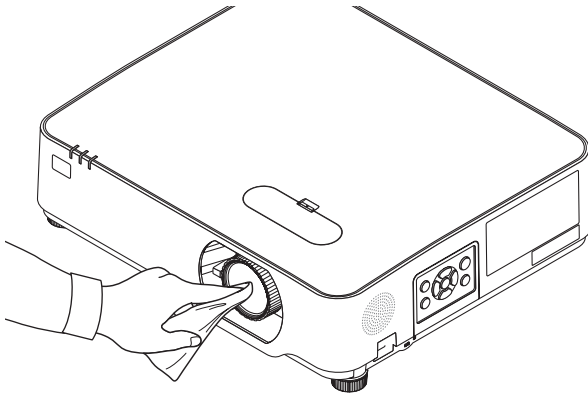

8-2. Cleaning the Cabinet

Turn off the projector, and unplug the projector before cleaning.

- Use a dry soft cloth to wipe dust off the cabinet.
If heavily soiled, use a mild detergent.
- Never use strong detergents or solvents such as alcohol or thinner.
- When cleaning the ventilation slits or the speaker using a vacuum cleaner, do not force the brush of the vacuum cleaner into the slits of the cabinet.

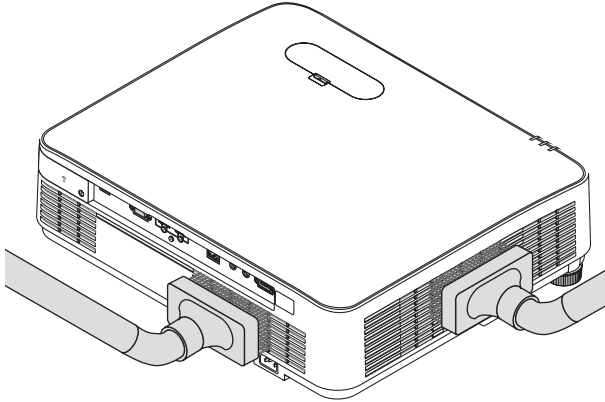

Vacuum the dust off the ventilation slits or the speaker.

- Poor ventilation caused by dust accumulation in ventilation openings can result in overheating and malfunction. These areas should be cleaned regularly.
- Do not scratch or hit the cabinet with your fingers or any hard objects
- Contact your dealer for cleaning the inside of the projector.

NOTE:

- Do not apply volatile agent such as insecticide on the cabinet, the lens, or the screen. Do not leave a rubber or vinyl product in prolonged contact with it. Otherwise the surface finish will be deteriorated or the coating may be stripped off.
-

9. Appendix

9-1. Setting Up the Screen and the Projector

Use this to get a general idea of what the screen size will be when set in a certain position, what size screen you will need, and what distance you will need to project images of the desired size.

[PE455UL]

The projection distance range at which focusing is possible is 0.78 m to 12.89 m. Install within this range.

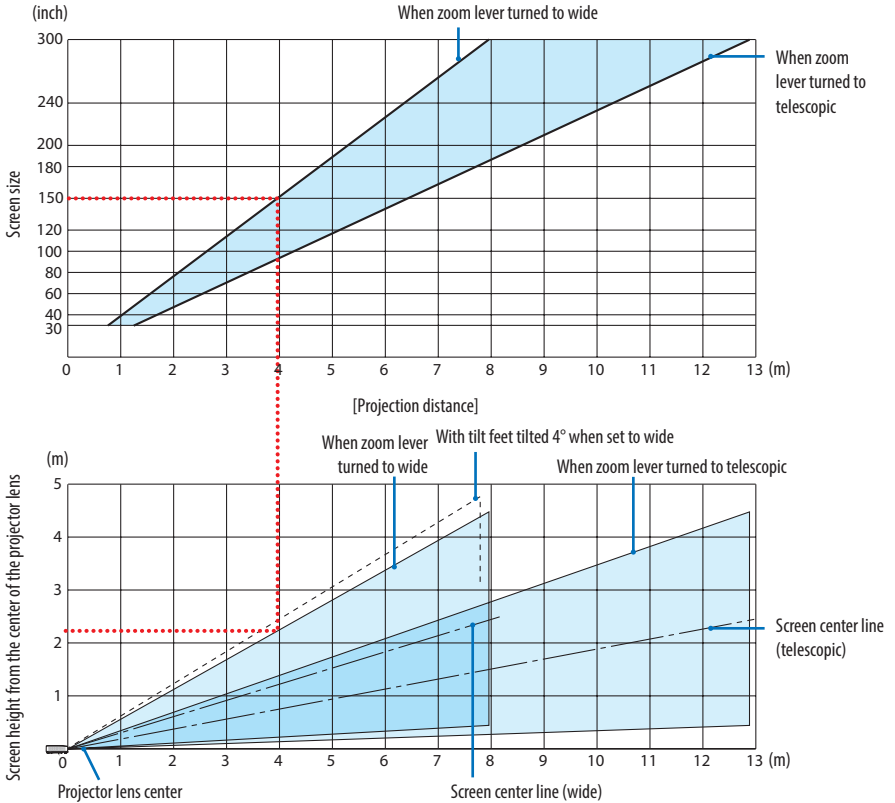

* The figures indicated for “height of screen from projector lens center” on the projection distance table are for a lens shift of 60% V.

Reading the Table

From the upper table on this page, to project wide images on a 150 screen, install at about 4.0 m from the front.

Also, from the lower table we can see that about 2.2 m are required from the projector’s lens center to the upper edge of the screen. Use this to see whether or not enough height can be provided from the projector to the ceiling and for installing the screen. The diagram shows the projection distance when the projector is installed horizontally. The projected image can be moved up and down, left and right using the lens shift function. (→ page 23)

[PE455WL]

The projection distance range at which focusing is possible is 0.78 m to 13.55 m. Install within this range.

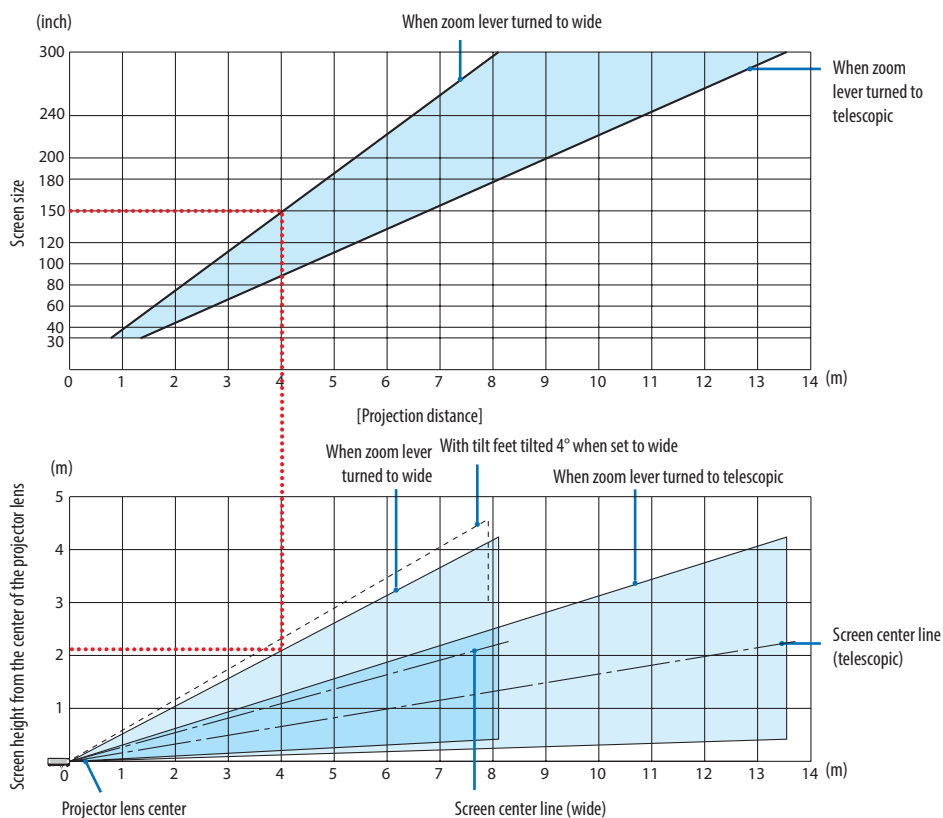

* The figures indicated for "height of screen from projector lens center" on the projection distance table are for a lens shift of 55% V.

Reading the Table

From the upper table on this page, to project wide images on a 150 screen, install at about 4.0 m from the front.

Also, from the lower table we can see that about 2.1 m are required from the projector's lens center to the upper edge of the screen. Use this to see whether or not enough height can be provided from the projector to the ceiling and for installing the screen. The diagram shows the projection distance when the projector is installed horizontally. The projected image can be moved up and down, left and right using the lens shift function. (→ page 23)

[PE505XL]

The projection distance range at which focusing is possible is 0.80 m to 13.81 m. Install within this range.

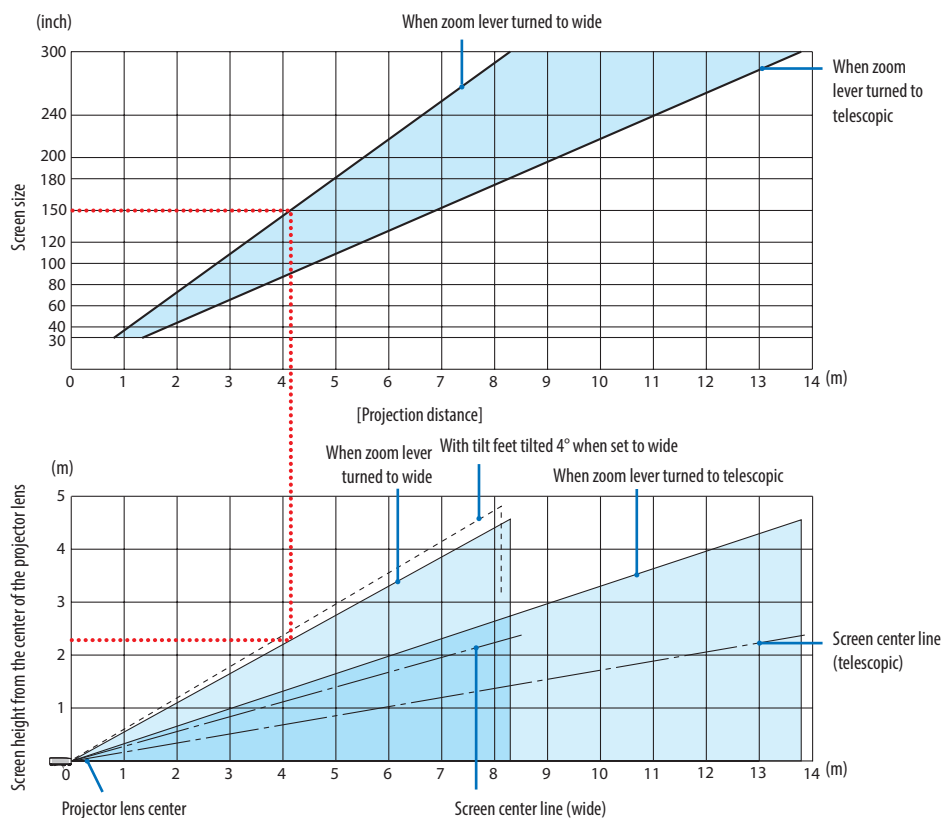

* The figures indicated for "height of screen from projector lens center" on the projection distance table are for a lens shift of 50% V.

Reading the Table

From the upper table on this page, to project wide images on a 150 screen, install at about 4.1 m from the front.

Also, from the lower table we can see that about 2.3 m are required from the projector's lens center to the upper edge of the screen. Use this to see whether or not enough height can be provided from the projector to the ceiling and for installing the screen. The diagram shows the projection distance when the projector is installed horizontally. The projected image can be moved up and down, left and right using the lens shift function. (→ page 23)

Tables of screen sizes and dimensions

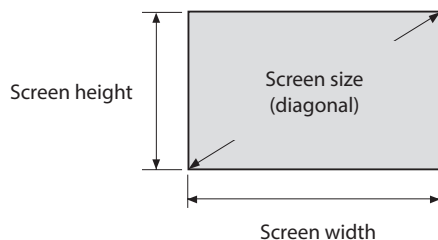

[PE455UL/PE455WL]

Size (inches)	Screen width		Screen height	
	(cm)	(inches)	(cm)	(inches)
30	64.6	25.4	40.4	15.9
40	86.2	33.9	53.8	21.2
50	107.7	42.4	67.3	26.5
60	129.2	50.9	80.8	31.8
80	172.3	67.8	107.7	42.4
100	215.4	84.8	134.6	53.0
120	258.5	101.8	161.5	63.6
150	323.1	127.2	201.9	79.5
200	430.8	169.6	269.2	106.0
250	538.5	212.0	336.5	132.5
300	646.2	254.4	403.9	159.0

[PE505XL]

Size (inches)	Screen width		Screen height	
	(cm)	(inches)	(cm)	(inches)
30	61.0	24.0	45.7	18.0
40	81.3	32.0	61.0	24.0
50	101.6	40.0	76.2	30.0
60	121.9	48.0	91.4	36.0
80	162.6	64.0	121.9	48.0
100	203.2	80.0	152.4	60.0
120	243.8	96.0	182.9	72.0
150	304.8	120.0	228.6	90.0
200	406.4	160.0	304.8	120.0
250	508.0	200.0	381.0	150.0
300	609.6	240.0	457.2	180.0

Example of installation on a desktop

The diagram below shows an example of when the projector is used on a desktop.
 Horizontal projection position: Equal distance to the left and right from the center of the lens
 Vertical projection position: (see table below)

[PE455UL]

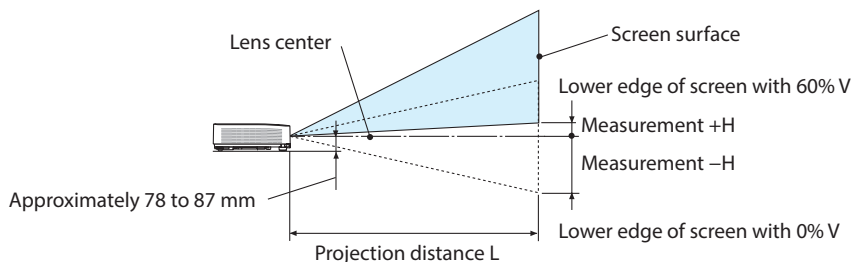

(NOTE) Height from lens center to lower edge of screen (with tilt feet screwed in)

Screen size (inches)	Throw distance L				Height H	
	(m)		(inches)		(cm)	(inches)
	Wide	Tele	Wide	Tele	0%V - 60%V	0%V - 60%V
30	0.77	1.26	30.1	49.5	-20.2 - +4.0	-7.9 - +1.6
40	1.03	1.69	40.6	66.5	-26.9 - +5.4	-10.6 - +2.1
60	1.56	2.55	61.6	100.4	-40.4 - +8.1	-15.9 - +3.2
80	2.10	3.41	82.6	134.3	-53.8 - +10.8	-21.2 - +4.2
90	2.36	3.84	93.1	151.3	-60.6 - +12.1	-23.8 - +4.8
100	2.63	4.27	103.6	168.2	-67.3 - +13.5	-26.5 - +5.3
120	3.16	5.13	124.6	202.1	-80.8 - +16.2	-31.8 - +6.4
150	3.96	6.43	156.1	253.0	-101.0 - +20.2	-39.7 - +7.9
180	4.76	7.72	187.6	303.8	-121.2 - +24.2	-47.7 - +9.5
200	5.30	8.58	208.6	337.8	-134.6 - +26.9	-53.0 - +10.6
250	6.36	10.30	250.5	405.6	-161.5 - +32.3	-63.6 - +12.7
270	7.16	11.59	282.0	456.4	-181.7 - +36.3	-71.5 - +14.3
300	7.96	12.89	313.5	507.3	-201.9 - +40.4	-79.5 - +15.9

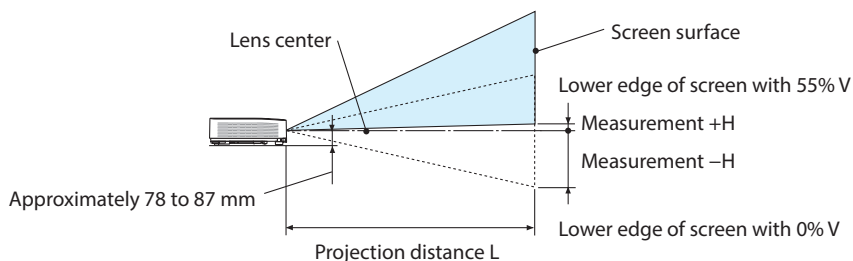
[PE455WL]

(NOTE) Height from lens center to lower edge of screen (with tilt feet screwed in)

Screen size (inches)	Throw distance L				Height H			
	(m)		(inches)		(cm)		(inches)	
	Wide	Tele	Wide	Tele	0%V - 55%V	0%V - 55%V	0%V - 55%V	0%V - 55%V
30	0.78	1.32	30.7	52.0	-20.2 - +2.0	-7.9 - +0.8		
40	1.05	1.77	41.4	69.8	-26.9 - +2.7	-10.6 - +1.1		
60	1.60	2.68	62.9	105.5	-40.4 - +4.0	-15.9 - +1.6		
80	2.14	3.59	84.4	141.1	-53.8 - +5.4	-21.2 - +2.1		
90	2.42	4.04	95.2	159.0	-60.6 - +6.1	-23.8 - +2.4		
100	2.69	4.49	105.9	176.8	-67.3 - +6.7	-26.5 - +2.6		
120	3.24	5.40	127.4	212.5	-80.8 - +8.1	-31.8 - +3.2		
150	4.06	6.76	159.6	266.0	-101.0 - +10.1	-39.7 - +4.0		
180	4.87	8.12	191.9	319.5	-121.2 - +12.1	-47.7 - +4.8		
200	5.42	9.02	213.4	355.2	-134.6 - +13.5	-53.0 - +5.3		
250	6.51	10.83	256.3	426.5	-161.5 - +16.2	-63.6 - +6.4		
270	7.33	12.19	288.6	480.0	-181.7 - +18.2	-71.5 - +7.2		
300	8.15	13.55	320.8	533.5	-201.9 - +20.2	-79.5 - +7.9		

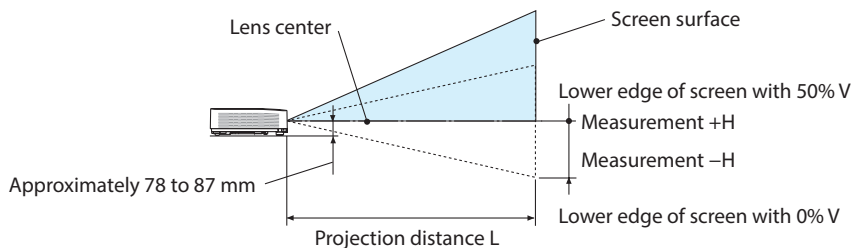
[PE505XL]

(NOTE) Height from lens center to lower edge of screen (with tilt feet screwed in)

Screen size (inches)	Throw distance L				Height H	
	(m)		(inches)		(cm)	(inches)
	Wide	Tele	Wide	Tele	0%V - 50%V	0%V - 50%V
30	0.79	1.35	31.3	53.0	-22.9 - +0	-9.0 - +0
40	1.07	1.81	42.2	71.1	-30.5 - +0	-12.0 - +0
60	1.63	2.73	64.1	107.5	-45.7 - +0	-18.0 - +0
80	2.19	3.65	86.0	143.8	-61.0 - +0	-24.0 - +0
90	2.46	4.12	97.0	162.0	-68.6 - +0	-27.0 - +0
100	2.74	4.58	107.9	180.2	-76.2 - +0	-30.0 - +0
120	3.30	5.50	129.8	216.5	-91.4 - +0	-36.0 - +0
150	4.13	6.89	162.7	271.0	-114.3 - +0	-45.0 - +0
180	4.97	8.27	195.5	325.6	-137.2 - +0	-54.0 - +0
200	5.52	9.19	217.4	361.9	-152.4 - +0	-60.0 - +0
250	6.63	11.04	261.2	434.6	-182.9 - +0	-72.0 - +0
270	7.47	12.42	294.0	489.1	-205.7 - +0	-81.0 - +0
300	8.30	13.81	326.9	543.6	-228.6 - +0	-90.0 - +0

Lens shifting range

This projector is equipped with a lens shift function (→ page 23) for adjusting the image position using dials. Lens shifting is possible within the range shown below.

NOTE:

- In case lens shifted volume exceeds the below illustrated range, blur and shade may appear around ends of projected image.

Legend: V "Vertical" refers to the screen height and H "Horizontal" refers to the screen width. The lens shift range is expressed as a ratio of height and width, respectively.

[PE455UL]

Lens shifting range:

Vertical direction: +60%, -0%

Horizontal direction: ±29%

DESKTOP FRONT, DESKTOP REAR

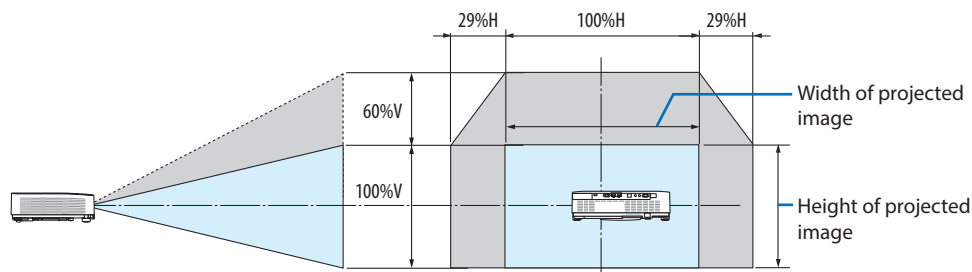

CEILING FRONT, CEILING REAR

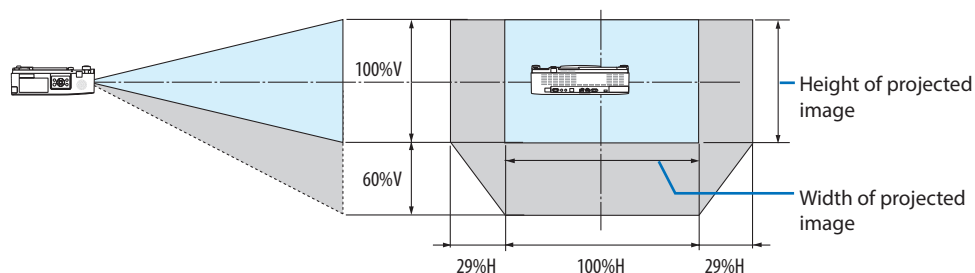

(Example) When using to project on a 150" screen

According to the "Table of screen sizes and dimensions" (→ page 124), $H = 127.2"/323.1 \text{ cm}$, $V = 79.5"/201.9 \text{ cm}$.

Adjustment range in the vertical direction: the projected image can be moved upwards $0.60 \times 79.5"/201.9 \text{ cm} \approx 47.7"/121 \text{ cm}$ (when the lens is at the center position).

Adjustment range in the horizontal direction: the projected image can be moved to the left $0.29 \times 127.2"/323.1 \text{ cm} \approx 36.9"/94 \text{ cm}$, to the right approximately $36.9"/94 \text{ cm}$.

* Figures differ by several % because the calculation is approximate.

[PE455WL]

Lens shifting range:

Vertical direction: +55%, -0%

Horizontal direction: $\pm 26\%$

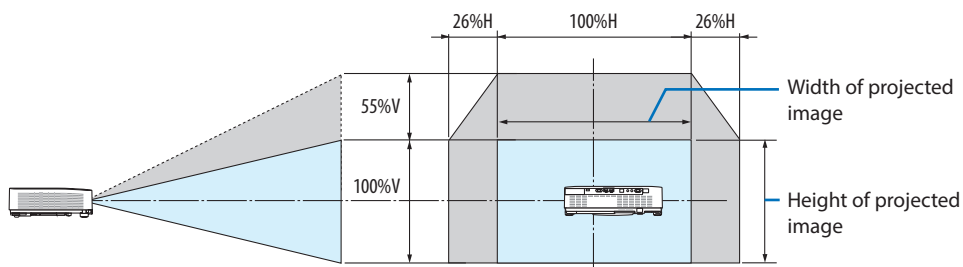
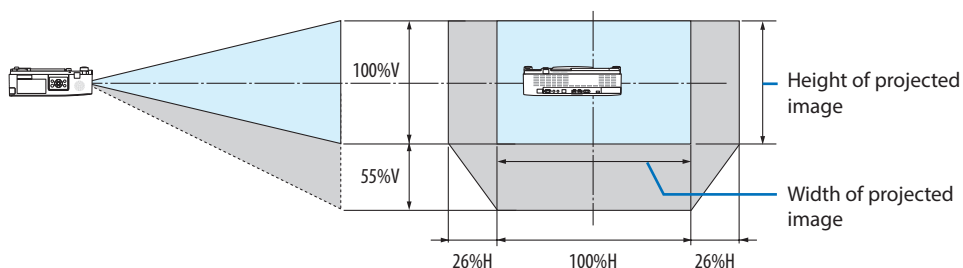
DESKTOP FRONT, DESKTOP REAR**CEILING FRONT, CEILING REAR**

(Example) When using to project on a 150" screen

According to the "Table of screen sizes and dimensions" (\rightarrow page 124), $H = 127.2''/323.1$ cm, $V = 79.5''/201.9$ cm.

Adjustment range in the vertical direction: the projected image can be moved upwards $0.55 \times 79.5''/201.9$ cm $\approx 43.7''/111$ cm (when the lens is at the center position).

Adjustment range in the horizontal direction: the projected image can be moved to the left $0.26 \times 127.2''/323.1$ cm $\approx 33.1''/84$ cm, to the right approximately $33.1''/84$ cm.

* Figures differ by several % because the calculation is approximate.

[PE505XL]

Lens shifting range:

Vertical direction: +50%, -0%

Horizontal direction: $\pm 28\%$

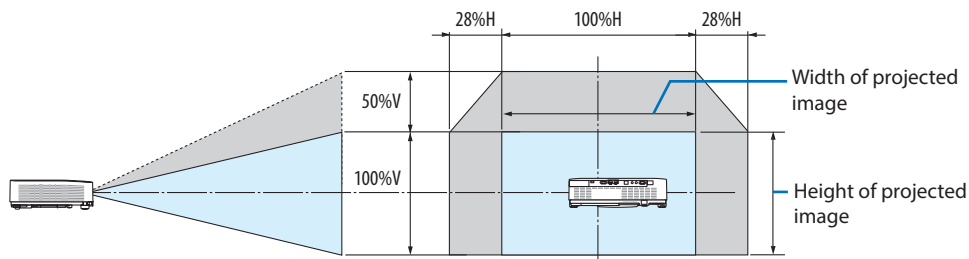
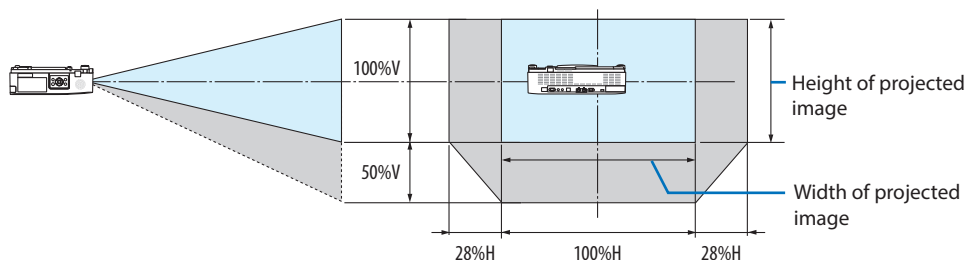
DESKTOP FRONT, DESKTOP REAR**CEILING FRONT, CEILING REAR**

(Example) When using to project on a 150" screen

According to the "Table of screen sizes and dimensions" (\rightarrow page 124), $H = 120.0''/304.8$ cm, $V = 90.0''/228.6$ cm.

Adjustment range in the vertical direction: the projected image can be moved upwards $0.50 \times 90.0''/228.6$ cm $\approx 45.0''/114$ cm (when the lens is at the center position).

Adjustment range in the horizontal direction: the projected image can be moved to the left $0.28 \times 120.0''/304.8$ cm $\approx 33.6''/85$ cm, to the right approximately $33.6''/85$ cm.

* Figures differ by several % because the calculation is approximate.

9-2. Compatible Input Signal List

Analog RGB

Signal	Resolution (dots)	Aspect Ratio	Refresh Rate (Hz)
VGA	640 × 480	4:3	60/72/75/85/iMac
SVGA	800 × 600	4:3	56/60/72/75/85/iMac
XGA	1024 × 768 ^{*1}	4:3	60/70/75/85/iMac
WXGA	1280 × 768 ^{*2}	15:9	60
	1280 × 800 ^{*2}	16:10	60
	1360 × 768 ^{*3}	16:9	60
	1366 × 768 ^{*3}	16:9	60
Quad-VGA	1280 × 960	4:3	60/75
SXGA	1280 × 1024	5:4	60/75
SXGA+	1400 × 1050	4:3	60
WXGA+	1440 × 900	16:10	60
WXGA++	1600 × 900 ^{*3}	16:9	60
UXGA	1600 × 1200 ^{*4}	4:3	60
WSXGA+	1680 × 1050	16:10	60
HD	1280 × 720	16:9	60
Full HD	1920 × 1080	16:9	60
WUXGA	1920 × 1200 ^{*5 *6}	16:10	60
MAC 13"	640 × 480	4:3	67
MAC 16"	832 × 624	4:3	75
MAC 19"	1024 × 768	4:3	75
MAC 21"	1152 × 870	4:3	75
MAC 23"	1280 × 1024	5:4	65

Component

Signal	Format	Aspect Ratio	Refresh Rate (Hz)
HDTV (1080p)	1920 × 1080	16:9	50/60
HDTV (1080i)	1920 × 1080	16:9	50/60
HDTV (720p)	1280 × 720	16:9	50/60
SDTV (480p)	720 × 480	4:3/16:9	60
SDTV (576p)	720 × 576	4:3/16:9	50
SDTV (480i)	720 × 480	4:3/16:9	60
SDTV (576i)	720 × 576	4:3/16:9	50

HDMI

Signal	Resolution (dots)	Aspect Ratio	Refresh Rate (Hz)
VGA	640 × 480	4:3	60
SVGA	800 × 600	4:3	60
XGA	1024 × 768	4:3	60
WXGA	1280 × 768 *2	15:9	60
	1280 × 800 *2	16:10	60
	1366 × 768	16:9	60
Quad-VGA	1280 × 960	4:3	60
SXGA	1280 × 1024	5:4	60
SXGA+	1400 × 1050	4:3	60
WXGA+	1440 × 900	16:10	60
WXGA++	1600 × 900	16:9	60
WSXGA+	1680 × 1050	16:10	60
WUXGA	1920 × 1200 *5	16:10	60
4K	3840 × 2160	16:9	23.98/24/25/29.97/30
HDTV (1080p)	1920 × 1080	16:9	50/60
HDTV (1080i)	1920 × 1080	16:9	50/60
HDTV (720p)	1280 × 720	16:9	50/60
SDTV (480p)	720 × 480	4:3/16:9	60
SDTV (576p)	720 × 576	4:3/16:9	50
SDTV(480i)	720 × 480	4:3/16:9	60
SDTV(576i)	720 × 576	4:3/16:9	50

*1 Native resolution on PE505XL

*2 Native resolution on PE455WL

*3 The projector may fail to display these signals correctly when [AUTO] is selected for [ASPECT RATIO] in the on-screen menu.

The factory default is [AUTO] for [ASPECT RATIO]. To display these signals, select [16:9] for [ASPECT RATIO].

*4 WXGA MODE: OFF

*5 Native resolution on PE455UL

*6 WXGA MODE: ON

Depending on your player or disc, the projected image may not be displayed correctly. The projector does not support HDCP 2.2, 4K/60p or HDR.

9-3. Specifications

This section provides technical information about projector's performance.

Model name		PE45SUL	PE455WL	PE505XL
Method		Three primary color liquid crystal shutter projection method		
Specifications of main parts				
Liquid crystal panel	Size	0.64" (with MLA) × 3 (aspect ratio: 16:10)		0.63" (with MLA) × 3 (aspect ratio: 4:3)
	Pixels ^(*)	2,304,000 (1920 dots × 1200 lines)	1,024,000 (1280 dots × 800 lines)	786,432 (1024 dots × 768 lines)
Projection lenses		F = 1.5–2.1, f = 17.2–27.6 mm		F = 1.7–2.2, f = 17.4–29.0 mm
		Zoom		Manual (Zoom Ratio = 1.7)
		Focus		Manual
		Lens shifting		H: ±29%, V: +60%, -0%
Light source		Blue Laser Diode		
Optical device		Optical isolation by dichroic mirror, combining by dichroic prism		
Light output ^(**) ^(***)		4,500 lm		5,000 lm
Contrast ratio ^(**) (all white/all black)		450,000:1 with dynamic contrast		500,000:1 with dynamic contrast
Screen size (throw distance)		30 to 300 inches (0.8–13.5 m)		30 to 300 inches (0.8–13.8 m)
Projection Angle		0 to 17.0 deg (Wide)/ 0 to 10.8 deg (Tele)	0 to 15.9 deg (Wide)/ 0 to 9.6 deg (Tele)	0 to 16.0 deg (Wide)/ 0 to 9.6 deg (Tele)
Color reproducibility		10-bit color processing (approx. 1.07 billion colors)		
Scanning frequency	Horizontal	Analog: 15 to 100 kHz (24 kHz or greater for RGB inputs), conforming to VESA standards Digital: 15 kHz, 24 to 153 kHz, conforming to VESA standards		
	Vertical	Analog: 48 Hz, 50 to 85 Hz, 100, 120 Hz conforming to VESA standards Digital: 24, 25, 30, 48 Hz, 50 to 85 Hz, 100, 120 Hz conforming to VESA standards		
Main adjustment functions		Manual zoom, manual focus, manual lens shift, input signal switching (HDMI1/HDMI2/COMPUTER/USB-A/LAN), auto image adjustment, picture magnification, muting (video), power on/standby, on-screen display/selection, etc.		
Max. display resolution (horizontal × vertical)		Analog: 1920 × 1200 (handled with Advanced AccuBlend) Digital: 3840 × 2160 (handled with Advanced AccuBlend)		
Input signals				
R,G,B,H,V	RGB: 0.7 Vp-p/75 Ω			
	Y: 1.0 Vp-p/75 Ω (with Negative Polarity Sync)			
	Cb, Cr (Pb, Pr): 0.7 Vp-p/75 Ω			
	H/V Sync: 4.0 Vp-p/TTL			
	Composite Sync: 4.0 Vp-p/TTL			
	Sync on G: 1.0 Vp-p/75 Ω (with Sync)			
Component	Y: 1.0 Vp-p/75 Ω (with Sync)			
	Cb, Cr (Pb, Pr): 0.7 Vp-p/75 Ω			
	DTV: 480i, 480p, 720p, 1080i, 1080p (60 Hz) 576i, 576p, 720p, 1080i, 1080p (50 Hz)			
	DVD: Progressive signal (50/60 Hz)			
Audio	Stereo L/R: 0.5 Vrms/22 kΩ or over			

Model name		PE455UL	PE455WL	PE505XL	
Input/output terminals					
Computer/ Component	Video input	Mini D-Sub 15-pin × 1			
	Audio input	Stereo mini Jack × 1			
Audio	Output	Stereo mini Jack × 1 (Selected from: Computer/HDMI)			
HDMI	Video input	HDMI® Terminal type A × 2 Deep Color (color depth): 8-/10-/12-bit compatible Colorimetry: RGB, YcbCr444 and YcbCr422 compatible LipSync compatible, HDCP compatible ^(*4)			
	Audio input	HDMI: Sampling frequency – 32/44.1/48 kHz, Sampling bits – 16/20/24 bits			
USB port		USB type A × 1, 5.0 V/2.0 A power supply			
LAN port		RJ-45 × 1, Supports 100BASE-TX			
Wireless LAN Port (Optional)		USB type A × 1			
Control Terminals					
RS-232C terminal (PC control)		D-Sub 9-pin × 1			
Built-in Speaker		16 W (monaural)			
Usage environment		Operating temperature: 5 to 40°C ^(*5) Operating humidity: 20 to 80% (with no condensation) Storage temperature: –10 to 50°C ^(*5) Storage humidity: 20 to 80% (with no condensation) Operating altitude: 0 to 2600 m/8500 feet (Set [FAN MODE] to [HIGH ALTITUDE] when using the projector at altitudes approximately 1600 meters/5200 feet or higher.)			
Power supply		100–240 V AC, 50/60 Hz			
Power consumption	ECO MODE	OFF	316 W (100–130 V) / 308 W (200–240 V)	279 W (100–130 V) / 276 W (200–240 V)	305 W (100–130 V) / 298 W (200–240 V)
		ECO	226 W (100–130 V) / 222 W (200–240 V)	216 W (100–130 V) / 215 W (200–240 V)	217 W (100–130 V) / 215 W (200–240 V)
		LONG LIFE	203 W (100–130 V) / 201 W (200–240 V)	191 W (100–130 V) / 191 W (200–240 V)	191 W (100–130 V) / 189 W (200–240 V)
	STANDBY MODE	NORMAL	0.11 W (100–130 V) / 0.16 W (200–240 V)		
		NETWORK STANDBY	1.6 W (100–130 V) / 1.8 W (200–240 V)		
Rated input current		4.9 A (100–130 V AC) – 2.0 A (200–240 V AC)	4.5 A (100–130 V AC) – 1.8 A (200–240 V AC)	4.8 A (100–130 V AC) – 2.0 A (200–240 V AC)	
Power cord specification		10 A or higher ^(*6)			
External dimensions		18.9" (width) × 4.8" (height) × 16" (depth)/ 480 (width) × 122 (height) × 407 (depth) mm (not including protrusions) 18.9" (width) × 5.6" (height) × 16" (depth)/ 480 (width) × 142.5 (height) × 407 (depth) mm (including protrusions)			
Weight		20.7 lbs (9.4 kg)	20.5 lbs (9.3 kg)		

*1 Effective pixels are more than 99.99%.

*2 Compliance with ISO21118-2012

- *3 This is the light output value (lumens) when the [ECO MODE] is set to [OFF] and [PRESET] is set to [HIGH-BRIGHT]. The brightness decreases when [ECO MODE] is set to [ECO] or [LONG LIFE] ([ECO]: About 60% (PE455WL: 67%), [LONG LIFE]: About 50% (PE455WL: 56%)). If any other mode is selected as the [PRESET] mode, the light output value may drop slightly.
- *4 If you are unable to view material via the HDMI input, this does not necessarily mean the projector is not functioning properly. With the implementation of HDCP technology, there may be cases in which certain content is protected with HDCP and might not be displayed due to the decision/intention of the HDCP community (Digital Content Protection, LLC).
- Video: Deep Color; 8/10/12-bit, LipSync
Audio: LPCM; up to 2 ch, sample rate 32/44.1/48 KHz, sample bit; 16/20/24-bit
HDMI: Supports HDCP 1.4
- *5 33°C or more – “Forced eco mode”
- *6 In UK, use a BS-approved power cord with molded plug having a black (13 A) fuse installed for use with this projector.
- These specifications and the product’s design are subject to change without notice.

For additional information visit:

US: <https://www.necdisplay.com/>

Europe: <https://www.nec-display-solutions.com/>

Global: <https://www.nec-display.com/global/index.html>

For information on our optional accessories, visit our website or see our brochure.

The specifications are subject to change without notice.

9-4. Cabinet Dimensions

Unit: mm (inch)

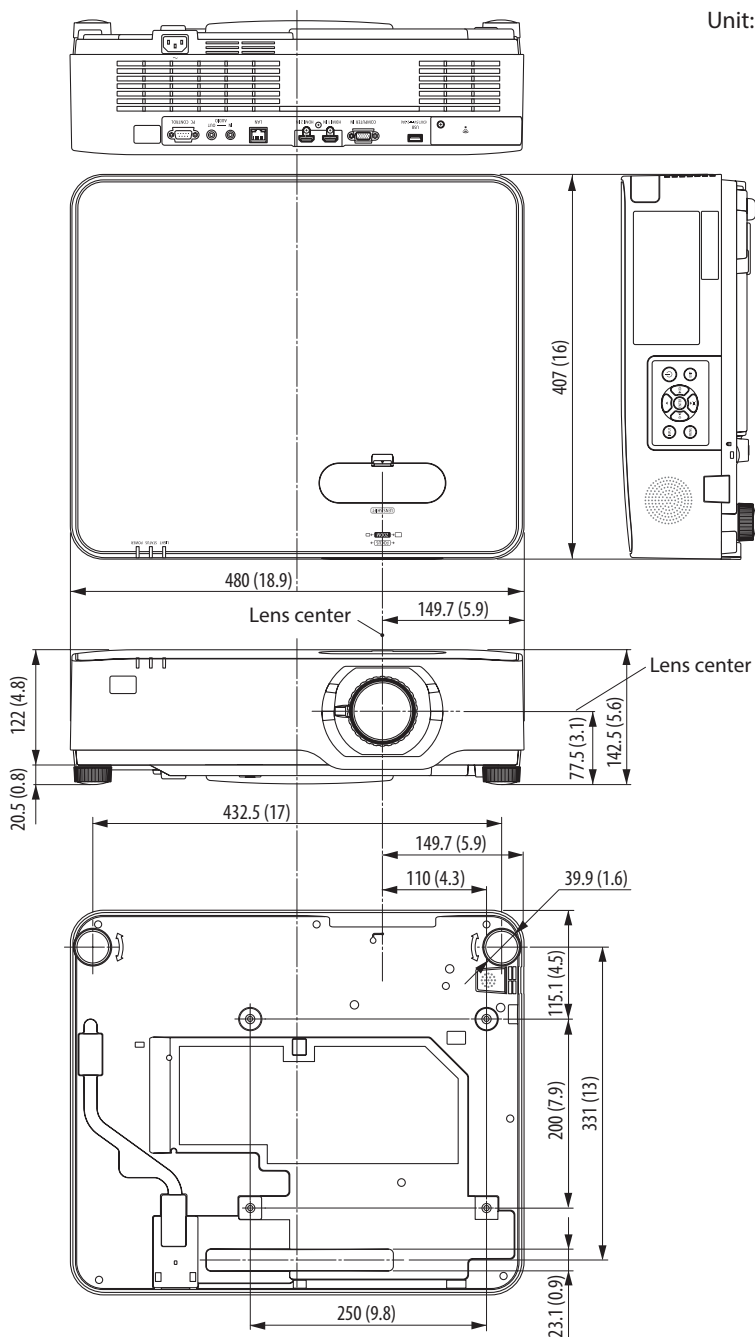

9-5. Pin assignments and signal names of main terminals

COMPUTER IN Terminal (Mini D-Sub 15 Pin)

Connection and signal level of each pin

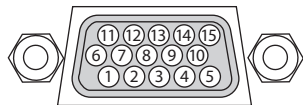

Signal Level

Video signal : 0.7Vp-p (Analog)

Sync signal : TTL level

Pin No.	RGB Signal (Analog)	YCbCr Signal
1	Red	Cr
2	Green or Sync on Green	Y
3	Blue	Cb
4	Ground	
5	Ground	
6	Red Ground	Cr Ground
7	Green Ground	Y Ground
8	Blue Ground	Cb Ground
9	Hot Plug	
10	Sync Signal Ground	
11	No Connection	
12	Bi-directional DATA (SDA)	
13	Horizontal Sync or Composite Sync	
14	Vertical Sync	
15	Data Clock	

HDMI 1 IN/HDMI 2 IN Terminal (Type A)

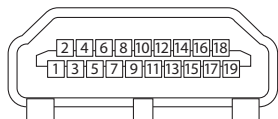

Pin No.	Signal
1	TMDS Data 2+
2	TMDS Data 2 Shield
3	TMDS Data 2-
4	TMDS Data 1+
5	TMDS Data 1 Shield
6	TMDS Data 1-
7	TMDS Data 0+
8	TMDS Data 0 Shield
9	TMDS Data 0-
10	TMDS Clock +
11	TMDS Clock Shield
12	TMDS Clock-
13	CEC
14	Disconnection
15	SCL
16	SDA
17	DDC/CEC grounding
18	+5 V power supply
19	Hot plug detection

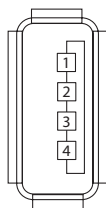
USB Port (Type A)

Pin No.	Signal
1	V _{BUS}
2	D-
3	D+
4	Grounding

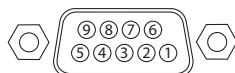
PC CONTROL Port (D-Sub 9 Pin)

Pin No.	Signal
1	Unused
2	RxD reception data
3	TxD transmission data
4	Unused
5	Grounding
6	Unused
7	RTS transmission request
8	CTS transmission allowed
9	Unused

9-6. PC Control Codes and Cable Connection

PC Control Codes

Function	Code Data							
POWER ON	02H	00H	00H	00H	00H	02H		
POWER OFF	02H	01H	00H	00H	00H	03H		
INPUT SELECT COMPUTER	02H	03H	00H	00H	02H	01H	01H	09H
INPUT SELECT HDMI1	02H	03H	00H	00H	02H	01H	A1H	A9H
INPUT SELECT HDMI2	02H	03H	00H	00H	02H	01H	A2H	AAH
INPUT SELECT USB-A	02H	03H	00H	00H	02H	01H	1FH	27H
INPUT SELECT LAN	02H	03H	00H	00H	02H	01H	20H	28H
PICTURE MUTE ON	02H	10H	00H	00H	00H	12H		
PICTURE MUTE OFF	02H	11H	00H	00H	00H	13H		
SOUND MUTE ON	02H	12H	00H	00H	00H	14H		
SOUND MUTE OFF	02H	13H	00H	00H	00H	15H		

NOTE:

- Contact your local dealer for a full list of the PC Control Codes if needed.

Cable Connection

Communication Protocol

Baud rate	38400 bps
Data length	8 bits
Parity	No parity
Stop bit	One bit
X on/off	None
Communications procedure	Full duplex

NOTE:

- Depending on the equipment, a lower baud rate may be recommended for long cable runs.

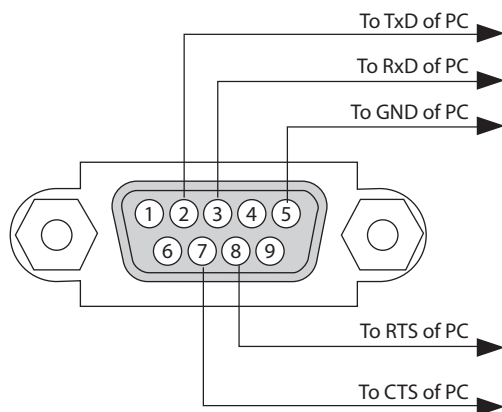
PC Control Terminal (D-Sub 9P)**NOTE:**

- Pins 1, 4, 6 and 9 are no used.
- Jumper "Request to Send" and "Clear to Send" together on both ends of the cable to simplify cable connection.
- For long cable runs it is recommended to set communication speed within projector menus to 9600 bps.

9-7. About the ASCII Control Command

This device supports the common ASCII Control Command for controlling our projector and monitor. Please visit our web site for detailed information about the command.

https://www.nec-display.com/dl/en/pj_manual/lineup.html

How to connect with an external device

There are two methods to connect the projector with an external device such as a computer.

1. Connection thru the serial port.
Connects the projector to a computer by a serial cable (a cross cable).
2. Connection via network (LAN)
Connects the projector to a computer by a LAN cable.
Concerning to the type of LAN cable, please ask to your network administrator.

Connection interface

1. Connection thru the serial port.

Communication Protocol

Item	Information
Baud rate	38400/19200/9600/4800 bps
Data length	8 bits
Parity bit	No parity
Stop bit	1 bit
Flow control	None
Communications procedure	Full duplex

2. Connection via network

Communication Protocol (Connection via LAN)

Item	Information
Communication speed	Set automatically (10/100 Mbps)
Supported standard	IEEE802.3 (10BASE-T) IEEE802.3u (100BASE-TX, Auto-Negotiation)

Use the TCP port number 7142 for transmitting and receiving command.

Parameters for this device

Input command

Input terminal	Response	Parameter
HDMI1	hdmi1	hdmi1 or hdmi
HDMI2	hdmi2	hdmi2
COMPUTER	computer	One among computer, computer1, vga, vga1, rgb, and rgb1
USB-A	usb-a	usb-a or usb-a1
LAN	lan	lan or lan1

Status command

Response	Error Status
error:temp	Temperature error
error:fan	Fan trouble
error:light	Light source trouble
error:system	System trouble

9-8. Troubleshooting

This section helps you resolve problems you may encounter while setting up or using the projector.

Common Problems & Solutions

Problem	Check These Items
Does not turn on or shut down	<ul style="list-style-type: none"> • Check that the power cord is plugged in and that the power button on the projector cabinet or the remote control is on. (→ pages 16, 18) • Check to see if the projector has overheated. If there is insufficient ventilation around the projector or if the room where you are presenting is particularly warm, move the projector to a cooler location. • The light module may fail to light. Wait a full minute and then turn on the power again. • Set [FAN MODE] to [HIGH ALTITUDE] when using the projector at altitudes approximately 5200 feet/1600 meters or higher. Using the projector at altitudes approximately 5200 feet/1600 meters or higher without setting to [HIGH ALTITUDE] can cause the projector to overheat and the projector could shut down. If this happens, wait a couple minutes and turn on the projector. (→ page 74) If you turn on the projector immediately after the light module is turned off, the fans run without displaying an image for some time and then the projector will display the image. Wait for a moment. • In case it's hard to think the trouble is not caused on the above mentioned conditions, unplug the power cord from the outlet. Then wait 5 minutes before plugging it in again. (→ page 33)
Will turn off	<ul style="list-style-type: none"> • Ensure that the [OFF TIMER] or [AUTO POWER OFF] is off. (→ page 65, 78)
No picture	<ul style="list-style-type: none"> • Check if the appropriate input is selected. (→ page 20) If there is still no picture, press the SOURCE button or one of the source buttons again. • Ensure your cables are connected properly. • Use menus to adjust the brightness and contrast. (→ page 58) • Check that the AV-MUTE (image off) buttons are not pressed. • Reset the settings or adjustments to factory preset levels using the [RESET] in the Menu. (→ page 82) • Enter your registered keyword if the Security function is enabled. (→ page 45) • If the HDMI 1 IN or the HDMI 2 IN signal cannot be displayed, try the following. <ul style="list-style-type: none"> - Reinstall your driver for the graphics card built in your computer, or use the updated driver. For reinstalling or updating your driver, refer to the user guide accompanied with your computer or graphics card, or contact the support center for your computer manufacturer. Install the updated driver or OS on your own responsibility. We are not liable for any trouble and failure caused by this installation. • Be sure to connect the projector and notebook PC while the projector is in standby mode and before turning on the power to the notebook PC. In most cases the output signal from the notebook PC is not turned on unless connected to the projector before being powered up. <ul style="list-style-type: none"> * If the screen goes blank while using your remote control, it may be the result of the computer's screen-saver or power management software. • See also the page 145.
Picture suddenly becomes dark	<ul style="list-style-type: none"> • Check if the projector is in the Forced ECO mode because of too high ambient temperature.

Problem	Check These Items
Color tone or hue is unusual	<ul style="list-style-type: none"> • Check if an appropriate color is selected in [WALL COLOR]. If so, select an appropriate option. (→ page 63) • Adjust [HUE] in [PICTURE]. (→ page 58)
Image isn't square to the screen	<ul style="list-style-type: none"> • Reposition the projector to improve its angle to the screen. (→ page 22) • Use the Keystone correction function to correct the trapezoid distortion. (→ page 28)
Picture is blurred	<ul style="list-style-type: none"> • Adjust the focus. (→ page 25) • Reposition the projector to improve its angle to the screen. (→ page 22) • Ensure that the distance between the projector and screen is within the adjustment range of the lens. (→ page 121) • Has the lens been shifted by an amount exceeding the guaranteed range? (→ page 128) • Condensation may form on the lens if the projector is cold, brought into a warm place and is then turned on. Should this happen, let the projector stand until there is no condensation on the lens.
Image is scrolling vertically, horizontally or both	<ul style="list-style-type: none"> • Check the computer's resolution and frequency. Make sure that the resolution you are trying to display is supported by the projector. (→ page 131) • Adjust the computer image manually with the [HORIZONTAL]/[VERTICAL] in the [IMAGE OPTIONS]. (→ page 60)
Remote control does not work	<ul style="list-style-type: none"> • Install new batteries.(→ page 13) • Make sure there are no obstacles between you and the projector. • Stand within 23 feet (7 m) of the projector. (→ page 14) • The remote control sensor on the back of the projector cannot be used when the cable cover is mounted on the projector.
Indicator is lit or blinking	<ul style="list-style-type: none"> • See the POWER/STATUS/LIGHT Indicator. (→ page 146)
Cross color in RGB mode	<ul style="list-style-type: none"> • Press the AUTO ADJ. button on the remote control. (→ page 32) • Adjust the computer image manually with [CLOCK]/[PHASE] in [IMAGE OPTIONS] in the menu. (→ page 59)

For more information contact your dealer.

If there is no picture, or the picture is not displayed correctly.

- Power on process for the projector and the PC.
Be sure to connect the projector and notebook PC while the projector is in standby mode and before turning on the power to the notebook PC.
In most cases the output signal from the notebook PC is not turned on unless connected to the projector before being powered up.

NOTE:

- You can check the horizontal frequency of the current signal in the projector's menu under Information. If it reads "0kHz", this means there is no signal being output from the computer. (→ page 80 or go to next step)
-

- Enabling the computer's external display.
Displaying an image on the notebook PC's screen does not necessarily mean it outputs a signal to the projector. When using a PC compatible laptop, a combination of function keys will enable/disable the external display. Usually, the combination of the "Fn" key along with one of the 12 function keys gets the external display to come on or off. For example, NEC laptops use Fn + F3, while Dell laptops use Fn + F8 key combinations to toggle through external display selections.
- Non-standard signal output from the computer
If the output signal from a notebook PC is not an industry standard, the projected image may not be displayed correctly. Should this happen, deactivate the notebook PC's LCD screen when the projector display is in use. Each notebook PC has a different way of deactivate/reactivate the local LCD screens as described in the previous step. Refer to your computer's documentation for detailed information.
- Image displayed is incorrect when using a Mac
When using a Mac with the projector, set the DIPswitch of the Mac adapter (not supplied with the projector) according to your resolution. After setting, restart your Mac for the changes to take affect.
For setting display modes other than those supported by your Mac and the projector, changing the DIP switch on a Mac adapter may bounce an image slightly or may display nothing. Should this happen, set the DIP switch to the 13" fixed mode and then restart your Mac. After that, restore the DIP switches to a displayable mode and then restart the Mac again.

NOTE:

- A Video Adapter cable manufactured by Apple Inc. is needed for a MacBook which does not have a mini D-Sub 15-pin terminal.
-

- Mirroring on a MacBook
 - * When using the projector with a MacBook, output may not be set to the display resolution of the projector unless "mirroring" is off on your MacBook. Refer to owner's manual supplied with your Mac computer for mirroring.
- Folders or icons are hidden on the Mac screen
Folders or icons may not be seen on the screen. Should this happen, select [View] → [Arrange] from the Apple menu and arrange icons.





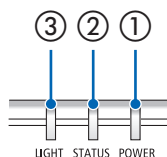















9-9. Indicator Message



Feature of each indicator



- ① POWER indicator
This indicator informs the power status of the projector.
- ② STATUS indicator
Lights up/flashes when a button is pressed with the [CONTROL PANEL LOCK] enabled, or when an error occurs in the projector.
- ③ LIGHT indicator
This indicator informs the state of light source, used time of the light source.

Indicator Message (Status message)

POWER	STATUS	LIGHT	Projector status
 Off	 Off	 Off	Power is off
 Orange (Blink ^{*1})	 Off	 Off	In the state of Standby ([STANDBY MODE] is [NORMAL])
 Orange (Light)	 Off	 Off	In the state of Standby ([STANDBY MODE] is [NETWORK STANDBY])
 Green (Light)	 Off	 Off	In the state of Sleep
 Blue (Light)	 Off	 Green (Light)	Powered state ([ECO MODE] is [OFF])
 Blue (Light)	 Off	 Green (Blink ^{*2})	Powered state ([ECO MODE] is [ECO] or [LONG LIFE])
 Blue (Blink ^{*2})	 Off	 Status varies	[OFF TIMER] is activated (Powered state)













POWER	STATUS	LIGHT	Projector status
 Blue (Blink* ³)	 Off	 Off	Preparing for powering ON

*1 Repetition to light on for 1.5 seconds / off for 7.5 seconds

*2 Repetition to light on for 2.5 seconds / off for 0.5 seconds

*3 Repetition to light on for 0.5 seconds / off for 0.5 seconds

Indicator Message (Error message)

POWER	STATUS	LIGHT	Projector status	Procedure
 Blue (Light)	 Orange (Light)	Status varies	A button has been pressed while the [CONTROL PANEL LOCK] is activated.	The projector's keys are locked. The setting must be canceled to operate the projector. (→ page 71)
			ID numbers for the projector and the remote control do not match.	Check the control IDs (→ page 72)
 Blue (Light)	 Orange (Blink*4)	Status varies	Network conflict	Both the built-in wired LAN and the wireless LAN cannot be connected to the same network at the same time. To use both built-in wired LAN and wireless LAN at the same time, connect them to different networks. NOTE: In the Standby condition, the status indicator on the cabinet does not blink in orange even if the network conflicts.
 Blue (Light)	 Off	 Orange (Light)	Temperature problem (In the Forced ECO mode)	Ambient temperature is high. Lower the room temperature.
 Red (Blink*3)	 Off	 Off	Temperature problem	Ambient temperature is out of the operation temperature. Check if any obstruction stays near the exhaust vent.
Status varies	 Off	 Red (Blink*3)	Hardware problem	Problem with the hardware. Contact your dealer.
 Red (Light)	Status varies	Status varies	Error requiring service support	Contact your dealer or service personnel. Make sure to check and inform indicator status for asking to repair.

*3 Repetition to light on for 0.5 seconds / off for 0.5 seconds

*4 Repetition to light on for 0.5 seconds / off for 2.5 seconds

When the thermal protector is activated:

When inside temperature of the projector becomes too high or low, the POWER indicator start to red blink in a short cycle. After this happened, the thermal protector will activate and the projector may be turned off.

In this case, please take the below measures:

- Pull out the power plug from the wall inlet.
- Place the projector in cool place if it has been placed in high ambient temperature.
- Clean the exhaust vent if dust has accumulated on.
- Leave the projector for about one hour until inside temperature gets lower.

9-10. Setting the date and time in the projector

Set the current date and time and daylight saving time in the projector. When set, the date and time appear in the upper right corner of the MultiPresenter start-up screen.

There are 2 ways of displaying the screen for [DATE AND TIME SETTINGS] as shown below.

1. Display the on-screen menu and select [SETUP] → [GENERAL] → [DATE AND TIME SETTINGS].
(NOTE: At this point, the input terminal switches to [LAN].)

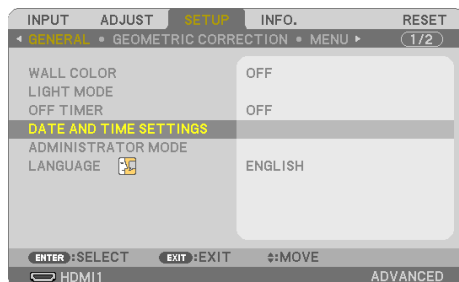

2. Switch the input terminal to [LAN], display the “MultiPresenter start-up screen” and select [TOOLS] → [DATE AND TIME].



Item name	Description
TIME ZONE SETTINGS	Set the time difference between the region where the projector is used and the UTC (Universal Time, Coordinated). <ul style="list-style-type: none"> • Initial value: +00:00 • When using the projector in Japan, set the time as [+09:00].
DATE AND TIME SETTINGS	Sets the current date and time. <ul style="list-style-type: none"> • When shipped from the factory, the time is set to the UTC (Universal Time, Coordinated). By setting the time zone of your area, the current date and time will be displayed. • When synchronizing the time with the NTP server on the network to obtain the correct time, set [SYNCHRONIZE TO INTERNET TIME SERVER.] to [ENABLE]. Then enter the IP address of the NTP server or the [HOST NAME] and perform [UPDATE].
SUMMER TIME SETTINGS	Set the daylight saving time. <ul style="list-style-type: none"> • Set the daylight saving time setting to [ENABLE]. • Set the start and end of the daylight saving time, as well as each item of the time difference.

Important:

- When a period of about one or more months has passed after disconnecting the power cord of the projector, the time will be initialized and the clock function will stop. When initialized, the date becomes [01/01/2018] and the time becomes [00:00]. If the clock function has stopped, configure the [DATE AND TIME SETTINGS] again.

NOTE:

- To change the date and time by inputting them directly, delete the currently displayed numbers then input the new numbers (overwriting is not possible).
 - When the [SUMMER TIME SETTINGS] is enabled, the same start date or end date specified in the daylight saving time cannot be set for [DATE AND TIME SETTINGS].
-

9-11. Troubleshooting Check List

Before contacting your dealer or service personnel, check the following list to be sure repairs are needed also by referring to the “Troubleshooting” section in your user’s manual. This checklist below will help us solve your problem more efficiently.

* Print this page and the next page for your check.

Frequency of occurrence:

always sometimes (How often? _____) other (_____)

Power

- No power (POWER indicator does not light blue). See also “Status Indicator (STATUS)”.
- Power cord’s plug is fully inserted into the wall outlet.
- Main power switch is pressed to the ON position.
- No power even though you press and hold the POWER button.
- Shut down during operation.
 - Power cord’s plug is fully inserted into the wall outlet.
 - [AUTO POWER OFF] is turned off (only models with the [AUTO POWER OFF] function).
 - [OFF TIMER] is turned off (only models with the [OFF TIMER] function).

Video and Audio

- No image is displayed from your PC or video equipment to the projector.
 - Still no image even though you connect the projector to the PC first, then start the PC.
 - Enabling your notebook PC’s signal output to the projector.
 - A combination of function keys will enable/disable the external display. Usually, the combination of the “Fn” key along with one of the 12 function keys turns the external display on or off.
 - No image (blue or black background, no display).
 - Still no image even though you press the AUTO ADJ. button.
 - Still no image even though you carry out [RESET] in the projector’s menu.
 - Signal cable’s plug is fully inserted into the input terminal
 - A message appears on the screen. (_____)
 - The source connected to the projector is active and available.
 - Still no image even though you adjust the brightness and/or the contrast.
 - Input source’s resolution and frequency are supported by the projector.
- Image is too dark.
 - Remains unchanged even though you adjust the brightness and/or the contrast.
- Image is distorted.
 - Image appears to be trapezoidal (unchanged even though you carry out the [KEYSTONE] adjustment).
- Parts of the image are lost.
 - Still unchanged even though you press the AUTO ADJ. button.
 - Still unchanged even though you carry out [RESET] in the projector’s menu.
- Image is shifted in the vertical or horizontal direction.
 - Horizontal and vertical positions are correctly adjusted on a computer signal.
 - Input source’s resolution and frequency are supported by the projector.
 - Some pixels are lost.
- Image is flickering.
 - Still unchanged even though you press the AUTO ADJ. button.
 - Still unchanged even though you carry out [RESET] in the projector’s menu.
 - Image shows flickering or color drift on a computer signal.
 - Still unchanged even though you change [FAN MODE] from [HIGH ALTITUDE] to [AUTO].
- Image appears blurry or out of focus.
 - Still unchanged even though you checked the signal’s resolution on PC and changed it to projector’s native resolution.
 - Still unchanged even though you adjusted the focus.
- No sound.
 - Audio cable is correctly connected to the audio input of the projector.
 - Still unchanged even though you adjusted the volume level.
 - AUDIO OUT is connected to your audio equipment (only models with the AUDIO OUT terminal).

Other

- Remote control does not work.
 - No obstacles between the sensor of the projector and the remote control.
 - Projector is placed near a fluorescent light that can disturb the infrared remote controls.
 - ID for the projector and for the remote are same.
- Buttons on the projector cabinet do not work (only models with the [CONTROL PANEL LOCK] function)
 - [CONTROL PANEL LOCK] is not turned on or is disabled in the menu.
 - Still unchanged even though you press and hold the INPUT button over 10 seconds.

9-12. REGISTER YOUR PROJECTOR! (for residents in the United States, Canada, and Mexico)

Please take time to register your new projector. This will activate your limited parts and labor warranty and InstaCare service program.

Visit our web site at www.necdisplay.com, click on support center/register product and submit your completed form online.

Upon receipt, we will send a confirmation letter with all the details you will need to take advantage of fast, reliable warranty and service programs from the industry leader, NEC Display Solutions of America, Inc.

NEC