

Panasonic®

Operating Instructions Functional Manual

DLP™ Projector Commercial Use

Model No. **PT-RQ50K**

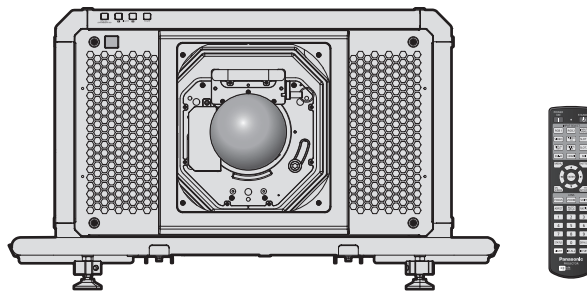

The projection lens is sold separately.

**SOLID
SHINE
LASER**

4K
PROFESSIONAL

ProSelecta

View :: Compare :: Select - www.ProSelecta.com

Contents

Read this first!	5	Connecting	52
		Before connecting	52
		Connecting example: AV equipment	52
		Connecting example: Computers	54
		Connecting example using DIGITAL LINK	55
		Connecting example when using the contrast synchronization function/shutter synchronization function	56
Chapter 1 Preparation		Chapter 3 Basic Operations	
Precautions for use	18	Switching on/off the projector	59
Intended use of the product	18	Connecting the power cord	59
Installation and handling of the laser product (for USA and Canada)	18	Power indicator	60
Cautions when transporting	18	Switching on the projector	61
Cautions when installing	18	When the initial setting screen is displayed	62
Cautions when setting up the projector	21	Making adjustments and selections	67
Security	23	Switching off the projector	68
Notes regarding the wireless LAN	24	Projecting	69
DIGITAL LINK	25	Selecting the input signal	69
Art-Net	25	Adjusting the focus, zoom, and lens shift	71
Application software supported by the projector	25	Adjusting the focus balance	72
Storing	26	Executing the lens calibration	73
Disposal	26	Moving the projection lens to the home position	73
Cautions on use	26	Lens shift range	74
Accessories	27	Adjusting the lens mounter when the focus is unbalanced	75
Optional accessories	28	Using the USB memory	78
About your projector	29	Notes on use	78
Remote control	29	USB memory that can be used with the projector	78
Projector body	31	Attaching the USB memory	78
Names and functions of the Interface Board	35	Removing the USB memory	78
Preparing the remote control	37	Operating with the remote control	79
Inserting and removing the batteries	37	Using the shutter function	79
When using the multiple projectors	37	Using the on-screen display function	79
Connecting the remote control to the projector with a cable	38	Using the automatic setup function	80
		Switching the image aspect ratio	80
		Using the function button	80
		Displaying internal test pattern	81
		Using the status function	81
		Setting ID number of the remote control	81
Chapter 2 Getting Started		Chapter 4 Settings	
Setting up	40	Menu navigation	84
Usable outlet	40	Navigating through the menu	84
Installation mode	40	Main menu	85
Interface Board	42	Sub-menu	86
Projected image and throw distance	42		
Adjusting adjustable feet	48		
Attaching/removing the projection lens (optional)	49		
Attaching the projection lens	49		
Removing the projection lens	50		

Contents

[PICTURE] menu	89	[PROJECTOR SETUP] menu	143
[PICTURE MODE].....	89	[PROJECTOR ID].....	143
[CONTRAST].....	89	[PROJECTION METHOD].....	143
[BRIGHTNESS].....	90	[LENS].....	144
[COLOR].....	90	[OPERATION SETTING].....	154
[TINT].....	90	[LIGHT OUTPUT].....	157
[COLOR TEMPERATURE].....	90	[BRIGHTNESS CONTROL].....	158
[GAMMA].....	92	[NO SIGNAL SETTING].....	161
[SYSTEM DAYLIGHT VIEW].....	94	[INITIAL STARTUP].....	165
[SHARPNESS].....	94	[STARTUP INPUT SELECT].....	165
[NOISE REDUCTION].....	94	[DATE AND TIME].....	166
[DYNAMIC CONTRAST].....	94	[SCHEDULE].....	167
[COLOR SPACE].....	96	[MULTI PROJECTOR SYNC].....	168
[SYSTEM SELECTOR].....	96	[RS-232C].....	170
sRGB-compliant video.....	97	[REMOTE2 MODE].....	172
[POSITION] menu	98	[FUNCTION BUTTON].....	172
[SHIFT].....	98	[STATUS].....	173
[ASPECT].....	98	[INFO MONITOR SETTING].....	176
[ZOOM].....	99	[DATA CLONING].....	178
[GEOMETRY].....	100	[SAVE ALL USER DATA].....	178
[CONVERGENCE].....	105	[LOAD ALL USER DATA].....	178
[ADVANCED MENU] menu	106	[INITIALIZE].....	178
[DIGITAL CINEMA REALITY].....	106	[FIRMWARE UPDATE].....	180
[BLANKING].....	106	[SERVICE PASSWORD].....	180
[EDGE BLENDING].....	107	[TEST PATTERN] menu	181
[FRAME RESPONSE].....	109	[TEST PATTERN].....	181
[FRAME DELAY].....	109	[SIGNAL LIST] menu	182
[RASTER POSITION].....	110	Registering new signals.....	182
[DISPLAY LANGUAGE] menu	111	Renaming the registered signal.....	182
Changing the display language.....	111	Deleting the registered signal.....	182
[DISPLAY OPTION] menu	112	Protecting the registered signal.....	183
[COLOR MATCHING].....	112	Expanding signal lock-in range.....	183
[SCREEN SETTING].....	114	Sub memory.....	184
[AUTO SIGNAL].....	114	[SECURITY] menu	185
[AUTO SETUP].....	114	[SECURITY PASSWORD].....	185
[BACKUP INPUT SETTING].....	115	[SECURITY PASSWORD CHANGE].....	185
[SIMUL INPUT SETTING].....	117	[CONTROL DEVICE SETUP].....	185
[SLOT IN].....	117	[CONTROL DEVICE PASSWORD CHANGE]	189
[DIGITAL LINK IN].....	131	[NETWORK] menu	191
[ON-SCREEN DISPLAY].....	133	[DIGITAL LINK MODE].....	191
[MENU MODE].....	135	[DIGITAL LINK STATUS].....	191
[BACK COLOR].....	136	[WIRED LAN].....	192
[STARTUP LOGO].....	136	[WIRELESS LAN].....	192
[UNIFORMITY].....	137	[PROJECTOR NAME].....	193
[SHUTTER SETTING].....	138	[NETWORK CONTROL].....	193
[FREEZE].....	140	[NETWORK STATUS].....	194
[WAVEFORM MONITOR].....	140	[DIGITAL LINK MENU].....	194
[CUT OFF].....	141	[Art-Net SETUP].....	195
		[Art-Net CHANNEL SETTING].....	195
		[Art-Net STATUS].....	196

Chapter 5 Operations

Network connection **198**
 Connecting via wired LAN 198
 Connecting via wireless LAN 200
Web control function **202**
 Computer that can be used for setting 202
 Accessing from the web browser 202
Using the information monitor function **229**
 Screen mode 229
 Top menu 229
 Sub-menu 229
 Basic operation procedure in the menu
 operation mode 230
 [USER VIEW] menu 230
 [SETUP] menu 231
 [STATUS] menu 235
 Error notification mode 237
Using the data cloning function **239**
 Copying the data to another projector via LAN
 239
 Copying the data to another projector using
 USB 241
Updating the firmware **243**
 Updating the firmware via LAN 243
 Updating the firmware using the USB memory
 248

Chapter 6 Maintenance

Light source/temperature indicators **251**
 When an indicator lights up 251
Maintenance **253**
 Before maintenance 253
 Maintenance 253
Troubleshooting **254**
Self-diagnosis display **256**

Chapter 7 Appendix

Technical information **259**
 PJLink protocol 259
 Using Art-Net function 261
 Control commands via LAN 266
 <SERIAL IN>/<SERIAL OUT> terminal 269
 <REMOTE 2 IN> terminal 273
 List of compatible signals 274
Specifications **290**
Dimensions **293**
Installing the Interface Board **294**
 Before installing or removing 294
 How to install the Interface Board 294
 How to remove the Interface Board 295
Index **296**

Read this first!

WARNING: THIS APPARATUS MUST BE EARTHED.

WARNING: To prevent damage which may result in fire or shock hazard, do not expose this appliance to rain or moisture.
This device is not intended for use in the direct field of view at visual display workplaces. To avoid incommoding reflexions at visual display workplaces this device must not be placed in the direct field of view.
The equipment is not intended for used at a video workstation in compliance BildscharbV.

The sound pressure level at the operator position is equal or less than 70 dB (A) according to ISO 7779.

WARNING:

1. Remove the plug from the mains socket when this unit is not in use for a prolonged period of time.
2. To prevent electric shock, do not remove cover. No user serviceable parts inside. Refer servicing to qualified service personnel.
3. Do not remove the earthing pin on the mains plug. This apparatus is equipped with a three prong earthing-type mains plug. This plug will only fit an earthing-type mains socket. This is a safety feature. If you are unable to insert the plug into the mains socket, contact an electrician. Do not defeat the purpose of the earthing plug.

WARNING:

This equipment is compliant with Class A of CISPR32.
In a residential environment this equipment may cause radio interference.

(for Taiwan)

WARNING:

This equipment complies with the Class A standard of CISPR32.
This is Class A information technology equipment that may cause radio frequency interference when used in a residential environment, in which the user will be required to take certain appropriate countermeasures.

CAUTION: To assure continued compliance, follow the attached installation instructions. This includes using the provided power cord and shielded interface cables when connecting to computer or peripheral devices. Also, any unauthorized changes or modifications to this equipment could void the user's authority to operate this device.

This is a device to project images onto a screen, etc., and is not intended for use as indoor lighting in a domestic environment.

Directive 2009/125/EC

WARNING: TO REDUCE THE RISK OF FIRE OR ELECTRIC SHOCK, DO NOT EXPOSE THIS PRODUCT TO RAIN OR MOISTURE.

■ Hazard distance (IEC 62471-5:2015)

The distance from the projection lens surface, at which the level of exposure has reached the level of the applicable Exposure Limit Value, is known as the hazard distance (HD) or safety distance.

Do not look into the projected light from inside the hazard distance (within RG3 range). The eyes may be damaged by the direct irradiation. It is considered to be safe to look into the projected light from outside the hazard distance (within RG2 range).

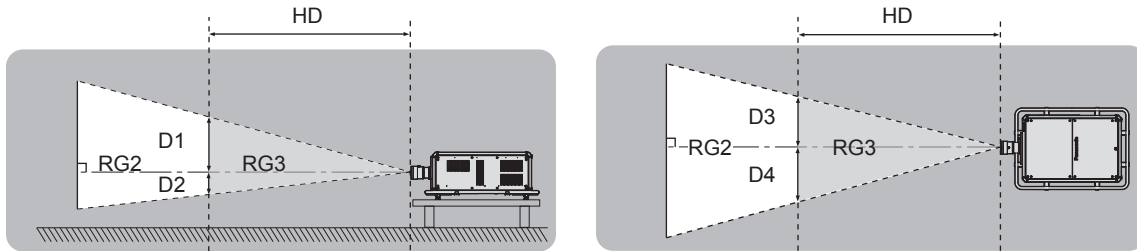

■ Risk group

The combination of the projector and the projection lens is categorized as the risk group 2 when the hazard distance is less than 1 m (39-3/8"). It is categorized as the risk group 3 when the hazard distance exceeds 1 m (39-3/8"), and it will be for professional use instead of consumer use.

In case of risk group 3, there is a possibility of damaging the eyes by direct irradiation when looking into the projection light from inside the hazard distance (within RG3 range).

In case of risk group 2, it can be used safely without damaging the eyes in any condition.

Combinations with any projection lens are categorized as risk group 3 for this projector.

Each dimension inside the hazard distance (within RG3 range) for combination with projection lens which the hazard distance exceeds 1 m (39-3/8") is as follows.

(Unit: m)

Projection lens Model No.	HD ^{*1}	D1 ^{*2}	D2 ^{*2}	D3 ^{*2}	D4 ^{*2}
ET-D3QW300	1.8	0.280	0.280	0.529	0.529
ET-D3QS400	2.3	0.290	0.290	0.548	0.548
ET-D3QT500	3.9	0.304	0.304	0.574	0.574
ET-D3QT600	4.1	0.278	0.278	0.526	0.526
ET-D3QT700	5.5	0.270	0.270	0.509	0.509
ET-D3QT800	8.4	0.289	0.289	0.545	0.545

*1 HD: Hazard Distance

*2 The values of D1 to D4 will change in accordance with the lens shift amount. Each value in the table is the maximum value.

Note

- The value in the table is based on IEC 62471-5:2015.

WARNING:

■ POWER

The wall outlet or the circuit breaker shall be installed near the equipment and shall be easily accessible when problems occur. If the following problems occur, cut off the power supply immediately.

Continued use of the projector in these conditions will result in fire or electric shock, or will cause visual impairment.

- If foreign objects or water get inside the projector, cut off the power supply.
- If the projector is dropped or the cabinet is broken, cut off the power supply.
- If you notice smoke, strange smells or noise coming from the projector, cut off the power supply.

Please contact an Authorized Service Center for repairs, and do not attempt to repair the projector yourself.

During a thunderstorm, do not touch the projector or the cable.

Electric shocks can result.

Do not do anything that might damage the power cord, the power plug, or the power connector.

If the power cord is used while damaged, electric shocks, short-circuits or fire will result.

- Do not damage the power cord, make any modifications to it, disassemble it, place it near any hot objects, bend it excessively, twist it, pull it, place heavy objects on top of it or wrap it into a bundle.

Consult an Authorized Service Center for any repairs to the power cord, the power plug, or the power connector that might be necessary.

Do not use anything other than the provided power cord.

Failure to observe this will result in electric shocks or fire. Please note that if you do not use the provided power cord to ground the device on the side of the outlet, this may result in electric shocks.

Completely insert the power plug into the wall outlet.

If the plug is not inserted correctly, electric shocks or overheating will result.

- Do not use plugs which are damaged or wall outlets which are coming loose from the wall.

Fully attach the power connector (projector-side) to the <AC IN> terminal.

A power connector that is not completely attached may result in fires caused by electric shocks or heat generation.

Do not handle the power plug and power connector with wet hands.

Failure to observe this will result in electric shocks.

Use an outlet supporting 30 A independently when using the projector with 200 V to 240 V alternating current.

Use an outlet supporting 15 A independently when using the projector with 100 V to 120 V alternating current.

Using an outlet together with another device may result in fires due to heat generation.

Do not overload the wall outlet.

If the power supply is overloaded (ex., by using too many adapters), overheating may occur and fire will result.

Clean the power plug regularly to prevent it from becoming covered in dust.

Failure to observe this will cause a fire.

- If dust builds up on the power plug, the resulting humidity can damage the insulation.
- If not using the projector for an extended period of time, pull the power plug out from the wall outlet.

Pull the power plug out from the wall outlet and wipe it with a dry cloth regularly.

■ ON USE/INSTALLATION

Do not place the projector on soft materials such as carpets or sponge mats.

Doing so will cause the projector to overheat, which can cause burns, fire or damage to the projector.

Do not set up the projector in humid or dusty places or in places where the projector may come into contact with oily smoke or steam.

Using the projector under such conditions will result in fire, electric shocks or deterioration of components. Oil may also distort the plastic and the projector could fall such as when mounted on the ceiling.

Do not install this projector in a place which is not strong enough to take the full weight of the projector or on top of a surface which is sloped or unstable.

Failure to observe this will cause projector to fall down or tip over the projector, and severe injury or damage could result.

WARNING:

Do not install the projector in a location where people pass through.

People may bump into the projector or trip on the power cord, which may result in fire, electric shock, or injury.

Do not cover the intake/exhaust vents or place anything within 500 mm (19-11/16") of them.

Doing so will cause the projector to overheat, which can cause fire or damage to the projector.

- Do not place the projector in narrow, badly ventilated places.
- Do not place the projector on cloth or papers, as these materials could be drawn into the intake vent.

Do not look at or place your skin into the light emitted from the lens while the projector is being used.

Do not enter the projection luminous flux using an optical device (such as magnifier or mirror).

Doing so can cause burns or loss of sight.

- Strong light is emitted from the projector's lens. Do not look at or place your hands directly into this light.
- Be especially careful not to let young children look into the lens. In addition, turn off the power and switch off the main power when you are away from the projector.

Do not project an image with the lens cover of the projection lens (optional) attached.

Doing so can cause fire.

Never attempt to remodel or disassemble the projector.

High voltages can cause fire or electric shocks.

- For any inspection, adjustment and repair work, please contact an Authorized Service Center.

Do not touch the top surface of the projector during use.

Doing so may result in burns, as the top surface is hot during use and for a while after use.

Do not allow metal objects, flammable objects, or liquids to enter inside of the projector. Do not allow the projector to get wet.

Doing so may cause short circuits or overheating, and result in fire, electric shock, or malfunction of the projector.

- Do not place containers of liquid or metal objects near the projector.
- If liquid enters inside of the projector, consult your dealer.
- Particular attention must be paid to children.

Installation work such as mounting the projector on the ceiling should only be carried out by a qualified technician.

If installation is not carried out and secured correctly, it can cause injury or accidents, such as electric shocks.

■ ACCESSORIES

Do not use or handle the batteries improperly, and refer to the following.

Failure to observe this will cause burns, batteries to leak, overheat, explode or catch fire.

- Do not use unspecified batteries.
- Do not charge dry cell batteries.
- Do not disassemble dry cell batteries.
- Do not heat the batteries or place them into water or fire.
- Do not allow the + and – terminals of the batteries to come into contact with metallic objects such as necklaces or hairpins.
- Do not store or carry batteries together with metallic objects.
- Store the batteries in a plastic bag and keep them away from metallic objects.
- Make sure the polarities (+ and –) are correct when inserting the batteries.
- Do not use a new battery together with an old battery or mix different types of batteries.
- Do not use batteries with the outer cover peeling away or removed.

If the battery fluid leaks, do not touch it with bare hands, and take the following measures if necessary.

- Battery fluid on your skin or clothing could result in skin inflammation or injury.
Rinse with clean water and seek medical advice immediately.
- Battery fluid coming in contact with your eyes could result in loss of sight.
In this case, do not rub your eyes. Rinse with clean water and seek medical advice immediately.

Remove the depleted batteries from the remote control promptly.

- Leaving them in the unit may result in fluid leakage, overheating, or explosion of the batteries.

CAUTION:

■ POWER

When disconnecting the power cord, be sure to hold the power plug and power connector.

If the power cord itself is pulled, the lead will become damaged, and fire, short-circuits or serious electric shocks will result.

When not using the projector for an extended period of time, disconnect the power plug from the wall outlet.

Failure to do so may result in fire or electric shock.

Before replacing the projection lens, be sure to turn off the power and disconnect the power plug from the wall outlet.

- Unexpected projection of light may cause injury to eyes.
- Replacing the projection lens without removing the power plug may result in electric shock.

Disconnect the power plug from the wall outlet before attaching or removing the Interface Board and performing maintenance.

Failure to do so may result in electric shock.

Do not connect the power cord to the projector while current is running.

Do not remove the power connector (projector-side) while current is running.

Connecting or removing the power connector while current is running may result in fires caused by sparks.

■ ON USE/INSTALLATION

Do not place heavy objects on top of the projector.

Failure to observe this will cause the projector to become unbalanced and fall, which could result in damage or injury. The projector will be damaged or deformed.

Do not put your weight on this projector.

You could fall or the projector could break, and injury will result.

- Be especially careful not to let young children stand or sit on the projector.

Do not place the projector in extremely hot locations.

Doing so will cause the outer casing or internal components to deteriorate, or result in fire.

- Take particular care in locations exposed to direct sunlight or near heaters.

Do not place your hands in the openings beside the optical lens, while shifting the lens.

Failure to observe this could cause injury.

Do not install the projector in a location where salt pollution or corrosive gas may occur.

Doing so may result in falling due to corrosion. Also, it may result in malfunctions.

Do not stand in front of the lens while the projector is being used.

Doing so can cause damage and burns to clothing.

- Strong light is emitted from the projector's lens.

Do not place objects in front of the lens while the projector is being used.

Do not block the projection by placing an object in front of the projection lens.

Doing so can cause fire, damage to an object, or malfunction of the projector.

- Strong light is emitted from the projector's lens.

The projector must be carried or installed by four or more people.

Failure to do so may cause falling accidents.

Always disconnect all cables before moving the projector.

Moving the projector with cables still attached can damage the cables, which will cause fire or electric shocks to occur.

CAUTION:

■ **ACCESSORIES**

When not using the projector for an extended period of time, remove the batteries from the remote control.

Failure to observe this will cause the batteries to leak, overheat, catch fire or explode, which may result in fire or contamination of surrounding area.

■ **MAINTENANCE**

Ask your dealer about cleaning inside the projector every 20 000 hours of usage as an estimated duration.

Continuous use while dust is accumulated inside the projector may result in fire.

- For cleaning fee, ask your dealer.

To remove the battery

Remote Control Battery

1. Press the guide and lift the cover.

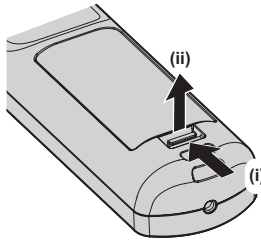

2. Remove the batteries.

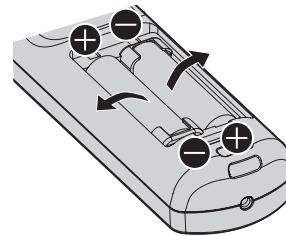

■ Trademarks

- SOLID SHINE is a trademark of Panasonic Corporation.
- DLP is a trademark or registered trademark of Texas Instruments.
- The terms HDMI and HDMI High-Definition Multimedia Interface, and the HDMI Logo are trademarks or registered trademarks of HDMI Licensing Administrator, Inc. in the United States and other countries.
- DisplayPort™ is a trademark owned by the Video Electronics Standards Association (VESA®) in the United States and other countries.
- PJLink™ is a registered trademark or pending trademark in Japan, the United States, and other countries and regions.
- Crestron Connected, the Crestron Connected logo, Crestron Fusion, Crestron RoomView, and RoomView are either trademarks or registered trademarks of Crestron Electronics, Inc. in the United States and/or other countries.
- HDBaseT™ is a trademark of HDBaseT Alliance.
- Art-Net™ Designed by and Copyright Artistic Licence Holdings Ltd
- Windows, Internet Explorer, and Microsoft Edge are registered trademarks or trademarks of Microsoft Corporation in the United States and other countries.
- Mac, macOS, and Safari are trademarks of Apple Inc., registered in the United States and other countries.
- IOS is a trademark or registered trademark of Cisco in the U.S. and other countries and is used under license.
- Android and Google Chrome are trademarks of Google LLC.
- Adobe, Acrobat, Flash Player, and Reader are either registered trademarks or trademarks of Adobe Systems Incorporated in the United States and/or other countries.
- Some of the fonts used in the on-screen menu are Ricoh bitmap fonts, which are manufactured and sold by Ricoh Company, Ltd.
- All other names, company names, and product names mentioned in this manual are trademarks or registered trademarks of their respective owners.

Please note that the ® and ™ symbols are not specified in this manual.

Software information regarding this product

This product incorporates the following software:

- (1) the software developed independently by or for Panasonic Corporation,
- (2) the software owned by third party and licensed to Panasonic Corporation,
- (3) the software licensed under the GNU General Public License, Version 2.0 (GPL V2.0),
- (4) the software licensed under the GNU LESSER General Public License, Version 2.1 (LGPL V2.1), and/or
- (5) open source software other than the software licensed under the GPL V2.0 and/or LGPL V2.1.

The software categorized as (3) - (5) are distributed in the hope that it will be useful, but WITHOUT ANY WARRANTY, without even the implied warranty of MERCHANTABILITY or FITNESS FOR A PARTICULAR PURPOSE.

Please refer to the detailed terms and conditions thereof shown in the “Operating Instructions – Basic Guide”. “Operating Instructions – Basic Guide” is supplied with the product.

At least three (3) years from delivery of this product, Panasonic will give to any third party who contacts us at the contact information provided below, for a charge no more than our cost of physically performing source code distribution, a complete machine-readable copy of the corresponding source code covered under GPL V2.0, LGPL V2.1 or the other licenses with the obligation to do so, as well as the respective copyright notice thereof.

Contact Information: oss-cd-request@gg.jp.panasonic.com

■ Illustrations in this manual

- Illustrations of the projector, menu screen (OSD), and other parts may vary from the actual product.
- Illustrations displayed on the computer screen may differ depending on the computer type and its operating system.
- Illustrations of the projector with the power cord attached are only examples. The shape of the supplied power cords varies depending on the country where you purchased the product.

■ Reference pages

- Reference pages in this manual are indicated as (➡ page 00).

■ Term

- In this manual, the “Wireless/wired remote control unit” accessory is referred to as “Remote control”.

Features of the Projector

High luminance & high picture quality

- ▶ In addition to high luminance of 50 000 lm*¹ and high contrast of 20 000:1*², this projector has realized wide color gamut covering approximately 90 % of the DCI-P3 standard. HDR (High Dynamic Range) is also supported, allowing higher quality image content to be reproduced as a projected image.

*1 When the power supply of AC 200 V to 240 V is used and [OPERATING MODE] is set to [NORMAL]

*2 When [DYNAMIC CONTRAST] is set to [3]

Easy and highly flexible setup

- ▶ Adopted the Interface Board method that flexibly supports various customer systems for the video signal input. In addition, by supporting Art-Net, etc., it has superior compatibility with the devices other than projectors. This projector has also realized compact all-in-one body even being a 50 000 lm class. More advanced rendition in wide range of usage is possible by supporting projection in all 360° direction, etc.

Long life and high reliability

- ▶ In addition to adopting the solid-state light source with long life, the projector has enhanced the dust resistance property of the optical unit that is sensitive to dust. By eliminating the filter, the maintenance cost for long-term operation is reduced.

Quick Steps

For details, refer to the corresponding pages.

1. **Set up the projector.**
(➔ page 40)



2. **Attach the projection lens (optional).**
(➔ page 49)



3. **Connect with external devices.**
(➔ page 52)



4. **Connect the power cord.**
(➔ page 59)



5. **Switch on the projector.**
(➔ page 61)



6. **Make initial settings.**
(➔ page 62)
Execute the lens calibration.
(➔ page 73)

- Take this step when you switch on the power for the first time after purchasing the projector.



7. **Select the input signal.**
(➔ page 69)



8. **Adjust the image.**
(➔ page 71)

Chapter 1 Preparation

This chapter describes things you need to know or check before using the projector.

Precautions for use

Intended use of the product

The purpose of the projector is to project a video signal from imaging equipment or a computer on a screen or other surface as a still image or moving image.

Installation and handling of the laser product (for USA and Canada)

■ For permanent Installation

- Installation of the projector shall be performed by a technician trained by Panasonic.
- The variance application to the U.S. Food and Drug Administration (FDA variance application) will be performed by Panasonic. The person responsible of the device or usage shall store the original or a copy of the FDA variance approval letter received from Panasonic.

■ For temporary installation

- Installation of the projector shall be performed by a technician trained by Panasonic.
- Owner of the projector or the person responsible of usage such as the promotor of the show shall apply for FDA variance and acquire the approval letter.
- The variance holder who has acquired the FDA variance approval letter must submit the “installation checklist” required by FDA to Panasonic.
- Variance holder shall create and store a document recording the information such as the location of the use, dates of the use, users of the projector.

■ For use

- This projector is categorized as the risk group 3 of IEC 62471-5:2015.
- Do not enter within the hazard distance (within RG3 range), refer to “Hazard distance (IEC 62471-5:2015)” (→ page 9).
- Assign a person responsible of the device when using the projector. The person responsible shall be trained by Panasonic before starting to use the projector.

Note

- Information such as training, FDA variance application, installation checklist, usage recording document can be confirmed by accessing following URL.
<https://eww.pavc.panasonic.co.jp/projector/extranet/index.html>

Cautions when transporting

- Transport the projector with four or more people. Failure to do so may drop the projector, which may result in damage or deformation of the projector, or injury.
- When transporting the projector, hold it securely by its handle on the outer perimeter of the projector and avoid excessive vibration and impact. Failure to do so may cause a failure due to the damaged internal components.
- Do not transport the projector with the adjustable feet extended. Doing so may damage the adjustable feet.

Cautions when installing

■ Do not set up the projector outdoors.

The projector is designed for indoor use only.

■ Do not set up the projector in the following locations.

- Places where vibration and impacts occur such as in a car or vehicle: Doing so may cause damage to internal components or malfunction.
- Location close to sea or where corrosive gas may occur: The projector may fall due to corrosion. Also, failure to do so may shorten the life of the components and result in malfunctions.
- Near the exhaust of an air conditioner: Depending on the conditions of use, the screen may fluctuate in rare cases due to the heated air from the exhaust vent or the hot or cooled air from the air conditioner. Make sure that the exhaust from the projector or other equipment, or the air from the air conditioner does not blow toward the front of the projector.

- Places with sharp temperature fluctuations such as near lights (studio lamps): Doing so may shorten the life of the light source, or result in deformation of the projector due to heat, which may cause malfunctions.
Follow the operating environment temperature of the projector.
- Near high-voltage power lines or near motors: Doing so may interfere with the operation of the projector.
- Places where there is high-power laser equipment: Directing a laser beam onto the projection lens surface causes damage to the DLP chips.

■ **Ask a qualified technician or your dealer to do installation work such as mounting the projector on the ceiling, including installation work that uses eyebolts.**

To ensure projector performance and security, ask a qualified technician or your dealer when installing the projector in a method other than the floor installation or when installing the projector in a high place.

■ **Ask a qualified technician or your dealer to install the cable wiring for DIGITAL LINK connection.**

Image and sound may be disrupted if cable transmission characteristics cannot be obtained due to inadequate installation.

■ **The projector may not work properly due to strong radio wave from the broadcast station or the radio.**

If there is any facility or equipment which outputs strong radio waves near the installation location, install the projector at a location sufficiently far from the source of the radio waves. Or, wrap the LAN cable connected to the <DIGITAL LINK> terminal using a piece of metal foil or a metal pipe which is grounded at both ends.

■ **Focus adjustment**

The high clarity projection lens is thermally affected by the light from the light source, making the focus unstable in the period just after switching on the power.

It is recommended to perform the focus adjustment after 30 minutes have elapsed with the focus test pattern displayed. For details of the test pattern, refer to “[TEST PATTERN] menu” (➔ page 181) .

■ **Do not install the projector at an altitude of 4 200 m (13 780') or higher above sea level.**

■ **Do not use the projector in a location where the ambient temperature exceeds 45 °C (113 °F).**

Using the projector in a location where the altitude is too high or the ambient temperature is too high may reduce the life of the components or result in malfunctions.

Upper limit of the operating environment temperature varies depending on the altitude above sea level.

When using the projector at an altitude between 0 m (0') and 1 400 m (4 593') above sea level: 0 °C (32 °F) to 45 °C (113 °F)

When using the projector at an altitude between 1 400 m (4 593') and 4 200 m (13 780') above sea level: 0 °C (32 °F) to 40 °C (104 °F)

Do not use the projector in a location where the ambient temperature exceeds 40 °C (104 °F) regardless of the altitude when the optional Wireless Module (Model No.: AJ-WM50 Series) is attached to the projector.

■ Projection in all 360° direction is possible.

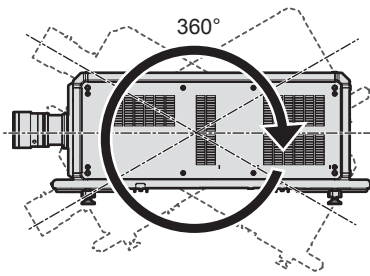

360° vertically

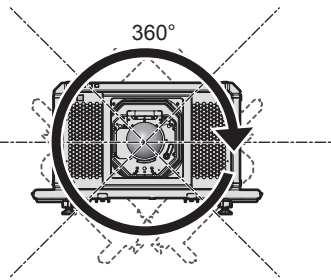

360° horizontally

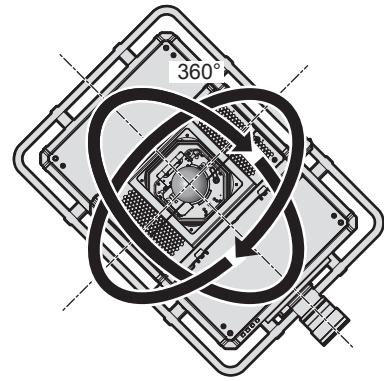

360° tilted
(combination of vertical and horizontal)

■ The geometric adjustment is disabled when projecting an image in simultaneous format or image with high frame rate.

The geometric adjustment function cannot be used when the video signal in simultaneous format or the video signal with vertical scanning frequency of 100 Hz or 120 Hz is input.

When projecting an image in simultaneous format or an image with vertical scanning frequency of 100 Hz or 120 Hz, install the projector following the instructions below so that distortion does not occur in the projected image.

- Use a flat screen.
- Install the projector so that the front side of the projector is parallel to the screen.
- Install the projector so that the image can be projected within the lens shift adjustment range.

Cautions when setting up the projector

- Install the projector in a place or with a mount that can sufficiently tolerate the weight. The position of the projected image may shift if the strength is not sufficient.
- Use the adjustable feet only for the floor standing installation and for adjusting the angle. Using them for other purposes may damage the projector.
- The adjustable feet can be removed if not needed in the installation. However, do not use the screw holes where the adjustable feet were removed to fix the projector to a mount.
Do not insert any screws other than the eyebolts for the installation work into the screw holes of the removed adjustable feet. Do not insert the removed adjustable feet into other M10 screw holes.
- Do not fix the projector to a mount with the screw holes for eyebolts (4 locations on each side) on the top side, right and left sides, and back side.
- When installing and using the projector in a method other than the floor installation using the adjustable feet, remove the adjustable feet (4 locations) and use the six screw holes to fix the projector to a mount (as shown in the figure).

For the screws to fix the projector, use commercially available ISO 898-1 standard screws (made of carbon steel or alloy steel).

(Screw diameter: M10, thread engagement length: 18 mm (23/32") or more, tapping depth inside the projector: 30 mm (1-3/16"))

In such case, make sure that there is no clearance between the screw holes for ceiling mount on the projector bottom and the setting surface by inserting spacers (metallic) between them.

- Use a torque screwdriver or Allen torque wrench to tighten the fixing screws to their specified tightening torques. Do not use electric screwdrivers or impact screwdrivers.

(Screw tightening torque: $20 \pm 1 \text{ N}\cdot\text{m}$)

Unit: mm

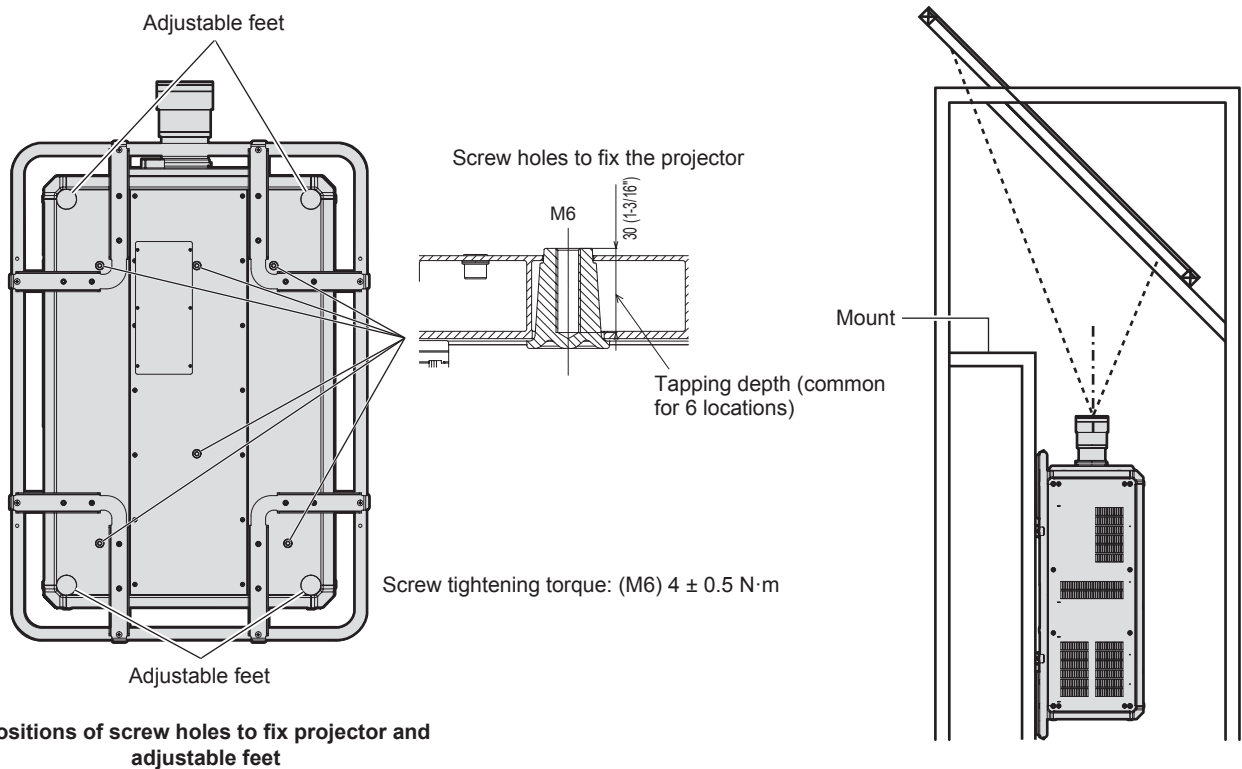

- Do not stack three or more projectors.
- Do not use the projector supporting it by the top.
- Do not block the intake/exhaust vents of the projector.
- Prevent hot and cool air from the air conditioning system to blow directly to the intake/exhaust vents of the projector.

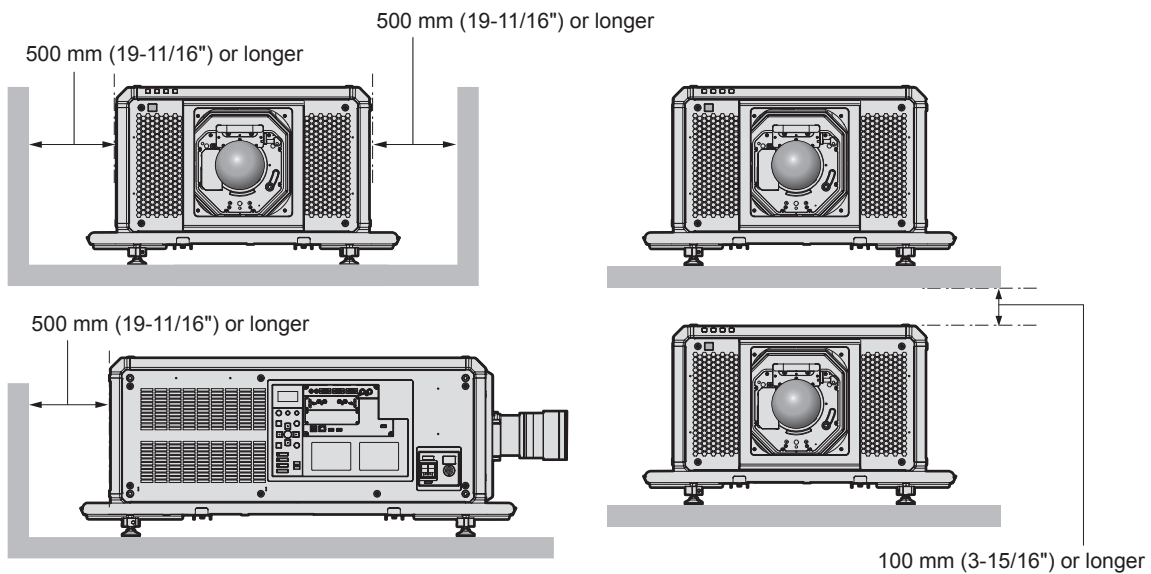
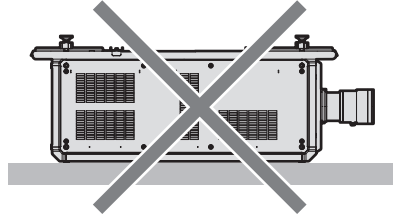
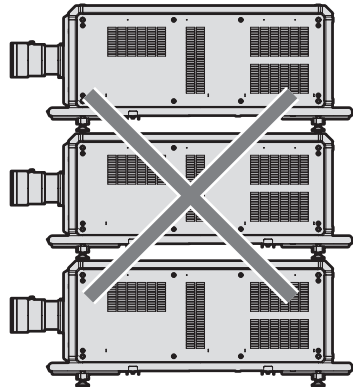

- Do not install the projector in a confined space.
When installing the projector in a confined space, provide air conditioning or ventilation separately. Exhaust heat may accumulate when the ventilation is not enough, triggering the protection circuit of the projector.
- Panasonic takes no responsibility for any damage to the product caused by an inappropriate choice of location for installing the projector, even if the warranty period of the product has not expired.

■ Cautions when conducting lifting work

- Use the eyebolts only when temporarily lifting the projector such as when installing the projector.
- Use ISO 3266 standard eyebolts (commercially available) for the M10 with an underhead length of 18 mm (23/32") to 30 mm (1-3/16"). Also use ISO standard parts for other components to lift the projector (wires, etc.).
- Lift the projector using the eyebolts attached to 4 locations on the same plane.
- Set the lifting angle to 60° or more.

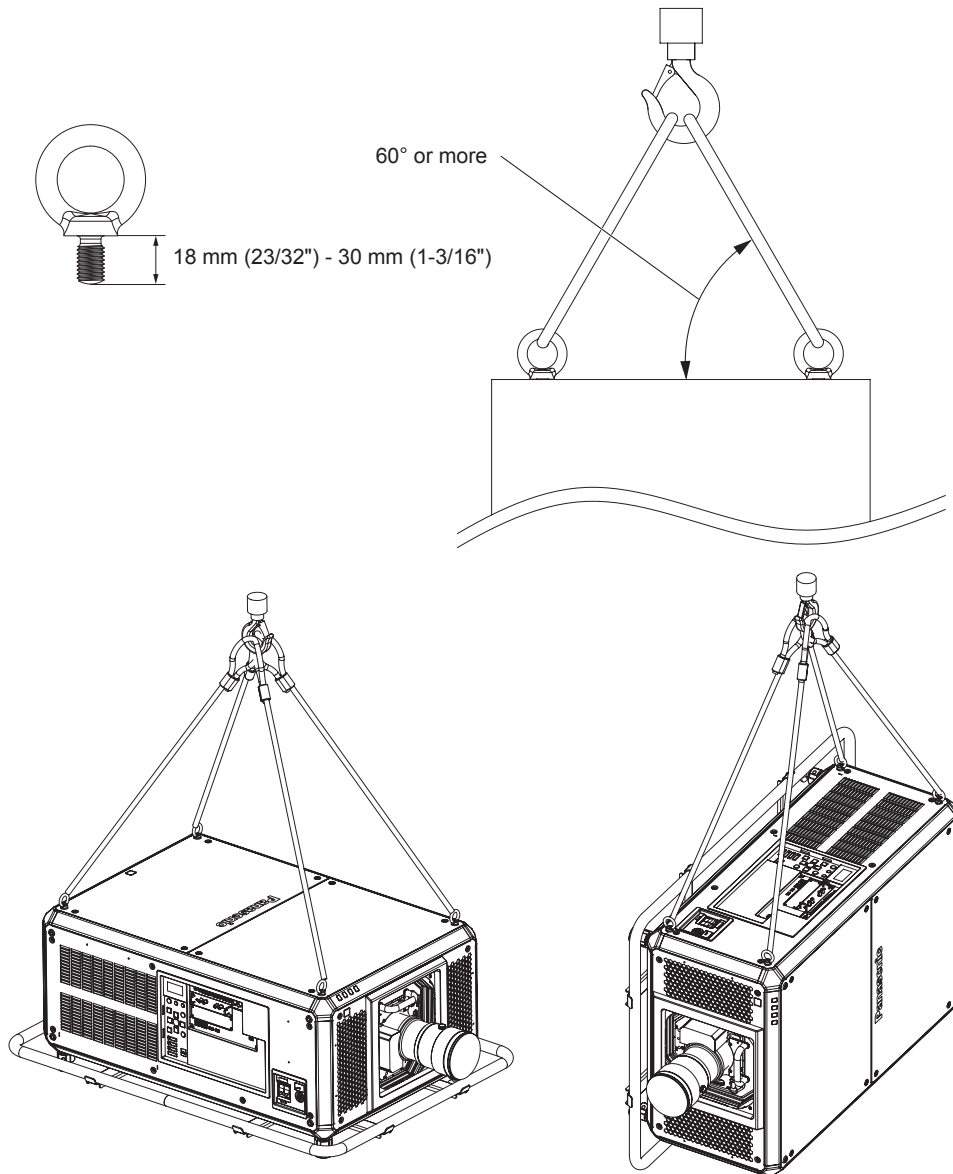

Security

When using this product, take safety measures against the following incidents.

- Personal information being leaked via this product
- Unauthorized operation of this product by a malicious third party
- Interfering or stopping of this product by a malicious third party

Take sufficient security measures.

- Make your password difficult to guess as much as possible.
- Change your password periodically. A password can be set in the [SECURITY] menu → [SECURITY PASSWORD CHANGE].
- Panasonic Corporation or its affiliate companies will never ask for your password directly. Do not divulge your password in case you receive such inquiries.
- The connecting network must be secured by a firewall, etc.
- Set a password for the web control and restrict the users who can log in. A password for the web control can be set in the [Change password] page of the web control screen.

■ Security when using the wireless LAN product

The advantage of a wireless LAN is that information can be exchanged between a computer or other such equipment and a wireless access point using radio waves, instead of using a LAN cable, as long as you are within range for radio transmissions.

On the other hand, because the radio wave can travel through an obstacle (such as a wall) and is accessible from anywhere within a given range, following problems may occur if security setting is insufficient.

- Transmitted data may be intercepted

A malicious third part may intentionally intercept radio waves and monitor the following transmitted data.

- Personal information such as your ID, password, credit card number
- Content of an Email

- Illegally accessed

A malicious third party may access your personal or corporate network without authorization and engage in the following types of behavior.

- Retrieve personal and/or secret information (information leak)
- Spread false information by impersonating a particular person (spoofing)
- Overwrite intercepted communications and issue false data (tampering)
- Spread harmful software such as a computer virus and crash your data and/or system (system crash)

Since most wireless LAN adapters or access points are equipped with security features to take care of these problems, you can reduce the possibility of these problems occurring when using this product by making the appropriate security settings for the wireless LAN device.

Some wireless LAN devices may not be set for security immediately after purchase. To decrease the possibility of occurrence of security problems, be sure to make all security related settings according to the operation instructions supplied with each wireless LAN device before using a wireless LAN device.

Depending on the specifications of the wireless LAN, a malicious third party may be able to break security settings by special means.

Panasonic asks customers to thoroughly understand the risk of using this product without making security settings, and recommends that the customers make security settings at their own discretion and responsibility.

■ Notes regarding the wireless LAN

Radio wave in the 2.4 GHz band is used when the wireless LAN connection function of the projector is used. The license of wireless station is not required, but understand the following when using.

To use the wireless LAN function with the projector, it is necessary to attach the optional Wireless Module (Model No.: AJ-WM50 Series).

■ Do not use close to other wireless devices.

Following devices may be using radio wave in the same bandwidth as the projector. Using the projector close to these devices may cause the communication to be disabled or the communication speed to slow down due to interference of radio wave.

- Microwave oven, etc.
- Industrial, scientific, or medical devices, etc.
- In-plant wireless station for identifying moving vehicles used in the manufacturing lines at a plant
- Specified low power wireless station

■ Do not use cell phone, television, or radio as much as possible close to the projector.

Cell phone, television, or radio is using radio wave with different bandwidth from the projector, so there is no effect on the wireless LAN communication or the send/receive on these devices. However, noise may occur in the audio or video due to the radio wave from the projector.

■ Radio wave for wireless LAN communication does not go through the reinforcing bars, metal, or concrete.

The projector can communicate through wall or floor made of wood or glass (excluding the glass with metal mesh embedded), but it cannot communicate through wall or floor made of reinforcing bars, metal, or concrete.

■ **Do not use the projector as much as possible in a location where static electricity is generated.**

The communication via wireless LAN or wired LAN may be prone to disruption when the projector is used in a location where static electricity or noise is generated.

There is a rare case that the LAN connection may not be established due to static electricity or noise, so in such case, turn off the projector, remove the source of problematic static electricity or noise, and turn the projector back on.

DIGITAL LINK

“DIGITAL LINK” is a technology to transmit the video, audio, Ethernet, and serial control signals using a twisted pair cable by adding unique functions by Panasonic to the HDBaseT™ communication standard formulated by HDBaseT Alliance.

This projector supports the optional Panasonic DIGITAL LINK output supported device (Model No.: ET-YFB100G, ET-YFB200G) and peripheral devices by other manufacturers (twisted-pair-cable transmitters such as the “XTP transmitter” of Extron Electronics) that use the same HDBaseT™ standard. For the devices of other manufacturers that the operation has been verified with this projector, visit the Panasonic website (<https://panasonic.net/cns/projector/>). Note that the verification for devices of other manufacturers has been made for the items set by Panasonic Corporation, and not all the operations have been verified. For operation or performance problems caused by the devices of other manufacturers, contact the respective manufacturers. This projector does not support audio transmission because it is not equipped with audio function.

Art-Net

“Art-Net” is an Ethernet communication protocol based on the TCP/IP protocol.

By using the DMX controller and the application software, illumination and stage system can be controlled. Art-Net is made based on DMX512 communication protocol.

Application software supported by the projector

The projector supports following application software. For details or downloading application software other than the “Geometric & Setup Management Software”, visit the Panasonic website (<https://panasonic.net/cns/projector/>).

- **Logo Transfer Software**

This application software transfers the original image, such as company logo, which is projected at the start, to the projector.

- **Smart Projector Control**

This application software sets and adjusts the projector connected via LAN using a smartphone or a tablet.

- **Multi Monitoring & Control Software**

This application software monitors and controls the multiple display devices (projector and flat panel display) connected to an intranet.

- **Early Warning Software**

This plug-in software monitors the status of the display devices and their peripherals within an intranet, and notifies of abnormality of such equipment and detects the signs of possible abnormality. “Early Warning Software” is pre-installed in the “Multi Monitoring & Control Software”. To use the early warning function of this plug-in software, install “Multi Monitoring & Control Software” in the PC to be used. By enabling the early warning function, it will notify of the approximate time to replace the consumables for the display devices, to clean each part of the display devices, and to replace the components of the display devices, allowing to execute maintenance in advance.

The early warning function can be used by registering maximum of 2048 display devices free of charge for 90 days after installing the “Multi Monitoring & Control Software” into a PC. To continuously use after the 90 days, it is necessary to purchase the license of “Early Warning Software” (ET-SWA100 Series) and perform the activation. Also, depending on the type of license, the number of display devices that can be registered for monitoring varies. For details, refer to the Operating Instructions of “Multi Monitoring & Control Software”.

- **Geometric & Setup Management Software (Geometry Manager Pro)**

This application software performs detailed corrections and adjustments such as the geometric adjustment which cannot be covered by the projector settings in real-time. Also, the geometric adjustment and edge blending matching the shape of the screen using a camera, and the adjustment of color and luminance can be automatically performed with simple steps.

“Geometric & Setup Management Software” can be downloaded from the Panasonic website (<https://panasonic.net/cns/projector/pass/>). It is necessary to register and login to PASS*1 to download.

*1 PASS: Panasonic Professional Display and Projector Technical Support Website
For details, visit the Panasonic website (<https://panasonic.net/cns/projector/pass/>).

Storing

To store the projector, store in a dry room.

Disposal

To dispose of the product, ask your local authorities or dealer for correct methods of disposal. Also, dispose of the product without disassembling.

Cautions on use

■ To get a good picture quality

In order to view a beautiful image in higher contrast, prepare an appropriate environment. Draw curtains or blinds over windows and turn off any lights near the screen to prevent outside light or light from indoor lamps from shining onto the screen.

■ Do not touch the surface of the projection lens with your bare hands.

If the surface of the projection lens becomes dirty from fingerprints or anything else, this will be magnified and projected onto the screen.

Attach the supplied lens cover to the optional projection lens when not using the projector.

■ DLP chips

- The DLP chips are precision-made. Note that in rare cases, pixels of high precision could be missing or always lit. Such a phenomenon does not indicate malfunction.
- Directing a high-power laser beam onto the projection lens surface can damage the DLP chips. By closing the mechanical shutter built into the projector, it can prevent damaging of the DLP chips by a high-power laser beam while using the shutter function (shutter: closed). To close the mechanical shutter while using the shutter function, set [MECHANICAL SHUTTER] to [ENABLE]. For details of the setting, refer to the [DISPLAY OPTION] menu → [SHUTTER SETTING].

■ Do not move the projector or subject it to vibration or impact while it is operating.

Doing so may shorten the life of the built-in motor.

■ Light source

The light source of the projector uses laser diode, and has the following characteristics.

- Depending on the operating environment temperature, the luminance of the light source will decrease. The higher the temperature becomes, the more the luminance of the light source decreases.
- The luminance of the light source will decrease by duration of usage. If brightness is noticeably reduced and the light source does not turn on, ask your dealer to clean inside the projector or replace the light source unit.

■ Computer and external device connections

When connecting a computer or an external device, read this manual carefully regarding the use of power cords and shielded cables as well.

■ Slots

This projector is equipped with two SLOT NX-specification slots.

The input for HDMI, DVI-D, and SDI can be added by installing the optional Interface Board in the slot.

The supplied Interface Board for 12G-SDI (Model No.: ET-MDN12G10) is already installed in one of the slots.

“SLOT NX” is a name of the slot unique to Panasonic supporting the signal input for the 4K image.

Accessories

Make sure that the following accessories are provided with your projector. Numbers enclosed in < > show the number of accessories.

Wireless/wired remote control unit <1>
(N2QAYB001176)



(K2CG3YY00220): for 100 V - 120 V

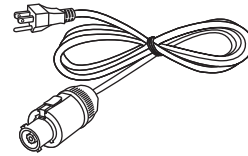

Lens hole cover <1>
(DPHR1165ZA/X1)

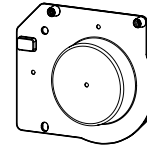

Power cord

(K2CZ3YY00085): for 200 V - 240 V

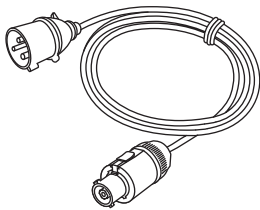

(Attached to the product at the time of purchase)

(K2CZ3YY00084): for 200 V - 240 V

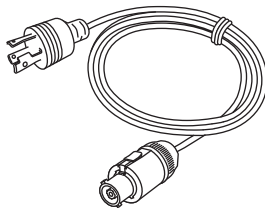

Interface Board for 12G-SDI <1>
(ET-MDN12G10)

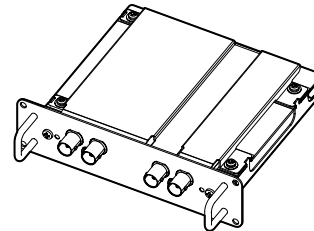

(Attached to the product at the time of purchase)

AA/R6 or AA/LR6 battery <2>

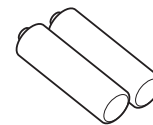

(For remote control unit)

Attention

- After unpacking the projector, discard the power cord cap and packaging material properly.
- Do not use the supplied power cord for devices other than this projector.
- For missing accessories, consult your dealer.
- Store small parts in an appropriate manner, and keep them away from small children.

Note

- The supplied Interface Board for 12G-SDI (ET-MDN12G10) is already installed in <SLOT 1> at the time of purchase.
- The type and number of the supplied power cords vary depending on the country or region where you purchased the product.
- The model numbers of accessories are subject to change without prior notice.

Optional accessories

Optional accessories (product name)		Model No.
Projection lens	Zoom Lens	ET-D3QW300, ET-D3QS400, ET-D3QT500, ET-D3QT600, ET-D3QT700, ET-D3QT800
Interface Board	Interface Board for HDMI 2 input	ET-MDNHM10
	Interface Board for DVI-D 2 input	ET-MDNDV10
	Interface Board for 12G-SDI	ET-MDN12G10
	Interface Board for DisplayPort 2 input	ET-MDNDP10
Wireless Module*1		AJ-WM50 Series*2
Early Warning Software (Basic license/3-year license)		ET-SWA100 Series*3
NFC Upgrade Kit*1		ET-NUK10
Digital Interface Box		ET-YFB100G
DIGITAL LINK Switcher		ET-YFB200G

*1 The availability of this product varies depending on the country. For details, contact your dealer.

*2 The suffix of the Model No. differs depending on the country.

Example of the Model No. with suffix for AJ-WM50 Series

AJ-WM50E, AJ-WM50G1, AJ-WM50G2, AJ-WM50GAN, AJ-WM50GPX, AJ-WM50P

*3 The suffix of the Model No. differs according to the license type.

Note

- Use the Wireless Module (Model No.: AJ-WM50 Series) in an environment of 0 °C (32 °F) to 40 °C (104 °F), including when it is attached to the projector.
- When performing the simultaneous input of the 4K image (resolution of 3 840 x 2 160 or 4 096 x 2 160) using the Interface Board for HDMI 2 input (Model No.: ET-MDNHM10), it is necessary for the firmware version of the Interface Board for HDMI 2 input to be 2.00 or later. If the version is earlier than 2.00, the simultaneous process is not performed even if corresponding signal is input. Consult your dealer regarding the version update to the latest firmware.
For details on how to confirm the firmware version, refer to “How to confirm the firmware version of the Interface Board” (➡ page 36).
- The optional NFC Upgrade Kit (Model No.: ET-NUK10) can be used to enable the NFC function of the projector. Note that there are some models that have the NFC function enabled from the time of factory shipment, and there are some countries or regions where the NFC Upgrade Kit cannot be applied.
For the availability of the NFC function in the country or region where you purchased the product, visit the Panasonic website (<https://panasonic.net/cns/projector/>) or consult your dealer.
- The model numbers of optional accessories are subject to change without prior notice.
- The optional accessories compatible with the projector may be added or changed without prior notice. The optional accessories described in this document are as of November 2019.
For the latest information, visit the Panasonic website (<https://panasonic.net/cns/projector/>).

About your projector

Remote control

■ Front

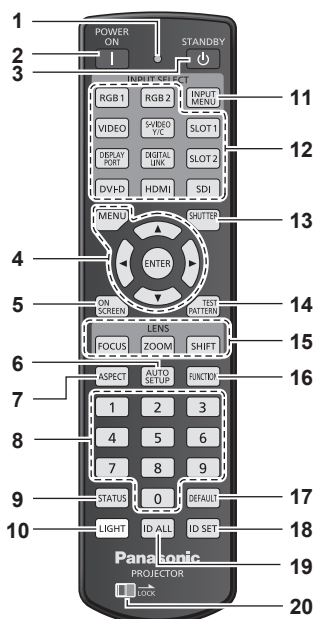

■ Top

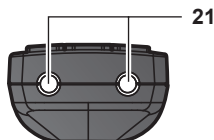

■ Bottom

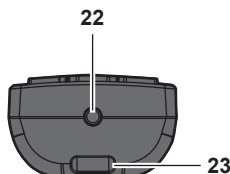

A strap can be attached depending on the usage.

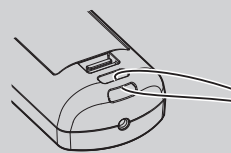

- 1 Remote control indicator**
Blinks if any button in the remote control is pressed.
- 2 Power on <|> button**
Sets the projector to projection mode when the <MAIN POWER> switch on the projector is set to <ON> and the power is turned off (standby mode).
- 3 Power standby <⏻> button**
Sets the projector to the state where the projector is turned off (standby mode) when the <MAIN POWER> switch on the projector is set to <ON> and in projection mode.
- 4 <MENU> button/<ENTER> button/▲▼◀▶ buttons**
Used to navigate through the menu screen. (➔ page 84)
- 5 <ON SCREEN> button**
Switches the on-screen display function on (display) or off (hide). (➔ page 79)
- 6 <AUTO SETUP> button**
Automatically adjusts the image display position and signal level while projecting the image.
[PROGRESS] is displayed while in automatic adjustment. (➔ page 80)
- 7 <ASPECT> button**
Switches the aspect ratio of the image. (➔ page 80)
- 8 Number (<0> - <9>) buttons**
Used for entering an ID number or a password in a multiple projector environment.
- 9 <STATUS> button**
Displays the projector information.
- 10 <LIGHT> button**
Pressing this button lights up the remote control buttons. The lights will go off when the remote control operation goes idle for 10 seconds.
- 11 <INPUT MENU> button**
Displays the input selection screen. (➔ page 71)
- 12 Input selection buttons (<SDI>, <DIGITAL LINK>, <HDMI>, <DVI-D>, <DISPLAYPORT>, <SLOT 1>, <SLOT 2>)**
Switches the input signal to project. (➔ page 69)
<HDMI> button, <DVI-D> button, <DISPLAYPORT> button, <SLOT 1> button, and <SLOT 2> button can be used when the optional Interface Board equipped with corresponding input is installed in the slot on the projector.
Following buttons are not used with this projector.
<RGB1> button, <RGB2> button, <VIDEO> button, <S-VIDEO Y/C> button
- 13 <SHUTTER> button**
Used to temporarily turn off the image. (➔ page 79)
- 14 <TEST PATTERN> button**
Displays the test pattern. (➔ page 81)
- 15 Lens buttons (<FOCUS>, <ZOOM>, <SHIFT>)**
Adjusts the focus, zoom, and lens shift. (➔ page 71)
- 16 <FUNCTION> button**
Assigns a frequently used operation as a shortcut button. (➔ page 80)
When the <FUNCTION> button is held down, the [FUNCTION BUTTON] screen is displayed. (➔ page 172)
- 17 <DEFAULT> button**
Resets the setting of the displayed sub-menu to the factory default. (➔ page 85)
- 18 <ID SET> button**
Sets the ID number of the remote control in a multiple projector environment. (➔ page 37)
- 19 <ID ALL> button**
Used to simultaneously control all the projectors with a single remote control in a multiple projector environment. (➔ page 37)
- 20 <LOCK> button**
Used to prevent unintended operation by careless pressing of the buttons and prevent draining the remote control batteries. Operation of each button on the remote control is disabled by sliding the <LOCK> button toward the arrow.
- 21 Remote control signal transmitter**

22 Remote control wired terminal

This is a terminal used to connect to the projector via a cable when the remote control is used as a wired remote control.

(➔ page 38)

23 Strap hole

Attention

- Do not drop the remote control.
- Avoid contact with liquids or moisture.
- Do not attempt to modify or disassemble the remote control.
- Do not swing the remote control holding onto the strap when a strap is attached.
- Observe the following instructions that are indicated on the caution label at the back of the remote control:
 - Do not use old battery with new one.
 - Do not use batteries other than the type specified.
 - Be sure the batteries are inserted properly.

For other instructions, read the instructions related to batteries that are described in “Read this first!”.

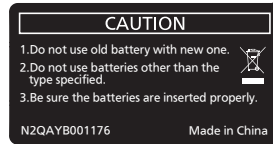

Caution label at the back of the remote control

Note

- When operating the remote control by directly pointing the remote control signal receiver of the projector, operate the remote control at a distance approx. 30 m (98'5") or shorter from the remote control signal receiver. The remote control can control at angles of up to $\pm 15^\circ$ vertically and $\pm 30^\circ$ horizontally, but the effective control range may be reduced.
- If there are any obstacles between the remote control and the remote control signal receiver, the remote control may not operate properly.
- The signal will be reflected off the screen. However, the operating range may be limited from light reflection loss due to the screen material.
- If the remote control signal receiver directly receives strong light, such as fluorescent light, the remote control may not operate properly. Use it in a place distant from the light source.
- The power indicator <ON (G)/STANDBY (R)> will blink if the projector receives a remote control signal.

Projector body

■ Front

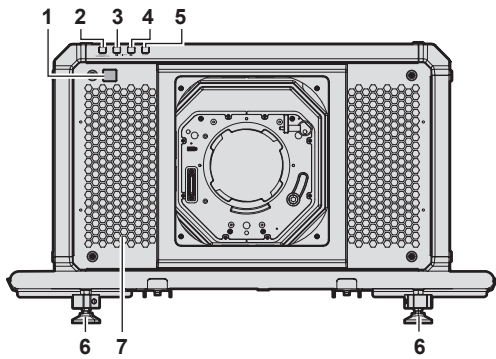

■ Side

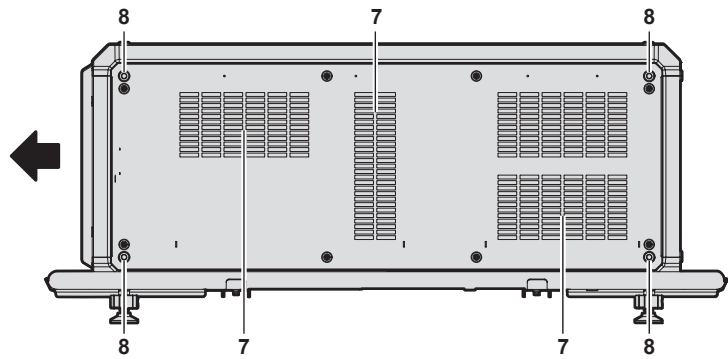

■ Rear

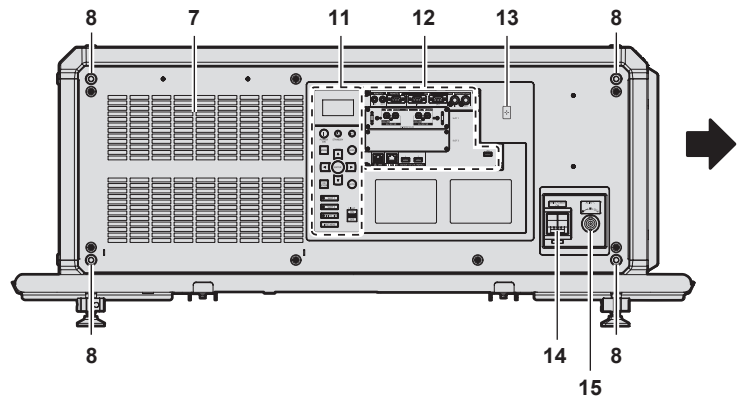
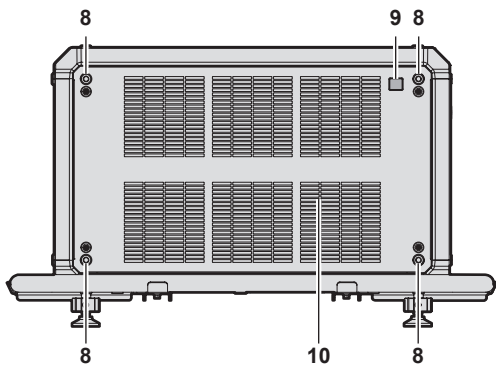

← : Projection direction

- | | |
|---|---|
| <p>1 Remote control signal receiver (front)</p> <p>2 Power indicator <ON (G)/STANDBY (R)>
Indicates the status of the power.</p> <p>3 Light source indicator <LIGHT1>
Indicates the status of light source 1.</p> <p>4 Light source indicator <LIGHT2>
Indicates the status of light source 2.</p> <p>5 Temperature indicator <TEMP>
Indicates the internal temperature status.</p> <p>6 Adjustable feet
Adjusts the projection angle.</p> <p>7 Intake vent</p> <p>8 Screw holes for eyebolts
Screw diameter: M10, tapping depth inside the projector:
35 mm (1-3/8")</p> | <p>9 Remote control signal receiver (rear)</p> <p>10 Exhaust vent</p> <p>11 Control panel (⇒ page 33)</p> <p>12 Connecting terminals (⇒ page 34)</p> <p>13 NFC touch point
This is the touch point when using the near field communication (NFC, Near Field Communication) function. A device such as a smartphone equipped with the NFC function can be connected to the projector by holding it near the touch point.</p> <p>14 <MAIN POWER> switch
Turns on/off the main power.</p> <p>15 <AC IN> terminal
Connect the supplied power cord.</p> |
|---|---|

■ Top

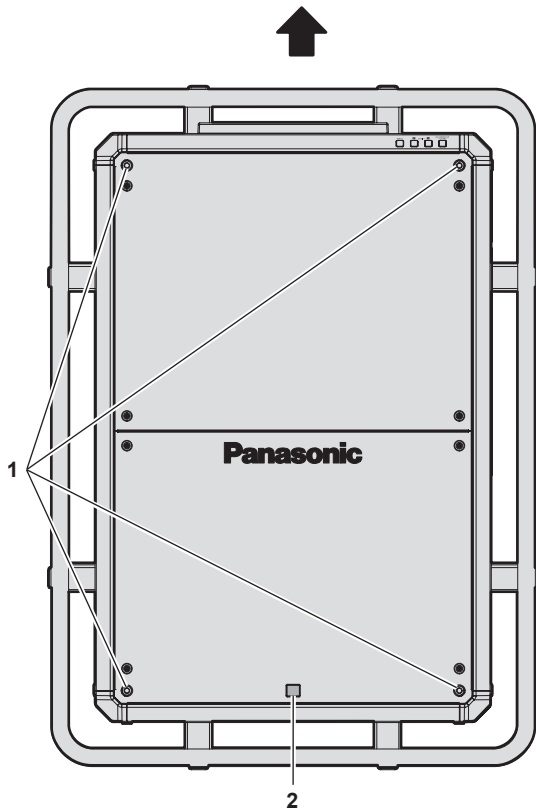

■ Bottom

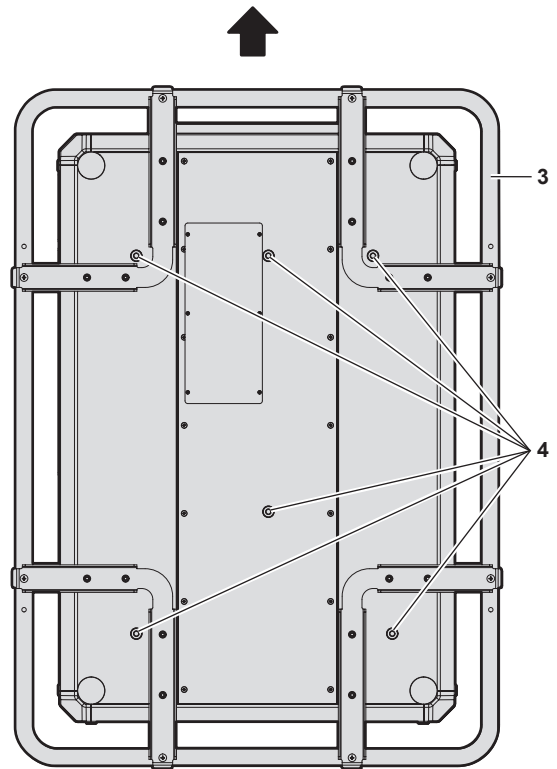

← : Projection direction

WARNING

- Do not touch the top surface of the projector during use.**
- Doing so may result in burns, as the top surface is hot during use and for a while after use.

- 1 Screw holes for eyebolts**
Screw diameter: M10, tapping depth inside the projector: 35 mm (1-3/8")
- 2 Remote control signal receiver (top)**
- 3 Handle**
Hold the handle with your hand when carrying the projector.
- 4 Screw holes to fix the projector**
Screw diameter: M10, tapping depth inside the projector: 30 mm (1-3/16")

Attention

- Do not block the intake/exhaust vents of the projector.

Note

- The optional NFC Upgrade Kit (Model No.: ET-NUK10) can be used to enable the NFC function of the projector. Note that there are some models that have the NFC function enabled from the time of factory shipment, and there are some countries or regions where the NFC Upgrade Kit cannot be applied.
For the availability of the NFC function in the country or region where you purchased the product, visit the Panasonic website (<https://panasonic.net/cns/projector/>) or consult your dealer.
- For the connection using the NFC function, use the application software "Smart Projector Control" which performs the setting and adjustment of the projector.
For details on the "Smart Projector Control", visit the Panasonic website (<https://panasonic.net/cns/projector/>).

■ Control panel

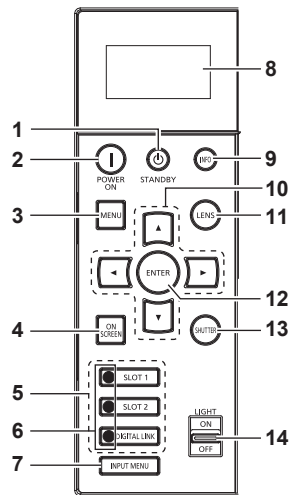

1 Power standby <⏻> button

Sets the projector to the state where the projector is turned off (standby mode) when the <MAIN POWER> switch on the projector is set to <ON> and in projection mode.

2 Power on <|> button

Sets the projector to projection mode when the <MAIN POWER> switch on the projector is set to <ON> and the power is turned off (standby mode).

3 <MENU> button

Displays or hides the main menu. (➔ page 84)
Returns to the previous menu when a sub-menu is displayed.

4 <ON SCREEN> button

Switches the on-screen display function on (display) or off (hide). (➔ page 79)

5 Input selection buttons (<SLOT 1>, <SLOT 2>, <DIGITAL LINK>)

Switches the input signal to project. (➔ page 69)
<SLOT 1> button and <SLOT 2> button can be used when the optional Interface Board is installed in the slot on the projector.

6 Input selection terminal indicator

Indicator that shows the selected input terminal. This indicator lights up when a video signal is being input to the selected terminal, and blinks when there is no video signal being input.

7 <INPUT MENU> button

Displays the input selection screen. (➔ page 71)

8 Information monitor

Displays various statuses and error information. (➔ page 229)

9 <INFO> button

Used to operate the information monitor. (➔ page 229)

10 ▲▼◀▶ buttons

Used to select items in the menu screen, change settings, and adjust levels.

Also used to enter a password in [SECURITY] or enter characters.

11 <LENS> button

Adjusts the focus, zoom, and lens shift.

12 <ENTER> button

Determines and executes an item in the menu screen.

13 <SHUTTER> button

Used to temporarily turn off the image. (➔ page 79)

14 <LIGHT> switch

This is a light switch for the connecting terminals and control panel.

■ Connecting terminals

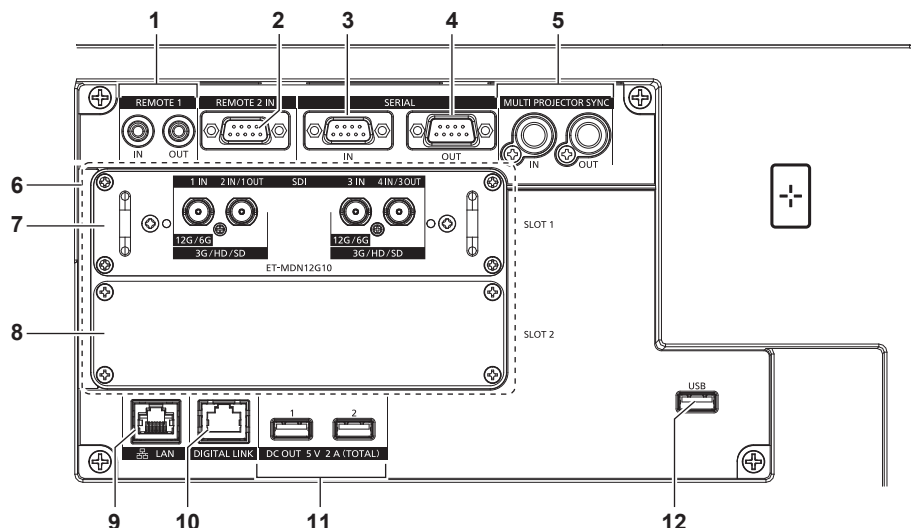

- | | |
|--|--|
| <p>1 <REMOTE 1 IN> terminal/<REMOTE 1 OUT> terminal
These are terminals to connect the remote control for serial control in a multiple projector environment.</p> <p>2 <REMOTE 2 IN> terminal
This is a terminal to remotely control the projector using the external control circuit.</p> <p>3 <SERIAL IN> terminal
This is the RS-232C compatible terminal to externally control the projector by connecting a computer.</p> <p>4 <SERIAL OUT> terminal
This is a terminal to output the signal connected to the <SERIAL IN> terminal.</p> <p>5 <MULTI PROJECTOR SYNC IN> terminal/<MULTI PROJECTOR SYNC OUT> terminal
This terminal is used to connect multiple projectors when balancing the contrast as a combined screen or synchronizing the effects using the shutter function including the fade in/fade out with a system using multiple projectors.</p> <p>6 Slots (<SLOT 1>, <SLOT 2>)
There are SLOT NX-specification slots to install the optional Interface Board internally.</p> | <p>7 Interface Board for 12G-SDI
The supplied Interface Board for 12G-SDI (Model No.: ET-MDN12G10) is already installed. (➡ page 36)</p> <p>8 Slot cover</p> <p>9 <LAN> terminal
This is the LAN terminal to connect to the network.</p> <p>10 <DIGITAL LINK> terminal
This is a terminal to connect a device that transmits video signal via the LAN terminal. Also, this is the LAN terminal to connect to the network.</p> <p>11 <DC OUT 1> terminal/<DC OUT 2> terminal
This is the USB terminal dedicated for power supply. (DC 5 V, total 2 A)
Use this terminal when a power supply is required to wireless display adapters and wireless LAN/Ethernet converters, etc.</p> <p>12 <USB> terminal
This is a terminal to connect the USB memory when using the data cloning function or firmware update function. (➡ pages 239, 243)
This is also the terminal to connect the optional Wireless Module (Model No.: AJ-WM50 Series) when the projector is connected via wireless LAN. (➡ page 200)</p> |
|--|--|

Note

- When a LAN cable is directly connected to the projector, the network connection must be made indoors.
- To transmit the Ethernet and serial control signals using the <DIGITAL LINK> terminal, set the [NETWORK CONTROL] → [TYPE SELECT] to [DIGITAL LINK] or [LAN & DIGITAL LINK].
- To transmit the Ethernet signal using the <LAN> terminal, set the [NETWORK CONTROL] → [TYPE SELECT] to [LAN] or [LAN & DIGITAL LINK].
- The <DIGITAL LINK> terminal and the <LAN> terminal are connected inside of the projector when the [NETWORK CONTROL] → [TYPE SELECT] is set to [LAN & DIGITAL LINK]. Do not directly connect the <DIGITAL LINK> terminal and the <LAN> terminal using a LAN cable. Construct the system so that it is not connected to the same network via the peripherals such as the hub or the twisted-pair-cable transmitter.
- Power can be supplied using the <DC OUT 1> terminal and the <DC OUT 2> terminal even when the projector is in the standby status.

Names and functions of the Interface Board

This projector is equipped with two SLOT NX-specification slots.

The input for HDMI, DVI-D, and SDI can be added by installing the optional Interface Board in the slot.

The supplied Interface Board for 12G-SDI (Model No.: ET-MDN12G10) is already installed in one of the slots.

The terminal name of the optional Interface Board is described with different terminal name in this document when it is installed in <SLOT 1> and when it is installed in <SLOT 2>. Refer to following information for details.

■ Interface Board for HDMI 2 input (Model No.: ET-MDNHM10)

This board supports the HDMI signal.

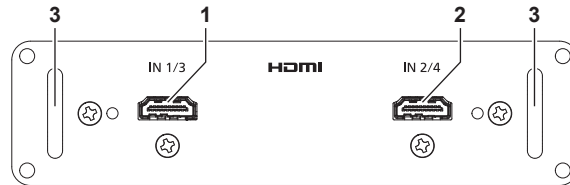

- 1 <HDMI IN 1> terminal (when installed in <SLOT 1>), <HDMI IN 3> terminal (when installed in <SLOT 2>)
This is a terminal to input HDMI signal.

- 2 <HDMI IN 2> terminal (when installed in <SLOT 1>), <HDMI IN 4> terminal (when installed in <SLOT 2>)
This is a terminal to input HDMI signal.

- 3 Handle

Note

- When performing the simultaneous input of the 4K image (resolution of 3 840 x 2 160 or 4 096 x 2 160) using the Interface Board for HDMI 2 input (Model No.: ET-MDNHM10), it is necessary for the firmware version of the Interface Board for HDMI 2 input to be 2.00 or later. If the version is earlier than 2.00, the simultaneous process is not performed even if corresponding signal is input. Consult your dealer regarding the version update to the latest firmware.

For details on how to confirm the firmware version, refer to “How to confirm the firmware version of the Interface Board” (➔ page 36).

■ Interface Board for DVI-D 2 input (Model No.: ET-MDNDV10)

This board supports the DVI-D signal.

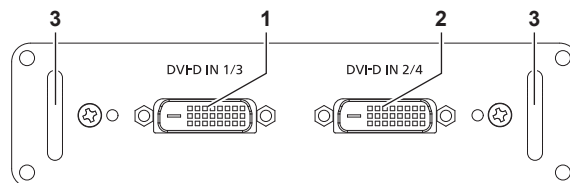

- 1 <DVI-D IN 1> terminal (when installed in <SLOT 1>), <DVI-D IN 3> terminal (when installed in <SLOT 2>)
This is a terminal to input DVI-D signal.

- 2 <DVI-D IN 2> terminal (when installed in <SLOT 1>), <DVI-D IN 4> terminal (when installed in <SLOT 2>)
This is a terminal to input DVI-D signal.

- 3 Handle

■ Interface Board for DisplayPort 2 input (Model No.: ET-MDNDP10)

This board supports the DisplayPort signal.

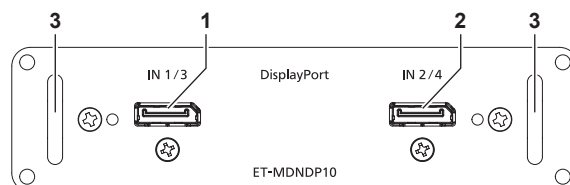

- 1 <DisplayPort IN 1> terminal (when installed in <SLOT 1>), <DisplayPort IN 3> terminal (when installed in <SLOT 2>)
This is a terminal to input DisplayPort signal.

- 2 <DisplayPort IN 2> terminal (when installed in <SLOT 1>), <DisplayPort IN 4> terminal (when installed in <SLOT 2>)
This is a terminal to input DisplayPort signal.

- 3 Handle

■ Interface Board for 12G-SDI (Model No.: ET-MDN12G10)

This board supports the HD-SDI signal, the 3G-SDI signal, the 6G-SDI signal, and the 12G-SDI signal. The operation will be the same when this board is installed in <SLOT 1> or <SLOT 2>.

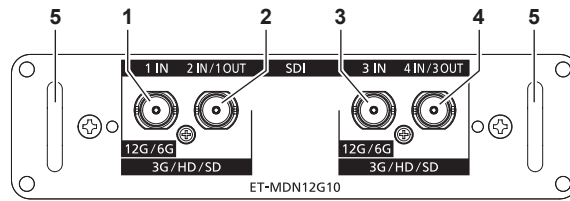

1 <SDI 1 IN> terminal

This is a terminal to input SDI signal (HD-SDI/3G-SDI/6G-SDI/12G-SDI).

2 <SDI 2 IN/1 OUT> terminal

This is a terminal to input SDI signal (HD-SDI/3G-SDI). This is also an active through terminal to output the SDI signal (HD-SDI/3G-SDI/6G-SDI/12G-SDI) input to the <SDI 1 IN> terminal of this board.

3 <SDI 3 IN> terminal

This is a terminal to input SDI signal (HD-SDI/3G-SDI/6G-SDI/12G-SDI).

4 <SDI 4 IN/3 OUT> terminal

This is a terminal to input SDI signal (HD-SDI/3G-SDI). This is also an active through terminal to output the SDI signal (HD-SDI/3G-SDI/6G-SDI/12G-SDI) input to the <SDI 3 IN> terminal of this board.

5 Handle

Note

- The <SDI 2 IN/1 OUT> terminal and the <SDI 4 IN/3 OUT> terminal do not support the input of the 6G-SDI signal or the 12G-SDI signal.
- To use the <SDI 2 IN/1 OUT> terminal or the <SDI 4 IN/3 OUT> terminal as an output terminal, set the [DISPLAY OPTION] menu → [SLOT IN] → [SDI MODE] to [OUTPUT].
- When the projector is in standby mode, a signal is not output from the <SDI 2 IN/1 OUT> terminal and the <SDI 4 IN/3 OUT> terminal.

How to confirm the firmware version of the Interface Board

■ Interface Board for HDMI 2 input (Model No.: ET-MDNHM10)

The Interface Board for HDMI 2 input with the firmware version 2.00 or later has the version displayed on the product.

The firmware version can also be confirmed in the [STATUS] screen. (➔ page 173)

Display example

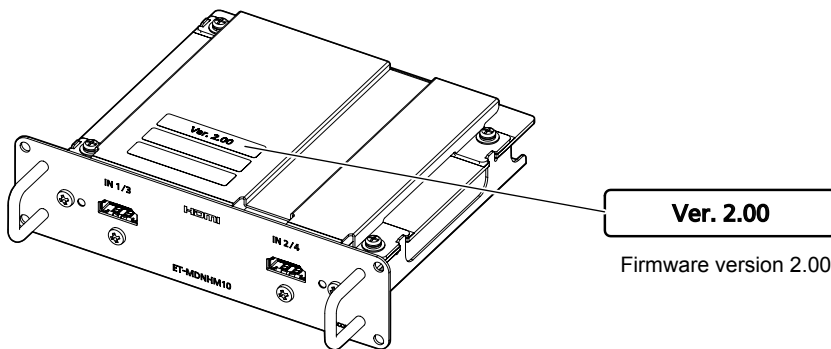

Preparing the remote control

Inserting and removing the batteries

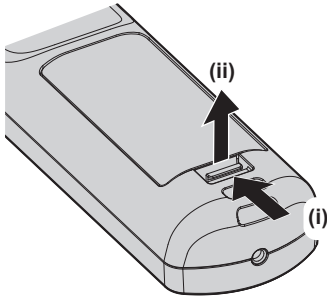

Fig. 1

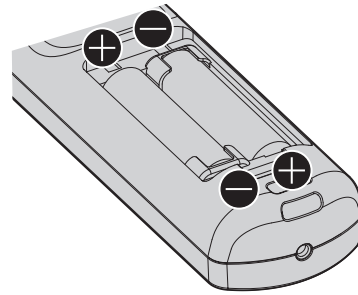

Fig. 2

- 1) Open the cover. (Fig. 1)
- 2) Insert the batteries and close the cover (insert the \ominus side first). (Fig. 2)
 - When removing the batteries, perform the steps in reverse order.

When using the multiple projectors

When you use the multiple projectors together, you can operate all the projectors simultaneously or each projector individually using single remote control, if a unique ID number is assigned to each projector.

When using the projectors by setting the ID numbers, set the ID number of the projector body after initial settings have been completed. Then, set the ID number of the remote control. For initial settings, refer to “When the initial setting screen is displayed” (➔ page 62).

The factory default ID number of the projector (projector body and remote control) is set to [ALL], so you can use it as it is. Set the ID numbers of the projector body and remote control as necessary.

For details on setting the ID number of the remote control, refer to “Setting ID number of the remote control” (➔ page 81).

Note

- Set the ID number of the projector body from the [PROJECTOR SETUP] menu → [PROJECTOR ID].

Connecting the remote control to the projector with a cable

If you control the multiple projectors with a single remote control, use commercially available M3 stereo mini jack cables to connect to the <REMOTE 1 IN>/<REMOTE 1 OUT> terminals of the projectors.

The remote control is effective even in places where an obstacle stands in the light path or where devices are susceptible to outside light.

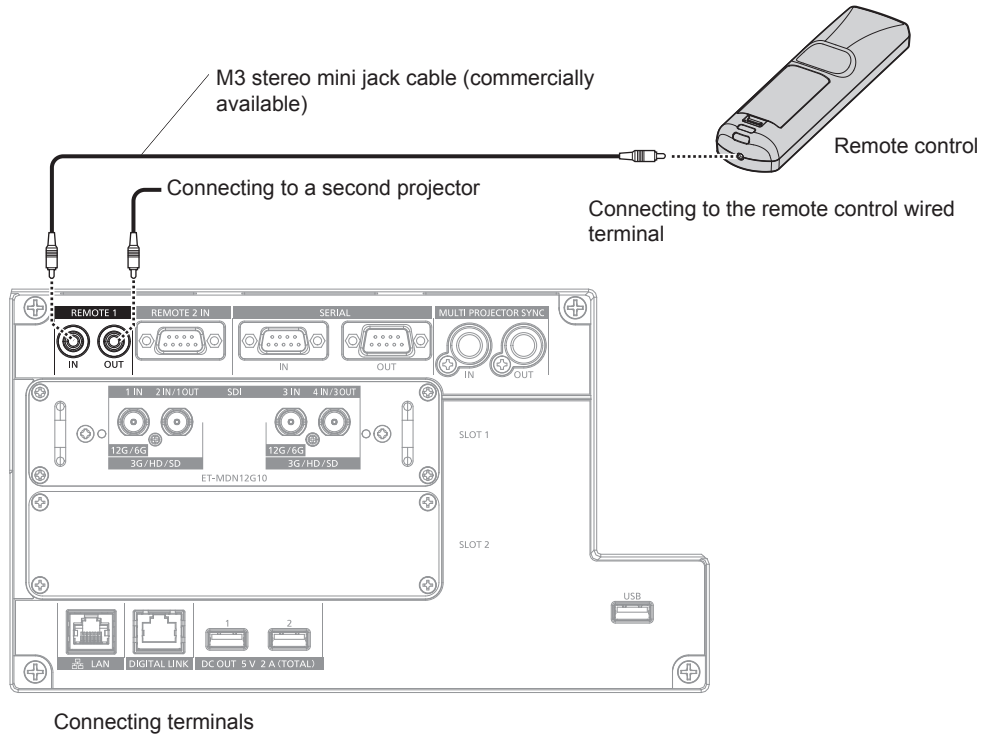

Attention

- Use a cable that is 15 m (49'3") or shorter, with 2 core shielded. The remote control may not operate when the length of the cable exceeds 15 m (49'3") or when the shielding of the cable is inadequate.

Chapter 2 **Getting Started**

This chapter describes things you need to do before using the projector such as the setup and connections.

Setting up

Usable outlet

This projector supports AC 100 V to AC 120 V, and AC 200 V to AC 240 V as the power supply. A grounded outlet supporting 30 A is required when using the projector with AC 200 V to AC 240 V. A grounded outlet supporting 15 A is required when using the projector with AC 100 V to AC 120 V.

The shape of the usable outlet differs depending on the power supply. Following illustrations are examples.



2P/3W 30 A 250 V
NEMA L6-30



2P/3W 32 A 250 V
Clock position 6h

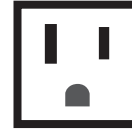

2P/3W 15 A 125 V

Attention

- Use the supplied power cord and ground at the outlet.
- Use the power cord matching the used power supply voltage and outlet shape.

Note

- The light output will decrease to approximately 1/5 when using the projector with AC 100 V to AC 120 V.
- The supplied power cords vary depending on the country or region where you purchased the product.

Installation mode

The installation modes of the projector are as follows. Set [FRONT/REAR]/[FLOOR/CEILING] in the [PROJECTOR SETUP] menu → [PROJECTION METHOD] (➔ page 143) depending on the installation mode.

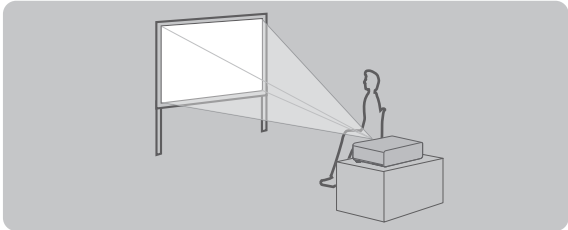
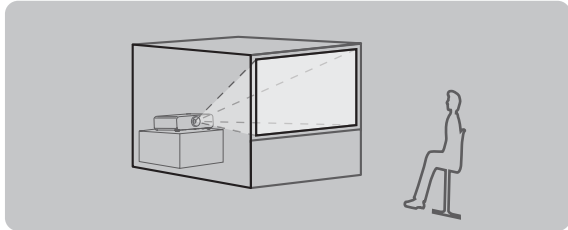
Setting on a desk/floor and projecting forward		Setting on a desk/floor and projecting from rear (Using the translucent screen)	
			
Menu item	Setting value	Menu item	Setting value
[FRONT/REAR]	[FRONT]	[FRONT/REAR]	[REAR]
[FLOOR/CEILING]	[AUTO] or [FLOOR]	[FLOOR/CEILING]	[AUTO] or [FLOOR]

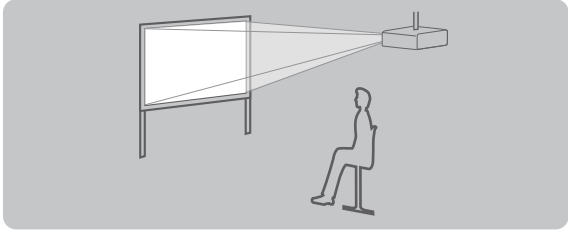
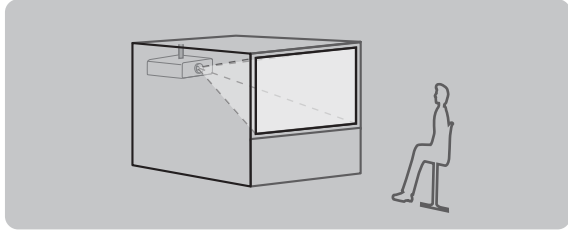
Mounting on the ceiling and projecting forward		Mounting on the ceiling and projecting from rear (Using the translucent screen)	
			
Menu item	Setting value	Menu item	Setting value
[FRONT/REAR]	[FRONT]	[FRONT/REAR]	[REAR]
[FLOOR/CEILING]	[AUTO] or [CEILING]	[FLOOR/CEILING]	[AUTO] or [CEILING]

Portrait setting and projecting forward

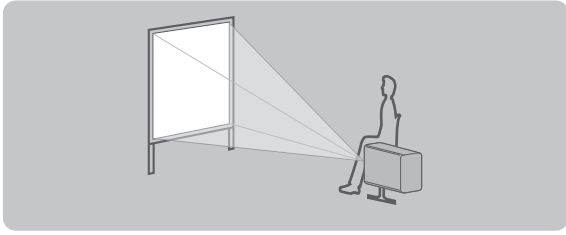

Portrait setting and projecting from the rear
(Using the translucent screen)

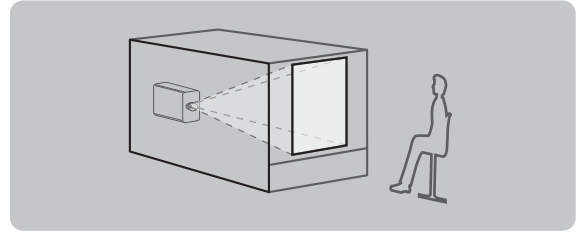

Menu item	Setting value	Menu item	Setting value
[FRONT/REAR]	[FRONT]	[FRONT/REAR]	[REAR]
[FLOOR/CEILING]	Set in accordance with the image to project.	[FLOOR/CEILING]	Set in accordance with the image to project.

Note

- In the portrait setting, the on-screen menu is displayed sideways. To display the on-screen menu vertically, change the [OSD ROTATION] setting in the [DISPLAY OPTION] menu → [ON-SCREEN DISPLAY] (➔ page 133).
- The projector has a built-in angle sensor. The attitude of the projector is automatically detected by setting [FLOOR/CEILING] to [AUTO] in the [PROJECTOR SETUP] menu → [PROJECTION METHOD].

■ Angle sensor

The range of the installation attitude that is detected by the angle sensor built-in the projector is as follows.

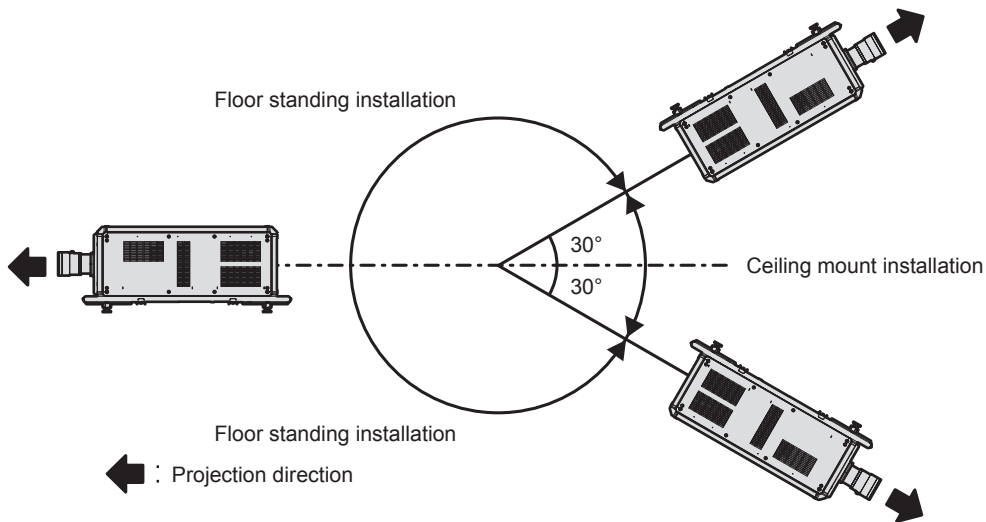

Interface Board

This projector is equipped with two SLOT NX-specification slots.

The input for HDMI, DVI-D, and SDI can be added by installing the optional Interface Board in the slot.

The supplied Interface Board for 12G-SDI (Model No.: ET-MDN12G10) is already installed in one of the slots.

Attention

- Requesting a qualified technician to install or remove the Interface Board is recommended. A malfunction may occur due to static electricity. Consult your dealer.

Projected image and throw distance

Install the projector referring to the projected image size, projection distance, etc.

Attention

- Before setting up, read “Precautions for use” (➔ page 18).
- The geometric adjustment function cannot be used when the video signal in simultaneous format or the video signal with vertical scanning frequency of 100 Hz or 120 Hz is input.
When projecting an image in simultaneous format or an image with vertical scanning frequency of 100 Hz or 120 Hz, install the projector following the instructions below so that distortion does not occur in the projected image.
 - Use a flat screen.
 - Install the projector so that the front side of the projector is parallel to the screen.
 - Install the projector so that the image can be projected within the lens shift adjustment range.
- Do not use the projector and the high-powered laser equipment in the same room. The DLP chips can be damaged if a laser beam hits the projection lens surface.

Figure of projected image and throw distance

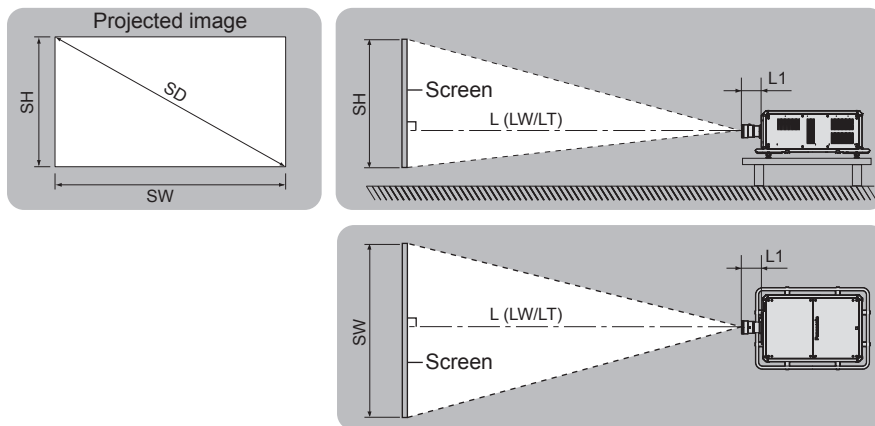

Note

- This illustration is prepared on the assumption that the projected image size and position have been aligned to fit full in the screen.

SH	Projected image height
SW	Projected image width
SD	Projected image size
$L^{-1} (LW/LT)^2$	Projection distance (distance from the front end of the projection lens to the screen)
L1	Lens protrusion dimension (distance from the front surface of the projector to the front end of the projection lens)

*1 For details about calculating the projection distance, refer to “Formula for calculating the projection distance per projection lens” (➔ page 47).

*2 LW: Minimum projection distance when the Zoom Lens is used

LT: Maximum projection distance when the Zoom Lens is used

(Unit: m)

Projection lens Model No.	Lens protrusion dimension (L1) (approximate value)
ET-D3QW300	0.246
ET-D3QS400	0.232
ET-D3QT500	0.208
ET-D3QT600	0.149
ET-D3QT700	0.221
ET-D3QT800	0.267

Note

- For the adjustment range of the projected image position with the lens shift, refer to “Lens shift range” (➔ page 74).

[GEOMETRY] projection range

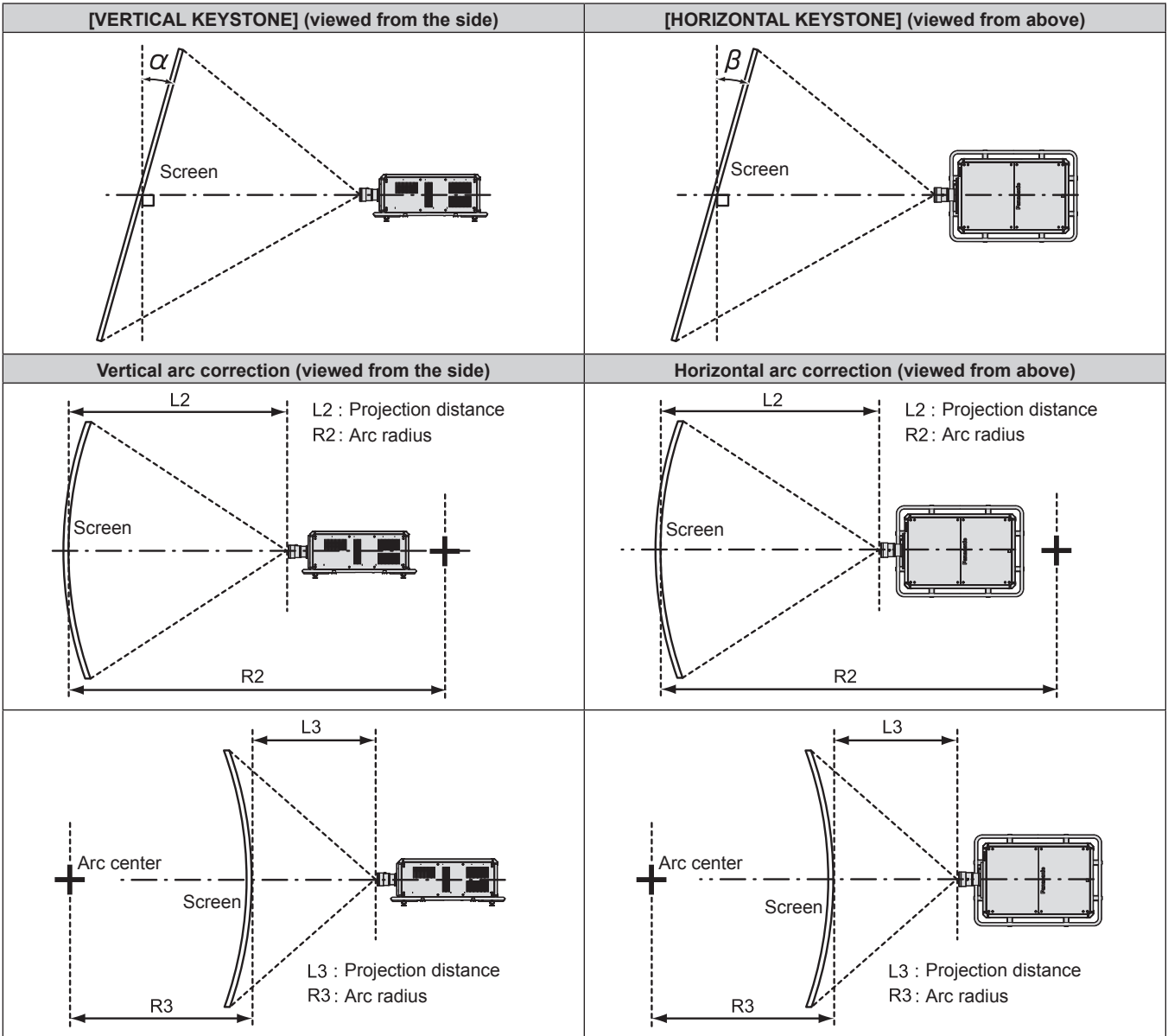

Projection lens Model No.	Only [KEystone] used*1		[KEystone] and [CURVED CORRECTION] used together*1				Only [CURVED CORRECTION] used	
	Vertical keystone correction angle α (°)	Horizontal keystone correction angle β (°)	Vertical keystone correction angle α (°)	Horizontal keystone correction angle β (°)	Min. value of R2/L2	Min. value of R3/L3	Min. value of R2/L2	Min. value of R3/L3
ET-D3QW300	±28	±15	±10	±10	1.2	3.0	0.7	1.7
ET-D3QS400	±40	±40	±20	±15	0.9	2.0	0.5	1.1
ET-D3QT500	±40	±40	±20	±15	0.9	2.0	0.5	1.1
ET-D3QT600	±40	±40	±20	±15	0.9	2.0	0.5	1.1
ET-D3QT700	±40	±40	±20	±15	0.9	2.0	0.5	1.1
ET-D3QT800	±40	±40	±20	±15	0.9	2.0	0.5	1.1

*1 When [VERTICAL KEystone] and [HORIZONTAL KEystone] are used simultaneously, correction cannot be made exceeding total of 55°.

Note

- When [GEOMETRY] is used, the focus of the entire screen may be lost as correction increases.
- Make the curved screen a circular arc shape with one part of a perfect circle removed.
- Adjustment range of the [GEOMETRY] items may not match the listed projection range depending on the projection lens. Use this projector within the projection range, otherwise the correction may not work.
- The geometric adjustment function cannot be used when the video signal in simultaneous format or the video signal with vertical scanning frequency of 100 Hz or 120 Hz is input.

When projecting an image in simultaneous format or an image with vertical scanning frequency of 100 Hz or 120 Hz, install the projector following the instructions below so that distortion does not occur in the projected image.

- Use a flat screen.
- Install the projector so that the front side of the projector is parallel to the screen.
- Install the projector so that the image can be projected within the lens shift adjustment range.

Projection distance of each projection lens

A ±5 % error in listed projection distances may occur.

When [GEOMETRY] is used, distance is corrected to become smaller than the specified image size.

■ When the image aspect ratio is 17:9

(Unit: m)

Lens type			Zoom Lens											
Projection lens Model No.			ET-D3QW300	ET-D3QS400	ET-D3QT500	ET-D3QT600	ET-D3QT700	ET-D3QT800						
Throw ratio*1			1.11-1.70:1	1.43-2.09:1	2.00-3.41:1	2.69-3.88:1	3.89-5.47:1	4.97-7.76:1						
Projected image size			Projection distance (L)											
Diagonal (SD)	Height (SH)	Width (SW)	Min. (LW)	Max. (LT)	Min. (LW)	Max. (LT)	Min. (LW)	Max. (LT)	Min. (LW)	Max. (LT)	Min. (LW)	Max. (LT)	Min. (LW)	Max. (LT)
2.54 (100")	1.188	2.245	2.42	3.77	3.13	4.64	4.64	7.80	5.92	8.57	8.57	12.09	10.97	17.22
3.05 (120")	1.426	2.694	2.93	4.55	3.79	5.59	5.51	9.31	7.15	10.34	10.34	14.59	13.23	20.75
3.81 (150")	1.783	3.367	3.69	5.71	4.77	7.02	6.81	11.57	8.99	12.99	12.99	18.33	16.62	26.05
5.08 (200")	2.377	4.490	4.95	7.65	6.40	9.40	8.97	15.33	12.06	17.42	17.42	24.57	22.27	34.88
6.35 (250")	2.971	5.612	6.22	9.60	8.03	11.78	11.14	19.09	15.14	21.85	21.85	30.81	27.92	43.71
7.62 (300")	3.565	6.734	7.49	11.54	9.66	14.17	13.31	22.85	18.21	26.28	26.28	37.04	33.57	52.54
8.89 (350")	4.160	7.857	8.76	13.48	11.29	16.55	15.47	26.62	21.28	30.71	30.71	43.28	39.23	61.37
10.16 (400")	4.754	8.979	10.03	15.42	12.92	18.93	17.64	30.38	24.35	35.14	35.14	49.52	44.88	70.20
12.70 (500")	5.942	11.224	12.56	19.31	16.18	23.69	21.97	37.90	30.49	44.00	43.99	62.00	56.18	87.85
15.24 (600")	7.131	13.469	15.10	23.19	19.44	28.45	26.31	45.43	36.64	52.85	52.85	74.47	67.48	105.51
17.78 (700")	8.319	15.714	17.63	27.07	22.70	33.21	30.64	52.95	42.78	61.71	61.71	86.95	78.78	123.17
20.32 (800")	9.507	17.959	20.17	30.96	25.97	37.98	34.97	60.48	48.92	70.57	70.57	99.43	90.09	140.83
22.86 (900")	10.696	20.203	22.70	34.84	29.23	42.74	39.31	68.00	55.07	79.42	79.42	111.90	101.39	158.49
25.40 (1000")	11.884	22.448	25.24	38.73	32.49	47.50	43.64	75.53	61.21	88.28	88.28	124.38	112.69	176.15
27.94 (1100")	13.073	24.693	27.77	42.61	35.75	52.26	47.97	83.05	67.36	97.14	97.14	136.86	123.99	193.81
30.48 (1200")	14.261	26.938	30.31	46.49	39.01	57.02	52.31	90.58	73.50	106.00	106.00	149.33	135.30	211.47
33.02 (1300")	15.450	29.183	32.84	50.38	42.27	61.79	56.64	98.10	79.64	114.85	114.85	161.81	146.60	229.13
35.56 (1400")	16.638	31.427	35.38	54.26	45.53	66.55	60.97	105.63	85.79	123.71	123.71	174.29	157.90	246.79
38.10 (1500")	17.827	33.672	37.91	58.15	48.80	71.31	65.31	113.16	91.93	132.57	132.57	186.76	169.20	264.44

*1 The throw ratio is based on the value during projection with the projected image size of 5.08 m (200").

■ When the image aspect ratio is 16:10

(Unit: m)

Lens type			Zoom Lens											
Projection lens Model No.			ET-D3QW300	ET-D3QS400	ET-D3QT500	ET-D3QT600	ET-D3QT700	ET-D3QT800						
Throw ratio*1			1.32-2.02:1	1.70-2.48:1	2.36-4.03:1	3.19-4.60:1	4.61-6.49:1	5.89-9.21:1						
Projected image size			Projection distance (L)											
Diagonal (SD)	Height (SH)	Width (SW)	Min. (LW)	Max. (LT)	Min. (LW)	Max. (LT)	Min. (LW)	Max. (LT)	Min. (LW)	Max. (LT)	Min. (LW)	Max. (LT)	Min. (LW)	Max. (LT)
2.54 (100")	1.346	2.154	2.76	4.30	3.58	5.29	5.23	8.83	6.76	9.77	9.77	13.79	12.51	19.62
3.05 (120")	1.615	2.585	3.34	5.18	4.32	6.37	6.22	10.54	8.15	11.79	11.78	16.63	15.08	23.64
3.81 (150")	2.019	3.231	4.21	6.51	5.43	8.00	7.69	13.10	10.25	14.80	14.80	20.88	18.93	29.66
5.08 (200")	2.692	4.308	5.65	8.71	7.28	10.70	10.15	17.38	13.74	19.84	19.84	27.97	25.35	39.69
6.35 (250")	3.365	5.385	7.09	10.92	9.14	13.41	12.62	21.65	17.23	24.87	24.87	35.05	31.77	49.72
7.62 (300")	4.039	6.462	8.53	13.12	10.99	16.11	15.08	25.93	20.72	29.90	29.90	42.14	38.19	59.75
8.89 (350")	4.712	7.539	9.97	15.33	12.84	18.82	17.54	30.20	24.21	34.93	34.93	49.23	44.61	69.79
10.16 (400")	5.385	8.616	11.41	17.54	14.70	21.52	20.00	34.48	27.70	39.96	39.96	56.32	51.03	79.82
12.70 (500")	6.731	10.770	14.29	21.95	18.40	26.93	24.93	43.03	34.68	50.03	50.03	70.50	63.88	99.88
15.24 (600")	8.077	12.923	17.17	26.36	22.11	32.34	29.85	51.58	41.66	60.09	60.09	84.67	76.72	119.95
17.78 (700")	9.423	15.077	20.05	30.78	25.81	37.75	34.77	60.13	48.64	70.16	70.15	98.85	89.56	140.01
20.32 (800")	10.770	17.231	22.93	35.19	29.52	43.16	39.70	68.68	55.62	80.22	80.22	113.02	102.40	160.08
22.86 (900")	12.116	19.385	25.81	39.60	33.23	48.58	44.62	77.23	62.60	90.28	90.28	127.20	115.24	180.14
25.40 (1000")	13.462	21.539	28.69	44.02	36.93	53.99	49.54	85.78	69.58	100.35	100.35	141.38	128.09	200.20
27.94 (1100")	14.808	23.693	31.57	48.43	40.64	59.40	54.47	94.33	76.56	110.41	110.41	155.55	140.93	220.27
30.48 (1200")	16.154	25.847	34.45	52.84	44.34	64.81	59.39	102.88	83.54	120.47	120.47	169.73	153.77	240.33
33.02 (1300")	17.501	28.001	37.33	57.26	48.05	70.22	64.31	111.43	90.52	130.54	130.54	183.91	166.61	260.40
35.56 (1400")	18.847	30.155	40.21	61.67	51.75	75.63	69.24	119.98	97.50	140.60	140.60	198.08	179.45	280.46
38.10 (1500")	20.193	32.309	43.09	66.08	55.46	81.04	74.16	128.53	104.48	150.67	150.67	212.26	192.30	300.53

*1 The throw ratio is based on the value during projection with the projected image size of 5.08 m (200").

■ When the image aspect ratio is 16:9

(Unit: m)

Lens type			Zoom Lens											
Projection lens Model No.			ET-D3QW300	ET-D3QS400	ET-D3QT500	ET-D3QT600	ET-D3QT700	ET-D3QT800						
Throw ratio*1			1.18-1.81:1	1.52-2.23:1	2.13-3.63:1	2.87-4.13:1	4.14-5.83:1	5.30-8.28:1						
Projected image size			Projection distance (L)											
Diagonal (SD)	Height (SH)	Width (SW)	Min. (LW)	Max. (LT)	Min. (LW)	Max. (LT)	Min. (LW)	Max. (LT)	Min. (LW)	Max. (LT)	Min. (LW)	Max. (LT)	Min. (LW)	Max. (LT)
2.54 (100")	1.245	2.214	2.55	3.97	3.30	4.88	4.86	8.19	6.23	9.02	9.02	12.73	11.55	18.12
3.05 (120")	1.494	2.657	3.08	4.78	3.99	5.89	5.77	9.77	7.52	10.88	10.88	15.35	13.92	21.83
3.81 (150")	1.868	3.321	3.88	6.01	5.02	7.39	7.14	12.14	9.46	13.67	13.67	19.28	17.49	27.40
5.08 (200")	2.491	4.428	5.21	8.05	6.73	9.89	9.42	16.10	12.69	18.33	18.33	25.84	23.43	36.68
6.35 (250")	3.113	5.535	6.55	10.09	8.44	12.39	11.69	20.05	15.92	22.98	22.98	32.40	29.36	45.96
7.62 (300")	3.736	6.641	7.88	12.13	10.16	14.89	13.97	24.00	19.15	27.64	27.64	38.95	35.30	55.24
8.89 (350")	4.358	7.748	9.21	14.17	11.87	17.40	16.25	27.96	22.38	32.29	32.29	45.51	41.24	64.52
10.16 (400")	4.981	8.855	10.54	16.21	13.59	19.90	18.52	31.91	25.60	36.95	36.94	52.07	47.18	73.80
12.70 (500")	6.226	11.069	13.21	20.30	17.01	24.90	23.08	39.82	32.06	46.25	46.25	65.18	59.06	92.36
15.24 (600")	7.472	13.283	15.87	24.38	20.44	29.91	27.63	47.73	38.52	55.56	55.56	78.29	70.94	110.92
17.78 (700")	8.717	15.497	18.54	28.46	23.87	34.91	32.19	55.64	44.98	64.87	64.87	91.41	82.82	129.48
20.32 (800")	9.962	17.710	21.20	32.54	27.30	39.92	36.74	63.55	51.43	74.18	74.18	104.52	94.70	148.04
22.86 (900")	11.207	19.924	23.87	36.63	30.72	44.92	41.30	71.46	57.89	83.49	83.49	117.63	106.58	166.60
25.40 (1000")	12.453	22.138	26.53	40.71	34.15	49.93	45.85	79.37	64.35	92.80	92.80	130.75	118.46	185.16
27.94 (1100")	13.698	24.352	29.19	44.79	37.58	54.93	50.41	87.28	70.80	102.11	102.11	143.86	130.34	203.72
30.48 (1200")	14.943	26.566	31.86	48.87	41.01	59.94	54.96	95.19	77.26	111.42	111.42	156.97	142.22	222.28
33.02 (1300")	16.188	28.779	34.52	52.95	44.44	64.94	59.51	103.10	83.72	120.73	120.73	170.09	154.10	240.84
35.56 (1400")	17.434	30.993	37.19	57.04	47.86	69.95	64.07	111.01	90.17	130.04	130.04	183.20	165.97	259.40
38.10 (1500")	18.679	33.207	39.85	61.12	51.29	74.95	68.62	118.92	96.63	139.35	139.35	196.31	177.85	277.96

*1 The throw ratio is based on the value during projection with the projected image size of 5.08 m (200").

■ When the image aspect ratio is 4:3

(Unit: m)

Lens type			Zoom Lens											
Projection lens Model No.			ET-D3QW300	ET-D3QS400	ET-D3QT500	ET-D3QT600	ET-D3QT700	ET-D3QT800						
Throw ratio*1			1.58-2.43:1	2.04-2.98:1	2.82-4.83:1	3.84-5.53:1	5.54-7.80:1	7.06-11.06:1						
Projected image size			Projection distance (L)											
Diagonal (SD)	Height (SH)	Width (SW)	Min. (LW)	Max. (LT)	Min. (LW)	Max. (LT)	Min. (LW)	Max. (LT)	Min. (LW)	Max. (LT)	Min. (LW)	Max. (LT)	Min. (LW)	Max. (LT)
2.54 (100")	1.524	2.032	3.15	4.88	4.07	6.00	5.88	9.96	7.68	11.10	11.10	15.66	14.15	22.27
3.05 (120")	1.829	2.438	3.80	5.88	4.91	7.23	7.00	11.89	9.26	13.38	13.38	18.87	17.06	26.82
3.81 (150")	2.286	3.048	4.78	7.38	6.17	9.07	8.67	14.80	11.63	16.80	16.80	23.69	21.42	33.63
5.08 (200")	3.048	4.064	6.41	9.88	8.26	12.13	11.45	19.64	15.58	22.49	22.49	31.71	28.69	44.99
6.35 (250")	3.810	5.080	8.04	12.38	10.36	15.19	14.24	24.48	19.53	28.19	28.19	39.74	35.96	56.35
7.62 (300")	4.572	6.096	9.67	14.87	12.46	18.26	17.03	29.32	23.48	33.89	33.89	47.76	43.23	67.70
8.89 (350")	5.334	7.112	11.30	17.37	14.56	21.32	19.82	34.16	27.43	39.58	39.58	55.78	50.50	79.06
10.16 (400")	6.096	8.128	12.93	19.87	16.65	24.38	22.60	39.00	31.39	45.28	45.28	63.81	57.77	90.42
12.70 (500")	7.620	10.160	16.19	24.87	20.85	30.51	28.18	48.68	39.29	56.67	56.67	79.86	72.30	113.13
15.24 (600")	9.144	12.192	19.45	29.86	25.04	36.63	33.75	58.35	47.19	68.07	68.07	95.91	86.84	135.85
17.78 (700")	10.668	14.224	22.71	34.86	29.24	42.76	39.32	68.03	55.09	79.46	79.46	111.95	101.38	158.56
20.32 (800")	12.192	16.256	25.97	39.85	33.44	48.88	44.90	77.71	63.00	90.85	90.85	128.00	115.92	181.28
22.86 (900")	13.716	18.288	29.23	44.85	37.63	55.01	50.47	87.39	70.90	102.25	102.25	144.05	130.46	203.99
25.40 (1000")	15.240	20.320	32.49	49.85	41.83	61.13	56.05	97.07	78.80	113.64	113.64	160.10	145.00	226.70
27.94 (1100")	16.764	22.352	35.76	54.84	46.02	67.26	61.62	106.75	86.70	125.03	125.03	176.15	159.53	249.42
30.48 (1200")	18.288	24.384	39.02	59.84	50.22	73.38	67.19	116.43	94.60	136.43	136.42	192.20	174.07	272.13
33.02 (1300")	19.812	26.416	42.28	64.83	54.41	79.51	72.77	126.11	102.51	147.82	147.82	208.25	188.61	294.85
35.56 (1400")	21.336	28.448	45.54	69.83	58.61	85.63	78.34	135.79	110.41	159.21	159.21	224.29	203.15	317.56
38.10 (1500")	22.860	30.480	48.80	74.82	62.80	91.76	83.92	145.47	118.31	170.60	170.60	240.34	217.69	340.28

*1 The throw ratio is based on the value during projection with the projected image size of 5.08 m (200").

Formula for calculating the projection distance per projection lens

To use a projected image size not listed in this manual, check the projected image size SD (m) and use the respective formula to calculate projection distance.

The unit of all the formulae is m. (Values obtained by the following calculation formulae contain a slight error.)

When calculating a projection distance using image size designation (value in inches), multiply the value in inches by 0.0254 and substitute it into SD in the formula for calculating the projection distance.

■ **Zoom Lens**

Projection lens Model No.	Throw ratio	Aspect ratio	Projection distance (L) formula	
			Min. (LW)	Max. (LT)
ET-D3QW300	1.11 - 1.70:1	17:9	= 0.9981 x SD - 0.1156	= 1.5291 x SD - 0.1143
	1.32 - 2.02:1	16:10	= 1.1341 x SD - 0.1156	= 1.7374 x SD - 0.1143
	1.18 - 1.81:1	16:9	= 1.0490 x SD - 0.1156	= 1.6072 x SD - 0.1143
	1.58 - 2.43:1	4:3	= 1.2839 x SD - 0.1156	= 1.9669 x SD - 0.1143
ET-D3QS400	1.43 - 2.09:1	17:9	= 1.2841 x SD - 0.1267	= 1.8748 x SD - 0.1207
	1.70 - 2.48:1	16:10	= 1.4590 x SD - 0.1267	= 2.1302 x SD - 0.1207
	1.52 - 2.23:1	16:9	= 1.3496 x SD - 0.1267	= 1.9705 x SD - 0.1207
	2.04 - 2.98:1	4:3	= 1.6517 x SD - 0.1267	= 2.4115 x SD - 0.1207
ET-D3QT500	2.00 - 3.41:1	17:9	= 1.7060 x SD + 0.3072	= 2.9627 x SD + 0.2772
	2.36 - 4.03:1	16:10	= 1.9384 x SD + 0.3072	= 3.3663 x SD + 0.2772
	2.13 - 3.63:1	16:9	= 1.7931 x SD + 0.3072	= 3.1139 x SD + 0.2772
	2.82 - 4.83:1	4:3	= 2.1944 x SD + 0.3072	= 3.8109 x SD + 0.2772
ET-D3QT600	2.69 - 3.88:1	17:9	= 2.4187 x SD - 0.2235	= 3.4871 x SD - 0.2915
	3.19 - 4.60:1	16:10	= 2.7482 x SD - 0.2235	= 3.9621 x SD - 0.2915
	2.87 - 4.13:1	16:9	= 2.5421 x SD - 0.2235	= 3.6651 x SD - 0.2915
	3.84 - 5.53:1	4:3	= 3.1111 x SD - 0.2235	= 4.4855 x SD - 0.2915
ET-D3QT700	3.89 - 5.47:1	17:9	= 3.4871 x SD - 0.2923	= 4.9121 x SD - 0.3863
	4.61 - 6.49:1	16:10	= 3.9621 x SD - 0.2923	= 5.5812 x SD - 0.3863
	4.14 - 5.83:1	16:9	= 3.6651 x SD - 0.2923	= 5.1627 x SD - 0.3863
	5.54 - 7.80:1	4:3	= 4.4855 x SD - 0.2923	= 6.3184 x SD - 0.3863
ET-D3QT800	4.97 - 7.76:1	17:9	= 4.4498 x SD - 0.3333	= 6.9524 x SD - 0.4407
	5.89 - 9.21:1	16:10	= 5.0559 x SD - 0.3333	= 7.8994 x SD - 0.4407
	5.30 - 8.28:1	16:9	= 4.6768 x SD - 0.3333	= 7.3071 x SD - 0.4407
	7.06 - 11.06:1	4:3	= 5.7237 x SD - 0.3333	= 8.9427 x SD - 0.4407

Adjusting adjustable feet

Install the projector on a flat surface so that the front of the projector is parallel to the screen surface and the projection screen is rectangular.

If the screen is tilted downward, extend the front adjustable feet so that the projected image becomes rectangular. The adjustable feet can also be used to adjust the projector to be level when it is tilted in the horizontal direction.

Adjustable feet can be extended by turning them as shown in the figure. Turning them in the opposite direction will return them to the original position.

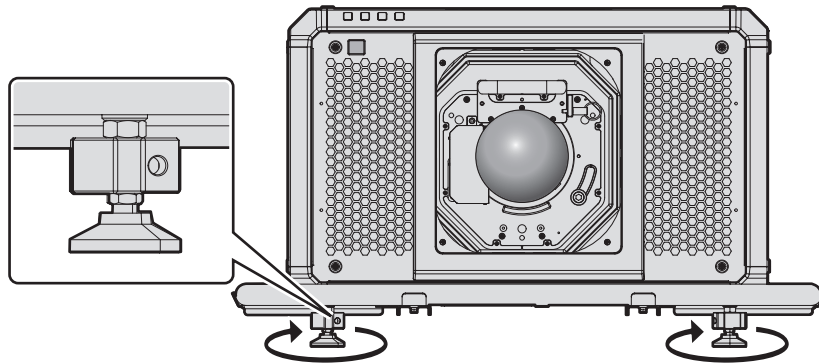

Maximum adjustable range

Adjustable feet: 20 mm (25/32") each

Attention

- Be careful not to block the intake/exhaust vents with your hands or any objects when adjusting the adjustable feet while the light source is on. (➔ page 31)

Note

- The adjustable feet can also be turned by inserting a screwdriver, etc. into the hole ($\phi 8$ mm (5/16")) at the side of the adjustable feet.

Attaching/removing the projection lens (optional)

Move the projection lens to the home position before replacing or removing the projection lens. (➔ page 73)

Attention

- Replace the projection lens after turning off the power of the projector.
- Do not touch the electric contacts of the projection lens. Dust or dirt may cause poor contact.
- Do not touch the surface of the projection lens with your bare hands.
- Before attaching the projection lens, remove the lens cover attached to the projection lens.
- Do not touch any area other than specified in “Adjusting the lens mounter when the focus is unbalanced” (➔ page 75) with the projection lens removed. Touching around the projection lens mount inside the projector may result in malfunction.
- Panasonic takes no responsibility for any damage or malfunction of the product resulting from the use of projection lenses which are not manufactured by Panasonic. Be sure to use the specified projection lenses.

Note

- For the adjustment procedure of the focus, zoom, and lens shift after attaching the projector lens, refer to “Adjusting the focus, zoom, and lens shift” (➔ page 71).
- For the adjustment procedure of the focus balance in the center and periphery of the projected image when the following projection lens is used, refer to “Adjusting the focus balance” (➔ page 72).
 - Zoom Lens (Model No.: ET-D3QW300, ET-D3QS400, ET-D3QT500)
- For the adjustment procedure of the focus balance between top, bottom, left, and right of the projected image, refer to “Adjusting the lens mounter when the focus is unbalanced” (➔ page 75).

Attaching the projection lens

Attach the projection lens using the following procedure. Start from Step 4) when the lens hole cover is already removed.

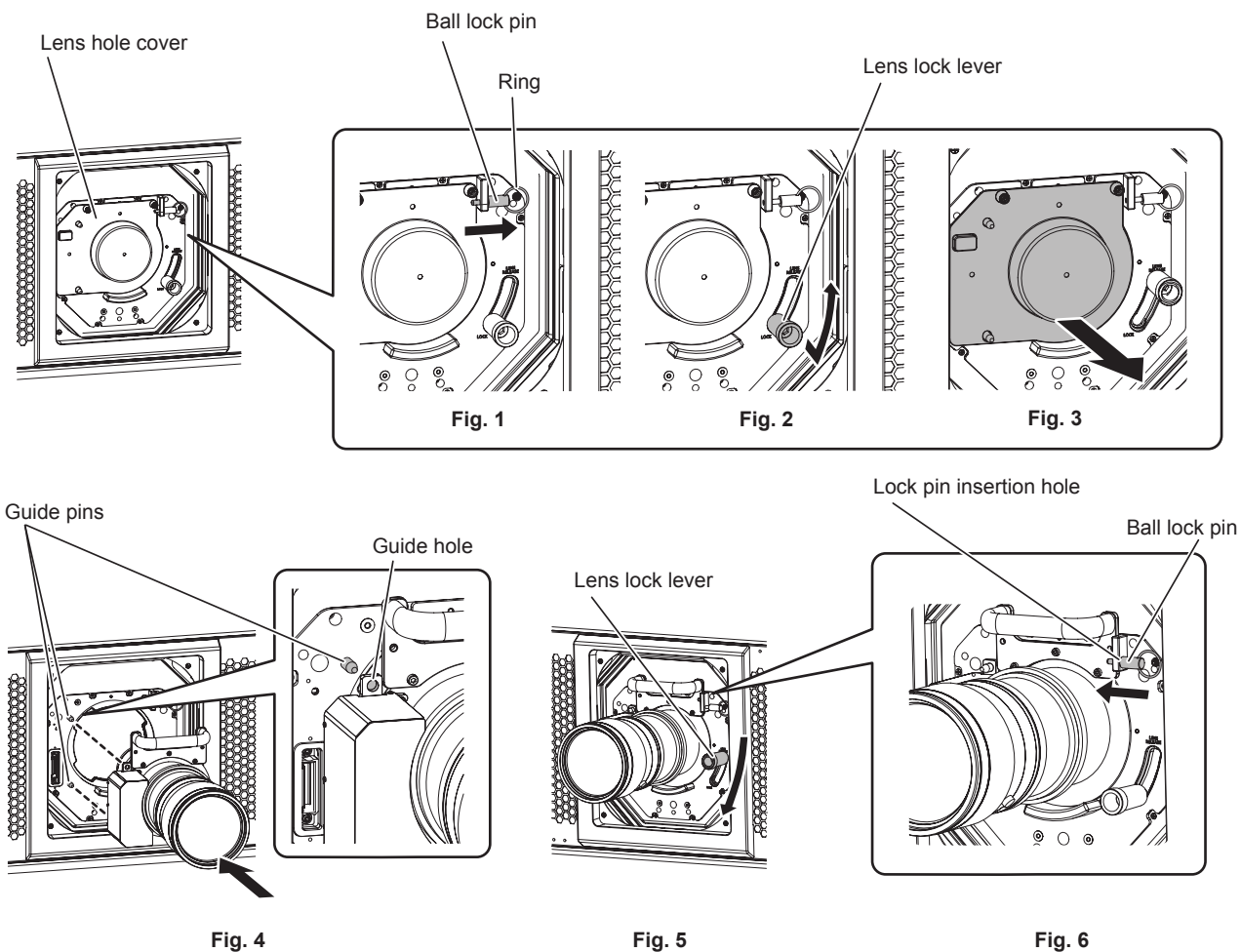

- 1) Remove the ball lock pin. (Fig. 1)**
 - Hold the ring of the ball lock pin and pull out in the direction of the arrow.
- 2) Unlock the lens hole cover. (Fig. 2)**
 - When unlocking the projection lens, hold the lens hole cover so that it will not drop off from the projector.

- While pulling the lens lock lever forward, slide it counterclockwise towards the “UNLOCK” position.
- 3) **Remove the lens hole cover. (Fig. 3)**
 - 4) **Attach the projection lens. (Fig. 4)**
 - Attach the projection lens by aligning the guide holes (two locations) of the projection lens with the guide pins on the projector.
 - 5) **Lock the projection lens. (Fig. 5)**
 - While pressing the projection lens to the projector side, slide the lens lock lever clockwise towards the “LOCK” position.
 - Confirm that the lens lock lever does not move vertically at the “LOCK” position. If the lens lock lever is in an incorrect position, the lock may be released unintentionally and the projection lens may fall off from the projector.
 - 6) **Attach the ball lock pin. (Fig. 6)**
 - Insert the ball lock pin all the way in.

Attention

- Store the removed lens hole cover in a safe place.
- Turn on the projector and execute the lens calibration after attaching the projection lens. (➔ page 73)

Removing the projection lens

Remove the projection lens using the following procedure.

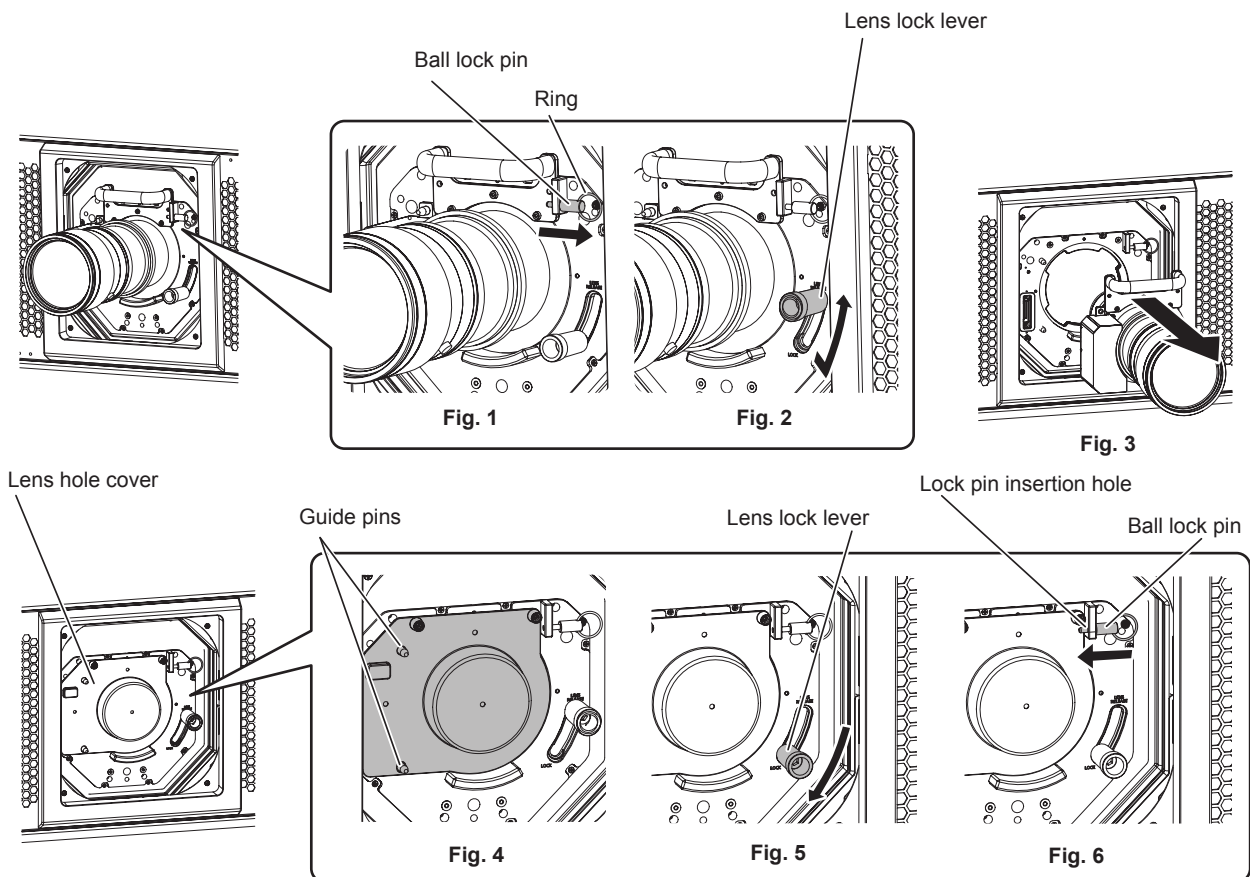

- 1) **Remove the ball lock pin. (Fig. 1)**
 - Hold the ring of the ball lock pin and pull out in the direction of the arrow.
- 2) **Unlock the projection lens. (Fig. 2)**
 - When unlocking the projection lens, hold the projection lens so that it will not drop off from the projector.
 - While pulling the lens lock lever forward, slide it counterclockwise to the “UNLOCK” position.
- 3) **Remove the projection lens. (Fig. 3)**
 - Proceed to Step 4) when carrying or storing the projector.

4) Attach the supplied lens hole cover. (Fig. 4)

- Attach the lens hole cover by aligning the guide holes (two locations) of the lens hole cover with the guide pins on the projector.

5) Lock the lens hole cover. (Fig. 5)

- Slide the lens lock lever clockwise towards the “LOCK” position.
- Confirm that the lens lock lever does not move vertically at the “LOCK” position.

6) Attach the ball lock pin. (Fig. 6)

- Insert the ball lock pin all the way in.

Attention

- Store the removed projection lens where it will be free from vibration and impact.

Connecting

Before connecting

- Before connecting, carefully read the operating instructions for the external device to be connected.
- Turn off the power of all devices before connecting cables.
- Connect cables taking care of the following descriptions. Failure to do so may result in malfunctions.
 - When connecting a cable to a device connected to the projector or the projector itself, touch any nearby metallic objects to eliminate static electricity from your body before performing work.
 - Do not use unnecessarily long cables to connect a device to the projector or to the projector body. The longer the cable, the more susceptible to noise it becomes. Since using a cable while it is wound makes it act like an antenna, it is more susceptible to noise.
 - When connecting cables, connect GND first, then insert the connecting terminal of the connecting device in a straight manner.
- Acquire any connection cable necessary to connect the external device to the system that is neither supplied with the device nor available as an option.
- Install the Interface Board necessary for the video equipment to connect with the projector to the slot in advance.

Requesting a qualified technician to install or remove the optional Interface Board is recommended. A malfunction may occur due to static electricity. Consult your dealer.

For details on how to install the Interface Board, refer to “Installing the Interface Board” (➔ page 294).
- Some computer models or graphic cards are not compatible with the projector.
- Connect using an extension device, etc., when installing the projector away from the video equipment. The projector may not display the image properly when it is connected directly using a long cable.
- For details of the types of video signals that can be used with the projector, refer to “List of compatible signals” (➔ page 274).

Connecting example: AV equipment

For <SDI 1 IN>/<SDI 2 IN/1 OUT>/<SDI 3 IN>/<SDI 4 IN/3 OUT> terminals of the Interface Board

This is an example when using the Interface Board for 12G-SDI (Model No.: ET-MDN12G10) installed in <SLOT 1>.

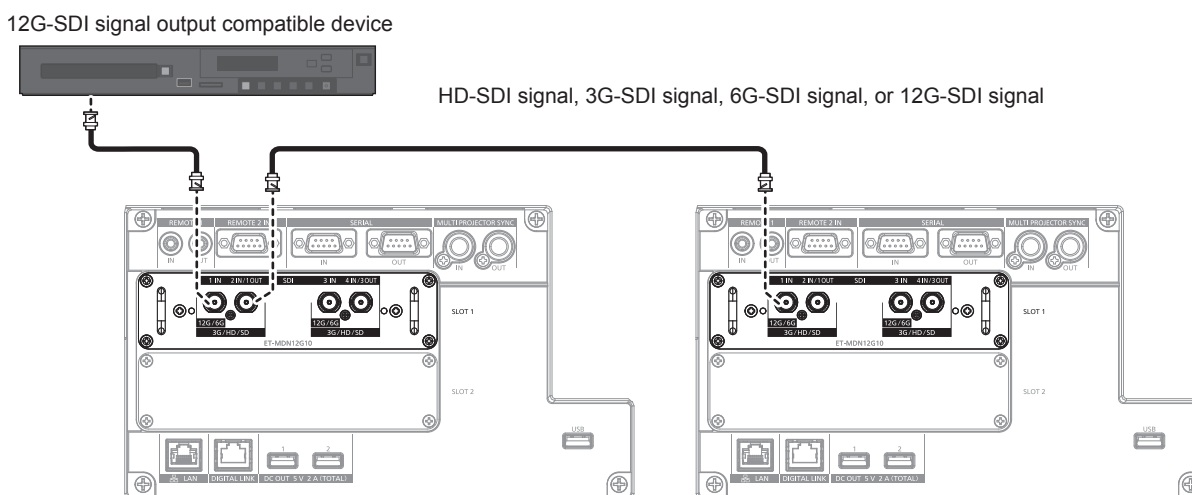

Note

- Use a connection cable of 5C-FB or higher (such as 5C-FB, or 7C-FB), Belden 1694A or higher, or L-5.5CUHD manufactured by Canare Electric Co., Ltd. to properly transmit images. The maximum cable length that can be used is as follows. However, this maximum cable length is a rough guideline, and does not guarantee the transmission distance.
 - HD-SDI signal, 3G-SDI signal: 150 m (492'2")
 - 6G-SDI signal: 80 m (262'6") (When L-5.5CUHD is used, the cable length should be 110 m (360'11").)
 - For 12G-SDI signal, the cable length will differ depending on the setting in the [DISPLAY OPTION] menu → [SLOT IN] → [SDI MODE].
 - When [SDI MODE] is set to [INPUT]: 50 m (164'1") (When L-5.5CUHD is used, the cable length should be 100 m (328'1").)
 - When [SDI MODE] is set to [OUTPUT]: 50 m (164'1") (When L-5.5CUHD is used, the cable length should be 90 m (295'3").)
- When the [DISPLAY OPTION] menu → [SLOT IN] → [SDI MODE] is set to [OUTPUT], attach a terminating resistor (75 Ω) to the terminal with no device connected as an output destination.

- Use the BNC connector that is compatible with the coaxial cable and type of the signal to be used.
- Setting the [DISPLAY OPTION] menu → [SLOT IN] is required depending on the connected external device or the input signal.
- Setting the [DISPLAY OPTION] menu → [SLOT IN] → [SDI LINK] is required when the dual link signal or the quad link signal is input.
- To input the dual link signal, use the cable with same length and same type for connecting to the <SDI 1 IN> terminal and the <SDI 3 IN> terminal. The image may not be projected correctly when the difference of the cable length is 4 m (13'1") or more.
- To input the quad link signal, use the cable with same length and same type for connecting to each of <SDI 1 IN>/<SDI 2 IN/1 OUT>/<SDI 3 IN>/<SDI 4 IN/3 OUT> terminals. The image may not be projected correctly when the difference of the cable length is 4 m (13'1") or more.
- Directly connect the projector with the external device that will output the signal without going through a distributor, etc., when inputting dual link signals. A phase difference is generated between the Link A signal and the Link B signal, and the image may not be projected correctly.
- Directly connect the projector with the external device that will output the signal without going through a distributor, etc., when inputting quad link signals. A phase difference is generated between the signals of Link 1, Link 2, Link 3, and Link 4, and the image may not be projected correctly.
- An error in signal detection may occur when an unsteady signal is input to the projector. In such case, set the [DISPLAY OPTION] menu → [SLOT IN] to the content corresponding to the input signal.
- The <SDI 2 IN/1 OUT> terminal and the <SDI 4 IN/3 OUT> terminal do not support the input of the 6G-SDI signal or the 12G-SDI signal.
- To use the <SDI 2 IN/1 OUT> terminal or the <SDI 4 IN/3 OUT> terminal as an output terminal, set the [DISPLAY OPTION] menu → [SLOT IN] → [SDI MODE] to [OUTPUT].

For <HDMI IN 1>/<HDMI IN 2> terminals and <HDMI IN 3>/<HDMI IN 4> terminals of the Interface Board

This is an example when the optional Interface Board for HDMI 2 input (Model No.: ET-MDNHM10) is installed in <SLOT 2>.

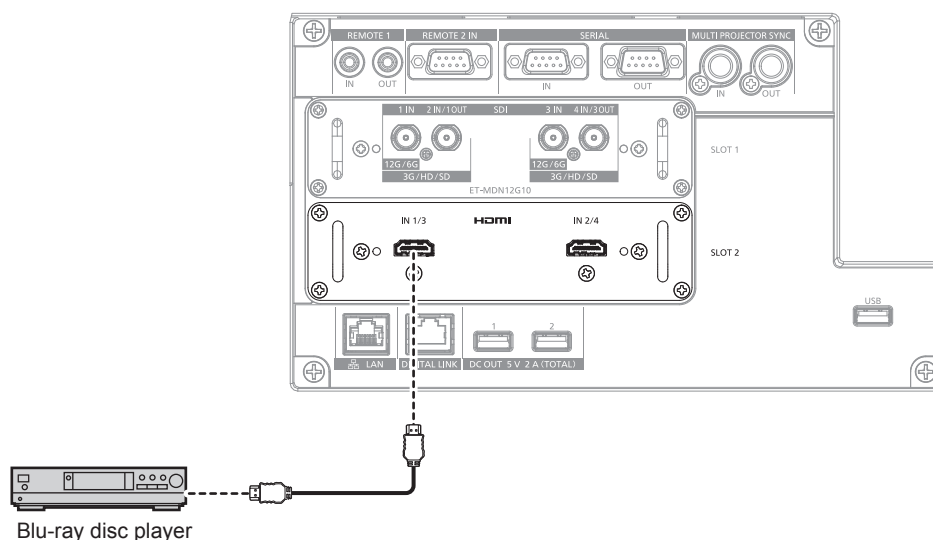

Note

- For the HDMI cable, use an HDMI High Speed cable that conforms to the HDMI standards. However, when the following 4K video signal exceeding the supported transmission speed of the HDMI High Speed cable is to be input, use the HDMI cable supporting the high speed transmission of 18 Gbps such as the one with Premium HDMI cable authentication.
 - A video signal with high specification color depth and gradation such as 3840 x 2160/60p 4:2:2/36-bit or 3840 x 2160/60p 4:4:4/24-bit Images may be disrupted or may not be projected when a video signal exceeding the supported transmission speed of the HDMI cable is used.
- Setting the [DISPLAY OPTION] menu → [SLOT IN] is required depending on the connected external device or the input signal. Setting the [DISPLAY OPTION] menu → [SLOT IN] → [HDMI LINK] is required when the dual link signal or the quad link signal is input.
- The <HDMI IN 1>/<HDMI IN 2>/<HDMI IN 3>/<HDMI IN 4> terminals can be connected to the external device with a DVI-D terminal by using the HDMI/DVI conversion cable. However, this may not function properly for some external devices, and image may not be projected.
- When performing the simultaneous input of the 4K image (resolution of 3 840 x 2 160 or 4 096 x 2 160) using the Interface Board for HDMI 2 input (Model No.: ET-MDNHM10), it is necessary for the firmware version of the Interface Board for HDMI 2 input to be 2.00 or later. If the version is earlier than 2.00, the simultaneous process is not performed even if corresponding signal is input. Consult your dealer regarding the version update to the latest firmware. For details on how to confirm the firmware version, refer to “How to confirm the firmware version of the Interface Board” (➡ page 36).
- The projector does not support VIERA Link (HDMI) and HDMI CEC (Consumer Electronics Control).

For <DVI-D IN 1>/<DVI-D IN 2> terminals and <DVI-D IN 3>/<DVI-D IN 4> terminals of the Interface Board

This is an example when the optional Interface Board for DVI-D 2 input (Model No.: ET-MDNDV10) is installed in <SLOT 2>.

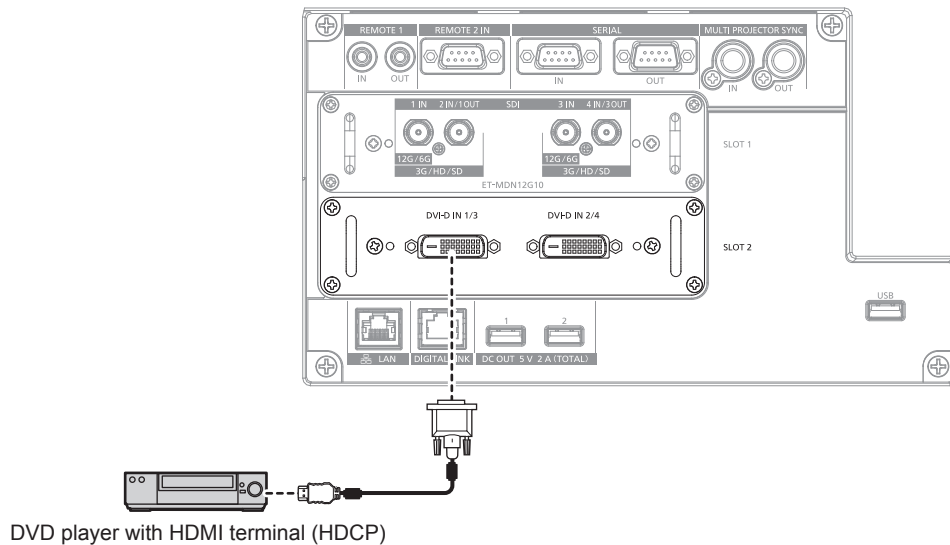

Note

- Setting the [DISPLAY OPTION] menu → [SLOT IN] is required depending on the connected external device or the input signal. Setting the [DISPLAY OPTION] menu → [SLOT IN] → [DVI-D LINK] is required when the dual link signal or the quad link signal is input.
- The <DVI-D IN 1>/<DVI-D IN 2>/<DVI-D IN 3>/<DVI-D IN 4> terminals can be connected with the HDMI and DVI-D compatible device. However, some external devices may not be able to project images properly, such as the image not displaying.

Connecting example: Computers

This is an example when the optional Interface Board for DisplayPort 2 input (Model No.: ET-MDNDP10) is installed in <SLOT 1>, and the optional Interface Board for DVI-D 2 input (Model No.: ET-MDNDV10) is installed in <SLOT 2>.

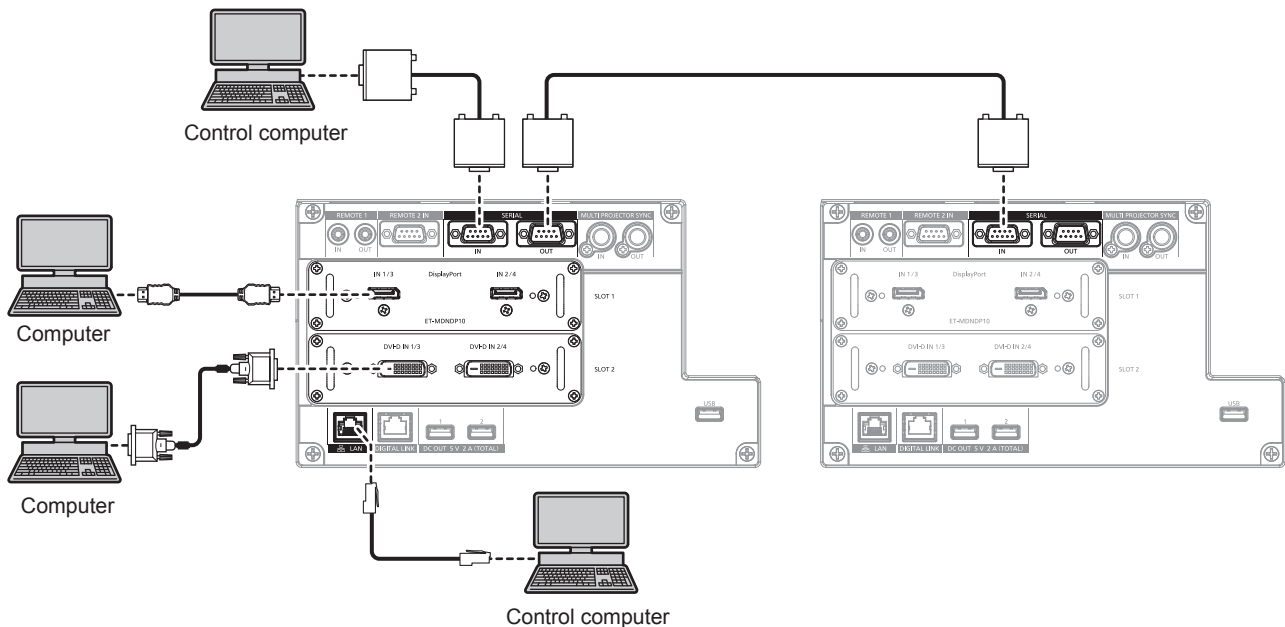

Attention

- When connecting the projector to a computer or an external device, use the power cord supplied with each device and commercially available shielded cables.

Note

- Setting the [DISPLAY OPTION] menu → [SLOT IN] is required depending on the connected external device or the input signal.
- For the DisplayPort cable, use a DisplayPort cable that conforms to the DisplayPort standards. When a cable that does not conform to the DisplayPort standards is used, images may be interrupted or may not be projected.

- The <DVI-D IN 1>/<DVI-D IN 2>/<DVI-D IN 3>/<DVI-D IN 4> terminals support the single link for DVI 1.0. They do not support the dual link for DVI 1.0.
- For the HDMI cable, use an HDMI High Speed cable that conforms to the HDMI standards. However, when the following 4K video signal exceeding the supported transmission speed of the HDMI High Speed cable is to be input, use the HDMI cable supporting the high speed transmission of 18 Gbps such as the one with Premium HDMI cable authentication.
 - A video signal with high specification color depth and gradation such as 3840 x 2160/60p 4:2:2/36-bit or 3840 x 2160/60p 4:4:4/24-bit Images may be disrupted or may not be projected when a video signal exceeding the supported transmission speed of the HDMI cable is used.
- The <HDMI IN 1>/<HDMI IN 2>/<HDMI IN 3>/<HDMI IN 4> terminals can be connected to the external device with a DVI-D terminal by using the HDMI/DVI conversion cable. However, this may not function properly for some external devices, and image may not be projected.
- If you operate the projector using the computer with the resume feature (last memory), you may have to reset the resume feature to operate the projector.

Connecting example using DIGITAL LINK

Twisted-pair-cable transmitters based on the communication standard HDBaseT™ such as the optional DIGITAL LINK output supported device (Model No.: ET-YFB100G, ET-YFB200G) use the twisted pair cable to transmit input images, Ethernet, and serial control signal, and the projector can input such digital signal to the <DIGITAL LINK> terminal.

Projector connecting terminals

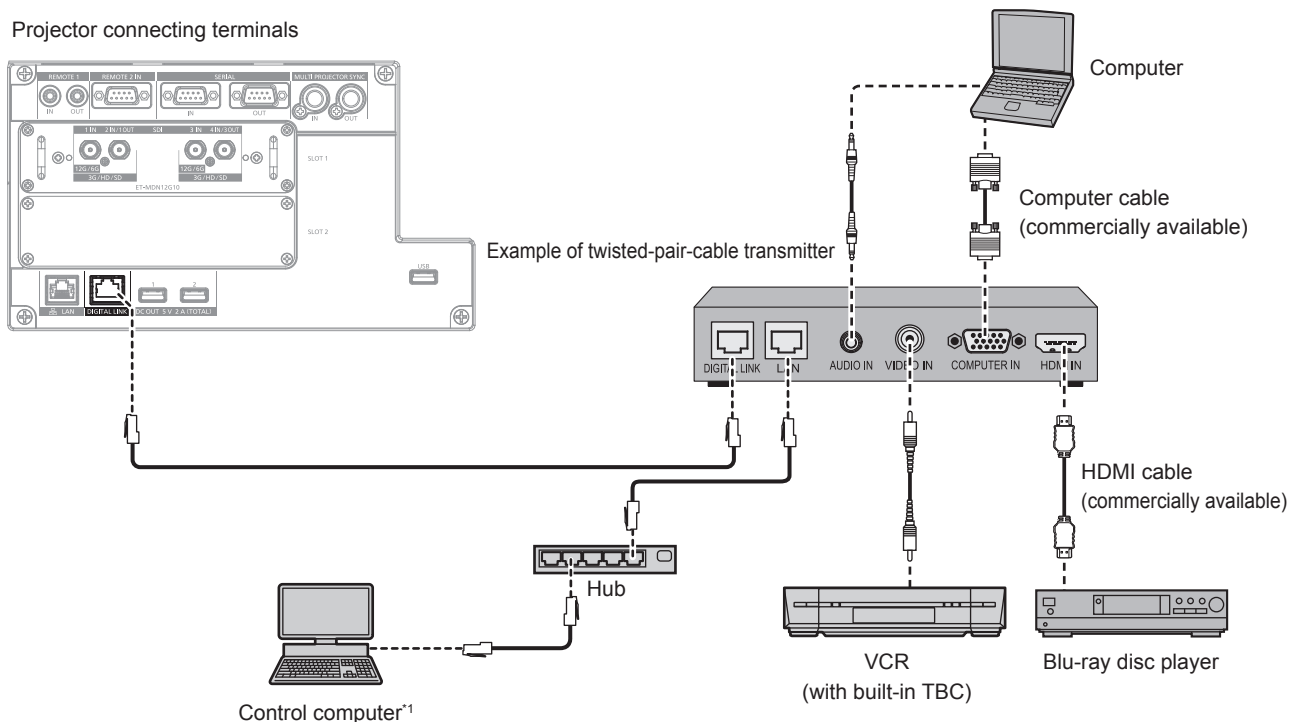

*1 Control target is the projector or the twisted-pair-cable transmitter. The control itself may not be possible depending on the twisted-pair-cable transmitter. Check the operating instructions of the device to be connected.

Attention

- Always use one of the following when connecting a VCR.
 - Use a VCR with built-in time base corrector (TBC).
 - Use a time base corrector (TBC) between the projector and the VCR.
- If nonstandard burst signals are connected, the image may be disrupted. In such a case, connect the time base corrector (TBC) between the projector and the external devices.
- Ask a qualified technician or your dealer to install the cable wiring between the twisted-pair-cable transmitter and the projector. Image may be disrupted if cable transmission characteristics cannot be obtained due to inadequate installation.
- For the LAN cable between the twisted-pair-cable transmitter and the projector, use a cable that meets the following criteria:
 - Conforming to CAT5e or higher standards
 - Shielded type (including connectors)
 - Straight-through
 - Single wire
 - Diameter of the cable core is same or larger than AWG24 (AWG24, AWG23, etc.)
- When laying cables between the twisted-pair-cable transmitter and the projector, confirm that cable characteristics are compatible with CAT5e or higher using tools such as a cable tester or cable analyzer. When a relay connector is used, include it in the measurement.
- Do not use a hub between the twisted-pair-cable transmitter and the projector.
- When connecting to the projector using a twisted-pair-cable transmitter (receiver) of other manufacturers, do not place another twisted-pair-cable transmitter between the twisted-pair-cable transmitter of other manufacturers and the projector. This may cause image to be disrupted.
- To transmit the Ethernet and serial control signals using the <DIGITAL LINK> terminal, set the [NETWORK] menu → [NETWORK CONTROL] → [TYPE SELECT] to [DIGITAL LINK] or [LAN & DIGITAL LINK].
- To transmit the Ethernet signal using the <LAN> terminal, set the [NETWORK] menu → [NETWORK CONTROL] → [TYPE SELECT] to [LAN] or [LAN & DIGITAL LINK].

- The <DIGITAL LINK> terminal and the <LAN> terminal are connected inside of the projector when the [NETWORK] menu → [NETWORK CONTROL] → [TYPE SELECT] is set to [LAN & DIGITAL LINK]. Do not directly connect the <DIGITAL LINK> terminal and the <LAN> terminal using a LAN cable. Construct the system so that it is not connected to the same network via the peripherals such as the hub or the twisted-pair-cable transmitter.
- Do not pull cables forcefully. Also, do not bend or fold cables unnecessarily.
- To reduce the effects of noise as much as possible, stretch out the cables between the twisted-pair-cable transmitter and the projector without any loops.
- Lay the cables between the twisted-pair-cable transmitter and the projector away from other cables, particularly power cables.
- When laying multiple cables, run them side by side along the shortest distance possible without bundling them together.
- After laying the cables, go to the [NETWORK] menu → [DIGITAL LINK STATUS] and confirm that the value of [SIGNAL QUALITY] is displayed in green which indicates normal quality. (▶ page 191)

Note

- For the HDMI cable, use an HDMI High Speed cable that conforms to the HDMI standards. If a cable that does not conform to the HDMI standards is used, images may be interrupted or may not be projected.
- The projector does not support VIERA Link (HDMI) and HDMI CEC (Consumer Electronics Control).
- The optional Digital Interface Box (Model No.: ET-YFB100G) and the optional DIGITAL LINK Switcher (Model No.: ET-YFB200G) do not support the input and output of the 4K video signal.
- The maximum transmission distance between the twisted-pair-cable transmitter and the projector is 100 m (328'1") for the signal with resolution of 1 920 x 1 200 dots or less. For the signal with the resolution exceeding 1 920 x 1 200 dots, the maximum transmission distance is 50 m (164'1"). It is possible to transmit up to 150 m (492'2") if the twisted-pair-cable transmitter supports the long-reach communication method. However, the signal that the projector can receive is only up to 1080/60p (1 920 x 1 080 dots, dot clock frequency 148.5 MHz) for the long-reach communication method. If these distances are exceeded, image may be disrupted or a malfunction may occur in LAN communication. Please note that Panasonic does not support the use of the projector outside the maximum transmission distance. When connecting with the long reach, video signal or distance that can be transmitted may be restricted, depending on the specification of the twisted-pair-cable transmitter.
- For twisted-pair-cable transmitters of other manufacturers of which the operation has been verified with the projector, visit the Panasonic website (<https://panasonic.net/cns/projector/>). Note that the verification for devices of other manufacturers has been made for the items set by Panasonic Corporation, and not all the operations have been verified. For operation or performance problems caused by the devices of other manufacturers, contact the respective manufacturers.

Connecting example when using the contrast synchronization function/shutter synchronization function

In a case to construct a multi-display by linking projected images from multiple projectors, following functions can be used by synchronizing multiple projectors using the <MULTI PROJECTOR SYNC IN> terminal and the <MULTI PROJECTOR SYNC OUT> terminal.

• Contrast synchronization function

A linked screen with balanced contrast can be displayed by sharing the brightness level of the video signal being input to each projector.

To use this function, set the [PROJECTOR SETUP] menu → [MULTI PROJECTOR SYNC] for each synchronized projector as follows.

– Set [MULTI PROJECTOR SYNC] → [MODE] to anything other than [OFF].

Set [MODE] to [MASTER] only on one projector that is synchronized. Set [MODE] to [SLAVE] for all other projectors.

– Set [MULTI PROJECTOR SYNC] → [CONTRAST SYNC] to [ON].

• Shutter synchronization function

This is a function to synchronize the shutter operation of the specified projector to other projectors, and the effect using the shutter function including the fade in/fade out operation can be synchronized.

To use this function, set the [PROJECTOR SETUP] menu → [MULTI PROJECTOR SYNC] for each synchronized projector as follows.

– Set [MULTI PROJECTOR SYNC] → [MODE] to anything other than [OFF].

Set [MODE] to [MASTER] only on one projector that becomes the synchronization source within the linked projectors. Set [MODE] to [SLAVE] for all other projectors.

– Set [MULTI PROJECTOR SYNC] → [SHUTTER SYNC] to [ON].

Connecting example

Connect all the projectors to be linked in a loop by daisy chain connection when using the contrast synchronization function/shutter synchronization function. The number of linked projectors is limited to the maximum of 64 projectors.

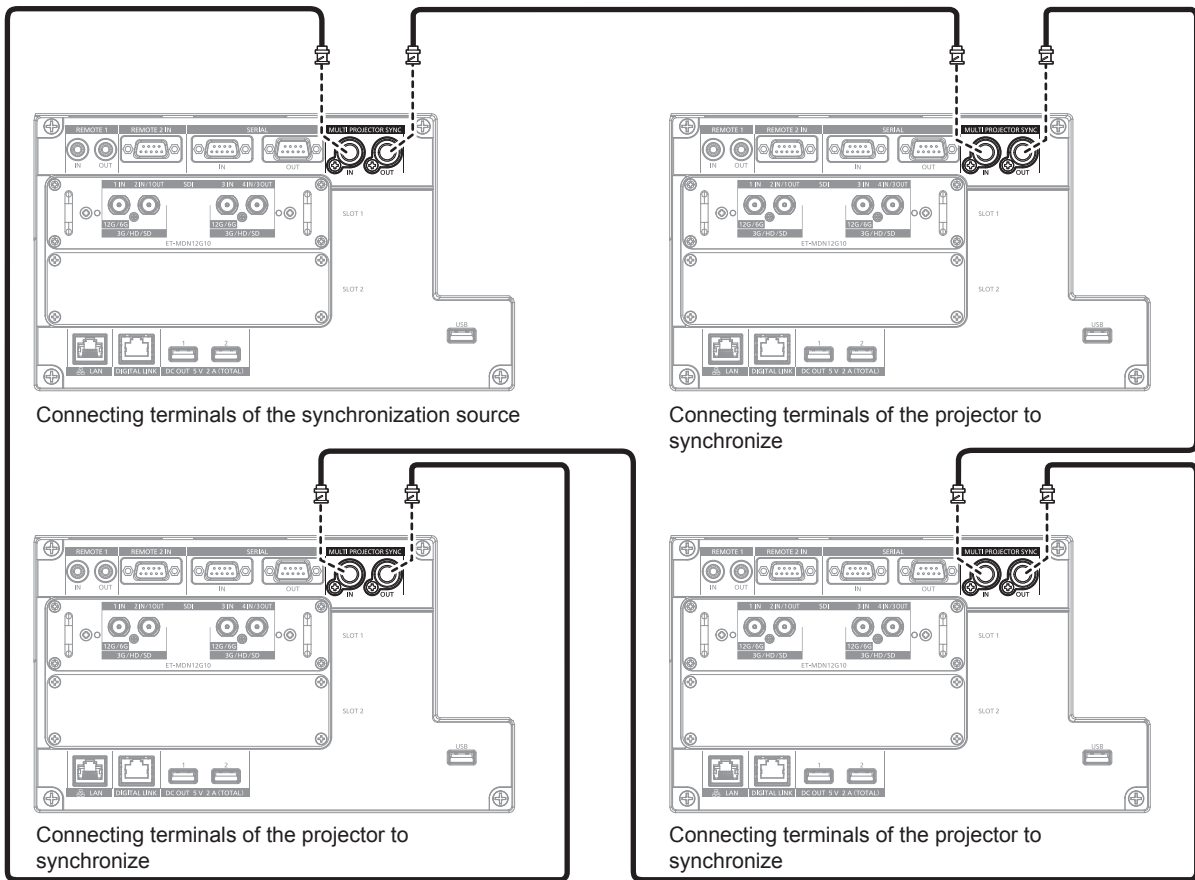

Note

- The contrast synchronization function and the shutter synchronization function can be used simultaneously.
- For details on the settings of the contrast synchronization function and the shutter synchronization function, refer to the [PROJECTOR SETUP] menu → [MULTI PROJECTOR SYNC] (▶ page 168).
- The menu items in the [PROJECTOR SETUP] menu → [MULTI PROJECTOR SYNC] is the same as the following setting items.
 - The [PICTURE] menu → [DYNAMIC CONTRAST] → [USER] → [MULTI PROJECTOR SYNC]
 - The [DISPLAY OPTION] menu → [SHUTTER SETTING] → [MULTI PROJECTOR SYNC]
- If there are any projectors which you do not want to synchronize within the linked projectors, set [CONTRAST SYNC] and [SHUTTER SYNC] to [OFF] individually.
- The shutter synchronization function will operate even when there are different models within the linked projectors. However, the synchronization function will not operate when there is a DLP projector that is constructed with one DLP chip such as PT-RCQ10 series within the linked projectors.

Chapter 3 Basic Operations

This chapter describes basic operations to start with.

Switching on/off the projector

Connecting the power cord

Confirm that the <MAIN POWER> switch is on the <OFF> side before connecting the supplied power cord. Use the power cord matching with the power supply voltage and the shape of the outlet.

For details of power cord handling, refer to “Read this first!” (➡ page 5). For the shape of the outlet, refer to “Usable outlet” (➡ page 40).

Attention

- The <AC IN> terminal on the side of the projector and the connector of the supplied power cord are not hot swapping compatible. Make sure to attach the power cord to the projector first, and then connect the power plug to the outlet. When removing the power cord from the projector, make sure to remove the power plug from the outlet first.

Note

- The light output will decrease to approximately 1/5 when using the projector with AC 100 V to AC 120 V.
- The supplied power cords vary depending on the country or region where you purchased the product.

How to attach the power cord

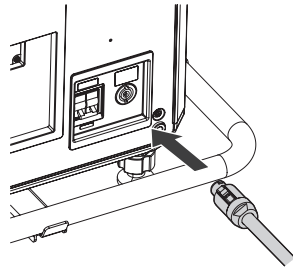

Fig. 1

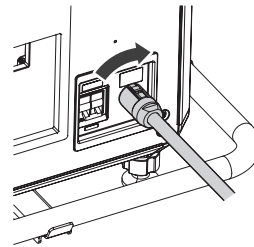

Fig. 2

- 1) Check the shapes of the <AC IN> terminal on the side of the projector and the power cord connector, then insert the connector completely in the correct direction. (Fig. 1)
- 2) While inserting the power cord connector into the projector, turn clockwise until it clicks. (Fig. 2)

How to remove the power cord

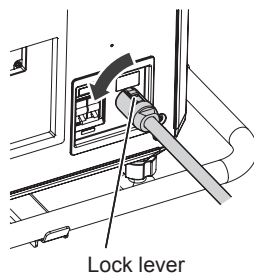

Fig. 1

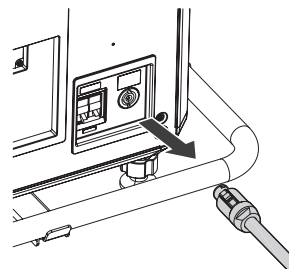
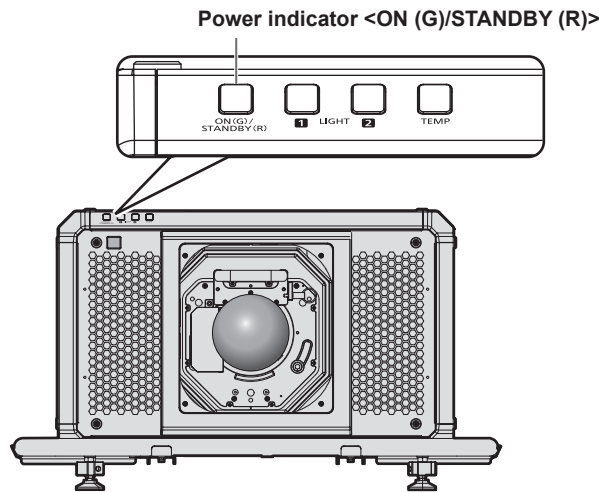

Fig. 2

- 1) Confirm that the <MAIN POWER> switch on the side of the projector is on the <OFF> side, and remove the power plug from the outlet.
- 2) Turn the power cord connector counterclockwise while sliding the lock lever forward (Fig. 1), and remove the connector from the <AC IN> terminal on the projector (Fig. 2).

Power indicator

Indicate the status of the power. Check the status of the power indicator <ON (G)/STANDBY (R)> before operating the projector.



Indicator status		Projector status
Off		The main power is switched off.
Red	Lit	The power is switched off. (standby mode) Projection will start when the power on < > button is pressed. • The projector may not operate when the light source indicators <LIGHT1>/<LIGHT2> or the temperature indicator <TEMP> are blinking. (➡ page 251)
	Blinking	The output image equivalent to the projected image from the projector is being viewed using the web control function. Refer to "[Remote preview] page" (➡ page 205) for details.
Green	Lit	Projecting.
Orange	Lit	The projector is preparing to switch off the projector. The power is switched off after a while. (Changes to the standby mode.)

Note

- While the power indicator <ON (G)/STANDBY (R)> lights in orange, the fan is running to cool the projector.
- The projector consumes power even in standby mode (power indicator <ON (G)/STANDBY (R)> lit in red). Refer to "Power consumption" (➡ page 290) for the power consumption.
- When the projector receives the signal from the remote control, the power indicator <ON (G)/STANDBY (R)> will blink in the following color according to the status of the projector.
 - When the projector is in projection mode: Green
 - When the projector is in standby mode: Orange
- The power indicator <ON (G)/STANDBY (R)> will blink slowly in green while the shutter function is in use (shutter: closed), or while the function of the [PROJECTOR SETUP] menu → [NO SIGNAL SETTING] → [NO SIGNAL LIGHTS-OUT] (➡ page 164) is operating and the light source is turned off.

Switching on the projector

Install the projection lens before switching on the projector.
Remove the lens cover first.

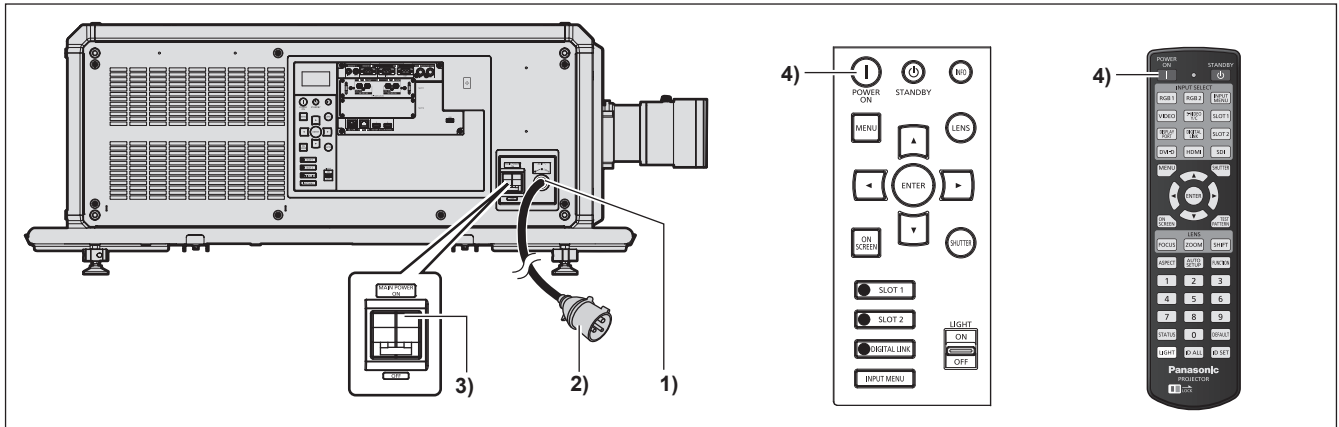

- 1) **Connect the power cord to the projector.**
- 2) **Connect the power plug to an outlet.**
- 3) **Press the handle of the <MAIN POWER> switch to the <ON> side to turn on the power.**
 - The power indicator <ON (G)/STANDBY (R)> lights in red, and the projector enters the standby mode.
- 4) **Press the power on <|> button.**
 - The power indicator <ON (G)/STANDBY (R)> lights in green and the image is soon projected on the screen.

Attention

- Always remove the lens cover before starting the projection. Projecting continuously while the lens cover is attached may cause the lens cover to heat up and result in a fire.

Note

- A warm-up period of up to approximately five minutes may be necessary until an image is displayed when the projector is switched on at around 0 °C (32 °F).
The temperature indicator <TEMP> lights during the warm-up period. When the warm-up is completed, the temperature indicator <TEMP> turns off and the projection starts. Refer to “When an indicator lights up” (► page 251) for the indicator status display.
- If the operating environment temperature is low and warm-up takes more than five minutes, the projector will judge that a problem has occurred and the power will automatically be set to standby mode. In such case, increase the operating environment temperature to 0 °C (32 °F) or higher, turn off the main power, and then turn on the power again.
- If the power was turned off during projection at the previous use by setting the <MAIN POWER> switch to <OFF> or by using the breaker directly while projecting, the power indicator <ON (G)/STANDBY (R)> lights up in green and an image is projected after a while when the power is turned on by setting the <MAIN POWER> switch to <ON> or by turning the breaker on with the power plug connected to the outlet. This applies only when the [PROJECTOR SETUP] menu → [INITIAL STARTUP] is set to [LAST MEMORY].
- The light output will decrease to approximately 1/5 when using the projector with AC 100 V to AC 120 V.

When the initial setting screen is displayed

When the projector is switched on for the first time after purchase, or when the [PROJECTOR SETUP] menu → [INITIALIZE] → [FACTORY RESET] is executed, the focus adjustment screen is displayed after projection starts, and then the [INITIAL SETTING] screen is displayed. Set them according to the circumstances.

In other occasions, you can change the settings by menu operations.

If you press the <MENU> button while the [INITIAL SETTING] screen is displayed, you can go back to the previous screen.

Focus adjustment

Adjust the focus to display the menu screen clearly.

You may also need to adjust the zoom and lens shift.

Refer to “Adjusting the focus, zoom, and lens shift” (➔ page 71) for details.

- 1) Press ▲▼◀▶ to adjust the focus.

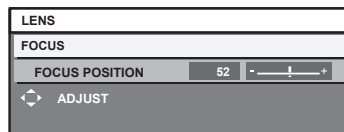

- 2) Press the <MENU> button to proceed to the initial setting.

Initial setting (display language)

Select the language to show on the screen.

After completed the initial setting, you can change the display language from the [DISPLAY LANGUAGE] menu.

- 1) Press ▲▼ to select the display language.

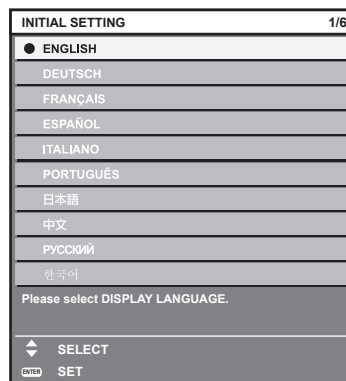

- 2) Press the <ENTER> button to proceed to the initial setting.

Initial setting (operation setting)

Set the items for the operating method depending on the projector's application and duration of usage.

After completed the initial setting, you can change the settings of each item from the [PROJECTOR SETUP] menu → [OPERATION SETTING]. If you change the settings while using the projector, the duration until the brightness decreases to half may shorten or the brightness may decrease.

This initial setting (operation setting) is prepared to complete the settings simply at once during the installation when the operation of the projector is predetermined. This cannot set all the items regarding the operation setting. When the detailed setting is required or setting change is required, ask the person responsible for this projector (such as a person in charge of equipment or operation).

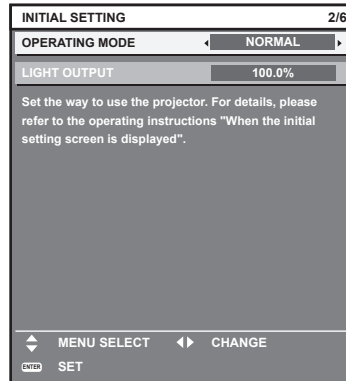

Note

- For the relationship between the brightness and the runtime, refer to "Relationship between brightness and runtime" (► page 64).
- For details on each setting item, refer to the [PROJECTOR SETUP] menu → [OPERATION SETTING].

1) Press ▲▼ to select [OPERATING MODE].

2) Press ◀▶ to switch the item.

- The items will switch each time you press the button.

[NORMAL]	Set this item when high luminance is required. The estimated runtime is approximately 20 000 hours or more*1.
[ECO]	The brightness will decrease compared to [NORMAL], but set this item to prioritize the life of the light source. The estimated runtime is approximately 24 000 hours or more*1.
[USER1]	Set [LIGHT OUTPUT] as desired.
[USER2]	
[USER3]	

*1 Estimated runtime is the time until the brightness decreases to approximately half of the time of delivery when the projector is used with the [PICTURE] menu → [DYNAMIC CONTRAST] set to [3] and under environment of 0.15 mg/m³ dust.
The value of runtime is just an estimate, and is not the warranty period.

3) Press ▲▼ to select [LIGHT OUTPUT].

4) Press ◀▶ to adjust.

Operation	Adjustment		Range of adjustment
	Brightness	Runtime	
Press ▶.	The screen becomes brighter.	The runtime becomes shorter.	8.0 % - 100.0 %
Press ◀.	The screen becomes darker.	The runtime becomes longer.	

5) Press the <ENTER> button to proceed to the initial setting.

Relationship between brightness and runtime

The projector can be operated with arbitrary brightness and runtime by setting [LIGHT OUTPUT] to desired setting.

The relationship between the [LIGHT OUTPUT] setting, brightness, and the estimated runtime is as follows. Make the initial setting (operation setting) depending on the desired brightness of the projected image and runtime.

The values of the brightness and the runtime are just an estimate, and the graph indicating the relationship is just an example. Also, these do not indicate the warranty period.

[LIGHT OUTPUT] (%)	Brightness (lm)	Estimated runtime*1 (hours)
100.0	50 000	27 000
80.0	40 000	39 500
70.0	35 000	47 500
60.0	30 000	56 500
50.0	25 000	66 500

*1 Estimated runtime is the time until the brightness decreases to approximately half of the time of delivery when the projector is used with the [PICTURE] menu → [DYNAMIC CONTRAST] set to [3] and under environment of 0.15 mg/m³ dust.

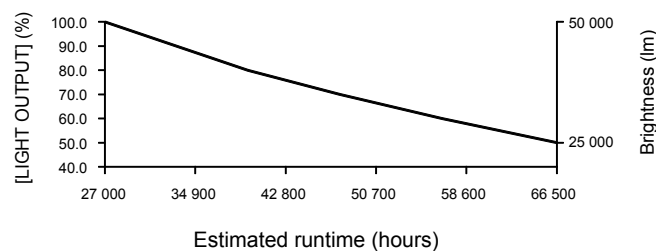

Note

- Under influence of characteristics of each light source, conditions of use, installation environment, etc., the runtime may be shorter than the estimation.
- If the consolidated runtime of the projector exceeds 20 000 hours, replacement of the components inside the projector may be required. The consolidated runtime can be confirmed in the [STATUS] screen. Refer to the [PROJECTOR SETUP] menu → [STATUS] for details.
- After completed the initial setting, the wider the combination of luminance and runtime becomes by setting the [PROJECTOR SETUP] menu → [BRIGHTNESS CONTROL] → [BRIGHTNESS CONTROL SETUP] → [CONSTANT MODE] to [AUTO] or [PC]. Refer to the [PROJECTOR SETUP] menu → [BRIGHTNESS CONTROL] for details.

Initial setting (installation setting)

Set [FRONT/REAR] and [FLOOR/CEILING] in [PROJECTION METHOD] depending on the installation mode. Refer to “Installation mode” (➔ page 40) for details.

After completed the initial setting, you can change the setting from the [PROJECTOR SETUP] menu → [PROJECTION METHOD].

1) Press ◀▶ to switch the setting.

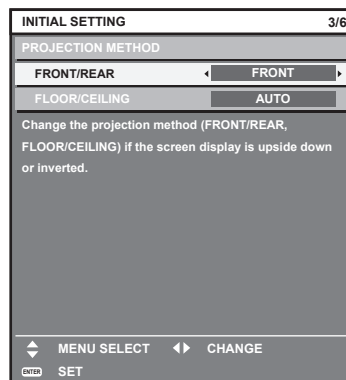

2) Press the <ENTER> button to proceed to the initial setting.

Initial setting (screen setting)

Set the screen format (aspect ratio) and display position of the image.

After completed the initial setting, you can change the settings of each item from the [DISPLAY OPTION] menu → [SCREEN SETTING].

1) Press ◀▶ to switch the setting.

- The setting will change each time you press the button.

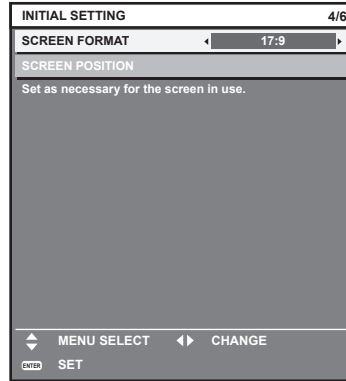

2) Press ▲▼ to select [SCREEN POSITION].

- [SCREEN POSITION] cannot be selected or adjusted when [SCREEN FORMAT] is set to [17:9].

3) Press ◀▶ to adjust.

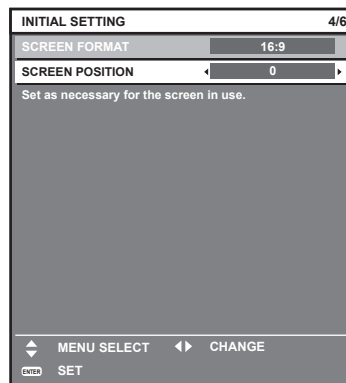

4) Press the <ENTER> button to proceed to the initial setting.

Initial setting (time zone)

Set [TIME ZONE] in accordance with the country or region where you use the projector.

After completed the initial setting, you can change the setting from the [PROJECTOR SETUP] menu → [DATE AND TIME]. The current settings are displayed in [LOCAL DATE] and [LOCAL TIME].

1) Press ◀▶ to switch the setting.

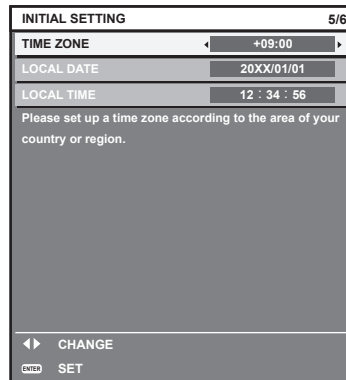

2) Press the <ENTER> button to proceed to the initial setting.

Note

- In the factory default setting, the time zone of the projector is set to +09:00 (Japan and Korea Standard Time). Change the setting of the [PROJECTOR SETUP] menu → [DATE AND TIME] → [TIME ZONE] to the time zone of the region where you use the projector.

Initial setting (date and time)

Set the local date and time.

After completed the initial setting, you can change the setting from the [PROJECTOR SETUP] menu → [DATE AND TIME].

To set the date and time automatically, refer to “Setting the date and time automatically” (➡ page 166).

1) Press ▲▼ to select an item.

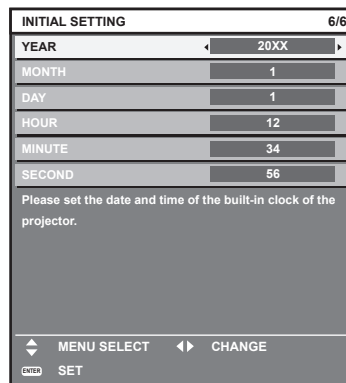

2) Press ◀▶ to switch the setting.

3) Press the <ENTER> button.

- Confirm the setting value and complete the initial setting.

Making adjustments and selections

It is recommended to perform the focus adjustment after 30 minutes have elapsed with the focus test pattern displayed. For details of the test pattern, refer to “[TEST PATTERN] menu” (➔ page 181). To use the active focus optimizer function, set the [PROJECTOR SETUP] menu → [LENS] → [ACTIVE FOCUS OPTIMIZER] → [ACTIVE FOCUS] to [ON], and then adjust the focus. (➔ page 148)

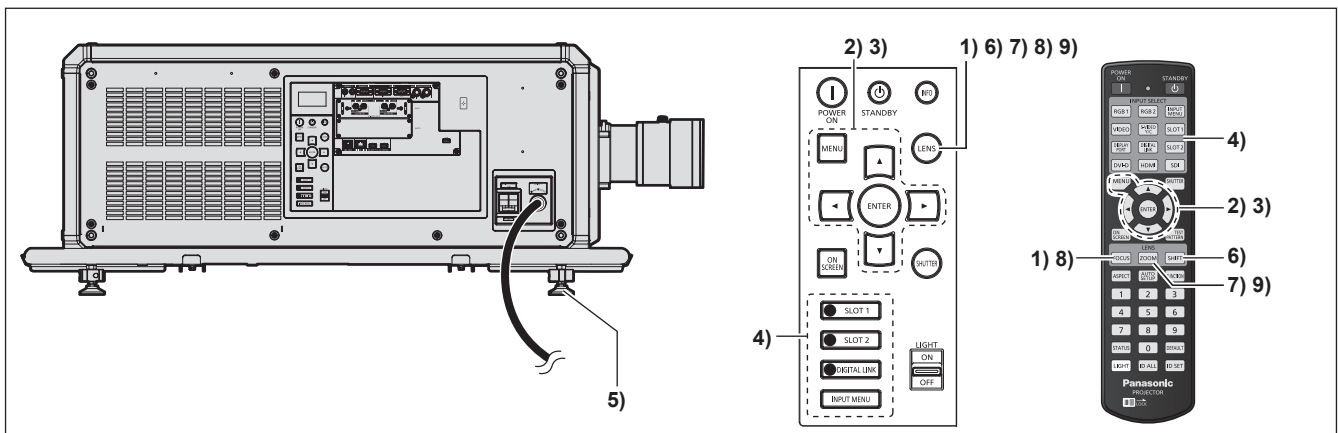

- 1) Press the <FOCUS> button to roughly adjust the focus of the projected image. (➔ page 71)
- 2) Change the setting of the [PROJECTOR SETUP] menu → [PROJECTION METHOD] depending on the installation mode. (➔ page 40)
 - Refer to “Navigating through the menu” (➔ page 84) for the operation of the menu screen.
- 3) Execute the lens calibration.
 - Execute the lens calibration when using the projector for the first time after attaching the projection lens. (➔ page 73)
- 4) Select the input by pressing the input selection button on the remote control or the control panel.
 - The buttons that can be used on the remote control or the control panel are as follows.

Remote control:
 <SDI> button, <DIGITAL LINK> button, <HDMI> button, <DVI-D> button, <DISPLAYPORT> button, <SLOT 1> button, <SLOT 2> button

Control panel:
 <DIGITAL LINK> button, <SLOT 1> button, <SLOT 2> button
 - For details of operation for input selection, refer to “Selecting the input signal” (➔ page 69).
- 5) Adjust the front, back and sideway tilt of the projector with the adjustable feet. (➔ page 48)
- 6) Press the <SHIFT> button to adjust the position of the projected image.
- 7) Press the <ZOOM> button to match the projected image size to the screen.
- 8) Press the <FOCUS> button again to adjust the focus.
- 9) Press the <ZOOM> button again to adjust the zoom and match the projected image size to the screen.

Note

- When the projector is switched on for the first time after purchase, or when the [PROJECTOR SETUP] menu → [INITIALIZE] → [FACTORY RESET] is executed, the focus adjustment screen is displayed after projection starts, and then the [INITIAL SETTING] screen is displayed. For details, refer to “When the initial setting screen is displayed” (➔ page 62).

Switching off the projector

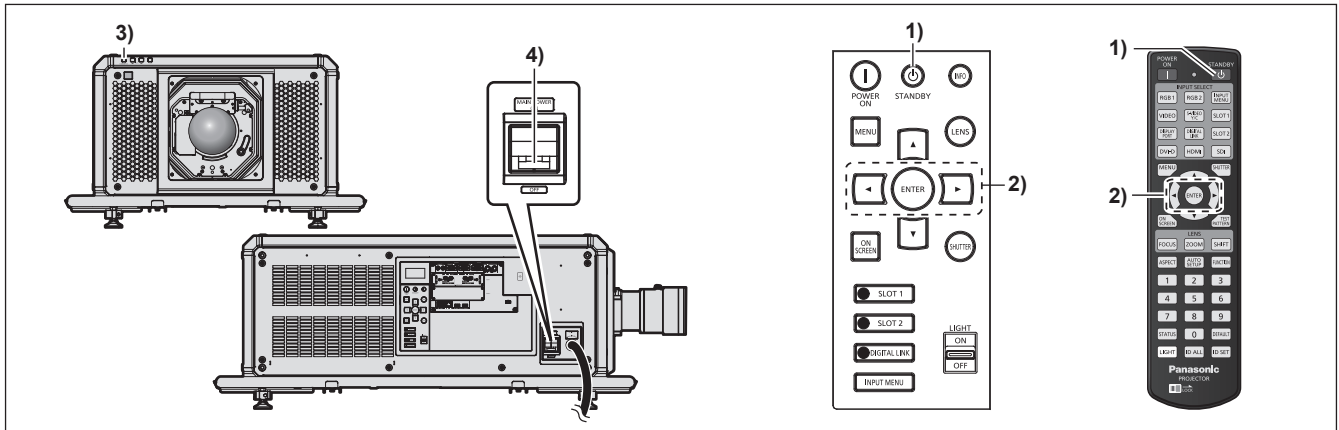

- 1) Press the power standby <⏻> button.
 - The [POWER OFF(STANDBY)] confirmation screen is displayed.
- 2) Press ◀▶ to select [OK], and press the <ENTER> button.
(Or press the power standby <⏻> button again.)
 - Projection of the image will stop, and the power indicator <ON (G)/STANDBY (R)> on the projector body lights in orange. (The fan keeps running.)
- 3) Wait for a few seconds until the power indicator <ON (G)/STANDBY (R)> of the projector body lights up in red (fan is stopped).
- 4) Press the handle of the <MAIN POWER> switch to the <OFF> side to turn off the power.

Attention

- When switching off the projector, make sure to follow the procedures described. Failure to do so may damage the internal components and result in malfunctions.

Note

- Even when the power standby <⏻> button is pressed and the projector is switched off, the projector consumes power if the main power of the projector is on.
- The <MAIN POWER> switch of the projector is equipped with an overcurrent protection function. When current exceeding 30 A is detected, the overcurrent is automatically disconnected and the circuit in the switch will become open. Ask your dealer for repair when the overcurrent protection function has operated.

Projecting

Check the projection lens attachment (➔ page 49), external device connection (➔ page 52), and power cord connection (➔ page 59), and then switch on the power (➔ page 61) to start projecting. Select the video for projection, and adjust appearance of the projected image.

Selecting the input signal

The input of the image to project can be switched. Method to switch the input is as follows.

- Press the input selection button on the remote control and directly specify the input of the image to project.
- Press the input selection button on the control panel and directly specify the input of the image to project.
- Display the input selection screen and select the input of the image to project from the list.

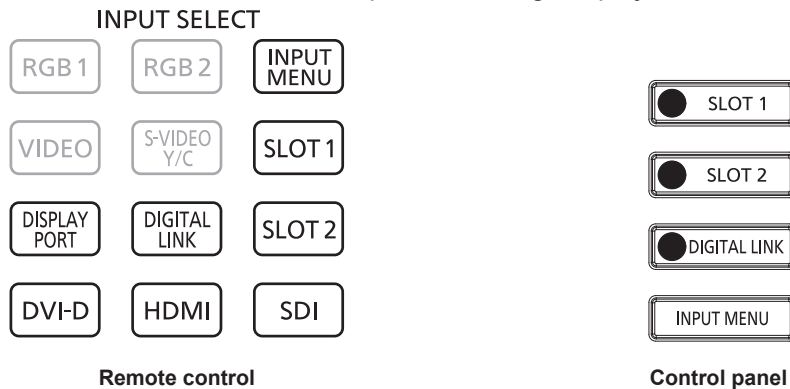

Switching the input directly with the remote control

The input of the image to project can be switched by directly specifying it with the input selection button on the remote control.

- 1) Press the input selection button (<HDMI>, <DISPLAYPORT>, <DVI-D>, <SDI>, <SLOT 1>, <SLOT 2>, <DIGITAL LINK>).

<HDMI>	Switches the input to HDMI. This can be operated when the optional Interface Board equipped with the HDMI input is installed in the slot. The input is switched every time the button is pressed when one of the HDMI inputs is selected on the installed optional Interface Board.
<DISPLAYPORT>	Switches the input to DisplayPort. This can be operated when the optional Interface Board equipped with the DisplayPort input is installed in the slot. The input is switched every time the button is pressed when one of the DisplayPort inputs is selected on the installed optional Interface Board.
<DVI-D>	Switches the input to DVI-D. This can be operated when the optional Interface Board equipped with the DVI-D input is installed in the slot. The input is switched every time the button is pressed when one of the DVI-D inputs is selected on the installed optional Interface Board.
<SDI>	Switches the input to SDI. This can be operated when the optional Interface Board equipped with the SDI input is installed in the slot. The input is switched every time the button is pressed when one of the SDI inputs is selected on the installed optional Interface Board.
<SLOT 1>	Switches the input to the signal of the optional Interface Board installed in <SLOT 1>. The input is switched every time the button is pressed when one of the inputs is selected on the installed optional Interface Board.
<SLOT 2>	Switches the input to the signal of the optional Interface Board installed in <SLOT 2>. The input is switched every time the button is pressed when one of the inputs is selected on the installed optional Interface Board.
<DIGITAL LINK>	Switches the input to DIGITAL LINK. The image of the signal input to the <DIGITAL LINK> terminal is projected.

Attention

- Images may not be projected properly depending on the external device, or the Blu-ray disc or DVD disc, to be played back.
Set the [PICTURE] menu → [SYSTEM SELECTOR]. When the SDI signal is input, set the [DISPLAY OPTION] menu → [SLOT IN].

- Confirm the aspect ratio of the projection screen and the image, and switch to an optimum aspect ratio from the [POSITION] menu → [ASPECT].

Note

- When the optional DIGITAL LINK output supported device (Model No.: ET-YFB100G, ET-YFB200G) is connected to the <DIGITAL LINK> terminal, the input on the DIGITAL LINK output supported device changes each time the <DIGITAL LINK> button is pressed. The input can also be changed using the RS-232C control command.
For twisted-pair-cable transmitters of other manufacturers, switch the input on the projector to DIGITAL LINK, and then switch the input on the twisted-pair-cable transmitter.
- <HDMI> button, <DISPLAYPORT> button, <DVI-D> button, <SLOT 1> button, and <SLOT 2> button can be used when the optional Interface Board equipped with corresponding input is installed in the slot.
- The operation when the <HDMI> button, <DISPLAYPORT> button, <DVI-D> button, <SDI> button, <SLOT 1> button, or <SLOT 2> button is pressed can be fixed to operation to switch to the specified input using the [SECURITY] menu → [CONTROL DEVICE SETUP].

Switching the input directly with the control panel

The input of the image to project can be switched by directly specifying it with the input selection button on the control panel.

1) Press the input selection button (<SLOT 1>, <SLOT 2>, <DIGITAL LINK>).

<SLOT 1>	Switches the input to the signal of the optional Interface Board installed in <SLOT 1>. The input is switched every time the button is pressed when one of the inputs is selected on the installed optional Interface Board.
<SLOT 2>	Switches the input to the signal of the optional Interface Board installed in <SLOT 2>. The input is switched every time the button is pressed when one of the inputs is selected on the installed optional Interface Board.
<DIGITAL LINK>	Switches the input to DIGITAL LINK. The image of the signal input to the <DIGITAL LINK> terminal is projected.

Attention

- Images may not be projected properly depending on the external device, or the Blu-ray disc or DVD disc, to be played back. Set the [PICTURE] menu → [SYSTEM SELECTOR]. When the SDI signal is input, set the [DISPLAY OPTION] menu → [SLOT IN].
- Confirm the aspect ratio of the projection screen and the image, and switch to an optimum aspect ratio from the [POSITION] menu → [ASPECT].

Note

- When the optional DIGITAL LINK output supported device (Model No.: ET-YFB100G, ET-YFB200G) is connected to the <DIGITAL LINK> terminal, the input on the DIGITAL LINK output supported device changes each time the <DIGITAL LINK> button is pressed. The input can also be changed using the RS-232C control command.
For twisted-pair-cable transmitters of other manufacturers, switch the input on the projector to DIGITAL LINK, and then switch the input on the twisted-pair-cable transmitter.
- The <SLOT 1> button and the <SLOT 2> button can be used when the optional Interface Board equipped with corresponding input is installed in the slot.
- The operation when the <SLOT 1> button or the <SLOT 2> button is pressed can be fixed to operation to switch to the specified input using the [SECURITY] menu → [CONTROL DEVICE SETUP].

Switching the input by displaying the input selection screen

The input of the image for projection can be selected by displaying the input selection screen.

1) Press the <INPUT MENU> button on the remote control or control panel.

- The input selection screen is displayed.

Following input selection screen is an example when the Interface Board for 12G-SDI (Model No.: ET-MDN12G10) is installed in <SLOT 1>, and the optional Interface Board for HDMI 2 input (Model No.: ET-MDNHM10) is installed in <SLOT 2>.

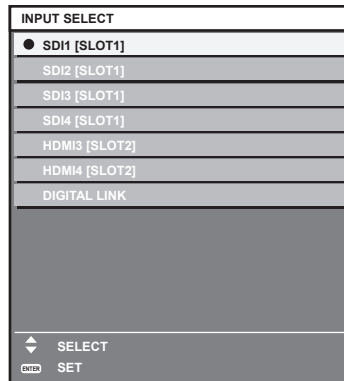

2) Press the <INPUT MENU> button again.

- The input will switch each time you press the <INPUT MENU> button.

Note

- Input can be switched by pressing ▲▼ to select the input of the image for projection and pressing the <ENTER> button while the input selection screen is displayed.
- If the optional DIGITAL LINK output supported device (Model No.: ET-YFB100G, ET-YFB200G) is connected to the projector, the input selection menu for the DIGITAL LINK output supported device is displayed when the <ENTER> button is pressed while the DIGITAL LINK input is selected in the input selection screen.
- If the optional DIGITAL LINK output supported device (Model No.: ET-YFB100G, ET-YFB200G) is connected to the projector, the DIGITAL LINK logo and the input name selected in the DIGITAL LINK output supported device are displayed in the display section of the [DIGITAL LINK] in the input selection screen.

Adjusting the focus, zoom, and lens shift

Adjust the focus, zoom, and lens shift if the image projected to the screen or its position is shifted even if the projector and the screen are set up in the correct positions.

- When the following projection lens is used, also refer to “Adjusting the focus balance” (➔ page 72).
 - Zoom Lens (Model No.: ET-D3QW300, ET-D3QS400, ET-D3QT500)

Using the control panel

1) Press the <LENS> button on the control panel.

- Pressing the button changes the adjustment screen in the order of [FOCUS], [ZOOM], and [SHIFT].

2) Select each item and press ▲▼◀▶ to adjust it.

Using the remote control

1) Press the lens buttons (<FOCUS>, <ZOOM>, <SHIFT>) on the remote control.

- Pressing the <FOCUS> button: Adjusts the focus (adjustment of the lens focus position).
- Pressing the <ZOOM> button: Adjusts the zoom (adjustment of the lens zoom position).
- Pressing the <SHIFT> button: Adjusts the lens shift (vertical position and horizontal position of the lens).

2) Select each item and press ▲▼◀▶ to adjust it.

CAUTION

During the lens shift operation, do not insert your hand in any opening around the lens.
Your hand may be caught in between, resulting to injury.

Note

- The adjustment can be performed faster by holding down ▲▼◀▶ for approximately six seconds or longer while adjusting the focus, or for approximately three seconds or longer while adjusting the lens shift.
- It is recommended to perform the focus adjustment after 30 minutes have elapsed with the focus test pattern displayed. For details of the test pattern, refer to “[TEST PATTERN] menu” (➡ page 181). To use the active focus optimizer function, set the [PROJECTOR SETUP] menu → [LENS] → [ACTIVE FOCUS OPTIMIZER] → [ACTIVE FOCUS] to [ON], and then adjust the focus. (➡ page 148)
- Only [FOCUS] is shown in yellow so that the displayed menu item can be recognized by color, even when the projector is not focused and displayed characters are unreadable. (Factory default)
The displayed color of [FOCUS] differs depending on the setting of the [DISPLAY OPTION] menu → [ON-SCREEN DISPLAY] → [OSD DESIGN].
- If the power is turned off during the focus adjustment, the zoom adjustment, or the lens shift adjustment, turn on the power again and execute the [PROJECTOR SETUP] menu → [LENS] → [LENS CALIBRATION].
- When the main power is switched off during focus adjustment, lens calibration is performed automatically during the next focus adjustment.
- If the main power is turned off during the lens shift adjustment, a lens calibration error screen is displayed during the next lens shift adjustment. Execute the [PROJECTOR SETUP] menu → [LENS] → [LENS CALIBRATION].
- Request a repair to your dealer if the lens calibration error screen is displayed even though the lens calibration is executed.

Adjusting the focus balance

By changing the projected image size, the focus balance in the center and periphery of the image may be lost.

- When the following projection lens is used, the focus balance in the center and periphery of the projected image can be adjusted on the projection lens side.
 - Zoom Lens (Model No.: ET-D3QW300, ET-D3QS400, ET-D3QT500)
- Illustrations are examples. The structure of the adjustment part of the periphery focus differs depending on the type of the projection lens.

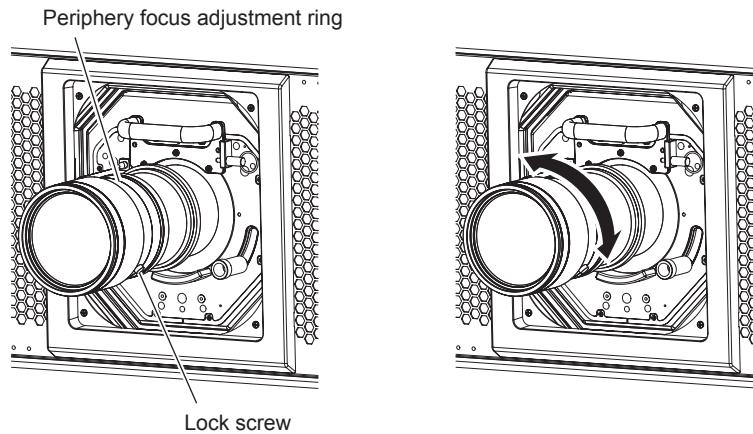

- 1) Loosen the lock screw.**
 - Turn the lock screw on the side of the projection lens counterclockwise to loosen.
- 2) Turn the tip of the lens barrel or the periphery focus adjustment ring towards the direction of the arrow by hand and align it with the scale of the projection distance.**
 - Align the mark on the tip of the lens barrel or the periphery focus adjustment ring with the actual projection distance between the front end of the projection lens and the screen.
- 3) Tighten the lock screw.**
 - The tip of the lens barrel or the periphery focus adjustment ring is fixed.
- 4) Adjust the focus of the center of the image.**
 - For the steps to adjust the focus, refer to “Adjusting the focus, zoom, and lens shift” (➡ page 71).
 - The projected image size may change when the focus balance in the center and periphery of the image is adjusted.
When adjusting the focus balance, check the image size as well.

Note

- When the projector is used for the first time or when the projection lens is replaced, execute the [PROJECTOR SETUP] menu → [LENS] → [LENS CALIBRATION].
- The projection distance and scale shown on the projection lens are an approximate guide. This does not correspond to the projection distance range supported by the projector.

Executing the lens calibration

When the projector is used for the first time or when the projection lens is replaced, execute the lens calibration. Detect the lens adjustment limit value, and perform the calibration in the adjustment range.

- 1) **Press the <MENU> button.**
 - The [MAIN MENU] screen is displayed.
- 2) **Press ▲▼ to select [PROJECTOR SETUP].**
- 3) **Press the <ENTER> button.**
 - The [PROJECTOR SETUP] screen is displayed.
- 4) **Press ▲▼ to select [LENS].**
- 5) **Press the <ENTER> button.**
 - The [LENS] screen is displayed.
- 6) **Press ▲▼ to select [LENS CALIBRATION].**
- 7) **Press the <ENTER> button.**
 - The [LENS CALIBRATION] screen is displayed.
- 8) **Press ▲▼ to select an item.**

[SHIFT/FOCUS/ZOOM]	Executes the calibrations for the lens shift, focus, and zoom. After completing the calibration in the adjustment range, the projection lens will move to the home position.
[SHIFT/FOCUS]	Executes the calibrations for the lens shift and focus. After completing the calibration in the adjustment range, the projection lens will move to the home position.
[ZOOM]	Executes the calibration of the zoom adjustment range.

- 9) **Press the <ENTER> button.**
 - The confirmation screen is displayed.
- 10) **Press ◀▶ to select [OK], and press the <ENTER> button.**
 - The lens calibration is started.

Note

- For details of operation, refer to the [PROJECTOR SETUP] menu → [LENS] → [LENS CALIBRATION] (▶ page 154).
- The origin position of the lens mounter and the home position of the projection lens are automatically updated when the lens shift calibration is performed. The home position is an origin position of the lens shift (vertical position and horizontal position of the lens) based on the calibration result. It does not match with the optical image center position.

Moving the projection lens to the home position

Operate in following procedure to move the projection lens to the home position.

When operating from the main menu

- 1) **Press the <MENU> button.**
 - The [MAIN MENU] screen is displayed.
- 2) **Press ▲▼ to select [PROJECTOR SETUP].**
- 3) **Press the <ENTER> button.**
 - The [PROJECTOR SETUP] screen is displayed.
- 4) **Press ▲▼ to select [LENS].**
- 5) **Press the <ENTER> button.**
 - The [LENS] screen is displayed.
- 6) **Press ▲▼ to select [LENS HOME POSITION].**

7) Press the <ENTER> button.

- The confirmation screen is displayed.

8) Press ◀▶ to select [OK], and press the <ENTER> button.

- The projection lens is moved to the home position.

Note

- [PROGRESS] is displayed in the menu while the projection lens is moved to the home position.
- The projection lens is not moved to the correct home position when the [PROJECTOR SETUP] menu → [LENS] → [LENS CALIBRATION] is not executed.
- The home position does not match with the optical image center position.

When operating from the lens shift adjustment screen

1) Press the <DEFAULT> button on the remote control while displaying the lens shift adjustment screen.

- The confirmation screen is displayed.

2) Press ◀▶ to select [OK], and press the <ENTER> button.

- The projection lens is moved to the home position.

Note

- [PROGRESS] is displayed in the menu while the projection lens is moved to the home position.
- The projection lens is not moved to the correct home position when the [PROJECTOR SETUP] menu → [LENS] → [LENS CALIBRATION] is not executed.
- The [HOME POSITION] screen can also be displayed by pressing the <LENS> button on the control panel or the <SHIFT> button on the remote control for three seconds or longer.

Lens shift range

The projector can adjust the position of the projected image within the lens shift range for each projection lens based on the optical center position of the image (standard projection position). Optical center position of the image is an image position based on the optical axis center of the projector.

Perform the lens shift adjustment within the range indicated in the following illustration. Note that moving the lens outside the adjustment range may change the focus. This is because the shift of the lens is restricted to protect the optical parts.

Following illustration indicates the lens shift range when the projector is installed on desk/floor.

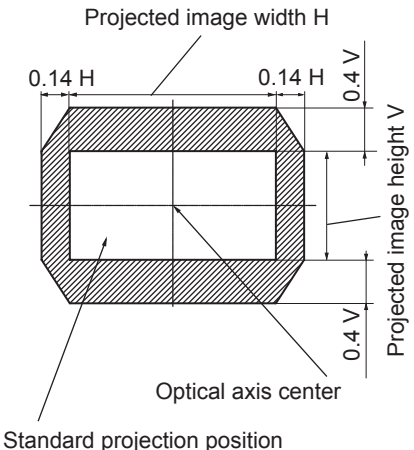
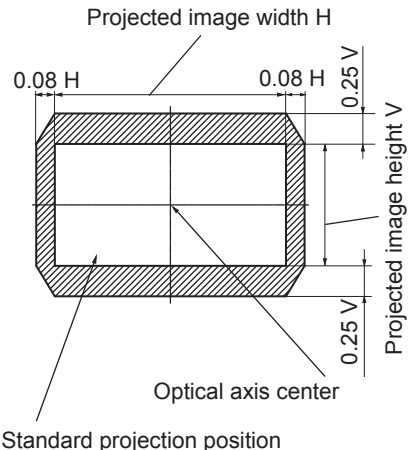
Projection lens Model No.	ET-D3QW300	ET-D3QT600
Lens shift range	 <p>Projected image width H</p> <p>0.14 H 0.14 H</p> <p>0.4 V</p> <p>Projected image height V</p> <p>Optical axis center</p> <p>Standard projection position</p>	 <p>Projected image width H</p> <p>0.08 H 0.08 H</p> <p>0.25 V</p> <p>Projected image height V</p> <p>Optical axis center</p> <p>Standard projection position</p>

Projection lens Model No.	ET-D3QS400, ET-D3QT500	ET-D3QT700, ET-D3QT800
Lens shift range		

Adjusting the lens mounter when the focus is unbalanced

Focus balance

Relationship between the tilt of the lens and the screen focus surface

When the projection lens is tilted in contrast with the image forming surface, tilting the front side (screen side) of the projection lens downwards (in the direction of the dotted arrow line), the upper side of the screen focus surface will tilt inwards and the lower side will tilt outwards as shown in the example.

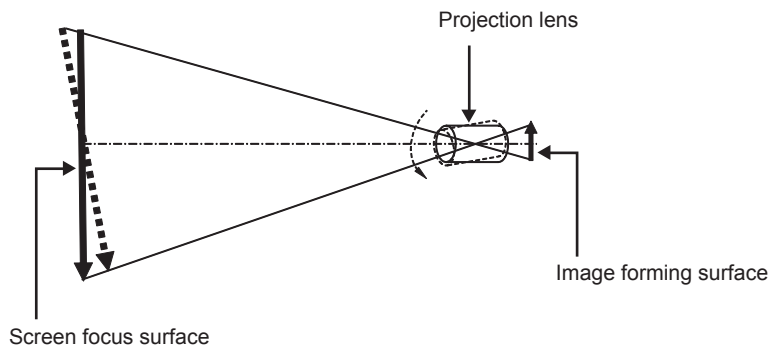

How to adjust the focus balance (adjustment by tilting the lens mounter)

When the entire screen surface is not uniform even if the focus has been adjusted, the lens mounter has focus adjustment screws in three locations.

- Tool used: Hex driver or Allen wrench (diagonal 4.0 mm (5/32"))

Lens mounter structure

Focus adjustment screws (a), (b), and (c) can be turned to move the lens mount bracket back and forth.

Also, tightening the fixed screws locks the lens mount bracket in place so it does not move.

When a projection lens with a large weight is installed, or when the projector is installed on an inclination, the lens may tilt and the focus may become unbalanced. In these cases, perform adjustment by referring to the relationship between the adjustment location and adjustment screws.

■ Front view diagram of the lens mounter (viewed from the screen side)

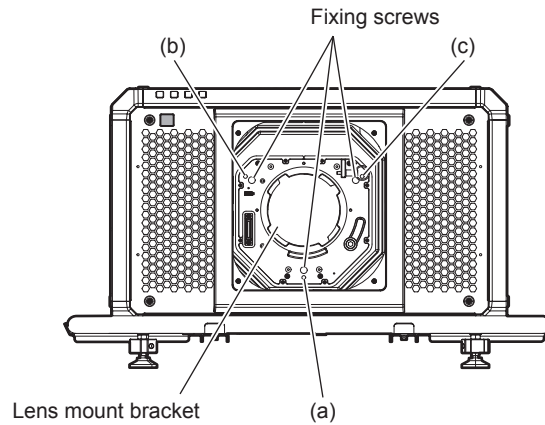

Note

- Focus adjustment screws (a), (b), and (c) are adjusted with the lens attached.

Adjustment procedure

■ Relationship between the adjustment location and adjustment screws

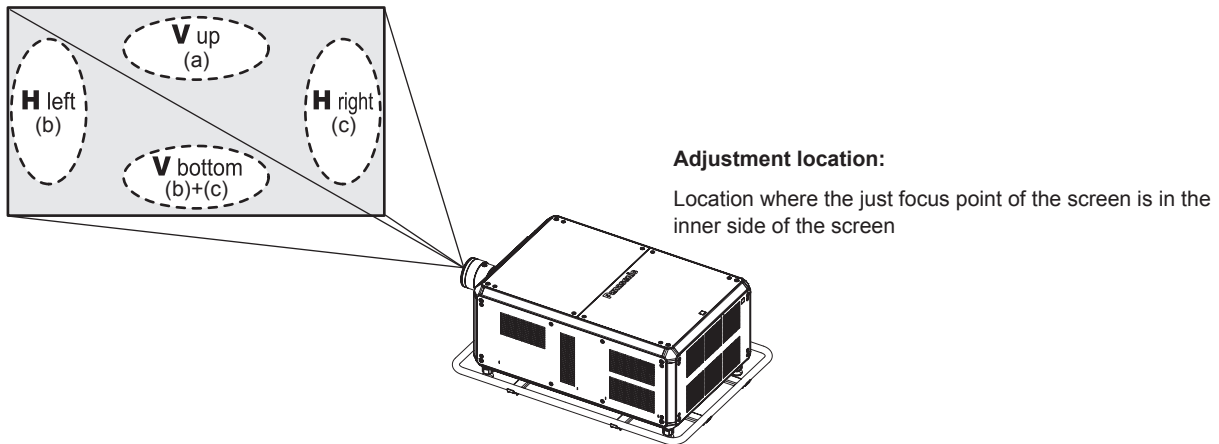

	When the just focus point of the screen in V up (top in the vertical direction) is in the inner side of the screen	When the just focus point of the screen in V bottom (bottom in the vertical direction) is in the inner side of the screen	When the just focus point of the screen in H left (left in the horizontal direction) is in the inner side of the screen	When the just focus point of the screen in H right (right in the horizontal direction) is in the inner side of the screen
(a)	Rotate counterclockwise	—	—	—
(b)	—	Rotate counterclockwise	Rotate counterclockwise	—
(c)	—	Rotate counterclockwise	—	Rotate counterclockwise

- 1) Press the <FOCUS> button on the remote control or the <LENS> button on the control panel to display the focus adjustment screen.
- 2) Press ▼ to shift the focus of the entire screen once.
- 3) Press ▲ to stop on any part of the screen to be the first just focus point.
 - For the location where focus is shifted in this state, the just focus point is on the inner side of the screen.
- 4) Loosen the fixed screws in the position relative to the location where the focus is shifted the most (the location where the just focus point is shifted the most towards the inner side in Step 2)) up to one and half rotations.
 - Turn screws clockwise in two locations, or at least in one location when making an adjustment.

- 5) **Slowly turn the focus adjustment screws corresponding to the locations counterclockwise and stop where the image is in focus. (➡ page 75)**
 - If the screws are turned counterclockwise, the tilt of the lens will change by moving the lens mount bracket of the lens mounter forward (screen side), and in the projected image on the screen, the focus point in the opposite direction of the adjustment screws will move from the inner side of the screen to the outside.
- 6) **Press the <SHIFT> button on the remote control or the <LENS> button on the control panel to display the lens shift adjustment menu, and reset the screen position of the projected image on the screen surface back to an optimal state.**
- 7) **Perform focus adjustment again near the center of the screen and if it is still not enough, fine tune the amount of rotation of the adjustment screws.**
- 8) **When adjustments have been made, securely tighten the loosened fixing screws.**
- 9) **Adjust the focus again using the remote control.**

Using the USB memory

This projector supports the attachment of the USB memory. Attach the USB memory to the <USB> terminal when using the data cloning function, the firmware update function, etc.

Note

- For the data cloning function, refer to the [PROJECTOR SETUP] menu → [DATA CLONING] (▶ page 178).
- For the firmware update function, refer to the [PROJECTOR SETUP] menu → [FIRMWARE UPDATE] (▶ page 180).

Notes on use

Observe following.

- Do not disassemble or modify the USB memory.
- Do not apply strong impact on the USB memory.
- Do not pour liquid such as water or get it wet.
- Do not place foreign object into the terminal section.
- Do not touch the metal terminal with hand or metal.
- Do not leave the USB memory in a place with high humidity or dust.
- Do not leave the USB memory in a place where static electricity or electromagnetic radiation is generated.
- Store the USB memory appropriately in a location that small children cannot reach.
- Immediately remove the USB memory from the projector when smoke or odor is noticed, and contact the manufacturer.
- Do not remove the USB memory from the projector while reading or writing the data.

USB memory that can be used with the projector

This projector supports the commercially available USB 2.0 compatible USB memory formatted in FAT16 or FAT32.

- Only the single partition structure is supported.

Attaching the USB memory

- 1) Insert the USB memory all the way in to the <USB> terminal.

Attention

- Take care of the orientation of the terminal when inserting the USB memory so that it will not get damaged.
- Do not use a USB extension cable or a USB hub, and directly insert the USB memory into the <USB> terminal of the projector.
- Do not insert the USB memory into the <DC OUT 1>/<DC OUT 2> terminals. The USB memory cannot be used on the <DC OUT 1>/<DC OUT 2> terminals.

Note

- The USB memory can be attached even when the projector is turned on.

Removing the USB memory

- 1) Remove the USB memory after confirming that the indicator on the USB memory is not blinking.

Attention

- The blinking of the indicator of the USB memory attached to the projector is indicating that the projector is accessing (reading or writing) the USB memory. Do not remove the USB memory from the projector when the indicator is blinking.
- The access status to the USB memory cannot be confirmed when a USB memory without the monitoring function such as indicator is used. In such case, remove the USB memory after confirming one of the following.
 - Turn off the projector.
 - When using the data cloning function, confirm that the saving or loading of the data to/from the USB memory is completed in the menu screen.
 - When using the firmware update function, wait until the projector automatically goes into standby after the update has started.

Operating with the remote control



Using the shutter function

If the projector is not used for a certain period of time during the meeting intermission, for example, it is possible to turn off the image temporarily.

button

- 1) **Press the <SHUTTER> button.**
 - The image disappears.
 - This operation can be also performed using the <SHUTTER> button on the control panel.
- 2) **Press the <SHUTTER> button again.**
 - The image is displayed.

Note

- The power indicator <ON (G)/STANDBY (R)> will blink slowly in green while the shutter function is in use (shutter: closed).
- You can set whether to use the mechanical shutter or not and the time for the fade in/fade out of the image using the [DISPLAY OPTION] menu → [SHUTTER SETTING].
- If [MECHANICAL SHUTTER] in the [DISPLAY OPTION] menu → [SHUTTER SETTING] (➔ page 138) is set to [DISABLE], the light source may be lit dimly due to warm-up when the shutter function is used while the operating environment temperature is around 0 °C (32 °F).

Using the on-screen display function

Turn off the on-screen display function (no display) when you do not wish the viewers to see the on-screen display, such as the menu or the input terminal name.

button

- 1) **Press the <ON SCREEN> button.**
 - Turns off (hides) the on-screen display.
- 2) **Press the <ON SCREEN> button again.**
 - Cancels the hide condition of the on-screen display.

Note

- The hide condition of the on-screen display can also be canceled by pressing the <MENU> button on the control panel for at least three seconds while the on-screen display is off (hidden).

Using the automatic setup function

The image position and the signal level can be automatically adjusted when HDMI/DisplayPort/DVI-D signal is input.

It is recommended to input an image with bright white borders at the edges and high-contrast black and white characters when executing the automatic setup. Avoid using images that include halftones or gradation, such as photographs and computer graphics.



button

1) Press the <AUTO SETUP> button.

- [COMPLETE] is displayed when it has completed without any problem.

Note

- The items to be automatically adjusted when the automatic setup function is executed can be set in the [DISPLAY OPTION] menu → [AUTO SETUP] (➔ page 114).
- It is necessary to install the optional Interface Board equipped with the corresponding input on the slot to input the HDMI/DisplayPort/DVI-D signal directly without passing through the <DIGITAL LINK> terminal.
- If an image with blurred edges or a dark image is input, [INCOMPLETE] may appear or the position adjustment may not be performed properly even when [COMPLETE] appears. In such a case, adjust the following settings.
 - The [POSITION] menu → [SHIFT] (➔ page 98)
- Automatic adjustment may not work depending on the model of the computer.
- Images may be disrupted for a few seconds during execution of the automatic setup, but it is not a malfunction.
- Adjustment is required for each input signal.
- Automatic setup can be canceled by pressing the <MENU> button while the automatic setup is being executed.
- Even if a signal possible to perform the automatic setup is being input, it may not be able to adjust correctly if the automatic setup function is executed while the moving image is being input. [INCOMPLETE] may be displayed, or the adjustment may not be completed correctly even if [COMPLETE] is displayed.

Switching the image aspect ratio

Switch the image aspect ratio according to the input.



button

1) Press the <ASPECT> button.

- The setting will change each time you press the button.

Note

- The aspect ratio of the image can also be switched using the menu operation. Refer to the [POSITION] menu → [ASPECT] (➔ page 98) for details.

Using the function button

By assigning the following functions to the <FUNCTION> button, it can be used as a simplified shortcut button. [SUB MEMORY], [SYSTEM SELECTOR], [SYSTEM DAYLIGHT VIEW], [FREEZE], [WAVEFORM MONITOR], [LENS MEMORY LOAD], [PROJECTION METHOD], [GEOMETRY], [OSD POSITION]



button

1) Press the <FUNCTION> button.

Note

- Assignment of the function is performed from the [PROJECTOR SETUP] menu → [FUNCTION BUTTON] (➔ page 172). The [FUNCTION BUTTON] screen can also be displayed by holding down the <FUNCTION> button on the remote control.

Displaying internal test pattern

The projector has nine types of internal test patterns to check the condition of the projector. To display test patterns, perform the following steps.



button

- 1) Press the <TEST PATTERN> button.
- 2) Press ◀▶ to select the test pattern.

Note

- Test patterns can also be displayed using the menu operation. Refer to “[TEST PATTERN] menu” (➔ page 181) for details.
- Settings of position, size, and other factors will not be reflected in test patterns. Make sure to display the input signal before performing various adjustments.

Using the status function

Display the status of the projector.



button

- 1) Press the <STATUS> button.
 - The [STATUS] screen is displayed.

STATUS		1/6
PROJECTOR TYPE	PT-RQ50K	
SERIAL NUMBER	123456789012	
PROJECTOR RUNTIME	100000h	
LIGHT RUNTIME	100000h / 100000h	
CONTINUOUS LIGHTING TIME	1h 23m	
MAIN/SUB VERSION	1.00 / 1.00	
NETWORK VERSION	1.00	
INTAKE AIR TEMP.	31°C/87°F	
EXHAUST AIR TEMP.	31°C/87°F	
SELF TEST	NO ERRORS	
DATA E-MAIL/USB ◀▶ CHANGE MENU EXIT		

Note

- The projector status can also be displayed using the menu operation. Refer to the [PROJECTOR SETUP] menu → [STATUS] (➔ page 173) for details.

Setting ID number of the remote control

When you use the multiple projectors together, you can operate all the projectors simultaneously or each projector individually using a single remote control, if a unique ID number is assigned to each projector.

After setting the ID number of the projector, set same ID number on the remote control.

The factory default ID number of the projector is set to [ALL]. When using a single projector, press the <ID ALL> button on the remote control. Also, you can control a projector by pressing the <ID ALL> button on the remote control even if you do not know the projector ID.



button

- 1) Press the <ID SET> button on the remote control.
- 2) Within five seconds, press and set the one-digit or two-digit ID number set on the projector body using the number (<0> - <9>) buttons.
 - If you press the <ID ALL> button, you can control the projectors regardless of the ID number setting of the projector body.

Attention

- Since the ID number of the remote control can be set without the projector body, do not press the <ID SET> button on the remote control carelessly. If the <ID SET> button is pressed and no number (<0> - <9>) buttons are pressed within five seconds, the ID number returns to its original value before the <ID SET> button was pressed.
- The ID number set on the remote control will be stored unless it is set again. However, it will be erased if the remote control is left with dead batteries. Set the same ID number again when the batteries are replaced.

Note

- When the ID number of the remote control is set to [0], you can control the projector regardless of the ID number setting of the projector body, as same as when [ALL] is set.
- Set the ID number of the projector body from the [PROJECTOR SETUP] menu → [PROJECTOR ID].

Chapter 4 Settings

This chapter describes the settings and adjustments you can make using the on-screen menu.

Menu navigation

The on-screen menu (Menu) is used to perform various settings and adjustments of the projector.

Navigating through the menu

Operating procedure



1) Press the <MENU> button on the remote control or control panel.

- The [MAIN MENU] screen is displayed.

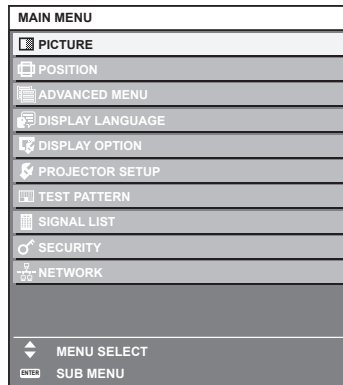

2) Press ▲▼ to select an item from the main menu.

- The selected item is highlighted in yellow.

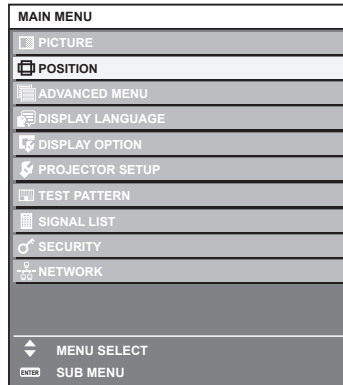

3) Press the <ENTER> button.

- The sub-menu items of the selected main menu are displayed.

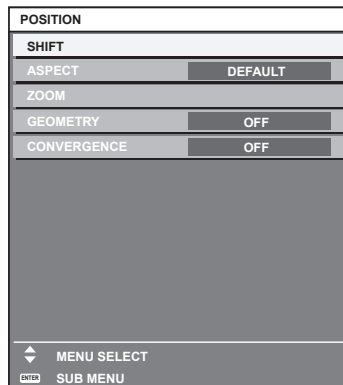

4) Press ▲▼ to select a sub-menu, and press ◀▶ or the <ENTER> button to change or adjust settings.

- Some items will switch in order as follows each time you press ◀▶.

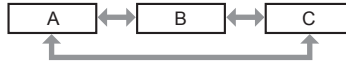

- For some items, press ◀▶ to display an individual adjustment screen with a bar scale as shown below.



Note

- Pressing the <MENU> button while the menu screen is displayed returns to the previous menu.
- Some items or functions may not be adjusted or used depending on the signals input to the projector. When the items cannot be adjusted or used, the items in the menu screen are shown in black characters, and they cannot be adjusted or set. If the item in the menu screen is displayed in black characters and the item cannot be adjusted or set, the factor causing it is displayed by pressing the <ENTER> button while the corresponding menu is selected.
- Some items can be adjusted even if signals are not input.
- Individual adjustment screen is cleared automatically if no operation is performed for approximately five seconds.
- For menu items, refer to “Main menu” (➔ page 85) and “Sub-menu” (➔ page 86).
- The cursor color depends on the setting in the [DISPLAY OPTION] menu → [ON-SCREEN DISPLAY] → [OSD DESIGN]. The selected item is displayed with the yellow cursor by the factory default.
- In the portrait setting, the on-screen menu is displayed sideways. To display the on-screen menu vertically, change the setting of the [DISPLAY OPTION] menu → [ON-SCREEN DISPLAY] → [OSD ROTATION].

Resetting adjustment values to the factory default

If the <DEFAULT> button on the remote control is pressed, the values adjusted in the menu items are restored to the factory default settings.



1) Press the <DEFAULT> button on the remote control.



Note

- You cannot reset all the settings to the factory default at a time.
- To reset all the settings adjusted in the sub-menu item to the factory default one at a time, execute the [PROJECTOR SETUP] menu → [INITIALIZE].
- Some items cannot be reset to the factory default settings even when the <DEFAULT> button on the remote control is pressed. Adjust those items individually.
- The triangular mark under the bar scale in the individual adjustment screen indicates the factory default setting. The position of the triangular mark varies according to the selected input signals.

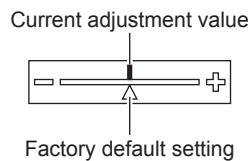







Main menu

The following items are in the main menu.

When a main menu item is selected, the screen changes to a sub-menu selection screen.

The menu item with ✓ in the [SIMPLE] mode column indicates that this is displayed in the menu screen (OSD) when the [DISPLAY OPTION] menu → [MENU MODE] is set to [SIMPLE].

Main menu item		[SIMPLE] mode	Page
	[PICTURE]	✓	89
	[POSITION]	✓	98
	[ADVANCED MENU]	—	106

Main menu item		[SIMPLE] mode	Page
	[DISPLAY LANGUAGE]	✓	111
	[DISPLAY OPTION]	✓	112
	[PROJECTOR SETUP]	✓	143
	[TEST PATTERN]	✓	181
	[SIGNAL LIST]	✓	182
	[SECURITY]	—	185
	[NETWORK]	✓	191

Sub-menu

The sub-menu of the selected main menu item is displayed, and you can set and adjust items in the sub-menu. The menu item with ✓ in the [SIMPLE] mode column indicates that this is displayed in the menu screen (OSD) when the [DISPLAY OPTION] menu → [MENU MODE] is set to [SIMPLE].

[PICTURE]

Sub-menu item	Factory default	[SIMPLE] mode	Page
[PICTURE MODE]	[DYNAMIC]	✓	89
[CONTRAST]	[0] ^{*1}	✓	89
[BRIGHTNESS]	[0] ^{*1}	✓	90
[COLOR]	[0] ^{*1}	✓	90
[TINT]	[0] ^{*1}	—	90
[COLOR TEMPERATURE]	[DEFAULT] ^{*1}	—	90
[GAMMA]	[DEFAULT] ^{*1}	—	92
[SYSTEM DAYLIGHT VIEW]	[OFF] ^{*1}	—	94
[SHARPNESS]	[+8] ^{*1}	—	94
[NOISE REDUCTION]	[2] ^{*1}	—	94
[DYNAMIC CONTRAST]	[2] ^{*1}	—	94
[COLOR SPACE]	[NATIVE]	—	96
[SYSTEM SELECTOR]	[AUTO] ^{*2}	—	96

*1 Depends on the [PICTURE MODE].

*2 Depends on the signal input.

[POSITION]

Sub-menu item	Factory default	[SIMPLE] mode	Page
[SHIFT]	—	—	98
[ASPECT]	[DEFAULT]	✓	98
[ZOOM]	—	—	99
[GEOMETRY]	[OFF]	✓	100
[CONVERGENCE]	[OFF]	—	105

[ADVANCED MENU]

Sub-menu item	Factory default	[SIMPLE] mode	Page
[DIGITAL CINEMA REALITY]	[AUTO] ^{*1}	—	106
[BLANKING]	—	—	106
[EDGE BLENDING]	[OFF]	—	107

Sub-menu item	Factory default	[SIMPLE] mode	Page
[FRAME RESPONSE]	[NORMAL]	—	109
[FRAME DELAY]	[+0.00ms]	—	109
[RASTER POSITION]	—	—	110

*1 Depends on the signal input.

[DISPLAY LANGUAGE]

Details (➔ page 111)

[DISPLAY OPTION]

Sub-menu item	Factory default	[SIMPLE] mode	Page
[COLOR MATCHING]	[OFF]	✓	112
[SCREEN SETTING]	—	✓	114
[AUTO SIGNAL]	[OFF]	—	114
[AUTO SETUP]	—	—	114
[BACKUP INPUT SETTING]	—	—	115
[SIMUL INPUT SETTING]	—	—	117
[SLOT IN]	—	—	117
[DIGITAL LINK IN]	—	—	131
[ON-SCREEN DISPLAY]	—	✓	133
[MENU MODE]	[NORMAL]	✓	135
[BACK COLOR]	[BLUE]	—	136
[STARTUP LOGO]	[DEFAULT LOGO]	✓	136
[UNIFORMITY]	—	—	137
[SHUTTER SETTING]	—	—	138
[FREEZE]	—	—	140
[WAVEFORM MONITOR]	[OFF]	—	140
[CUT OFF]	—	—	141

[PROJECTOR SETUP]

Sub-menu item	Factory default	[SIMPLE] mode	Page
[PROJECTOR ID]	[ALL]	✓	143
[PROJECTION METHOD]	—	✓	143
[LENS]	—	✓	144
[OPERATION SETTING]	—	✓	154
[LIGHT OUTPUT]	[100.0%]	✓	157
[BRIGHTNESS CONTROL]	—	—	158
[NO SIGNAL SETTING]	—	—	161
[INITIAL STARTUP]	[LAST MEMORY]	—	165
[STARTUP INPUT SELECT]	[LAST USED]	—	165
[DATE AND TIME]	—	✓	166
[SCHEDULE]	[OFF]	—	167
[MULTI PROJECTOR SYNC]	—	—	168
[RS-232C]	—	✓	170
[REMOTE2 MODE]	[DEFAULT]	—	172
[FUNCTION BUTTON]	—	—	172
[STATUS]	—	✓	173
[INFO MONITOR SETTING]	—	—	176
[DATA CLONING]	—	—	178
[SAVE ALL USER DATA]	—	—	178
[LOAD ALL USER DATA]	—	—	178
[INITIALIZE]	—	✓	178

Sub-menu item	Factory default	[SIMPLE] mode	Page
[FIRMWARE UPDATE]	—	—	180
[SERVICE PASSWORD]	—	✓	180

[TEST PATTERN] 

Details (➔ page 181)

[SIGNAL LIST] 

Details (➔ page 182)

[SECURITY] 

Sub-menu item	Factory default	[SIMPLE] mode	Page
[SECURITY PASSWORD]	[OFF]	—	185
[SECURITY PASSWORD CHANGE]	—	—	185
[CONTROL DEVICE SETUP]	—	—	185
[CONTROL DEVICE PASSWORD CHANGE]	—	—	189

[NETWORK] 

Sub-menu item	Factory default	[SIMPLE] mode	Page
[DIGITAL LINK MODE]	[AUTO]	—	191
[DIGITAL LINK STATUS]	—	✓	191
[WIRED LAN]	—	✓	192
[WIRELESS LAN]*1	[ENABLE]	✓	192
[PROJECTOR NAME]	—	✓	193
[NETWORK CONTROL]	—	✓	193
[NETWORK STATUS]	—	✓	194
[DIGITAL LINK MENU]	—	—	194
[Art-Net SETUP]	[OFF]	—	195
[Art-Net CHANNEL SETTING]	[2]	—	195
[Art-Net STATUS]	—	—	196

*1 [WIRELESS LAN] cannot be set if the optional Wireless Module (Model No.: AJ-WM50 Series) is not attached to the <USB> terminal.

Note

- Some items may not be adjusted or used for certain signal formats to be input to the projector.
When the items cannot be adjusted or used, the items in the menu screen are shown in black characters, and they cannot be adjusted or set.
- Sub-menu items and factory default settings vary depending on the selected input terminal.

[PICTURE] menu

On the menu screen, select [PICTURE] from the main menu, and select an item from the sub-menu. Refer to “Navigating through the menu” (➔ page 84) for the operation of the menu screen.

[PICTURE MODE]

You can switch to the desired picture mode suitable for the image source and the environment in which the projector is used.

- 1) Press ▲▼ to select [PICTURE MODE].
- 2) Press ◀▶.
 - The [PICTURE MODE] individual adjustment screen is displayed.
- 3) Press ◀▶ to switch the item.
 - The items will switch each time you press the button.

[STANDARD]	The image becomes suitable for moving images in general.
[CINEMA]	The image becomes suitable for movie contents.
[NATURAL]	The image is sRGB compliant.
[DICOM SIM.]	The image becomes similar to that of DICOM Part 14 Grayscale Standard.
[DYNAMIC]	The light output is maximized for use in bright areas. (Factory default setting)
[GRAPHIC]	The image becomes suitable for input from the personal computer.
[USER]	Set any desired picture mode.

Note

- DICOM is an abbreviation of “Digital Imaging and COmmunication in Medicine” and is a standard for medical imaging devices. Although the DICOM name is used, the projector is not a medical device, and should not be used for purposes such as diagnosis of display images.
- Press the <ENTER> button when each [PICTURE MODE] is selected to save as a specified value when a new signal is input. The data of all items except [SYSTEM SELECTOR] in the [PICTURE] menu is saved.
- In the factory default settings, [USER] is set to images that comply with the ITU-R BT.709 standard.

Changing the [USER] name

- 1) Press ▲▼ to select [PICTURE MODE].
- 2) Press ◀▶ to select [USER].
- 3) Press the <ENTER> button.
 - The [PICTURE MODE] detailed screen is displayed.
- 4) Press ▲▼ to select [PICTURE MODE NAME CHANGE], and press the <ENTER> button.
 - The [PICTURE MODE NAME CHANGE] screen is displayed.
- 5) Press ▲▼◀▶ to select the text, and press the <ENTER> button to enter the text.
- 6) Press ▲▼◀▶ to select [OK], and press the <ENTER> button.
 - The picture mode name is changed.

[CONTRAST]

You can adjust the contrast of the colors.

- 1) Press ▲▼ to select [CONTRAST].
- 2) Press ◀▶ or the <ENTER> button.
 - The [CONTRAST] individual adjustment screen is displayed.
- 3) Press ◀▶ to adjust the level.

Operation	Adjustment	Range of adjustment
Press ▶.	The screen becomes brighter.	-31 - +31
Press ◀.	The screen becomes darker.	

Attention

- Adjust [BRIGHTNESS] first when you need to adjust the black level.

[BRIGHTNESS]

You can adjust the dark (black) part of the projected image.

- 1) Press ▲▼ to select [BRIGHTNESS].
- 2) Press ◀▶ or the <ENTER> button.
 - The [BRIGHTNESS] individual adjustment screen is displayed.
- 3) Press ◀▶ to adjust the level.

Operation	Adjustment	Range of adjustment
Press ▶.	Increases the brightness of the dark (black) parts of the screen.	-31 - +31
Press ◀.	Reduces the brightness of the dark (black) parts of the screen.	

[COLOR]

You can adjust the color saturation of the projected image.

- 1) Press ▲▼ to select [COLOR].
- 2) Press ◀▶ or the <ENTER> button.
 - The [COLOR] individual adjustment screen is displayed.
- 3) Press ◀▶ to adjust the level.

Operation	Adjustment	Range of adjustment
Press ▶.	Deepens colors.	-31 - +31
Press ◀.	Weakens colors.	

[TINT]

You can adjust the skin tone in the projected image.

- 1) Press ▲▼ to select [TINT].
- 2) Press ◀▶ or the <ENTER> button.
 - The [TINT] individual adjustment screen is displayed.
- 3) Press ◀▶ to adjust the level.

Operation	Adjustment	Range of adjustment
Press ▶.	Adjusts skin tone toward greenish color.	-31 - +31
Press ◀.	Adjusts skin tone toward reddish purple.	

[COLOR TEMPERATURE]

You can switch the color temperature if the white areas of the projected image are bluish or reddish.

Adjusting with color temperature

- 1) Press ▲▼ to select [COLOR TEMPERATURE].
- 2) Press ◀▶.
 - The [COLOR TEMPERATURE] individual adjustment screen is displayed.
- 3) Press ◀▶ to switch the item.
 - The items will switch each time you press the button.

[DEFAULT]	Factory default setting.
-----------	--------------------------

[USER1]	Adjusts white balance as desired. Refer to “Adjusting desired white balance” (➔ page 91) for details.
[USER2]	
[3200K] - [13000K]	Allows you to set in increments of 100 K. Select so that images become natural.

Note

- When [PICTURE MODE] (➔ page 89) is set to [USER] or [DICOM SIM.], [DEFAULT] cannot be selected.
- When the [DISPLAY OPTION] menu → [COLOR MATCHING] is set to anything other than [OFF], [COLOR TEMPERATURE] is fixed to [USER1].
- The color temperature numerical values are guidelines.

Adjusting desired white balance

- 1) Press ▲▼ to select [COLOR TEMPERATURE].
- 2) Press ◀▶.
 - The [COLOR TEMPERATURE] individual adjustment screen is displayed.
- 3) Press ◀▶ to select [USER1] or [USER2].
- 4) Press the <ENTER> button.
 - The [COLOR TEMPERATURE] screen is displayed.
- 5) Press ▲▼ to select [WHITE BALANCE].
- 6) Press the <ENTER> button.
 - The [WHITE BALANCE] screen is displayed.
- 7) Press ▲▼ to select [WHITE BALANCE HIGH] or [WHITE BALANCE LOW].
- 8) Press the <ENTER> button.
 - The [WHITE BALANCE HIGH] screen or the [WHITE BALANCE LOW] screen is displayed.
- 9) Press ▲▼ to select [RED], [GREEN], or [BLUE].
- 10) Press ◀▶ to adjust the level.

Item	Operation	Adjustment	Range of adjustment
[RED]	Press ▶.	Deepens red.	[WHITE BALANCE HIGH]: 0 - +255 (factory default is +255) [WHITE BALANCE LOW]: -127 - +127 (factory default is 0)
	Press ◀.	Weakens red.	
[GREEN]	Press ▶.	Deepens green.	
	Press ◀.	Weakens green.	
[BLUE]	Press ▶.	Deepens blue.	
	Press ◀.	Weakens blue.	

Note

- Adjust [COLOR TEMPERATURE] correctly. All colors will not be displayed properly unless adequate adjustment is made. If the adjustment does not look suitable, you can press the <DEFAULT> button on the remote control to return the setting for the selected item only to the factory default setting.

Adjusting desired white balance based on existing color temperature settings

- 1) Press ▲▼ to select [COLOR TEMPERATURE].
- 2) Press ◀▶.
 - The [COLOR TEMPERATURE] individual adjustment screen is displayed.
- 3) Press ◀▶ to select anything other than [USER1] and [USER2].
- 4) Press the <ENTER> button.
 - The [CHANGE TO *****] screen is displayed.
- 5) Press ▲▼ to select [USER1] or [USER2].
 - The status of the color temperature changed is saved to the selected item.

- 6) Press the <ENTER> button.
 - The confirmation screen is displayed.
- 7) Press ◀▶ to select [OK], and press the <ENTER> button.
 - The [USER1] or [USER2] data is overwritten.
 - If you press ◀▶ to select [CANCEL] and then press the <ENTER> button, the data will not be overwritten.
 - The [WHITE BALANCE HIGH] screen is displayed.
- 8) Press ▲▼ to select [RED], [GREEN], or [BLUE].
- 9) Press ◀▶ to adjust the level.

Note

- Adjust [COLOR TEMPERATURE] correctly. All colors will not be displayed properly unless adequate adjustment is made. If the adjustment does not look suitable, you can press the <DEFAULT> button on the remote control to return the setting for the selected item only to the factory default setting.
- When color temperature has been changed, the colors before and after the change will differ slightly.

Changing the name of [USER1] or [USER2]

- 1) Press ▲▼ to select [COLOR TEMPERATURE].
- 2) Press ◀▶.
 - The [COLOR TEMPERATURE] individual adjustment screen is displayed.
- 3) Press ◀▶ to select [USER1] or [USER2].
- 4) Press the <ENTER> button.
 - The [COLOR TEMPERATURE] screen is displayed.
- 5) Press ▲▼ to select [COLOR TEMPERATURE NAME CHANGE].
- 6) Press the <ENTER> button.
 - The [COLOR TEMPERATURE NAME CHANGE] screen is displayed.
- 7) Press ▲▼◀▶ to select the text, and press the <ENTER> button to enter the text.
- 8) Press ▲▼◀▶ to select [OK], and press the <ENTER> button.
 - The name set to color temperature is changed.

Note

- When a name is changed, display of [USER1], [USER2] is also changed.

[GAMMA]

You can switch gamma mode.

- 1) Press ▲▼ to select [GAMMA].
- 2) Press ◀▶ or the <ENTER> button.
 - The [GAMMA] individual adjustment screen is displayed.
- 3) Press ◀▶ to switch the item.
 - The items will switch each time you press the button.

[DEFAULT] ^{*1}	Gamma mode unique to this projector.
[USER1]	Uses the gamma data registered by the user.
[USER2]	(Registration requires separate software. Consult your dealer.)
[HDR ST2084-500]	Gamma mode compliant with SMPTE ST 2084 that assumes a highest luminance of 500 cd/m ² and supports HDR (High Dynamic Range).
[HDR ST2084-1000]	Gamma mode compliant with SMPTE ST 2084 that assumes a highest luminance of 1 000 cd/m ² and supports HDR (High Dynamic Range).
[HDR HLG]	Gamma mode compliant with ITU-R BT.2100 (HLG: Hybrid Log Gamma system) that supports HDR (High Dynamic Range).
[DICOM SIM.]	The picture becomes similar to that of DICOM standard.

[1.0]	Set so that images become as you like. [2.0] - [2.8] can be set in increments of 0.1.
[1.8]	
[2.0] - [2.8]	

*1 When [PICTURE MODE] is set to [DYNAMIC], [USER], or [DICOM SIM.], [DEFAULT] cannot be selected.

Note

- DICOM is an abbreviation of “Digital Imaging and COmmunication in Medicine” and is a standard for medical imaging devices. Although the DICOM name is used, the projector is not a medical device, and should not be used for purposes such as diagnosis of display images.
- In the following cases, the gamma mode is automatically set based on the InfoFrame information while displaying the image with the InfoFrame information added, so the gamma mode cannot be selected. If the information necessary for supporting HDR (High Dynamic Range) is not included in the InfoFrame information added to the displayed video signal, it will follow the [GAMMA] setting.
 - When the [DISPLAY OPTION] menu → [DIGITAL LINK IN] → [AUTO GAMMA SELECT] is set to [ENABLE], and the DIGITAL LINK input is selected
 - When [AUTO GAMMA SELECT] under the [DISPLAY OPTION] menu → [SLOT IN] (HDMI input) is set to [ENABLE], and the HDMI input corresponding to that setting is selected
 - When the [DISPLAY OPTION] menu → [SLOT IN] (DisplayPort input) → [AUTO GAMMA SELECT] is set to [ENABLE], and the DisplayPort input applicable to that setting is selected

Setting [HDR HLG SYSTEM GAMMA]

Set the system gamma to be applied to the [USER1], [USER2], and [HDR HLG] gamma modes. This system gamma is defined by the ITU-R BT.2100 standard.

- 1) Press ▲▼ to select [GAMMA].
- 2) Press ◀▶ or the <ENTER> button.
 - The [GAMMA] individual adjustment screen is displayed.
- 3) Press ◀▶ to select [USER1], [USER2], or [HDR HLG], and press the <ENTER> button.
 - The [GAMMA] screen is displayed.
 - When [HDR HLG] is selected, proceed to Step 5).
- 4) Press ▲▼ to select [HDR HLG SYSTEM GAMMA].
- 5) Press ◀▶ to switch the item.
 - The items will switch each time you press the button.
 - [1.00] - [1.62] can be set in increments of 0.01.

Changing the name of [USER1] or [USER2]

- 1) Press ▲▼ to select [GAMMA].
- 2) Press ◀▶ or the <ENTER> button.
 - The [GAMMA] individual adjustment screen is displayed.
- 3) Press ◀▶ to select [USER1] or [USER2].
- 4) Press the <ENTER> button.
 - The [GAMMA] screen is displayed.
- 5) Press ▲▼ to select [GAMMA NAME CHANGE].
- 6) Press the <ENTER> button.
 - The [GAMMA NAME CHANGE] screen is displayed.
- 7) Press ▲▼◀▶ to select the text, and press the <ENTER> button to enter the text.
- 8) Press ▲▼◀▶ to select [OK], and press the <ENTER> button.
 - The selected gamma name is changed.

Note

- When a name is changed, display of [USER1], [USER2] is also changed.

[SYSTEM DAYLIGHT VIEW]

You can correct the image to the optimal vividness even if it is projected under a bright light.

- 1) Press ▲▼ to select [SYSTEM DAYLIGHT VIEW].
- 2) Press ◀▶ or the <ENTER> button.
 - The [SYSTEM DAYLIGHT VIEW] individual adjustment screen is displayed.
- 3) Press ◀▶ to switch the item.
 - The items will switch each time you press the button.

[OFF]	No correction.
[1] - [6]	Corrects the vividness of the image. The larger the value, the stronger the correction.

[SHARPNESS]

You can adjust the sharpness of the projected image.

- 1) Press ▲▼ to select [SHARPNESS].
- 2) Press ◀▶ or the <ENTER> button.
 - The [SHARPNESS] individual adjustment screen is displayed.
- 3) Press ◀▶ to adjust the level.

Operation	Adjustment	Range of adjustment
Press ▶.	Contours become sharper.	0 - +15
Press ◀.	Contours become softer.	

Note

- If you press ▶ while the adjustment value is [+15], the value will become [0]. If you press ◀ while the adjustment value is [0], the value will become [+15].

[NOISE REDUCTION]

You can reduce noises when the input image is degraded and noise is occurring in the image signal.

- 1) Press ▲▼ to select [NOISE REDUCTION].
- 2) Press ◀▶ or the <ENTER> button.
 - The [NOISE REDUCTION] individual adjustment screen is displayed.
- 3) Press ◀▶ to switch the item.
 - The items will switch each time you press the button.

[OFF]	No correction.
[1] - [6]	Compensates the noise. The larger the value, the stronger the compensation of the noise.

Attention

- When this is set for an input signal with less noise, the image may look different from what it originally was. In such a case, set it to [OFF].

[DYNAMIC CONTRAST]

Light adjustment of the light source and signal compensation are performed automatically according to the image to make the contrast optimum for the image.

- 1) Press ▲▼ to select [DYNAMIC CONTRAST].
- 2) Press ◀▶ or the <ENTER> button.
 - The [DYNAMIC CONTRAST] individual adjustment screen is displayed.
- 3) Press ◀▶ to switch the item.
 - The items will switch each time you press the button.

[OFF]	Disables the dynamic contrast function.
[1]	Adjusts the light source and compensates signals to a small extent.
[2]	Adjusts the light source and compensates signals to a moderate extent.
[3]	Adjusts the light source and compensates signals to a large extent.
[USER]	Set any desired correction. Refer to "Performing desired correction" (► page 95) for details.

Performing desired correction

- 1) Press ▲▼ to select [DYNAMIC CONTRAST].
- 2) Press ◀▶ or the <ENTER> button.
 - The [DYNAMIC CONTRAST] individual adjustment screen is displayed.
- 3) Press ◀▶ to select [USER].
- 4) Press the <ENTER> button.
 - The [DYNAMIC CONTRAST] screen is displayed.
- 5) Press ▲▼ to select the item to set.
 - The items of the detailed settings will switch each time you press ◀▶.
 - Press the <ENTER> button when [MULTI PROJECTOR SYNC] is selected.

Setting item		Details
[AUTO CONTRAST] (Automatic light source adjustment)	[OFF]	Does not adjust the light source.
	[1] - [255]	The higher the value, the stronger the light adjustment of the light source. Can be set in increments of 1.
[BRIGHT SIGNAL LEVEL] (Setting of the brightness level of the signal to start the light adjustment)	[6%] - [50%]	Adjusts the light source when the brightness level of the video signal being input gets lower than the set value. The higher the value, the larger the range to perform the light adjustment of the light source. Can be set in increments of 1 %. (Factory setting: 30 %)
[LIGHTS OUT TIMER] (Time setting until the light turns off)	[DISABLE]	Does not turn off the light source.
	[0.0s] - [10.0s]	Turns off the light source when the brightness level of the video signal being input goes under the value set in [LIGHTS OUT SIGNAL LEVEL]. Select an item from [0.0s] - [4.0s], [5.0s], [7.0s], or [10.0s]. [0.0s] - [4.0s] can be selected in increments of 0.5.
[LIGHTS OUT SIGNAL LEVEL] (Setting of the brightness level of the signal to turn off the light)	[0%] - [5%]	Set the level of the brightness of the video signal to turn off the light source with [LIGHTS OUT TIMER]. Can be set in increments of 1 %. (Factory setting: 0 %)
[LIGHTS OUT FADE-IN] (Setting of fade-in when lighting up again)	[OFF]	Does not set the fade-in of the image when the light source is turned on again from the condition that the light source was turned off with [LIGHTS OUT TIMER].
	[0.5s] - [10.0s]	Sets the time to fade in the image when the light source is turned on again from the condition that the light source was turned off with [LIGHTS OUT TIMER]. Select an item from [0.5s] - [4.0s], [5.0s], [7.0s], or [10.0s]. [0.5s] - [4.0s] can be selected in increments of 0.5.
[LIGHTS OUT FADE-OUT] (Setting of fade-out when lighting off)	[OFF]	Does not set the fade-out of the image when the light source is turned off with [LIGHTS OUT TIMER].
	[0.5s] - [10.0s]	Sets the time to fade out the image when the light source is turned off with [LIGHTS OUT TIMER]. Select an item from [0.5s] - [4.0s], [5.0s], [7.0s], or [10.0s]. [0.5s] - [4.0s] can be selected in increments of 0.5.
[MANUAL INTENSITY] (Manual light source adjustment)	[0] - [255]	The larger the value, the stronger the correction. Can be set in increments of 1. (Factory setting: 255)
[DYNAMIC GAMMA] (Adjustment of signal compensation)	[OFF]	Does not compensate the signal.
	[1]	Slightly compensates the signal.
	[2]	Moderately compensates the signal.
	[3]	Strongly compensates the signal.

Setting item	Details
[MULTI PROJECTOR SYNC]	<p>Sets the contrast synchronization function. This setting item is common with the following menu item.</p> <ul style="list-style-type: none"> The [PROJECTOR SETUP] menu → [MULTI PROJECTOR SYNC] <p>Refer to the [PROJECTOR SETUP] menu → [MULTI PROJECTOR SYNC] (➔ page 168) for details.</p>

Note

- [LIGHTS OUT SIGNAL LEVEL], [LIGHTS OUT FADE-IN], and [LIGHTS OUT FADE-OUT] cannot be set when [LIGHTS OUT TIMER] is set to [DISABLE].
- When [LIGHTS OUT TIMER] is set to anything other than [DISABLE], the following are the conditions to turn the light source back on again from the state that the light source has turned off by this function.
 - When the brightness level of the video signal being input has exceeded the value set in [LIGHTS OUT SIGNAL LEVEL]
 - When the input signal is gone
 - When on-screen display such as menu screen (OSD) or input guide, a test pattern, or a warning message is displayed
 - When the operating environment temperature is around 0 °C (32 °F) and the light source is forced to turn on due to warm-up
- The contrast will be maximized when [DYNAMIC GAMMA] is set to [3].
- The contrast synchronization function is a function to display a combined screen with a balanced contrast by sharing the brightness level of the video signal input to each projector when a multi-display is constructed by combining the projected image of multiple projectors.

[COLOR SPACE]

Set the color space used for the color representation of the image.

- Press ▲▼ to select [COLOR SPACE].
- Press ◀▶ or the <ENTER> button.
 - The [COLOR SPACE] individual adjustment screen is displayed.
- Press ◀▶ to switch the item.
 - The items will switch each time you press the button.

[NATIVE]	Displays the image with a color space unique to this projector.
[ITU-709]	Displays the image with a color space compliant with the ITU-R BT.709 standard.
[DCI-P3 emu.]	Displays the image with a color space close to DCI-P3.
[ITU-2020 emu.]	Displays the image with a color space close to the ITU-R BT.2020 standard.

Note

- DCI-P3 is the specifications of the digital cinema color region defined by the Digital Cinema Initiatives (DCI).
- In the following cases, the color space is automatically set based on the InfoFrame information while displaying the image with the InfoFrame information added, so the [COLOR SPACE] cannot be set. If the information necessary for supporting HDR (High Dynamic Range) is not included in the InfoFrame information added to the displayed video signal, it will follow the [COLOR SPACE] setting.
 - When the [DISPLAY OPTION] menu → [DIGITAL LINK IN] → [AUTO COLOR SPACE SELECT] is set to [ENABLE], and the DIGITAL LINK input is selected
 - When [AUTO COLOR SPACE SELECT] under the [DISPLAY OPTION] menu → [SLOT IN] (HDMI input) is set to [ENABLE], and the HDMI input corresponding to that setting is selected
 - When the [DISPLAY OPTION] menu → [SLOT IN] (DisplayPort input) → [AUTO COLOR SPACE SELECT] is set to [ENABLE], and the DisplayPort input applicable to that setting is selected

[SYSTEM SELECTOR]

The projector will automatically detect the input signal, but you can set the system method manually when an unstable signal is input. Set the system method matching the input signal.

- Press ▲▼ to select [SYSTEM SELECTOR].
- Press the <ENTER> button.
- Press ▲▼ to select a system format.
 - Available system formats vary depending on the input signal.

Terminal	System format	
<DIGITAL LINK> terminal, <HDMI IN 1> terminal, <HDMI IN 2> terminal, <HDMI IN 3> terminal, <HDMI IN 4> terminal	480/60p or 576/50p signal	Select [AUTO], [RGB], or [YCbCr].
	Other moving image signals	Select [AUTO], [RGB], or [YPbPr].

Terminal	System format	
<DVI-D IN 1> terminal, <DVI-D IN 2> terminal, <DVI-D IN 3> terminal, <DVI-D IN 4> terminal	480/60p or 576/50p signal	Select [RGB] or [YCbCr].
	Other moving image signals	Select [RGB] or [YPbPr].
<DisplayPort IN 1> terminal, <DisplayPort IN 2> terminal, <DisplayPort IN 3> terminal, <DisplayPort IN 4> terminal	Moving image signals	Select [AUTO], [RGB], or [YPbPr].

4) Press the <ENTER> button.

Note

- For details of the types of video signals that can be used with the projector, refer to “List of compatible signals” (➔ page 274).
- This may not function properly for some connected external devices.
- The selection item for the input signal to the <HDMI IN 1> terminal and the <HDMI IN 2> terminal can be selected when the optional Interface Board equipped with the HDMI input is installed in <SLOT 1>.
- The selection item for the input signal to the <HDMI IN 3> terminal and the <HDMI IN 4> terminal can be selected when the optional Interface Board equipped with the HDMI input is installed in <SLOT 2>.
- The selection item for the input signal to the <DVI-D IN 1> terminal and the <DVI-D IN 2> terminal can be selected when the optional Interface Board equipped with the DVI-D input is installed in <SLOT 1>.
- The selection item for the input signal to the <DVI-D IN 3> terminal and the <DVI-D IN 4> terminal can be selected when the optional Interface Board equipped with the DVI-D input is installed in <SLOT 2>.
- The selection item for the input signal to the <DisplayPort IN 1> terminal and the <DisplayPort IN 2> terminal can be selected when the optional Interface Board equipped with the DisplayPort input is installed in <SLOT 1>.
- The selection item for the input signal to the <DisplayPort IN 3> terminal and the <DisplayPort IN 4> terminal can be selected when the optional Interface Board equipped with the DisplayPort input is installed in <SLOT 2>.
- For the SDI input, the signal format can be set in detail in the [DISPLAY OPTION] menu → [SLOT IN].

sRGB-compliant video

sRGB is an international standard (IEC61966-2-1) for color reproduction defined by IEC (International Electrotechnical Commission).

Set according to the following steps to reproduce more faithful, sRGB compliant colors.

- 1) Set [COLOR MATCHING] to [OFF].
 - Refer to [COLOR MATCHING] (➔ page 112).
- 2) Display the [PICTURE] menu.
 - Refer to “[PICTURE] menu” (➔ page 89).
- 3) Press ▲▼ to select [PICTURE MODE].
- 4) Press ◀▶ to set [NATURAL].
- 5) Press ▲▼ to select [COLOR].
- 6) Press the <DEFAULT> button on the remote control to set the factory default setting.
- 7) Follow Steps 5) to 6) to set [TINT], [COLOR TEMPERATURE], [GAMMA], and [SYSTEM DAYLIGHT VIEW] to the factory default settings.

Note

- sRGB is available for RGB signal input only.

[POSITION] menu

On the menu screen, select [POSITION] from the main menu, and select an item from the sub-menu. Refer to “Navigating through the menu” (➔ page 84) for the operation of the menu screen.

Note

- When the optional DIGITAL LINK output supported device (Model No.: ET-YFB100G, ET-YFB200G) is connected to the <DIGITAL LINK> terminal, adjust the shift and aspect from the menu of DIGITAL LINK output supported device first.

[SHIFT]

Move the image position vertically or horizontally if the image projected on the screen is still out of position even when the positions of the projector and screen are correct.

- Press ▲▼ to select [SHIFT].
- Press the <ENTER> button.
 - The [SHIFT] screen is displayed.
- Press ▲▼◀▶ to adjust the position.

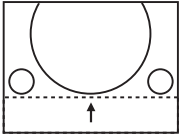
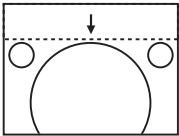
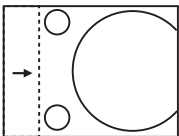
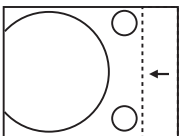
Orientation	Operation	Adjustment	
Vertical (up and down) adjustment	Press ▲.	The image position moves up.	
	Press ▼.	The image position moves down.	
Horizontal (right and left) adjustment	Press ▶.	The image position moves to the right.	
	Press ◀.	The image position moves to the left.	

Note

- For the portrait setting, image position is moved horizontally when “Vertical (up and down) adjustment” is made. Image position is moved vertically when “Horizontal (right and left) adjustment” is made.

[ASPECT]

You can switch the aspect ratio of the image.

The aspect ratio is switched within the screen range selected in the [DISPLAY OPTION] menu → [SCREEN SETTING] → [SCREEN FORMAT]. Set [SCREEN FORMAT] first. (➔ page 114)

- Press ▲▼ to select [ASPECT].
- Press ◀▶ or the <ENTER> button.
 - The [ASPECT] individual adjustment screen is displayed.
- Press ◀▶ to switch the item.
 - The items will switch each time you press the button.

[DEFAULT]	Displays images without changing the aspect ratio of the input signals.
[THROUGH]	Displays images without changing the resolution of the input signals.

[16:9]	Displays images with the aspect ratio converted to 16:9 when standard signals are input*1. When wide-screen signals are input*2, the images are displayed without changing the aspect ratio.
[4:3]	Displays images without changing the aspect ratio when standard signals are input*1. When wide-screen signals are input*2, and [4:3] is selected in [SCREEN FORMAT], the image is displayed by converting the aspect ratio to 4:3. When anything other than [4:3] is selected in [SCREEN FORMAT], the images are reduced to be displayed without changing input aspect ratio so that the images will fit in the 4:3 screen.
[H FIT]	Displays images using the entire width of the screen range selected in [SCREEN FORMAT]. When signals have the aspect ratio vertically longer than the screen aspect ratio selected in [SCREEN FORMAT], the images are displayed with the top and bottom parts cut off.
[V FIT]	Displays images using the entire height of the screen range selected in [SCREEN FORMAT]. When signals have the aspect ratio horizontally longer than the aspect ratio of the screen selected in [SCREEN FORMAT], the images are displayed with the right and left parts cut off.
[HV FIT]	Displays images in the entire screen range selected in [SCREEN FORMAT]. When the aspect ratio of the input signals differs from that of the screen range, the images are displayed with the aspect ratio converted to that of the screen selected in [SCREEN FORMAT].

*1 Standard signals are input signals with an aspect ratio of 4:3 or 5:4.

*2 Wide-screen signals are input signals with an aspect ratio of 17:9, 16:10, 16:9, 15:10, or 15:9.

Note

- If an aspect ratio which is different from the aspect ratio for the input signals is selected, the images will appear differently from the originals. Be careful of this when selecting the aspect ratio.
- If using the projector in places such as cafes or hotels to display programs for a commercial purpose or for public presentation, note that adjusting the aspect ratio or using the zoom function to change the screen images may be an infringement of the rights of the original copyright owner for that program under copyright protection laws. Take care when using a function of the projector such as the aspect ratio adjustment and zoom function.
- If conventional (normal) 4:3 images which are not wide-screen images are displayed on a wide screen, the edges of the images may not be visible or they may become distorted. Such images should be viewed as with an aspect ratio of 4:3 in the original format intended by the creator of the images.

[ZOOM]

You can adjust the image size.

The adjustments in [ZOOM] will differ depending on the setting of the [POSITION] menu → [ASPECT].

When [ASPECT] is set to other than [DEFAULT] and [THROUGH]

- 1) Press ▲▼ to select [ZOOM].
- 2) Press the <ENTER> button.
 - The [ZOOM] screen is displayed.
- 3) Press ▲▼ to select [INTERLOCKED].
- 4) Press ◀▶ to switch the item.

[OFF]	Sets the [VERTICAL] and [HORIZONTAL] zoom ratio.
[ON]	Uses [BOTH] to set zoom ratio. Image can be enlarged or reduced vertically and horizontally at the same magnification.

- 5) Press ▲▼ to select [VERTICAL] or [HORIZONTAL].
 - If [ON] is selected, select [BOTH].
- 6) Press ◀▶ to adjust.

Note

- When [ASPECT] is set to [THROUGH], [ZOOM] cannot be adjusted.

When [ASPECT] is set to [DEFAULT]

- 1) Press ▲▼ to select [ZOOM].
- 2) Press the <ENTER> button.
 - The [ZOOM] screen is displayed.
- 3) Press ▲▼ to select [MODE].

4) Press ◀▶ to switch the item.

[INTERNAL]	Enlarges the size within the aspect range set with [SCREEN FORMAT].
[FULL]	Enlarges or reduces the size using the entire display area set with [SCREEN FORMAT].

5) Press ▲▼ to select [INTERLOCKED].

6) Press ◀▶ to switch the item.

[OFF]	Sets the [VERTICAL] and [HORIZONTAL] zoom ratio.
[ON]	Uses [BOTH] to set zoom ratio. Image can be enlarged or reduced vertically and horizontally at the same magnification.

7) Press ▲▼ to select [VERTICAL] or [HORIZONTAL].

- If [ON] is selected, select [BOTH].

8) Press ◀▶ to adjust.

Note

- When [ASPECT] is not set to [DEFAULT], [MODE] is not displayed.
- Zoom ratio less than 100 cannot be set when the video signal fulfilling one of the following conditions is being input.
 - Video signal with resolution exceeding 1 920 x 1 200 dots
 - Video signal with dot clock frequency exceeding 150 MHz

[GEOMETRY]

You can correct various types of distortion in a projected image.

Unique image processing technology enables projection of a square image on a special screen shape.

The projected image can be made to look more natural by making topical correction as necessary.

1) Press ▲▼ to select [GEOMETRY].

2) Press ◀▶ to switch the item.

- The items will switch each time you press the button.

[OFF]	Does not perform geometric adjustment.
[KEYSTONE]	Adjusts any trapezoidal distortion in the projected image.
[CORNER/PINCUSHION]	Adjusts any distortion in the four corners of the projected image.
[CURVED CORRECTION]	Adjusts any curved distortion in the projected image.
[PC-1]	Select this item when performing correction using a computer and “Geometric & Setup Management Software” ^{*1} . Up to three correction data can be saved.
[PC-2]	
[PC-3]	

*1 “Geometric & Setup Management Software” can be downloaded from the Panasonic website (<https://panasonic.net/cns/projector/pass/>). It is necessary to register and login to PASS to download.

Note

- The menu, logo, or waveform monitor display may run off the screen when [GEOMETRY] is set.
- If [EDGE BLENDING] (▶ page 107) adjustment and [GEOMETRY] are used together, correct edge blending adjustment may not be possible in certain environments.
- The image may disappear for a moment or may be disrupted while performing adjustment, but it is not a malfunction.

Setting [KEYSTONE] or [CURVED CORRECTION]

1) Press ▲▼ to select [GEOMETRY].



2) Press ◀▶ to select [KEYSTONE] or [CURVED CORRECTION].

3) Press the <ENTER> button.

- The [GEOMETRY:KEYSTONE] or [GEOMETRY:CURVED CORRECTION] screen is displayed.

4) Press ▲▼ to select the item to adjust.

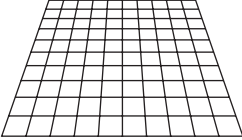
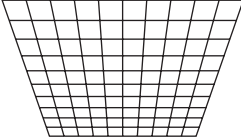
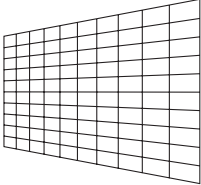
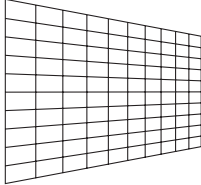
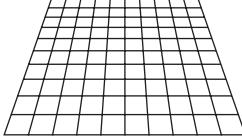
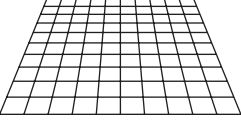
5) Press ◀▶ to adjust.

[KEYSTONE]	
<p>[LENS THROW RATIO] Set the throw ratio. Select the value close to the actual projection distance divided by projected image width here.</p>	
<p>[VERTICAL KEYSTONE]</p> <div style="display: flex; justify-content: space-around; align-items: center;">   </div>	<p>[HORIZONTAL KEYSTONE]</p> <div style="display: flex; justify-content: space-around; align-items: center;">   </div>
<p>[VERTICAL BALANCE]</p> <div style="display: flex; justify-content: space-around; align-items: center;">   </div> <p style="font-size: small;">Adjust the setting according to the lens shift range in the vertical direction.</p>	<p>[HORIZONTAL BALANCE]</p> <div style="display: flex; justify-content: space-around; align-items: center;">   </div> <p style="font-size: small;">Adjust the setting according to the lens shift range in the horizontal direction.</p>
<p>[FREE GRID] Finer adjustment is possible by selecting the points or lines to be corrected. For details of operation, refer to "Adjusting distortion with [FREE GRID]" (➡ page 102).</p>	

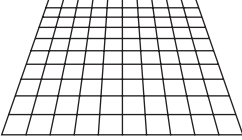
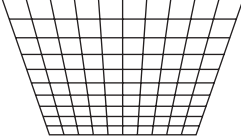
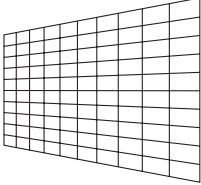
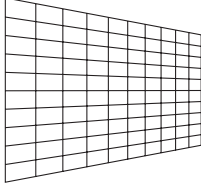
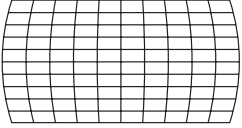
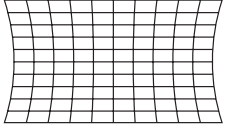
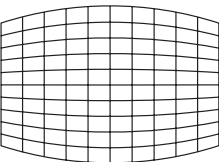
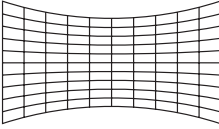
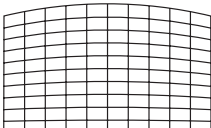
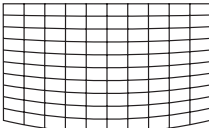
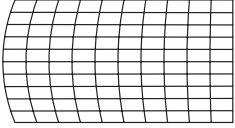
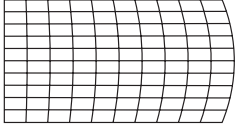
[CURVED CORRECTION]	
<p>[LENS THROW RATIO] Set the throw ratio. Select the value close to the actual projection distance divided by projected image width here.</p>	
<p>[VERTICAL KEYSTONE]</p> <div style="display: flex; justify-content: space-around; align-items: center;">   </div>	<p>[HORIZONTAL KEYSTONE]</p> <div style="display: flex; justify-content: space-around; align-items: center;">   </div>
<p>[VERTICAL ARC]</p> <div style="display: flex; justify-content: space-around; align-items: center;">   </div>	<p>[HORIZONTAL ARC]</p> <div style="display: flex; justify-content: space-around; align-items: center;">   </div>
<p>[VERTICAL BALANCE]</p> <div style="display: flex; justify-content: space-around; align-items: center;">   </div>	<p>[HORIZONTAL BALANCE]</p> <div style="display: flex; justify-content: space-around; align-items: center;">   </div>
<p>[MAINTAIN ASPECT RATIO] Select [ON] to correct while keeping the aspect ratio.</p>	
<p>[FREE GRID] Finer adjustment is possible by selecting the points or lines to be corrected. For details of operation, refer to "Adjusting distortion with [FREE GRID]" (➡ page 102).</p>	

Setting [CORNER/PINCUSHION]

- 1) Press ▲▼ to select [GEOMETRY].
- 2) Press ◀▶ to select [CORNER/PINCUSHION].

- 3) Press the <ENTER> button.
 - The [GEOMETRY:CORNER/PINCUSHION] screen is displayed.
- 4) Press ▲▼ to select the item to adjust, and press the <ENTER> button.
 - When [LINEARITY] is selected, press ◀▶ to select either adjustment method ([AUTO] or [MANUAL]). Select [AUTO] normally.
For details of operation when [MANUAL] is selected, refer to “Adjusting to desired linearity” (➡ page 102).
- 5) Press ▲▼◀▶ to adjust.

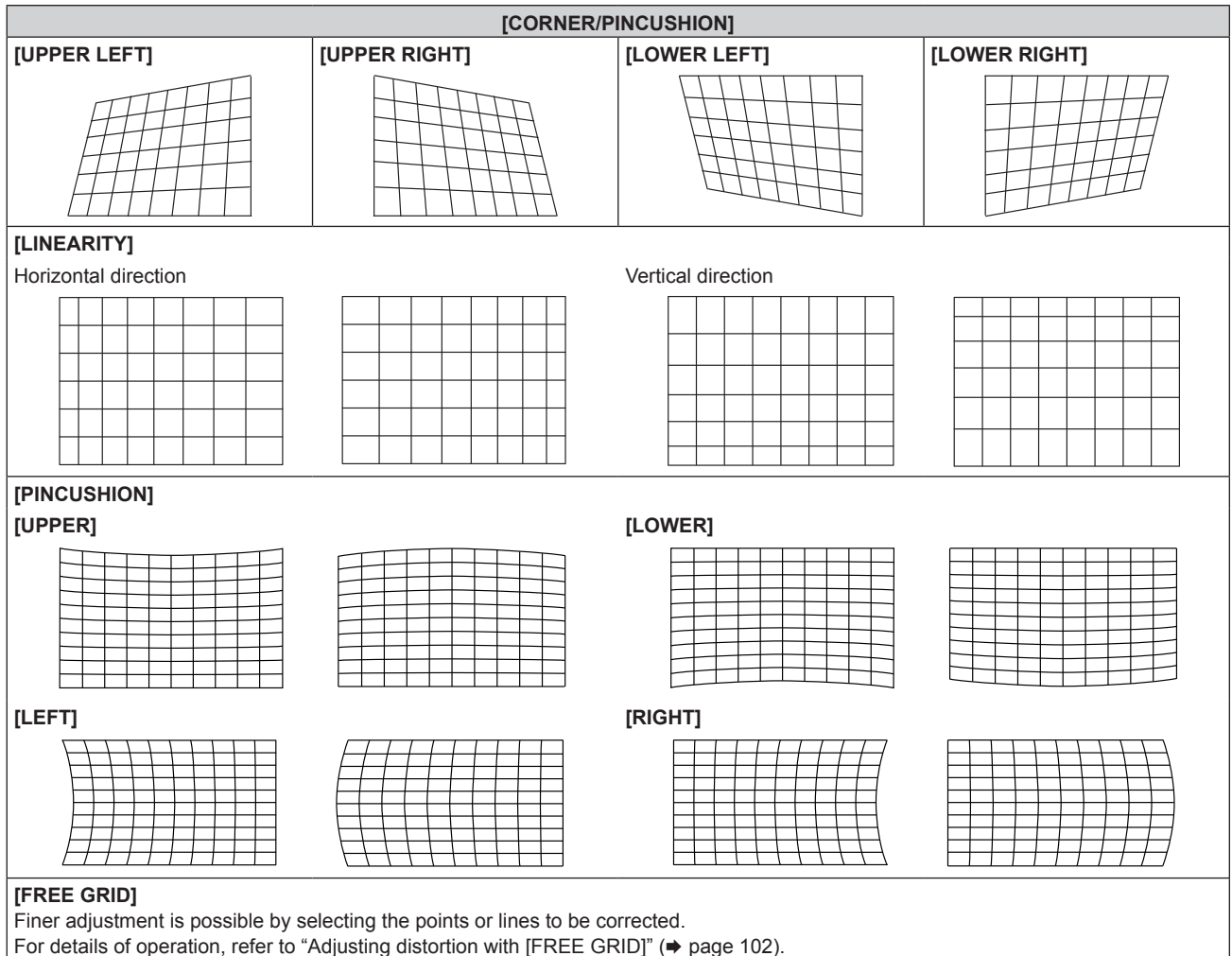

Adjusting to desired linearity

- 1) Press ▲▼ to select [GEOMETRY].
- 2) Press ◀▶ to select [CORNER/PINCUSHION].
- 3) Press the <ENTER> button.
 - The [GEOMETRY:CORNER/PINCUSHION] screen is displayed.
- 4) Press ▲▼ to select [LINEARITY].
- 5) Press ◀▶ to select [MANUAL].
- 6) Press the <ENTER> button.
 - The [LINEARITY] screen is displayed.
- 7) Press ▲▼◀▶ to adjust.

Adjusting distortion with [FREE GRID]

- 1) Press ▲▼ to select [GEOMETRY].

2) Press ◀▶ to select an item other than [OFF].

3) Press the <ENTER> button.

- The screen for the selected item is displayed.

4) Press ▲▼ to select [FREE GRID].

5) Press ◀▶ to select an item.

- The items will switch each time you press the button.

[OFF]	Disables the adjustment to be performed with [FREE GRID].
[ON]	Enables the adjustment to be performed with [FREE GRID].

- Proceed to Step 6) when [ON] is selected.

6) Press the <ENTER> button.

- The [FREE GRID] screen is displayed.

7) Press ▲▼ to select [GRID RESOLUTION].

8) Press ◀▶ to switch the item.

- The items will switch each time you press the button.

[2x2]	Performs the adjustment using the pattern of the outer border (there are two lines each vertically and horizontally as a grid line).
[3x3]	Performs the adjustment using the grid pattern divided into two in the horizontal direction and also in the vertical direction.
[5x5]	Performs the adjustment using the grid pattern divided into four in the horizontal direction and also in the vertical direction. (Factory default setting)
[9x9]	Performs the adjustment using the grid pattern divided into eight in the horizontal direction and also in the vertical direction.
[17x17]	Performs the adjustment using the grid pattern divided into 16 in the horizontal direction and also in the vertical direction.

9) Press ▲▼ to select [CONTROL POINTS].

10) Press ◀▶ to switch the item.

- The items will switch each time you press the button.

[POINT]	Select this item when adjusting by selecting one intersection from the intersections on the grid lines.
[HORIZONTAL LINE]	Select this item when selecting all the intersections on one horizontal grid line, and adjusting them simultaneously.
[VERTICAL LINE]	Select this item when selecting all the intersections on one vertical grid line, and adjusting them simultaneously.

11) Press ▲▼ to select [GRID WIDTH].

12) Press ◀▶ to switch the item.

- The items will switch each time you press the button.

[1] - [10]	Select the width of the grid line. It can be set between 1 line to 10 lines. (Factory default setting: [5])
------------	--

13) Press ▲▼ to select [GRID COLOR].

14) Press ◀▶ to switch the item.

- The items will switch each time you press the button.

[WHITE]	
[BLACK]	
[RED]	
[GREEN]	Displays the pattern of the selected color. (Factory default setting: [RED])
[BLUE]	
[CYAN]	
[MAGENTA]	
[YELLOW]	
[OFF]	

15) Press ▲▼ to select [CONTROL POINTS COLOR].

16) Press ◀▶ to switch the item.

- The items will switch each time you press the button.

[WHITE]	
[BLACK]	
[RED]	Select the color of the marker that indicates the control point. The marker that indicates the control point is displayed in the control point selection mode and adjustment mode. (Factory default setting: [WHITE])
[GREEN]	
[BLUE]	
[CYAN]	
[MAGENTA]	
[YELLOW]	
[WHITE]	
[BLACK]	

17) Press ▲▼ to select [EXECUTE].

18) Press the <ENTER> button.

- The screen switches to the control point selection mode.

19) Press ▲▼◀▶ to select the control point.

- Move the marker over the intersection of the grid lines to adjust.
- When [HORIZONTAL LINE] is selected in Step 10), press ▲▼ to select the control point.
- When [VERTICAL LINE] is selected in Step 10), press ◀▶ to select the control point.

20) Press the <ENTER> button.

- The control point is confirmed, and the screen switches to the adjustment mode.

21) Press ▲▼◀▶ to adjust the position of the control point.

- By adjusting the position of the control point, the range to the neighboring intersections will be corrected.
- To continuously adjust the position of the other intersection, press the <MENU> button or the <ENTER> button to return to Step 19).
- Pressing the <MENU> button twice allows to reselect [GRID RESOLUTION], [CONTROL POINTS], [GRID WIDTH], [GRID COLOR], and [CONTROL POINTS COLOR].

Note

- The contents adjusted in [FREE GRID] are saved as individual correction data for [KEystone], [CORNER/PINCUSHION], [CURVED CORRECTION], [PC-1], [PC-2], and [PC-3].
- Even if [GRID RESOLUTION] or [CONTROL POINTS] is reselected, the correction data adjusted before the reselection is maintained.
- By selecting more narrow grid pattern with [GRID RESOLUTION], the range of effect of the control point position adjustment will be smaller. To perform topical fine adjustment, it is recommended to adjust by setting [GRID RESOLUTION] to [17x17].
- The image is not displayed correctly when the position of the control point exceeds the neighboring intersections.
- The settings of [GRID RESOLUTION], [CONTROL POINTS], [GRID WIDTH], [GRID COLOR], and [CONTROL POINTS COLOR] are synchronized with the setting items under each item of [KEystone], [CORNER/PINCUSHION], [CURVED CORRECTION], [PC-1], [PC-2], and [PC-3].

Initializing adjustments for [FREE GRID]

Initialize the correction data adjusted with [FREE GRID] and restore the factory default settings (the state where no correction is performed). Simultaneously the settings of [GRID RESOLUTION], [CONTROL POINTS], [GRID WIDTH], [GRID COLOR], and [CONTROL POINTS COLOR] are restored to the factory default settings.

1) Press ▲▼ to select [GEOMETRY].

2) Press ◀▶ to select the item to initialize its correction data in [FREE GRID].

- 3) **Press the <ENTER> button.**
 - The screen for the selected item is displayed.
- 4) **Press ▲▼ to select [FREE GRID].**
- 5) **Press ◀▶ to select [ON].**
- 6) **Press the <ENTER> button.**
 - The [FREE GRID] screen is displayed.
- 7) **Press ▲▼ to select [INITIALIZE].**
- 8) **Press the <ENTER> button.**
 - The confirmation screen is displayed.
- 9) **Press ◀▶ to select [OK], and press the <ENTER> button.**

Note

- Each correction data for [KEystone], [CORNER/PINCUSHION], [CURVED CORRECTION], [PC-1], [PC-2], and [PC-3] cannot be initialized at once.
To initialize all the correction data, select each item and execute [INITIALIZE] individually.
- When the projector is initialized by one of the following methods, all data in [FREE GRID] are initialized.
 - When initialized by selecting the [PROJECTOR SETUP] menu → [INITIALIZE] → [FACTORY RESET]
 - When initialized by setting the [PROJECTOR SETUP] menu → [INITIALIZE] → [USER SETTINGS] → [OTHER USER SETTING] to [INITIALIZE]

[CONVERGENCE]

Correct the position shift of the three primary colors of red, green, and blue in the projected image.

- 1) **Press ▲▼ to select [CONVERGENCE].**
- 2) **Press ◀▶ to switch the item.**
 - The items will switch each time you press the button.

[OFF]	Disables the convergence function.
[ON]	Enables the convergence function.

- Proceed to Step 3) when [ON] is selected.
- 3) **Press the <ENTER> button.**
 - The [CONVERGENCE] screen is displayed.
 - 4) **Press ▲▼ to select the color to adjust, and press the <ENTER> button.**
 - 5) **Press ▲▼ to select the position on the projected image to adjust and adjustment direction, and press ◀▶ to adjust.**

Note

- The picture quality may degrade when the convergence function is used.
- It is recommended to perform the adjustment with the convergence function after 30 minutes have elapsed with the focus test pattern displayed. For details of the test pattern, refer to "[TEST PATTERN] menu" (➔ page 181).

[ADVANCED MENU] menu

On the menu screen, select [ADVANCED MENU] from the main menu, and select an item from the sub-menu.

Refer to “Navigating through the menu” (➔ page 84) for the operation of the menu screen.

[DIGITAL CINEMA REALITY]

The picture quality is enhanced by raising the vertical resolution higher performing the cinema processing when interlace signal for moving image is input.

- 1) Press ▲▼ to select [DIGITAL CINEMA REALITY].
- 2) Press ◀▶ to switch the item.
 - The items will switch each time you press the button.

[AUTO]	Automatically detects the input signal and performs cinema processing.	
[OFF]	Does not perform cinema processing.	
[30p FIXED]	When 60 Hz vertical scanning frequency signals are input	Performs forced cinema processing (2:2 pulldown).
[25p FIXED]	When 50 Hz vertical scanning frequency signals are input	

Note

- In [DIGITAL CINEMA REALITY], the picture quality will degrade when a signal other than the 2:2 pulldown is set as [25p FIXED] or [30p FIXED]. (Vertical resolution will degrade.)
- [DIGITAL CINEMA REALITY] is fixed to [OFF] in the following cases.
 - When [FRAME RESPONSE] is set to [FAST]
- The [DIGITAL CINEMA REALITY] setting is disabled and fixed to [OFF] when [DIGITAL CINEMA REALITY] is set to anything other than [OFF] and the following setting or operation is performed.
 - Set [FRAME RESPONSE] to [FAST].

[BLANKING]

Adjust the blanking width if there is a noise at the edge of the screen or the image is slightly running out from the screen.

- 1) Press ▲▼ to select [BLANKING].
- 2) Press the <ENTER> button.
 - The [BLANKING] adjustment screen is displayed.
- 3) Press ▲▼ to select [UPPER], [LOWER], [LEFT], or [RIGHT].
- 4) Press ◀▶ to adjust the blanking width.

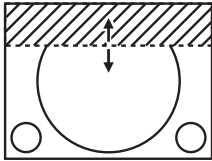
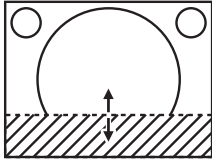
Blanking correction	Item	Operation	Adjustment	Range of adjustment	
Top of the screen	[UPPER]	Press ◀.	The blanking zone moves upward.		Top and bottom 0 - 2158
		Press ▶.	The blanking zone moves downward.		
Bottom of the screen	[LOWER]	Press ▶.	The blanking zone moves upward.		
		Press ◀.	The blanking zone moves downward.		

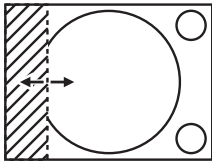
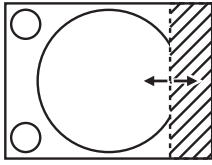
Blanking correction	Item	Operation	Adjustment	Range of adjustment	
Left side of the screen	[LEFT]	Press ►.	The blanking zone moves to the right.		Left and right 0 - 4094
		Press ◀.	The blanking zone moves to the left.		
Right side of the screen	[RIGHT]	Press ◀.	The blanking zone moves to the right.		
		Press ►.	The blanking zone moves to the left.		

Note

- The upper limit of the adjustment range may be restricted so that the entire projected image is not covered by blanking width.

[EDGE BLENDING]

The overlapping area is made seamless by creating inclination in the brightness in the overlapped area when structuring a multi-display screen by combining the projected images from multiple projectors.

It is recommended that edge blending is adjusted after an image is projected continuously for at least 30 minutes and then the image is stable.

1) Press ▲▼ to select [EDGE BLENDING].

2) Press ◀▶ to switch the item.

- The items will switch each time you press the button.

[OFF]	Sets the edge blending function to off.
[ON]	Use the setting value preset in the projector for the inclination of the edge blending area.
[USER]	Use the user-setting value for the inclination of the edge blending area. (Configuration/registration requires separate software. Consult your dealer.)

- Proceed to Step 3) when anything other than [OFF] is selected.

3) Press the <ENTER> button.

- The [EDGE BLENDING] screen is displayed.

4) Press ▲▼ to specify the location to be corrected.

- When joining at top: Set [UPPER] to [ON]
- When joining at bottom: Set [LOWER] to [ON]
- When joining at left: Set [LEFT] to [ON]
- When joining at right: Set [RIGHT] to [ON]

5) Press ◀▶ to switch to [ON].

6) Press ▲▼ to select [START] or [WIDTH].

7) Press ◀▶ to adjust the starting position or correction width.

8) Press ▲▼ to select [MARKER].

9) Press ◀▶ to switch to [ON].

- A marker for image position adjustment is displayed. The position where the red and green lines overlap for the projectors to be joined will be the optimal point. Make sure to set the correction width for the projectors to be joined with the same value. Optimal joining is not possible with projectors that have different correction widths.

The optimal point is the point at which these lines overlap.

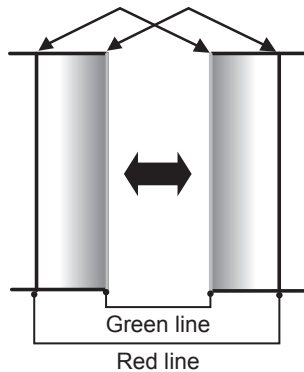

10) Press ▲▼ to select [BRIGHTNESS ADJUST].

11) Press the <ENTER> button.

- The [BRIGHTNESS ADJUST] screen is displayed.
- By setting [AUTO TESTPATTERN] to [ON] on the [EDGE BLENDING] screen, the black test pattern is displayed when you enter the [BRIGHTNESS ADJUST] screen.

12) Press ▲▼ to select [NON-OVERLAPPED BLACK LEVEL].

13) Press the <ENTER> button.

- The adjustment area in the projected image becomes temporarily bright and the [NON-OVERLAPPED BLACK LEVEL] screen is displayed.
- [RED], [GREEN], and [BLUE] can be adjusted individually if [INTERLOCKED] is set to [OFF].

14) Press ▲▼ to select an item, and press ◀▶ to adjust the setting.

- Once the adjustment is completed, press the <MENU> button to return to the [BRIGHTNESS ADJUST] screen.

15) Press ▲▼ to select [UPPER], [LOWER], [LEFT], or [RIGHT] in [BLACK BORDER WIDTH].

16) Press ◀▶ to set the region (width) of the [BLACK BORDER WIDTH] adjustment.

17) Press ▲▼ to select [UPPER KEYSTONE AREA], [LOWER KEYSTONE AREA], [LEFT KEYSTONE AREA], or [RIGHT KEYSTONE AREA].

18) Press ◀▶ to adjust the tilt of the border between [NON-OVERLAPPED BLACK LEVEL] and [BLACK BORDER LEVEL].

19) Press ▲▼ to select [BLACK BORDER LEVEL].

20) Press the <ENTER> button.

- The adjustment area in the projected image becomes temporarily bright and the [BLACK BORDER LEVEL] screen is displayed.
- [RED], [GREEN], and [BLUE] can be adjusted individually if [INTERLOCKED] is set to [OFF].

21) Press ▲▼ to select an item, and press ◀▶ to adjust the setting.

- Once the adjustment is completed, press the <MENU> button to return to the [BRIGHTNESS ADJUST] screen.

22) Press ▲▼ to select [UPPER], [LOWER], [LEFT], or [RIGHT] for [OVERLAPPED BLACK LEVEL].

23) Press the <ENTER> button.

- The adjustment area in the projected image becomes temporarily bright and the [OVERLAPPED BLACK LEVEL] screen is displayed.
- [RED], [GREEN], and [BLUE] can be adjusted individually if [INTERLOCKED] is set to [OFF].

24) Press ▲▼ to select an item, and press ◀▶ to adjust the setting.

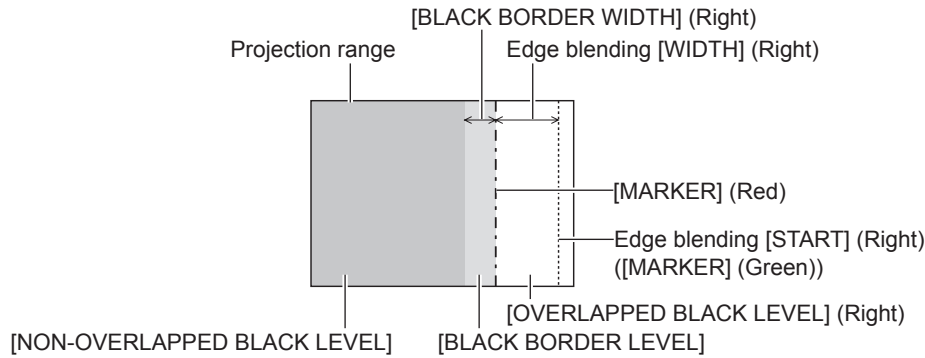

Note

- [BRIGHTNESS ADJUST] is a function that makes the increased brightness in black level of the overlapping image area difficult to notice when [EDGE BLENDING] is used to configure multiple screens. The optimal point of correction is set by adjusting [NON-OVERLAPPED BLACK LEVEL] so the black level of the overlapping image area will be the same level as the non-overlapping area. If the border area of the part where the image is overlapping and the non-overlapping part gets brighter after adjusting [NON-OVERLAPPED BLACK LEVEL], adjust the width of the top, bottom, left, or right. Adjust [BLACK BORDER LEVEL] when the width adjustment makes only the border area darker.
- The joining part may look discontinuous depending on the position you are looking from when a screen with high gain or rear screen is used.
- When configuring multiple screens using both horizontal and vertical edge blending, adjust [OVERLAPPED BLACK LEVEL] first before making adjustments in Step 12). Adjustment method is same as the procedure of [NON-OVERLAPPED BLACK LEVEL].
- If only horizontal or vertical edge blending is used, set all items in [OVERLAPPED BLACK LEVEL] to 0.
- The [AUTO TESTPATTERN] setting changes synchronizing with [AUTO TESTPATTERN] of [COLOR MATCHING].
- Adjustment of the tilt of the border between [NON-OVERLAPPED BLACK LEVEL] and [BLACK BORDER LEVEL] is a function to perform the adjustment of [GEOMETRY] (→ page 100) together with the edge blending. If [NON-OVERLAPPED BLACK LEVEL] is tilted by correcting the keystone from [KEystone] in [GEOMETRY], perform Steps 17) and 18) to adjust the edge blending according to the shape of [NON-OVERLAPPED BLACK LEVEL].

[FRAME RESPONSE]

Set the processing method of the image frame delay.

- 1) Press ▲▼ to select [FRAME RESPONSE].
- 2) Press ◀▶ to switch the item.
 - The items will switch each time you press the button.

[NORMAL]	Standard setting.
[FAST]*1	Simplifies the image processing to reduce image frame delay.
[FIXED]*2	Sets image frame delay to be constant regardless of the image position or magnification.

*1 [FAST] can be set when the input signal is the interlaced signal

*2 Only when moving image signals and still image signals with the vertical scanning frequency of 50 Hz or 60 Hz are input

Note

- When [FRAME RESPONSE] is set to [FAST], the [DIGITAL CINEMA REALITY] setting becomes disabled and is fixed to [OFF].

[FRAME DELAY]

Set the additional delay time against the frame delay status by the [FRAME RESPONSE] setting.

- 1) Press ▲▼ to select [FRAME DELAY].
- 2) Press the <ENTER> button.
 - The [FRAME DELAY] screen is displayed.
- 3) Press ◀▶ to switch the item.
 - The items will switch each time you press the button.

[+0.00ms] - [+100.00ms]	Sets the delay in 0.01 ms increments.
-------------------------	---------------------------------------

- The delay time (approximate) from the point the video signal is input until the image is projected is displayed in [ACTUAL DELAY] of the [FRAME DELAY] screen.

Note

- When the [PROJECTOR SETUP] menu → [MULTI PROJECTOR SYNC] → [MODE] is set to [SLAVE], [FRAME DELAY] cannot be set. In such case, the projector will operate according to the [FRAME DELAY] setting of the projector where the [PROJECTOR SETUP] menu → [MULTI PROJECTOR SYNC] → [MODE] is set to [MASTER].

[RASTER POSITION]

This will allow the position of the image to move within the display area arbitrarily when the input image is not using the whole display area.

- 1) Press ▲▼ to select [RASTER POSITION].
- 2) Press the <ENTER> button.
 - The [RASTER POSITION] screen is displayed.
- 3) Press ▲▼◀▶ to adjust the position.

[DISPLAY LANGUAGE] menu

On the menu screen, select [DISPLAY LANGUAGE] from the main menu, and display the sub-menu. Refer to “Navigating through the menu” (➔ page 84) for the operation of the menu screen.

Changing the display language

You can select the language of the on-screen display.

- 1) Press ▲▼ to select the display language and press the <ENTER> button.

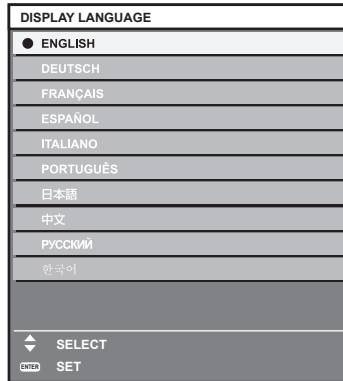

- Various menus, settings, adjustment screens, control button names, etc., are displayed in the selected language.
- The language can be changed to English, German, French, Spanish, Italian, Portuguese, Japanese, Chinese, Russian, or Korean.

Note

- The on-screen display language is set to English in the factory default setting or when the projector is initialized by one of the following methods.
 - When initialized by selecting the [PROJECTOR SETUP] menu → [INITIALIZE] → [FACTORY RESET]
 - When initialized by setting the [PROJECTOR SETUP] menu → [INITIALIZE] → [USER SETTINGS] → [OTHER USER SETTING] to [INITIALIZE]

[DISPLAY OPTION] menu

On the menu screen, select [DISPLAY OPTION] from the main menu, and select an item from the sub-menu.

Refer to “Navigating through the menu” (➔ page 84) for the operation of the menu screen.

[COLOR MATCHING]

Correct the color difference between projectors when using multiple projectors simultaneously.

Adjusting the color matching as desired

- 1) Press ▲▼ to select [COLOR MATCHING].
- 2) Press ◀▶ to switch the item.
 - The items will switch each time you press the button.

[OFF]	Color matching adjustment is not carried out.
[3COLORS]	Adjusts the three colors [RED], [GREEN], or [BLUE].
[7COLORS]	Adjusts the seven colors [RED], [GREEN], [BLUE], [CYAN], [MAGENTA], [YELLOW], or [WHITE].
[MEASURED]	Refer to “Adjusting the color matching using a colorimeter” (➔ page 112) for details about this mode.

- 3) Select [3COLORS] or [7COLORS].
- 4) Press the <ENTER> button.
 - The [3COLORS] or [7COLORS] screen is displayed.
- 5) Press ▲▼ to select [RED], [GREEN], or [BLUE] ([RED], [GREEN], [BLUE], [CYAN], [MAGENTA], [YELLOW], or [WHITE] when [7COLORS] is selected).
 - The adjustment condition can be reset by selecting [RESET]. For details regarding [RESET], refer to “Resetting the adjustment condition of the color matching” (➔ page 113).
- 6) Press the <ENTER> button.
 - The [3COLORS:RED], [3COLORS:GREEN], or [3COLORS:BLUE] screen is displayed.
When [7COLORS] is selected, the [7COLORS:RED], [7COLORS:GREEN], [7COLORS:BLUE], [7COLORS:CYAN], [7COLORS:MAGENTA], [7COLORS:YELLOW], or [7COLORS:WHITE] screen is displayed.
 - By setting [AUTO TESTPATTERN] to [ON], the test pattern for the selected color is displayed.
- 7) Press ▲▼ to select [RED], [GREEN], or [BLUE].
- 8) Press ◀▶ to adjust.
 - The adjustment value changes between 0 and 2 048.

Note

- Operation when correcting the adjustment color
When the correction color same as the adjustment color is changed: The luminance of the adjustment color changes.
When correction color red is changed: Red is added to or subtracted from the adjustment color.
When correction color green is changed: Green is added to or subtracted from the adjustment color.
When correction color blue is changed: Blue is added to or subtracted from the adjustment color.
- Since advanced skills are necessary for the adjustment, this adjustment should be carried out by a person who is familiar with the projector or by a service person.
- When [RESET] is set to [PICTURE MODE] and the <DEFAULT> button on the remote control is pressed, the selected adjustment item will return to the value of factory default for the current picture mode.
- When [RESET] is set to [NATIVE], pressing the <DEFAULT> button on the remote control will return the value to uncorrected value.
- When [COLOR MATCHING] is set to other than [OFF], [COLOR TEMPERATURE] is fixed to [USER1].

Adjusting the color matching using a colorimeter

Use a colorimeter that can measure chromaticity coordinates and luminance to change the colors [RED], [GREEN], [BLUE], [CYAN], [MAGENTA], [YELLOW], or [WHITE] to desired colors.

- 1) Press ▲▼ to select [COLOR MATCHING].
- 2) Press ◀▶ to select [MEASURED].

- 3) Press the <ENTER> button.
 - The [MEASURED MODE] screen is displayed.
- 4) Press ▲▼ to select [MEASURED DATA].
 - The adjustment condition can be reset by selecting [RESET]. For details regarding [RESET], refer to “Resetting the adjustment condition of the color matching” (➡ page 113).
- 5) Press the <ENTER> button.
 - The [MEASURED DATA] screen is displayed.
- 6) Measure the current luminance (Y) and the chromaticity coordinates (x, y) using the colorimeter.
- 7) Press ▲▼ to select a color, and press ◀▶ to adjust the setting.
 - Set [AUTO TESTPATTERN] to [ON] to display a test pattern of selected colors.
- 8) Once all the input is completed, press the <MENU> button.
 - The [MEASURED MODE] screen is displayed.
 - When [MEASURED] is selected in Step 2), proceed to Step 9) and enter the coordinates of desired colors.
- 9) Press ▲▼ to select [TARGET DATA].
- 10) Press the <ENTER> button.
 - The [TARGET DATA] screen is displayed.
- 11) Press ▲▼ to select a color and press ◀▶ to input coordinates for desired colors.
 - By setting [AUTO TESTPATTERN] to [ON], the test pattern for the selected color is displayed.
- 12) Once all the input is completed, press the <MENU> button.

Note

- Colors are not displayed properly when target data is a color outside the region of this projector.
- Set the [AUTO TESTPATTERN] to [ON] to automatically display a test pattern for use in adjusting the selected adjustment colors.
- [AUTO TESTPATTERN] settings change together with the [AUTO TESTPATTERN] of [EDGE BLENDING].
- Before using a colorimeter or similar instrument to measure measurement data, set [PICTURE MODE] to [DYNAMIC].
- A difference in the color coordinates of target data and measurement values obtained from an instrument may occur for certain instruments and measurement environments used.

Resetting the adjustment condition of the color matching

Reset all the adjustment items of the color matching adjusted in [3COLORS], [7COLORS], and [MEASURED].

- 1) Press ▲▼ to select [COLOR MATCHING].
- 2) Press ◀▶ to select [3COLORS], [7COLORS], or [MEASURED].
- 3) Press the <ENTER> button.
 - The [3COLORS], [7COLORS], or [MEASURED MODE] screen is displayed.
- 4) Press ▲▼ to select [RESET].
- 5) Press the <ENTER> button.
 - The confirmation screen is displayed.
- 6) Press ▲▼◀▶ to select [RESET].
- 7) Press ◀▶ to switch the item.
 - The items will switch each time you press the button.

[PICTURE MODE]	Sets all the adjustment items of the color matching to the color value of the factory default for the currently selected picture mode. Set the picture mode in the [PICTURE] menu → [PICTURE MODE].
[NATIVE]	Sets all the adjustment items for color matching to uncorrected value.

- 8) Press ▲▼◀▶ to select [OK], and press the <ENTER> button.
 - The value for color matching is overwritten.

[SCREEN SETTING]

Set the screen size.

Correct to the optimum image position for the set screen when the aspect ratio of a projected image is changed. Set as necessary for the screen in use.

- 1) Press ▲▼ to select [SCREEN SETTING].
- 2) Press the <ENTER> button.
 - The [SCREEN SETTING] screen is displayed.
- 3) Press ◀▶ to switch the [SCREEN FORMAT] item.
 - The items will switch each time you press the button.

[SCREEN FORMAT]	Range when [SCREEN POSITION] is selected
[17:9]	Cannot be adjusted.
[4:3]	Adjusts the horizontal position between -608 and 608.
[16:9]	Adjusts the horizontal position between -128 and 128.
[16:10]	Adjusts the horizontal position between -320 and 320.

- 4) Press ▲▼ to select [SCREEN POSITION].
 - [SCREEN POSITION] cannot be selected or adjusted when [SCREEN FORMAT] is set to [17:9].
- 5) Press ◀▶ to adjust [SCREEN POSITION].

[AUTO SIGNAL]

Set whether to execute automatic setup of signals automatically.

The screen display position or signal level can be adjusted automatically without pressing the <AUTO SETUP> button on the remote control on each occasion if you input unregistered signals frequently at meetings, etc.

- 1) Press ▲▼ to select [AUTO SIGNAL].
- 2) Press ◀▶ to switch the item.
 - The items will switch each time you press the button.

[OFF]	Sets the auto signal function to off.
[ON]	Executes automatic setup automatically when images are changed to unregistered signals during projection.

[AUTO SETUP]

Set the items to automatically adjust while automatic setup function is executed. Also, the automatic setup can be executed.

Adjusting position automatically

- 1) Press ▲▼ to select [AUTO SETUP].
- 2) Press the <ENTER> button.
 - The [AUTO SETUP] screen is displayed.
- 3) Press ▲▼ to select [POSITION ADJUST].
- 4) Press ◀▶ to switch the item.

[ON]	Adjust the screen position and size when automatic setup is executed.
[OFF]	Does not perform automatic adjustment.

Adjusting signal level automatically

- 1) Press ▲▼ to select [AUTO SETUP].

- 2) Press the <ENTER> button.
 - The [AUTO SETUP] screen is displayed.
- 3) Press ▲▼ to select [SIGNAL LEVEL ADJUST].
- 4) Press ◀▶ to switch the item.

[OFF]	Does not perform automatic adjustment.
[ON]	Adjusts black level (the [PICTURE] menu → [BRIGHTNESS]) and white level (the [PICTURE] menu → [CONTRAST]) when automatic setup is executed.

Note

- [SIGNAL LEVEL ADJUST] may not function properly unless a still image containing clear blacks and whites is input.

Executing the automatic setup

- 1) Press ▲▼ to select [AUTO SETUP].
- 2) Press the <ENTER> button.
 - The [AUTO SETUP] screen is displayed.
- 3) Press ▲▼ to select [EXECUTE], and press the <ENTER> button.
 - The automatic setup is executed.

Note

- The automatic setup can also be executed by pressing the <AUTO SETUP> button on the remote control.

[BACKUP INPUT SETTING]

Set the backup function that switches the signal to the backup input signal as seamless as possible when input signal is disrupted.

- 1) Press ▲▼ to select [BACKUP INPUT SETTING].
- 2) Press the <ENTER> button.
 - The [BACKUP INPUT SETTING] screen is displayed.
- 3) Press ▲▼ to select [BACKUP INPUT MODE].
- 4) Press the <ENTER> button.
 - The [BACKUP INPUT MODE] screen is displayed.
- 5) Press ▲▼ to select the combination of the input and press the <ENTER> button.

Primary input	Secondary input	Number of signals constructing one screen	Details
[OFF]		—	Disables the backup function.
[HDMI1 [SLOT1]]*1	[HDMI2 [SLOT1]]*1	1	Enables the backup function.
[HDMI3 [SLOT2]]*2	[HDMI4 [SLOT2]]*2		
[DVI-D1 [SLOT1]]*1	[DVI-D2 [SLOT1]]*1		
[DVI-D3 [SLOT2]]*2	[DVI-D4 [SLOT2]]*2		
[DisplayPort1 [SLOT1]]*3	[DisplayPort3 [SLOT2]]*3		
[SDI1 [SLOT1]]*4	[SDI3 [SLOT1]]*4		
[SDI1 [SLOT2]]*5	[SDI3 [SLOT2]]*5	2	
[SDI1-3 [SLOT1]]*6	[SDI1-3 [SLOT2]]*6		
[SDI1-2-3-4 [SLOT1]]*6	[SDI1-2-3-4 [SLOT2]]*6	4	

*1 This is displayed when the optional Interface Board equipped with corresponding input is installed in <SLOT 1>.
 *2 This is displayed when the optional Interface Board equipped with corresponding input is installed in <SLOT 2>.
 *3 This is displayed when the optional Interface Board for DisplayPort 2 input (Model No.: ET-MDNDP10) is installed in <SLOT 1> and <SLOT 2>.
 *4 This is displayed when the Interface Board for 12G-SDI (Model No.: ET-MDN12G10) is installed in <SLOT 1>.
 *5 This is displayed when the Interface Board for 12G-SDI (Model No.: ET-MDN12G10) is installed in <SLOT 2>.
 *6 This is displayed when the Interface Board for 12G-SDI (Model No.: ET-MDN12G10) is installed in <SLOT 1> and <SLOT 2>.

- 6) Press the <MENU> button.
 - The [BACKUP INPUT SETTING] screen is displayed.
- 7) Press ▲▼ to select [AUTOMATIC SWITCHING].
 - When [BACKUP INPUT MODE] is set to [OFF], [AUTOMATIC SWITCHING] cannot be selected.
- 8) Press ◀▶ to switch the item.
 - The items will switch each time you press the button.

[ENABLE]	Switches to the secondary input (primary input) automatically when the input signal for primary input (secondary input) is disrupted.
[DISABLE]	Disables the automatic input switching function.

Note

- The [BACKUP INPUT SETTING] setting item is common with the following menu item.
 - The [PROJECTOR SETUP] menu → [NO SIGNAL SETTING] → [BACKUP INPUT SETTING]
- The backup function is enabled when [BACKUP INPUT MODE] is set to anything other than [OFF] and same signal is input to the primary input and the secondary input.
- To switch to the backup input signal using the backup function, make sure that the following three conditions are satisfied to be ready to use the function.
 - Set [BACKUP INPUT MODE] to anything other than [OFF].
 - Input the same signal to the primary and secondary inputs.
 - Display the image of the primary input or secondary input.
- If the input is switched to other than the primary or secondary input while the backup function is ready for use, the state of readiness to use the backup function is canceled. To switch to the backup input signal using the backup function again, switch to the primary input or secondary input.
- When [BACKUP INPUT MODE] is set to anything other than [OFF], the combination of that input is displayed in [PRIMARY INPUT] and [SECONDARY INPUT] of the [BACKUP INPUT SETTING] screen.
- [BACKUP INPUT STATUS] is displayed in the input guide (➔ page 135) and the [STATUS] screen (➔ pages 81, 173) when [BACKUP INPUT MODE] is set to anything other than [OFF].

When the signal can be switched to the backup input signal using the backup function, [ACTIVE] is displayed in [BACKUP INPUT STATUS]. When it is not possible, [INACTIVE] is displayed instead.

The secondary input will be the backup input when [BACKUP INPUT STATUS] is displaying [ACTIVE] while the image from the primary input is displayed.

The primary input will be the backup input when [BACKUP INPUT STATUS] is displaying [ACTIVE] while the image from the secondary input is displayed.
- When [BACKUP INPUT MODE] is set to anything other than [OFF], the input is switched seamlessly if the input is switched between the primary input and the secondary input while it is possible to switch to the backup input signal.
- When [AUTOMATIC SWITCHING] is set to [ENABLE], and [BACKUP INPUT STATUS] shows [ACTIVE], the signal is switched to the backup input if a disruption occurs in the input signal.
- When [AUTOMATIC SWITCHING] is set to [ENABLE], the indication in [BACKUP INPUT STATUS] will change to [INACTIVE] if the input signal is disrupted and automatically switched to the backup input. In this case, it is not possible to switch to the backup input signal until the original input signal is restored. If the input has switched to the backup input automatically, it is possible to switch to the backup input signal when the original signal has restored. In this case, the current input is maintained.
- [BACKUP INPUT MODE] in which the input equipped on the optional Interface Board installed in the slot is included as the primary input or the secondary input cannot be selected when the [DISPLAY OPTION] menu → [SIMUL INPUT SETTING] → [AUTO(x2-speed)] is set.
- When [SDI LINK] for the primary input and the secondary input is set to [AUTO], [BACKUP INPUT MODE] for that combination cannot be selected. When [SDI LINK] for the primary input and the secondary input do not match, [BACKUP INPUT MODE] for that combination cannot be selected.

Match the setting in accordance with the signal and then input the same signal in the primary input and the secondary input.

 - The [DISPLAY OPTION] menu → [SLOT IN] → [SDI LINK]
- When [HDMI LINK SETTINGS] or [DVI-D LINK SETTINGS] for the primary input and the secondary input is set to [AUTO], [BACKUP INPUT MODE] for that combination cannot be selected. When [HDMI LINK SETTINGS] or [DVI-D LINK SETTINGS] for the primary input and the secondary input do not match, [BACKUP INPUT MODE] for that combination cannot be selected.

Match the setting in accordance with the signal and then input the same signal in the primary input and the secondary input.

 - The [DISPLAY OPTION] menu → [SLOT IN] → [HDMI LINK]
 - The [DISPLAY OPTION] menu → [SLOT IN] → [DVI-D LINK]
- The primary input setting values are applied to image adjustment values such as the [PICTURE] menu → [PICTURE MODE], [GAMMA], and [COLOR TEMPERATURE].

[SIMUL INPUT SETTING]

Set this function when the video signal in simultaneous format is input and used.

This can be set when the same optional Interface Board supporting the simultaneous input is installed in both of the slots.

- 1) Press ▲▼ to select [SIMUL INPUT SETTING].
- 2) Press the <ENTER> button.
 - The [SIMUL INPUT SETTING] screen is displayed.
- 3) Press ◀▶ to switch the setting.
 - The items will switch each time you press the button.

[OFF]	This is not used for simultaneous input.
[AUTO(x2-speed)]	Displays the image in double speed using the signals input in the two input terminals.

Note

- The image for double speed is displayed when [AUTO(x2-speed)] is set and the same corresponding signal is input to each of the input terminal.
- [SIMUL INPUT SETTING] including the input set as the primary input or the secondary input is fixed to [OFF] when the [PROJECTOR SETUP] menu → [NO SIGNAL SETTING] → [BACKUP INPUT SETTING] → [BACKUP INPUT MODE] is set to anything other than [OFF].
- [SIMUL INPUT SETTING] is fixed to [OFF] when [HDMI LINK], [DVI-D LINK], or [SDI LINK] in [SLOT IN] is set to anything other than [SINGLE].
- When performing the simultaneous input of the 4K image (resolution of 3 840 x 2 160 or 4 096 x 2 160) using the Interface Board for HDMI 2 input (Model No.: ET-MDNHM10), it is necessary for the firmware version of the Interface Board for HDMI 2 input to be 2.00 or later. If the version is earlier than 2.00, the simultaneous process is not performed even if corresponding signal is input. Consult your dealer regarding the version update to the latest firmware.
For details on how to confirm the firmware version, refer to "How to confirm the firmware version of the Interface Board" (▶ page 36).
- [SIMUL INPUT SETTING] cannot be set when the [POSITION] menu → [GEOMETRY] is set to anything other than [OFF]. To input and project the video signal in simultaneous format, use a flat screen so that the geometric adjustment is unnecessary, and install the projector so that the projected image will be rectangular.
- This may not function properly for some connected external devices.
- This may not function properly depending on the signal.

■ [SIMUL INPUT SETTING] screen

Usage of each input signal is displayed under the setting items of [SLOT IN] in the [SIMUL INPUT SETTING] screen when [AUTO(x2-speed)] is set.

[SIMUL INPUT SETTING]	Usage of the input signal	Details
[AUTO(x2-speed)]	[1st FRAME INPUT]	Uses the signal for the corresponding input as a signal for the odd frame.
	[2nd FRAME INPUT]	Uses the signal for the corresponding input as a signal for the even frame.

[SLOT IN]

Set this item in accordance with the signal input to the input terminal of the installed Interface Board when the optional Interface Board is installed in the slot.

The content that can be set varies depending on the structure of the installed Interface Board. It cannot be set if no Interface Board is installed in the slots.

When the optional Interface Board for HDMI 2 input (Model No.: ET-MDNHM10) is installed

Setting [HDMI LINK] in [SLOT IN] (HDMI input)

This can be set when the optional Interface Board for HDMI 2 input (Model No.: ET-MDNHM10) is installed in both of the slots.

- 1) Press ▲▼ to select [SLOT IN].
- 2) Press the <ENTER> button.
 - The [SLOT IN] screen is displayed.
- 3) Press ▲▼ to select [HDMI LINK], and press the <ENTER> button.
 - The [HDMI LINK] screen is displayed.

4) Press ▲▼ to select the setting.

[AUTO]	Automatically selects the single link or the quad link. Selects the quad link when the signal in the same format (such as resolution and timing) is input in the four inputs of HDMI1, HDMI2, HDMI3, and HDMI4.
[SINGLE]	Sets the HDMI1 input, the HDMI2 input, the HDMI3 input, and the HDMI4 input to single link. (Factory default setting)
[QUAD]	Sets the HDMI1 input, the HDMI2 input, the HDMI3 input, and the HDMI4 input to quad link.

5) Press the <ENTER> button.

Note

- [HDMI LINK] is fixed to [SINGLE] in the following cases.
 - When the [DISPLAY OPTION] menu → [SIMUL INPUT SETTING] is set to [AUTO(x2-speed)]
- When the [PROJECTOR SETUP] menu → [NO SIGNAL SETTING] → [BACKUP INPUT SETTING] → [BACKUP INPUT MODE] is set as the combination to use the HDMI input, the [HDMI LINK] setting cannot be changed.
- The content set is displayed in [HDMI LINK SETTINGS].

■ **Structure of the projected image**

The single link is a setting to display one image with one input signal. The quad link is a setting to display one image with four input signals.



Single link



Quad link

Setting [SIGNAL LEVEL] in [SLOT IN] (HDMI input)

- 1) Press ▲▼ to select [SLOT IN].
- 2) Press the <ENTER> button.
 - The [SLOT IN] screen is displayed.
 - Proceed to Step 4) when the optional Interface Board for HDMI 2 input (Model No.: ET-MDNHM10) is installed in either of the slots.
- 3) Press ▲▼ to select [SINGLE LINK SETTING] or [QUAD LINK SETTING], and press the <ENTER> button.
 - The [SINGLE LINK SETTING] screen or the [QUAD LINK SETTING] screen is displayed.
 - Proceed to Step 5).
- 4) Press ▲▼ to select [HDMI1], [HDMI2], [HDMI3], or [HDMI4], and press the <ENTER> button.
 - The [HDMI1] screen, the [HDMI2] screen, the [HDMI3] screen, or the [HDMI4] screen is displayed.
- 5) Press ▲▼ to select [SIGNAL LEVEL].
- 6) Press ◀▶ to switch the item.
 - The items will switch each time you press the button.

[AUTO]	Automatically sets the signal level.
[64-940]	Select this item when the signal output from the HDMI terminal of the external device (such as a Blu-ray disc player) is input to the <HDMI IN 1> terminal, the <HDMI IN 2> terminal, the <HDMI IN 3> terminal, or the <HDMI IN 4> terminal.
[0-1023]	Select this item when the signal output from the DVI-D terminal of the external device (such as a computer) is input to the <HDMI IN 1> terminal, the <HDMI IN 2> terminal, the <HDMI IN 3> terminal, or the <HDMI IN 4> terminal using a conversion cable, etc. Select this item also when the signal output from the HDMI terminal of a computer, etc., is input to the <HDMI IN 1> terminal, the <HDMI IN 2> terminal, the <HDMI IN 3> terminal, and the <HDMI IN 4> terminal.

Note

- The optimal setting varies depending on the output setting of the connected external device. Refer to the operating instructions of the external device regarding the output of the external device.
- The HDMI signal level is displayed for 30 bits of input.

Setting [AUTO GAMMA SELECT] in [SLOT IN] (HDMI input)

Set this item when the gamma mode is to be automatically set based on the InfoFrame information added to the video signal.

- 1) Press ▲▼ to select [SLOT IN].
- 2) Press the <ENTER> button.
 - The [SLOT IN] screen is displayed.
 - Proceed to Step 5) when the optional Interface Board for HDMI 2 input (Model No.: ET-MDNHM10) is installed in either of the slots.
- 3) Press ▲▼ to select [OPTION SETTING].
- 4) Press the <ENTER> button.
 - The [OPTION SETTING] screen is displayed.
 - Proceed to Step 6).
- 5) Press ▲▼ to select [HDMI1], [HDMI2], [HDMI3], or [HDMI4], and press the <ENTER> button.
 - The [HDMI1] screen, the [HDMI2] screen, the [HDMI3] screen, or the [HDMI4] screen is displayed.
- 6) Press ▲▼ to select [AUTO GAMMA SELECT].
- 7) Press ◀▶ to switch the item.
 - The items will switch each time you press the button.

[ENABLE]	Select this item when the gamma mode is to be automatically set to the one compatible with HDR (High Dynamic Range) based on the InfoFrame information added to the video signal. In such case, the [PICTURE] menu → [GAMMA] is set to [HDR ST2084-500], [HDR ST2084-1000], or [HDR HLG].
[DISABLE]	Select this item when the gamma mode is not to be automatically set and to specify the gamma mode with the [PICTURE] menu → [GAMMA].

Note

- Even if [AUTO GAMMA SELECT] is set to [ENABLE], when the information required for the HDR (High Dynamic Range) support is not included in the InfoFrame information added to the displayed video signal, the gamma mode is not automatically set and follows the setting in the [PICTURE] menu → [GAMMA].

Setting [AUTO COLOR SPACE SELECT] in [SLOT IN] (HDMI input)

Set this item when the color space is to be automatically set based on the InfoFrame information added to the video signal.

- 1) Press ▲▼ to select [SLOT IN].
- 2) Press the <ENTER> button.
 - The [SLOT IN] screen is displayed.
 - Proceed to Step 5) when the optional Interface Board for HDMI 2 input (Model No.: ET-MDNHM10) is installed in either of the slots.
- 3) Press ▲▼ to select [OPTION SETTING].
- 4) Press the <ENTER> button.
 - The [OPTION SETTING] screen is displayed.
 - Proceed to Step 6).
- 5) Press ▲▼ to select [HDMI1], [HDMI2], [HDMI3], or [HDMI4], and press the <ENTER> button.
 - The [HDMI1] screen, the [HDMI2] screen, the [HDMI3] screen, or the [HDMI4] screen is displayed.
- 6) Press ▲▼ to select [AUTO COLOR SPACE SELECT].

7) Press ◀▶ to switch the item.

- The items will switch each time you press the button.

[ENABLE]	Select this item when the color space is to be automatically set to the one compatible with HDR (High Dynamic Range) based on the InfoFrame information added to the video signal. In such case, the [PICTURE] menu → [COLOR SPACE] is set to [ITU-2020 emu].
[DISABLE]	Select this item when the color space is not to be automatically set and to specify the color space with the [PICTURE] menu → [COLOR SPACE].

Note

- Even if [AUTO GAMMA SELECT] is set to [ENABLE], when the information required for the HDR (High Dynamic Range) support is not included in the InfoFrame information added to the displayed video signal, the color space is not automatically set and follows the setting in the [PICTURE] menu → [COLOR SPACE].

Setting [EDID SELECT] in [SLOT IN] (HDMI input)

1) Press ▲▼ to select [SLOT IN].

2) Press the <ENTER> button.

- The [SLOT IN] screen is displayed.
- Proceed to Step 5) when the optional Interface Board for HDMI 2 input (Model No.: ET-MDNHM10) is installed in either of the slots.

3) Press ▲▼ to select [OPTION SETTING].

4) Press the <ENTER> button.

- The [OPTION SETTING] screen is displayed.
- Proceed to Step 6).

5) Press ▲▼ to select [HDMI1], [HDMI2], [HDMI3], or [HDMI4], and press the <ENTER> button.

- The [HDMI1] screen, the [HDMI2] screen, the [HDMI3] screen, or the [HDMI4] screen is displayed.

6) Press ▲▼ to select [EDID SELECT].

7) Press ◀▶ to switch the item.

- The items will switch each time you press the button.

[4K/60p/HDR]	Switches to EDID corresponding to the 4K video signal (maximum 4 096 x 2 160 dots, maximum vertical scanning frequency 60 Hz). This is EDID supporting HDR (High Dynamic Range).
[4K/60p/SDR]	Switches to EDID corresponding to the 4K video signal (maximum 4 096 x 2 160 dots, maximum vertical scanning frequency 60 Hz). This is EDID supporting SDR (Standard Dynamic Range). This does not support HDR (High Dynamic Range).
[4K/30p]	Switches to EDID corresponding to the 4K video signal (maximum 4 096 x 2 160 dots, maximum vertical scanning frequency 30 Hz).
[2K]	Switches to EDID corresponding to the 2K video signal (maximum 1 920 x 1 200 dots) or lower.

Note

- Switch the setting to [4K/30p] when proper image is not projected while [EDID SELECT] is set to [4K/60p/SDR] or [4K/60p/HDR] and the 4K video signal is input.
- Switch the setting to [2K] when proper image is not projected while [EDID SELECT] is set to [4K/60p/SDR], [4K/60p/HDR], or [4K/30p] and the 2K video signal or lower is input.
- For details of the signal described in EDID of [4K/60p/SDR], [4K/60p/HDR], [4K/30p], or [2K], refer to “List of plug and play compatible signals” (➡ page 276).

Setting [EDID MODE] in [SLOT IN] (HDMI input)

1) Press ▲▼ to select [SLOT IN].

2) Press the <ENTER> button.

- The [SLOT IN] screen is displayed.
- Proceed to Step 5) when the optional Interface Board for HDMI 2 input (Model No.: ET-MDNHM10) is installed in either of the slots.

- 3) Press ▲▼ to select [OPTION SETTING].
- 4) Press the <ENTER> button.
 - The [OPTION SETTING] screen is displayed.
 - Proceed to Step 6).
- 5) Press ▲▼ to select [HDMI1], [HDMI2], [HDMI3], or [HDMI4], and press the <ENTER> button.
 - The [HDMI1] screen, the [HDMI2] screen, the [HDMI3] screen, or the [HDMI4] screen is displayed.
- 6) Press ▲▼ to select [EDID MODE].
- 7) Press the <ENTER> button.
 - The [HDMI EDID MODE] screen is displayed.
- 8) Press ◀▶ to switch the item.
 - The items will switch each time you press the button.

[DEFAULT]	Standard setting.
[USER]	Sets the [RESOLUTION] and [VERTICAL SCAN FREQUENCY] items to EDID.

- Proceed to Step 13) when [DEFAULT] is selected.
- 9) Press the <ENTER> button.
 - The [RESOLUTION] screen is displayed.
 - 10) Press ▲▼◀▶ to select [RESOLUTION].
 - Select [1024x768p], [1280x720p], [1280x800p], [1280x1024p], [1366x768p], [1400x1050p], [1440x900p], [1600x900p], [1600x1200p], [1680x1050p], [1920x1080p], [1920x1080i], [1920x1200p], or [2048x1080p].
 - 11) Press the <ENTER> button.
 - The [VERTICAL SCAN FREQUENCY] screen is displayed.
 - 12) Press ◀▶ to select [VERTICAL SCAN FREQUENCY].
 - Select [60Hz], [50Hz], [30Hz], [25Hz], or [24Hz] when [2048x1080p] or [1920x1080p] is selected for [RESOLUTION].
 - Select [60Hz], [50Hz], or [48Hz] when [1920x1080i] is selected for [RESOLUTION].
 - Select [60Hz] or [50Hz] when anything other than following is selected for [RESOLUTION].
 - [2048x1080p], [1920x1080p], [1920x1080i]
 - 13) Press the <ENTER> button.
 - The confirmation screen is displayed.
 - 14) Press ◀▶ to select [OK], and press the <ENTER> button.

Note

- The contents set in [RESOLUTION] and [VERTICAL SCAN FREQUENCY] are displayed in [EDID STATUS] of the [OPTION SETTING] screen.
- The resolution and vertical scanning frequency settings may also be required on your computer or video device.
- The computer, video device, or projector in use may require the power to be turned off and on again after configuring settings.
- A signal may not be output with the resolution and vertical scanning frequency that have been set, depending on your computer or video device.

When the optional Interface Board for DVI-D 2 input (Model No.: ET-MDNDV10) is installed

This can be set when the optional Interface Board for DVI-D 2 input (Model No.: ET-MDNDV10) is installed in both of the slots.

Setting [DVI-D LINK] in [SLOT IN] (DVI-D input)

- 1) Press ▲▼ to select [SLOT IN].
- 2) Press the <ENTER> button.
 - The [SLOT IN] screen is displayed.

3) Press ▲▼ to select [DVI-D LINK], and press the <ENTER> button.

- The [DVI-D LINK] screen is displayed.

4) Press ▲▼ to select the setting.

[AUTO]	Automatically selects the single link, the dual link, or the quad link. Selects the quad link when the signal in the same format (such as resolution and timing) is input in the four inputs of DVI-D1, DVI-D2, DVI-D3, and DVI-D4.
[SINGLE]	Sets the DVI-D1 input, the DVI-D2 input, the DVI-D3 input, and the DVI-D4 input to single link. (Factory default setting)
[QUAD]	Sets the DVI-D1 input, the DVI-D2 input, the DVI-D3 input, and the DVI-D4 input to quad link.

5) Press the <ENTER> button.

Note

- [DVI-D LINK] is fixed to [SINGLE] in the following cases.
 - When the [DISPLAY OPTION] menu → [SIMUL INPUT SETTING] is set to [AUTO(x2-speed)]
- When the [PROJECTOR SETUP] menu → [NO SIGNAL SETTING] → [BACKUP INPUT SETTING] → [BACKUP INPUT MODE] is set as the combination to use the DVI-D input, the [DVI-D LINK] setting cannot be changed.
- The content set is displayed in [DVI-D LINK SETTINGS].

■ **Structure of the projected image**

The single link is a setting to display one image with one input signal. The quad link is a setting to display one image with four input signals.



Single link



Quad link

Setting [SIGNAL LEVEL] in [SLOT IN] (DVI-D input)

1) Press ▲▼ to select [SLOT IN].

2) Press the <ENTER> button.

- The [SLOT IN] screen is displayed.
- Proceed to Step 4) when the optional Interface Board for DVI-D 2 input (Model No.: ET-MDNDV10) is installed in either of the slots.

3) Press ▲▼ to select [SINGLE LINK SETTING] or [QUAD LINK SETTING], and press the <ENTER> button.

- The [SINGLE LINK SETTING] screen or the [QUAD LINK SETTING] screen is displayed.
- Proceed to Step 5).

4) Press ▲▼ to select [DVI-D1], [DVI-D2], [DVI-D3], or [DVI-D4], and press the <ENTER> button.

- The [DVI-D1] screen, the [DVI-D2] screen, the [DVI-D3] screen, or the [DVI-D4] screen is displayed.

5) Press ▲▼ to select [SIGNAL LEVEL].

6) Press ◀▶ to switch the item.

- The items will switch each time you press the button.

[AUTO]	Automatically sets the signal level.
[0-255:PC]	Select this item when the signal output from the DVI-D terminal of the external device (such as a computer) is input to the <DVI-D IN 1> terminal, the <DVI-D IN 2> terminal, the <DVI-D IN 3> terminal, or the <DVI-D IN 4> terminal.
[16-235]	Select this item when the signal output from the HDMI terminal of the external device (such as a Blu-ray disc player) is input to the <DVI-D IN 1> terminal, the <DVI-D IN 2> terminal, the <DVI-D IN 3> terminal, or the <DVI-D IN 4> terminal using a conversion cable, etc.

Note

- The optimal setting varies depending on the output setting of the connected external device. Refer to the operating instructions of the external device regarding the output of the external device.

Setting [EDID SELECT] in [SLOT IN] (DVI-D input)

- 1) Press **▲▼** to select [SLOT IN].
- 2) Press the **<ENTER>** button.
 - The [SLOT IN] screen is displayed.
 - Proceed to Step 5) when the optional Interface Board for DVI-D 2 input (Model No.: ET-MDNDV10) is installed in either of the slots.
- 3) Press **▲▼** to select [OPTION SETTING].
- 4) Press the **<ENTER>** button.
 - The [OPTION SETTING] screen is displayed.
 - Proceed to Step 6).
- 5) Press **▲▼** to select [DVI-D1], [DVI-D2], [DVI-D3], or [DVI-D4], and press the **<ENTER>** button.
 - The [DVI-D1] screen, the [DVI-D2] screen, the [DVI-D3] screen, or the [DVI-D4] screen is displayed.
- 6) Press **▲▼** to select [EDID SELECT].
- 7) Press **◀▶** to switch the item.
 - The items will switch each time you press the button.

[EDID3]	Recognizes movie-based video signals and still image signals automatically.
[EDID1]	Select this item mainly when the external device (such as Blu-ray disc player) which outputs the moving image signal is connected to the <DVI-D IN 1> terminal, the <DVI-D IN 2> terminal, the <DVI-D IN 3> terminal, or the <DVI-D IN 4> terminal.
[EDID2:PC]	Select this item mainly when the external device (such as computer) which outputs the still image signal is connected to the <DVI-D IN 1> terminal, the <DVI-D IN 2> terminal, the <DVI-D IN 3> terminal, or the <DVI-D IN 4> terminal.

Note

- The data for Plug and play will change when the setting is changed. Refer to "List of compatible signals" (▶ page 274) for a resolution that supports plug and play.

Setting [EDID MODE] in [SLOT IN] (DVI-D input)

- 1) Press **▲▼** to select [SLOT IN].
- 2) Press the **<ENTER>** button.
 - The [SLOT IN] screen is displayed.
 - Proceed to Step 5) when the optional Interface Board for DVI-D 2 input (Model No.: ET-MDNDV10) is installed in either of the slots.
- 3) Press **▲▼** to select [OPTION SETTING].
- 4) Press the **<ENTER>** button.
 - The [OPTION SETTING] screen is displayed.
 - Proceed to Step 6).
- 5) Press **▲▼** to select [DVI-D1], [DVI-D2], [DVI-D3], or [DVI-D4], and press the **<ENTER>** button.
 - The [DVI-D1] screen, the [DVI-D2] screen, the [DVI-D3] screen, or the [DVI-D4] screen is displayed.
- 6) Press **▲▼** to select [EDID MODE].
- 7) Press the **<ENTER>** button.
 - The [DVI-D EDID MODE] screen is displayed.
- 8) Press **◀▶** to switch [EDID MODE].
 - The items will switch each time you press the button.

[DEFAULT]	Standard setting.
[USER]	Sets the [RESOLUTION] and [VERTICAL SCAN FREQUENCY] items to EDID.

- Proceed to Step 13) when [DEFAULT] is selected.
- 9) Press the <ENTER> button.
 - The [RESOLUTION] screen is displayed.
 - 10) Press ▲▼◀▶ to select [RESOLUTION].
 - Select [1024x768p], [1280x720p], [1280x800p], [1280x1024p], [1366x768p], [1400x1050p], [1440x900p], [1600x900p], [1600x1200p], [1680x1050p], [1920x1080p], [1920x1080i], [1920x1200p], or [2048x1080p].
 - 11) Press the <ENTER> button.
 - The [VERTICAL SCAN FREQUENCY] screen is displayed.
 - 12) Press ◀▶ to select [VERTICAL SCAN FREQUENCY].
 - Select [60Hz], [50Hz], [30Hz], [25Hz], or [24Hz] when [2048x1080p] or [1920x1080p] is selected for [RESOLUTION].
 - Select [60Hz], [50Hz], or [48Hz] when [1920x1080i] is selected for [RESOLUTION].
 - Select [60Hz] or [50Hz] when anything other than following is selected for [RESOLUTION].
 - [2048x1080p], [1920x1080p], [1920x1080i]
 - 13) Press the <ENTER> button.
 - The confirmation screen is displayed.
 - 14) Press ◀▶ to select [OK], and press the <ENTER> button.

Note

- The contents set in [RESOLUTION] and [VERTICAL SCAN FREQUENCY] are displayed in [EDID STATUS] of the [OPTION SETTING] screen.
- The resolution and vertical scanning frequency settings may also be required on your computer or video device.
- The computer, video device, or projector in use may require the power to be turned off and on again after configuring settings.
- A signal may not be output with the resolution and vertical scanning frequency that have been set, depending on your computer or video device.

When the optional Interface Board for DisplayPort 2 input (Model No.: ET-MDNDP10) is installed

Setting [SIGNAL LEVEL] in [SLOT IN] (DisplayPort input)

- 1) Press ▲▼ to select [SLOT IN].
- 2) Press the <ENTER> button.
 - The [SLOT IN] screen is displayed.
- 3) Press ▲▼ to select [DisplayPort1], [DisplayPort2], [DisplayPort3], or [DisplayPort4], and press the <ENTER> button.
 - The [DisplayPort1] screen, the [DisplayPort2] screen, the [DisplayPort3] screen, or the [DisplayPort4] screen is displayed.
- 4) Press ▲▼ to select [SIGNAL LEVEL].
- 5) Press ◀▶ to switch the item.
 - The items will switch each time you press the button.

[AUTO]	Automatically sets the signal level.
[64-940]	Select this item when the signal output from the HDMI terminal of the external device (such as a Blu-ray disc player) is input to the <DisplayPort IN 1> terminal, the <DisplayPort IN 2> terminal, the <DisplayPort IN 3> terminal, or the <DisplayPort IN 4> terminal using a conversion cable, etc.
[0-1023]	Select this item when the signal output from the DisplayPort terminal of the external device (such as a computer) is input to the <DisplayPort IN 1> terminal, the <DisplayPort IN 2> terminal, the <DisplayPort IN 3> terminal, or the <DisplayPort IN 4> terminal. Select this item also when the signal output from the HDMI terminal of a computer, etc., is input to the <DisplayPort IN 1> terminal, the <DisplayPort IN 2> terminal, the <DisplayPort IN 3> terminal, or the <DisplayPort IN 4> terminal using a conversion cable, etc.

Note

- The optimal setting varies depending on the output setting of the connected external device. Refer to the operating instructions of the external device regarding the output of the external device.

Setting [AUTO GAMMA SELECT] in [SLOT IN] (DisplayPort input)

Set this item when the gamma mode is to be automatically set based on the InfoFrame information added to the video signal.

- 1) Press ▲▼ to select [SLOT IN].
- 2) Press the <ENTER> button.
 - The [SLOT IN] screen is displayed.
- 3) Press ▲▼ to select [DisplayPort1], [DisplayPort2], [DisplayPort3], or [DisplayPort4], and press the <ENTER> button.
 - The [DisplayPort1] screen, the [DisplayPort2] screen, the [DisplayPort3] screen, or the [DisplayPort4] screen is displayed.
- 4) Press ▲▼ to select [AUTO GAMMA SELECT].
- 5) Press ◀▶ to switch the item.
 - The items will switch each time you press the button.

[ENABLE]	Select this item when the gamma mode is to be automatically set to the one compatible with HDR (High Dynamic Range) based on the InfoFrame information added to the video signal. In such case, the [PICTURE] menu → [GAMMA] is set to [HDR ST2084-500], [HDR ST2084-1000], or [HDR HLG].
[DISABLE]	Select this item when the gamma mode is not to be automatically set and to specify the gamma mode with the [PICTURE] menu → [GAMMA].

Note

- Even if [AUTO GAMMA SELECT] is set to [ENABLE], when the information required for the HDR (High Dynamic Range) support is not included in the InfoFrame information added to the displayed video signal, the gamma mode is not automatically set and follows the setting in the [PICTURE] menu → [GAMMA].

Setting [AUTO COLOR SPACE SELECT] in [SLOT IN] (DisplayPort input)

Set this item when the color space is to be automatically set based on the InfoFrame information added to the video signal.

- 1) Press ▲▼ to select [SLOT IN].
- 2) Press the <ENTER> button.
 - The [SLOT IN] screen is displayed.
- 3) Press ▲▼ to select [DisplayPort1], [DisplayPort2], [DisplayPort3], or [DisplayPort4], and press the <ENTER> button.
 - The [DisplayPort1] screen, the [DisplayPort2] screen, the [DisplayPort3] screen, or the [DisplayPort4] screen is displayed.
- 4) Press ▲▼ to select [AUTO COLOR SPACE SELECT].
- 5) Press ◀▶ to switch the item.
 - The items will switch each time you press the button.

[ENABLE]	Select this item when the color space is to be automatically set to the one compatible with HDR (High Dynamic Range) based on the InfoFrame information added to the video signal. In such case, the [PICTURE] menu → [COLOR SPACE] is set to [ITU-2020 emu].
[DISABLE]	Select this item when the color space is not to be automatically set and to specify the color space with the [PICTURE] menu → [COLOR SPACE].

Note

- Even if [AUTO COLOR SPACE SELECT] is set to [ENABLE], when the information required for the HDR (High Dynamic Range) support is not included in the InfoFrame information added to the displayed video signal, the color space is not automatically set and follows the setting in the [PICTURE] menu → [COLOR SPACE].

Setting [EDID SELECT] in [SLOT IN] (DisplayPort input)

- 1) Press ▲▼ to select [SLOT IN].
- 2) Press the <ENTER> button.
 - The [SLOT IN] screen is displayed.
- 3) Press ▲▼ to select [DisplayPort1], [DisplayPort2], [DisplayPort3], or [DisplayPort4], and press the <ENTER> button.
 - The [DisplayPort1] screen, the [DisplayPort2] screen, the [DisplayPort3] screen, or the [DisplayPort4] screen is displayed.
- 4) Press ▲▼ to select [EDID SELECT].
- 5) Press ◀▶ to switch the item.
 - The items will switch each time you press the button.

[4K/60p/HDR]	Switches to EDID corresponding to the 4K video signal (maximum 4 096 x 2 160 dots, maximum vertical scanning frequency 60 Hz). This is EDID supporting HDR (High Dynamic Range).
[4K/60p/SDR]	Switches to EDID corresponding to the 4K video signal (maximum 4 096 x 2 160 dots, maximum vertical scanning frequency 60 Hz). This is EDID supporting SDR (Standard Dynamic Range). This does not support HDR (High Dynamic Range).
[4K/30p]	Switches to EDID corresponding to the 4K video signal (maximum 4 096 x 2 160 dots, maximum vertical scanning frequency 30 Hz).
[2K]	Switches to EDID corresponding to the 2K video signal (maximum 1 920 x 1 200 dots) or lower.

Note

- Switch the setting to [4K/30p] when proper image is not projected while [EDID SELECT] is set to [4K/60p/SDR] or [4K/60p/HDR] and the 4K video signal is input.
- Switch the setting to [2K] when proper image is not projected while [EDID SELECT] is set to [4K/60p/SDR], [4K/60p/HDR], or [4K/30p] and the 2K video signal or lower is input.
- For details of the signal described in EDID of [4K/60p/SDR], [4K/60p/HDR], [4K/30p], or [2K], refer to “List of DisplayPort compatible signals” (➔ page 277).

Setting [EDID MODE] in [SLOT IN] (DisplayPort input)

- 1) Press ▲▼ to select [SLOT IN].
- 2) Press the <ENTER> button.
 - The [SLOT IN] screen is displayed.
- 3) Press ▲▼ to select [DisplayPort1], [DisplayPort2], [DisplayPort3], or [DisplayPort4], and press the <ENTER> button.
 - The [DisplayPort1] screen, the [DisplayPort2] screen, the [DisplayPort3] screen, or the [DisplayPort4] screen is displayed.
- 4) Press ▲▼ to select [EDID MODE].
- 5) Press the <ENTER> button.
 - The [DisplayPort EDID MODE] screen is displayed.
- 6) Press ◀▶ to switch the item.
 - The items will switch each time you press the button.

[DEFAULT]	Standard setting.
[USER]	Sets the [RESOLUTION] and [VERTICAL SCAN FREQUENCY] items to EDID.

- Proceed to Step 11) when [DEFAULT] is selected.

- 7) Press the <ENTER> button.
 - The [RESOLUTION] screen is displayed.

- 8) Press ▲▼◀▶ to select [RESOLUTION].
 - Select [1024x768p], [1280x720p], [1280x800p], [1400x1050p], [1600x900p], [1600x1200p], [1920x1080p], [1920x1200p], or [2048x1080p].
- 9) Press the <ENTER> button.
 - The [VERTICAL SCAN FREQUENCY] screen is displayed.
- 10) Press ◀▶ to select [VERTICAL SCAN FREQUENCY].
 - Select [60Hz], [50Hz], [30Hz], [25Hz], or [24Hz] when [2048x1080p] or [1920x1080p] is selected for [RESOLUTION].
 - Select [60Hz] or [50Hz] when anything other than following is selected for [RESOLUTION].
 - [2048x1080p], [1920x1080p]
- 11) Press the <ENTER> button.
 - The confirmation screen is displayed.
- 12) Press ◀▶ to select [OK], and press the <ENTER> button.

Note

- The settings in [RESOLUTION] and [VERTICAL SCAN FREQUENCY] are displayed in [EDID STATUS].
- The resolution and vertical scanning frequency settings may also be required on your computer or video device.
- The computer, video device, or projector in use may require the power to be turned off and on again after configuring settings.
- A signal may not be output with the resolution and vertical scanning frequency that have been set, depending on your computer or video device.

When the Interface Board for 12G-SDI (Model No.: ET-MDN12G10) is installed

Setting [SDI MODE] in [SLOT IN] (SDI input)

Switch input/output of the <SDI 2 IN/1 OUT> terminal and the <SDI 4 IN/3 OUT> terminal.

- 1) Press ▲▼ to select [SLOT IN].
- 2) Press the <ENTER> button.
 - The [SLOT IN] screen is displayed.
- 3) Press ▲▼ to select [SDI MODE].
- 4) Press ◀▶ to switch the item.
 - The items will switch each time you press the button.

[INPUT]	Select this item when using the <SDI 2 IN/1 OUT> terminal and the <SDI 4 IN/3 OUT> terminal as SDI2 input and SDI4 input.
[OUTPUT]	Select this item when the signal input to the <SDI 1 IN> terminal is output from the <SDI 2 IN/1 OUT> terminal, and the signal input to the <SDI 3 IN> terminal is output from the <SDI 4 IN/3 OUT> terminal.

Note

- The <SDI 2 IN/1 OUT> terminal and the <SDI 4 IN/3 OUT> terminal do not support the input of the 6G-SDI signal or the 12G-SDI signal.
- The <SDI 2 IN/1 OUT> terminal and the <SDI 4 IN/3 OUT> terminal support the output of the HD-SDI signal, 3G-SDI signal, 6G-SDI signal, and 12G-SDI signal.
- When the projector is in standby mode, a signal is not output from the <SDI 2 IN/1 OUT> terminal and the <SDI 4 IN/3 OUT> terminal.

Setting [SDI LINK] in [SLOT IN] (SDI input)

- 1) Press ▲▼ to select [SLOT IN].
- 2) Press the <ENTER> button.
 - The [SLOT IN] screen is displayed.
- 3) Press ▲▼ to select [SDI LINK], and press the <ENTER> button.
 - The [SDI LINK] screen is displayed.
- 4) Press ▲▼ to select the setting.

[AUTO]	Automatically selects the single link, the dual link, or the quad link.
[SINGLE]	Sets the SDI1 input, the SDI2 input, the SDI3 input, and the SDI4 input of the Interface Board to single link. (Factory default setting)
[DUAL]	Sets the SDI1 input and the SDI3 input of the Interface Board to dual link.
[QUAD]	Sets the SDI1 input, the SDI2 input, the SDI3 input, and the SDI4 input of the Interface Board to quad link.

5) Press the <ENTER> button.

Note

- The single link is a setting to display one image with one input signal. The dual link is a setting to display one image with two input signals. The quad link is a setting to display one image with four input signals.
- [SDI LINK] is fixed to [SINGLE] in the following cases.
 - When the [DISPLAY OPTION] menu → [SIMUL INPUT SETTING] is set to [AUTO(x2-speed)]
- When the [PROJECTOR SETUP] menu → [NO SIGNAL SETTING] → [BACKUP INPUT SETTING] → [BACKUP INPUT MODE] is set as the combination to use the SDI input, the [SDI LINK] setting cannot be changed.
- When [SDI LINK] is set to [AUTO], use the same format for the signal to be input to the <SDI 1 IN>/<SDI 2 IN/1 OUT>/<SDI 3 IN>/<SDI 4 IN/3 OUT> terminals. If different format signal is input to even one terminal, currently displayed image may not be projected correctly.
- [SDI MAPPING] and [3G-SDI MAPPING] cannot be set when [SDI LINK] is set to [AUTO].
- The content set is displayed in [SDI LINK SETTINGS].

Setting [RESOLUTION] in [SLOT IN] (SDI input)

- 1) Press ▲▼ to select [SLOT IN].
- 2) Press the <ENTER> button.
 - The [SLOT IN] screen is displayed.
- 3) Press ▲▼ to select [SINGLE LINK SETTING], [DUAL LINK SETTING], or [QUAD LINK SETTING], and press the <ENTER> button.
 - The [SINGLE LINK SETTING] screen, the [DUAL LINK SETTING] screen, or the [QUAD LINK SETTING] screen is displayed.
 - Proceed to Step 5) when [DUAL LINK SETTING] or [QUAD LINK SETTING] is selected.
- 4) Press ▲▼ to select [SDI1], [SDI2], [SDI3], or [SDI4], and press the <ENTER> button.
 - The [SINGLE LINK SETTING] screen for the selected item is displayed.
- 5) Press ▲▼ to select [RESOLUTION], and press the <ENTER> button.
 - The [RESOLUTION] screen is displayed.
- 6) Press ▲▼ to select an item, and press the <ENTER> button.
 - Select [AUTO], [1280x720p], [1920x1080i], [1920x1080p], [1920x1080sF], [2048x1080p], [3840x2160p], or [4096x2160p] when SDI1 input or SDI3 input is selected for [SINGLE LINK SETTING].
 - Select [AUTO], [1280x720p], [1920x1080i], [1920x1080p], [1920x1080sF], or [2048x1080p] when SDI2 input or SDI4 input is selected for [SINGLE LINK SETTING].
 - Select [AUTO], [1920x1080p], [2048x1080p], [3840x2160p], or [4096x2160p] when [DUAL LINK SETTING] is selected.
 - Select [AUTO], [3840x2160p], or [4096x2160p] when [QUAD LINK SETTING] is selected.

Setting [4K DIVISION] in [SLOT IN] (SDI input)

Set the transmission method in the 4K division when 4K image is displayed with SDI input.

- 1) Press ▲▼ to select [SLOT IN].
- 2) Press the <ENTER> button.
 - The [SLOT IN] screen is displayed.
- 3) Press ▲▼ to select [SINGLE LINK SETTING], [DUAL LINK SETTING], or [QUAD LINK SETTING], and press the <ENTER> button.
 - The [SINGLE LINK SETTING] screen, the [DUAL LINK SETTING] screen, or the [QUAD LINK SETTING] screen is displayed.
 - Proceed to Step 5) when [DUAL LINK SETTING] or [QUAD LINK SETTING] is selected.

- 4) Press ▲▼ to select [SDI1] or [SDI3], and press the <ENTER> button.
 - The [SINGLE LINK SETTING] screen for the selected item is displayed.
- 5) Press ▲▼ to select [4K DIVISION].
- 6) Press ◀▶ to switch the item.
 - The items will switch each time you press the button.

[AUTO]	Automatically select [SQUARE] or [INTERLEAVE].
[SQUARE]	Fixes the transmission method to Square Division.
[INTERLEAVE]	Fixes the transmission method to 2-Sample Interleave Division.

Setting [SDI MAPPING] in [SLOT IN] (SDI input)

Set the mapping method for the SDI1 input and the SDI3 input.

- 1) Press ▲▼ to select [SLOT IN].
- 2) Press the <ENTER> button.
 - The [SLOT IN] screen is displayed.
- 3) Press ▲▼ to select [SINGLE LINK SETTING] or [DUAL LINK SETTING], and press the <ENTER> button.
 - The [SINGLE LINK SETTING] screen or the [DUAL LINK SETTING] screen is displayed.
 - Proceed to Step 5) when [DUAL LINK SETTING] is selected.
- 4) Press ▲▼ to select [SDI1] or [SDI3], and press the <ENTER> button.
 - The [SINGLE LINK SETTING] screen for the selected item is displayed.
- 5) Press ▲▼ to select [SDI MAPPING].
- 6) Press ◀▶ to switch the item.
 - The items will switch each time you press the button.

[AUTO]	Automatically selects [TYPE1/LEVEL A] or [TYPE2/LEVEL B].
[TYPE1/LEVEL A]	Fixes the mapping method to Type 1 or Level-A.
[TYPE2/LEVEL B]	Fixes the mapping method to Type 2 or Level-B.

Note

- This function does not operate when the HD-SDI signal is input.
- [SDI MAPPING] cannot be set when [SDI LINK] is set to [AUTO].

Setting [3G-SDI MAPPING] in [SLOT IN] (SDI input)

Set the mapping method for the SDI2 input and the SDI4 input.

- 1) Press ▲▼ to select [SLOT IN].
- 2) Press the <ENTER> button.
 - The [SLOT IN] screen is displayed.
- 3) Press ▲▼ to select [SINGLE LINK SETTING] or [QUAD LINK SETTING], and press the <ENTER> button.
 - The [SINGLE LINK SETTING] screen or the [QUAD LINK SETTING] screen is displayed.
 - Proceed to Step 5) when [QUAD LINK SETTING] is selected.
- 4) Press ▲▼ to select [SDI2] or [SDI4], and press the <ENTER> button.
 - The [SINGLE LINK SETTING] screen for the selected item is displayed.
- 5) Press ▲▼ to select [3G-SDI MAPPING].
- 6) Press ◀▶ to switch the item.
 - The items will switch each time you press the button.

[AUTO]	Automatically selects [LEVEL A] or [LEVEL B].
--------	---

[LEVEL A]	Fixes the mapping method to 3G-SDI Level-A.
[LEVEL B]	Fixes the mapping method to 3G-SDI Level-B.

Note

- This function does not operate when the HD-SDI signal is input.
- [3G-SDI MAPPING] cannot be set when [SDI LINK] is set to [AUTO].

Setting [SYSTEM SELECTOR] in [SLOT IN] (SDI input)

- 1) Press ▲▼ to select [SLOT IN].
- 2) Press the <ENTER> button.
 - The [SLOT IN] screen is displayed.
- 3) Press ▲▼ to select [SINGLE LINK SETTING], [DUAL LINK SETTING], or [QUAD LINK SETTING], and press the <ENTER> button.
 - The [SINGLE LINK SETTING] screen, the [DUAL LINK SETTING] screen, or the [QUAD LINK SETTING] screen is displayed.
 - Proceed to Step 5) when [DUAL LINK SETTING] or [QUAD LINK SETTING] is selected.
- 4) Press ▲▼ to select [SDI1], [SDI2], [SDI3], or [SDI4], and press the <ENTER> button.
 - The [SINGLE LINK SETTING] screen for the selected item is displayed.
- 5) Press ▲▼ to select [SYSTEM SELECTOR].
- 6) Press ◀▶ to switch the item.
 - The items will switch each time you press the button.

[AUTO]	Automatically selects [RGB], [YP _B P _R 4:4:4], or [YP _B P _R 4:2:2].
[RGB]	Fixes to [RGB].
[YP _B P _R 4:4:4]	Fixes to [YP _B P _R 4:4:4].
[YP _B P _R 4:2:2]	Fixes to [YP _B P _R 4:2:2].

Setting [BIT DEPTH] in [SLOT IN] (SDI input)

- 1) Press ▲▼ to select [SLOT IN].
- 2) Press the <ENTER> button.
 - The [SLOT IN] screen is displayed.
- 3) Press ▲▼ to select [SINGLE LINK SETTING], [DUAL LINK SETTING], or [QUAD LINK SETTING], and press the <ENTER> button.
 - The [SINGLE LINK SETTING] screen, the [DUAL LINK SETTING] screen, or the [QUAD LINK SETTING] screen is displayed.
 - Proceed to Step 5) when [DUAL LINK SETTING] or [QUAD LINK SETTING] is selected.
- 4) Press ▲▼ to select [SDI1], [SDI2], [SDI3], or [SDI4], and press the <ENTER> button.
 - The [SINGLE LINK SETTING] screen for the selected item is displayed.
- 5) Press ▲▼ to select [BIT DEPTH].
- 6) Press ◀▶ to switch the item.
 - The items will switch each time you press the button.

[AUTO]	Automatically selects [12-bit] or [10-bit].
[12-bit]	Fixes to [12-bit].
[10-bit]	Fixes to [10-bit].

Setting [SIGNAL LEVEL] in [SLOT IN] (SDI input)

- 1) Press ▲▼ to select [SLOT IN].

- 2) Press the <ENTER> button.
 - The [SLOT IN] screen is displayed.
- 3) Press ▲▼ to select [SINGLE LINK SETTING], [DUAL LINK SETTING], or [QUAD LINK SETTING], and press the <ENTER> button.
 - The [SINGLE LINK SETTING] screen, the [DUAL LINK SETTING] screen, or the [QUAD LINK SETTING] screen is displayed.
 - Proceed to Step 5) when [DUAL LINK SETTING] or [QUAD LINK SETTING] is selected.
- 4) Press ▲▼ to select [SDI1], [SDI2], [SDI3], or [SDI4], and press the <ENTER> button.
 - The [SINGLE LINK SETTING] screen for the selected item is displayed.
- 5) Press ▲▼ to select [SIGNAL LEVEL].
- 6) Press ◀▶ to switch the item.
 - The items will switch each time you press the button.

[64-940]	Normally use this setting.
[4-1019]	Select this item when gray is displayed as black.

[DIGITAL LINK IN]

Set this item in accordance with the video signal input to the <DIGITAL LINK> terminal.

Setting [SIGNAL LEVEL] in [DIGITAL LINK IN]

- 1) Press ▲▼ to select [DIGITAL LINK IN].
- 2) Press the <ENTER> button.
 - The [DIGITAL LINK IN] screen is displayed.
- 3) Press ▲▼ to select [SIGNAL LEVEL].
- 4) Press ◀▶ to switch the item.
 - The items will switch each time you press the button.

[AUTO]	Automatically sets the signal level.
[64-940]	Select this item when the signal output from the HDMI terminal of an external device (such as a Blu-ray disc player) is input to the <DIGITAL LINK> terminal via a twisted-pair-cable transmitter.
[0-1023]	Select this item when the signal output from the DVI-D terminal or HDMI terminal of an external device (such as a computer) is input to the <DIGITAL LINK> terminal via a twisted-pair-cable transmitter.

Note

- The optimal setting varies depending on the output setting of the connected external device. Refer to the operating instructions of the external device regarding the output of the external device.
- The signal level is displayed for 30 bits of input.

Setting [AUTO GAMMA SELECT] in [DIGITAL LINK IN]

Set this item when the gamma mode is to be automatically set based on the InfoFrame information added to the video signal.

- 1) Press ▲▼ to select [DIGITAL LINK IN].
- 2) Press the <ENTER> button.
 - The [DIGITAL LINK IN] screen is displayed.
- 3) Press ▲▼ to select [AUTO GAMMA SELECT].
- 4) Press ◀▶ to switch the item.
 - The items will switch each time you press the button.

[ENABLE]	Select this item when the gamma mode is to be automatically set to the one compatible with HDR (High Dynamic Range) based on the InfoFrame information added to the video signal. In such case, the [PICTURE] menu → [GAMMA] is set to [HDR ST2084-500], [HDR ST2084-1000], or [HDR HLG].
[DISABLE]	Select this item when the gamma mode is not to be automatically set and to specify the gamma mode with the [PICTURE] menu → [GAMMA].

Note

- Even if [AUTO GAMMA SELECT] is set to [ENABLE], when the information required for the HDR (High Dynamic Range) support is not included in the InfoFrame information added to the displayed video signal, the gamma mode is not automatically set and follows the setting in the [PICTURE] menu → [GAMMA].

Setting [AUTO COLOR SPACE SELECT] in [DIGITAL LINK IN]

Set this item when the color space is to be automatically set based on the InfoFrame information added to the video signal.

- 1) Press ▲▼ to select [DIGITAL LINK IN].
- 2) Press the <ENTER> button.
 - The [DIGITAL LINK IN] screen is displayed.
- 3) Press ▲▼ to select [AUTO COLOR SPACE SELECT].
- 4) Press ◀▶ to switch the item.
 - The items will switch each time you press the button.

[ENABLE]	Select this item when the color space is to be automatically set to the one compatible with HDR (High Dynamic Range) based on the InfoFrame information added to the video signal. In such case, the [PICTURE] menu → [COLOR SPACE] is set to [ITU-2020 emu.].
[DISABLE]	Select this item when the color space is not to be automatically set and to specify the color space with the [PICTURE] menu → [COLOR SPACE].

Note

- Even if [AUTO GAMMA SELECT] is set to [ENABLE], when the information required for the HDR (High Dynamic Range) support is not included in the InfoFrame information added to the displayed video signal, the color space is not automatically set and follows the setting in the [PICTURE] menu → [COLOR SPACE].

Setting [EDID SELECT] in [DIGITAL LINK IN]

- 1) Press ▲▼ to select [DIGITAL LINK IN].
- 2) Press the <ENTER> button.
 - The [DIGITAL LINK IN] screen is displayed.
- 3) Press ▲▼ to select [EDID SELECT].
- 4) Press ◀▶ to switch the item.
 - The items will switch each time you press the button.

[4K/30p/HDR]	Switches to EDID corresponding to the 4K video signal (maximum 4 096 x 2 160 dots, maximum vertical scanning frequency 30 Hz). This is EDID supporting HDR (High Dynamic Range).
[4K/30p/SDR]	Switches to EDID corresponding to the 4K video signal (maximum 4 096 x 2 160 dots, maximum vertical scanning frequency 30 Hz). This is EDID supporting SDR (Standard Dynamic Range). This does not support HDR (High Dynamic Range).
[2K]	Switches to EDID corresponding to the 2K video signal (maximum 1 920 x 1 200 dots) or lower.
[4K/60p]	Switches to EDID corresponding to the 4K video signal (maximum 4 096 x 2 160 dots, maximum vertical scanning frequency 60 Hz).

Note

- Switch the setting to [4K/30p/HDR] or [4K/30p/SDR] when proper image is not projected while [EDID SELECT] is set to [4K/60p] and the 4K video signal is input.
- Switch the setting to [2K] when proper image is not projected while [EDID SELECT] is set to [4K/60p], [4K/30p/HDR], or [4K/30p/SDR] and the 2K video signal or lower is input.

- For details of the signal described in EDID of [4K/60p], [4K/30p/HDR], [4K/30p/SDR], or [2K], refer to “List of plug and play compatible signals” (➔ page 276).

Setting [EDID MODE] in [DIGITAL LINK IN]

- 1) Press ▲▼ to select [DIGITAL LINK IN].
- 2) Press the <ENTER> button.
 - The [DIGITAL LINK IN] screen is displayed.
- 3) Press ▲▼ to select [EDID MODE].
- 4) Press the <ENTER> button.
 - The [DIGITAL LINK EDID MODE] screen is displayed.
- 5) Press ◀▶ to switch the item.
 - The items will switch each time you press the button.

[DEFAULT]	Standard setting.
[USER]	Sets the [RESOLUTION] and [VERTICAL SCAN FREQUENCY] items to EDID.

- Proceed to Step 10) when [DEFAULT] is selected.
- 6) Press the <ENTER> button.
 - The [RESOLUTION] screen is displayed.
 - 7) Press ▲▼◀▶ to select [RESOLUTION].
 - Select [1024x768p], [1280x720p], [1280x800p], [1280x1024p], [1366x768p], [1400x1050p], [1440x900p], [1600x900p], [1600x1200p], [1680x1050p], [1920x1080p], [1920x1080i], [1920x1200p], or [2048x1080p].
 - 8) Press the <ENTER> button.
 - The [VERTICAL SCAN FREQUENCY] screen is displayed.
 - 9) Press ◀▶ to select [VERTICAL SCAN FREQUENCY].
 - Select [60Hz], [50Hz], [30Hz], [25Hz], or [24Hz] when [2048x1080p] or [1920x1080p] is selected for [RESOLUTION].
 - Select [60Hz], [50Hz], or [48Hz] when [1920x1080i] is selected for [RESOLUTION].
 - Select [60Hz] or [50Hz] when anything other than following is selected for [RESOLUTION].
 - [2048x1080p], [1920x1080p], [1920x1080i]
 - 10) Press the <ENTER> button.
 - The confirmation screen is displayed.
 - 11) Press ◀▶ to select [OK], and press the <ENTER> button.

Note

- The settings in [RESOLUTION] and [VERTICAL SCAN FREQUENCY] are displayed in [EDID STATUS].
- The resolution and vertical scanning frequency settings may also be required on your computer or video device.
- The computer, video device, or projector in use may require the power to be turned off and on again after configuring settings.
- A signal may not be output with the resolution and vertical scanning frequency that have been set, depending on your computer or video device.

[ON-SCREEN DISPLAY]

Set the on-screen display.

Setting [OSD POSITION]

Set the position of the menu screen (OSD).

- 1) Press ▲▼ to select [ON-SCREEN DISPLAY].
- 2) Press the <ENTER> button.
 - The [ON-SCREEN DISPLAY] screen is displayed.
- 3) Press ▲▼ to select [OSD POSITION].

4) Press ◀▶ to switch the item.

- The items will switch each time you press the button.

[2]	Sets to the center left of the screen.
[3]	Sets to the bottom left of the screen.
[4]	Sets to the top center of the screen.
[5]	Sets to the center of the screen.
[6]	Sets to the bottom center of the screen.
[7]	Sets to the upper right of the screen.
[8]	Sets to the center right of the screen.
[9]	Sets to the bottom right of the screen.
[1]	Sets to the upper left of the screen.

Setting [OSD ROTATION]

Set the orientation of the menu screen (OSD).

1) Press ▲▼ to select [ON-SCREEN DISPLAY].

2) Press the <ENTER> button.

- The [ON-SCREEN DISPLAY] screen is displayed.

3) Press ▲▼ to select [OSD ROTATION].

4) Press ◀▶ to switch the item.

- The items will switch each time you press the button.

[OFF]	Does not rotate the screen.
[CLOCKWISE]	Rotates the screen by 90° clockwise.
[COUNTERCLOCKWISE]	Rotates the screen by 90° counterclockwise.

Setting [OSD DESIGN]

Set the color of the menu screen (OSD).

1) Press ▲▼ to select [ON-SCREEN DISPLAY].

2) Press the <ENTER> button.

- The [ON-SCREEN DISPLAY] screen is displayed.

3) Press ▲▼ to select [OSD DESIGN].

4) Press ◀▶ to switch the item.

- The items will switch each time you press the button.

[1]	Sets to yellow.
[2]	Sets to blue.
[3]	Sets to white.
[4]	Sets to green.
[5]	Sets to peach.
[6]	Sets to brown.

Setting [OSD MEMORY]

Set hold for the position of the menu screen (OSD) cursor.

1) Press ▲▼ to select [ON-SCREEN DISPLAY].

2) Press the <ENTER> button.

- The [ON-SCREEN DISPLAY] screen is displayed.

3) Press ▲▼ to select [OSD MEMORY].

4) Press ◀▶ to switch the item.

- The items will switch each time you press the button.

[ON]	Holds the cursor position.
[OFF]	Does not hold the cursor position.

Note

- The cursor position is not maintained even if [OSD MEMORY] is set to [ON].

Setting [INPUT GUIDE]

Set whether to display the input guide in the position set in [OSD POSITION].

The input guide is the screen to display information such as the currently selected input terminal name, signal name, memory number, and [BACKUP INPUT STATUS].

1) Press ▲▼ to select [ON-SCREEN DISPLAY].

2) Press the <ENTER> button.

- The [ON-SCREEN DISPLAY] screen is displayed.

3) Press ▲▼ to select [INPUT GUIDE].

4) Press ◀▶ to switch the item.

- The items will switch each time you press the button.

[ON]	Displays the input guide.
[OFF]	Hides the input guide.

Setting [WARNING MESSAGE]

Set the display/hide of the warning message.

1) Press ▲▼ to select [ON-SCREEN DISPLAY].

2) Press the <ENTER> button.

- The [ON-SCREEN DISPLAY] screen is displayed.

3) Press ▲▼ to select [WARNING MESSAGE].

4) Press ◀▶ to switch the item.

- The items will switch each time you press the button.

[ON]	Displays the warning message.
[OFF]	Hides the warning message.

Note

- If [OFF] is set, the warning message will not be displayed on the projected image even when warning condition such as [TEMPERATURE WARNING] is detected while using the projector. Also, the following countdown message is not displayed: the message until the power is turned off after the no signal shut-off function is executed; the message until the light source is turned off after the no signal lights-out function is executed

[MENU MODE]

Set the display mode of the menu screen (OSD).

1) Press ▲▼ to select [MENU MODE].

2) Press ◀▶ to switch the item.

- The items will switch each time you press the button.

[NORMAL]	Displays all menu items.
[SIMPLE]	Displays some of the menu items that are used for basic setting or adjustment.

Note

- For the menu items that are displayed when [SIMPLE] is set, refer to “Main menu” (➔ page 85), “Sub-menu” (➔ page 86).

[BACK COLOR]

Set the display of the screen when a signal is not input.

- 1) Press ▲▼ to select [BACK COLOR].
- 2) Press ◀▶ to switch the item.
 - The items will switch each time you press the button.

[BLUE]	Displays blue in the entire screen.
[BLACK]	Displays black in the entire screen.
[DEFAULT LOGO]	Displays the Panasonic logo in the screen.
[USER LOGO]	Displays the image registered by the user in the screen.

Note

- The [BACK COLOR] setting item is common with the following menu item.
 - The [PROJECTOR SETUP] menu → [NO SIGNAL SETTING] → [BACK COLOR]
- To create and register the [USER LOGO] image, use “Logo Transfer Software”. The software can be downloaded from the Panasonic website (<https://panasonic.net/cns/projector/>).

[STARTUP LOGO]

Set the logo display when the power is turned on.

- 1) Press ▲▼ to select [STARTUP LOGO].
- 2) Press ◀▶ to switch the item.
 - The items will switch each time you press the button.

[DEFAULT LOGO]	Displays the Panasonic logo.
[USER LOGO]	Displays the image registered by the user.
[NONE]	Disables the startup logo display.

Note

- When [USER LOGO] is selected, the display of the startup logo will be kept for approximately 15 seconds.
- To create and register the [USER LOGO] image, use “Logo Transfer Software”. The software can be downloaded from the Panasonic website (<https://panasonic.net/cns/projector/>).

[UNIFORMITY]

Correct the brightness unevenness and color unevenness of the whole image.

Setting [GRADIENT CORRECTION]

Correction is performed in vertical and horizontal directions to approach the even condition when unevenness in one direction is occurring throughout the whole image.

- 1) Press ▲▼ to select [UNIFORMITY].
- 2) Press the <ENTER> button.
 - The [UNIFORMITY] screen is displayed.
- 3) Press ▲▼ to select [WHITE], [RED], [GREEN], or [BLUE].
- 4) Press ◀▶ to adjust the level.

Item	Operation	Adjustment	Range of adjustment
[VERTICAL]	Press ▶.	The lower-side color becomes pale, or the upper-side color becomes dark.	-127 - +127
	Press ◀.	The upper-side color becomes pale, or the lower-side color becomes dark.	
[HORIZONTAL]	Press ▶.	The left-side color becomes pale, or the right-side color becomes dark.	
	Press ◀.	The right-side color becomes pale, or the left-side color becomes dark.	

Setting [FLEXIBLE CORRECTION]

Correct the topical brightness unevenness and color unevenness using the correction value in the projector.

- 1) Press ▲▼ to select [UNIFORMITY].
- 2) Press the <ENTER> button.
 - The [UNIFORMITY] screen is displayed.
- 3) Press ▲▼ to select [FLEXIBLE CORRECTION].
- 4) Press ◀▶ to switch the item.
 - The items will switch each time you press the button.

[GEOMETRY UNLINKED]	Corrects the brightness unevenness and color unevenness using the correction value in the projector. The shape of the projected image and the compensation area of uniformity are not linked. Select this item to correct the brightness unevenness and the color unevenness of the light irradiated from the projection lens.
[OFF]	Does not perform correction using the correction value in the projector. Select this item to prioritize the brightness of the whole projected image.
[GEOMETRY LINKED]	Corrects the brightness unevenness and color unevenness using the correction value in the projector. When the geometric adjustment is performed, the shape of the projected image and the compensation area of uniformity are linked. Select this item when projecting at an angle against the flat screen, or when projecting on a curved screen.

- Proceed to Step 5) when anything other than [OFF] is selected.

- 5) Press ▲▼ to select [MODE].
- 6) Press ◀▶ to switch the item.
 - The items will switch each time you press the button.

[CHROMA ONLY]	Corrects only the color unevenness. Select this item to prioritize the brightness of the whole projected image.
[LUMINANCE/CHROMA]	Corrects the brightness unevenness and the color unevenness.

Note

- When [GEOMETRY LINKED] is selected, set the projection method and perform geometric adjustment, and then correct the uniformity.

[SHUTTER SETTING]

The operation of the shutter function is set.

Setting [MECHANICAL SHUTTER]

- 1) Press ▲▼ to select [SHUTTER SETTING].
- 2) Press the <ENTER> button.
 - The [SHUTTER SETTING] screen is displayed.
- 3) Press ▲▼ to select [MECHANICAL SHUTTER].
- 4) Press ◀▶ to switch the item.

[ENABLE]	Closes the mechanical shutter when the shutter function is enabled (shutter: closed).
[DISABLE]	Leaves the mechanical shutter opened and turns off the light source when the shutter function is enabled (shutter: closed).

Note

- By closing the mechanical shutter, the malfunction of the DLP chip caused by high power laser ray entering the projection lens surface can be prevented. To close the mechanical shutter, set [MECHANICAL SHUTTER] to [ENABLE] and then set the shutter function to be enabled (shutter: closed).
- When [MECHANICAL SHUTTER] is set to [ENABLE], it will take approximately 0.5 seconds from when the shutter function is enabled (shutter: closed) to the shutter function is disabled (shutter: opened).
- Even if [MECHANICAL SHUTTER] is set to [DISABLE], the projector will go into the standby status with the mechanical shutter closed when [SHUT-OFF] is set to [CLOSE] and the power is turned off.
- The light source may turn on darker to warm up when the shutter function is used when the operating environment temperature is around 0 °C (32 °F) when [MECHANICAL SHUTTER] is set to [DISABLE].

Setting [FADE-IN] or [FADE-OUT]

Set the image fade-in and fade-out when the shutter function operates.

- 1) Press ▲▼ to select [SHUTTER SETTING].
- 2) Press the <ENTER> button.
 - The [SHUTTER SETTING] screen is displayed.
- 3) Press ▲▼ to select [FADE-IN] or [FADE-OUT].
- 4) Press ◀▶ to switch the item.

Item		Adjustment
[FADE-IN] [FADE-OUT]	[OFF]	Does not set fade-in or fade-out.
	[0.5s] - [10.0s]	Sets the fade-in or fade-out time. Select an item from [0.5s] - [4.0s], [5.0s], [7.0s], or [10.0s]. [0.5s] - [4.0s] can be selected in increments of 0.5.

Note

- Press the <SHUTTER> button on the remote control or the control panel during fade-in or fade-out to cancel the fade operation.

Setting [STARTUP]

Automatically enable/disable the shutter function (shutter: closed/opened) when the power is turned on.

- 1) Press ▲▼ to select [SHUTTER SETTING].
- 2) Press the <ENTER> button.
 - The [SHUTTER SETTING] screen is displayed.
- 3) Press ▲▼ to select [STARTUP].
- 4) Press ◀▶ to switch the item.

[OPEN]	The projector goes into projection mode with the shutter function disabled (shutter: opened) when the power is turned on.
[CLOSE]	The projector goes into projection mode with the shutter function enabled (shutter: closed) when the power is turned on.

Setting [SHUT-OFF]

Sets to automatically opens/closes the mechanical shutter when the power is turned off.

- 1) Press ▲▼ to select [SHUTTER SETTING].
- 2) Press the <ENTER> button.
 - The [SHUTTER SETTING] screen is displayed.
- 3) Press ▲▼ to select [SHUT-OFF].
- 4) Press ◀▶ to switch the item.

[CLOSE]	The projector goes into standby mode with the mechanical shutter closed when the projector is switched off.
[KEEP CURRENT STATE]	The projector goes into standby mode with the condition of the mechanical shutter maintained when the projector is switched off.
[OPEN]	The projector goes into standby mode with the mechanical shutter opened when the projector is switched off.

Note

- Even if [MECHANICAL SHUTTER] is set to [DISABLE], the projector will go into the standby status with the mechanical shutter closed when [SHUT-OFF] is set to [CLOSE] and the power is turned off.

Setting the shutter synchronization function

The shutter synchronization function is a function to synchronize the shutter operation of the specified projector to other projectors, and the effect using the shutter function including the fade in/fade out operation can be synchronized.

To use the shutter synchronization function, it is necessary to connect the projectors targeted for synchronization in a loop with daisy chain connection using the <MULTI PROJECTOR SYNC IN> terminal and the <MULTI PROJECTOR SYNC OUT> terminal. For details of how to connect the projectors, refer to “Connecting example when using the contrast synchronization function/shutter synchronization function” (➡ page 56).

- 1) Press ▲▼ to select [SHUTTER SETTING].
- 2) Press the <ENTER> button.
 - The [SHUTTER SETTING] screen is displayed.
- 3) Press ▲▼ to select [MULTI PROJECTOR SYNC].
- 4) Press the <ENTER> button.
 - The [MULTI PROJECTOR SYNC] screen is displayed.
- 5) Press ▲▼ to select [MODE].
- 6) Press ◀▶ to switch the item.
 - The items will switch each time you press the button.

[OFF]	Select this item when the contrast synchronization function and the shutter synchronization function are not used.
[MASTER]	Select this item when the contrast synchronization function or the shutter synchronization function is used. Set this item only on one of the linked projectors that becomes the synchronization source of the shutter operation.
[SLAVE]	Select this item when the contrast synchronization function or the shutter synchronization function is used. Set this item in all the linked projectors excluding the projector set as the [MASTER].

- When anything other than [OFF] is selected, the diagnostic result is displayed in [LINK STATUS], indicating if all the projectors including the projectors targeted for synchronization are correctly connected, and if [MODE] is correctly set.

[LINKED]	All the projectors are correctly connected, and correctly set. They are in the condition that the contrast synchronization function or the shutter synchronization function can be used.
[NO LINK]	The projectors are not correctly connected, or not correctly set. Check the cable connection status and the projector setting for each projector that is linked.

7) Press ▲▼ to select [SHUTTER SYNC].

8) Press ◀▶ to switch the item.

- The items will switch each time you press the button.

[OFF]	Select this item when the shutter synchronization function is not used.
[ON]	Select this item when the shutter synchronization function is used.

Note

- The [MULTI PROJECTOR SYNC] setting item is common with the following menu item.
 - The [PROJECTOR SETUP] menu → [MULTI PROJECTOR SYNC]
 For details on contrast synchronization function, refer to the [PROJECTOR SETUP] menu → [MULTI PROJECTOR SYNC] (▶ page 168).
- The shutter synchronization function will operate when all of the following conditions are fulfilled.
 - All the projectors to be linked are connected in a loop with the daisy chain connection. (Maximum 64 projectors)
 - [MODE] on only one projector that is linked is set to [MASTER], and [MODE] on all other projectors are set to [SLAVE].
 - [SHUTTER SYNC] on the projectors to perform the shutter synchronization is set to [ON].
- It is possible to set [SHUTTER SYNC] to [OFF] for the projectors that are linked but not to synchronize.
- The shutter operation by the shutter synchronization function will follow the setting of the [DISPLAY OPTION] menu → [SHUTTER SETTING] on the projector that [MODE] is set to [MASTER].
- The operation of the mechanical shutter is not included in the shutter synchronization function.
- When the input signal to each linked projector is not synchronized, the timing of the shutter operation between the projectors may shift up to 1 frame while using the shutter synchronization function.
- The shutter function of the projector with [MODE] set to [SLAVE] can be operated individually. The shutter operation at this time will follow the setting of the [DISPLAY OPTION] menu → [SHUTTER SETTING] set in that projector.

[FREEZE]

Pause the projected image temporarily regardless of the playback of the external device.

1) Press ▲▼ to select [FREEZE].

2) Press the <ENTER> button.

- Press the <MENU> button to release.

Note

- [FREEZE] is displayed on the screen when video is paused.

[WAVEFORM MONITOR]

Use the input signals from a connected external device to display in a waveform. Check whether video output (luminance) signal level is within the recommended range for the projector and adjust.

1) Press ▲▼ to select [WAVEFORM MONITOR].

2) Press ◀▶ to switch the item.

[OFF]	Does not display the waveform monitor.
[ON]	Displays the waveform monitor.

3) Press the <MENU> button two times to clear.

4) Press ▲▼ to select any horizontal line.

5) Press the <ENTER> button to switch the Select line to either luminance, red, green, or blue.

- Line selection items switch each time the <ENTER> button is pressed only when the waveform monitor is displayed.

“Select line (luminance)”	Displayed in white waveform.
“Select line (red)”	Displayed in red waveform.
“Select line (green)”	Displayed in green waveform.
“Select line (blue)”	Displayed in blue waveform.

Note

- Setting is also available from the [PROJECTOR SETUP] menu → [FUNCTION BUTTON].
- The waveform monitor is not displayed when on-screen display is hidden (off).

Adjusting the waveform

Project the luminance adjustment signal of a commercial test disk (0 % (0 IRE or 7.5 IRE) – 100 % (100 IRE)) and adjust.

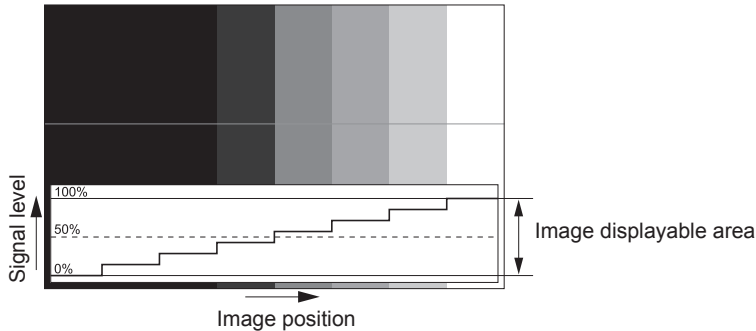

- 1) Select “Select line (luminance)” on the waveform monitor.
- 2) Adjust black level.
 - Adjust the black level 0 % of the video signal to the 0 % position of the waveform monitor using the [PICTURE] menu → [BRIGHTNESS].
- 3) Adjust white level.
 - Adjust the white level 100 % of the video signal to the 100 % position of the waveform monitor using the [PICTURE] menu → [CONTRAST].

Adjusting red, green, and blue

- 1) Set [COLOR TEMPERATURE] to [USER1] or [USER2] (➔ page 90).
- 2) Select “Select line (red)” on the waveform monitor.
- 3) Adjust dark red areas.
 - Use [RED] in [WHITE BALANCE LOW] to adjust the black level 0 % of the video signal to the 0 % position of the waveform monitor.
- 4) Adjust bright red areas.
 - Use [RED] in [WHITE BALANCE HIGH] to adjust the white level 100 % of the video signal to the 100 % position of the waveform monitor.
- 5) Use the procedure for [RED] to adjust [GREEN] and [BLUE].

Note

- Confirm that the [SIGNAL LEVEL] setting of the input signal is correct before adjusting the black level. Check the [SIGNAL LEVEL] setting in following menu in accordance with the input.
 - The [DISPLAY OPTION] menu → [DIGITAL LINK IN] → [SIGNAL LEVEL]
 - [SIGNAL LEVEL] under the [DISPLAY OPTION] menu → [SLOT IN] → [SINGLE LINK SETTING]/[DUAL LINK SETTING]/[QUAD LINK SETTING]

[CUT OFF]

Each red, green, and blue color component can be removed.

- 1) Press ▲▼ to select [CUT OFF].
- 2) Press the <ENTER> button.
 - The [CUT OFF] screen is displayed.
- 3) Press ▲▼ to select [RED], [GREEN], or [BLUE].
- 4) Press ◀▶ to switch the item.

[OFF]	Disables cutoff.
[ON]	Enables cutoff.

Note

- When input is switched or a signal is switched, the cutoff setting returns to its original setting (off).

[PROJECTOR SETUP] menu

On the menu screen, select [PROJECTOR SETUP] from the main menu, and select an item from the sub-menu.

Refer to “Navigating through the menu” (➔ page 84) for the operation of the menu screen.

[PROJECTOR ID]

The projector has an ID number setting function that can be used when multiple projectors are used side by side to enable simultaneous control or individual control via a single remote control.

- 1) Press ▲▼ to select [PROJECTOR ID].
- 2) Press ◀▶ to switch the item.
 - The items will switch each time you press the button.

[ALL]	Select this item when controlling projectors without specifying an ID number.
[1] - [64]	Select this item when specifying an ID number to control individual projector.

Note

- To specify an ID number for individual control, the ID number of a remote control must match the ID number of the projector.
- When the ID number is set to [ALL], the projector will operate regardless of the ID number specified during remote control or computer control.
If multiple projectors are set up side by side with IDs set to [ALL], they cannot be controlled separately from the projectors with other ID numbers.
- Refer to “Setting ID number of the remote control” (➔ page 81) for how to set the ID number on the remote control.

[PROJECTION METHOD]

Set the projection method in accordance with the installation status of the projector.

Change the [FRONT/REAR] setting when the screen display is inverted.

Change the [FLOOR/CEILING] setting when the screen display is upside down.

Setting [FRONT/REAR]

- 1) Press ▲▼ to select [PROJECTION METHOD].
- 2) Press the <ENTER> button.
 - The [PROJECTION METHOD] screen is displayed.
- 3) Press ▲▼ to select [FRONT/REAR].
- 4) Press ◀▶ to switch the item.
 - The items will switch each time you press the button.

[FRONT]	Select this item when installing the projector in front of the screen.
[REAR]	Select this item when installing behind the screen (using translucent screen).

Setting [FLOOR/CEILING]

- 1) Press ▲▼ to select [PROJECTION METHOD].
- 2) Press the <ENTER> button.
 - The [PROJECTION METHOD] screen is displayed.
- 3) Press ▲▼ to select [FLOOR/CEILING].
- 4) Press ◀▶ to switch the item.
 - The items will switch each time you press the button.

[AUTO]	Automatically detects the attitude of the projector by the built-in angle sensor. Set [AUTO] normally.
[FLOOR]	Select this item when installing the projector on a desk, etc.

[CEILING]	Select this item when installing the projector with the top surface of the projector facing down such as ceiling attachment. Projected image is inverted upside down.
------------------	--

Note

- Refer to “Angle sensor” (➔ page 41) for details on the range of the installation attitude that can be detected by the built-in angle sensor.

[LENS]

Perform the setting and operation regarding the projection lens.

The projector is equipped with automatic lens detection function, and information of the projection lens is automatically acquired from the EEPROM (Electrically Erasable Programmable Read-Only Memory) equipped in the projection lens when the projector is turned on. Acquired information can be confirmed in the **[LENS INFORMATION SETTING]** screen or the **[STATUS]** screen.

[LENS INFORMATION SETTING]

Confirming the projection lens information

- 1) Press ▲▼ to select **[LENS]**.
- 2) Press the <ENTER> button.
 - The **[LENS]** screen is displayed.
- 3) Press ▲▼ to select **[LENS INFORMATION SETTING]**.
- 4) Press the <ENTER> button.
 - The **[LENS INFORMATION SETTING]** screen is displayed.

[LENS ID]	Displays the set ID.
[LENS NAME]	Displays the set name.
[LENS TYPE]	Displays the set projection lens type.
[LENS ZOOM TYPE]	Displays the drive method of the zoom motor.

Setting ID to the projection lens

Write the identification information unique to the projection lens into the EEPROM built in the projection lens. Set ID if required.

- 1) Press ▲▼ to select **[LENS]**.
- 2) Press the <ENTER> button.
 - The **[LENS]** screen is displayed.
- 3) Press ▲▼ to select **[LENS INFORMATION SETTING]**.
- 4) Press the <ENTER> button.
 - The **[LENS INFORMATION SETTING]** screen is displayed.
- 5) Press ▲▼ to select **[LENS ID]**.
- 6) Press ◀▶ to switch the item.
 - The items will switch each time you press the button.

[ALL]	Select this item when the ID number is not to be specified.
[1] - [255]	Select this item when the ID number is to be set.

Note

- **[LENS ID]** will not return to the factory default setting even when initialized by any of the following methods.
 - When initialized by selecting the [PROJECTOR SETUP] menu → [INITIALIZE] → [FACTORY RESET]
 - When initialized by setting the [PROJECTOR SETUP] menu → [INITIALIZE] → [USER SETTINGS] → [OTHER USER SETTING] to [INITIALIZE]

Setting name to the projection lens

A name for identifying individual projection lens can be written into the EEPROM built in the projection lens. Set the name if required.

- 1) Press ▲▼ to select [LENS].
- 2) Press the <ENTER> button.
 - The [LENS] screen is displayed.
- 3) Press ▲▼ to select [LENS INFORMATION SETTING].
- 4) Press the <ENTER> button.
 - The [LENS INFORMATION SETTING] screen is displayed.
- 5) Press ▲▼ to select [LENS NAME].
- 6) Press the <ENTER> button.
 - The [LENS NAME INPUT] screen is displayed.
- 7) Press ▲▼◀▶ to select the character, and press the <ENTER> button to enter the character.
- 8) Press ▲▼◀▶ to select [OK], and press the <ENTER> button.
 - Name of the projection lens is changed.

Note

- Factory default name is [LENS01].
- [LENS NAME] will not return to the factory default setting even when initialized by any of the following methods.
 - When initialized by selecting the [PROJECTOR SETUP] menu → [INITIALIZE] → [FACTORY RESET]
 - When initialized by setting the [PROJECTOR SETUP] menu → [INITIALIZE] → [USER SETTINGS] → [OTHER USER SETTING] to [INITIALIZE]

[LENS MEMORY]

The adjusted lens position (vertical position, horizontal position, focus position, and zoom position) can be saved and loaded.

Saving lens position

- 1) Press ▲▼ to select [LENS].
- 2) Press the <ENTER> button.
 - The [LENS] screen is displayed.
- 3) Press ▲▼ to select [LENS MEMORY].
- 4) Press the <ENTER> button.
 - The [LENS MEMORY] screen is displayed.
- 5) Press ▲▼ to select [LENS MEMORY SAVE].
- 6) Press the <ENTER> button.
 - The [LENS MEMORY SAVE] screen is displayed.
 - If the lens memory has already been saved, the name of the saved lens memory and its lens position information ([VERTICAL POSITION]/[HORIZONTAL POSITION]/[FOCUS POSITION]/[ZOOM POSITION]) are displayed in the [LENS MEMORY SAVE] screen.
- 7) Press ▲▼ to select the item to save, and press the <ENTER> button.
 - The confirmation screen is displayed.
 - Current lens position information ([VERTICAL POSITION]/[HORIZONTAL POSITION]/[FOCUS POSITION]/[ZOOM POSITION]) is displayed in the confirmation screen.
- 8) Press ◀▶ to select [OK], and press the <ENTER> button.
 - The [LENS MEMORY NAME INPUT] screen is displayed.
- 9) Press ▲▼◀▶ to select the text, and press the <ENTER> button to enter the text.

10) After the name is input, press ▲▼◀▶ to select [OK], and press the <ENTER> button.

- Saving of the lens memory is completed, and returns to the [LENS MEMORY SAVE] screen.
- If you press ▲▼◀▶ to select [CANCEL] and then press the <ENTER> button, the lens memory will not be saved.
- If you press ▲▼◀▶ to select [DEFAULT] and press the <ENTER> button, the entered name will not be registered and the default name will be used.
- If you select [OK] without entering any characters and press the <ENTER> button, the default name will be used.

Note

- The numeric value information of the zoom position is displayed only when the Zoom Lens is attached.
-

Loading the lens position

1) Press ▲▼ to select [LENS].

2) Press the <ENTER> button.

- The [LENS] screen is displayed.

3) Press ▲▼ to select [LENS MEMORY].

4) Press the <ENTER> button.

- The [LENS MEMORY] screen is displayed.

5) Press ▲▼ to select [LENS MEMORY LOAD].

6) Press the <ENTER> button.

- The [LENS MEMORY LOAD] screen is displayed.
- The name of the saved lens memory and its lens position information ([VERTICAL POSITION]/[HORIZONTAL POSITION]/[FOCUS POSITION]/[ZOOM POSITION]) are displayed in the [LENS MEMORY LOAD] screen.

7) Press ▲▼ to select the item to load, and press the <ENTER> button.

- The confirmation screen is displayed.

8) Press ◀▶ to select [OK], and press the <ENTER> button.

- The lens will automatically move to the lens position (vertical position, horizontal position, focus position, and zoom position) of the loaded lens memory.

Note

- Lens memory is not guaranteed to be 100 % reproduced. Readjust the focus, zoom, and lens shift after loading the lens memory if required.
 - If the projection lens is replaced, execute the [PROJECTOR SETUP] menu → [LENS] → [LENS CALIBRATION], readjust the focus, zoom, and lens shift, and save the lens memory again.
 - The numeric value information of the zoom position is displayed only when the Zoom Lens is attached.
The lens memory for the zoom position will not operate when a projection lens without the zoom function is used.
 - The saved lens memory is loaded in order every time the <FUNCTION> button is pressed when [LENS MEMORY LOAD] is assigned to the <FUNCTION> button.
-

Deleting a lens memory

1) Press ▲▼ to select [LENS].

2) Press the <ENTER> button.

- The [LENS] screen is displayed.

3) Press ▲▼ to select [LENS MEMORY].

4) Press the <ENTER> button.

- The [LENS MEMORY] screen is displayed.

5) Press ▲▼ to select [LENS MEMORY EDIT].

6) Press the <ENTER> button.

- The [LENS MEMORY EDIT] screen is displayed.

- 7) Press ▲▼ to select [LENS MEMORY DELETE].
- 8) Press the <ENTER> button.
 - The [LENS MEMORY DELETE] screen is displayed.
 - The name of the saved lens memory and its lens position information ([VERTICAL POSITION]/[HORIZONTAL POSITION]/[FOCUS POSITION]/[ZOOM POSITION]) are displayed in the [LENS MEMORY DELETE] screen.
- 9) Press ▲▼ to select the item to delete, and press the <ENTER> button.
 - The confirmation screen is displayed.
- 10) Press ◀▶ to select [OK], and press the <ENTER> button.

Note

- The numeric value information of the zoom position is displayed only when the Zoom Lens is attached.

Changing the lens memory name

- 1) Press ▲▼ to select [LENS].
- 2) Press the <ENTER> button.
 - The [LENS] screen is displayed.
- 3) Press ▲▼ to select [LENS MEMORY].
- 4) Press the <ENTER> button.
 - The [LENS MEMORY] screen is displayed.
- 5) Press ▲▼ to select [LENS MEMORY EDIT].
- 6) Press the <ENTER> button.
 - The [LENS MEMORY EDIT] screen is displayed.
- 7) Press ▲▼ to select [LENS MEMORY NAME CHANGE].
- 8) Press the <ENTER> button.
 - The [LENS MEMORY NAME CHANGE] screen is displayed.
 - The name of the saved lens memory and its lens position information ([VERTICAL POSITION]/[HORIZONTAL POSITION]/[FOCUS POSITION]/[ZOOM POSITION]) are displayed in the [LENS MEMORY NAME CHANGE] screen.
- 9) Press ▲▼ to select the name to change, and press the <ENTER> button.
 - The [LENS MEMORY NAME INPUT] screen is displayed.
- 10) Press ▲▼◀▶ to select the text, and press the <ENTER> button to enter the text.
- 11) After the name is changed, press ▲▼◀▶ to select [OK], and press the <ENTER> button.
 - Saving of the lens memory is completed, and returns to the [LENS MEMORY NAME CHANGE] screen.
 - If you press ▲▼◀▶ to select [CANCEL] and then press the <ENTER> button, the changed name will not be registered.
 - If you press ▲▼◀▶ to select [DEFAULT] and press the <ENTER> button, the changed name will not be registered and the default name will be used.
 - If you select [OK] without entering any characters and press the <ENTER> button, the default name will be used.

Note

- The numeric value information of the zoom position is displayed only when the Zoom Lens is attached.

[LENS HOME POSITION]

Operate in following procedure to move the projection lens to the home position.

- 1) Press ▲▼ to select [LENS].

- 2) Press the <ENTER> button.
 - The [LENS] screen is displayed.
- 3) Press ▲▼ to select [LENS HOME POSITION].
- 4) Press the <ENTER> button.
 - The confirmation screen is displayed.
- 5) Press ◀▶ to select [OK], and press the <ENTER> button.
 - The projection lens is moved to the home position.

Note

- [PROGRESS] is displayed in the menu while the projection lens is moved to the home position.
- [LENS HOME POSITION] can also be executed by pressing the <DEFAULT> button on the remote control while the lens shift adjustment screen is displayed.

[ACTIVE FOCUS OPTIMIZER]

Enable/disable the active focus optimizer function. The shift in focus caused by the change of the image brightness can be reduced by enabling this function. It will also reduce the shift in focus right before enabling the shutter function (shutter: closed) and right after disabling the shutter function (shutter: opened).

- 1) Press ▲▼ to select [LENS].
- 2) Press the <ENTER> button.
 - The [LENS] screen is displayed.
- 3) Press ▲▼ to select [ACTIVE FOCUS OPTIMIZER].
- 4) Press the <ENTER> button.
 - The [ACTIVE FOCUS OPTIMIZER] screen is displayed.
- 5) Press ▲▼ to select [ACTIVE FOCUS].
- 6) Press ◀▶ to switch the item.
 - The items will switch each time you press the button.

[OFF]	Disables the active focus optimizer function.
[ON]	Enables the active focus optimizer function.

Note

- When this function is set to [ON], the focus adjustment (adjustment of the focus position of the lens) is automatically performed when the brightness of the image changes. Note following especially when constructing multi-display using multiple projectors such as using the edge blending function by setting the [ADVANCED MENU] menu → [EDGE BLENDING].
 - Position of the projected image may slightly shift due to the amount of focus adjustment.
 - The projected image may slightly undulate during the focus adjustment.
- When this function is set to [ON], driving sound of the focus adjustment motor may be audible when the brightness of the image changes.
- When this function is set to [ON], the setting status of [ACTIVE FOCUS OPTIMIZER] ([ON]) is displayed in the focus adjustment screen.
- The active focus optimizer function operates within the range of focus adjustment. It may not operate properly when used close to the limit value for the focus adjustment.
- The value of the parameter used by the active focus optimizer function is displayed as [FOCUS OFFSET BRIGHT] and [FOCUS OFFSET DARK].
- Parameter for [FOCUS OFFSET BRIGHT] and [FOCUS OFFSET DARK] will be the factory default value set for each type of projection lens in following cases.
 - When the [PROJECTOR SETUP] menu → [LENS] → [ACTIVE FOCUS OPTIMIZER] → [FOCUS OFFSET SETUP] → [SETUP ASSISTANT] is not executed
 - When the [PROJECTOR SETUP] menu → [LENS] → [ACTIVE FOCUS OPTIMIZER] → [FOCUS OFFSET SETUP] → [INITIALIZE] is executed
 - When the <DEFAULT> button is pressed while [FOCUS OFFSET BRIGHT] or [FOCUS OFFSET DARK] is selected
- To reduce the shift in focus caused by the change in the brightness of the image, set [FOCUS OFFSET BRIGHT] and [FOCUS OFFSET DARK] following the guidance in [SETUP ASSISTANT]. For details, refer to “Performing simplified setting using the internal test pattern” (➡ page 149), “Performing simplified setting using the external input image” (➡ page 150).
- The [ACTIVE FOCUS] setting is set to [OFF] when the projector is initialized by one of the following methods.
 - When initialized by selecting the [PROJECTOR SETUP] menu → [INITIALIZE] → [FACTORY RESET]
 - When initialized by setting the [PROJECTOR SETUP] menu → [INITIALIZE] → [USER SETTINGS] → [OTHER USER SETTING] to [INITIALIZE]

Performing simplified setting using the internal test pattern

Set the parameters for [FOCUS OFFSET BRIGHT] and [FOCUS OFFSET DARK] using the test pattern built in the projector following the guidance of [SETUP ASSISTANT].

- 1) Press ▲▼ to select [LENS].
- 2) Press the <ENTER> button.
 - The [LENS] screen is displayed.
- 3) Press ▲▼ to select [ACTIVE FOCUS OPTIMIZER].
- 4) Press the <ENTER> button.
 - The [ACTIVE FOCUS OPTIMIZER] screen is displayed.
- 5) Press ▲▼ to select [FOCUS OFFSET SETUP].
- 6) Press the <ENTER> button.
 - The [FOCUS OFFSET SETUP] screen is displayed.
- 7) Press ▲▼ to select [SETUP ASSISTANT].
- 8) Press the <ENTER> button.
 - If the [PROJECTOR SETUP] menu → [LIGHT OUTPUT] is set to [100.0%], the internal focus test pattern of signal level approximately 50 % is projected, and the [SETUP ASSISTANT] screen (page 1/8) is displayed. Proceed to Step 10).
 - If the [PROJECTOR SETUP] menu → [LIGHT OUTPUT] is set to less than [100.0%], the confirmation screen is displayed. Proceed to Step 9).
- 9) Press ◀▶ to select [NEXT], and press the <ENTER> button.
 - Even if [PROJECTOR SETUP] menu → [LIGHT OUTPUT] is set to less than [100.0%], the projector will operate with the [100.0%] setting while [SETUP ASSISTANT] is executing. Once [SETUP ASSISTANT] is completed, it will return to the original [LIGHT OUTPUT] setting value.
 - After confirming the confirmation message, press ◀▶ to select [NEXT], and press the <ENTER> button. The internal focus test pattern of signal level approximately 50 % is projected, and the [SETUP ASSISTANT] screen (page 1/8) is displayed.
 - To cancel the setting by [SETUP ASSISTANT], press ◀▶ to select [CANCEL], and press the <ENTER> button. [SETUP ASSISTANT] is canceled, and the [FOCUS OFFSET SETUP] screen is displayed.
- 10) Wait until [Waiting time] turns [0s].
 - Wait until the focus is stabilized.
 - When the [Waiting time] turns [0s], the [Please wait...] message disappears, and [NEXT] becomes selectable.
- 11) Press ◀▶ to select [NEXT], and press the <ENTER> button.
 - The [SETUP ASSISTANT] screen (page 2/8) is displayed.
 - It will return to previous screen by selecting [BACK] and pressing the <ENTER> button.
- 12) Press ▲▼◀▶ to select [FOCUS POSITION].
- 13) Press the ◀▶ button to adjust the focus.
- 14) Press ▲▼◀▶ to select [NEXT], and press the <ENTER> button.
 - The [SETUP ASSISTANT] screen (page 3/8) is displayed.
- 15) Press ▲▼◀▶ to select [TEST PATTERN].
- 16) Press ◀▶ to select [INTERNAL].
 - The items will switch each time you press the button.

[INTERNAL]	Uses the internal focus test pattern of signal level approximately 100 % for focus adjustment.
[EXTERNAL]	Select this item when using the input image from an external device for focus adjustment.

- 17) Press ▲▼◀▶ to select [NEXT], and press the <ENTER> button.
 - The [SETUP ASSISTANT] screen (page 4/8) is displayed.

- It will return to previous screen by selecting [BACK] and pressing the <ENTER> button.

18) Wait until [Waiting time] turns [0s].

- Wait until the focus is stabilized.
- When the [Waiting time] turns [0s], the [Please wait...] message disappears, and [NEXT] becomes selectable.

19) Press ◀▶ to select [NEXT], and press the <ENTER> button.

- The [SETUP ASSISTANT] screen (page 5/8) is displayed.
- It will return to previous screen by selecting [BACK] and pressing the <ENTER> button.

20) Press ▲▼◀▶ to select [FOCUS POSITION].

21) Press the ◀▶ button to adjust the focus.

22) Press ▲▼◀▶ to select [NEXT], and press the <ENTER> button.

- The [SETUP ASSISTANT] screen (page 6/8) is displayed.

23) Press ▲▼◀▶ to select [TEST PATTERN].

24) Press ◀▶ to select [INTERNAL].

- The items will switch each time you press the button.

[INTERNAL]	Uses the internal focus test pattern of signal level approximately 0 % for focus adjustment.
[EXTERNAL]	Select this item when using the input image from an external device for focus adjustment.

25) Press ▲▼◀▶ to select [NEXT], and press the <ENTER> button.

- The [SETUP ASSISTANT] screen (page 7/8) is displayed.
- It will return to previous screen by selecting [BACK] and pressing the <ENTER> button.

26) Wait until [Waiting time] turns [0s].

- Wait until the focus is stabilized.
- When the [Waiting time] turns [0s], the [Please wait...] message disappears, and [NEXT] becomes selectable.

27) Press ◀▶ to select [NEXT], and press the <ENTER> button.

- The [SETUP ASSISTANT] screen (page 8/8) is displayed.
- It will return to previous screen by selecting [BACK] and pressing the <ENTER> button.

28) Press ▲▼◀▶ to select [FOCUS POSITION].

29) Press the ◀▶ button to adjust the focus.

30) Press ▲▼◀▶ to select [STORE], and press the <ENTER> button.

- [SETUP ASSISTANT] is completed, and the parameters for [FOCUS OFFSET BRIGHT] and [FOCUS OFFSET DARK] are updated.

Note

- When the parameters for [FOCUS OFFSET BRIGHT] and [FOCUS OFFSET DARK] are set by executing [SETUP ASSISTANT], the [PROJECTOR SETUP] menu → [LENS] → [ACTIVE FOCUS OPTIMIZER] → [ACTIVE FOCUS] will be set to [ON].
- When [FOCUS OFFSET BRIGHT] and [FOCUS OFFSET DARK] are set following the guidance of [SETUP ASSISTANT] with AC 100 V to AC 120 V, use the projector with AC 100 V to AC 120 V. When the power supply is changed to AC 200 V to AC 240 V, reset the settings using [SETUP ASSISTANT].

Performing simplified setting using the external input image

Input any focus adjustment still image from the external device connected to the projector, and set the parameters for [FOCUS OFFSET BRIGHT] and [FOCUS OFFSET DARK] following the guidance of [SETUP ASSISTANT].

1) Switch to the input to display the focus adjustment image.

2) Press ▲▼ to select [LENS].

3) Press the <ENTER> button.

- The [LENS] screen is displayed.

- 4) Press ▲▼ to select [ACTIVE FOCUS OPTIMIZER].
- 5) Press the <ENTER> button.
 - The [ACTIVE FOCUS OPTIMIZER] screen is displayed.
- 6) Press ▲▼ to select [FOCUS OFFSET SETUP].
- 7) Press the <ENTER> button.
 - The [FOCUS OFFSET SETUP] screen is displayed.
- 8) Press ▲▼ to select [SETUP ASSISTANT].
- 9) Press the <ENTER> button.
 - If the [PROJECTOR SETUP] menu → [LIGHT OUTPUT] is set to [100.0%], the internal focus test pattern of signal level approximately 50 % is projected, and the [SETUP ASSISTANT] screen (page 1/8) is displayed. Proceed to Step 11).
 - If the [PROJECTOR SETUP] menu → [LIGHT OUTPUT] is set to less than [100.0%], the confirmation screen is displayed. Proceed to Step 10).
- 10) Press ◀▶ to select [NEXT], and press the <ENTER> button.
 - Even if [PROJECTOR SETUP] menu → [LIGHT OUTPUT] is set to less than [100.0%], the projector will operate with the [100.0%] setting while [SETUP ASSISTANT] is executing. Once [SETUP ASSISTANT] is completed, it will return to the original [LIGHT OUTPUT] setting value.
 - After confirming the confirmation message, press ◀▶ to select [NEXT], and press the <ENTER> button. The internal focus test pattern of signal level approximately 50 % is projected, and the [SETUP ASSISTANT] screen (page 1/8) is displayed.
 - To cancel the setting by [SETUP ASSISTANT], press ◀▶ to select [CANCEL], and press the <ENTER> button. [SETUP ASSISTANT] is canceled, and the [FOCUS OFFSET SETUP] screen is displayed.
- 11) Wait until [Waiting time] turns [0s].
 - Wait until the focus is stabilized.
 - When the [Waiting time] turns [0s], the [Please wait...] message disappears, and [NEXT] becomes selectable.
- 12) Press ◀▶ to select [NEXT], and press the <ENTER> button.
 - The [SETUP ASSISTANT] screen (page 2/8) is displayed.
 - It will return to previous screen by selecting [BACK] and pressing the <ENTER> button.
- 13) Press ▲▼◀▶ to select [FOCUS POSITION].
- 14) Press the ◀▶ button to adjust the focus.
- 15) Press ▲▼◀▶ to select [NEXT], and press the <ENTER> button.
 - The [SETUP ASSISTANT] screen (page 3/8) is displayed.
- 16) Press ▲▼◀▶ to select [TEST PATTERN].
- 17) Press ◀▶ to select [EXTERNAL].
 - The items will switch each time you press the button.

[INTERNAL]	Select this item when using the internal test pattern for focus adjustment.
[EXTERNAL]	Uses the input image from the external device for focus adjustment. If the level of [Brightness of the image] falls below the specified value, [NEXT] cannot be selected. When the bright image with a brightness level indicated in the menu screen (OSD) or greater is input, [NEXT] can be selected.

- 18) Press ▲▼◀▶ to select [NEXT], and press the <ENTER> button.
 - The [SETUP ASSISTANT] screen (page 4/8) is displayed.
 - It will return to previous screen by selecting [BACK] and pressing the <ENTER> button.
- 19) Wait until [Waiting time] turns [0s].
 - Wait until the focus is stabilized.
 - When the [Waiting time] turns [0s], the [Please wait...] message disappears, and [NEXT] becomes selectable.

- 20) Press ◀▶ to select [NEXT], and press the <ENTER> button.
- The [SETUP ASSISTANT] screen (page 5/8) is displayed.
 - It will return to previous screen by selecting [BACK] and pressing the <ENTER> button.
- 21) Press ▲▼◀▶ to select [FOCUS POSITION].
- 22) Press the ◀▶ button to adjust the focus.
- 23) Press ▲▼◀▶ to select [NEXT], and press the <ENTER> button.
- The [SETUP ASSISTANT] screen (page 6/8) is displayed.
- 24) Press ▲▼◀▶ to select [TEST PATTERN].
- 25) Press ◀▶ to select [EXTERNAL].
- The items will switch each time you press the button.

[INTERNAL]	Select this item when using the internal test pattern for focus adjustment.
[EXTERNAL]	Uses the input image from the external device for focus adjustment. If the level of [Brightness of the image] exceeds the specified value, [NEXT] cannot be selected. When the dark image with a brightness level indicated in the menu screen (OSD) or lower is input, [NEXT] can be selected.

- 26) Press ▲▼◀▶ to select [NEXT], and press the <ENTER> button.
- The [SETUP ASSISTANT] screen (page 7/8) is displayed.
 - It will return to previous screen by selecting [BACK] and pressing the <ENTER> button.
- 27) Wait until [Waiting time] turns [0s].
- Wait until the focus is stabilized.
 - When the [Waiting time] turns [0s], the [Please wait...] message disappears, and [NEXT] becomes selectable.
- 28) Press ◀▶ to select [NEXT], and press the <ENTER> button.
- The [SETUP ASSISTANT] screen (page 8/8) is displayed.
 - It will return to previous screen by selecting [BACK] and pressing the <ENTER> button.
- 29) Press ▲▼◀▶ to select [FOCUS POSITION].
- 30) Press the ◀▶ button to adjust the focus.
- 31) Press ▲▼◀▶ to select [STORE], and press the <ENTER> button.
- [SETUP ASSISTANT] is completed, and the parameters for [FOCUS OFFSET BRIGHT] and [FOCUS OFFSET DARK] are updated.

Note

- When the parameters for [FOCUS OFFSET BRIGHT] and [FOCUS OFFSET DARK] are set by executing [SETUP ASSISTANT], the [PROJECTOR SETUP] menu → [LENS] → [ACTIVE FOCUS OPTIMIZER] → [ACTIVE FOCUS] will be set to [ON].
- When [FOCUS OFFSET BRIGHT] and [FOCUS OFFSET DARK] are set following the guidance of [SETUP ASSISTANT] with AC 100 V to AC 120 V, use the projector with AC 100 V to AC 120 V. When the power supply is changed to AC 200 V to AC 240 V, reset the settings using [SETUP ASSISTANT].

Directly setting the parameter

When using the projection lens where the optimal parameter at the time when combined with the projector is already known, [FOCUS OFFSET BRIGHT] and [FOCUS OFFSET DARK] parameters can be individually set without executing [SETUP ASSISTANT].

- 1) Press ▲▼ to select [LENS].
- 2) Press the <ENTER> button.
 - The [LENS] screen is displayed.
- 3) Press ▲▼ to select [ACTIVE FOCUS OPTIMIZER].
- 4) Press the <ENTER> button.
 - The [ACTIVE FOCUS OPTIMIZER] screen is displayed.
- 5) Press ▲▼ to select [FOCUS OFFSET SETUP].

- 6) Press the <ENTER> button.
 - The [FOCUS OFFSET SETUP] screen is displayed.
- 7) Press ▲▼ to select [FOCUS OFFSET BRIGHT] or [FOCUS OFFSET DARK].
- 8) Press ◀▶ to set the parameter.
 - Set the parameter in the range from [-99] to [+99].

Displaying the test pattern

The internal focus test pattern used with [SETUP ASSISTANT] is displayed.

- 1) Press ▲▼ to select [LENS].
- 2) Press the <ENTER> button.
 - The [LENS] screen is displayed.
- 3) Press ▲▼ to select [ACTIVE FOCUS OPTIMIZER].
- 4) Press the <ENTER> button.
 - The [ACTIVE FOCUS OPTIMIZER] screen is displayed.
- 5) Press ▲▼ to select [FOCUS OFFSET SETUP].
- 6) Press the <ENTER> button.
 - The [FOCUS OFFSET SETUP] screen is displayed.
- 7) Press ▲▼ to select [TEST PATTERN].
- 8) Press ◀▶ to select an item.
 - The items will switch each time you press the button.

[OFF]	Does not display the test pattern.
[0%]	Displays the focus test pattern of signal level approximately 0 %.
[50%]	Displays the focus test pattern of signal level approximately 50 %.
[100%]	Displays the focus test pattern of signal level approximately 100 %.

Initializing the parameter

Return all the parameters for [FOCUS OFFSET BRIGHT] and [FOCUS OFFSET DARK] saved by each lens type in the [PROJECTOR SETUP] menu → [LENS] → [LENS INFORMATION SETTING] → [LENS TYPE] to factory default settings.

- 1) Press ▲▼ to select [LENS].
- 2) Press the <ENTER> button.
 - The [LENS] screen is displayed.
- 3) Press ▲▼ to select [ACTIVE FOCUS OPTIMIZER].
- 4) Press the <ENTER> button.
 - The [ACTIVE FOCUS OPTIMIZER] screen is displayed.
- 5) Press ▲▼ to select [FOCUS OFFSET SETUP].
- 6) Press the <ENTER> button.
 - The [FOCUS OFFSET SETUP] screen is displayed.
- 7) Press ▲▼ to select [INITIALIZE], and press the <ENTER> button.
 - The confirmation screen is displayed.
- 8) Press ◀▶ to select [OK], and press the <ENTER> button.

[LENS CALIBRATION]

Detect the lens adjustment limit value, and perform the calibration in the adjustment range. Execute the lens calibration after attaching the projection lens.

- 1) Press ▲▼ to select [LENS].
- 2) Press the <ENTER> button.
 - The [LENS] screen is displayed.
- 3) Press ▲▼ to select [LENS CALIBRATION].
- 4) Press the <ENTER> button.
 - The [LENS CALIBRATION] screen is displayed.
- 5) Press ▲▼ to select an item.

[SHIFT/FOCUS/ZOOM]	Executes the calibrations for the lens shift, focus, and zoom. After completing the calibration in the adjustment range, the projection lens will move to the home position.
[SHIFT/FOCUS]	Executes the calibrations for the lens shift and focus. After completing the calibration in the adjustment range, the projection lens will move to the home position.
[ZOOM]	Executes the calibration of the zoom adjustment range.

- 6) Press the <ENTER> button.
 - The confirmation screen is displayed.
- 7) Press ◀▶ to select [OK], and press the <ENTER> button.
 - The lens calibration is started.
 - To cancel, select [CANCEL].

Note

- [PROGRESS] is displayed in the menu during lens calibration. The operation cannot be canceled during calibration.
- [INCOMPLETE] is displayed when the lens calibration is not performed correctly.
- The origin position of the lens mounter and the home position of the projection lens are automatically updated when the lens shift calibration is performed. The home position is an origin position of the lens shift (vertical position and horizontal position of the lens) based on the calibration result. It does not match with the optical image center position.

[OPERATION SETTING]

Set the operation method of the projector.

The settings are reflected when “Initial setting (operation setting)” (➔ page 63) in the [INITIAL SETTING] screen is already set.

If you change the settings while using the projector, the duration until the brightness decreases to half may shorten or the brightness may decrease.

Setting [OPERATING MODE]

- 1) Press ▲▼ to select [OPERATION SETTING].
- 2) Press the <ENTER> button.
 - The [OPERATION SETTING] screen is displayed.
- 3) Press ▲▼ to select [OPERATING MODE].
- 4) Press ◀▶ to switch the item.
 - The items will switch each time you press the button.

[NORMAL]	Set this item when high luminance is required. The estimated runtime is approximately 20 000 hours or more*1.
[ECO]	The brightness will decrease compared to [NORMAL], but set this item to prioritize the life of the light source. The estimated runtime is approximately 24 000 hours or more*1.

[USER1]	Set [MAX LIGHT OUTPUT LEVEL] and [LIGHT OUTPUT] individually.
[USER2]	
[USER3]	

*1 Estimated runtime is the time until the brightness decreases to approximately half of the time of delivery when the projector is used with the [PICTURE] menu → [DYNAMIC CONTRAST] set to [3] and under environment of 0.15 mg/m³ dust. The value of runtime is just an estimate, and is not the warranty period.

- 5) Press ▲▼ to select [APPLY].
- 6) Press the <ENTER> button.
 - The confirmation screen is displayed.
- 7) Press ◀▶ to select [OK], and press the <ENTER> button.

Note

- If the consolidated runtime of the projector exceeds 20 000 hours, replacement of the components inside the projector may be required. The consolidated runtime can be confirmed in the [STATUS] screen. Refer to the [PROJECTOR SETUP] menu → [STATUS] for details.

Setting [MAX LIGHT OUTPUT LEVEL]

Adjust the maximum level to correct screen brightness according to the changes in brightness of the light source.

- 1) Press ▲▼ to select [OPERATION SETTING].
- 2) Press the <ENTER> button.
 - The [OPERATION SETTING] screen is displayed.
- 3) Press ▲▼ to select [MAX LIGHT OUTPUT LEVEL].
- 4) Press ◀▶ to adjust.

Operation	Adjustment	Range of adjustment
Press ▶.	Increases the maximum level of brightness correction.	8.0 % - 100.0 %
Press ◀.	Decreases the maximum level of brightness correction.	

- 5) Press ▲▼ to select [APPLY].
- 6) Press the <ENTER> button.
 - The confirmation screen is displayed.
- 7) Press ◀▶ to select [OK], and press the <ENTER> button.

Note

- When [OPERATING MODE] is set to [NORMAL] or [ECO], [MAX LIGHT OUTPUT LEVEL] cannot be adjusted.
- The brightness is corrected using this setting when the [PROJECTOR SETUP] menu → [BRIGHTNESS CONTROL] → [BRIGHTNESS CONTROL SETUP] → [CONSTANT MODE] is set to [AUTO] or [PC].

Setting [LIGHT OUTPUT]

Adjust the brightness of light source.

The [LIGHT OUTPUT] setting is synchronized with the [PROJECTOR SETUP] menu → [LIGHT OUTPUT]. The most recent setting is reflected in both items.

- 1) Press ▲▼ to select [OPERATION SETTING].
- 2) Press the <ENTER> button.
 - The [OPERATION SETTING] screen is displayed.
- 3) Press ▲▼ to select [LIGHT OUTPUT].
- 4) Press ◀▶ to adjust.

Operation	Adjustment		Range of adjustment
	Brightness	Runtime	
Press ►.	The screen becomes brighter.	The runtime becomes shorter.	8.0 % - 100.0 %*1
Press ◀.	The screen becomes darker.	The runtime becomes longer.	

*1 The upper limit of the adjustment range is the value set in the [PROJECTOR SETUP] menu → [OPERATION SETTING] → [MAX LIGHT OUTPUT LEVEL].

- 5) Press ▲▼ to select [APPLY].
- 6) Press the <ENTER> button.
 - The confirmation screen is displayed.
- 7) Press ◀▶ to select [OK], and press the <ENTER> button.

Note

- [LIGHT OUTPUT] can be adjusted individually for each setting item of [OPERATING MODE].
- The uniformity of the brightness between multiple displays can be maintained by adjusting [LIGHT OUTPUT] for each projector when structuring a multi-display screen by combining the projected images from multiple projectors.

Relationship between brightness and runtime

The projector can be operated with arbitrary brightness and runtime by combining the settings of [MAX LIGHT OUTPUT LEVEL], [LIGHT OUTPUT], and [CONSTANT MODE] in [BRIGHTNESS CONTROL SETUP]. The relationship between the [LIGHT OUTPUT] setting, brightness, and the estimated runtime is as follows. Make the setting depending on the desired brightness of the projected image and runtime. The values of the brightness and the runtime are just an estimate, and the graph indicating the relationship is just an example. Also, these do not indicate the warranty period.

■ When [CONSTANT MODE] is set to [OFF]

[LIGHT OUTPUT] (%)	Brightness (lm)	Estimated runtime*1 (hours)
100.0	50 000	27 000
80.0	40 000	39 500
70.0	35 000	47 500
60.0	30 000	56 500
50.0	25 000	66 500

*1 Estimated runtime is the time until the brightness decreases to approximately half of the time of delivery when the projector is used with the [PICTURE] menu → [DYNAMIC CONTRAST] set to [3] and under environment of 0.15 mg/m³ dust.

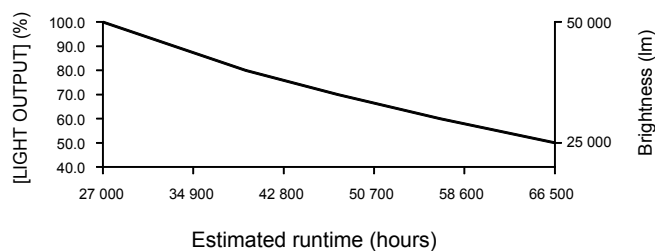

■ When [CONSTANT MODE] is set to [AUTO] or [PC]

[LIGHT OUTPUT] (%)	Brightness (lm)	Estimated runtime*1 (hours)
80.0	40 000	9 000
70.0	35 000	17 500
60.0	30 000	29 000
50.0	25 000	43 000
40.0	20 000	62 000
30.0	15 000	87 500

*1 Estimated runtime is the time the brightness is maintained constant when the projector is used with the [PICTURE] menu → [DYNAMIC CONTRAST] set to [3] and under environment of 0.15 mg/m³ dust. The brightness will gradually decrease after exceeding this time.

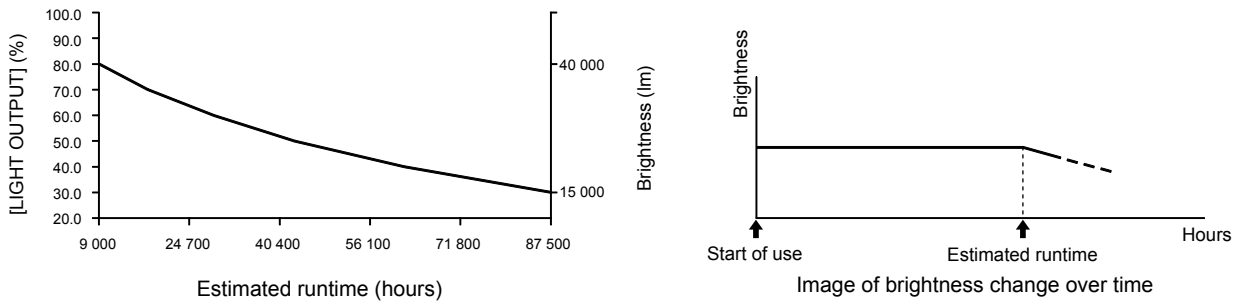

Note

- Under influence of characteristics of each light source, conditions of use, installation environment, etc., the runtime may be shorter than the estimation.
- If the consolidated runtime of the projector exceeds 20 000 hours, replacement of the components inside the projector may be required. The consolidated runtime can be confirmed in the [STATUS] screen. Refer to the [PROJECTOR SETUP] menu → [STATUS] for details.

[LIGHT OUTPUT]

Adjust the brightness of light source.

The setting is reflected when it is already set with “Initial setting (operation setting)” (➔ page 63) in the [INITIAL SETTING] screen or with the [PROJECTOR SETUP] menu → [OPERATION SETTING]. The [LIGHT OUTPUT] setting is synchronized with the [PROJECTOR SETUP] menu → [OPERATION SETTING] → [LIGHT OUTPUT]. The most recent setting is reflected in both items.

- 1) Press ▲▼ to select [LIGHT OUTPUT].
- 2) Press ◀▶ to adjust.

Operation	Adjustment		Range of adjustment
	Brightness	Runtime	
Press ▶.	The screen becomes brighter.	The runtime becomes shorter.	8.0 % - 100.0 %*1
Press ◀.	The screen becomes darker.	The runtime becomes longer.	

*1 The upper limit of the adjustment range is the value set in the [PROJECTOR SETUP] menu → [OPERATION SETTING] → [MAX LIGHT OUTPUT LEVEL].

Note

- [LIGHT OUTPUT] can be adjusted individually for each setting item of [OPERATING MODE].
- The uniformity of the brightness between multiple displays can be maintained by adjusting [LIGHT OUTPUT] for each projector when structuring a multi-display screen by combining the projected images from multiple projectors.

[BRIGHTNESS CONTROL]

The projector is equipped with a brightness sensor to measure brightness and color of the light source, and corrects brightness and white balance of the projected image according to the changes in brightness and color of the light source.

By using this function, in such a condition that multiple screens are configured using projected images of multiple projectors, you can reduce changes in overall brightness and white balance of the multiple screens due to aging of the light source and suppress variation in brightness and white balance to preserve uniformity.

Setting [BRIGHTNESS CONTROL SETUP]

Set the operation of the brightness control function.

- 1) Press ▲▼ to select [BRIGHTNESS CONTROL].
- 2) Press the <ENTER> button.
 - The [BRIGHTNESS CONTROL] screen is displayed.
- 3) Press ▲▼ to select [BRIGHTNESS CONTROL SETUP].
- 4) Press the <ENTER> button.
 - The [BRIGHTNESS CONTROL SETUP] screen is displayed.
- 5) Press ▲▼ to select [CONSTANT MODE].
- 6) Press ◀▶ to switch the item.
 - The items will switch each time you press the button.

[OFF]	Does not correct the brightness of the screen by the brightness sensor.
[AUTO]	Corrects the brightness of the screen by the brightness sensor. When the brightness of light source or white balance changes, the brightness of the projected image is automatically corrected.
[PC]	Synchronizes nine or more projectors using a computer and "Multi Monitoring & Control Software"*1.

*1 "Multi Monitoring & Control Software" can be downloaded from the Panasonic website (<https://panasonic.net/cns/projector/>).

- Proceed to Step 9) when [PC] is selected.

- 7) Press ▲▼ to select [LINK].
- 8) Press ◀▶ to switch the item.
 - The items will switch each time you press the button.

[OFF]	Performs corrections by the brightness sensor on a single projector without synchronizing with the other projectors. The duration that the constant brightness is kept will become longer by setting the value of [LIGHT OUTPUT] smaller.
[GROUP A] [GROUP B] [GROUP C] [GROUP D]	Performs correction by the brightness sensor in multiple projectors in synchronization. Up to four groups (A to D) can be set within the same subnet by using the network function. You can register and synchronize up to eight projectors in one group.

- 9) Press ▲▼ to select [APPLY].
- 10) Press the <ENTER> button.
 - When [CONSTANT MODE] in [BRIGHTNESS CONTROL SETUP] is set to anything other than [OFF], the brightness and white balance of light source at the time when the <ENTER> button is pressed is recorded as the standard brightness and white balance.
 - If the <ENTER> button is pressed when [LINK] is set from [GROUP A] to [GROUP D], the group name is displayed on the screens of projectors that have been set in the same group.



Note

- When [CONSTANT MODE] is set to [AUTO] or [PC], keep the shutter function disabled (shutter: opened) for at least two minutes, since the brightness sensor calibration is performed after the [BRIGHTNESS CONTROL SETUP] setting has been completed.

- When the projector operates with [CONSTANT MODE] set to [AUTO] or [PC], the brightness and color of the light source do not stabilize for approximately eight minutes after the light source is turned on. Therefore, the brightness and color of the light source will be automatically measured after approximately eight minutes have elapsed after the light source is turned on.
- When the projector operates with [CONSTANT MODE] set to [AUTO], and [LINK] set to [OFF], the brightness will be corrected until it reaches the value set in [MAX LIGHT OUTPUT LEVEL].
- The variation in brightness may increase due to dust accumulating on the lens, screen, or inside the projector, depending on the installation environment of the projector.
- When the variation in brightness has increased due to aging of the light source, or when you replaced the light source, readjust the brightness control.

Displaying [BRIGHTNESS CONTROL STATUS]

Display the brightness control status.

- 1) Press **▲▼** to select [BRIGHTNESS CONTROL].
- 2) Press the **<ENTER>** button.
 - The [BRIGHTNESS CONTROL] screen is displayed.
- 3) Press **▲▼** to select [BRIGHTNESS CONTROL STATUS].
- 4) Press the **<ENTER>** button.
 - The [BRIGHTNESS CONTROL STATUS] screen is displayed.

[BRIGHTNESS CONTROL STATUS] screen display example

When [CONSTANT MODE] is set to [OFF]

The screen shows the status that the brightness control is disabled.

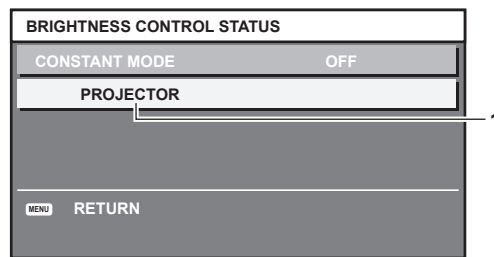

When [CONSTANT MODE] is set to [AUTO], and [LINK] is set to [OFF]

The screen shows the status of the brightness control in one projector.

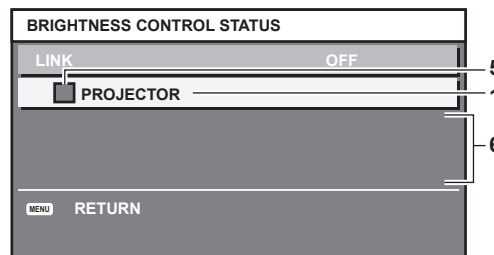

When [CONSTANT MODE] is set to [AUTO], and [LINK] is set to [GROUP A] through [GROUP D]

The screen shows the status of the brightness control of synchronized projectors (up to eight units), including the projector being controlled through the on-screen menu.

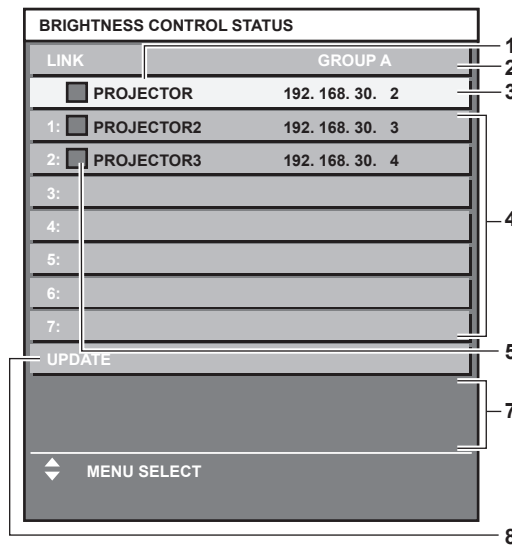

When [CONSTANT MODE] is set to [PC]

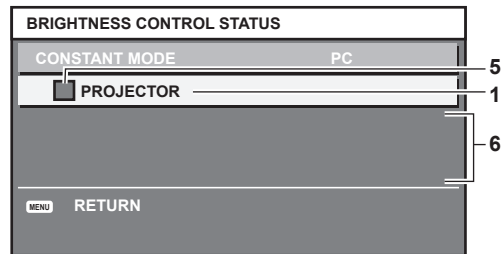

- 1 Display the name of the projector.
- 2 Display the synchronized group.
- 3 Display the IP address of the projector.
- 4 Display the names and IP addresses of projectors in same group detected over the network.
- 5 Display the status by color.
Green: There is an allowance for brightness correction.
Yellow: There is little allowance for brightness correction.
Red: There is a brightness control error.
- 6 Display error detailed messages.
- 7 Display error messages.
When the message [Failed to apply BRIGHTNESS CONTROL to some projectors.] appears, it means that synchronization with the projector displayed in red has failed.
Press ▲▼ to select the projector displayed in red, and press the <ENTER> button to display the error details.
- 8 Update to the latest status information.

■ Error details

Error message	Measures to take
[Exceed maximum number of projectors.]	<ul style="list-style-type: none"> • Limit the number of projectors in one group to eight. • To synchronize nine or more projectors, use a computer and “Multi Monitoring & Control Software”^{*1}.
[Please check the COMMAND CONTROL setting.]	<ul style="list-style-type: none"> • Set [NETWORK CONTROL] → [COMMAND CONTROL] to [ON] for the projector in error. • Set [NETWORK CONTROL] → [COMMAND PORT] of all linked projectors to the same value.
[Please check the USER NAME and PASSWORD in the COMMAND CONTROL setting.]	<ul style="list-style-type: none"> • Assign same character strings for [User name] and [Password] as the web control administrator rights to all linked projectors.
[Cannot apply BRIGHTNESS CONTROL. Please check projector status.]	<ul style="list-style-type: none"> • The projector is in standby. Switch on the power.
[Brightness Sensor Error]	<ul style="list-style-type: none"> • There is a problem with the brightness sensor. If problems persist even after switching on the power, consult your dealer.

^{*1} “Multi Monitoring & Control Software” can be downloaded from the Panasonic website (<https://panasonic.net/cns/projector/>).

Note

- If the synchronized projectors are not displayed in the list, check the following:
 - Are there devices with the same IP address on the network?
 - Are the LAN cables connected correctly? (➔ page 198)
 - Are the subnets of the projectors the same?
 - Are the same [LINK] settings applied to a group?
- Refer to [PROJECTOR NAME] (➔ page 193) or “[Network config] page” (➔ page 212) on how to change the projector name.

Brightness control adjustment procedure example

The steps exemplify an adjustment to link the brightness of eight projectors connected in a network.

- 1) **Connect all projectors to the hub using LAN cables.** (➔ page 198)
- 2) **Switch on all projectors and start projection.**
- 3) **Set [CONSTANT MODE] of [BRIGHTNESS CONTROL SETUP] to [OFF], and select [APPLY], and then press the <ENTER> button.**
- 4) **Set [OPERATING MODE] of each projector to the same setting.** (➔ page 154)
- 5) **Set [SUBNET MASK] and [IP ADDRESS] in each projector.**
 - To be able to communicate over the network, set the same value in [SUBNET MASK] for all projectors and set a different value in [IP ADDRESS] for each projector.
- 6) **Wait for at least eight minutes after projection has started until the light source brightness becomes steady.**
- 7) **Set all items in the [PICTURE] menu of all projectors to the same values.**
- 8) **Adjust [COLOR MATCHING] to match colors.**
- 9) **Display the internal test pattern “All white” in all projectors.**
- 10) **Set [LIGHT OUTPUT] of all projectors to 100 % or the maximum value that can be set.**
 - Depending on the [OPERATING MODE] settings, [LIGHT OUTPUT] may not be able to be set to 100 %.
- 11) **Set [LIGHT OUTPUT] of the projector with the least brightness to 90 % or 10 % lower than the maximum value that can be set.**
- 12) **Adjust [LIGHT OUTPUT] of each projector.**
 - Adjust [LIGHT OUTPUT] of all the other projectors so that the brightness will be the same as the projector with the least brightness.
- 13) **Set [CONSTANT MODE] of [BRIGHTNESS CONTROL SETUP] to [AUTO], and [LINK] to [GROUP A] in all projectors.**
- 14) **Select [APPLY] of [BRIGHTNESS CONTROL SETUP] and press the <ENTER> button in all projectors.**
 - Brightness control starts.

Note

- Brightness is automatically corrected whenever the light source lights up by switching on/off the projector, etc.
- When the variation in brightness has increased due to aging of the light source, or when you replaced the light source, readjust the brightness control.

[NO SIGNAL SETTING]

Set the operation of the function when there is no input signal.

[BACKUP INPUT SETTING]

Set the backup function that switches the signal to the backup input signal as seamless as possible when input signal is disrupted.

- 1) **Press ▲▼ to select [NO SIGNAL SETTING].**
- 2) **Press the <ENTER> button.**
 - The [NO SIGNAL SETTING] screen is displayed.

- 3) Press ▲▼ to select [BACKUP INPUT SETTING].
- 4) Press the <ENTER> button.
 - The [BACKUP INPUT SETTING] screen is displayed.
- 5) Press ▲▼ to select [BACKUP INPUT MODE].
- 6) Press the <ENTER> button.
 - The [BACKUP INPUT MODE] screen is displayed.
- 7) Press ▲▼ to select the combination of the input and press the <ENTER> button.

Primary input	Secondary input	Number of signals constructing one screen	Details
[OFF]		—	Disables the backup function.
[HDMI1 [SLOT1]]*1	[HDMI2 [SLOT1]]*1	1	Enables the backup function.
[HDMI3 [SLOT2]]*2	[HDMI4 [SLOT2]]*2		
[DVI-D1 [SLOT1]]*1	[DVI-D2 [SLOT1]]*1		
[DVI-D3 [SLOT2]]*2	[DVI-D4 [SLOT2]]*2		
[DisplayPort1 [SLOT1]]*3	[DisplayPort3 [SLOT2]]*3		
[SDI1 [SLOT1]]*4	[SDI3 [SLOT1]]*4	2	
[SDI1 [SLOT2]]*5	[SDI3 [SLOT2]]*5		
[SDI1-3 [SLOT1]]*6	[SDI1-3 [SLOT2]]*6		
[SDI1-2-3-4 [SLOT1]]*6	[SDI1-2-3-4 [SLOT2]]*6	4	

- *1 This is displayed when the optional Interface Board equipped with corresponding input is installed in <SLOT 1>.
- *2 This is displayed when the optional Interface Board equipped with corresponding input is installed in <SLOT 2>.
- *3 This is displayed when the optional Interface Board for DisplayPort 2 input (Model No.: ET-MDNDP10) is installed in <SLOT 1> and <SLOT 2>.
- *4 This is displayed when the Interface Board for 12G-SDI (Model No.: ET-MDN12G10) is installed in <SLOT 1>.
- *5 This is displayed when the Interface Board for 12G-SDI (Model No.: ET-MDN12G10) is installed in <SLOT 2>.
- *6 This is displayed when the Interface Board for 12G-SDI (Model No.: ET-MDN12G10) is installed in <SLOT 1> and <SLOT 2>.

- 8) Press the <MENU> button.
 - The [BACKUP INPUT SETTING] screen is displayed.
- 9) Press ▲▼ to select [AUTOMATIC SWITCHING].
 - When [BACKUP INPUT MODE] is set to [OFF], [AUTOMATIC SWITCHING] cannot be selected.
- 10) Press ◀▶ to switch the item.
 - The items will switch each time you press the button.

[ENABLE]	Switches to the secondary input (primary input) automatically when the input signal for primary input (secondary input) is disrupted.
[DISABLE]	Disables the automatic input switching function.

Note

- The [BACKUP INPUT SETTING] setting item is common with the following menu item.
 - The [DISPLAY OPTION] menu → [BACKUP INPUT SETTING]
- The backup function is enabled when [BACKUP INPUT MODE] is set to anything other than [OFF] and same signal is input to the primary input and the secondary input.
- To switch to the backup input signal using the backup function, make sure that the following three conditions are satisfied to be ready to use the function.
 - Set [BACKUP INPUT MODE] to anything other than [OFF].
 - Input the same signal to the primary and secondary inputs.
 - Display the image of the primary input or secondary input.
- If the input is switched to other than the primary or secondary input while the backup function is ready for use, the state of readiness to use the backup function is canceled. To switch to the backup input signal using the backup function again, switch to the primary input or secondary input.
- When [BACKUP INPUT MODE] is set to anything other than [OFF], the combination of that input is displayed in [PRIMARY INPUT] and [SECONDARY INPUT] of the [BACKUP INPUT SETTING] screen.
- [BACKUP INPUT STATUS] is displayed in the input guide (➔ page 135) and the [STATUS] screen (➔ pages 81, 173) when [BACKUP INPUT MODE] is set to anything other than [OFF].
 - When the signal can be switched to the backup input signal using the backup function, [ACTIVE] is displayed in [BACKUP INPUT STATUS].
 - When it is not possible, [INACTIVE] is displayed instead.
 - The secondary input will be the backup input when [BACKUP INPUT STATUS] is displaying [ACTIVE] while the image from the primary input is displayed.

The primary input will be the backup input when [BACKUP INPUT STATUS] is displaying [ACTIVE] while the image from the secondary input is displayed.

- When [BACKUP INPUT MODE] is set to anything other than [OFF], the input is switched seamlessly if the input is switched between the primary input and the secondary input while it is possible to switch to the backup input signal.
- When [AUTOMATIC SWITCHING] is set to [ENABLE], and [BACKUP INPUT STATUS] shows [ACTIVE], the signal is switched to the backup input if a disruption occurs in the input signal.
- When [AUTOMATIC SWITCHING] is set to [ENABLE], the indication in [BACKUP INPUT STATUS] will change to [INACTIVE] if the input signal is disrupted and automatically switched to the backup input. In this case, it is not possible to switch to the backup input signal until the original input signal is restored. If the input has switched to the backup input automatically, it is possible to switch to the backup input signal when the original signal has been restored. In this case, the current input is maintained.
- [BACKUP INPUT MODE] in which the input equipped on the optional Interface Board installed in the slot is included as the primary input or the secondary input cannot be selected when the [DISPLAY OPTION] menu → [SIMUL INPUT SETTING] → [AUTO(x2-speed)] is set.
- When [SDI LINK] for the primary input and the secondary input is set to [AUTO], [BACKUP INPUT MODE] for that combination cannot be selected. When [SDI LINK] for the primary input and the secondary input do not match, [BACKUP INPUT MODE] for that combination cannot be selected.

Match the setting in accordance with the signal and then input the same signal in the primary input and the secondary input.

– The [DISPLAY OPTION] menu → [SLOT IN] → [SDI LINK]

- When [HDMI LINK SETTINGS] or [DVI-D LINK SETTINGS] for the primary input and the secondary input is set to [AUTO], [BACKUP INPUT MODE] for that combination cannot be selected. When [HDMI LINK SETTINGS] or [DVI-D LINK SETTINGS] for the primary input and the secondary input do not match, [BACKUP INPUT MODE] for that combination cannot be selected.

Match the setting in accordance with the signal and then input the same signal in the primary input and the secondary input.

– The [DISPLAY OPTION] menu → [SLOT IN] → [HDMI LINK]

– The [DISPLAY OPTION] menu → [SLOT IN] → [DVI-D LINK]

- The primary input setting values are applied to image adjustment values such as the [PICTURE] menu → [PICTURE MODE], [GAMMA], and [COLOR TEMPERATURE].

[SECONDARY INPUT]

Set the secondary input switching function that will automatically switch to the specified input when the input signal of projecting image is discontinued.

- 1) Press ▲▼ to select [NO SIGNAL SETTING].
- 2) Press the <ENTER> button.
 - The [NO SIGNAL SETTING] screen is displayed.
- 3) Press ▲▼ to select [SECONDARY INPUT].
- 4) Press the <ENTER> button.
 - The [SECONDARY INPUT] screen is displayed.
- 5) Press ▲▼ to select the input to be specified as the switching destination, and press the <ENTER> button.

[OFF]	Disables the secondary input switching function.
[HDMI1 [SLOT1]]*1	Sets the secondary input to HDMI1 of the Interface Board.
[HDMI2 [SLOT1]]*1	Sets the secondary input to HDMI2 of the Interface Board.
[HDMI3 [SLOT2]]*2	Sets the secondary input to HDMI3 of the Interface Board.
[HDMI4 [SLOT2]]*2	Sets the secondary input to HDMI4 of the Interface Board.
[DVI-D1 [SLOT1]]*1	Sets the secondary input to DVI-D1 of the Interface Board.
[DVI-D2 [SLOT1]]*1	Sets the secondary input to DVI-D2 of the Interface Board.
[DVI-D3 [SLOT2]]*2	Sets the secondary input to DVI-D3 of the Interface Board.
[DVI-D4 [SLOT2]]*2	Sets the secondary input to DVI-D4 of the Interface Board.
[DisplayPort1 [SLOT1]]*1	Sets the secondary input to DisplayPort1 of the Interface Board.
[DisplayPort2 [SLOT1]]*1	Sets the secondary input to DisplayPort2 of the Interface Board.
[DisplayPort3 [SLOT2]]*2	Sets the secondary input to DisplayPort3 of the Interface Board.
[DisplayPort4 [SLOT2]]*2	Sets the secondary input to DisplayPort4 of the Interface Board.
[SDI1 [SLOT1]]*1	Sets the secondary input to SDI1 of the Interface Board.
[SDI2 [SLOT1]]*1	Sets the secondary input to SDI2 of the Interface Board.
[SDI3 [SLOT1]]*3	Sets the secondary input to SDI3 of the Interface Board.
[SDI4 [SLOT1]]*3	Sets the secondary input to SDI4 of the Interface Board.
[SDI1 [SLOT2]]*3	Sets the secondary input to SDI1 of the Interface Board.
[SDI2 [SLOT2]]*3	Sets the secondary input to SDI2 of the Interface Board.
[SDI3 [SLOT2]]*2	Sets the secondary input to SDI3 of the Interface Board.
[SDI4 [SLOT2]]*2	Sets the secondary input to SDI4 of the Interface Board.
[DIGITAL LINK]	Sets the secondary input to DIGITAL LINK*4.

*1 This can be selected when the optional Interface Board equipped with corresponding input is installed in <SLOT 1>.

- *2 This can be selected when the optional Interface Board equipped with corresponding input is installed in <SLOT 2>.
- *3 This is displayed when the Interface Board for 12G-SDI (Model No.: ET-MDN12G10) is installed in <SLOT 1> or <SLOT 2>.
- *4 Individual input on the twisted-pair-cable transmitter or the DIGITAL LINK output supported device cannot be specified.

Note

- When the [PROJECTOR SETUP] menu → [NO SIGNAL SETTING] → [BACKUP INPUT SETTING] → [BACKUP INPUT MODE] is set to anything other than [OFF], the secondary input switching function will not operate even when [SECONDARY INPUT] is set to anything other than [OFF]. The backup input switching function is prioritized.
- [SECONDARY INPUT] cannot be selected when the optional Interface Board is not installed in the slot.

[BACK COLOR]

Set the display of the screen when a signal is not input.

- 1) Press ▲▼ to select [NO SIGNAL SETTING].
- 2) Press the <ENTER> button.
 - The [NO SIGNAL SETTING] screen is displayed.
- 3) Press ▲▼ to select [BACK COLOR].
- 4) Press ◀▶ to switch the item.
 - The items will switch each time you press the button.

[BLUE]	Displays blue in the entire screen.
[BLACK]	Displays black in the entire screen.
[DEFAULT LOGO]	Displays the Panasonic logo in the screen.
[USER LOGO]	Displays the image registered by the user in the screen.

Note

- The [BACK COLOR] setting item is common with the following menu item.
 - The [DISPLAY OPTION] menu → [BACK COLOR]
- To create and register the [USER LOGO] image, use "Logo Transfer Software". The software can be downloaded from the Panasonic website (<https://panasonic.net/cns/projector/>).

[NO SIGNAL LIGHTS-OUT]

This is a function to automatically turn off the light source of the projector when there is no input signal for specific period. The time until the light source is turned off can be set.

- 1) Press ▲▼ to select [NO SIGNAL SETTING].
- 2) Press the <ENTER> button.
 - The [NO SIGNAL SETTING] screen is displayed.
- 3) Press ▲▼ to select [NO SIGNAL LIGHTS-OUT].
- 4) Press ◀▶ to switch the item.
 - The items will switch each time you press the button.

[DISABLE]	Disables the no signal lights-out function.
[10SEC.] - [5MIN.]	Turns off the light source when there is no input signal for the preset period. Select [10SEC.], [20SEC.], [30SEC.], [1MIN.], [2MIN.], [3MIN.], or [5MIN.].

Note

- The fan will rotate to cool the projector while the no signal lights-out function is operating and the light source is turned off. Also, the power indicator <ON (G)/STANDBY (R)> blinks slowly in green.
- When [NO SIGNAL LIGHTS-OUT] is set to anything other than [DISABLE], the following are the conditions to turn the light source back on again from the condition that the light source has turned off by this function.
 - When the signal is input
 - When on-screen display such as menu screen (OSD) or input guide, a test pattern, or a warning message is displayed
 - When the power on <|> button is pressed
 - When the operation to disable the shutter function (shutter: opened) is performed, such as pressing the <SHUTTER> button
 - When the operating environment temperature is around 0 °C (32 °F) and the light source is forced to turn on due to warm-up
- The no signal lights-out function is disabled in following cases.
 - When [BACK COLOR] is set to [DEFAULT LOGO] or [USER LOGO], and the Panasonic logo or the image registered by the user is displayed in the projected image

[NO SIGNAL SHUT-OFF]

A function that automatically switches the power source of the projector to standby if there is no input signal for a certain period of time. The time before switching to standby can be set.

- 1) Press ▲▼ to select [NO SIGNAL SETTING].
- 2) Press the <ENTER> button.
 - The [NO SIGNAL SETTING] screen is displayed.
- 3) Press ▲▼ to select [NO SIGNAL SHUT-OFF].
- 4) Press ◀▶ to switch the item.
 - The items will switch each time you press the button.

[DISABLE]	Disables the No signal shut-off function.
[10MIN.] - [90MIN.]	Sets the time in increments of 10 minutes.

[INITIAL STARTUP]

Set the startup method when the <MAIN POWER> switch is set to <ON>.

- 1) Press ▲▼ to select [INITIAL STARTUP].
- 2) Press ◀▶ to switch the item.
 - The items will switch each time you press the button.

[LAST MEMORY]	Starts up the projector in the condition before the <MAIN POWER> switch is set to <OFF>.
[STANDBY]	Starts up the projector in standby.
[ON]	Starts projecting immediately.

[STARTUP INPUT SELECT]

Set the input when the projector is switched on to start projection.

- 1) Press ▲▼ to select [STARTUP INPUT SELECT].
- 2) Press the <ENTER> button.
 - The [STARTUP INPUT SELECT] screen is displayed.
- 3) Press ▲▼◀▶ to select the input, and press the <ENTER> button.

[HDMI1 [SLOT1]]*1	Sets the input to HDMI1 of the Interface Board.
[HDMI2 [SLOT1]]*1	Sets the input to HDMI2 of the Interface Board.
[HDMI3 [SLOT2]]*2	Sets the input to HDMI3 of the Interface Board.
[HDMI4 [SLOT2]]*2	Sets the input to HDMI4 of the Interface Board.
[DVI-D1 [SLOT1]]*1	Sets the input to DVI-D1 of the Interface Board.
[DVI-D2 [SLOT1]]*1	Sets the input to DVI-D2 of the Interface Board.
[DVI-D3 [SLOT2]]*2	Sets the input to DVI-D3 of the Interface Board.
[DVI-D4 [SLOT2]]*2	Sets the input to DVI-D4 of the Interface Board.
[DisplayPort1 [SLOT1]]*1	Sets the input to DisplayPort1 of the Interface Board.
[DisplayPort2 [SLOT1]]*1	Sets the input to DisplayPort2 of the Interface Board.
[DisplayPort3 [SLOT2]]*2	Sets the input to DisplayPort3 of the Interface Board.
[DisplayPort4 [SLOT2]]*2	Sets the input to DisplayPort4 of the Interface Board.
[SDI1 [SLOT1]]*1	Sets the input to SDI1 of the Interface Board.
[SDI2 [SLOT1]]*1	Sets the input to SDI2 of the Interface Board.
[SDI3 [SLOT1]]*3	Sets the input to SDI3 of the Interface Board.
[SDI4 [SLOT1]]*3	Sets the input to SDI4 of the Interface Board.
[SDI1 [SLOT2]]*3	Sets the input to SDI1 of the Interface Board.
[SDI2 [SLOT2]]*3	Sets the input to SDI2 of the Interface Board.
[SDI3 [SLOT2]]*2	Sets the input to SDI3 of the Interface Board.
[SDI4 [SLOT2]]*2	Sets the input to SDI4 of the Interface Board.
[DIGITAL LINK]	Sets the input to DIGITAL LINK.

[INPUT1] - [INPUT10]*4

Sets the input to DIGITAL LINK, and switches the input of the Panasonic twisted-pair-cable transmitter to the specified input.

- *1 This can be selected when the optional Interface Board equipped with corresponding input is installed in <SLOT 1>.
- *2 This can be selected when the optional Interface Board equipped with corresponding input is installed in <SLOT 2>.
- *3 This is displayed when the Interface Board for 12G-SDI (Model No.: ET-MDN12G10) is installed in <SLOT 1> or <SLOT 2>.
- *4 When the optional DIGITAL LINK output supported device (Model No.: ET-YFB100G, ET-YFB200G) is connected to the projector, its input name is automatically reflected from [INPUT1] to [INPUT10]. When an item that does not reflect the input name is selected, it will be disabled.

[DATE AND TIME]

Set the time zone, date, and time of the built-in clock of the projector.

Setting the time zone

- 1) Press ▲▼ to select [DATE AND TIME].
- 2) Press the <ENTER> button.
 - The [DATE AND TIME] screen is displayed.
- 3) Press ▲▼ to select [TIME ZONE].
- 4) Press ◀▶ to switch [TIME ZONE].

Note

- The [TIME ZONE] setting is reset to the factory default setting when the projector is initialized by one of the following methods. However, the date and time based on the local date and time setting (Coordinated Universal Time, UTC, Universal Time, Coordinated) will be maintained without being initialized.
 - When initialized by selecting the [PROJECTOR SETUP] menu → [INITIALIZE] → [FACTORY RESET]
 - When initialized by setting the [PROJECTOR SETUP] menu → [INITIALIZE] → [USER SETTINGS] → [OTHER USER SETTING] to [INITIALIZE]

Setting the date and time manually

- 1) Press ▲▼ to select [DATE AND TIME].
- 2) Press the <ENTER> button.
 - The [DATE AND TIME] screen is displayed.
- 3) Press ▲▼ to select [ADJUST CLOCK].
- 4) Press the <ENTER> button.
 - The [ADJUST CLOCK] screen is displayed.
- 5) Press ▲▼ to select an item, and press ◀▶ to set the local date and time.
- 6) Press ▲▼ to select [APPLY], and press the <ENTER> button.
 - The setting of the date and time will be completed.

Note

- The replacement of the battery inside the projector is required when the time goes out of alignment right after correcting the time. Consult your dealer.

Setting the date and time automatically

To set the date and time automatically, the projector must be connected to the network.

- 1) Press ▲▼ to select [DATE AND TIME].
- 2) Press the <ENTER> button.
 - The [DATE AND TIME] screen is displayed.
- 3) Press ▲▼ to select [ADJUST CLOCK].
- 4) Press the <ENTER> button.
 - The [ADJUST CLOCK] screen is displayed.
- 5) Press ▲▼ to select [NTP SYNCHRONIZATION], and press ◀▶ to change the setting to [ON].

6) Press ▲▼ to select [APPLY], and press the <ENTER> button.

- The setting of the date and time will be completed.

Note

- If synchronization with the NTP server fails just after [NTP SYNCHRONIZATION] is set to [ON], [NTP SYNCHRONIZATION] will return to [OFF]. If [NTP SYNCHRONIZATION] is set to [ON] while the NTP server is not set, [NTP SYNCHRONIZATION] will return to [OFF].
- Access the projector via a web browser to set the NTP server. Refer to “[Adjust clock] page” (➔ page 214) for details.

[SCHEDULE]

Set the command execution schedule for each day of the week.

Enabling/disabling the schedule function

- 1) Press ▲▼ to select [SCHEDULE].
- 2) Press ◀▶ to switch the item.
 - The items will switch each time you press the button.

[OFF]	Disables the schedule function.
[ON]	Enables the schedule function. Refer to “How to assign a program” (➔ page 167) or “How to set a program” (➔ page 167) for how to set the schedule.

How to assign a program

- 1) Press ▲▼ to select [SCHEDULE].
- 2) Press ◀▶ to select [ON], and press the <ENTER> button.
 - The [SCHEDULE] screen is displayed.
- 3) Select and assign a program to each day of week.
 - Press ▲▼ to select the day of week, and press ◀▶ to select a program number.
 - You can set the program from No.1 to No.7. “- -” indicates that the program number has not been set.

How to set a program

Set up to 16 commands to each program.

- 1) Press ▲▼ to select [SCHEDULE].
- 2) Press ◀▶ to select [ON], and press the <ENTER> button.
 - The [SCHEDULE] screen is displayed.
- 3) Press ▲▼ to select [PROGRAM EDIT].
- 4) Press ◀▶ to select a program number, and press the <ENTER> button.
- 5) Press ▲▼ to select a command number, and press the <ENTER> button.
 - You can change the page using ◀▶.
- 6) Press ▲▼◀▶ to select [TIME], and press the <ENTER> button.
 - The projector is in the adjustment mode (the time is blinking).
- 7) Press ◀▶ to select “hour” or “minute”, and press ▲▼ or the number (<0> - <9>) buttons to set a time, and then press the <ENTER> button.
- 8) Press ▲▼◀▶ to select [COMMAND].
- 9) Press the <ENTER> button.
 - The [COMMAND] detailed screen is displayed.
- 10) Press ▲▼ to select a [COMMAND].
 - For [COMMAND] which requires detailed settings, the items of the detailed settings will switch each time you press ◀▶.

- When [INPUT] is selected, press the <ENTER> button, and then press ▲▼◀▶ to select the input to be set.

[COMMAND]	Detailed settings of [COMMAND]	Description
[POWER ON]	—	Switches on the projector.
[STANDBY]	—	Enters standby.
[SHUTTER]	[OPEN]	Disables the shutter function (shutter: opened).
	[CLOSE]	Enables the shutter function (shutter: closed).
[INPUT]	[HDMI1 [SLOT1]]*1	Switches the input to HDMI1 of the Interface Board.
	[HDMI2 [SLOT1]]*1	Switches the input to HDMI2 of the Interface Board.
	[HDMI3 [SLOT2]]*2	Switches the input to HDMI3 of the Interface Board.
	[HDMI4 [SLOT2]]*2	Switches the input to HDMI4 of the Interface Board.
	[DVI-D1 [SLOT1]]*1	Switches the input to DVI-D1 of the Interface Board.
	[DVI-D2 [SLOT1]]*1	Switches the input to DVI-D2 of the Interface Board.
	[DVI-D3 [SLOT2]]*2	Switches the input to DVI-D3 of the Interface Board.
	[DVI-D4 [SLOT2]]*2	Switches the input to DVI-D4 of the Interface Board.
	[DisplayPort1 [SLOT1]]*1	Switches the input to DisplayPort1 of the Interface Board.
	[DisplayPort2 [SLOT1]]*1	Switches the input to DisplayPort2 of the Interface Board.
	[DisplayPort3 [SLOT2]]*2	Switches the input to DisplayPort3 of the Interface Board.
	[DisplayPort4 [SLOT2]]*2	Switches the input to DisplayPort4 of the Interface Board.
	[SDI1 [SLOT1]]*1	Switches the input to SDI1 of the Interface Board.
	[SDI2 [SLOT1]]*1	Switches the input to SDI2 of the Interface Board.
	[SDI3 [SLOT1]]*3	Switches the input to SDI3 of the Interface Board.
	[SDI4 [SLOT1]]*3	Switches the input to SDI4 of the Interface Board.
	[SDI1 [SLOT2]]*4	Switches the input to SDI1 of the Interface Board.
	[SDI2 [SLOT2]]*4	Switches the input to SDI2 of the Interface Board.
	[SDI3 [SLOT2]]*2	Switches the input to SDI3 of the Interface Board.
	[SDI4 [SLOT2]]*2	Switches the input to SDI4 of the Interface Board.
[DIGITAL LINK]	Switches the input to DIGITAL LINK.	
[INPUT1] - [INPUT10]*5	Switches the input to DIGITAL LINK, and switches the input of the Panasonic twisted-pair-cable transmitter to the specified input.	
[OPERATING MODE]*6	[NORMAL]	Prioritizes brightness.
	[ECO]	Prioritizes the life of the light source.
	[USER1]	Controls the power with the setting set to [USER1].
	[USER2]	Controls the power with the setting set to [USER2].
	[USER3]	Controls the power with the setting set to [USER3].

*1 This can be selected when the optional Interface Board equipped with corresponding input is installed in <SLOT 1>.

*2 This can be selected when the optional Interface Board equipped with corresponding input is installed in <SLOT 2>.

*3 This is displayed when the Interface Board for 12G-SDI (Model No.: ET-MDN12G10) is installed in <SLOT 1>.

*4 This is displayed when the Interface Board for 12G-SDI (Model No.: ET-MDN12G10) is installed in <SLOT 2>.

*5 When the optional DIGITAL LINK output supported device (Model No.: ET-YFB100G, ET-YFB200G) is connected to the projector, its input name is automatically reflected from [INPUT1] to [INPUT10]. When an item that does not reflect the input name is selected, it will be disabled.

*6 If you change the settings while using the projector, the duration until the luminance decreases by half may shorten or the luminance may decrease.

11) Press the <ENTER> button.

- The command is fixed and ● is displayed at the left of the selected command.
- After the command is fixed, press the <MENU> button to close the detailed setting screen.

12) Press ▲▼◀▶ to select [STORE], and press the <ENTER> button.

Note

- To delete a command that has been already set, press the <DEFAULT> button on the remote control while the screen in Step 5) is displayed, or select [DELETE] at the screen in Step 6) and press the <ENTER> button.
- If multiple commands have been set for the same time, they are executed in chronological order starting from the smallest command number.
- The operating time will be the local time. (➔ page 166)
- If an operation is executed with the remote control or control panel of the projector or with a control command before the command set in [SCHEDULE] is executed, the command set with the schedule function may not be executed.

[MULTI PROJECTOR SYNC]

Set the contrast synchronization function and the shutter synchronization function.

The contrast synchronization function is a function to display a combined screen with a balanced contrast by sharing the brightness level of the video signal input to each projector when a multi-display is constructed by combining the projected image of multiple projectors. The shutter synchronization function is a function to synchronize the shutter operation of the specified projector to other projectors, and the effect using the shutter function including the fade in/fade out operation can be synchronized.

To use the contrast synchronization function and the shutter synchronization function, it is necessary to connect the projectors targeted for synchronization in a loop with daisy chain connection using the <MULTI PROJECTOR SYNC IN> terminal and the <MULTI PROJECTOR SYNC OUT> terminal. For details of how to connect the projectors, refer to “Connecting example when using the contrast synchronization function/shutter synchronization function” (➔ page 56).

Note

- The contrast synchronization function and the shutter synchronization function can be used simultaneously.
- The operation of the mechanical shutter is not included in the shutter synchronization function.
- The shutter synchronization function will operate even when there are different models within the linked projectors. However, the synchronization function will not operate when there is a DLP projector that is constructed with one DLP chip such as PT-RCQ10 series within the linked projectors.
- The menu items in the [PROJECTOR SETUP] menu → [MULTI PROJECTOR SYNC] are the same as the following setting items.
 - The [PICTURE] menu → [DYNAMIC CONTRAST] → [USER] → [MULTI PROJECTOR SYNC]
 - The [DISPLAY OPTION] menu → [SHUTTER SETTING] → [MULTI PROJECTOR SYNC]

Setting the contrast synchronization function

- 1) Press ▲▼ to select [MULTI PROJECTOR SYNC].
- 2) Press the <ENTER> button.
 - The [MULTI PROJECTOR SYNC] screen is displayed.
- 3) Press ▲▼ to select [MODE].
- 4) Press ◀▶ to switch the item.
 - The items will switch each time you press the button.

[OFF]	Select this item when the contrast synchronization function and the shutter synchronization function are not used.
[MASTER]	Select this item when the contrast synchronization function or the shutter synchronization function is used. Set this item only on one projector out of the projectors that are linked. The projector set as the [MASTER] will calculate the brightness level of the video signal to become optimum on the whole combined screen for each frame. All the projectors targeted for contrast synchronization will control the dynamic contrast function based on the calculation result.
[SLAVE]	Select this item when the contrast synchronization function or the shutter synchronization function is used. Set this item in all the linked projectors excluding the projector set as the [MASTER].

- When anything other than [OFF] is selected, the diagnostic result is displayed in [LINK STATUS], indicating if all the projectors including the projectors targeted for synchronization are correctly connected, and if [MODE] is correctly set.

[LINKED]	All the projectors are correctly connected, and correctly set. They are in the condition that the contrast synchronization function or the shutter synchronization function can be used.
[NO LINK]	The projectors are not correctly connected, or not correctly set. Check the cable connection status and the projector setting for each projector that is linked.

- 5) Press ▲▼ to select [CONTRAST SYNC].
- 6) Press ◀▶ to switch the item.
 - The items will switch each time you press the button.

[OFF]	Select this item when the contrast synchronization function is not used.
[ON]	Select this item when the contrast synchronization function is used.

Note

- The contrast synchronization function will operate when all of the following conditions are fulfilled.
 - All the projectors to be linked are connected in a loop with the daisy chain connection. (Maximum 64 projectors)
 - [MODE] on only one projector that is linked is set to [MASTER], and [MODE] on all other projectors are set to [SLAVE].

- [CONTRAST SYNC] on the projectors to perform the contrast synchronization is set to [ON].
- It is possible to set [CONTRAST SYNC] to [OFF] for the projectors that are linked but not to synchronize.

Setting the shutter synchronization function

- 1) Press ▲▼ to select [MULTI PROJECTOR SYNC].
- 2) Press the <ENTER> button.
 - The [MULTI PROJECTOR SYNC] screen is displayed.
- 3) Press ▲▼ to select [MODE].
- 4) Press ◀▶ to switch the item.
 - The items will switch each time you press the button.

[OFF]	Select this item when the contrast synchronization function and the shutter synchronization function are not used.
[MASTER]	Select this item when the contrast synchronization function or the shutter synchronization function is used. Set this item only on one of the linked projectors that becomes the synchronization source of the shutter operation.
[SLAVE]	Select this item when the contrast synchronization function or the shutter synchronization function is used. Set this item in all the linked projectors excluding the projector set as the [MASTER].

- When anything other than [OFF] is selected, the diagnostic result is displayed in [LINK STATUS], indicating if all the projectors including the projectors targeted for synchronization are correctly connected, and if [MODE] is correctly set.

[LINKED]	All the projectors are correctly connected, and correctly set. They are in the condition that the contrast synchronization function or the shutter synchronization function can be used.
[NO LINK]	The projectors are not correctly connected, or not correctly set. Check the cable connection status and the projector setting for each projector that is linked.

- 5) Press ▲▼ to select [SHUTTER SYNC].
- 6) Press ◀▶ to switch the item.
 - The items will switch each time you press the button.

[OFF]	Select this item when the shutter synchronization function is not used.
[ON]	Select this item when the shutter synchronization function is used.

Note

- The shutter synchronization function will operate when all of the following conditions are fulfilled.
 - All the projectors to be linked are connected in a loop with the daisy chain connection. (Maximum 64 projectors)
 - [MODE] on only one projector that is linked is set to [MASTER], and [MODE] on all other projectors are set to [SLAVE].
 - [SHUTTER SYNC] on the projectors to perform the shutter synchronization is set to [ON].
- It is possible to set [SHUTTER SYNC] to [OFF] for the projectors that are linked but not to synchronize.
- The shutter operation by the shutter synchronization function will follow the setting of the [DISPLAY OPTION] menu → [SHUTTER SETTING] on the projector that [MODE] is set to [MASTER].
- When the input signal to each linked projector is not synchronized, the timing of the shutter operation between the projectors may shift up to 1 frame while using the shutter synchronization function.
- The shutter function of the projector with [MODE] set to [SLAVE] can be operated individually. The shutter operation at this time will follow the setting of the [DISPLAY OPTION] menu → [SHUTTER SETTING] set in that projector.

[RS-232C]

Set the communication conditions of the <SERIAL IN>/<SERIAL OUT> terminals. For details on the connection method for RS-232C communication, refer to “<SERIAL IN>/<SERIAL OUT> terminal” (➡ page 269).

Setting the communication condition of the <SERIAL IN> terminal

- 1) Press ▲▼ to select [RS-232C].
- 2) Press the <ENTER> button.
 - The [RS-232C] screen is displayed.

3) Press ▲▼ to select [INPUT SELECT].

4) Press ◀▶ to switch the item.

[PROJECTOR]	Performs the RS-232C communication with the <SERIAL IN> terminal of the projector.
[DIGITAL LINK]	Performs the RS-232C communication via the optional DIGITAL LINK output supported device (Model No.: ET-YFB100G, ET-YFB200G) and the <DIGITAL LINK> terminal.

5) Press ▲▼ to select [(IN) BAUDRATE].

6) Press ◀▶ to switch the item.

- The items will switch each time you press the button.

[9600]	Select the proper speed.
[19200]	
[38400]	

7) Press ▲▼ to select [(IN) PARITY].

8) Press ◀▶ to switch the item.

- The items will switch each time you press the button.

[NONE]	Select the parity condition.
[EVEN]	
[ODD]	

Setting the communication condition of the <SERIAL OUT> terminal

1) Press ▲▼ to select [RS-232C].

2) Press the <ENTER> button.

- The [RS-232C] screen is displayed.

3) Press ▲▼ to select [(OUT) BAUDRATE].

4) Press ◀▶ to switch the item.

- The items will switch each time you press the button.

[9600]	Select the proper speed.
[19200]	
[38400]	

5) Press ▲▼ to select [(OUT) PARITY].

6) Press ◀▶ to switch the item.

- The items will switch each time you press the button.

[NONE]	Select the parity condition.
[EVEN]	
[ODD]	

Setting the response

1) Press ▲▼ to select [RS-232C].

2) Press the <ENTER> button.

- The [RS-232C] screen is displayed.

3) Press ▲▼ to select [RESPONSE(ID ALL)].

4) Press ◀▶ to switch the item.

[ON]	Returns the response when an ID is designated as ALL.
------	---

[OFF]	Does not return the response when an ID is designated as ALL.
-------	---

5) Press ▲▼ to select [GROUP].

6) Press ◀▶ to switch the item.

[A] - [Z]	Controls multiple projectors simultaneously by sending the ID of RS-232C. You can set groups from [A] to [Z]. The projector responds when the ID of RS-232C matches the setting.
-----------	--

7) Press ▲▼ to select [RESPONSE(ID GROUP)].

8) Press ◀▶ to switch the item.

[ON]	Returns the response when an ID is designated as GROUP.
[OFF]	Does not return the response when an ID is designated as GROUP.

Note

- When [INPUT SELECT] is set to [DIGITAL LINK], communication using that serial terminal is available only when the corresponding device (such as the optional DIGITAL LINK output supported device (Model No.: ET-YFB100G, ET-YFB200G)) is connected to the <DIGITAL LINK> terminal.
- When transferring logos via the optional DIGITAL LINK output supported device (Model No.: ET-YFB100G, ET-YFB200G), setting for “NO SIGNAL SLEEP” of the DIGITAL LINK output supported device should be set to “OFF” to avoid interruption of communication.
- When [INPUT SELECT] is set to [DIGITAL LINK], communication speed for input is fixed to 9 600 bps and the parity is fixed to “NONE”.

[REMOTE2 MODE]

You can set the <REMOTE 2 IN> terminal.

1) Press ▲▼ to select [REMOTE2 MODE].

2) Press ◀▶ to switch the item.

- The items will switch each time you press the button.

[DEFAULT]	Uses pin assignment of the <REMOTE 2 IN> terminal in standard setting. (➔ page 273)
[USER]	Changes the setting of the <REMOTE 2 IN> terminal.

- Proceed to Step 3) when [USER] is selected.

3) Press the <ENTER> button.

4) Press ▲▼ to select one from [PIN2] to [PIN8], and press ◀▶ to switch the setting.

[FUNCTION BUTTON]

Set the function of the <FUNCTION> button on the remote control.

1) Press ▲▼ to select [FUNCTION BUTTON].

2) Press the <ENTER> button.

- The [FUNCTION BUTTON] screen is displayed.

3) Press ▲▼ to select a function.

[DISABLE]	Disables the <FUNCTION> button.
[SUB MEMORY]	Displays the sub memory list. (➔ page 184)
[SYSTEM SELECTOR]	Switches the [SYSTEM SELECTOR] setting according to the input signal of the image being projected. <ul style="list-style-type: none"> • When the input is SDI1 to SDI4 on the Interface Board <ul style="list-style-type: none"> - The [DISPLAY OPTION] menu → [SLOT IN] → [SINGLE LINK SETTING] → [SDI1]/[SDI2]/[SDI3]/[SDI4] → [SYSTEM SELECTOR] - The [DISPLAY OPTION] menu → [SLOT IN] → [DUAL LINK SETTING] → [SYSTEM SELECTOR] - The [DISPLAY OPTION] menu → [SLOT IN] → [QUAD LINK SETTING] → [SYSTEM SELECTOR] • When the input is anything other than SDI <ul style="list-style-type: none"> The [PICTURE] menu → [SYSTEM SELECTOR]
[SYSTEM DAYLIGHT VIEW]	Switches the [SYSTEM DAYLIGHT VIEW] setting. (➔ page 94)

[FREEZE]	Temporarily pauses the image. (➔ page 140)
[WAVEFORM MONITOR]	Displays the waveform of the input signal. (➔ page 140)
[LENS MEMORY LOAD]	Loads the registered lens memory. (➔ page 145)
[PROJECTION METHOD]	Switches the [PROJECTION METHOD] setting. (➔ page 143)
[GEOMETRY]	Switches the [GEOMETRY] setting. (➔ page 100)
[OSD POSITION]	Switches the [OSD POSITION] setting. (➔ page 133)

4) Press the <ENTER> button.

Note

- The [FUNCTION BUTTON] screen can also be displayed by holding down the <FUNCTION> button on the remote control.

[STATUS]

Display the status of the projector.

- 1) Press ▲▼ to select [STATUS].
- 2) Press the <ENTER> button.
 - The [STATUS] screen is displayed.
- 3) Press ◀▶ to switch the pages.
 - The page will change each time you press the button.

[PROJECTOR TYPE]	Displays the type of the projector.	
[SERIAL NUMBER]	Displays the serial number of the projector.	
[PROJECTOR RUNTIME]	Displays the runtime of the projector.	
[LIGHT RUNTIME]	Displays the runtime of the light source 1 and the light source 2.	
[CONTINUOUS LIGHTING TIME]	Displays the elapsed time from when the light source is illuminated. The elapsed time after the illumination of the light source can be confirmed when adjusting the focus. The elapsed time is reset when the light source is temporarily turned off such as using the shutter function.	
[MAIN/SUB VERSION]	Displays the main and sub versions of the firmware of the projector.	
[NETWORK VERSION]	Displays the network version of the firmware of the projector.	
[INTAKE AIR TEMP.]*1	Displays the intake air temperature status.	
[EXHAUST AIR TEMP.]*1	Displays the exhaust air temperature status.	
[SELF TEST]	Displays the self-diagnosis information.	
[INPUT]	Displays the input terminal currently selected. Displays the representative input terminal when one image is displayed with multiple input signals.	
[SIGNAL NAME]	Displays the input signal name.	
[MEMORY NO.]	Displays the memory number of the input signal.	
[BACKUP INPUT STATUS]	Displays whether switching to the backup input signal is possible or not when [BACKUP INPUT MODE] is set to [OFF]. (➔ page 115)	
[NUMBER OF REGISTERED SIGNAL]	Displays the number of registered signals.	
[COOLING CONDITION]	Displays the set cooling conditions.	
[ATMOSPHERIC PRESSURE]	Displays the atmospheric pressure.	
[REMOTE2 STATUS]	Displays the control status of the REMOTE2.	
[AC VOLTAGE]	Displays the input supply voltage.	
[LENS TYPE]	Displays the type name (type of the projection lens) set to the projection lens.	
[LENS ID]	Displays the ID set to the projection lens.	
[LENS NAME]	Displays the name set to the projection lens.	
[LENS THROW RATIO]	Displays the range of the throw ratio supported by the projection lens.	
[LENS ZOOM TYPE]	Displays the drive method of the zoom motor attached to the projection lens.	
[ZOOM CALIBRATION]	Displays the zoom calibration result ([OK]/[FAILED]) and the calibration date.	
[ON COUNT]	[POWER ON TIMES]	Displays the number of times the power is turned on.
	[MECHANICAL SHUTTER]	Displays the number of times the mechanical shutter is closed. It is counted when [MECHANICAL SHUTTER] is set to [ENABLE].
[OPERATING MODE]	Displays the setting value of the [PROJECTOR SETUP] menu → [OPERATION SETTING] → [OPERATING MODE].	
[NORMAL]	Displays the runtime of the light source with [OPERATING MODE] set to [NORMAL].	
[ECO]	Displays the runtime of the light source with [OPERATING MODE] set to [ECO].	

[USER1]	Displays the runtime of the light source with [OPERATING MODE] set to [USER1].	
[USER2]	Displays the runtime of the light source with [OPERATING MODE] set to [USER2].	
[USER3]	Displays the runtime of the light source with [OPERATING MODE] set to [USER3].	
[CONSOLIDATED RUNTIME]* ²	Converts the total runtime of the light sources with [OPERATING MODE] set to each item into the time used with the [NORMAL] setting. The consolidated runtime is used for a rough indication about when to perform maintenance when the projector is used in combination of each item in [OPERATING MODE].	
[UPGRADE KIT]	[ET-NUK10]	Displays the activation status by the NFC Upgrade Kit (Model No.: ET-NUK10). Or, displays the status of the NFC function. [ACTIVATED]: The NFC function can be used. [NOT ACTIVATED]: The NFC function cannot be used.
[SLOT1]	Displays the product model number of the Interface Board installed in <SLOT 1>. Also, the firmware version is displayed after the product model number.	
[SLOT2]	Displays the product model number of the Interface Board installed in <SLOT 2>. Also, the firmware version is displayed after the product model number.	
[SIGNAL INFORMATION]	[INPUT]	Displays the input terminal used for the projected image. Displays the representative input terminal when one image is displayed with multiple input signals.
	[SIGNAL FORMAT]	Displays the format of the input signal.
	[LINK]	Displays the settings of [SDI LINK], [HDMI LINK], and [DVI-D LINK]. Displays the determination result of the signal when [AUTO] is set.
	[SIMUL]	Displays the [SIMUL INPUT SETTING] setting. Displays the determination result of the signal when [AUTO(x2-speed)] is set.
	[4K DIVISION]	Displays the [4K DIVISION] setting. Displays the determination result of the signal when [AUTO] is set.
	[SAMPLING]	Displays the sampling information and the color format of the input signal.
	[BIT DEPTH]	Displays the gradation of the input signal.
	[SIGNAL LEVEL]	Displays the signal level of the input signal.
	[GAMMA]	Displays the [GAMMA] setting.
[COLOR SPACE]	Displays the [COLOR SPACE] setting.	

*1 The temperature status is indicated with text color (green/yellow/red) and bar scale. Use the projector within the range that the indication is green.

*2 [CONSOLIDATED RUNTIME] can be obtained with the following calculation formula. Values obtained by the calculation formula contain a slight error.

Conversion formula for [CONSOLIDATED RUNTIME]

$$A \times 1.0 + B \times 0.8$$

- **A:** Runtime of the light source with [OPERATING MODE] set to [NORMAL], [USER1], [USER2], or [USER3]
- **B:** Runtime of the light source with [OPERATING MODE] set to [ECO]

■ [DETAILED INFORMATION]

[INPUT]	Displays the input terminal used for the projected image.
[SIGNAL FORMAT]	Displays the format of the input signal.
[SIGNAL FREQUENCY]	Displays the frequency of the input signal.
[SCAN TYPE]	Displays the scan type of the input signal.
[TOTAL DOTS]	Displays the total dot count of the input signal.
[DISPLAY DOTS]	Displays the number of input signal display dots.
[TOTAL LINES]	Displays the total line count of the input signal.
[DISPLAY LINES]	Displays the number of input signal display lines.
[SAMPLING]	Displays the sampling information and the color format of the input signal.
[BIT DEPTH]	Displays the gradation of the input signal.
[SIGNAL LEVEL]	Displays the signal level of the input signal.
[COLORIMETRY]	Displays the color gamut information of the input signal. The content of display is as follows. [ITU-2020]: When the color gamut is compliant with ITU-R BT.2020 standard [ITU-709]: When the color gamut is compliant with ITU-R BT.709 standard [SMPTE 170M]: When the color gamut is compliant with SMPTE 170M standard [---]: When there is no signal, when the color gamut information is not included in the InfoFrame information, or when the color gamut information other than [ITU-2020], [ITU-709], or [SMPTE 170M] is included

[HDCP STATUS]	Displays the HDCP status of the input signal. The content of display is as follows. [HDCP2.2]: When protected with HDCP 2.2 [HDCP1.X]: When protected with HDCP 1.X [NONE]: When not protected with HDCP [---]: When there is no signal
---------------	---

■ [CONTENT INFORMATION]

[EOTF]	Displays EOTF (Electro-Optical Transfer Function) out of the InfoFrame information added to the input signal.	
[MASTERING DISPLAY COLOR VOLUME]	[RED]	Displays the chromaticity coordinates for the primary color red out of the InfoFrame information added to the input signal.
	[GREEN]	Displays the chromaticity coordinates for the primary color green out of the InfoFrame information added to the input signal.
	[BLUE]	Displays the chromaticity coordinates for the primary color blue out of the InfoFrame information added to the input signal.
	[WHITE]	Displays the chromaticity coordinates for the white point out of the InfoFrame information added to the input signal.
	[MAX LUMINANCE]	Displays the maximum brightness out of the InfoFrame information added to the input signal.
	[MIN LUMINANCE]	Displays the minimum brightness out of the InfoFrame information added to the input signal.
[CONTENT LIGHT LEVEL]	[MaxCLL]	Displays MaxCLL (Maximum Content Light Level) out of the InfoFrame information added to the input signal.
	[MaxFALL]	Displays MaxFALL (Maximum Frame Average Light Level) out of the InfoFrame information added to the input signal.

Note

- If you press the <ENTER> button while displaying [SIGNAL INFORMATION] in the page 6/6 of the [STATUS] screen, the [DETAILED INFORMATION] screen can be displayed to view the detailed information of the input signal. Information for multiple input signals may be displayed depending on the projected image. Press ◀▶ to switch pages.
- While the [DETAILED INFORMATION] screen is displayed, press the <ENTER> button to display the [CONTENT INFORMATION] screen, and the contents of the InfoFrame information added to the input signal can be displayed.
- There are items that are displayed or not displayed in [SIGNAL INFORMATION], [DETAILED INFORMATION], and [CONTENT INFORMATION] depending on the setting and the signal being input.
- While the [STATUS] screen is displayed, press the <DEFAULT> button to check the details of the temperature information of each part inside the projector.
For details of operation, refer to “Displaying the details of the temperature information” (➔ page 175).
- If any abnormality has occurred on the projector, press the <DEFAULT> button while the [STATUS] screen is displayed to check the details of the error information.
- For details on the contents displayed in [SELF TEST], refer to “Self-diagnosis display” (➔ page 256).

Displaying the details of the temperature information

Details of the temperature information of each part inside the projector can be checked.

1) Press the <DEFAULT> button while the [STATUS] screen is displayed.

- The selection screen is displayed.

2) Press ▲▼ to select [TEMPERATURE INFORMATION].

- The items will switch each time you press the button.

[ERROR INFORMATION]	Displays the detailed screen of the error information.
[TEMPERATURE INFORMATION]	Displays the detailed screen of the temperature information.

3) Press the <ENTER> button.

- The detailed screen of the temperature information is displayed (English only).

Note

- Select [ERROR INFORMATION] in Step 2) to display the detailed screen of the error information (English only).

Sending status content via E-mail

The status content can be sent to the E-mail address (up to two addresses) set in “[E-mail set up] page” (➔ page 221).

- 1) Press the <ENTER> button while the 1/6 to 5/6 page of the [STATUS] screen is displayed.
 - The selection screen is displayed.
- 2) Press ▲▼ to select [SEND E-MAIL].
- 3) Press the <ENTER> button.
 - The [SELECT E-MAIL ADDRESS] screen is displayed.
- 4) Press ▲▼ to select the destination.
- 5) Press the <ENTER> button.
 - The confirmation screen is displayed.
- 6) Press ◀▶ to select [OK], and press the <ENTER> button.
 - The status content is sent.

Saving status content in USB memory

The status content can be saved in a USB memory attached to the <USB> terminal.

- 1) Press the <ENTER> button while the 1/6 to 5/6 page of the [STATUS] screen is displayed.
 - The selection screen is displayed.
- 2) Press ▲▼ to select [SAVE TO USB MEMORY].
- 3) Press the <ENTER> button.
 - The confirmation screen is displayed.
- 4) Press ◀▶ to select [OK], and press the <ENTER> button.
 - The status content is saved.

[INFO MONITOR SETTING]

Set the information monitor of the control panel.

For operation of the information monitor, refer to “Using the information monitor function” (➔ page 229).

Setting the display during normal status

Display/hide the information monitor during no operation.

- 1) Press ▲▼ to select [INFO MONITOR SETTING].
- 2) Press the <ENTER> button.
 - The [INFO MONITOR SETTING] screen is displayed.
- 3) Press ▲▼ to select [DEFAULT].
- 4) Press ◀▶ to switch the item.
 - The items will switch each time you press the button.

[USER VIEW]	Displays the items set in the [PROJECTOR SETUP] menu → [INFO MONITOR SETTING] → [USER VIEW].
[OFF]	Does not display the information.

Note

- Even if [DEFAULT] is set to [OFF], the content of an error or a warning is automatically displayed when it occurs.
- This can also be set with operation in the information monitor. For details, refer to “Using the information monitor function” (➔ page 229).

Setting the information to display

Set the items to display on the information monitor during no operation.

- 1) Press ▲▼ to select [INFO MONITOR SETTING].
- 2) Press the <ENTER> button.
 - The [INFO MONITOR SETTING] screen is displayed.
- 3) Press ▲▼ to select [USER VIEW].
- 4) Press the <ENTER> button.
 - The [USER VIEW] screen is displayed.
- 5) Press ▲▼ to select an item.

[INPUT]	Currently selected input terminal*1
[SIGNAL NAME]	Input signal name
[AC VOLTAGE]	Input supply voltage
[INTAKE AIR TEMP.]	Intake air temperature of the projector
[EXHAUST AIR TEMP.]	Exhaust air temperature of the projector
[SHUTTER]	Status of the shutter ([CLOSE]: Shutter function enabled; [OPEN]: Shutter function disabled)
[OSD]	Status of the on-screen display function ([ON]: Display; [OFF]: Hide)
[IP ADDRESS(WIRED)]	IP address of the wired LAN

*1 The representative input terminal is displayed when one image is displayed with multiple input signals.

- 6) Press ◀▶ to switch the setting.
 - The items will switch each time you press the button.

[ON]	Displays the items in the information monitor.
[OFF]	Does not display the items in the information monitor.

- Repeat Steps 5) to 6) until the desired display items are set.

Note

- This can also be set with operation in the information monitor. For details, refer to “Using the information monitor function” (➔ page 229).

Setting the direction to display

Set the direction of the text to display in the information monitor.

- 1) Press ▲▼ to select [INFO MONITOR SETTING].
- 2) Press the <ENTER> button.
 - The [INFO MONITOR SETTING] screen is displayed.
- 3) Press ▲▼ to select [DIRECTION].
- 4) Press ◀▶ to switch the item.
 - The items will switch each time you press the button.

[AUTO]	Detects the orientation of the projector by the built-in angle sensor, and automatically sets the direction of the text displayed in the information monitor. Set [AUTO] normally.
[NORMAL]	Select this item when installing the projector on a desk, etc.
[FLIPPED]	Select this item when installing the projector with the top surface of the projector facing down such as ceiling attachment. Displays the text inverted upside down from when [NORMAL] is set.

Note

- This can also be set with operation in the information monitor. For details, refer to “Using the information monitor function” (➔ page 229).

Setting the brightness of the information monitor

Set the brightness of the information monitor.

- 1) Press ▲▼ to select [INFO MONITOR SETTING].

- 2) Press the <ENTER> button.
 - The [INFO MONITOR SETTING] screen is displayed.
- 3) Press ▲▼ to select [BRIGHTNESS].
- 4) Press ◀▶ to adjust the level.

Operation	Adjustment	Range of adjustment
Press ▶.	The information monitor becomes bright.	30 % - 100 % (Factory default setting: 100 %)
Press ◀.	The information monitor becomes dark.	

Note

- [BRIGHTNESS] is adjusted in increments of 10.
- This can also be set with operation in the information monitor. For details, refer to “Using the information monitor function” (➔ page 229).

[DATA CLONING]

Perform the operation of the data cloning function. Data such as the settings and adjustment values of the projector can be copied to multiple projectors via LAN or using the USB memory. For details of operation, refer to “Using the data cloning function” (➔ page 239).

[SAVE ALL USER DATA]

Save the various setting values as a backup in the built-in memory of the projector.

- 1) Press ▲▼ to select [SAVE ALL USER DATA].
- 2) Press the <ENTER> button.
 - The [SECURITY PASSWORD] screen is displayed.
- 3) Enter a security password and press the <ENTER> button.
 - The confirmation screen is displayed.
- 4) Press ◀▶ to select [OK], and press the <ENTER> button.
 - [PROGRESS] is displayed while saving data.

Note

- The data saved by executing [SAVE ALL USER DATA] does not include the data set with “Geometric & Setup Management Software”.
- The data saved by executing [SAVE ALL USER DATA] is not deleted even if the [PROJECTOR SETUP] menu → [INITIALIZE] → [FACTORY RESET] is executed.

[LOAD ALL USER DATA]

Load the various setting values saved as a backup in the built-in memory of the projector.

- 1) Press ▲▼ to select [LOAD ALL USER DATA].
- 2) Press the <ENTER> button.
 - The [SECURITY PASSWORD] screen is displayed.
- 3) Enter a security password and press the <ENTER> button.
 - The confirmation screen is displayed.
- 4) Press ◀▶ to select [OK], and press the <ENTER> button.

Note

- The projector enters the standby mode to reflect the setting values when [LOAD ALL USER DATA] is executed.
- The data loaded from [LOAD ALL USER DATA] does not include the data set with “Geometric & Setup Management Software”.

[INITIALIZE]

Return the various user data settings to the factory default settings.

- 1) Press ▲▼ to select [INITIALIZE].
- 2) Press the <ENTER> button.
 - The [SECURITY PASSWORD] screen is displayed.

3) Enter a security password and press the <ENTER> button.

- The [INITIALIZE] screen is displayed.

4) Press ▲▼ to select an item to initialize.

[USER SETTINGS]	The user data to return to factory default settings can be selected arbitrarily. The projector goes into the standby status after executing [INITIALIZE]. For details of operation, refer to “Initializing the settings by selecting the items” (➡ page 179).
[REGISTERED SIGNAL ONLY]	Deletes all the signals registered in [SIGNAL LIST]. All the setting values saved for each registered signal are also deleted.
[NETWORK/E-MAIL ONLY]	Returns all the setting items under the [NETWORK] menu and all the setting items under the operation page in the [Detailed set up] page and the Crestron Connected of the web control screen to the factory default settings. <ul style="list-style-type: none"> • The items of [Time Zone], [Date], and [Time] in the [Adjust clock] page of the web control screen do not return to the factory default settings. • The information such as the self-signed certificate already created in the [Https set up] page of the web control screen or the server certificate already installed is not deleted.
[LOGO IMAGE ONLY]	Deletes the image registered in [USER LOGO].
[UNIFORMITY ONLY]	Sets the setting of the [DISPLAY OPTION] menu → [UNIFORMITY] to the factory default setting.
[FACTORY RESET]	Returns all the user data settings to the factory default settings. The projector goes into the standby status after executing [FACTORY RESET].

- Proceed to Step 5) when anything other than [USER SETTINGS] is selected.

5) Press the <ENTER> button.

- The confirmation screen is displayed.

6) Press ◀▶ to select [OK], and press the <ENTER> button.

Note

- The security password is the password set in the [SECURITY] menu → [SECURITY PASSWORD CHANGE]. Initial password of the factory default setting: ▲▶▼◀▶▶▶▶▶
- To delete only a part of a registered signal, delete it following “Deleting the registered signal” (➡ page 182).
- To return the setting of [Time Zone] in the [Adjust clock] page of the web control screen and the setting of the [PROJECTOR SETUP] menu → [DATE AND TIME] → [TIME ZONE] to the factory default settings, initialize them by one of the following methods.
 - Initializing by selecting the [PROJECTOR SETUP] menu → [INITIALIZE] → [FACTORY RESET]
 - Initializing by setting the [PROJECTOR SETUP] menu → [INITIALIZE] → [USER SETTINGS] → [OTHER USER SETTING] to [INITIALIZE]
- The self-signed certificate already created in the [Https set up] page of the web control screen or the information of the server certificate already installed can be deleted in the web control screen.
- Following settings are not returned to factory default settings even if the projector is initialized by selecting [FACTORY RESET].
 - The [PROJECTOR SETUP] menu → [LENS] → [LENS INFORMATION SETTING] → [LENS ID] and [LENS NAME]
 - The [PROJECTOR SETUP] menu → [LENS] → [ACTIVE FOCUS OPTIMIZER] → [FOCUS OFFSET BRIGHT] and [FOCUS OFFSET DARK]
- To return the settings of [FOCUS OFFSET BRIGHT] and [FOCUS OFFSET DARK] in the [PROJECTOR SETUP] menu → [LENS] → [ACTIVE FOCUS OPTIMIZER] to the factory default settings, execute the [PROJECTOR SETUP] menu → [LENS] → [ACTIVE FOCUS OPTIMIZER] → [FOCUS OFFSET SETUP] → [INITIALIZE].
- If initialized by selecting [FACTORY RESET], the [INITIAL SETTING] screen is displayed when the projection is started the next time.

Initializing the settings by selecting the items

1) Press ▲▼ to select [INITIALIZE].

2) Press the <ENTER> button.

- The [SECURITY PASSWORD] screen is displayed.

3) Enter a security password and press the <ENTER> button.

- The [INITIALIZE] screen is displayed.

4) Press ▲▼ to select [USER SETTINGS].

5) Press the <ENTER> button.

- The [USER SETTINGS] screen is displayed.

6) Press ▲▼ to select an item.

[OPERATION SETTING]	The [PROJECTOR SETUP] menu → [OPERATION SETTING] → [OPERATING MODE] and [MAX LIGHT OUTPUT LEVEL] are initialized. [LIGHT OUTPUT] is not initialized. The [LIGHT OUTPUT] setting is maintained.
---------------------	--

[REGISTERED SIGNAL]	All the signals registered in [SIGNAL LIST] are initialized.
[NETWORK/E-MAIL]	All the setting items under the [NETWORK] menu and all the setting items under the operation page in the [Detailed set up] page and the Crestron Connected of the web control screen are initialized. <ul style="list-style-type: none"> • The items of [Time Zone], [Date], and [Time] in the web control screen are not initialized. • The information such as the self-signed certificate already created in the [Https set up] page of the web control screen or the server certificate already installed is not initialized.
[LOGO IMAGE]	Image registered in [USER LOGO] is initialized.
[UNIFORMITY]	The [DISPLAY OPTION] menu → [UNIFORMITY] is initialized.
[CONVERGENCE]	The [POSITION] menu → [CONVERGENCE] is initialized.
[OTHER USER SETTING]	The user data other than mentioned above are initialized.

7) Press ◀▶ to switch the setting.

- The items will switch each time you press the button.

[KEEP]	Does not return to the factory default settings and maintains the current settings when initialization is executed by [USER SETTINGS].
[INITIALIZE]	Returns to the factory default settings when initialization is executed by [USER SETTINGS].

- Repeat Steps 6) to 7) until the desired initialization items are set.

8) Press ▲▼ to select [INITIALIZE].

9) Press the <ENTER> button.

- The confirmation screen is displayed.

10) Press ◀▶ to select [OK], and press the <ENTER> button.

Note

- To return the setting in the [PROJECTOR SETUP] menu → [LIGHT OUTPUT] to the factory default setting, initialize it by selecting [OTHER USER SETTING].
- To return the setting of [Time Zone] in the [Adjust clock] page of the web control screen and the setting of the [PROJECTOR SETUP] menu → [DATE AND TIME] → [TIME ZONE] to the factory default settings, initialize them by one of the following methods.
 - Initializing by selecting the [PROJECTOR SETUP] menu → [INITIALIZE] → [FACTORY RESET]
 - Initializing by setting the [PROJECTOR SETUP] menu → [INITIALIZE] → [USER SETTINGS] → [OTHER USER SETTING] to [INITIALIZE]

[FIRMWARE UPDATE]

Rewriting of the firmware is possible by using a USB memory.

For details of operation, refer to “Updating the firmware using the USB memory” (➔ page 248).

[SERVICE PASSWORD]

This function is used by a service person.

[TEST PATTERN] menu

On the menu screen, select [TEST PATTERN] from the main menu.

Refer to “Navigating through the menu” (➔ page 84) for the operation of the menu screen.

[TEST PATTERN]

Display the test pattern built-in to the projector.

Settings of position, size, and other factors will not be reflected in test patterns. Make sure to display the input signal before performing various adjustments.

1) Press ◀▶ to switch the [TEST PATTERN] item.

- The items will switch each time you press the button.

Menu screen + All white	Displays a test pattern with the menu screen. Select a desired test pattern.
Menu screen + All black	
Menu screen + Window	
Menu screen + Window (inversion)	
Menu screen + Color bar (vertical)	
Menu screen + Color bar (horizontal)	
Menu screen + 16:9/4:3 aspect frame	
Menu screen + Cross hatch	
Menu screen + Focus	
Menu screen + Input screen	Displays the menu screen and input signal. Built-in test patterns are not displayed.

Note

- Press the <ON SCREEN> button on the remote control while the test pattern is displayed to hide the menu screen.
- It is recommended to perform the focus adjustment after 30 minutes have elapsed with the focus test pattern displayed. To use the active focus optimizer function, set the [PROJECTOR SETUP] menu → [LENS] → [ACTIVE FOCUS OPTIMIZER] → [ACTIVE FOCUS] to [ON], and then adjust the focus. (➔ page 148)

Changing the color of the cross hatch test pattern

The color can be changed when the “Menu screen + Cross hatch” test pattern is displayed.

1) Press ◀▶ to select the “Menu screen + Cross hatch” test pattern.

2) Press the <ENTER> button.

- The [TEST PATTERN COLOR] screen is displayed.

3) Press ▲▼ to select a color, and press the <ENTER> button.

- The color of the cross hatch test pattern is changed to the selected color.

Note

- The test pattern color settings return to [WHITE] when the projector is switched off.
- Colors of the test patterns other than cross hatch test patterns cannot be changed.

[SIGNAL LIST] menu

On the menu screen, select [SIGNAL LIST] from the main menu.

Refer to “Navigating through the menu” (➔ page 84) for the operation of the menu screen.

■ Registered signal details

Memory number: A1 (1-2)



When the address number (A1, A2, ... L7, L8) signal is registered

- A name can be set for each sub memory (➔ page 184).

Registering new signals

After a new signal is input and the <MENU> button on the remote control or the control panel is pressed, the registration is completed and the [MAIN MENU] screen is displayed.

Note

- Up to 96 signals, including sub memories, can be registered to the projector.
- There are 12 pages (eight memories of A through L, with eight memories possible on each page) for memory numbers, and the signal is registered to the lowest number that is available. If there is no available memory number it will be overwritten from the oldest signal.
- The name to be registered is automatically determined by the input signal.
- If a menu is being displayed, the new signals will be registered at the instant they are input.

Renaming the registered signal

Registered signals can be renamed.

- 1) Press ▲▼◀▶ to select the signal of which name is to be changed.
- 2) Press the <ENTER> button.
 - The [REGISTERED SIGNAL STATUS] screen is displayed.
 - The memory number, input terminal, input signal name, frequency, synch polarity, etc., are displayed.
 - Press the <MENU> button to return to the [REGISTERED SIGNAL LIST] screen.
- 3) Press the <ENTER> button.
 - The [REGISTERED SIGNAL SETUP] screen is displayed.
- 4) Press ▲▼ to select [SIGNAL NAME CHANGE].
- 5) Press the <ENTER> button.
 - The [SIGNAL NAME CHANGE] screen is displayed.
- 6) Press ▲▼◀▶ to select the text, and press the <ENTER> button to enter the text.
- 7) After the name is changed, press ▲▼◀▶ to select [OK], and press the <ENTER> button.
 - The registration is completed and the [REGISTERED SIGNAL SETUP] screen returns.
 - When pressing ▲▼◀▶ to select [CANCEL] and pressing the <ENTER> button, the changed signal name will not be registered and an automatically registered signal name will be used.

Deleting the registered signal

Registered signals can be deleted.

- 1) Press ▲▼◀▶ to select the signal to delete.
- 2) Press the <DEFAULT> button on the remote control.
 - The [REGISTERED SIGNAL DELETE] screen is displayed.
 - To cancel the deletion, press the <MENU> button to return to the [REGISTERED SIGNAL LIST] screen.
- 3) Press the <ENTER> button.
 - The selected signal will be deleted.

Note

- A registered signal can also be deleted from [REGISTERED SIGNAL DELETE] on the [REGISTERED SIGNAL SETUP] screen.

Protecting the registered signal

- 1) Press ▲▼◀▶ to select the signal to protect.
- 2) Press the <ENTER> button.
 - The [REGISTERED SIGNAL STATUS] screen is displayed.
- 3) Press the <ENTER> button.
 - The [REGISTERED SIGNAL SETUP] screen is displayed.
- 4) Press ▲▼ to select [LOCK].
- 5) Press ◀▶ to switch the item.
 - The items will switch each time you press the button.

[OFF]	The signal is not protected.
[ON]	The signal is protected.

- A lock icon is displayed at the right of the [REGISTERED SIGNAL LIST] screen when [LOCK] is set to [ON].

**Note**

- When [LOCK] is set to [ON], signal deletion, image adjustment, and automatic setup are not available. To perform these operations, set [LOCK] to [OFF].
- A signal can be registered to the sub memory even if it is protected.
- Even a protected signal will be deleted if [INITIALIZE] is executed.

Expanding signal lock-in range

- 1) Press ▲▼◀▶ to select the signal to set.
- 2) Press the <ENTER> button.
 - The [REGISTERED SIGNAL STATUS] screen is displayed.
- 3) Press the <ENTER> button.
 - The [REGISTERED SIGNAL SETUP] screen is displayed.
- 4) Press ▲▼ to select [LOCK-IN RANGE].
- 5) Press ◀▶ to switch the item.
 - The items will switch each time you press the button.

[NARROW]	Select in most cases.
[WIDE]	Widens the lock-in range.

- An expansion icon is displayed at the right of the [REGISTERED SIGNAL LIST] screen when [LOCK-IN RANGE] is set to [WIDE].

**Note**

- Switch the range where the signal to be input is determined to be the same signal as the already registered signal.
- To prioritize the determination that a signal is the same as the already registered signal, set this function to [WIDE]. Use in cases such as when the synchronizing frequency of a signal to be input has changed slightly, or multiple signal lists are registered.
- This function cannot be set for the SDI signal.
- When [WIDE] is set, the image may be distorted because a signal is recognized as the same even if its synchronizing frequency varies slightly.
- When a signal to be input corresponds to multiple signals set in [WIDE], a registered signal with a high memory number receives priority. Example: a signal to be input that corresponds to memory numbers A2, A4 and B1 will be determined to be B1.
- When a registration signal is deleted, the settings are also deleted.

- In an environment where multiple types of signals are input to the same terminal, signals are sometimes not determined correctly when the setting is set to [WIDE].

Sub memory

The projector has a sub memory function that can register the multiple image adjustment data, even if it is recognized as the same signal by the frequency or format of the synchronization signal source.

Use this function when you need to switch the aspect or adjust the picture quality such as the white balance while using the same signal source. The sub memory includes all the data that can be adjusted for each signal, such as the screen aspect ratio and data adjusted in the [PICTURE] item (such as [CONTRAST], [BRIGHTNESS]).

Registering to the sub memory

- 1) **While in the normal screen (where no menu is displayed), press ◀▶.**
 - The sub memory registration screen is displayed if the sub memory is not registered. Proceed to Step 3).
 - A list of sub memories registered to the signal currently input is displayed.
 - The <FUNCTION> button on the remote control can be used instead of the ◀▶ button when [SUB MEMORY] is selected from the [PROJECTOR SETUP] menu → [FUNCTION BUTTON].
- 2) **Press ▲▼◀▶ to select the sub memory number to register in [SUB MEMORY LIST].**
- 3) **Press the <ENTER> button.**
 - The [SIGNAL NAME CHANGE] screen is displayed.
- 4) **Press ▲▼◀▶ to select [OK], and press the <ENTER> button.**
 - To rename the registered signal, follow the procedure in Steps 6) and 7) in “Renaming the registered signal” (➔ page 182).

Switching to the sub memory

- 1) **While in the normal screen (where no menu is displayed), press ◀▶.**
 - A list of sub memories registered to the signal currently input is displayed.
- 2) **Press ▲▼◀▶ to select the signal to switch in [SUB MEMORY LIST].**
- 3) **Press the <ENTER> button.**
 - This switches to the signal selected in Step 2).

Deleting the sub memory

- 1) **While in the normal screen (where no menu is displayed), press ◀▶.**
 - The [SUB MEMORY LIST] screen is displayed.
- 2) **Press ▲▼◀▶ to select the sub memory to be deleted, and press the <DEFAULT> button on the remote control.**
 - The [REGISTERED SIGNAL DELETE] screen is displayed.
 - To cancel the deletion, press the <MENU> button to return to the [SUB MEMORY LIST] screen.
- 3) **Press the <ENTER> button.**
 - The selected sub memory will be deleted.

[SECURITY] menu

On the menu screen, select [SECURITY] from the main menu, and select an item from the sub-menu. Refer to “Navigating through the menu” (➔ page 84) for the operation of the menu screen.

- When the projector is used for the first time
Initial password: Press ▲▶▼◀▲▶▼◀ in order, and press the <ENTER> button.

Attention

- When you select the [SECURITY] menu and press the <ENTER> button, entering a password is prompted. Enter the preset password and then continue operations of the [SECURITY] menu.
- When the password has been changed previously, enter the changed password, and press the <ENTER> button.

Note

- The entered password is displayed with * marks on the screen.
- An error message is displayed on the screen when the entered password is incorrect. Re-enter the correct password.

[SECURITY PASSWORD]

Display the [SECURITY PASSWORD] screen when the power is turned on with the <MAIN POWER> switch set to the <OFF> side. When the entered password is incorrect, the operation will be restricted to the power standby <⏻> button, the <SHUTTER> button, and the <LENS> buttons (<FOCUS>, <ZOOM>, <SHIFT>).

- 1) Press ▲▼ to select [SECURITY PASSWORD].
- 2) Press ◀▶ to switch the item.
 - The items will switch each time you press the button.

[OFF]	Disables the security password entry.
[ON]	Enables the security password entry.

Note

- The [SECURITY PASSWORD] setting is set to [OFF] by the factory default setting, or after initialized by one of the following methods.
 - When initialized by selecting the [PROJECTOR SETUP] menu → [INITIALIZE] → [FACTORY RESET]
 - When initialized by setting the [PROJECTOR SETUP] menu → [INITIALIZE] → [USER SETTINGS] → [OTHER USER SETTING] to [INITIALIZE]
- Change the password periodically that is hard to guess.
- The security password is enabled after setting [SECURITY PASSWORD] to [ON] and turning the <MAIN POWER> switch to <OFF>.

[SECURITY PASSWORD CHANGE]

Change the security password.

- 1) Press ▲▼ to select [SECURITY PASSWORD CHANGE].
- 2) Press the <ENTER> button.
 - The [SECURITY PASSWORD CHANGE] screen is displayed.
- 3) Press ▲▼◀▶ and the number (<0> - <9>) buttons to set the password.
 - Up to eight button operations can be set.
- 4) Press the <ENTER> button.
- 5) Re-enter the password for the confirmation.
- 6) Press the <ENTER> button.

Note

- The entered password is displayed with * marks on the screen.
- When numerical values are used for the security password, the security password is required to be initialized if the remote control is lost. Consult your dealer for the method of initialization.

[CONTROL DEVICE SETUP]

Enable/disable the button operations on the control panel and the remote control.

- 1) Press ▲▼ to select [CONTROL DEVICE SETUP].

- 2) Press the <ENTER> button.
 - The [CONTROL DEVICE SETUP] screen is displayed.
- 3) Press ▲▼ to select [CONTROL PANEL] or [REMOTE CONTROL].

[CONTROL PANEL]	You can set the limitation on the control from the control panel.
[REMOTE CONTROL]	You can set the limitation on the control from the remote control.

- 4) Press the <ENTER> button.
 - The [CONTROL PANEL] screen or the [REMOTE CONTROL] screen is displayed.
- 5) Press ▲▼ to select [CONTROL PANEL] or [REMOTE CONTROL].
- 6) Press ◀▶ to switch the item.
 - You can set the operation restriction from the control panel or the remote control.

[ENABLE]	Enables all button operations.
[DISABLE]	Disables all button operations.
[USER]	Operation of all buttons can be enabled/disabled separately. Refer to “Enabling/disabling any button” (▶ page 186) for details.

- 7) Press ▲▼ to select [APPLY], and press the <ENTER> button.
 - The confirmation screen is displayed.
- 8) Press ◀▶ to select [OK], and press the <ENTER> button.

Enabling/disabling any button

- 1) Press ▲▼ to select [CONTROL DEVICE SETUP].
- 2) Press the <ENTER> button.
 - The [CONTROL DEVICE SETUP] screen is displayed.
- 3) Press ▲▼ to select [CONTROL PANEL] or [REMOTE CONTROL].
- 4) Press the <ENTER> button.
 - The [CONTROL PANEL] screen or the [REMOTE CONTROL] screen is displayed.
- 5) Press ▲▼ to select [CONTROL PANEL] or [REMOTE CONTROL].
- 6) Press ◀▶ to switch [USER].
- 7) Press ▲▼ to select the button item to set.
 - When [INPUT SELECT BUTTON] is selected, press the <ENTER> button, and then press ▲▼ to select the button to set.

	Buttons that can be set	
	[CONTROL PANEL]	[REMOTE CONTROL]
[POWER BUTTON]	Power standby <⏻> button, power on <⏻> button	
[INPUT SELECT BUTTON]	<SLOT 1> button, <SLOT 2> button, <DIGITAL LINK> button, <INPUT MENU> button	<DVI-D> button, <HDMI> button, <DISPLAYPORT> button, <SDI> button, <SLOT 1> button, <SLOT 2> button, <DIGITAL LINK> button, <INPUT MENU> button
[MENU BUTTON]	<MENU> button	
[LENS BUTTON]	<LENS> button	Lens buttons (<FOCUS>, <ZOOM>, <SHIFT>)
[AUTO SETUP BUTTON]	—	<AUTO SETUP> button
[SHUTTER BUTTON]	<SHUTTER> button	
[ASPECT BUTTON]	—	<ASPECT> button
[ON SCREEN BUTTON]	<ON SCREEN> button	
[OTHER BUTTON]	▲▼◀▶, <ENTER> button	Buttons not listed above

- 8) Press ◀▶ to switch the item.

[ENABLE]	Enables button operations.
----------	----------------------------

[DISABLE]	Disables button operations.
-----------	-----------------------------

- When [INPUT SELECT BUTTON] is selected in Step 7), the item that can be set varies depending on the selected button.
Refer to “Item that can be set with [INPUT SELECT BUTTON]” (➔ page 187) for details.
Once the switching of the item is completed, press the <MENU> button to return to the [CONTROL PANEL] screen or the [REMOTE CONTROL] screen.

9) Press ▲▼ to select [APPLY], and press the <ENTER> button.

- The confirmation screen is displayed.

10) Press ◀▶ to select [OK], and press the <ENTER> button.

Note

- When a button operation is performed on the device set to [DISABLE], the [CONTROL DEVICE PASSWORD] screen is displayed.
Enter the control device password.
- The [CONTROL DEVICE PASSWORD] screen will disappear when there is no operation for approximately 10 seconds.
- If the operations of both [CONTROL PANEL] and [REMOTE CONTROL] are set to [DISABLE], the projector cannot be turned off (cannot enter standby).
- When the setting has completed, the menu screen will disappear. To operate continuously, press the <MENU> button to display the main menu.
- Even when you set button operations on the remote control disabled, operations of the <ID SET> and <ID ALL> buttons on the remote control are kept enabled.

Item that can be set with [INPUT SELECT BUTTON]

When [INPUT SELECT BUTTON] is selected in Step 7) of “Enabling/disabling any button” (➔ page 186), the item that can be selected varies depending on the button to set.

The item that can be selected when each button is set is as follows.

■ [DVI-D BUTTON]

[DVI-D1 [SLOT1]] and [DVI-D2 [SLOT1]] can be selected when the optional Interface Board for DVI-D 2 input (Model No.: ET-MDNDV10) is installed in <SLOT 1>.

[DVI-D3 [SLOT2]] and [DVI-D4 [SLOT2]] can be selected when the optional Interface Board for DVI-D 2 input (Model No.: ET-MDNDV10) is installed in <SLOT 2>.

[TOGGLE]	Switches the items in following order when the button is operated. [DVI-D1 [SLOT1]] → [DVI-D2 [SLOT1]] → [DVI-D3 [SLOT2]] → [DVI-D4 [SLOT2]]
[DVI-D1 [SLOT1]]	Fixes to selection operation of the DVI-D1 input of the Interface Board.
[DVI-D2 [SLOT1]]	Fixes to selection operation of the DVI-D2 input of the Interface Board.
[DVI-D3 [SLOT2]]	Fixes to selection operation of the DVI-D3 input of the Interface Board.
[DVI-D4 [SLOT2]]	Fixes to selection operation of the DVI-D4 input of the Interface Board.
[DISABLE]	Disables button operations.

■ [HDMI BUTTON]

[HDMI1 [SLOT1]] and [HDMI2 [SLOT1]] can be selected when the optional Interface Board for HDMI 2 input (Model No.: ET-MDNHM10) is installed in <SLOT 1>.

[HDMI3 [SLOT2]] and [HDMI4 [SLOT2]] can be selected when the optional Interface Board for HDMI 2 input (Model No.: ET-MDNHM10) is installed in <SLOT 2>.

[TOGGLE]	Switches the items in following order when the button is operated. [HDMI1 [SLOT1]] → [HDMI2 [SLOT1]] → [HDMI3 [SLOT2]] → [HDMI4 [SLOT2]]
[HDMI1 [SLOT1]]	Fixes to selection operation of the HDMI1 input of the Interface Board.
[HDMI2 [SLOT1]]	Fixes to selection operation of the HDMI2 input of the Interface Board.
[HDMI3 [SLOT2]]	Fixes to selection operation of the HDMI3 input of the Interface Board.
[HDMI4 [SLOT2]]	Fixes to selection operation of the HDMI4 input of the Interface Board.
[DISABLE]	Disables button operations.

■ [DISPLAYPORT BUTTON]

[DisplayPort1 [SLOT1]] and [DisplayPort2 [SLOT1]] can be selected when the optional Interface Board for DisplayPort 2 input (Model No.: ET-MDNDP10) is installed in <SLOT 1>.

[DisplayPort3 [SLOT2]] and [DisplayPort4 [SLOT2]] can be selected when the optional Interface Board for DisplayPort 2 input (Model No.: ET-MDNDP10) is installed in <SLOT 2>.

[TOGGLE]	Switches the items in following order when the button is operated. [DisplayPort1 [SLOT1]] → [DisplayPort2 [SLOT1]] → [DisplayPort3 [SLOT2]] → [DisplayPort4 [SLOT2]]
[DisplayPort1 [SLOT1]]	Fixes to selection operation of the DisplayPort1 input of the Interface Board.
[DisplayPort2 [SLOT1]]	Fixes to selection operation of the DisplayPort2 input of the Interface Board.
[DisplayPort3 [SLOT2]]	Fixes to selection operation of the DisplayPort3 input of the Interface Board.
[DisplayPort4 [SLOT2]]	Fixes to selection operation of the DisplayPort4 input of the Interface Board.
[DISABLE]	Disables button operations.

■ [SDI BUTTON]

The items from [SDI1 [SLOT1]] to [SDI4 [SLOT1]] can be selected when the optional Interface Board for 12G-SDI (Model No.: ET-MDN12G10) is installed in <SLOT 1>.

The items from [SDI1 [SLOT2]] to [SDI4 [SLOT2]] can be selected when the optional Interface Board for 12G-SDI (Model No.: ET-MDN12G10) is installed in <SLOT 2>.

[TOGGLE]	Switches the SDI input of the optional Interface Boards installed in <SLOT 1> and <SLOT 2> in turn when the button is operated.
[SDI1 [SLOT1]]	Fixes to selection operation of the SDI1 input of the Interface Board.
[SDI2 [SLOT1]]	Fixes to selection operation of the SDI2 input of the Interface Board.
[SDI3 [SLOT1]]	Fixes to selection operation of the SDI3 input of the Interface Board.
[SDI4 [SLOT1]]	Fixes to selection operation of the SDI4 input of the Interface Board.
[SDI1 [SLOT2]]	Fixes to selection operation of the SDI1 input of the Interface Board.
[SDI2 [SLOT2]]	Fixes to selection operation of the SDI2 input of the Interface Board.
[SDI3 [SLOT2]]	Fixes to selection operation of the SDI3 input of the Interface Board.
[SDI4 [SLOT2]]	Fixes to selection operation of the SDI4 input of the Interface Board.
[DISABLE]	Disables button operations.

■ [SLOT1 BUTTON]

The items from [SDI1 [SLOT1]] to [SDI4 [SLOT1]] can be selected when the optional Interface Board for 12G-SDI (Model No.: ET-MDN12G10) is installed in <SLOT 1>.

[HDMI1 [SLOT1]] and [HDMI2 [SLOT1]] can be selected when the optional Interface Board for HDMI 2 input (Model No.: ET-MDNHM10) is installed in <SLOT 1>.

[DVI-D1 [SLOT1]] and [DVI-D2 [SLOT1]] can be selected when the optional Interface Board for DVI-D 2 input (Model No.: ET-MDNDV10) is installed in <SLOT 1>.

[DisplayPort1 [SLOT1]] and [DisplayPort2 [SLOT1]] can be selected when the optional Interface Board for DisplayPort 2 input (Model No.: ET-MDNDP10) is installed in <SLOT 1>.

[TOGGLE]	Switches the input of the Interface Board installed in <SLOT 1> in turn when the button is operated.
[SDI1 [SLOT1]]	Fixes to selection operation of the SDI1 input of the Interface Board.
[SDI2 [SLOT1]]	Fixes to selection operation of the SDI2 input of the Interface Board.
[SDI3 [SLOT1]]	Fixes to selection operation of the SDI3 input of the Interface Board.
[SDI4 [SLOT1]]	Fixes to selection operation of the SDI4 input of the Interface Board.
[HDMI1 [SLOT1]]	Fixes to selection operation of the HDMI1 input of the Interface Board.
[HDMI2 [SLOT1]]	Fixes to selection operation of the HDMI2 input of the Interface Board.
[DVI-D1 [SLOT1]]	Fixes to selection operation of the DVI-D1 input of the Interface Board.
[DVI-D2 [SLOT1]]	Fixes to selection operation of the DVI-D2 input of the Interface Board.
[DisplayPort1 [SLOT1]]	Fixes to selection operation of the DisplayPort1 input of the Interface Board.
[DisplayPort2 [SLOT1]]	Fixes to selection operation of the DisplayPort2 input of the Interface Board.
[DISABLE]	Disables button operations.

■ [SLOT2 BUTTON]

The items from [SDI1 [SLOT2]] to [SDI4 [SLOT2]] can be selected when the optional Interface Board for 12G-SDI (Model No.: ET-MDN12G10) is installed in <SLOT 2>.

[HDMI3 [SLOT2]] and [HDMI4 [SLOT2]] can be selected when the optional Interface Board for HDMI 2 input (Model No.: ET-MDNHM10) is installed in <SLOT 2>.

[DVI-D3 [SLOT2]] and [DVI-D4 [SLOT2]] can be selected when the optional Interface Board for DVI-D 2 input (Model No.: ET-MDNDV10) is installed in <SLOT 2>.

[DisplayPort3 [SLOT2]] and [DisplayPort4 [SLOT2]] can be selected when the optional Interface Board for DisplayPort 2 input (Model No.: ET-MDNDP10) is installed in <SLOT 2>.

[TOGGLE]	Switches the input of the Interface Board installed in <SLOT 2> in turn when the button is operated.
[SDI1 [SLOT2]]	Fixes to selection operation of the SDI1 input of the Interface Board.
[SDI2 [SLOT2]]	Fixes to selection operation of the SDI2 input of the Interface Board.
[SDI3 [SLOT2]]	Fixes to selection operation of the SDI3 input of the Interface Board.
[SDI4 [SLOT2]]	Fixes to selection operation of the SDI4 input of the Interface Board.
[HDMI3 [SLOT2]]	Fixes to selection operation of the HDMI3 input of the Interface Board.
[HDMI4 [SLOT2]]	Fixes to selection operation of the HDMI4 input of the Interface Board.
[DVI-D3 [SLOT2]]	Fixes to selection operation of the DVI-D3 input of the Interface Board.
[DVI-D4 [SLOT2]]	Fixes to selection operation of the DVI-D4 input of the Interface Board.
[DisplayPort3 [SLOT2]]	Fixes to selection operation of the DisplayPort3 input of the Interface Board.
[DisplayPort4 [SLOT2]]	Fixes to selection operation of the DisplayPort4 input of the Interface Board.
[DISABLE]	Disables button operations.

[CONTROL DEVICE PASSWORD CHANGE]

The control device password can be changed.

- 1) Press ▲▼ to select [CONTROL DEVICE PASSWORD CHANGE].
- 2) Press the <ENTER> button.
 - The [CONTROL DEVICE PASSWORD CHANGE] screen is displayed.
- 3) Press ▲▼◀▶ to select the text, and press the <ENTER> button to enter the text.
- 4) Press ▲▼◀▶ to select [OK], and press the <ENTER> button.
 - To cancel, select [CANCEL].

Attention

- The initial password is “AAAA” by the factory default setting, or after initialized by one of the following methods.
 - When initialized by selecting the [PROJECTOR SETUP] menu → [INITIALIZE] → [FACTORY RESET]
 - When initialized by setting the [PROJECTOR SETUP] menu → [INITIALIZE] → [USER SETTINGS] → [OTHER USER SETTING] to [INITIALIZE]
- Change the password periodically that is hard to guess.
- To initialize your password, consult your distributor.

[NETWORK] menu

On the menu screen, select [NETWORK] from the main menu, and select an item from the sub-menu. Refer to “Navigating through the menu” (➔ page 84) for the operation of the menu screen.

[DIGITAL LINK MODE]

Switch the communication method of the <DIGITAL LINK> terminal of the projector.

- 1) Press ▲▼ to select [DIGITAL LINK MODE].
- 2) Press ◀▶ to switch the item.
 - The items will switch each time you press the button.

[AUTO]	Switches the communication method automatically to DIGITAL LINK, long reach, or Ethernet.
[DIGITAL LINK]	Fixes the communication method to DIGITAL LINK.
[LONG REACH]	Fixes the communication method to long reach.
[ETHERNET]	Fixes the communication method to Ethernet.

Possible communication modes

- ✓: Communication possible
—: Communication not possible

Setting		Communication possible			
		Video transfer (100 m (328'1"))	Video transfer (150 m (492'2"))	Ethernet	RS-232C
[AUTO]	For DIGITAL LINK	✓	—	✓	✓
	For long reach	—	✓	✓	✓
	For Ethernet	—	—	✓*1	—
[DIGITAL LINK]		✓	—	✓	✓
[LONG REACH]		—	✓	✓	✓
[ETHERNET]		—	—	✓*1	—

*1 Communication via a twisted-pair-cable transmitter is not available. Connect the projector to the network directly.

Note

- For the signal with resolution of 1 920 x 1 200 dots or less, the maximum transmission distance is 100 m (328'1") when connected with the DIGITAL LINK communication method. For the signal with the resolution exceeding 1 920 x 1 200 dots, the maximum transmission distance is 50 m (164'1").
- The maximum transmission distance when connected with the long-reach communication method is 150 m (492'2"). In this case, the signal that the projector can receive is only up to 1080/60p (1 920 x 1 080 dots, dot clock frequency 148.5 MHz).
- When the communication method of the twist-pair-cable transmitter is set to long reach, the projector will connect with long-reach communication method when [DIGITAL LINK MODE] is set to [AUTO]. To connect with the optional DIGITAL LINK Switcher (Model No.: ET-YFB200G) with the long-reach communication method, set [DIGITAL LINK MODE] to [LONG REACH].
- Connection will not be made correctly if the twist-pair-cable transmitter is not supporting the long-reach communication method even if [DIGITAL LINK MODE] is set to [LONG REACH].

[DIGITAL LINK STATUS]

Display the DIGITAL LINK connection environment.

- 1) Press ▲▼ to select [DIGITAL LINK STATUS].
- 2) Press the <ENTER> button.
 - The [DIGITAL LINK STATUS] screen is displayed.

[LINK STATUS]	The content of display is as follows. [DIGITAL LINK]: Communicating in the DIGITAL LINK method. [LONG REACH]: Communicating in the long reach method. [ETHERNET]: Communicating in the Ethernet method. [NO LINK]: Communication is not established.
[HDCP STATUS]	The content of display is as follows. [HDCP2.2]: When protected with HDCP 2.2 [HDCP1.X]: When protected with HDCP 1.X [NONE]: When not protected with HDCP [---]: When there is no signal

[SIGNAL QUALITY]	<p>[SIGNAL QUALITY] is a numerical value of the amount of error, and the display color changes to green, yellow, or red depending on that value. Check the signal quality level while receiving a signal from the twisted-pair-cable transmitter.</p> <ul style="list-style-type: none"> • [MAX]/[MIN]: Maximum/minimum value of the amount of error • Green (–12 dB or lower) → normal signal quality level. • Yellow (–11 to –8 dB) → caution level that noise may appear on the screen. • Red (–7 dB or higher) → abnormal level with interrupted synchronization and receiving not possible.
-------------------------	--

[WIRED LAN]

Perform the connection setting to use the wired LAN.

- 1) Press ▲▼ to select [WIRED LAN].
- 2) Press the <ENTER> button.
 - The [WIRED LAN] screen is displayed.
- 3) Press ▲▼ to select an item, and change the settings according to the operation instructions of the menu.

[DHCP]	[ON]	If a DHCP server exists in the network where the projector is to be connected, obtains the IP address automatically.
	[OFF]	If a DHCP server does not exist in the network where the projector is to be connected, set [IP ADDRESS], [SUBNET MASK], and [DEFAULT GATEWAY].
[IP ADDRESS]	Enter the IP address when a DHCP server is not used.	
[SUBNET MASK]	Enter the subnet mask when a DHCP server is not used.	
[DEFAULT GATEWAY]	Enter the default gateway address when a DHCP server is not used.	

- 4) Press ▲▼ to select [STORE], and press the <ENTER> button.
 - The confirmation screen is displayed.
- 5) Press ◀▶ to select [OK], and press the <ENTER> button.

Note

- When using a DHCP server, confirm that the DHCP server is running.
- Consult your network administrator regarding the IP address, subnet mask, and default gateway.
- When [Art-Net SETUP] is set to [ON(2.X.X.X)] or [ON(10.X.X.X)], [WIRED LAN] cannot be selected.
- The network setting is common for the <LAN> terminal and the <DIGITAL LINK> terminal.
- Wired LAN and wireless LAN cannot be used in the same segment.

[WIRELESS LAN]

Set the connection method of wireless LAN and its details.

- To use the wireless LAN function with the projector, it is necessary to attach the optional Wireless Module (Model No.: AJ-WM50 Series) to the <USB> terminal.

- 1) Press ▲▼ to select [WIRELESS LAN].
- 2) Press ◀▶ to switch the item.
 - The items will switch each time you press the button.

[ENABLE]	<p>Select this item when the wireless LAN is to be used. A device such as a smartphone can be directly connected to the projector even if a wireless LAN access point is not set up separately because the projector is used as a simplified access point. For setting procedure of the connection key, refer to “Setting the connection key” (➔ page 192).</p>
[DISABLE]	Select this item when the wireless LAN is not to be used.

Note

- [WIRELESS LAN] cannot be set if the optional Wireless Module (Model No.: AJ-WM50 Series) is not attached to the <USB> terminal.
- Maximum number of devices that can be connected simultaneously to the projector via wireless LAN is four devices.

Setting the connection key

- 1) Press ▲▼ to select [WIRELESS LAN].

- 2) Press ◀▶ to select [ENABLE].
- 3) Press the <ENTER> button.
 - The [WIRELESS LAN] screen is displayed.
- 4) Press ▲▼ to select [KEY].
- 5) Press the <ENTER> button.
 - The [KEY] screen is displayed.
- 6) Press ▲▼◀▶ to select the text, and press the <ENTER> button to enter the text.
 - The character string that can be registered as the connection key is as follows.
 - 8 to 15 single-byte alphanumeric characters
- 7) After entering the connection key, press ▲▼◀▶ to select [OK], and press the <ENTER> button.
- 8) Press ▲▼ to select [STORE], and press the <ENTER> button.
 - The confirmation screen is displayed.
- 9) Press ◀▶ to select [OK], and press the <ENTER> button.

Note

- The factory default setting of the connection key is "spjcxxxx". xxxx is the four digit number assigned for each product.

[PROJECTOR NAME]

Change the projector name. Enter the host name if it is required to use a DHCP server.

- 1) Press ▲▼ to select [PROJECTOR NAME].
- 2) Press the <ENTER> button.
 - The [PROJECTOR NAME CHANGE] screen is displayed.
- 3) Press ▲▼◀▶ to select the text, and press the <ENTER> button to enter the text.
 - Up to 16 characters can be entered.
- 4) After entering the projector name, press ▲▼◀▶ to select [OK], and press the <ENTER> button.
 - To cancel, select [CANCEL].

Note

- The factory default setting of the projector name is "NAMExxxx". xxxx is the four digit number assigned for each product.

[NETWORK CONTROL]

Set up the control method of the network.

- 1) Press ▲▼ to select [NETWORK CONTROL].
- 2) Press the <ENTER> button.
 - The [NETWORK CONTROL] screen is displayed.
- 3) Press ▲▼ to select an item, and press ◀▶ to change the setting.

[WEB CONTROL]	Set to [ON] to control with the web browser.
[PJLink CONTROL]	Set to [ON] to control with the PJLink protocol.
[PJLink NOTIFICATION]	Set to [ON] to use the PJLink notification function. <ul style="list-style-type: none"> • The [PJLink NOTIFICATION] screen is displayed when set to [ON] and the <ENTER> button is pressed. Set the IP address of the computer to notify the status of the projector in [NOTIFIED IP ADDRESS 1], [NOTIFIED IP ADDRESS 2].
[COMMAND CONTROL]	Set to [ON] to control with the <SERIAL IN>/<SERIAL OUT> terminal control command format (➡ page 272). Refer to "Control commands via LAN" (➡ page 266).
[COMMAND PORT]	Set the port number used for command control.
[Crestron Connected(TM)]	Set to [ON] to control with Crestron Connected of Crestron Electronics, Inc.
[AMX D.D.]	Set to [ON] to control with the controller of AMX Corporation. Setting this function to [ON] enables detection through "AMX Device Discovery". For details, visit the website of AMX Corporation. URL http://www.amx.com/

[EXTRON XTP]	Set to [ON] when connecting the "XTP transmitter" of Extron Electronics to the <DIGITAL LINK> terminal. The [EXTRON XTP] setting must be set to [OFF] when connecting the optional DIGITAL LINK output supported device (Model No.: ET-YFB100G, ET-YFB200G). For details of the "XTP transmitter", visit the website of Extron Electronics. URL http://www.extron.com/	
[TYPE SELECT]	[LAN]	Select this item when using only the <LAN> terminal to transmit the Ethernet signal.
	[DIGITAL LINK]	Select this item when using only the <DIGITAL LINK> terminal to transmit the Ethernet signal.
	[LAN & DIGITAL LINK]	Select this item when using the <DIGITAL LINK> terminal and the <LAN> terminal to transmit the Ethernet signal.

4) Press ▲▼ to select [STORE], and press the <ENTER> button.

- The confirmation screen is displayed.

5) Press ◀▶ to select [OK], and press the <ENTER> button.

Note

- When [TYPE SELECT] is set to [LAN], the Ethernet and serial control signals cannot be transmitted via the optional DIGITAL LINK output supported device (Model No.: ET-YFB100G, ET-YFB200G) connected to the <DIGITAL LINK> terminal.
- When [TYPE SELECT] is set to [LAN & DIGITAL LINK], the <DIGITAL LINK> terminal and the <LAN> terminal are connected inside the projector. Do not directly connect the <DIGITAL LINK> terminal and the <LAN> terminal using a LAN cable. Construct the system so that it is not connected to the same network via the peripherals such as the hub or the twisted-pair-cable transmitter.

[NETWORK STATUS]

Display the network information of the projector.

1) Press ▲▼ to select [NETWORK STATUS].

2) Press the <ENTER> button.

- The [NETWORK STATUS] screen is displayed.

3) Press ◀▶ to switch the display screen.

- The page will change each time you press the button.

[WIRED LAN] (page 1/3), [WIRELESS LAN] (page 2/3), [WIRELESS LAN] (page 3/3)

[WIRED LAN]	[DHCP]	Displays the status of use of the DHCP server.
	[IP ADDRESS]	Displays the [IP ADDRESS].
	[SUBNET MASK]	Displays the [SUBNET MASK].
	[DEFAULT GATEWAY]	Displays the [DEFAULT GATEWAY].
	[DNS1]	Displays the address of the preferred DNS server.
	[DNS2]	Displays the address of the alternate DNS server.
	[MAC ADDRESS]	Displays the [MAC ADDRESS] of wired LAN.
[WIRELESS LAN]	[SSID]	Displays the string of SSID.
	[KEY]	Displays the connection key. Displays/hides the connection key by pressing the <ENTER> button.
	[AUTHENTICATION]	Displays the user authentication method.
	[ENCRYPTION]	Displays the encryption method.
	[IP ADDRESS]	Displays the [IP ADDRESS].
	[SUBNET MASK]	Displays the [SUBNET MASK].
	[MAC ADDRESS]	Displays the [MAC ADDRESS] of wireless LAN.

Note

- The [WIRELESS LAN] page in [NETWORK STATUS] screen is not displayed in following cases.
 - When the optional Wireless Module (Model No.: AJ-WM50 Series) is not attached to the <USB> terminal
 - When the [NETWORK] menu → [WIRELESS LAN] is set to [DISABLE]

[DIGITAL LINK MENU]

When the optional DIGITAL LINK output supported device (Model No.: ET-YFB100G, ET-YFB200G) is connected to the <DIGITAL LINK> terminal, the main menu of the connected DIGITAL LINK output supported device is displayed. Refer to the Operating Instructions of the DIGITAL LINK output supported device for details.

Note

- [DIGITAL LINK MENU] cannot be selected when [EXTRON XTP] is set to [ON].
- The operation guidance for the "RETURN" button is in the menu screen of the Digital Interface Box and DIGITAL LINK Switcher. The projector does not have the "RETURN" button, but the same operation is available with the <MENU> button.

[Art-Net SETUP]

Make settings to use the Art-Net function.

- 1) Press ▲▼ to select [Art-Net SETUP].
- 2) Press ◀▶ to switch the item.
 - The items will switch each time you press the button.

[OFF]	Disables the Art-Net function.
[ON(2.X.X.X)]	Enables the Art-Net function and sets the IP address to 2.X.X.X.
[ON(10.X.X.X)]	Enables the Art-Net function and sets the IP address to 10.X.X.X.
[ON(MANUAL)]	Enables the Art-Net function and uses the IP address set in [NETWORK SETUP].

- Proceed to Step 3) when anything other than [OFF] is selected.

- 3) Press the <ENTER> button.
 - The [Art-Net SETUP] screen is displayed.
- 4) Press ▲▼ to select an item, and press ◀▶ to switch the setting.

[NET]	Enter [NET] to be used when the projector processes Art-Net.
[SUB NET]	Enter [SUB NET] to be used when the projector processes Art-Net.
[UNIVERSE]	Enter [UNIVERSE] to be used when the projector processes Art-Net.
[START ADDRESS]	Enter [START ADDRESS] to be used when the projector processes Art-Net.

- 5) Press ▲▼ to select [STORE], and press the <ENTER> button.
 - The confirmation screen is displayed.
- 6) Press ◀▶ to select [OK], and press the <ENTER> button.

Note

- If [ON(2.X.X.X)] or [ON(10.X.X.X)] is selected, IP address is calculated and set automatically.

[Art-Net CHANNEL SETTING]

Set the assignment of the channel.

For the channel definitions used for controlling the projector with the Art-Net function, refer to "Using Art-Net function" (➡ page 261).

- 1) Press ▲▼ to select [Art-Net CHANNEL SETTING].
- 2) Press ◀▶ to switch the item.
 - The items will switch each time you press the button.

[2]	Uses the channel assignment in standard setting.
[3]	Uses the channel assignment with the setting that can numerically control the lens position.
[USER]	Changes the channel assignment.
[1]	Uses the channel assignment with DZ21K series compatible. DZ21K series: DZ21K series, DS20K series, DW17K series, DZ16K series

- When anything other than [USER] is selected, the function assigned to the channel is displayed by pressing the <ENTER> button.
- Proceed to Step 3) when [USER] is selected.

- 3) Press the <ENTER> button.
 - The [Art-Net CHANNEL SETTING] screen is displayed.
- 4) Press ▲▼ to select the channel to set, and press ◀▶ to switch the item.

[LIGHT OUTPUT]	Adjusts the amount of light.
----------------	------------------------------

[INPUT SELECT]	Switches the input.
[LENS POSITION]	Moves the lens position.
[LENS H SHIFT]	Adjusts the lens shift in the horizontal direction.
[LENS V SHIFT]	Adjusts the lens shift in the vertical direction.
[LENS FOCUS]	Adjusts the focus.
[LENS ZOOM]	Adjusts the zoom.
[POWER]	Controls the power status.
[SHUTTER]	Controls the shutter.
[FADE-IN]	Sets the fade-in time.
[FADE-OUT]	Sets the fade-out time.
[GEOMETRY]	Performs geometric adjustment.
[FREEZE]	Freezes the projected image.
[COLOR]	Adjusts the color saturation.
[TINT]	Adjusts the tint.
[RASTER PATTERN]	Displays the raster pattern.
[LENS H SHIFT MSB]	Coarsely adjusts the horizontal position of the lens.
[LENS H SHIFT LSB]	Finely adjusts the horizontal position of the lens.
[LENS V SHIFT MSB]	Coarsely adjusts the vertical position of the lens.
[LENS V SHIFT LSB]	Finely adjusts the vertical position of the lens.
[LENS FOCUS MSB]	Coarsely adjusts the focus position of the lens.
[LENS FOCUS LSB]	Finely adjusts the focus position of the lens.
[LENS ZOOM MSB]	Coarsely adjusts the zoom position of the lens.
[LENS ZOOM LSB]	Finely adjusts the zoom position of the lens.
[ENABLE/DISABLE]	Enables/disables the control of the projector with the Art-Net function.
[NONE]	No definition

- The setting can be also made by pressing ▲▼ to select the channel, pressing the <ENTER> button to display the item list, pressing ▲▼◀▶ to select the item, and pressing the <ENTER> button.
- Same item cannot be set for multiple channels, except for [NONE].

Note

- Assign each item of [LENS H SHIFT MSB], [LENS V SHIFT MSB], [LENS FOCUS MSB], and [LENS ZOOM MSB] to a channel together with [LENS H SHIFT LSB], [LENS V SHIFT LSB], [LENS FOCUS LSB], and [LENS ZOOM LSB]. These cannot be used when assigned to a channel by itself.
- Assign each item of [LENS H SHIFT LSB], [LENS V SHIFT LSB], [LENS FOCUS LSB], and [LENS ZOOM LSB] to a channel together with [LENS H SHIFT MSB], [LENS V SHIFT MSB], [LENS FOCUS MSB], and [LENS ZOOM MSB]. These cannot be used when assigned to a channel by itself.
- **MSB:** Most Significant Byte
- **LSB:** Least Significant Byte

[Art-Net STATUS]

Display the content of control assigned to each channel and the received data of that channel.

- 1) Press ▲▼ to select [Art-Net STATUS].
- 2) Press the <ENTER> button.
 - The [Art-Net STATUS] screen is displayed.

Chapter 5 Operations

This chapter describes how to use each function.

Network connection

The projector is equipped with the network function, and following is possible by connecting to a computer.

- **Web control**

Setting, adjustment, and displaying status of the projector are possible by accessing the projector from a computer.

Refer to “Web control function” (➔ page 202) for details.

- **Smart Projector Control**

The application software “Smart Projector Control” can be used, which enables to set and adjust the projector connected via LAN using a smartphone or tablet device.

Visit the Panasonic website (<https://panasonic.net/cns/projector/>) for details.

- **Multi Monitoring & Control Software**

“Multi Monitoring & Control Software”, a software application to monitor and control multiple display devices (projector or flat panel display) connected to intranet, can be used.

Plug-in software “Early Warning Software”, which monitors the status of the display devices and their peripherals within an intranet, and notifies of abnormality of such equipment and detects the signs of possible abnormality, can also be used.

For details, visit the Panasonic website (<https://panasonic.net/cns/projector/>).

- **PJLink**

Operation or status query of the projector can be performed from a computer using the PJLink protocol.

Refer to “PJLink protocol” (➔ page 259) for details.

- **Art-Net**

Setting of the projector can be operated by the DMX controller or application software using the Art-Net protocol.

Refer to “Using Art-Net function” (➔ page 261) for details.

- **Command control**

Operation or status query of the projector can be performed from a computer using the control command.

Refer to “Control commands via LAN” (➔ page 266) for details.

Connecting via wired LAN

This projector can receive the Ethernet signal from the twisted-pair-cable transmitter together with the video and serial control signal via the LAN cable.

Example of general network connection

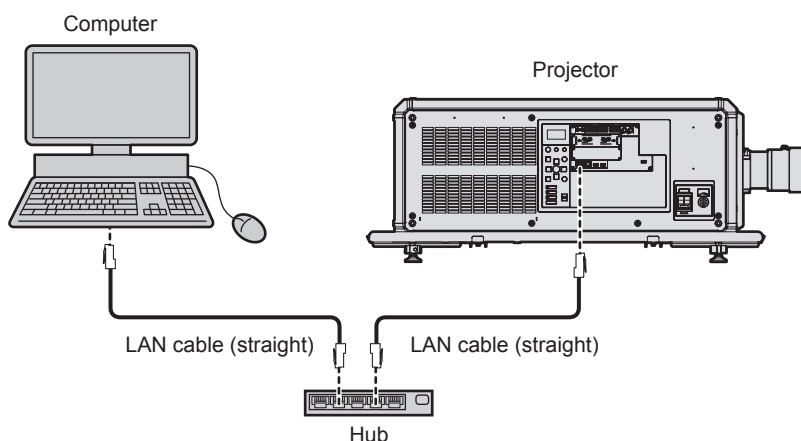

Attention

- When a LAN cable is directly connected to the projector, the network connection must be made indoors.

Note

- A LAN cable is required to use the network function.
- Use a straight or crossover LAN cable that is compatible with CAT5 or higher. Either the straight or the crossover cable, or both cables can be used depending on the system configuration. Consult your network administrator. The projector will determine the type of the cable (straight or crossover) automatically.
- Use a LAN cable of 100 m (328'1") or shorter.

Example of network connections via a twisted-pair-cable transmitter

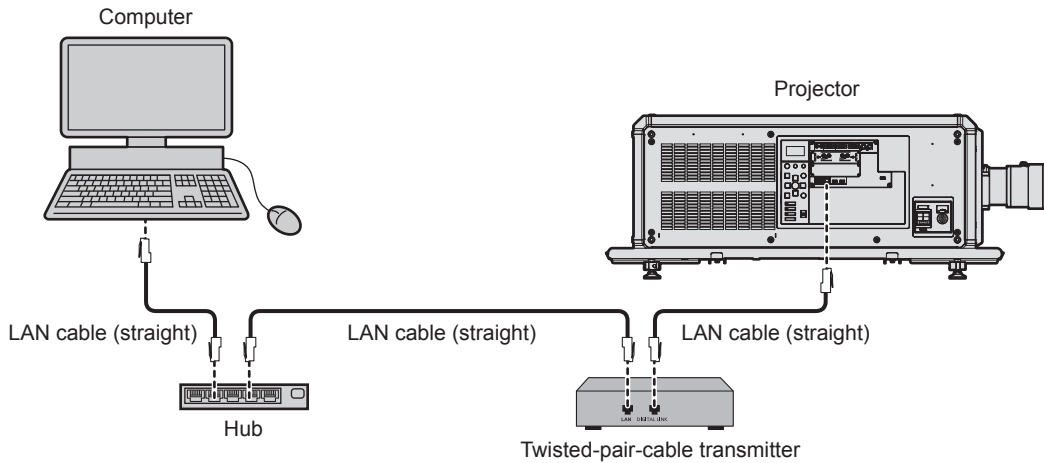

Attention

- When a LAN cable is directly connected to the projector, the network connection must be made indoors.

Note

- For the LAN cable between the twisted-pair-cable transmitter and the projector, use a cable that meets the following criteria:
 - Conforming to CAT5e or higher standards
 - Shielded type (including connectors)
 - Straight-through
 - Single wire
 - Diameter of the cable core is same or larger than AWG24 (AWG24, AWG23, etc.)
- The maximum transmission distance between the twisted-pair-cable transmitter and the projector is 100 m (328'1") for the signal with resolution of 1 920 x 1 200 dots or less. For the signal with the resolution exceeding 1 920 x 1 200 dots, the maximum transmission distance is 50 m (164'1"). It is possible to transmit up to 150 m (492'2") if the twisted-pair-cable transmitter supports the long-reach communication method. However, the signal that the projector can receive is only up to 1080/60p (1 920 x 1 080 dots, dot clock frequency 148.5 MHz) for the long-reach communication method. If these distances are exceeded, image may be disrupted or a malfunction may occur in LAN communication.
- When laying cables between the twisted-pair-cable transmitter and the projector, confirm that cable characteristics are compatible with CAT5e or higher using tools such as a cable tester or cable analyzer. When a relay connector is used, include it in the measurement.
- Do not use a hub between the twisted-pair-cable transmitter and the projector.
- To transmit the Ethernet and serial control signals using the <DIGITAL LINK> terminal, set the [NETWORK] menu → [NETWORK CONTROL] → [TYPE SELECT] to [DIGITAL LINK] or [LAN & DIGITAL LINK].
- To transmit the Ethernet signal using the <LAN> terminal, set the [NETWORK] menu → [NETWORK CONTROL] → [TYPE SELECT] to [LAN] or [LAN & DIGITAL LINK].
- The <DIGITAL LINK> terminal and the <LAN> terminal are connected inside of the projector when the [NETWORK] menu → [NETWORK CONTROL] → [TYPE SELECT] is set to [LAN & DIGITAL LINK]. Do not directly connect the <DIGITAL LINK> terminal and the <LAN> terminal using a LAN cable. Construct the system so that it is not connected to the same network via the peripherals such as the hub or the twisted-pair-cable transmitter.
- Do not pull cables forcefully. Also, do not bend or fold cables unnecessarily.
- To reduce the effects of noise as much as possible, stretch out the cables between the twisted-pair-cable transmitter and the projector without any loops.
- Lay the cables between the twisted-pair-cable transmitter and the projector away from other cables, particularly power cables.
- When laying multiple cables, run them side by side along the shortest distance possible without bundling them together.
- After laying the cables, go to the [NETWORK] menu → [DIGITAL LINK STATUS] and confirm that the value of [SIGNAL QUALITY] is displayed in green which indicates normal quality.
- For twisted-pair-cable transmitters of other manufacturers of which the operation has been verified with the projector, visit the Panasonic website (<https://panasonic.net/cns/projector/>). Note that the verification for devices of other manufacturers has been made for the items set by Panasonic Corporation, and not all the operations have been verified. For operation or performance problems caused by the devices of other manufacturers, contact the respective manufacturers.

Setting the projector

- 1) **Connect the projector to a computer using a LAN cable.**
- 2) **Turn on the power of the projector.**
- 3) **Press the <MENU> button to open the [NETWORK] menu from the main menu.**
 - The [NETWORK] screen is displayed.

- 4) Press ▲▼ to select [WIRED LAN], and press the <ENTER> button.
 - The [WIRED LAN] screen is displayed.
- 5) Perform the [WIRED LAN] setting.
 - Refer to [WIRED LAN] (➔ page 192) for details.

Note

- To connect to an existing network, perform after consulting your network administrator.

■ Factory default setting

- Following setting has been made as a factory default.

[DHCP]	OFF
[IP ADDRESS]	192.168.0.8
[SUBNET MASK]	255.255.255.0
[DEFAULT GATEWAY]	192.168.0.1
[DNS1]/[DNS2]	None

Operating the computer

- 1) Turn on the power of the computer.
- 2) Perform the network setting following the instruction of your network administrator.
 - Operation from the computer is possible by configuring the network setting of the computer as follows if the projector is in the factory default setting.

[IP ADDRESS]	192.168.0.10
[SUBNET MASK]	255.255.255.0
[DEFAULT GATEWAY]	192.168.0.1

Connecting via wireless LAN

To use the wireless LAN function with the projector, it is necessary to attach the optional Wireless Module (Model No.: AJ-WM50 Series) to the <USB> terminal.

Connecting example

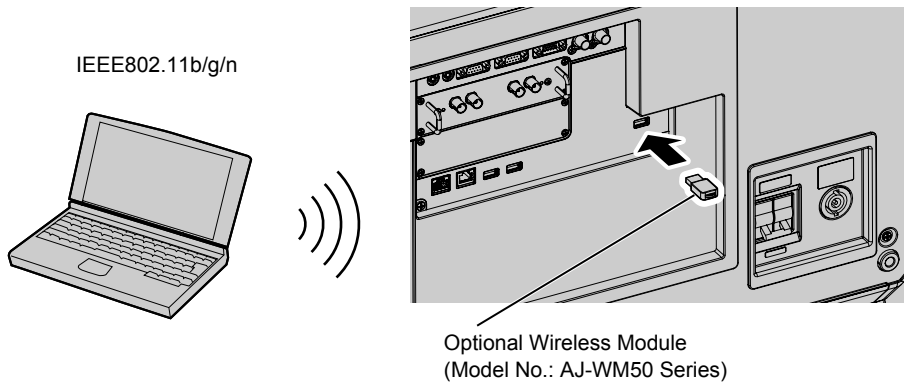

Preparing and confirming the projector

- 1) Insert the optional Wireless Module (Model No.: AJ-WM50 Series) all the way into the <USB> terminal.
- 2) Turn on the projector.
- 3) Press the <MENU> button to open the [NETWORK] menu from the main menu.
 - The [NETWORK] screen is displayed.
- 4) Press ▲▼ to select [WIRELESS LAN], and press the <ENTER> button.
 - The [WIRELESS LAN] screen is displayed.

- 5) Press ◀▶ to set [ENABLE].
 - For details, refer to [WIRELESS LAN] (▶ page 192).
- 6) Press the <MENU> button.
 - The [NETWORK] screen is displayed.
- 7) Press ▲▼ to select [NETWORK STATUS], and press the <ENTER> button.
 - The [NETWORK STATUS] screen is displayed.
- 8) Press ◀▶ to display [WIRELESS LAN] (page 2/3).
 - Confirm [SSID] and [KEY].

Note

- [WIRELESS LAN] cannot be set if the optional Wireless Module (Model No.: AJ-WM50 Series) is not attached to the <USB> terminal.
- Attach the Wireless Module to the <USB> terminal directly without using a USB extension cable or USB hub.
- The indicator on the Wireless Module blinks in blue while the main power of the projector is turned on.
- If the indicator on the Wireless Module does not blink even when the projector is turned on, re-insert the Wireless Module into the <USB> terminal.

Operating the computer

- 1) Turn on the computer.
- 2) Perform the network setting.
 - Perform the network setting on the computer following the instruction of the network administrator so that it can be connected to the projector.
- 3) Connect the Wireless Module to the projector via wireless LAN.
 - When connecting, confirm the [WIRELESS LAN] setting displayed in the [NETWORK STATUS] screen of the projector.

Web control function

Following operation is possible from a computer using the web control function.

- Setting and adjustment of the projector
- Display of the projector status
- Sending E-mail messages when there is a problem with the projector

The projector supports “Crestron Connected”, and the following application software of Crestron Electronics, Inc. can be used.

- RoomView Express
- Crestron Fusion

Note

- Communication with an E-mail server is required to use the E-mail function. Confirm that the E-mail can be used beforehand.
- “Crestron Connected” is a system of Crestron Electronics, Inc. that collectively manages and controls devices on multiple systems connected to a network using a computer.
- For details of the “Crestron Connected”, visit the website of Crestron Electronics, Inc. (English only.)
URL <https://www.crestron.com/>
Download “RoomView Express” from the Crestron Electronics, Inc. website. (English only.)
URL <https://www.crestron.com/en-US/resources/get-roomview>

Computer that can be used for setting

To use the web control function, a web browser is required. Confirm that the web browser can be used in advance.

OS	Compatible browser
Windows	Internet Explorer 11.0, Microsoft Edge
Mac OS	Safari 10.0/11.0/12.0
iOS	Safari (equipped with version iOS 10, iOS 11, iOS 12, or iOS 13)
Android	Google Chrome (equipped with version Android 6.0/7.0/8.0/9.0/10.0)

Accessing from the web browser

- 1) Start up the web browser on the computer.
- 2) Enter the IP address set on the projector into the URL entry field of the web browser.
- 3) Enter the user name and the password.
 - The factory default settings are User name: dispuser (user rights)/dispadmin (administer rights); Password: @Panasonic.
 - Change of password is prompted when using the web control function for the first time. Proceed to Step 4). If the web control function is used already, proceed to Step 7).

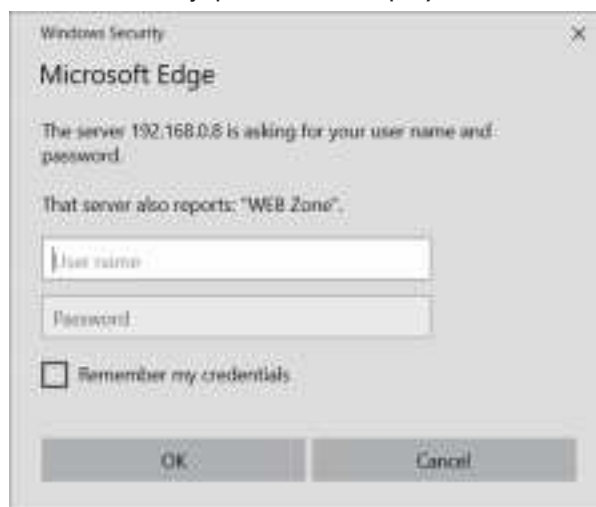

4) Click OK.

- The [Change password] page is displayed.

For user rights



For administrator rights



5) Enter the new user name and password, and click [Change].

- The screen in Step 3) is displayed again.

6) Enter the new user name and password.

- Enter the new user name and password set in Step 5).

7) Click OK.

Attention

- The entry screen for the user name and password may be hidden by other window that is already opened. In such case, minimize the window in front to display the entry screen.

Note

- If you use a web browser to control the projector, set the [NETWORK] menu → [NETWORK CONTROL] → [WEB CONTROL] to [ON].
- Do not perform setting or control simultaneously by starting up multiple web browsers. Do not set or control the projector from multiple computers.
- Access will be locked for few minutes when an incorrect password is entered three times consecutively.
- Some items on the projector setting page use the Javascript function of the web browser. Correct control may not be possible when the web browser is set not to use this function.
- If the screen for the web control is not displayed, consult your network administrator.
- While updating the screen for the web control, the screen may appear white for a moment, but it is not a malfunction.
- When the projector is already registered in application software (such as “Multi Monitoring & Control Software” and “Smart Projector Control”) which uses the communication control via LAN, communication with the projector will become impossible if a user name or password for [Administrator] is changed. If a user name or password for [Administrator] is changed, update the registration information of the application software in use.
- Screenshot of a computer
The size or the display of the screen may be different from this manual depending on the OS or the web browser, or the type of computer in use.

Rights for each account

The administrator rights allow use of all functions. There is a limitation in the rights that can be used with the user rights. Select the rights depending on the purpose.

The function that has ✓ in the administrator rights/user rights column indicates that it can be operated with that rights.

Item	Function	Administrator rights	User rights	Page
[Status]	[Remote preview]	✓	✓*1	205
	[Projector status]	✓	✓	208
	Error information page	✓	✓	209
	[Network status]	✓	✓	209
	[Access error log]	✓	—	209
	[Mail error log]	✓	—	210
[Projector control]	[Basic control]	✓	✓	210
	[Detail control]	✓	—	211
[Detailed set up]	[Network config]	✓	—	212
	[Adjust clock]	✓	—	214
	[Ping test]	✓	—	214
	[Https set up]	✓	—	215
	[E-mail set up]	✓	—	221
	[Authentication set up]	✓	—	222
	[User function set up]	✓	—	224
[Change password]	User name of [Administrator]	✓	—	225
	User name of [User]	✓	—	225
	Password of [Administrator]	✓	—	225
	Password of [User]	✓	✓	225, 226
[Crestron Connected(TM)]	Operation page	✓	—	226
	[Tools]	✓	—	227
	[Info]	✓	—	227
	[Help]	✓	—	228

*1 Available only when [Detailed set up] → [User function set up] → [Remote preview] is set to [ENABLE]. When [Invalid] is set, the [Remote preview] page cannot be displayed or operated with user rights.

Descriptions of items



- 1 **Page tab**
Switches pages by clicking this item.
- 2 **[Status]**
The status of the projector is displayed by clicking this item.
- 3 **[Projector control]**
The [Projector control] page is displayed by clicking this item.
- 4 **[Detailed set up]**
The [Detailed set up] page is displayed by clicking this item.
- 5 **[Change password]**
The [Change password] page is displayed by clicking this item.
- 6 **[Crestron Connected(TM)]**
The operation page of Crestron Connected is displayed by clicking this item.

[Remote preview] page

The output image from the projector can be simply viewed on the web control screen.
Click [Status] → [Remote preview].

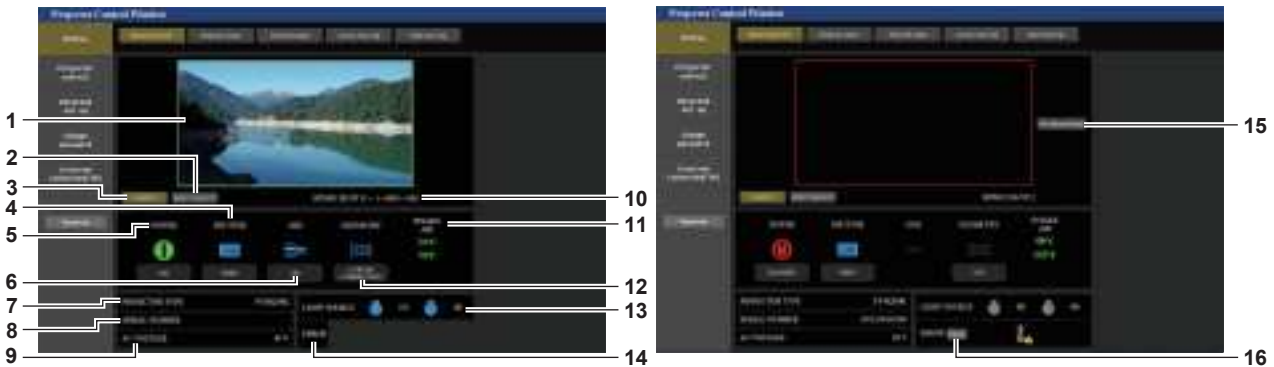



















- 1 **Preview window**
Simply displays the output image equivalent to the projected image from the projector.
Color of the outside border of the preview window indicates the projection status from the projector.
Red: Image from the projector is not projected.
Green: Image from the projector is being projected.
- 2 **[INPUT SELECT]**
Displays the operation menu for switching input.
For details, refer to "Switching the input" (➡ page 207).
- 3 **[STATUS]**
Displays the status of the projector.
- 4 **[SHUTTER]**
Displays the status of the shutter.
- 5 **[POWER]**
Displays the status of the power.
- 6 **[OSD]**
Displays the status of the on-screen display function.
- 7 **[PROJECTOR TYPE]**
Displays the type of the projector.
- 8 **[SERIAL NUMBER]**
Displays the serial number of the projector.
- 9 **[AC VOLTAGE]**
Displays the input supply voltage.
- 10 **Signal information**
Displays the signal information of the selected input.
- 11 **[INTAKE AIR]**
Displays the intake air temperature of the projector in Celsius and Fahrenheit.
- 12 **[GEOMETRY]**
Displays the setting of the [POSITION] menu → [GEOMETRY].
- 13 **[LIGHT SOURCE]**
Displays the illumination status (icon) and the runtime of the light source 1 and the light source 2.
- 14 **[ERROR]**
Displays the occurrence status of error/warning in icon.
This will be blank if there is no occurrence of error/warning.
- 15 **[Pre-Show Mode]**
Switches the Pre-Show mode.
In the Pre-Show mode, the output image of the projector can be viewed without projecting even if the projector is in the standby status.
[Pre-Show Mode] is not displayed in the projection mode.
- 16 **[Detail]**
A button is displayed when there is an occurrence of error/warning.
Click "Error information page" (➡ page 209) to display.

Note

- The power indicator <ON (G)/STANDBY (R)> blinks in red in frequency of 2.95 seconds illuminating → 0.25 seconds off during the Pre-Show mode.

- In addition to the display setting items of the [PROJECTOR SETUP] menu → [INFO MONITOR SETTING] → [USER VIEW], the text of “Pre-Show Mode” is displayed in the information monitor of the projector during the Pre-Show mode.
- The runtime in [PROJECTOR RUNTIME] continues to add up even if the projector is in the standby status while in the Pre-Show mode.

■ Status display icon

[POWER]		The power is switched off. (Standby status)
		In the projection mode
[SHUTTER]		The shutter function is enabled (shutter: closed).
		The shutter function is disabled (shutter: opened).
[OSD]		The on-screen display is set to on (display).
		The on-screen display is set to off (hide).
[GEOMETRY]		The [POSITION] menu → [GEOMETRY] is set to [OFF].
		The [POSITION] menu → [GEOMETRY] is set to [KEYSTONE].
		The [POSITION] menu → [GEOMETRY] is set to [CORNER/PINCUSHION].
		The [POSITION] menu → [GEOMETRY] is set to [CURVED CORRECTION].
		The [POSITION] menu → [GEOMETRY] is set to [PC-1].
		The [POSITION] menu → [GEOMETRY] is set to [PC-2].
		The [POSITION] menu → [GEOMETRY] is set to [PC-3].
[LIGHT SOURCE]		Corresponding light source is illuminated.
		Corresponding light source is not illuminated.
[ERROR]		The light source is in warning status.
		The light source is in error status.
		The temperature is in warning status.
		The temperature is in error status.
		A warning other than light source or temperature has occurred.
		An error other than light source or temperature has occurred.

Switching the input

Click [INPUT SELECT] in the [Remote preview] page.



1 [INPUT SELECT]

Switches to the input to view the image.
The display content for the input selection button varies depending on the Interface Board installed in the slot.

2 [INPUT]

Displays the input terminal currently selected.

3 [SIGNAL NAME]

Displays the input signal name.

4 [SIGNAL FREQUENCY]

Displays the frequency of the input signal.

Note

- View the input image in the standby image confirmation mode, and turn on the power in [Projector control] → [Basic control] page/[Detail control] page if there is no problem to project.
- The power indicator <ON (G)/STANDBY (R)> blinks alternately in red and green during the standby image confirmation mode.
- [PROJECTOR RUNTIME] continues to add up while in the standby image confirmation mode.

[Projector status] page

Click [Status] → [Projector status].

Display the status of the projector for the following items.

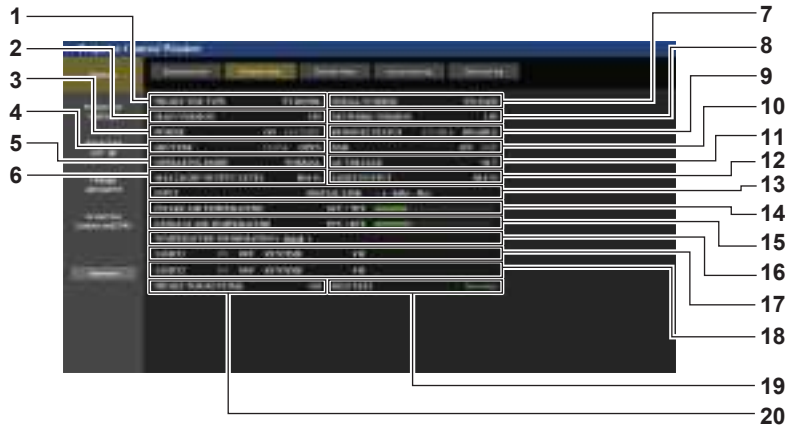

- | | |
|---|---|
| <p>1 [PROJECTOR TYPE]
Displays the type of the projector.</p> <p>2 [MAIN VERSION]
Displays the main version of the firmware of the projector.</p> <p>3 [POWER]
Displays the status of the power.</p> <p>4 [SHUTTER]
Displays the status of the shutter. ([CLOSE]: Shutter function enabled; [OPEN]: Shutter function disabled)</p> <p>5 [OPERATING MODE]
Displays the setting status of [OPERATING MODE].</p> <p>6 [MAX LIGHT OUTPUT LEVEL]
Displays the setting status of [MAX LIGHT OUTPUT LEVEL].</p> <p>7 [SERIAL NUMBER]
Displays the serial number of the projector.</p> <p>8 [NETWORK VERSION]
Displays the network version of the firmware of the projector.</p> <p>9 [REMOTE2 STATUS]
Displays the control status of the <REMOTE 2 IN> terminal.</p> <p>10 [OSD]
Displays the status of on-screen display function. ([ON]: Display; [OFF]: Hide)</p> | <p>11 [AC VOLTAGE]
Displays the input supply voltage.</p> <p>12 [LIGHT OUTPUT]
Displays the setting status of [LIGHT OUTPUT].</p> <p>13 [INPUT]
Displays the status of the selected input.</p> <p>14 [INTAKE AIR TEMPERATURE]
Displays the status of the intake air temperature of the projector.</p> <p>15 [EXHAUST AIR TEMPERATURE]
Displays the status of the exhaust air temperature of the projector.</p> <p>16 [TEMPERATURE INFORMATION]
Click [Detail] to display the temperature status for each part of the projector.</p> <p>17 [LIGHT1]
Displays the lighting status and runtime of light source 1.</p> <p>18 [LIGHT2]
Displays the lighting status and runtime of light source 2.</p> <p>19 [SELF TEST]
Displays the self-diagnosis information.</p> <p>20 [PROJECTOR RUNTIME]
Displays the runtime of the projector.</p> |
|---|---|

Error information page

When [Error (Detail)] or [Warning (Detail)] is displayed in the [SELF TEST] display field of the [Projector status] screen, click it to display the content of the error/warning.

- The projector may go into the standby status to protect the projector depending on the contents of the error.



1 Display of error information
 Displays the alphanumeric symbols and content of errors/warnings that occur.
 Refer to "Self-diagnosis display" (➔ page 256) for the display details.

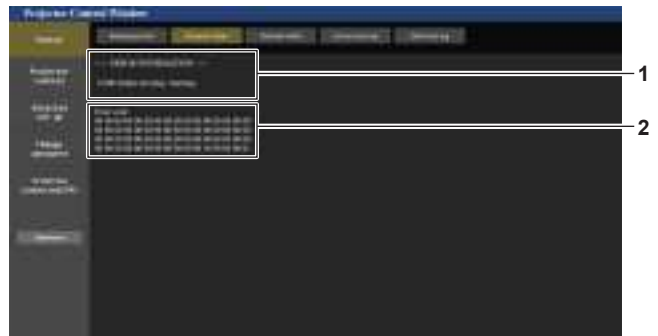

2 Error code

[Network status] page

Click [Status] → [Network status].
 The current network setting status is displayed.



1 [WIRED LAN]
 Displays the settings of wired LAN.



2 [WIRELESS LAN]
 Displays the settings of wireless LAN when the optional Wireless Module (Model No.: AJ-WM50 Series) is attached.

[Access error log] page

Click [Status] → [Access error log].
 The error log on the web server is displayed such as access to the pages that do not exist or access with unauthorized user names or passwords.



[Mail error log] page

Click [Status] → [Mail error log].

E-mail error log is displayed if periodic E-mail sending has failed.



Note

- [Access error log] and [Mail error log] display the recent few thousand accesses/requests. All information may not be displayed when many accesses/requests are made at once.
- Logs in [Access error log] and [Mail error log] are deleted from the oldest when exceeding a certain amount.
- Check [Access error log] and [Mail error log] periodically.

[Basic control] page

Click [Projector control] → [Basic control].

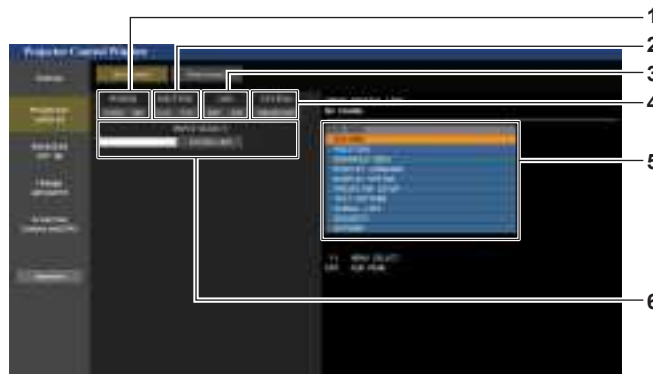

- | | |
|---|--|
| <p>1 [POWER]
Turns off/on the power.</p> <p>2 [SHUTTER]
Switches the status of the shutter. ([CLOSE]: Shutter function enabled; [OPEN]: Shutter function disabled)</p> <p>3 [OSD]
Switches the status of the on-screen display function. ([OFF]: Hide; [ON]: Display)</p> <p>4 [SYSTEM]
Switches the system method.</p> | <p>5 On-screen display of the projector
Displays the same items as shown on the on-screen display of the projector. You can check or change the settings of the menus. It is displayed even if the on-screen display function is set to off (hide).</p> <p>6 [INPUT SELECT]
Switches the input of the image to project. The display content for the input selection button varies depending on the optional Interface Board installed in the slot.</p> |
|---|--|

[Detail control] page

Click [Projector control] → [Detail control].



- | | |
|---|---|
| <p>1 Control of the projector
The projector is controlled by clicking the buttons in the same way as the buttons on the remote control. After control, the on-screen display of the projector at the right of the control page is updated.</p> <p>2 [SUB MEMORY]
Switches the sub memory.</p> <p>3 [SYSTEM DAYLIGHT VIEW]
Switches to system daylight view settings.</p> <p>4 [FREEZE]
Temporarily pauses the image.</p> <p>5 [WAVEFORM MONITOR]
Displays the waveform of the input signal.</p> <p>6 [PROJECTION METHOD]
Switches the setting of the projection method.</p> | <p>7 [LENS]
Displays the [LENS] page.</p> <p>8 [TEST PATTERN]
Displays the test pattern.
Click the test pattern to display in the projected image from the patters displayed on the right side of the control page.
The display of the test pattern disappears if [Exit] is clicked.</p> <p>9 [GEOMETRY]
Switches the geometric adjustment setting.</p> <p>10 [OSD POSITION]
Switches the OSD position setting.</p> <p>11 [GET OSD]
Updates the on-screen display of the projector at the right of the control page.</p> |
|---|---|

[LENS] page

Click [Projector control] → [Detail control] → [LENS].

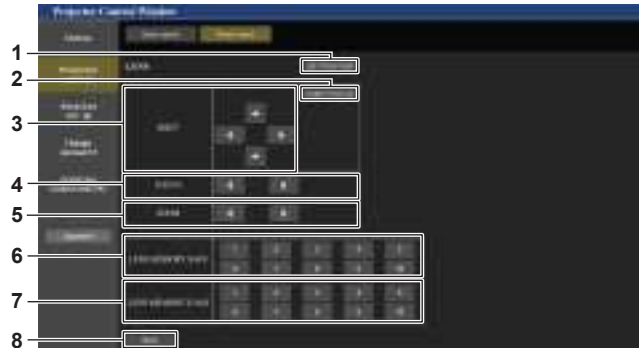

- | | |
|--|--|
| <p>1 [SET POSITION]
The lens position setting page is displayed.</p> <p>2 [HOME POSITION]
Moves the projection lens to the home position.</p> <p>3 [SHIFT]
Click ▲▼◀▶ to adjust the lens shift (vertical position and horizontal position).
The adjustment can be performed faster by holding down the button for approximately three seconds or longer.</p> <p>4 [FOCUS]
Click ◀▶ to adjust the focus.
The adjustment can be performed faster by holding down the button for approximately six seconds or longer.</p> | <p>5 [ZOOM]
Click ◀▶ to adjust the zoom.</p> <p>6 [LENS MEMORY SAVE]
Saves the current lens position (vertical position, horizontal position, focus position, and zoom position). Click the number of the lens memory to save.</p> <p>7 [LENS MEMORY LOAD]
Loads the lens position (vertical position, horizontal position, focus position, and zoom position). Click the number of the lens memory to load.</p> <p>8 [Back]
Returns to the [Detail control] page.</p> |
|--|--|

Lens position setting page

Click [Projector control] → [Detail control] → [LENS] → [SET POSITION].



- | | |
|--|---|
| <p>1 [Get]
Acquires the current lens position and displays the acquired values in the lens position information field.</p> <p>2 Lens position information field
Enter the lens position (vertical position, horizontal position, focus position, and zoom position).</p> | <p>3 [Back]
Returns to the [LENS] page.</p> <p>4 [Apply]
Moves to the lens position displayed in the lens position information field.</p> |
|--|---|

[Network config] page

Click [Detailed set up] → [Network config].

- 1) Click [Network config].**
- Click [Network config] to display the **[CAUTION!]** screen.



- 2) Select the item to change the setting.**
- The [WIRELESS LAN] setting can be selected only when the optional Wireless Module (Model No.: AJ-WM50 Series) is attached.
- 3) Click [Next].**
- The current settings are displayed.
- 4) Click [Change].**
- The setting change screen is displayed.

For wired LAN connection



- | | |
|---|--|
| <p>1 [DHCP ON], [DHCP OFF]
To enable the DHCP client function, set to [DHCP ON].</p> <p>2 [IP ADDRESS]
Enter the IP address when not using a DHCP server.</p> <p>3 [SUBNET MASK]
Enter the subnet mask when not using a DHCP server.</p> <p>4 [DEFAULT GATEWAY]
Enter the default gateway address when not using a DHCP server.</p> <p>5 [DNS1]
Enter the DNS1 server address.
Permissible characters for the entry of DNS1 server address (primary):
Numbers (0 - 9), period (.)
(Example: 192.168.0.253)</p> | <p>6 [DNS2]
Enter the DNS2 server address.
Available characters for the entry of DNS2 server address (secondary):
Numbers (0 - 9), period (.)
(Example: 192.168.0.254)</p> <p>7 [Back], [Next]
Click [Back] to return to the original screen. Click [Next] to display the setting confirmation screen. Click [Submit] to update the setting.</p> |
|---|--|

Note

- When you use the “Forward” and “Back” functions of your browser, a warning message “Page has Expired” may appear. In that case, click [Network config] again since the following operation will not be guaranteed.
- Changing LAN settings while connected to the LAN may cause the connection to cut out.

For wireless LAN connection

(Available only when the Wireless Module is attached to the projector)

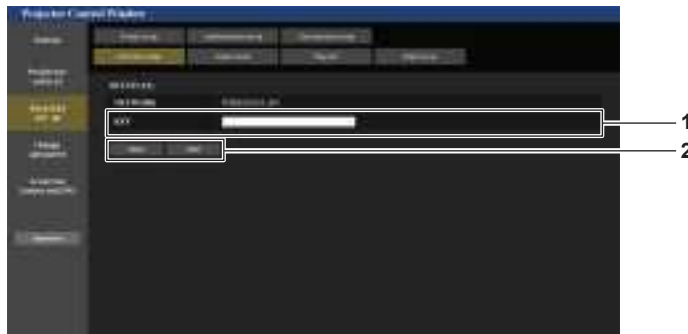

- | | |
|--|--|
| <p>1 [KEY]
Sets the connection key.
Enter 8 to 15 characters of single-byte alphanumeric.</p> | <p>2 [Back], [Next]
Click [Back] to return to the original screen. Click [Next] to display the setting confirmation screen. Click [Submit] to update the setting.</p> |
|--|--|

[Adjust clock] page

Click [Detailed set up] → [Adjust clock].

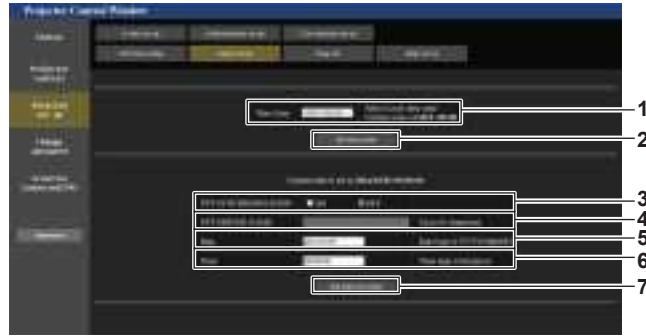

- | | |
|--|---|
| <p>1 [Time Zone]
Select the time zone.</p> <p>2 [Set time zone]
Updates the time zone setting.</p> <p>3 [NTP SYNCHRONIZATION]
Set to [ON] when setting the date and time automatically.</p> <p>4 [NTP SERVER NAME]
Enter the IP address or server name of the NTP server when you set to adjust the date and time manually.
(To enter the server name, the DNS server needs to be set up.)</p> | <p>5 [Date]
Enter the date to change when [NTP SYNCHRONIZATION] is set to [OFF].</p> <p>6 [Time]
Enter the time to change when [NTP SYNCHRONIZATION] is set to [OFF].</p> <p>7 [Set date and time]
Updates the date and time settings.</p> |
|--|---|

Note

- The replacement of the battery inside the projector is required when the time goes out of alignment right after correcting the time. Consult your dealer.

[Ping test] page

Check whether the network is connected to the E-mail server, POP server, DNS server, etc.

Click [Detailed set up] → [Ping test].

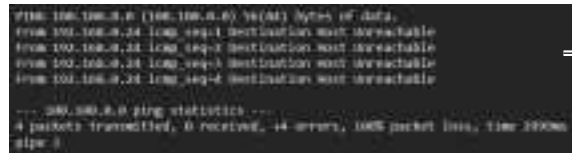
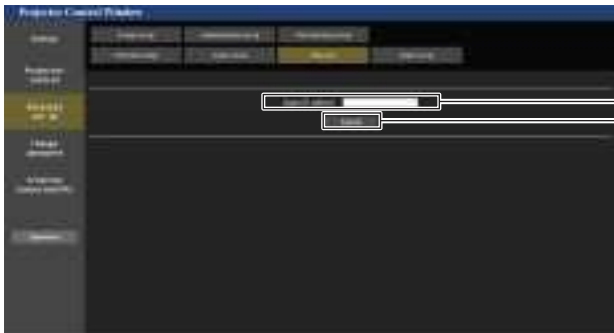

- | | |
|--|--|
| <p>1 [Input IP address]
Enter the IP address of the server to be tested.</p> <p>2 [Submit]
Executes the connection test.</p> | <p>3 Example of display when the connection has succeeded</p> <p>4 Example of display when the connection has failed</p> |
|--|--|

[Https set up] page

Set this page when HTTPS (Hypertext Transfer Protocol Secure) communication encrypted with the SSL/TLS protocol is to be performed between the computer and the projector while the web control function is used. To perform the HTTPS communication, it is necessary to install the certificate for authentication into the projector. Click [Detailed set up] → [Https set up].



1 [CRT Key generate]

Generates the CRT (Certificate) key.
The page to generate the CRT key is displayed by clicking [Execute].
For details, refer to “Generating the CRT key” (➡ page 216).

2 [Self-signed Certificate]

[Generate]:
Generates the self-signed certificate by the projector.
The page to generate the self-signed certificate is displayed by clicking [Execute].
For details, refer to “Generating the self-signed certificate” (➡ page 220).

[Information]:
Displays the status of the self-signed certificate.

- **[Not generated]:** Self-signed certificate is not generated.
- **[(host name)]:** Self-signed certificate is generated and valid. The host name registered in the self-signed certificate is displayed.
- **[Invalid (Reason: Server Certificate installed)]:** The server certificate is valid, so the generated self-signed certificate is invalid.

Information of the generated self-signed certificate is displayed by clicking [Confirm].
The generated self-signed certificate can be deleted by clicking [Delete].
For details, refer to “Confirming the information of the self-signed certificate” (➡ page 220).

3 [Server Certificate]

[Generate Certificate Signing Request]:
Generates signing request (Certificate Signing Request).
The page to generate the signing request is displayed by clicking [Execute].
For details, refer to “Generating the signing request” (➡ page 218).

[Server Certificate install]/[Intermediate Certificate install]:
Installs the server certificate and the intermediate certificate.
The certificate is installed into the projector by specifying the certificate file and clicking [Execute].
For details, refer to “Installing the certificate” (➡ page 219).

[Information]:
Displays the status of the server certificate.

- **[Invalid]:** The server certificate is not installed. Or, the current CRT key is different from the CRT key used for requesting the installed server certificate.
- **[(host name)]:** The server certificate is installed and valid. The host name registered in the server certificate is displayed.
- **[Expired]:** Valid period of the server certificate has expired. The host name registered in the server certificate is displayed when the server certificate is installed and valid.

Information of the installed server certificate is displayed by clicking [Confirm].
The installed server certificate and the intermediate certificate can be deleted by clicking [Delete].
For details, refer to “Confirming the information of the server certificate” (➡ page 219).

4 [Connection]

Sets the connection method to the projector.

- **[HTTP]:** Uses the HTTP communication. (Factory default setting)
- **[HTTPS]:** Uses the HTTPS communication.

5 [HTTPS port]

Sets the port number to be used with the HTTPS communication.
Allowed port number: 1 to 65535
Factory default setting: 443

6 [Set]

Enables the setting.

Note

- When the [Connection] setting is changed from [HTTPS] to [HTTP], the screen may not be displayed when the operation or update of the web control screen is performed. In such case, delete the cache of the web browser.
- The [Crestron Connected(TM)] page cannot be operated when [Connection] is set to [HTTPS].
- Installation operation of the certificate may not be possible depending on the computer or web browser in use.

■ Flow for setting

The flow for setting differs depending on which certificate is to be used as the security certificate used for the HTTPS communication, either the server certificate or the self-signed certificate.

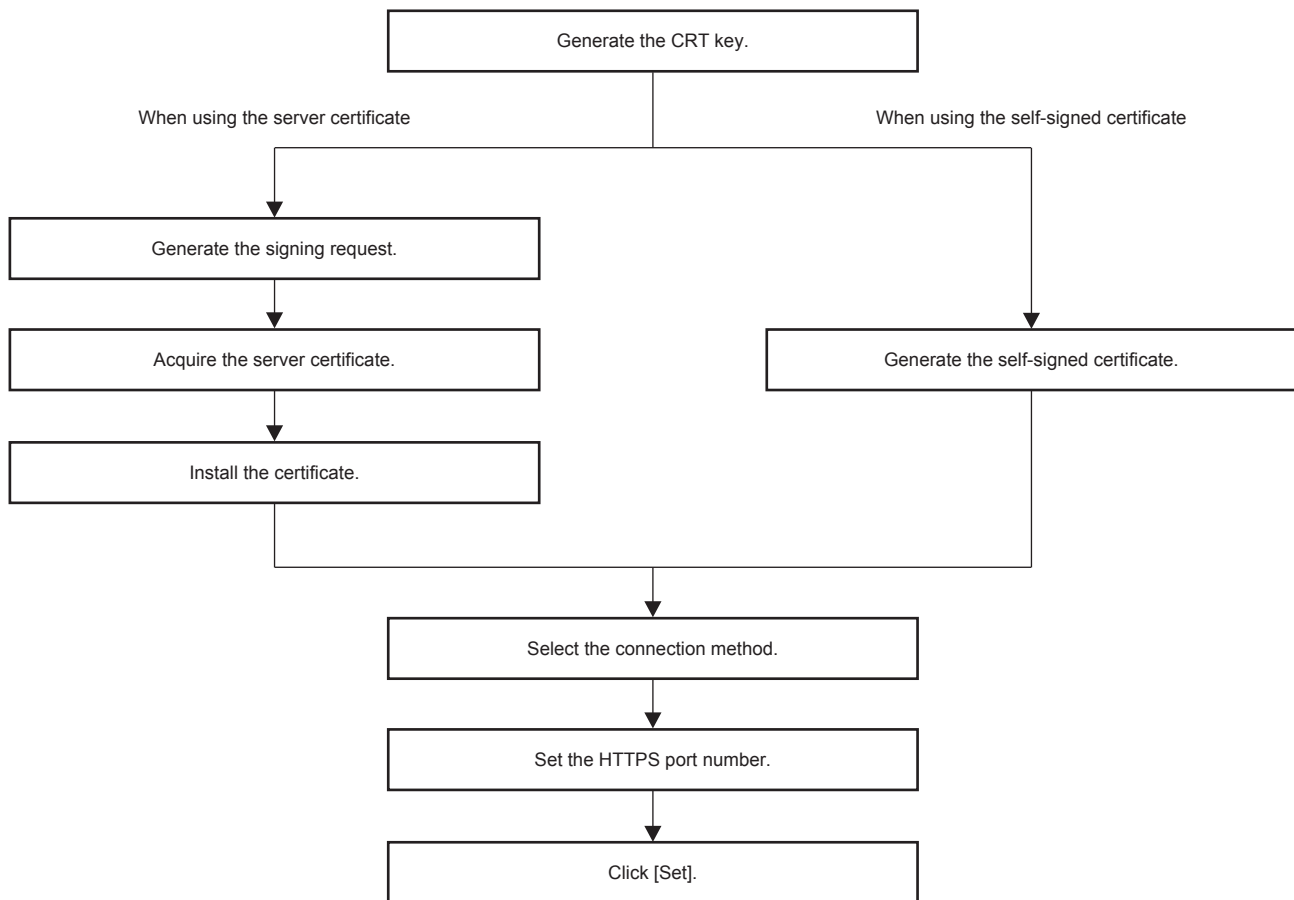

Note

- When using the server certificate, the procedure from application to the certification organization to issuing of the server certificate is required to be performed between the customer and the certification organization. For the application method, etc., contact the certification organization.

Generating the CRT key

Generate the CRT key used for encryption with the RSA (Rivest-Shamir-Adleman cryptosystem) public key encryption method. CRT key is a type of the private key.

1) Click [Https set up] → [CRT Key generate] → [Execute].

- The page to generate the CRT key is displayed.



2) Click [Execute].

- The CRT key is generated.
- Once the generation of the CRT key is completed, the key length and the generation date and time of the current CRT key are displayed in [RSA key size] and [Last modified] of [Current CRT key] at the upper row.

3) Click [back].

Note

- [Not generated] displayed in [Last modified] indicates that the CRT has not been generated.
- [RSA key size] is fixed to [2048bit]. The server certificate may not be issued depending on the certification organization to apply if the key length is 2048-bit.

- Generation of the CRT key may take up to approximately two minutes.
- When the CRT key is updated, apply for the server certificate or generate the self-signed certificate again using that CRT key. A certificate linked to the CRT key is required.
- Previously generated CRT key information is saved even if the CRT key is updated. To return to the previous CRT key, refer to “Cancelling the update of the CRT key” (➔ page 217).

Cancelling the update of the CRT key

It is possible to return to the previously generated CRT key only once even if the CRT key is updated.

1) Click [Https set up] → [CRT Key generate] → [Execute].

- The page to generate the CRT key is displayed.



2) Click [History].

- Following contents are displayed.



3) Confirm [RSA key size] and [Last modified] of the CRT key to restore.

4) Click [Apply].

- Following confirmation message is displayed.
“The previous CRT key will be loaded. Please generate Self-signed Certificate or install the Server Certificate corresponds to the CRT key. Continue?”

5) Click [OK].

- Previously generated CRT key is reflected as the current CRT key.

Note

- When returned to the previously generated CRT key, a certificate linked to that CRT key is required.

Generating the signing request

When using the server certificate issued by the certification organization as a security certificate used for the HTTPS communication, generate a signing request necessary for application of issuing to the certification organization. Generate the signing request after generating the CRT key.

1) Click [Https set up] → [Generate Certificate Signing Request] → [Execute].

- The page to generate the signing request is displayed.



2) Enter the information required for application.

- The details of each item are as follows. Enter the information following the requirement of the certification organization to apply.

Item	Details	Character length limit
[Common Name]	Enter the projector name or the IP address set in the projector.	64 characters
[Country]	Enter the country code defined in ISO 3166-1 alpha-2 (two upper case alphabets).	—
[State]	Enter the State, etc.	128 characters
[Locality]	Enter the locality.	128 characters
[Organization]	Enter the organization name.	64 characters
[Organization Unit]	Enter the organization unit name.	64 characters
[CRT key]	[RSA key size]	The key length of the current CRT key is displayed.
	[Last modified]	The generation date and time of the current CRT key is displayed.

3) Click [OK].

- The signing request file is generated. Enter a file name and save the file in the desired folder.

4) Enter a file name and click [Save].

- The file for signing request is saved in the specified folder.

Note

- The characters that can be input are as follows.
 - Single-byte numbers: 0 to 9
 - Single-byte alphabets: A to Z, a to z
 - Single-byte symbols: - . _ , + / ()
- The signing request generated by the projector is PEM format (file extension: pem).
- Apply issuing of the server certificate to the certification organization using the saved signing request file (PEM format).

Installing the certificate

Install the server certificate and the intermediate certificate issued by the certification organization into the projector.

- 1) Click **[Https set up]** → **[Server Certificate install]** → **[Browse]**.
 - A dialog to select the file is displayed.
- 2) **Select the server certificate file and click [Open]**.
 - If the intermediate certificate is issued from the certification organization together with the server certificate, proceed to Step 3).
 - If only the server certificate is issued from the certification organization, proceed to Step 5).
- 3) Click **[Browse]** in **[Intermediate Certificate install]**.
 - A dialog to select the file is displayed.
- 4) **Select the intermediate certificate file and click [Open]**.
- 5) Click **[Execute]**.
 - The server certificate and the intermediate certificate are installed into the projector.
- 6) Click **[back]**.

Note

- To confirm the information of the installed server certificate, refer to “Confirming the information of the server certificate” (➔ page 219).

Confirming the information of the server certificate

Confirm the information of the server certificate installed in the projector.

- 1) Click **[Https set up]** → **[Server Certificate]** → **[Information]** → **[Confirm]**.
 - The information of the installed server certificate is displayed. The details of each item are as follows.

Item	Details	
[Common Name]	The projector name or the IP address is displayed.	
[Country]	The country code defined in ISO 3166-1 alpha-2 (two upper case alphabets) is displayed.	
[State]	The State, etc. is displayed.	
[Locality]	The locality is displayed.	
[Organization]	The organization name is displayed.	
[Organization Unit]	The organization unit name is not displayed. It is displayed as an asterisk.	
[Not Before]	Displays the date and time that the self-signed certificate was issued.	
[Not After]	Displays the date and time that the self-signed certificate will expire.	
[CRT key]	[RSA key size]	The key length of the CRT key is displayed.
	[Last modified]	The generation date and time of the CRT key is displayed.

Note

- The installed server certificate and the intermediate certificate can be deleted by clicking **[Https set up]** → **[Server Certificate]** → **[Delete]**. However, it cannot be deleted when **[Connection]** is set to **[HTTPS]**. Delete it after changing the setting to perform the HTTP communication. To delete the server certificate within the valid period, confirm that the certificate file used for installing is available on hand. It will be necessary when installing the server certificate again.

Generating the self-signed certificate

When the server certificate issued by the certification organization is not to be used as the security certificate used for HTTPS communication, it is possible to use the self-signed certificate generated in the projector. Generate the self-signed certificate after generating the CRT key.

1) Click [Https set up] → [Self-signed Certificate] → [Generate] → [Execute].

- The page to generate the self-signed certificate is displayed.



2) Enter the information required for generation.

- The details of each item are as follows.

Item	Details	Character length limit
[Common Name]	Enter the projector name or the IP address set in the projector.	64 characters
[Country]	Enter the country code defined in ISO 3166-1 alpha-2 (two upper case alphabets).	—
[State]	Enter the State, etc.	128 characters
[Locality]	Enter the locality.	128 characters
[Organization]	Enter the organization name.	64 characters
[Organization Unit]	Enter the organization unit name.	64 characters
[CRT key]	[RSA key size]	The key length of the current CRT key is displayed.
	[Last modified]	The generation date and time of the current CRT key is displayed.

3) Click [OK].

- Self-signed certificate is generated.

Note

- The characters that can be input are as follows.
 - Single-byte numbers: 0 to 9
 - Single-byte alphabets: A to Z, a to z
 - Single-byte symbols: - . _ , + / ()

Confirming the information of the self-signed certificate

Confirm the information of the self-signed certificate generated by the projector.

1) Click [Https set up] → [Self-signed Certificate] → [Information] → [Confirm].

- The information of the generated self-signed certificate is displayed. The details of each item are as follows.

Item	Details	
[Common Name]	The projector name or the IP address is displayed.	
[Country]	The country code defined in ISO 3166-1 alpha-2 (two upper case alphabets) is displayed.	
[State]	The State, etc. is displayed.	
[Locality]	The locality is displayed.	
[Organization]	The organization name is displayed.	
[Organization Unit]	The organization unit name is displayed.	
[Not Before]	Displays the date and time that the self-signed certificate was issued.	
[Not After]	Displays the date and time that the self-signed certificate will expire (local time corresponding to 23:59, December 31, 2035 in Greenwich Mean Time).	
[CRT key]	[RSA key size]	The key length of the CRT key is displayed.
	[Last modified]	The generation date and time of the CRT key is displayed.

Note

- The generated self-signed certificate can be deleted by clicking [Https set up] → [Self-signed Certificate] → [Delete]. However, it cannot be deleted when [Connection] is set to [HTTPS]. Delete it after changing the setting to perform the HTTP communication.

[E-mail set up] page

Send an E-mail to preset E-mail addresses (up to two addresses) when a problem has occurred. Click [Detailed set up] → [E-mail set up].

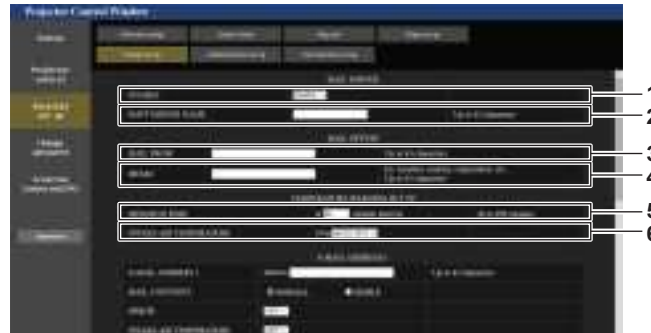

- 1 [ENABLE]**
Select [ENABLE] to use the E-mail function.
- 2 [SMTP SERVER NAME]**
Enter the IP address or the server name of the E-mail server (SMTP). To enter the server name, the DNS server needs to be set up.
- 3 [MAIL FROM]**
Enter the E-mail address of the projector. (Up to 63 characters in single byte)
- 4 [MEMO]**
Enter information such as the location of the projector that notifies the sender of the E-mail. (Up to 63 characters in single byte)

- 5 [MINIMUM TIME]**
Change the minimum interval for the temperature warning E-mail. The default value is 60 minutes. In this case, another E-mail will not be sent for 60 minutes after sending the temperature warning E-mail even if it reaches the warning temperature.
- 6 [INTAKE AIR TEMPERATURE]**
Change the temperature setting for the temperature warning mail. A temperature warning E-mail is sent when the temperature exceeds this value.



- 7 [E-MAIL ADDRESS 1], [E-MAIL ADDRESS 2]**
Enter the E-mail address to be sent. Leave [E-MAIL ADDRESS 2] blank when two E-mail addresses are not to be used.



- 8 Settings of the conditions to send E-mail**
Select the conditions to send E-mail.
[MAIL CONTENTS]:
Select either [NORMAL] or [SIMPLE].
 - **[NORMAL]:** Select this item when sending detailed information including the status of the projector.
 - **[SIMPLE]:** Select this item when sending minimal information such as error information.**[ERROR]:**
Send an E-mail when an error occurred in the self-diagnosis.
[INTAKE AIR TEMPERATURE]:
Send an E-mail when the intake air temperature has reached the value set at the above field.
[PERIODIC REPORT]:
Place a check mark on this to send an E-mail periodically. An E-mail will be sent on the day and time with the check mark.
- 9 [Submit]**
Updates the settings and sends the details by E-mail.

[Authentication set up] page

Set the authentication items when POP authentication or SMTP authentication is necessary to send an E-mail. Click [Detailed set up] → [Authentication set up].

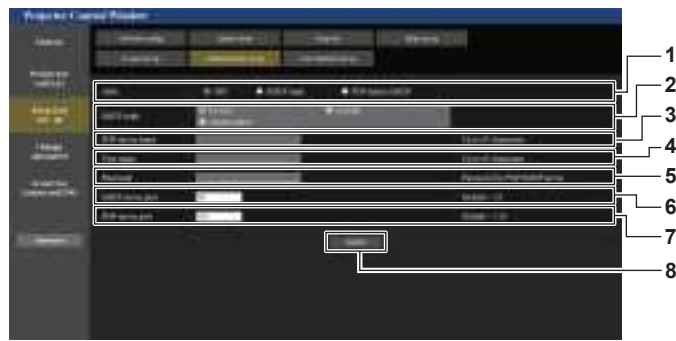

- | | |
|--|---|
| <p>1 [Auth]
Select the authentication method specified by your Internet service provider.</p> <p>2 [SMTP Auth]
Set when the SMTP authentication is selected.</p> <p>3 [POP server name]
Enter the POP server name.
Allowed characters:
Alphanumerics (A - Z, a - z, 0 - 9)
Minus sign (-) and period (.)</p> <p>4 [User name]
Enter the user name for the POP server or the SMTP server.</p> | <p>5 [Password]
Enter the password for the POP server or the SMTP server.</p> <p>6 [SMTP server port]
Enter the port number of the SMTP server.
(Normally 25)</p> <p>7 [POP server port]
Enter the port number of the POP server.
(Normally 110)</p> <p>8 [Submit]
Update the settings.</p> |
|--|---|

Contents of E-mail sent

Example of the E-mail sent when E-mail is set

The following E-mail is sent when the E-mail settings have been established.

- Example: When [MAIL CONTENTS] is set to [SIMPLE] in the [E-mail set up] page

```

=== Panasonic projector report(CONFIGURE) ===
Projector Type      : PT-RQ50K
Serial No          : 123456789012

---- E-mail setup data ----
TEMPERATURE WARNING SETUP
MINIMUM TIME       at [ 60 ] minutes interval
INTAKE AIR TEMPERATURE Over [ 46 degC / 114 degF ]

ERROR              [ ON ]
INTAKE AIR TEMPERATURE [ ON ]

PERIODIC REPORT
Sunday [ OFF ] Monday [ OFF ] Tuesday [ OFF ] Wednesday [ OFF ]
Thursday [ OFF ] Friday [ OFF ] Saturday [ OFF ]

00:00 [ OFF ] 01:00 [ OFF ] 02:00 [ OFF ] 03:00 [ OFF ]
04:00 [ OFF ] 05:00 [ OFF ] 06:00 [ OFF ] 07:00 [ OFF ]
08:00 [ OFF ] 09:00 [ OFF ] 10:00 [ OFF ] 11:00 [ OFF ]
12:00 [ OFF ] 13:00 [ OFF ] 14:00 [ OFF ] 15:00 [ OFF ]
16:00 [ OFF ] 17:00 [ OFF ] 18:00 [ OFF ] 19:00 [ OFF ]
20:00 [ OFF ] 21:00 [ OFF ] 22:00 [ OFF ] 23:00 [ OFF ]

---- Wired network configuration ----
DHCP Client        OFF
IP address         192.168.0.8
MAC address        12:34:56:78:90:12

---- Wireless network configuration ----
IP address         192.168.13.45
MAC address        12:34:56:78:90:12

----- Error information -----
SELF TEST         : NO ERRORS

Mon Jan 01 12:34:56 20XX

---- Memo ----

```

Example of the E-mail sent for an error

The following E-mail is sent when an error has occurred.

- Example: When [MAIL CONTENTS] is set to [SIMPLE] in the [E-mail set up] page

```

=== Panasonic projector report(ERROR) ===
Projector Type      : PT-RQ50K
Serial No          : 123456789012

---- Wired network configuration ----
DHCP Client        OFF
IP address         192.168.0.8
MAC address        12:34:56:78:90:12

---- Wireless network configuration ----
IP address         192.168.13.45
MAC address        12:34:56:78:90:12

----- Error information -----
SELF TEST         : WARNING
U081 Low AC voltage warning (below 90V)

Mon Jan 01 12:34:56 20XX

---- Memo ----

```

[User function set up] page

Set the function limitation for the user rights.

Click [Detailed set up] → [User function set up].

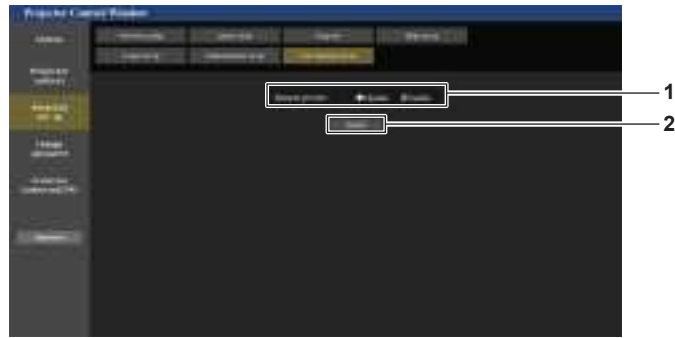

1 [Remote preview]

To disable the remote preview function with the user rights, set [Disable].

2 [Submit]

Updates the setting.

[Change password] page

Click [Change password].

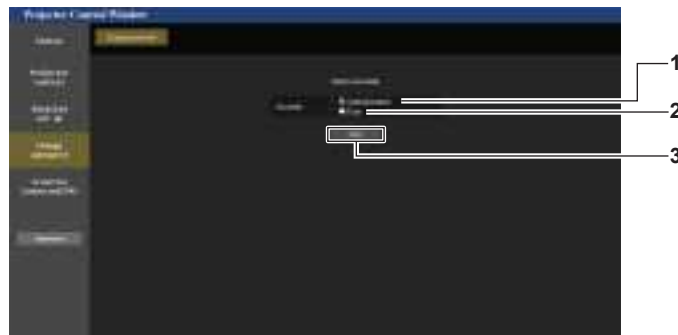

1 [Administrator]

Used to change the setting of the [Administrator].

2 [User]

Used to change the setting of the [User].

3 [Next]

Used to change the setting of the password.

[Administrator] account

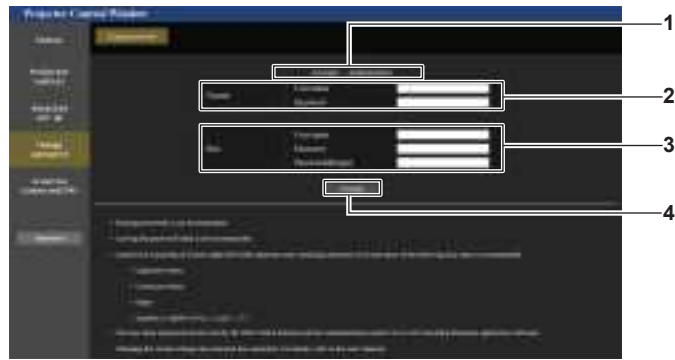

- | | |
|---|--|
| <p>1 [Account]
Displays the account to change.</p> <p>2 [Current]
[User name]:
Enter the user name before the change.
[Password]:
Enter the current password.</p> | <p>3 [New]
[User name]:
Enter the desired new user name. (Up to 16 characters in single byte)
[Password]:
Enter the desired new password. (Up to 16 characters in single byte)
[Password(Retype)]:
Enter the desired new password again.</p> <p>4 [Change]
Determines the change of password.</p> |
|---|--|

Note

- When the projector is already registered in application software (such as “Multi Monitoring & Control Software” and “Smart Projector Control”) which uses the communication control via LAN, communication with the projector will become impossible if a user name or password for [Administrator] is changed. If a user name or password for [Administrator] is changed, update the registration information of the application software in use.

[User] account

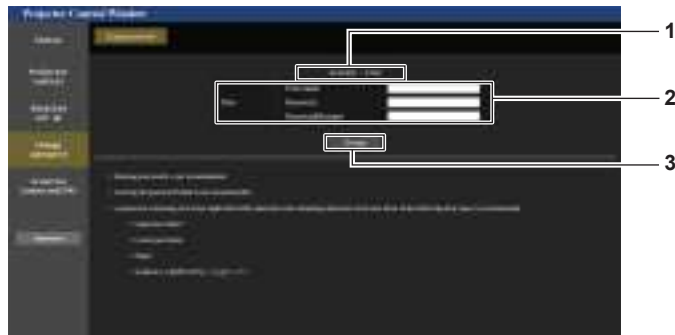

- | | |
|--|---|
| <p>1 [Account]
Displays the account to change.</p> <p>2 [New]
[User name]:
Enter the desired new user name. (Up to 16 characters in single byte)
[Password]:
Enter the desired new password. (Up to 16 characters in single byte)
[Password(Retype)]:
Enter the desired new password again.</p> | <p>3 [Change]
Determines the change of password.</p> |
|--|---|

[Change password] (For user rights)

Only the change of password is enabled under the user rights.

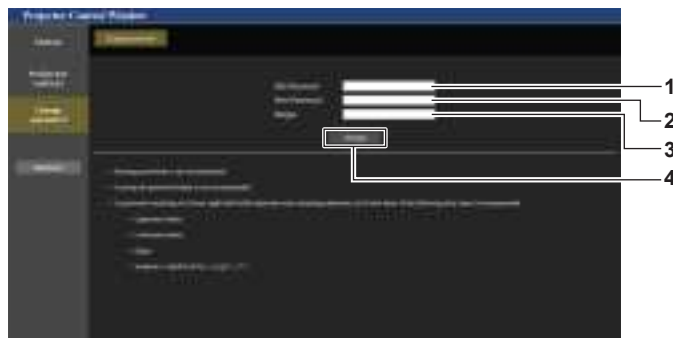

- | | |
|--|--|
| <p>1 [Old Password]
Enter the current password.</p> <p>2 [New Password]
Enter the desired new password. (Up to 16 characters in single byte)</p> | <p>3 [Retype]
Enter the desired new password again.</p> <p>4 [Change]
Determines the change of password.</p> |
|--|--|

Note

- To change the account of the [Administrator], entry of [User name] and [Password] in [Current] is required.

[Crestron Connected(TM)] page

The projector can be monitored/controlled with Crestron Connected.

It is necessary to access with the administrator rights to start the operation screen of Crestron Connected from the web control screen. ([Crestron Connected(TM)] is not displayed in the web control screen with the user rights.)

The operation page of Crestron Connected is displayed by clicking [Crestron Connected(TM)].

It is not displayed if Adobe® Flash® Player is not installed on your computer, or the browser you use does not support Flash. In such a case, click [Back] in the operation page to go back to the previous page.

Note

- When Microsoft Edge is used for a web browser, the operation of the [Crestron Connected(TM)] page may not be possible depending on its version. If the web browser freezes when [Crestron Connected(TM)] is clicked, use "Windows Update" to install the update program.
- The [Crestron Connected(TM)] page cannot be operated when [Detailed set up] → [Https set up] → [Connection] is set to [HTTPS].

Operation page



- | | |
|--|---|
| <p>1 [Tools], [Info], [Help]
Tabs for selecting the setting, information, or help page of the projector.</p> <p>2 [POWER]
Turns off/on the power.</p> <p>3 [SHUTTER]
Switches the status of the shutter. ([CLOSE]: Shutter function enabled; [OPEN]: Shutter function disabled)</p> | <p>4 [Input Select]
Controls input selection.
Not available when the power of the projector is turned off.</p> <p>5 Menu screen control buttons
Navigates the menu screen.</p> <p>6 Freeze/image quality adjustment
Controls items related to freeze/image quality.</p> <p>7 [Back]
Returns to the previous page.</p> |
|--|---|

Note

- When the Interface Board for 12G-SDI (Model No.: ET-MDN12G10) is installed in <SLOT 1> or <SLOT 2>, switching to the SDI2 input or the SDI4 input on the Interface Board for 12G-SDI is not possible by operating [Input Select].

[Tools] page

Click [Tools] in the operation page.

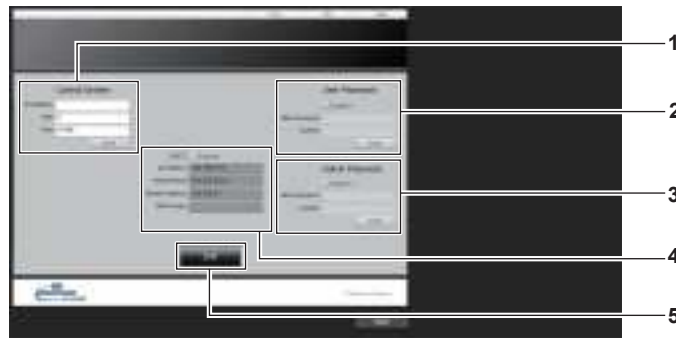

- | | |
|---|--|
| <p>1 [Control System]
Set the information required for communicating with the controller to be connected with the projector.</p> <p>2 [User Password]
Set the user rights password for the operation page of Crestron Connected.</p> <p>3 [Admin Password]
Set the administrator rights password for the operation page of Crestron Connected.</p> | <p>4 Network status
Displays the settings of wired LAN.
[DHCP]
Displays the current setting.
[Ip Address]
Displays the current setting.
[Subnet Mask]
Displays the current setting.
[Default Gateway]
Displays the current setting.
[DNS Server]
Displays the current setting.</p> <p>5 [Exit]
Returns to the operation page.</p> |
|---|--|

[Info] page

Click [Info] in the operation page.

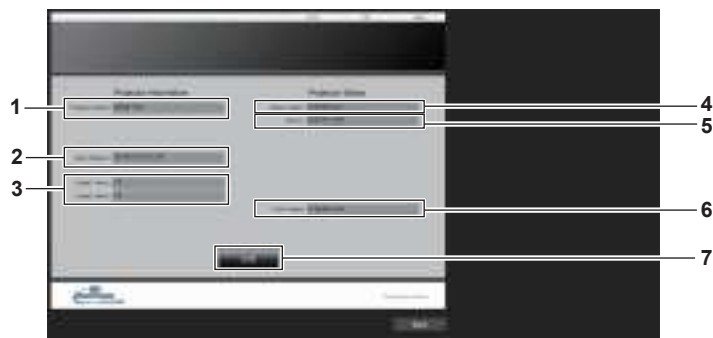

- | | |
|--|---|
| <p>1 [Projector Name]
Displays the projector name.</p> <p>2 [Mac Address]
Displays the MAC address.</p> <p>3 [Lamp1 Hours], [Lamp2 Hours]
Displays the runtime of the light source 1 and the light source 2.</p> <p>4 [Power Status]
Displays the status of the power.</p> | <p>5 [Source]
Displays the selected input.</p> <p>6 [Error Status]
Displays the error status.</p> <p>7 [Exit]
Returns to the operation page.</p> |
|--|---|

[Help] page

Click [Help] in the operation page.
The [Help Desk] window is displayed.



- 1 **[Help Desk]**
A message can be sent/received with the administrator using the Crestron Connected.

Using the information monitor function

Status of the projector can be checked in the information monitor on the control panel.

Screen mode

Information monitor is categorized into following four modes.

Hide mode	This is one of the screen modes in normal status, and is a mode to be selected when not displaying information on the screen during no operation. Set the menu operation mode → [SETUP] menu → [INFO MONITOR] → [DEFAULT] to [OFF].
USER VIEW mode	This is one of the screen modes in normal status, and the mode to constantly display the basic information of the projector during no operation. Set the menu operation mode → [SETUP] menu → [INFO MONITOR] → [DEFAULT] to [USER VIEW]. <ul style="list-style-type: none"> The information to display can be set in the menu operation mode → [SETUP] menu → [INFO MONITOR]. Up to four information can be displayed at once. The screen will switch approximately every two seconds if five or more information is selected to display. When the output image equivalent to the projected image from the projector is being viewed in the [Remote preview] page of the web control screen while the projector is in the standby mode, the text of "Pre-Show Mode" is displayed in addition to the display setting items in [USER VIEW].
Menu operation mode	This is the screen mode to perform the operation of the information monitor. Status of the projector can also be checked. By pressing the <INFO> button on the control panel during the hide mode/USER VIEW mode, the information monitor will transfer to the menu operation mode and the top menu is displayed.
Error notification mode	The error/warning symbol is automatically displayed when an error or warning has occurred in the projector. (▶ page 237)

Note

- If there is no error or warning in the projector, the information monitor will go into either the hide mode/USER VIEW mode when the main power of the projector is turned on and the projector goes into the standby status.

Top menu

By pressing the <INFO> button on the control panel while the information monitor is in the hide mode/USER VIEW mode, the information monitor will transfer to the menu operation mode and the top menu is displayed.

There are following three items in the top menu.

Top menu item	Overview	Page
[USER VIEW]	Displays the basic information of the projector.	230
[SETUP]	Sets the projector ID, the information monitor setting, and the network setting in the sub-menu.	231
[STATUS]	Displays the status of the projector.	235

Note

- Information can be displayed or the settings can be configured even if the projector is in the standby status.

Sub-menu

Press ▲▼ to select [SETUP] in the top menu, and press the <ENTER> button to display the sub-menu.

Sub-menu item	Overview	Factory default	Page
[ID]	Sets the projector ID.	[ALL]	231
[INFO MONITOR]	Sets the information monitor.	—	231
[NETWORK]	Configures the settings to use the network function.	—	233

Note

- Except for some of the input operation in the standby status, operation with the remote control is not possible.

Basic operation procedure in the menu operation mode

1) Press the <INFO> button on the control panel.

- The top menu screen is displayed.

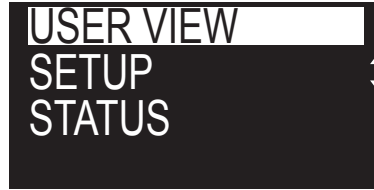

2) Press ▲▼ to select a top menu item.

- The selected item is displayed inverted.

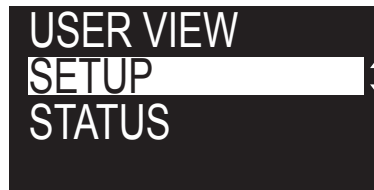

3) Press the <ENTER> button.

- The sub-menu for the selected top menu is displayed.



4) Press ▲▼ to select a sub-menu item, and press the <ENTER> button.

- The setting screen is displayed.

5) Press ◀▶ to change the setting.

Note

- Pressing the <INFO> button during the menu operation mode returns to the previous menu screen.
- Information monitor will transfer to the hide mode/USER VIEW mode automatically if there is no operation for approximately 60 seconds during the menu operation mode. Pressing the <INFO> button on the control panel returns to the original menu operation mode display.

[USER VIEW] menu

Set the information monitor to the menu operation mode by pressing the <INFO> button on the control panel. For the operation of the menu, refer to “Basic operation procedure in the menu operation mode” (➔ page 230).

[USER VIEW]

Display the basic information of the projector.

1) Press ▲▼ to select [USER VIEW].

2) Press the <ENTER> button.

- The information is displayed.

3) Press ▲▼ to switch the pages.

- The page will change each time you press the button.

[INPUT]	Currently selected input terminal*1
[SIGNAL NAME]	Input signal name
[AC VOLTAGE]	Input supply voltage
[INTAKE AIR TEMP.]	Intake air temperature of the projector
[EXHAUST AIR TEMP.]	Exhaust air temperature of the projector

[SHUTTER]	Status of the shutter ([CLOSE]: Shutter function enabled; [OPEN]: Shutter function disabled)
[OSD]	Status of the on-screen display function ([ON]: Display; [OFF]: Hide)
[IP ADDRESS(WIRED)]	IP address of the wired LAN

*1 The representative input terminal is displayed when one image is displayed with multiple input signals.

[SETUP] menu

Set the information monitor to the menu operation mode by pressing the <INFO> button on the control panel. For the operation of the menu, refer to “Basic operation procedure in the menu operation mode” (➔ page 230).

[ID]

The projector has an ID number setting function that can be used when multiple projectors are used side by side to enable simultaneous control or individual control via a single remote control.

- 1) Press ▲▼ to select [SETUP].
- 2) Press the <ENTER> button.
 - The sub-menu item is displayed.
- 3) Press ▲▼ to select [ID].
- 4) Press the <ENTER> button.
 - Setting in [PROJECTOR ID] is displayed.
- 5) Press the <ENTER> button.
 - Setting can be changed.
- 6) Press ◀▶ to switch the setting item.
 - The items will switch each time you press the button.

[ALL]	Select this item when controlling projectors without specifying an ID number.
[1] - [64]	Select this item when specifying an ID number to control individual projector.

Note

- This setting item is common with the following menu item in the on-screen menu.
 - The [PROJECTOR SETUP] menu → [PROJECTOR ID]
- To specify an ID number for individual control, the ID number of a remote control must match the ID number of the projector.
- When the ID number is set to [ALL], the projector will operate regardless of the ID number specified during remote control or computer control.
- If multiple projectors are set up side by side with IDs set to [ALL], they cannot be controlled separately from the projectors with other ID numbers.
- Refer to “Setting ID number of the remote control” (➔ page 81) for how to set the ID number on the remote control.

[INFO MONITOR]

Set the information monitor.

■ Setting the display during normal status

Display/hide the information monitor during no operation.

- 1) Press ▲▼ to select [SETUP].
- 2) Press the <ENTER> button.
 - The sub-menu item is displayed.
- 3) Press ▲▼ to select [INFO MONITOR].
- 4) Press the <ENTER> button.
 - The detailed setting item is displayed.
- 5) Press ▲▼ to select [DEFAULT].
 - The current setting is displayed.
- 6) Press the <ENTER> button.
 - Setting can be changed.

7) Press ◀▶ to switch the setting item.

- The items will switch each time you press the button.

[USER VIEW]	Sets the screen mode during no operation to the USER VIEW mode. Displays the items set in the menu operation mode → [SETUP] menu → [INFO MONITOR]. For details, refer to “Setting the information to display” (▶ page 232).
[OFF]	Sets the screen mode during no operation to the hide mode. Does not display the information.

Note

- This setting item is common with the following menu item in the on-screen menu.
 - The [PROJECTOR SETUP] menu → [INFO MONITOR SETTING] → [DEFAULT]
- Even if [DEFAULT] is set to [OFF], the content of an error or a warning is automatically displayed when it occurs.

■ **Setting the information to display**

Set the items to display during the USER VIEW mode.

- 1) Press ▲▼ to select [SETUP].
- 2) Press the <ENTER> button.
 - The sub-menu item is displayed.
- 3) Press ▲▼ to select [INFO MONITOR].
- 4) Press the <ENTER> button.
 - The detailed setting item is displayed.
- 5) Press ▲▼ to select an item to change setting.
 - The current setting is displayed.

Item	Details	Factory default
[INPUT]	Currently selected input terminal*1	[ON]
[SIGNAL NAME]	Input signal name	[ON]
[AC VOLTAGE]	Input supply voltage	[ON]
[INTAKE AIR TEMP.]	Intake air temperature of the projector	[ON]
[EXHAUST AIR TEMP.]	Exhaust air temperature of the projector	[OFF]
[SHUTTER]	Status of the shutter ([CLOSE]: Shutter function enabled; [OPEN]: Shutter function disabled)	[OFF]
[OSD]	Status of the on-screen display function ([ON]: Display; [OFF]: Hide)	[OFF]
[IP ADDRESS(WIRED)]	IP address of the wired LAN	[OFF]

*1 The representative input terminal is displayed when one image is displayed with multiple input signals.

- 6) Press the <ENTER> button.
 - Setting can be changed.
- 7) Press ◀▶ to switch the setting.
 - The items will switch each time you press the button.

[ON]	Displays the items during the USER VIEW mode.
[OFF]	Does not display the items during the USER VIEW mode.

- Repeat Steps 5) to 7) until the desired display items are set.

Note

- This setting item is common with the following menu item in the on-screen menu.
 - The [PROJECTOR SETUP] menu → [INFO MONITOR SETTING] → [USER VIEW]

■ **Setting the direction to display**

Set the direction of the text to display in the information monitor.

- 1) Press ▲▼ to select [SETUP].
- 2) Press the <ENTER> button.
 - The sub-menu item is displayed.

- 3) Press ▲▼ to select [INFO MONITOR].
- 4) Press the <ENTER> button.
 - The detailed setting item is displayed.
- 5) Press ▲▼ to select [DIRECTION].
- 6) Press the <ENTER> button.
 - Setting can be changed.
- 7) Press ◀▶ to switch the setting.
 - The items will switch each time you press the button.

[AUTO]	Detects the orientation of the projector by the built-in angle sensor, and automatically sets the direction of the text displayed in the information monitor. Set [AUTO] normally.
[NORMAL]	Select this item when installing the projector on a desk, etc.
[FLIPPED]	Select this item when installing the projector with the top surface of the projector facing down such as ceiling attachment. Displays the text inverted upside down from when [NORMAL] is set.

Note

- This setting item is common with the following menu item in the on-screen menu.
 - The [PROJECTOR SETUP] menu → [INFO MONITOR SETTING] → [DIRECTION]

■ Setting the brightness of the information monitor

Set the brightness of the information monitor.

- 1) Press ▲▼ to select [SETUP].
- 2) Press the <ENTER> button.
 - The sub-menu item is displayed.
- 3) Press ▲▼ to select [INFO MONITOR].
- 4) Press the <ENTER> button.
 - The detailed setting item is displayed.
- 5) Press ▲▼ to select [BRIGHTNESS].
- 6) Press the <ENTER> button.
 - Setting can be changed.
- 7) Press ◀▶ to adjust the level.

Operation	Adjustment	Range of adjustment
Press ▶.	The information monitor becomes bright.	30 % - 100 %
Press ◀.	The information monitor becomes dark.	(Factory default setting: 100 %)

Note

- [BRIGHTNESS] is adjusted in increments of 10.
- This setting item is common with the following menu item in the on-screen menu.
 - The [PROJECTOR SETUP] menu → [INFO MONITOR SETTING] → [BRIGHTNESS]

[NETWORK]

Configure the settings to use the network function.

■ Setting the acquisition method of the wired LAN IP address

- 1) Press ▲▼ to select [SETUP].
- 2) Press the <ENTER> button.
 - The sub-menu item is displayed.
- 3) Press ▲▼ to select [NETWORK].

- 4) **Press the <ENTER> button.**
 - The network selection item is displayed.
- 5) **Press ▲▼ to select [WIRED LAN].**
- 6) **Press the <ENTER> button.**
 - The detailed setting item is displayed.
- 7) **Press ▲▼ to select [DHCP].**
 - The current setting is displayed.
- 8) **Press the <ENTER> button.**
 - Setting can be changed.
- 9) **Press ◀▶ to switch the setting item.**
 - The items will switch each time you press the button.

[ON]	Acquires the IP address automatically if a DHCP server exists in the network where the projector is to be connected.
[OFF]	Set [IP ADDRESS], [SUBNET MASK], and [DEFAULT GATEWAY] if a DHCP server does not exist in the network where the projector is to be connected.

Note

- This setting item is common with the following menu item in the on-screen menu.
 - The [NETWORK] menu → [WIRED LAN] → [DHCP]

■ Specifying the wired LAN IP address

Set the IP address, the subnet mask, and the default gateway if a DHCP is not used.

- 1) **Press ▲▼ to select [SETUP].**
- 2) **Press the <ENTER> button.**
 - The sub-menu item is displayed.
- 3) **Press ▲▼ to select [NETWORK].**
- 4) **Press the <ENTER> button.**
 - The network selection item is displayed.
- 5) **Press ▲▼ to select [WIRED LAN].**
- 6) **Press the <ENTER> button.**
 - The detailed setting item is displayed.
- 7) **Press ▲▼ to select [IP ADDRESS], [SUBNET MASK], or [DEFAULT GATEWAY].**
 - The current setting is displayed.
- 8) **Press the <ENTER> button.**
 - Setting can be changed.
- 9) **Press ▲▼◀▶ to enter the address.**
 - Press ◀▶ to select the number to change, and press ▲▼ to change the number.
- 10) **Press the <ENTER> button.**
 - The setting is reflected.

Note

- This setting item is common with the following menu item in the on-screen menu.
 - The [NETWORK] menu → [WIRED LAN] → [IP ADDRESS]/[SUBNET MASK]/[DEFAULT GATEWAY]
- The number can be entered with the number (<0> - <9>) buttons on the remote control when the projector is in the standby status.

■ Connecting via wireless LAN

Set the wireless LAN function.

- To use the wireless LAN function with the projector, it is necessary to attach the optional Wireless Module (Model No.: AJ-WM50 Series) to the <USB> terminal.

- 1) Press ▲▼ to select [SETUP].
- 2) Press the <ENTER> button.
 - The sub-menu item is displayed.
- 3) Press ▲▼ to select [NETWORK].
- 4) Press the <ENTER> button.
 - The network selection item is displayed.
- 5) Press ▲▼ to select [WIRELESS LAN].
- 6) Press the <ENTER> button.
 - The current setting is displayed.
- 7) Press the <ENTER> button again.
 - Setting can be changed.
- 8) Press ◀▶ to switch to [ENABLE].
 - The items will switch each time you press the button.

[DISABLE]	Select this item when the wireless LAN is not to be used.
[ENABLE]	Select this item when the wireless LAN is to be used.

Note

- [WIRELESS LAN] cannot be set if the optional Wireless Module (Model No.: AJ-WM50 Series) is not installed in the <USB> terminal.
- This setting item is common with the following menu item in the on-screen menu.
 - The [NETWORK] menu → [WIRELESS LAN]

[STATUS] menu

Display the status of the projector.

- 1) Press ▲▼ to select [STATUS].
- 2) Press the <ENTER> button.
 - The sub-menu item is displayed.
- 3) Press ▲▼ to select an item.

Sub-menu item	Overview
[PROJECTOR]	Displays the information of the projector.
[INFO MONITOR]	Displays the setting information of the information monitor.
[NETWORK]	Displays the setting information of the network.
[VERSION]	Displays the firmware version of the projector.

- 4) Press the <ENTER> button.
 - The detailed item is displayed.
 - The network selection item is displayed when [NETWORK] is selected in Step 3). Proceed to Step 6).
- 5) Press ▲▼ to switch the item.
 - The display items will switch each time you press the button.

Sub-menu item	Detailed item	Details
[PROJECTOR]	[PROJECTOR ID]	Displays the ID number set to the projector.
	[PROJECTOR TYPE]	Displays the type of the projector.
	[SERIAL NUMBER]	Displays the serial number of the projector.
	[CONSOLIDATED RUNTIME]	Converts the total runtime of the light sources with [OPERATING MODE] set to each item into the time used with the [NORMAL] setting. The consolidated runtime is used for a rough indication about when to perform maintenance when the projector is used in combination of each item in [OPERATING MODE].
	[PROJECTOR RUNTIME]	Displays the runtime of the projector.
	[LIGHT RUNTIME]	Displays the runtime of the light source 1 and the light source 2.
	[INTAKE AIR TEMP.]	Displays the intake air temperature status.
	[EXHAUST AIR TEMP.]	Displays the exhaust air temperature status.
	[SELF TEST]	Displays the self-diagnosis information. Displays the detailed information when the <ENTER> button is pressed while error/warning has occurred.
	[INPUT]	Displays the input terminal currently selected. Displays the representative input terminal when one image is displayed with multiple input signals.
	[SIGNAL NAME]	Displays the input signal name.
	[ON SCREEN DISPLAY]	Displays the status of on-screen display function. ([ON]: Display; [OFF]: Hide)
	[SHUTTER]	Displays the status of the shutter. ([CLOSE]: Shutter function enabled; [OPEN]: Shutter function disabled)
	[REMOTE2 STATUS]	Displays the control status of the REMOTE2.
	[AC VOLTAGE]	Displays the input supply voltage.
	[OPERATING MODE]	Displays the setting value of the [PROJECTOR SETUP] menu → [OPERATION SETTING] → [OPERATING MODE].
	[MAX LIGHT OUTPUT LEVEL]	Displays the setting value of the [PROJECTOR SETUP] menu → [OPERATION SETTING] → [MAX LIGHT OUTPUT LEVEL].
[LIGHT OUTPUT]	Displays the setting value of the [PROJECTOR SETUP] menu → [LIGHT OUTPUT].	
[INFO MONITOR]	[DEFAULT]	Displays the display setting of the information monitor during normal status. ([USER VIEW]: Display; [OFF]: Hide)
	[INPUT]	Displays the display status of each item during the USER VIEW mode. ([ON]: Display; [OFF]: Hide)
	[SIGNAL NAME]	
	[AC VOLTAGE]	
	[INTAKE AIR TEMP.]	
	[EXHAUST AIR TEMP.]	
	[SHUTTER]	
	[OSD]	
	[IP ADDRESS(WIRED)]	
[DIRECTION]	Displays the direction of the text to display in the information monitor. ([AUTO]: Automatic detection; [NORMAL]: Floor mount; [FLIPPED]: Inverted upside down)	
[BRIGHTNESS]	Displays the setting value of the [PROJECTOR SETUP] menu → [INFO MONITOR SETTING] → [BRIGHTNESS].	
[VERSION]	[MAIN VERSION]	Displays the main version of the firmware of the projector.
	[SUB VERSION]	Displays the sub version of the firmware of the projector.
	[NETWORK VERSION]	Displays the network version of the firmware of the projector.

6) Press ▲▼ to switch the item.

- The display items will switch each time you press the button.

[WIRED LAN]	Select this item when the information of the wired LAN is to be displayed.
[WIRELESS LAN]	Select this item when the information of the wireless LAN is to be displayed.

7) Press the <ENTER> button.

- The detailed item is displayed.

8) Press ▲▼ to switch the item.

- The display items will switch each time you press the button.

Network selection item	Detailed item	Details
[WIRED LAN]	[PROJECTOR NAME]	Displays the [PROJECTOR NAME].
	[DHCP]	Displays the use status of the DHCP server. ([ON]: Used; [OFF]: Not used)
	[IP ADDRESS]	Displays the [IP ADDRESS].
	[SUBNET MASK]	Displays the [SUBNET MASK].
	[DEFAULT GATEWAY]	Displays the [DEFAULT GATEWAY].
	[MAC ADDRESS]	Displays the [MAC ADDRESS] of wired LAN.
[WIRELESS LAN]	[PROJECTOR NAME]	Displays the [PROJECTOR NAME].
	[SSID]	Displays the string of SSID.
	[KEY]	Displays the connection key. Displays/hides the connection key by pressing the <ENTER> button.
	[AUTHENTICATION]	Displays the user authentication method.
	[ENCRYPTION]	Displays the encryption method.
	[IP ADDRESS]	Displays the [IP ADDRESS].
	[SUBNET MASK]	Displays the [SUBNET MASK].
	[MAC ADDRESS]	Displays the [MAC ADDRESS] of wireless LAN.

Note

- Item of the [STATUS] menu → [NETWORK] → [WIRELESS LAN] is not displayed in following cases.
 - When the optional Wireless Module (Model No.: AJ-WM50 Series) is not attached to the <USB> terminal.
 - When the [SETUP] menu → [NETWORK] → [WIRELESS LAN] is set to [DISABLE]

Error notification mode

The error/warning symbol is displayed in the information monitor as a self-diagnosis information when an error or warning has occurred in the projector.

For details on content of the error/warning symbols, refer to “Self-diagnosis display” (➡ page 256).

Operation procedure when an error/warning has occurred

This section explains using the case when the intake air temperature warning is detected in the self-diagnosis as an example.



1) Press the <INFO> button on the control panel.

- The screen of the menu operation mode → [STATUS] menu → [PROJECTOR] → [SELF TEST] is displayed.

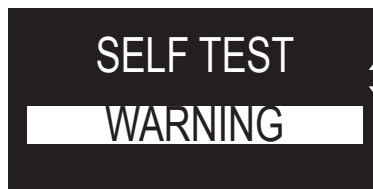

2) Press the <ENTER> button.

- The self-diagnosis information is displayed as the error/warning symbol.



3) Press ►.

- The detailed information is displayed.

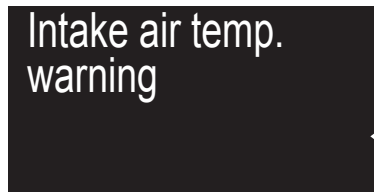

- Press the <INFO> button on the control panel to return to the [SELF TEST] screen in Step 2).

Using the data cloning function

Perform the operation of the data cloning function. Data such as the settings and adjustment values of the projector can be copied to multiple projectors via LAN or using the USB memory.

■ Data that cannot be copied

The following settings cannot be copied. Set these in each projector.

- The [PROJECTOR SETUP] menu → [PROJECTOR ID]
- The [PROJECTOR SETUP] menu → [DATE AND TIME] → [ADJUST CLOCK]
- The [PROJECTOR SETUP] menu → [DATA CLONING] → [LAN] → [WRITE PROTECT]
- The [SECURITY] menu → [SECURITY PASSWORD]
- The [SECURITY] menu → [CONTROL DEVICE SETUP]
- The [NETWORK] menu → [WIRED LAN]
- The [NETWORK] menu → [WIRELESS LAN]
- The [NETWORK] menu → [PROJECTOR NAME]
- Security password
- Control device password
- Password set in “[Change password] page” (➔ page 224) of the web control screen
- Information of the CRT key and the self-signed certificate generated in “[Https set up] page” (➔ page 215) of the web control screen, information of the installed server certificate
- “[E-mail set up] page” (➔ page 221) in the web control screen
- “[Authentication set up] page” (➔ page 222) in the web control screen
- “[Crestron Connected(TM)] page” (➔ page 226) in the web control screen

■ Supported device

- Commercially available USB memory is supported.
The USB memory with a security function is not supported.
- Only the cards formatted in FAT16 or FAT32 can be used.
- Only the single partition structure is supported.

Note

- The data cloning function will not operate when the models of the projectors are different. For example, data of PT-RQ50K can be copied to other PT-RQ50K projectors, but it cannot be copied to PT-RQ22K. Data cloning is limited to the same model.

Copying the data to another projector via LAN

Make the following settings on the projector of the copy destination in advance. For details, refer to “Setting [WRITE PROTECT]” (➔ page 240).

- The [PROJECTOR SETUP] menu → [DATA CLONING] → [LAN] → [WRITE PROTECT] → [OFF]

- 1) **Connect all projectors to the hub using LAN cables.** (➔ page 198)
- 2) **Turn on all the projectors.**
- 3) **Press ▲▼ to select [DATA CLONING] on the copy source projector.**
- 4) **Press the <ENTER> button.**
 - The [SECURITY PASSWORD] screen is displayed.
- 5) **Enter a security password and press the <ENTER> button.**
 - The [DATA CLONING] screen is displayed.
- 6) **Press ▲▼ to select [LAN].**
- 7) **Press the <ENTER> button.**
 - The [LAN DATA CLONING] screen is displayed.
- 8) **Press ▲▼ to select [SELECT PROJECTOR].**
- 9) **Press the <ENTER> button.**
 - The projectors in the same subnet are displayed as a list.

- 10) Press ▲▼ to select the copy destination projector.
- 11) Press the <ENTER> button.
 - To select multiple projectors, repeat Steps 10) to 11).
- 12) Press the <DEFAULT> button on the remote control.
 - The confirmation screen is displayed.
- 13) Press ◀▶ to select [OK], and press the <ENTER> button.
 - Copy of the data between the projectors is started.
Once the copy is completed, results are displayed as a list in the [LAN DATA CLONING] screen. Meanings of the marks displayed in the list are as follows.
 - Green: Data copy has succeeded.
 - Red: Data copy has failed. Confirm the connection of the LAN cable and power status of the copy destination projector.
 - Data is copied to the copy destination projector in the standby mode.
If the copy destination projector is in the projection mode, the LAN data cloning request message is displayed, and then the copy destination projector automatically shifts to the standby mode to start copy of data.
- 14) Turn on the copy destination projector.
 - The copied content is reflected to the projector.

Note

- The security password is the password set in the [SECURITY] menu → [SECURITY PASSWORD CHANGE].
Initial password of the factory default setting: ▲▶▼◀▲▶▼◀
- The light source indicator <LIGHT1>/<LIGHT2> and the temperature indicator <TEMP> of the copy destination projector blink while copying the data. Confirm the blinking of the indicators stops, and then turn on the power supply.

Setting [WRITE PROTECT]

Set if the copy of data via LAN is permitted or not.

- 1) Press ▲▼ to select [DATA CLONING] on the copy destination projector.
- 2) Press the <ENTER> button.
 - The [SECURITY PASSWORD] screen is displayed.
- 3) Enter a security password and press the <ENTER> button.
 - The [DATA CLONING] screen is displayed.
- 4) Press ▲▼ to select [LAN].
- 5) Press the <ENTER> button.
 - The [LAN DATA CLONING] screen is displayed.
- 6) Press ▲▼ to select [WRITE PROTECT].
- 7) Press ◀▶ to switch the item.
 - The items will switch each time you press the button.

[OFF]	Permits operations of [DATA CLONING] from another projector via LAN.
[ON]	Does not permit the operations of [DATA CLONING] from another projector via LAN. <ul style="list-style-type: none"> • Data copy will not be possible when [ON] is set. When it is not necessary to copy data, set [ON] so that the data is not changed by mistake.

Note

- The security password is the password set in the [SECURITY] menu → [SECURITY PASSWORD CHANGE].
Initial password of the factory default setting: ▲▶▼◀▲▶▼◀

Copying the data to another projector using USB

Copying projector data to USB memory

- 1) Insert the USB memory into the <USB> terminal.
- 2) Press ▲▼ to select [DATA CLONING].
- 3) Press the <ENTER> button.
 - The [SECURITY PASSWORD] screen is displayed.
- 4) Enter a security password and press the <ENTER> button.
 - The [DATA CLONING] screen is displayed.
- 5) Press ▲▼ to select [USB MEMORY].
- 6) Press the <ENTER> button.
 - The [SELECT COPY TYPE] screen is displayed.
- 7) Press ▲▼ to select [PROJECTOR -> USB MEMORY].
- 8) Press the <ENTER> button.
 - The confirmation screen is displayed.
- 9) Press ◀▶ to select [OK], and press the <ENTER> button.
 - Copying of data to the USB memory is started.
 - Once the copying of data is completed, [Data copy finished.] is displayed.
- 10) Once the copying of the data is completed, disconnect the USB memory from the <USB> terminal.

Note

- The security password is the password set in the [SECURITY] menu → [SECURITY PASSWORD CHANGE].
Initial password of the factory default setting: ▲▶▼◀▲▶▼◀
- For the USB memory that can be used with the projector and handling of the memory, refer to “Using the USB memory” (➔ page 78).
- An error message is displayed when saving or reading data to/from the USB memory has failed.

Copying data in the USB memory to the projector

- 1) Insert the USB memory into the <USB> terminal.
- 2) Press ▲▼ to select [DATA CLONING].
- 3) Press the <ENTER> button.
 - The [SECURITY PASSWORD] screen is displayed.
- 4) Enter a security password and press the <ENTER> button.
 - The [DATA CLONING] screen is displayed.
- 5) Press ▲▼ to select [USB MEMORY].
- 6) Press the <ENTER> button.
 - The [SELECT COPY TYPE] screen is displayed.
- 7) Press ▲▼ to select [USB MEMORY -> PROJECTOR].
- 8) Press the <ENTER> button.
 - The confirmation screen is displayed.
- 9) Press ◀▶ to select [OK], and press the <ENTER> button.
 - The projector automatically enters standby state and starts copying data from the USB memory to the projector.
- 10) Once the copying of the data is completed, disconnect the USB memory from the <USB> terminal.

11) Turn on the power of the projector.

- The copied content is reflected to the projector.

Note

- The security password is the password set in the [SECURITY] menu → [SECURITY PASSWORD CHANGE].
Initial password of the factory default setting: ▲▶▼◀▲▶▼◀
- The light source indicator <LIGHT1>/<LIGHT2> and the temperature indicator <TEMP> of the copy destination projector blink while copying the data. Confirm the blinking of the indicators stops, and then turn on the power supply.

Updating the firmware

The firmware of the projector can be updated via LAN or using a USB memory.

Check the Panasonic website (<https://panasonic.net/cns/projector/pass/>) for availability of the firmware that can be updated. Customer can update the firmware if a newer version than the current firmware version is published.

It is necessary to register and log in to PASS^{*1} to confirm the availability of the firmware that can be updated or to download the firmware.

*1 PASS: Panasonic Professional Display and Projector Technical Support Website
For details, visit the Panasonic website (<https://panasonic.net/cns/projector/pass/>).

■ Firmware that can be updated

- Main version
- Network version

■ How to confirm the firmware version

Current firmware version can be confirmed by pressing the <STATUS> button on the remote control and displaying the [STATUS] screen.

The firmware version can also be confirmed in the [PROJECTOR SETUP] menu → [STATUS].

STATUS		1/6
PROJECTOR TYPE	PT-RQ50K	
SERIAL NUMBER	123456789012	
PROJECTOR RUNTIME	100000h	
LIGHT RUNTIME	100000h / 100000h	
CONTINUOUS LIGHTING TIME	1h 23m	
MAIN/SUB VERSION	[1.00]	1.00
NETWORK VERSION	[1.00]	
INTAKE AIR TEMP.	31°C/87°F	
EXHAUST AIR TEMP.	31°C/87°F	
SELF TEST	NO ERRORS	
ENTER E-MAIL/USB ◀ CHANGE MENU EXIT		

Main version

Network version

Note

- A LAN cable is required to connect to the network via wired LAN.

Updating the firmware via LAN

Example of network connection

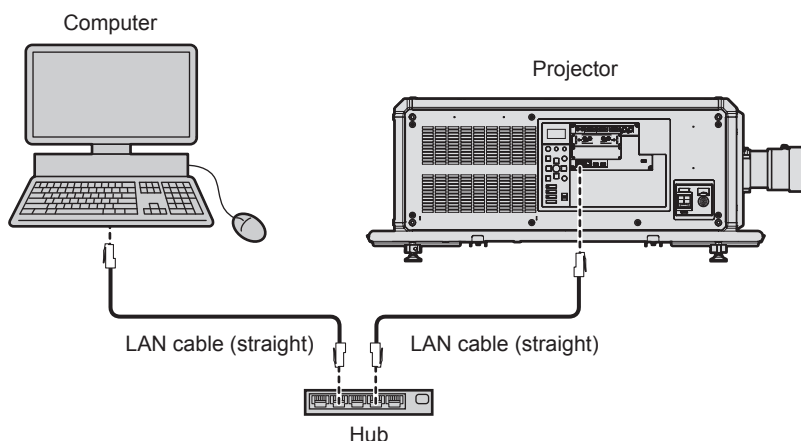

Attention

- When a LAN cable is directly connected to the projector, the network connection must be made indoors.

Note

- A LAN cable is required to connect to the network via wired LAN.
- Connect a LAN cable to the <LAN> terminal or the <DIGITAL LINK> terminal of the projector.
- To connect to the network using the <LAN> terminal, set the [NETWORK] menu → [NETWORK CONTROL] → [TYPE SELECT] to [LAN] or [LAN & DIGITAL LINK].

- To connect to the network using the <DIGITAL LINK> terminal, set the [NETWORK] menu → [NETWORK CONTROL] → [TYPE SELECT] to [DIGITAL LINK] or [LAN & DIGITAL LINK].
- The <DIGITAL LINK> terminal and the <LAN> terminal are connected inside of the projector when the [NETWORK] menu → [NETWORK CONTROL] → [TYPE SELECT] is set to [LAN & DIGITAL LINK]. Do not directly connect the <DIGITAL LINK> terminal and the <LAN> terminal using a LAN cable. Construct the system so that it is not connected to the same network via the peripherals such as the hub or the twisted-pair-cable transmitter.
- Use a straight or crossover LAN cable that is compatible with CAT5 or higher for the LAN cable to connect to the <LAN> terminal. Either the straight or the crossover cable, or both cables can be used depending on the system configuration. Consult your network administrator. The projector will determine the type of the cable (straight or crossover) automatically.
- Use a LAN cable of 100 m (328'1") or shorter as the LAN cable to connect to the <LAN> terminal.
- For the LAN cable between the twisted-pair-cable transmitter and the projector, use a cable that meets the following criteria:
 - Conforming to CAT5e or higher standards
 - Shielded type (including connectors)
 - Straight-through
 - Single wire
 - Diameter of the cable core is same or larger than AWG24 (AWG24, AWG23, etc.)
- The maximum transmission distance between the twisted-pair-cable transmitter and the projector is normally 100 m (328'1"). It is possible to transmit up to 150 m (492'2") if the twisted-pair-cable transmitter supports the long-reach communication method.
- Do not use a hub between the twisted-pair-cable transmitter and the projector.

Computer used for updating the firmware

Prepare a computer compatible with the following OS equipped with a LAN terminal.

- Microsoft Windows 10
Windows 10 Pro 32 bit/64 bit, Windows 10 32 bit/64 bit
- Microsoft Windows 8.1
Windows 8.1 Pro 32 bit/64 bit, Windows 8.1 32 bit/64 bit

Note

- The operation is not guaranteed when used in an environment outside the conditions described in this section, or when a home-made computer is used.
- This does not guarantee the operation on all computers even if it is used in the environment fulfilling the conditions described in this section.
- Connection with the projector or the data transfer of the firmware may fail in following cases. If it has failed, change the software setting or change the [Power Options] setting in Windows OS, and try the update again.
 - When security software such as firewall or the utility software for the LAN adapter is installed
 - When other software has started up or operating
 - When the computer has gone into sleep/pause status

Acquiring the firmware

Download the firmware update tool for this projector (compressed file in zip format) from the Panasonic website (<https://panasonic.net/cns/projector/pass/>).

- File name (example): FirmUpdateTool_RQ50K_101_102.zip
(Update tool for the PT-RQ50K with main version 1.01/network version 1.02)

Confirming the setting of the projector

Confirm the setting of the projector to be updated in advance.

- The [NETWORK] menu → [NETWORK CONTROL] → [COMMAND PORT]
- The [NETWORK] menu → [NETWORK STATUS] → [WIRED LAN]
 - [DHCP]
 - [IP ADDRESS]
 - [SUBNET MASK]
 - [DEFAULT GATEWAY]
- [User name] and [Password] of the administrator rights for web control

Confirming the computer setting

Confirm the network setting of the computer to be used for update, and make it possible to connect with the projector to be updated via network.

Updating the firmware

1) Extract the compressed file downloaded from the website.

- The firmware update tool (executable file in exe format) is generated.
File name (example): FirmUpdateTool_RQ50K_101_102.exe

2) **Double-click the executable file generated by extracting.**

- The update tool is started up, and the confirmation screen is displayed.

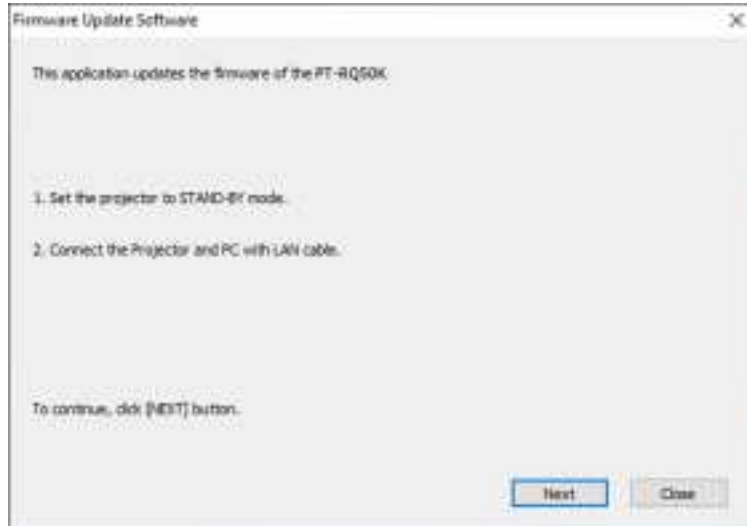

3) **Confirm the status of the projector.**

- Confirm that the projector to be updated is in the standby mode.

4) **Confirm the connection status.**

- Confirm that the projector to be updated and the computer to be used for update are correctly connected to LAN.

5) **Click [Next].**

- The license agreement screen is displayed.
- Confirm the content of the license agreement.

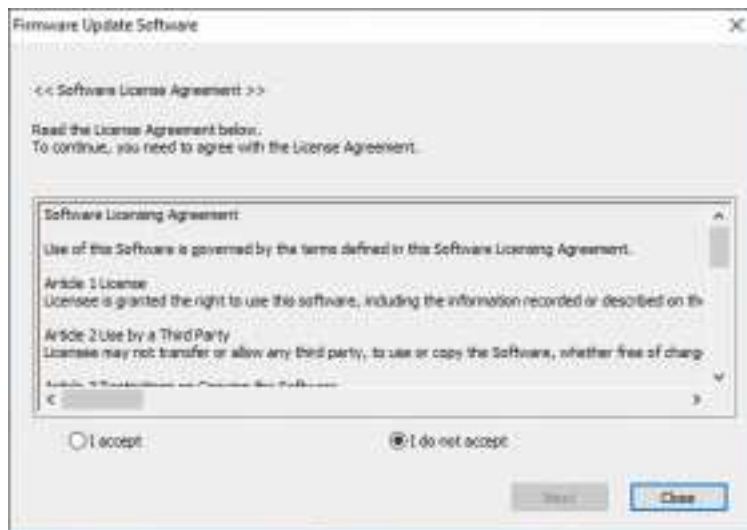

- The update tool will end by clicking [Close].

6) Select [I accept].

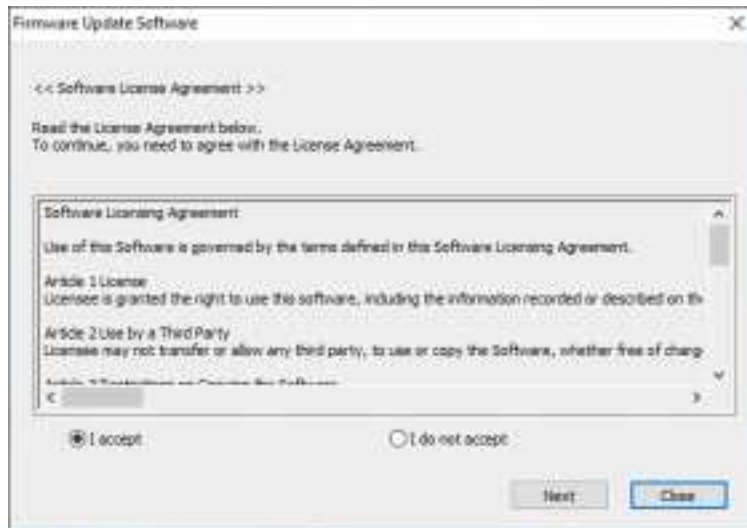

7) Click [Next].

- The connection setting screen is displayed.

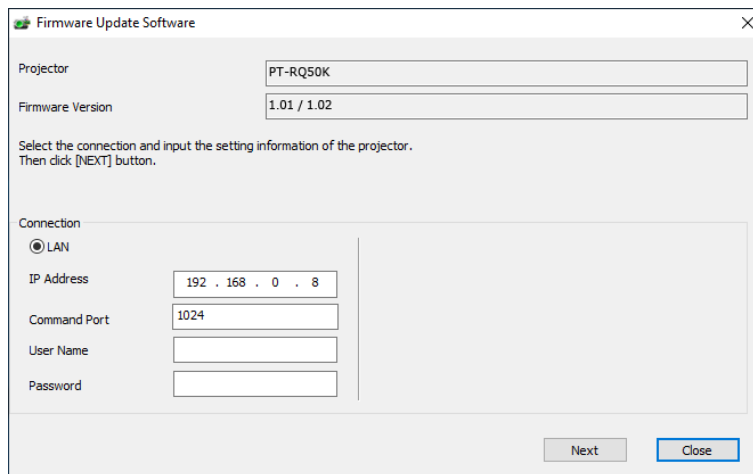

8) Enter the setting details of the projector.

- Enter the details set in the projector to be updated.

Item	Details
[IP Address]	The [NETWORK] menu → [NETWORK STATUS] → [WIRED LAN] → [IP ADDRESS]
[Command Port]	The [NETWORK] menu → [NETWORK CONTROL] → [COMMAND PORT]
[User Name]	[User name] of the administrator rights for web control
[Password]	[Password] of the administrator rights for web control

9) Click [Next].

- The update confirmation screen is displayed.

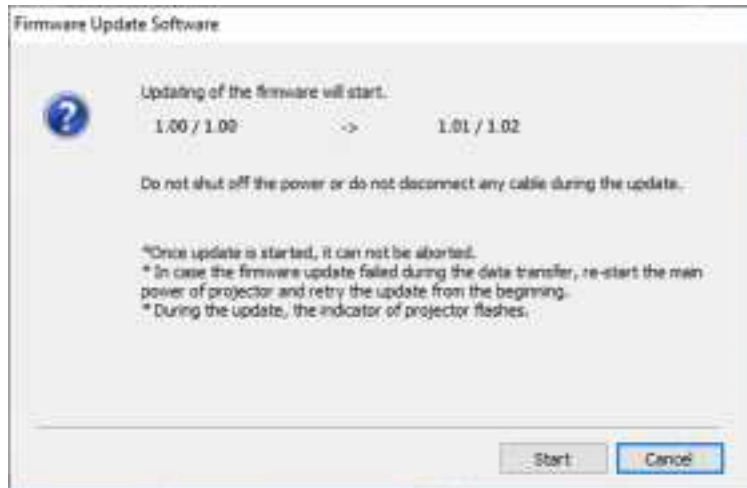

10) Click [Start].

- Update is started.
- The light source indicator <LIGHT1> and the light source indicator <LIGHT2> on the projector blink in red alternately while updating.
- Elapsed time and rough progress can be confirmed in the update status display screen. The required time is approximately 20 minutes.



11) Confirm the completion of the update.

- Once the update is completed, the completion confirmation screen is displayed.

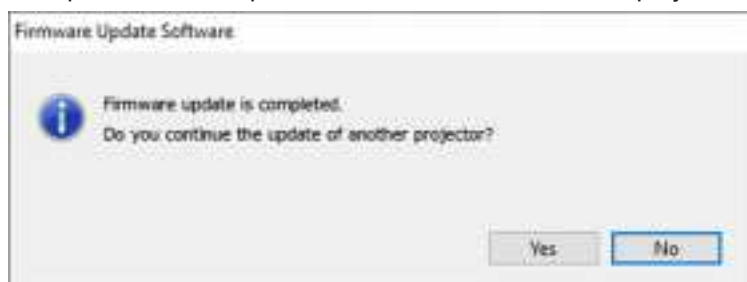

- To continue to update the firmware of another projector, click [Yes]. The connection setting screen in Step 7) is displayed.
- To end the update tool, click [No].

12) Confirm the firmware version.

- Turn on the power of the projector and confirm the firmware version in the [STATUS] screen.

Attention

- Do not disconnect the main power of the projector or disconnect the LAN cable while updating.

Note

- In following cases, turn the power of the projector off and on and perform the update from the beginning.
 - When the update does not complete after 60 minutes or more have elapsed
 - When the power of the projector or the computer has turned off due to power outage, etc., during the update

Updating the firmware using the USB memory

Supported device

- Commercially available USB memory is supported.
The USB memory with a security function is not supported.
- Only the cards formatted in FAT16 or FAT32 can be used.
- Only the single partition structure is supported.

Acquiring the firmware

Download the firmware data for this projector (compressed file in zip format) from the Panasonic website (<https://panasonic.net/cns/projector/pass/>).

- File name (example): RQ50K_USER_101_102.zip
(Firmware data for PT-RQ50K with main version 1.01/network version 1.02)

Preparing the USB memory

Prepare the USB memory to be used for update.

- 1) **Extract the compressed file downloaded from the website.**
 - The firmware data (file in rom format) is generated.
File name (example): RQ50K_USER_101_102.rom
- 2) **Save the firmware data generated by extracting into the USB memory.**
 - Save in the root directory of the formatted USB memory.

Note

- Delete everything other than the firmware data to be used for update from the USB memory.
- For the handling of the USB memory, refer to “Using the USB memory” (➡ page 78).

Updating the firmware

- 1) **Insert the USB memory with the firmware data saved into the <USB> terminal of the projector.**
- 2) **Turn on the power of the projector.**
- 3) **Press the <MENU> button on the remote control or control panel.**
 - The [MAIN MENU] screen is displayed.
- 4) **Press ▲▼ to select [PROJECTOR SETUP].**
- 5) **Press the <ENTER> button.**
 - The [PROJECTOR SETUP] screen is displayed.
- 6) **Press ▲▼ to select [FIRMWARE UPDATE].**
- 7) **Press the <ENTER> button.**
 - The [SECURITY PASSWORD] screen is displayed.
- 8) **Enter a security password and press the <ENTER> button.**
 - The [FIRMWARE UPDATE] screen is displayed.
- 9) **Press ◀▶ to select [OK], and press the <ENTER> button.**
 - Update is started.
 - The projector goes into the standby mode once the update is started, and the light source indicator <LIGHT1> and the light source indicator <LIGHT2> blink in red alternately.

10) Confirm the firmware version.

- Update is completed when the light source indicators <LIGHT1>/<LIGHT2> stop blinking and turn off.
- Turn on the power of the projector and confirm the firmware version in the **[STATUS]** screen.

Attention

- Do not disconnect the main power supply of the projector while updating.

Note

- In following cases, turn the power of the projector off and on and perform the update from the beginning.
 - When the update does not complete after 60 minutes or more have elapsed
 - When the power of the projector has turned off due to power outage, etc., during the update

Chapter 6 Maintenance

This chapter describes inspection methods when there are problems, and maintenance methods.

Light source/temperature indicators

When an indicator lights up

If a problem occurs inside the projector, the light source indicators <LIGHT1>/<LIGHT2> or temperature indicator <TEMP> will inform you by lighting or blinking in red. Check the status of the indicators and take following measures.

Attention

- When switching off the projector to deal with problems, make sure to follow the procedure in “Switching off the projector” (➔ page 68).

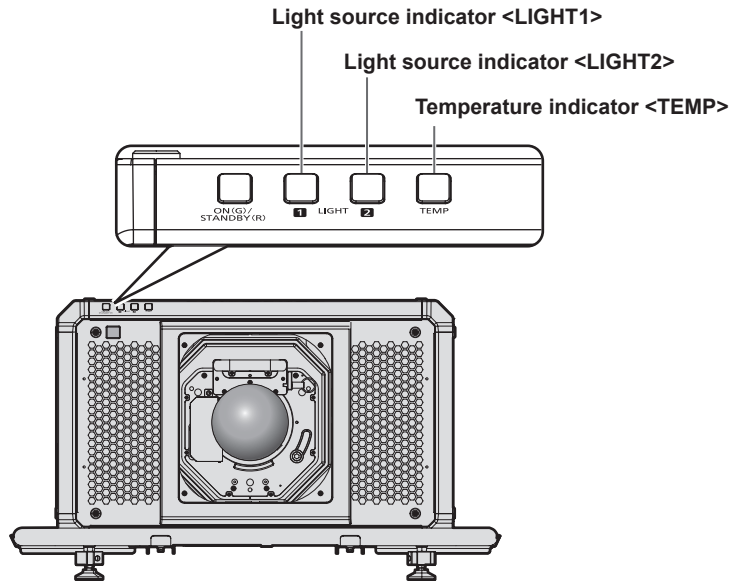

Light source indicators <LIGHT1>/<LIGHT2>

Indicator status	Status	Solution
Lighting in red	<ul style="list-style-type: none"> Some of the elements of the light source are defective and the light output has decreased. 	<ul style="list-style-type: none"> Turn the <MAIN POWER> switch to <OFF> (➔ page 68), and turn on the power again.
Blinking in red (1 time)	<ul style="list-style-type: none"> The light source is turned off since the projection lens cannot be detected. 	<ul style="list-style-type: none"> Turn off the power and mount the projection lens again. (➔ page 49) Turn the <MAIN POWER> switch to <OFF> (➔ page 68), and turn on the power again.
Blinking in red (2 times)	<ul style="list-style-type: none"> The light source does not light up, or the light source turns off while the projector is in use. 	<ul style="list-style-type: none"> Turn the <MAIN POWER> switch to <OFF> (➔ page 68), and turn on the power again.
Blinking in red (3 times)		

Note

- If the light source indicators <LIGHT1>/<LIGHT2> are still lit or blinking after taking the measures, set the <MAIN POWER> switch to <OFF>, and ask your dealer for repairs.
- The light source indicator corresponding to the light source being lit will light up in green if the projector is in projection mode and there is no indication of problem by lighting or blinking in red.

Temperature indicator <TEMP>

Indicator status	Status	Solution
Lighting in red	<ul style="list-style-type: none"> • Warm-up status 	<ul style="list-style-type: none"> • Wait five minutes when the power is turned on while the temperature is low (approximately 0 °C (32 °F)). • Install the projector in a location with the operating environment temperature between 0 °C (32 °F) and 45 °C (113 °F)*1.
	<ul style="list-style-type: none"> • Internal temperature is high (warning). 	<ul style="list-style-type: none"> • Remove any objects if they are blocking the intake/exhaust vents. • Install the projector in a location with the operating environment temperature between 0 °C (32 °F) and 45 °C (113 °F)*1, and ambient humidity between 10 % and 80 % (no condensation).
Blinking in red (2 times)	<ul style="list-style-type: none"> • Internal temperature is high (standby status). 	
Blinking in red (3 times)	<ul style="list-style-type: none"> • The cooling fan has stopped. 	<ul style="list-style-type: none"> • Turn the <MAIN POWER> switch to <OFF> (➔ page 68), and consult your dealer.

*1 The operating environment temperature should be between 0 °C (32 °F) and 40 °C (104 °F) if the projector is used at an altitude between 1 400 m (4 593') and 4 200 m (13 780') above sea level.

Note

- If the temperature indicator <TEMP> is still lit or blinking after taking the measures, ask your dealer for repair.

Maintenance

Before maintenance

- Make sure to turn off the power before performing the maintenance of the projector.
- When switching off the projector, make sure to follow the procedures in “Switching off the projector” (➔ page 68).

Maintenance

Outer case

Wipe off dirt and dust with a soft, dry cloth.

- If the dirt is persistent, soak the cloth with water and wring it thoroughly before wiping. Dry off the projector with a dry cloth.
- Do not use benzene, thinner, or rubbing alcohol, other solvents, or household cleaners. Doing so may deteriorate the outer case.
- When using chemically treated dust cloths, follow the instructions written on its packaging.

Lens front surface

Wipe off dirt and dust from the front surface of the lens with a soft clean cloth.

- Do not use a cloth that is fluffy, dusty, or soaked with oil/water.
- Since the lens is fragile, do not use excessive force when wiping the lens.

Attention

- The lens may become damaged by hitting with a hard object or by wiping the front surface of the lens with excessive force. Handle with care.

Note

- Dust may accumulate around the intake vent depending on the environment and operating condition when used in an environment with excessive dust. This may adversely affect the ventilation, cooling, and heat dissipation inside the projector, thus causing reduced brightness.

Troubleshooting

Review the following points. For details, see the corresponding pages.

Problems	Points to be checked	Page
Power does not turn on.	• Is the power plug firmly inserted into the outlet?	—
	• Is the <MAIN POWER> switch set to <OFF>?	68
	• Is the wall outlet supplying electricity?	—
	• Have the circuit breakers tripped?	—
	• Are the light source indicators <LIGHT1>/<LIGHT2> or the temperature indicator <TEMP> lighting or blinking?	251
No image appears.	• Are connections to external devices correctly performed?	52
	• Is the image input selected correctly?	69
	• Is the [BRIGHTNESS] adjustment setting at a minimum?	90
	• Is the external device that is connected to the projector working properly?	—
	• Is the shutter function in use?	79
	• Is the projection lens attached correctly?	49
	• Is the lens cover still attached to the lens?	61
Image is fuzzy.	• Is the lens focus set correctly?	71
	• Is the projection distance appropriate?	42
	• Is the lens dirty?	26
	• Is the projector installed perpendicular to the screen?	—
Color is pale or grayish.	• Are [COLOR] and [TINT] adjusted correctly?	90
	• Is the external device connected to the projector adjusted correctly?	—
Remote control does not respond.	• Are the batteries depleted?	—
	• Is the polarity of the batteries set correctly?	37
	• Is the button operation disabled by sliding the <LOCK> button on the remote control?	29
	• Are there any obstructions between the remote control and the remote control signal receiver of the projector?	30
	• Is the remote control being used beyond its effective operation range?	30
	• Are other forms of light, such as fluorescent light, affecting the projection?	30
	• Is the [REMOTE CONTROL] setting in [CONTROL DEVICE SETUP] set to [DISABLE]?	185
	• Is the <REMOTE 2 IN> terminal used for contact control?	273
• Is the ID number setting operation correct?	81	
Menu screen does not appear.	• Is the on-screen display function turned off (hidden)?	79
Buttons on the control panel do not operate.	• Is the [CONTROL PANEL] setting in [CONTROL DEVICE SETUP] set to [DISABLE]?	185
	• Is the <REMOTE 2 IN> terminal used for contact control?	273
Image does not display correctly.	• Is the [SYSTEM SELECTOR] selection set correctly?	96, 130
	• Is there a problem with the external device to output images?	—
	• Is a signal which is not compatible with the projector being input?	274
	• Are the settings for [SLOT IN] and [DIGITAL LINK IN] made correctly?	—
Image from a computer does not appear.	• Is the cable too long?	—
	• Is the external video output on the laptop computer set correctly? (Ex.: The external output settings may be switched by pressing the "Fn" + "F3" or "Fn" + "F10" simultaneously. Since the method varies depending on the computer type, refer to the user manual provided with your computer.)	—
Image output from DVI-D of the computer does not appear.	• Is [DVI-D LINK] in [SLOT IN] set correctly? If it is set to [AUTO], the condition may improve by changing the setting to anything other than [AUTO].	121
	• Is the [EDID SELECT] setting in [SLOT IN] set to [EDID3] or [EDID2:PC]?	123
	• The graphics accelerator driver of the computer may need to be updated to the latest version.	—
	• The condition may improve by setting [EDID SELECT] in [SLOT IN] and then restarting the computer.	123
Image from HDMI compatible device does not appear or is disrupted.	• Is the HDMI cable connected securely?	52
	• Turn the power of the projector and the external device off and on.	—
	• Is a signal which is not compatible with the projector being input?	274

Chapter 6 Maintenance — Troubleshooting

Problems	Points to be checked	Page
Image output from DisplayPort of the computer does not appear.	• If connecting the projector to a computer that uses an early-type chipset or graphics card compatible with DisplayPort, the projector or computer may not be operated properly.	278
	• The graphics accelerator driver of the computer may need to be updated to the latest version.	—
	• Turn the power of the projector and the external device off and on.	—
	• Is a signal which is not compatible with the projector being input?	277
Lens shift cannot be adjusted.	• Perform [LENS CALIBRATION].	73
Geometric adjustment is not possible.	• Is [SIMUL INPUT SETTING] set to [AUTO(x2-speed)]?	100
	• Is the video signal with vertical scanning frequency of 100 Hz or 120 Hz being input?	—
Cannot control the projector with Art-Net.	• Are the connections between the twisted-pair-cable transmitter and an external device, and between the twisted-pair-cable transmitter and projector correctly done?	—
	• Is [Art-Net SETUP] set to other than [OFF]?	195
	• Are [NET], [SUB NET], [UNIVERSE], and [START ADDRESS] set correctly?	195
The DIGITAL LINK input image is not displayed.	• Is the cable compatible to the condition of the projector used?	55
	• Are the connections between the twisted-pair-cable transmitter and the projector or an external device correctly done?	—
	• Is [DIGITAL LINK MODE] set to [AUTO], [DIGITAL LINK], or [LONG REACH]? Is it set to [ETHERNET]?	191
	• Is a signal which is not compatible with a twisted-pair-cable transmitter being input?	—
Cannot switch to the input of the Interface Board.	• Is the Interface Board correctly installed in the slot?	294

Attention

- If problems persist even after checking the preceding points, consult your dealer.

Self-diagnosis display

The content of an error or warning is automatically displayed in the information monitor at the side of the projector when it occurs. (➔ page 229)

The following list shows the alphanumeric symbol that is displayed when an error or a warning has occurred and its details. Confirm “Action number”, and follow the measure in “Measure for error and warning” (➔ page 257).

Error/warning alphanumeric symbol	Error/warning alphanumeric symbol content	Action number
U081	Low AC voltage warning (below 90 V)	4
U084	USB power supply error	5
U090	Projection lens not attached	6
U200	Intake air temperature warning	1
U201	Exhaust air temperature warning	2
U255	<AC IN> terminal high temperature warning	10
U202 - U254	Other high temperature warnings	1
U280	Low temperature warning	3
U300	Intake air temperature error	1
U301	Exhaust air temperature error	2
U355	<AC IN> terminal high temperature error	10
U356, U357	Peltier temperature error	2
U302 - U354	Other high temperature errors	1
U380	Low temperature error	3
F011	Shutter error	8
F015	Luminance sensor error	8
F061 - F074	Light source driver communication error	8
F096	Lens mounter error	8
F098	Lens EEPROM error	9
F110 - F113	Phosphor wheel error	8
F400 - F477	Light source error	8
F200 - F263	Fan warning	8
F250 - F263	Liquid cooling pump fan error	8
F300 - F363	Fan error	8
F380 - F383	Peltier driver error	8
H001	Battery replacement for the internal clock	7
H011 - H029	Temperature sensor error	8

Note

- The displayed error/warning symbol may differ from the actual defect.
- For errors and warnings that are not described in the table, consult your dealer.

■ Measure for error and warning

Action number	Measure
1	The operating environment temperature is too high. Use the projector in an appropriate operating environment temperature*1.
2	The operating environment temperature is too high, or the exhaust vent may be blocked. Use the projector in an appropriate operating environment temperature*1. Or remove any objects that are blocking the exhaust vent.
3	The operating environment temperature is too low. Use the projector in an appropriate operating environment temperature*1.
4	The input supply voltage is low. Use electric wiring that can sufficiently withstand the power consumption of the projector.
5	The output total value for the <DC OUT 1> terminal/<DC OUT 2> terminals is too high. The total value of the power supply required for the connected device may be exceeding DC 5 V/2 000 mA. If the display does not clear after the device is removed, consult your dealer.
6	The projection lens cannot be detected. Turn off the power and attach the projection lens again. If the display does not clear after switching the power off and on, consult your dealer.
7	Battery replacement is required. Consult your dealer.
8	If the display does not clear after switching the main power off and on, consult your dealer.
9	The projection lens information cannot be acquired. If the display does not clear after switching the power off and on, consult your dealer.
10	The temperature of the power cord connector is extremely high. Turn off the main power and remove the power cord, and then re-attach the power cord to the <AC IN> terminal. If the display does not clear after the power cord is re-attached, consult your dealer.

*1 Refer to "Operating environment temperature" (➡ page 290) for the operating environment temperature of the projector.

Chapter 7 Appendix

This chapter describes the specification of the projector, how to install the optional Interface Board, and after-sales service.

Technical information

PJLink protocol

The network function of this projector supports the PJLink class 1 and class 2, and setting of the projector or querying of the projector status can be performed from the computer using the PJLink protocol.

Control commands

The following table lists the PJLink protocol commands that can be used to control the projector.

• x characters in tables are non-specific characters.

Class	Command	Control details	Parameter/response string	Remark	
1	POWR	Power supply control	0 1	Standby Power on	
1	POWR ?	Power supply status query	0 1 2	Standby Power on Preparing for switching off the projector	
1, 2	INPT	Input selection	31	SLOT1-1 (input 1 of the Interface Board installed in <SLOT 1>)	<ul style="list-style-type: none"> • 0 = No error is detected • 1 = Warning • 2 = Error
			32	SLOT1-2 (input 2 of the Interface Board installed in <SLOT 1>)	
	INPT ?	Input selection query	33	SLOT1-3 (input 3 of the Interface Board installed in <SLOT 1>)	
			34	SLOT1-4 (input 4 of the Interface Board installed in <SLOT 1>)	
			35	SLOT2-1 (input 1 of the Interface Board installed in <SLOT 2>)	
			36	SLOT2-2 (input 2 of the Interface Board installed in <SLOT 2>)	
			37	SLOT2-3 (input 3 of the Interface Board installed in <SLOT 2>)	
38	SLOT2-4 (input 4 of the Interface Board installed in <SLOT 2>)				
39	DIGITAL LINK				
1	AVMT	Shutter control	30	Shutter function disabled (shutter: opened)	
	AVMT ?	Shutter status query	31	Shutter function enabled (shutter: closed)	
1	ERST ?	Error status query	xxxxxx	1st byte	Indicates fan errors, and returns 0 - 2.
2nd byte				Indicates light source errors, and returns 0 or 2.	
3rd byte				Indicates temperature errors, and returns 0 - 2.	
4th byte				Returns 0.	
5th byte				Returns 0.	
6th byte				Indicates other errors, and returns 0 - 2.	
1	LAMP ?	Light source status query	AAAA X BBBB Y	AAAA: Light source 1 runtime X: 0 = Light source 1 off, 1 = Light source 1 on BBBB: Light source 2 runtime Y: 0 = Light source 2 off, 1 = Light source 2 on	
1, 2	INST ?	Input selection list query	31 32 33 34 35 36 37 38 39	—	
1	NAME ?	Projector name query	xxxxx	Returns the name set in [PROJECTOR NAME] of [NETWORK SETUP].	
1	INF1 ?	Manufacturer name query	Panasonic	Returns manufacturer name.	
1	INF2 ?	Model name query	PT-RQ50K	Returns model name.	
1	INF0 ?	Other information queries	xxxxx	Returns information such as version number.	
1	CLSS ?	Class information query	2	Returns class for PJLink.	
2	SNUM ?	Serial number query	xxxxxxxxx	Returns serial number.	
2	SVER ?	Software version query	xxxxxxxxx	Returns version number.	

Class	Command	Control details	Parameter/response string	Remark
2	INNM ?	Input terminal name query	31 / SLOT1-1	SLOT1-1 (name of the input 1 of the Interface Board installed in <SLOT 1>)
			32 / SLOT1-2	SLOT1-2 (name of the input 2 of the Interface Board installed in <SLOT 1>)
			33 / SLOT1-3	SLOT1-3 (name of the input 3 of the Interface Board installed in <SLOT 1>)
			34 / SLOT1-4	SLOT1-4 (name of the input 4 of the Interface Board installed in <SLOT 1>)
			35 / SLOT2-1	SLOT2-1 (name of the input 1 of the Interface Board installed in <SLOT 2>)
			36 / SLOT2-2	SLOT2-2 (name of the input 2 of the Interface Board installed in <SLOT 2>)
			37 / SLOT2-3	SLOT2-3 (name of the input 3 of the Interface Board installed in <SLOT 2>)
			38 / SLOT2-4	SLOT2-4 (name of the input 4 of the Interface Board installed in <SLOT 2>)
			39 / DIGITAL LINK	
2	IRES ?	Input signal resolution query	AAAAxBBBB	AAAA: Horizontal resolution BBBB: Vertical resolution
2	RRES ?	Recommended resolution query	4096x2160	Returns display resolution.
2	FREZ	Freeze control	0	Freeze clear
	FREZ ?	Freeze status query	1	Freeze (stop)
2	POWR	Cooling notification	0	Notifies when the power is turned off.
		Warmup notification	1	Notifies when the power is turned on.
2	ERST	Error notification	xxxxxx	Notifies when an error occurs.
2	LKUP	Link up notification	xx:xx:xx:xx:xx:xx	Notifies the MAC address when the PJLink communication becomes possible.
2	INPT	Input switch completion notification	31	SLOT1-1 (input 1 of the Interface Board installed in <SLOT 1>)
			32	SLOT1-2 (input 2 of the Interface Board installed in <SLOT 1>)
			33	SLOT1-3 (input 3 of the Interface Board installed in <SLOT 1>)
			34	SLOT1-4 (input 4 of the Interface Board installed in <SLOT 1>)
			35	SLOT2-1 (input 1 of the Interface Board installed in <SLOT 2>)
			36	SLOT2-2 (input 2 of the Interface Board installed in <SLOT 2>)
			37	SLOT2-3 (input 3 of the Interface Board installed in <SLOT 2>)
			38	SLOT2-4 (input 4 of the Interface Board installed in <SLOT 2>)
			39	DIGITAL LINK
2	SRCH	Projector search	ACKN=xx:xx:xx:xx:xx:xx	The projector connected to the same network that can communicate with PJLink will respond with its MAC address.

PJLink security authentication

The password used for PJLink is the same as that of the password set for web control.

When using the projector without security authentication, do not set a password for web control.

- For specifications related to PJLink, visit the website of Japan Business Machine and Information System Industries Association.

URL <http://pjlink.jbmia.or.jp/english/>

Using Art-Net function

Since the network function of the projector supports the Art-Net function, you can control the projector settings with the DMX controller and application software using the Art-Net protocol.

Channel definition

The following table lists the channel definitions used for controlling the projector with the Art-Net function. Channel settings can be switched using the [NETWORK] menu → [Art-Net CHANNEL SETTING] (➡ page 195).

The control details assigned to each channel are listed in the following table.

- Channel assignment for [USER] is in factory default setting. Assignment can be changed.

Channel	Control details			
	[1]	[2]	[3]	[USER]
CHANNEL1	SHUTTER	LIGHT OUTPUT	LIGHT OUTPUT	LIGHT OUTPUT
CHANNEL2	NONE	INPUT SELECT	INPUT SELECT	INPUT SELECT
CHANNEL3	LENS FUNCTION SELECT	LENS POSITION	LENS POSITION	LENS POSITION
CHANNEL4	LENS CONTROL	LENS H SHIFT	LENS H SHIFT	LENS H SHIFT
CHANNEL5	POWER	LENS V SHIFT	LENS V SHIFT	LENS V SHIFT
CHANNEL6	LIGHT OUTPUT	LENS FOCUS	LENS FOCUS MSB	LENS FOCUS
CHANNEL7	ENABLE/DISABLE	LENS ZOOM	LENS FOCUS LSB	LENS ZOOM
CHANNEL8	FADE-IN	POWER	LENS ZOOM MSB	POWER
CHANNEL9	FADE-OUT	GEOMETRY	LENS ZOOM LSB	GEOMETRY
CHANNEL10	NONE	NONE	SHUTTER	NONE
CHANNEL11	GEOMETRY	ENABLE/DISABLE	ENABLE/DISABLE	ENABLE/DISABLE
CHANNEL12	NONE	NONE	NONE	NONE

Content that can be controlled by each Art-Net channel setting

✓: Can be controlled

Control details	Art-Net channel setting			
	[1]	[2]	[3]	[USER]
LIGHT OUTPUT	✓	✓	✓	✓
INPUT SELECT	—	✓	✓	✓
LENS FUNCTION SELECT	✓	—	—	—
LENS CONTROL	✓	—	—	—
LENS POSITION	—	✓	✓	✓
LENS H SHIFT	—	✓	✓	✓
LENS V SHIFT	—	✓	✓	✓
LENS FOCUS	—	✓	—	✓
LENS ZOOM	—	✓	—	✓
POWER	✓	✓	—	✓
SHUTTER	✓	—	✓	✓
FADE-IN	✓	—	—	✓
FADE-OUT	✓	—	—	✓
GEOMETRY	✓	✓	—	✓
FREEZE	—	—	—	✓
COLOR	—	—	—	✓
TINT	—	—	—	✓
RASTER PATTERN	—	—	—	✓
LENS H SHIFT MSB	—	—	—	✓
LENS H SHIFT LSB	—	—	—	✓
LENS V SHIFT MSB	—	—	—	✓
LENS V SHIFT LSB	—	—	—	✓
LENS FOCUS MSB	—	—	✓	✓
LENS FOCUS LSB	—	—	✓	✓
LENS ZOOM MSB	—	—	✓	✓

Control details	Art-Net channel setting			
	[1]	[2]	[3]	[USER]
LENS ZOOM LSB	—	—	✓	✓
ENABLE/DISABLE	✓	✓	✓	✓

Control details

■ LIGHT OUTPUT

This can be set in 256 steps between 100 % and 0 %.

Performance	Parameter	Default value
100 %	0	0
...	...	
0 %	255	

■ INPUT SELECT

Performance	Parameter	Default value
No operation	0-39	0
DIGITAL LINK	40-47	
No operation	48-79	
SLOT1-1* ¹	80-87	
SLOT1-2* ¹	88-95	
SLOT2-3* ²	96-103	
SLOT2-4* ²	104-111	
No operation	112-151	
SLOT1-1* ³	152-159	
SLOT1-2* ³	160-167	
SLOT1-3* ³	168-175	
SLOT1-4* ³	176-183	
SLOT2-1* ⁴	184-191	
SLOT2-2* ⁴	192-199	
SLOT2-3* ⁴	200-207	
SLOT2-4* ⁴	208-215	
No operation	216-255	

*1 When the Interface Board equipped with two inputs is installed in <SLOT 1>, the input is switched to the specified input of the Interface Board.

*2 When the Interface Board equipped with two inputs is installed in <SLOT 2>, the input is switched to the specified input of the Interface Board.

*3 When the Interface Board equipped with four inputs is installed in <SLOT 1>, the input is switched to the specified input of the Interface Board.

*4 When the Interface Board equipped with four inputs is installed in <SLOT 2>, the input is switched to the specified input of the Interface Board.

■ LENS FUNCTION SELECT

Operate together with LENS CONTROL.

Performance	Parameter	Default value
No operation	0-15	0
LENS H SHIFT	16-31	
LENS V SHIFT	32-47	
LENS FOCUS	48-63	
LENS ZOOM	64-79	
Move to the home position	80-95	
Load LENS MEMORY 1	96-111	
Load LENS MEMORY 2	112-127	
Load LENS MEMORY 3	128-143	
No operation	144-255	

■ LENS CONTROL

Operate together with LENS FUNCTION SELECT.

Performance		Parameter	Default value
Lens adjustment	(-) High speed	0-31	100
	(-) Low speed	32-63	
	(-) Fine adjustment	64-95	
Operation stop		96-127	
Lens adjustment	(+) Fine adjustment	128-159	
	(+) Low speed	160-191	
	(+) High speed	192-223	
Execute command action		224-255	

■ LENS POSITION

Performance	Parameter	Default value
No operation	0-31	0
Move to the home position	32-63	
Load LENS MEMORY 1	64-79	
Load LENS MEMORY 2	80-95	
Load LENS MEMORY 3	96-111	
Load LENS MEMORY 4	112-127	
Load LENS MEMORY 5	128-143	
Load LENS MEMORY 6	144-159	
Load LENS MEMORY 7	160-175	
Load LENS MEMORY 8	176-191	
Load LENS MEMORY 9	192-207	
Load LENS MEMORY 10	208-223	
No operation	224-255	

■ LENS H SHIFT, LENS V SHIFT, LENS FOCUS, LENS ZOOM

Performance		Parameter	Default value
Lens adjustment	(-) High speed	0-31	128
	(-) Low speed	32-63	
	(-) Fine adjustment	64-95	
Operation stop		96-159	
Lens adjustment	(+) Fine adjustment	160-191	
	(+) Low speed	192-223	
	(+) High speed	224-255	

■ POWER

Performance	Parameter	Default value
Standby	0-63	128
No operation	64-191	
Power on	192-255	

■ SHUTTER

Performance	Parameter	Default value
SHUTTER: Opened	0-63	128
No operation	64-191	
SHUTTER: Closed	192-255	

■ FADE-IN, FADE-OUT

Operate together with SHUTTER.

Performance	Parameter	Default value
OFF	0-15	255
0.5s	16-31	
1.0s	32-47	
1.5s	48-63	
2.0s	64-79	
2.5s	80-95	
3.0s	96-111	
3.5s	112-127	
4.0s	128-143	
5.0s	144-159	
7.0s	160-175	
10.0s	176-191	
No operation	192-255	

■ GEOMETRY

Performance	Parameter	Default value
OFF	0-15	255
KEystone	16-31	
CURVED CORRECTION	32-47	
PC-1	48-63	
PC-2	64-79	
PC-3	80-95	
CORNER/PINCUSHION	96-111	
No operation	112-255	

■ FREEZE

Performance	Parameter	Default value
No operation	0-31	128
OFF	32-95	
No operation	96-159	
ON	160-223	
No operation	224-255	

■ COLOR, TINT

Performance	Parameter	Default value
No operation	0-31	0
Factory default setting	32-63	
-31	64	
...	...	
0	128-129	
...	...	
+31	191	
No operation	192-255	

■ RASTER PATTERN

Performance	Parameter	Default value
No operation	0-15	0
OFF	16-31	
WHITE	32-47	
YELLOW	48-63	
CYAN	64-79	
GREEN	80-95	
MAGENTA	96-111	
RED	112-127	
BLUE	128-143	
BLACK	144-159	
USER LOGO	160-175	
No operation	176-255	

■ LENS H SHIFT MSB, LENS V SHIFT MSB, LENS FOCUS MSB, LENS ZOOM MSB

Operate LENS H SHIFT MSB together with LENS H SHIFT LSB.

Operate LENS V SHIFT MSB together with LENS V SHIFT LSB.

Operate LENS FOCUS MSB together with LENS FOCUS LSB.

Operate LENS ZOOM MSB together with LENS ZOOM LSB.

Performance	Parameter	Default value
No operation	0-15	0
Coarse adjustment	16-255	

■ LENS H SHIFT LSB, LENS V SHIFT LSB, LENS FOCUS LSB, LENS ZOOM LSB

Operate LENS H SHIFT LSB together with LENS H SHIFT MSB.

Operate LENS V SHIFT LSB together with LENS V SHIFT MSB.

Operate LENS FOCUS LSB together with LENS FOCUS MSB.

Operate LENS ZOOM LSB together with LENS ZOOM MSB.

Performance	Parameter	Default value
No operation	0-15	0
Fine adjustment	16-255	

■ ENABLE/DISABLE

Operation for all channels is not accepted when set to “Disable”.

Performance	Parameter	Default value
Disable	0-127	0
Enable	128-255	

Note

- If the projector is operated using the remote control or the control panel, or by the control command while controlling the projector using the Art-Net function, the setting of the DMX controller or computer application may be different from the projector status. To reflect the controls of all channels to the projector, set “ENABLE/DISABLE” of channel 11 to “Disable” and then back to “Enable”.
- To create and register the USER LOGO image, use “Logo Transfer Software”. The software can be downloaded from the Panasonic website (<https://panasonic.net/cns/projector/>).

Control commands via LAN

When web control administrator rights password is set (Protect mode)

Connecting

- 1) Obtain the IP address and port number (Initial set value = 1024) of the projector and request a connection to the projector.
 - You can obtain both the IP address and the port number from the menu screen of the projector.

IP address	Obtain from the [NETWORK] menu → [NETWORK STATUS].
Port number	Obtain from the [NETWORK] menu → [NETWORK CONTROL] → [COMMAND PORT].

- 2) Check the response from the projector.

	Data section	Blank	Mode	Blank	Random number section	Termination symbol
Command example	"NTCONTROL" (ASCII string)	' '	'1'	' '	"zzzzzzzz" (ASCII code hex number)	(CR) 0x0d
Data length	9 bytes	1 byte	1 byte	1 byte	8 bytes	1 byte

- Mode: 1 = Protect mode
- Example: Response during protect mode (random number section is undefined value)
"NTCONTROL 1 23181e1e" (CR)

- 3) Generate a 32-byte hash value from the following data using MD5 algorithm.

- "xxxxxx:yyyyy:zzzzzzzz"

xxxxxx	Administrator rights user name for the web control (default user name is "dispadmin")
yyyyy	Password of above administrator rights user (default password is "@Panasonic")
zzzzzzzz	8-byte random number obtained in Step 2)

Command transmission method

Transmit using the following command formats.

■ Transmitted data

	Header			Data section	Termination symbol
Command example	Hash value "Connecting" (➔ page 266)	'0'	'0'	Control command (ASCII string)	(CR) 0x0d
Data length	32 bytes	1 byte	1 byte	Undefined length	1 byte

- Example: Transmission of power supply status acquisition command (hash value is calculated from default user name, password, and acquired random number)
"dbdd2dabd3d4d68c5dd970ec0c29fa6400QPW" (CR)

■ Received data

	Header		Data section	Termination symbol
Command example	'0'	'0'	Control command (ASCII string)	(CR) 0x0d
Data length	1 byte	1 byte	Undefined length	1 byte

- Example: The projector is powered on
"00001" (CR)

■ Error response

	String	Details	Termination symbol
Message	"ERR1"	Undefined control command	(CR) 0x0d
	"ERR2"	Out of parameter range	
	"ERR3"	Busy state or no-acceptable period	
	"ERR4"	Timeout or no-acceptable period	
	"ERR5"	Wrong data length	
	"ERRA"	Password mismatch	
Data length	4 bytes	—	1 byte

Note

- The projector will automatically disconnect the connection with the network right after sending the command. This is the specification based on the security view point to prevent unauthorized operation of this product by a malicious third party. To send commands continuously, execute the network connection request every time the command is to be sent. For details, refer to "Communication flow between server and client" (➔ page 268).

When web control administrator rights password is not set (Non-protect mode)

Connecting

- 1) Obtain the IP address and port number (Initial set value = 1024) of the projector and request a connection to the projector.

- You can obtain both the IP address and the port number from the menu screen of the projector.

IP address	Obtain from the [NETWORK] menu → [NETWORK STATUS].
Port number	Obtain from the [NETWORK] menu → [NETWORK CONTROL] → [COMMAND PORT].

- 2) Check the response from the projector.

	Data section	Blank	Mode	Termination symbol
Command example	"NTCONTROL" (ASCII string)	' ' 0x20	'0' 0x30	(CR) 0x0d
Data length	9 bytes	1 byte	1 byte	1 byte

- Mode: 0 = Non-protect mode
- Example: Response during non-protect mode
"NTCONTROL 0" (CR)

Command transmission method

Transmit using the following command formats.

■ Transmitted data

	Header		Data section	Termination symbol
Command example	'0' 0x30	'0' 0x30	Control command (ASCII string)	(CR) 0x0d
Data length	1 byte	1 byte	Undefined length	1 byte

- Example: Transmission of power supply status acquisition command
"00QPW" (CR)

■ Received data

	Header		Data section	Termination symbol
Command example	'0' 0x30	'0' 0x30	Control command (ASCII string)	(CR) 0x0d
Data length	1 byte	1 byte	Undefined length	1 byte

- Example: The projector is in standby status
"00000" (CR)

■ Error response

	String	Details	Termination symbol
Message	"ERR1"	Undefined control command	(CR) 0x0d
	"ERR2"	Out of parameter range	
	"ERR3"	Busy state or no-acceptable period	
	"ERR4"	Timeout or no-acceptable period	
	"ERR5"	Wrong data length	
	"ERRA"	Password mismatch	
Data length	4 bytes	—	1 byte

Note

- The projector will automatically disconnect the connection with the network right after sending the command. This is the specification based on the security view point to prevent unauthorized operation of this product by a malicious third party. To send commands continuously, execute the network connection request every time the command is to be sent. For details, refer to "Communication flow between server and client" (➔ page 268).

Communication flow between server and client

To send/receive a command via LAN, refer to the communication flow indicated below.

Server: Projector

Client: Control device such as a computer

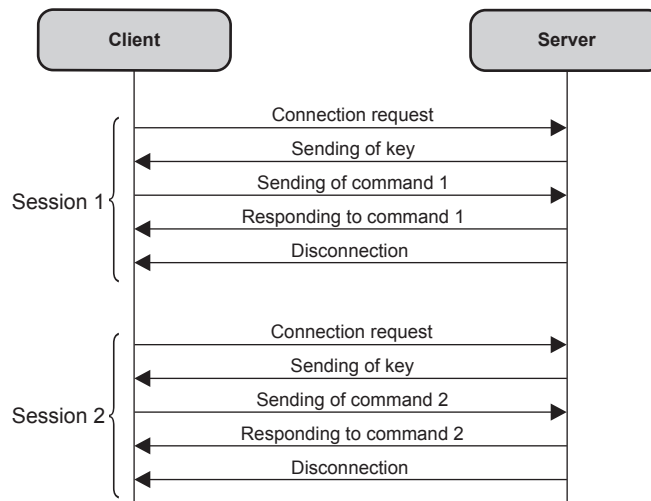

<SERIAL IN>/<SERIAL OUT> terminal

The <SERIAL IN>/<SERIAL OUT> terminal of the projector conforms with RS-232C so that the projector can be connected to and controlled from a computer.

Connection

Single projector

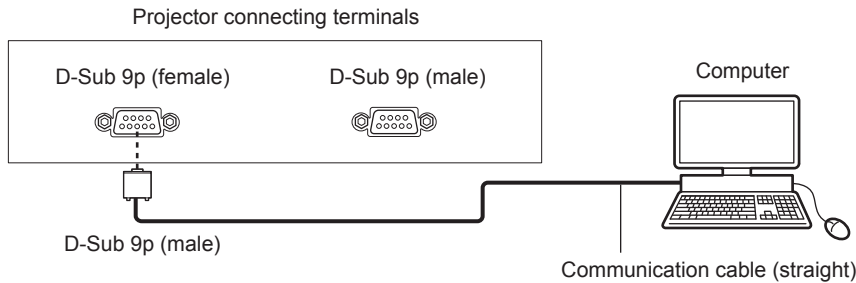

Multiple projectors

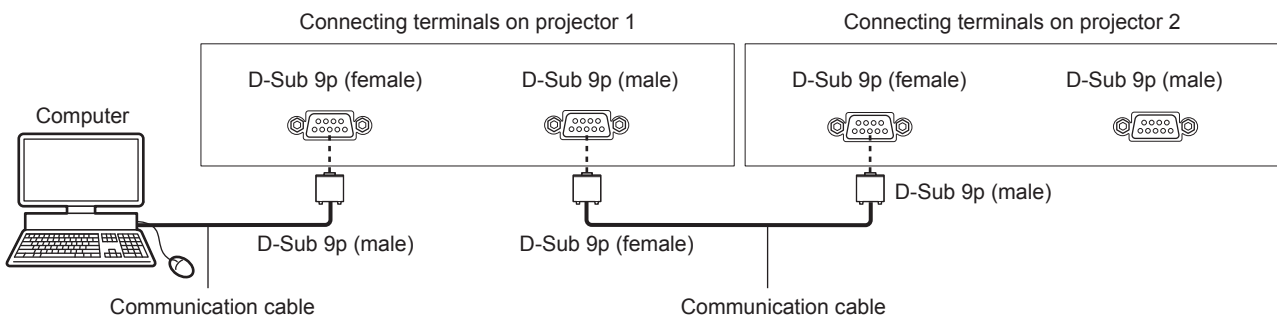

When connecting using DIGITAL LINK compatible device

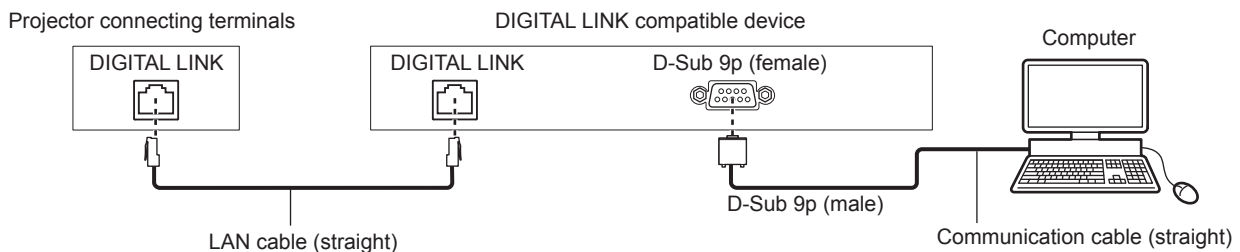

Note

- The destination of [RS-232C] (➔ page 170) must be set according to the connection method.

Pin assignments and signal names

D-Sub 9-pin (female) Outside view	Pin No.	Signal name	Details
	(1)	—	NC
	(2)	TXD	Transmitted data
	(3)	RXD	Received data
	(4)	—	NC
	(5)	GND	Earth
	(6)	—	NC
	(7)	CTS	Connected internally
	(8)	RTS	
	(9)	—	NC

D-Sub 9-pin (male) Outside view	Pin No.	Signal name	Details
	(1)	—	NC
	(2)	RXD	Received data
	(3)	TXD	Transmitted data
	(4)	—	NC
	(5)	GND	Earth
	(6)	—	NC
	(7)	RTS	Connected internally
	(8)	CTS	
	(9)	—	NC

Communication conditions (Factory default)

Signal level	RS-232C-compliant
Sync. method	Asynchronous
Baud rate	9 600 bps
Parity	None
Character length	8 bits
Stop bit	1 bit
X parameter	None
S parameter	None

Basic format

Transmission from the computer starts with STX, then the ID, command, parameter, and ETX are sent in this order. Add parameters according to the details of control.

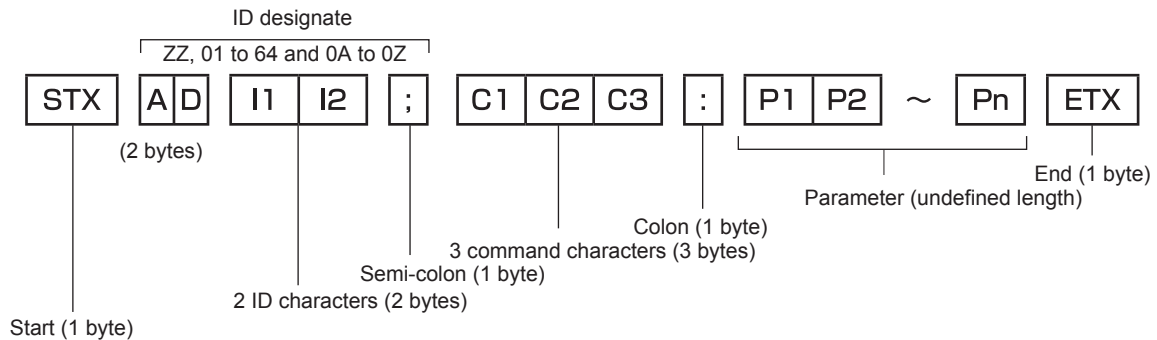

Basic format (has subcommands)

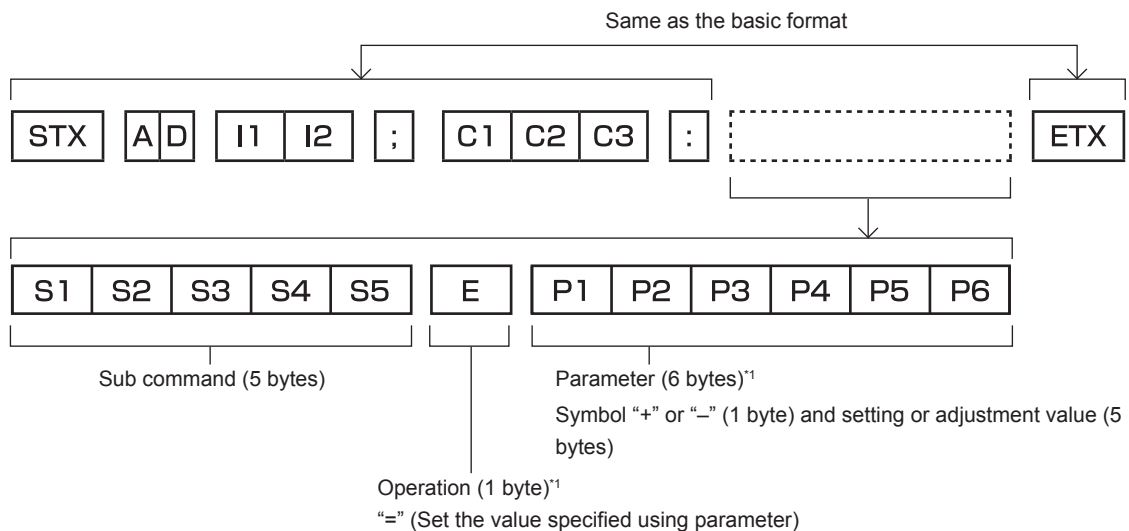

*1 When transmitting a command which does not need a parameter, an operation (E) and parameter are not necessary.

Attention

- If a command is sent after the light source starts lighting, there may be a delay in response or the command may not be executed. Try sending or receiving any command after 60 seconds.
- When transmitting multiple commands, be sure to wait until 0.5 seconds has elapsed after receiving the response from the projector before sending the next command. When transmitting a command which does not need a parameter, a colon (:) is not necessary.

Note

- If a command cannot be executed, the “ER401” response is sent from the projector to the computer.
- If an invalid parameter is sent, the “ER402” response is sent from the projector to the computer.
- ID transmission in RS-232C supports ZZ (ALL) and 01 to 64, as well as 0A to 0Z groups.
- If a command is sent with an ID designated, a response will be sent to the computer only in the following cases.
 - It matches the projector ID
 - ID is designated as ALL and [RESPONSE(ID ALL)] is set to [ON]
 - ID is designated as GROUP and [RESPONSE(ID GROUP)] is set to [ON]
- STX and ETX are character codes. STX shown in hexadecimal is 02, and ETX shown in hexadecimal is 03.

When multiple projectors are controlled

When multiple projectors are all controlled

When controlling multiple projectors together via RS-232C, perform the following settings.

- 1) Set a different ID for each projector.
- 2) Set [RESPONSE(ID ALL)] to [ON] in only one projector.
- 3) Set [RESPONSE(ID ALL)] to [OFF] for all other projectors set in Step 2).

When multiple projectors are all controlled by group unit

When controlling multiple projectors by group unit via RS-232C, perform the following settings.

- 1) Set a different ID for each projector.
- 2) Set the same setting for [GROUP] in each group.
- 3) Set [RESPONSE(ID GROUP)] to [ON] in only one projector.
- 4) Set [RESPONSE(ID GROUP)] to [OFF] for all other projectors set in Step 3).

Note

- Response is not made correctly if [RESPONSE(ID ALL)] is set to [ON] in two or more projectors.
- When setting multiple groups, set [RESPONSE(ID GROUP)] to [ON] in only one projector in each group. Response is not made correctly if [RESPONSE(ID GROUP)] is set to [ON] in two or more projectors of the same group.

Cable specification

When connected to a computer

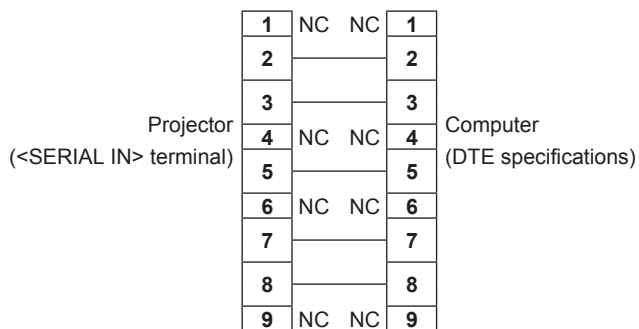

When multiple projectors are connected

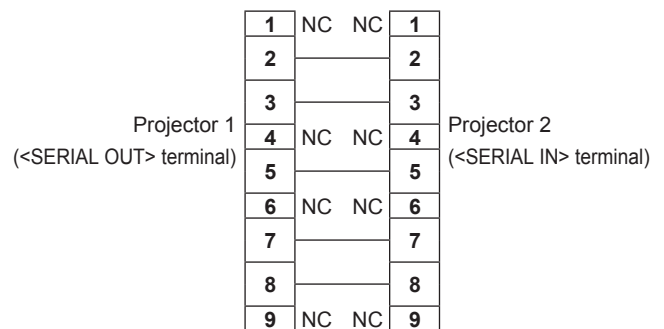

Control command

The following table lists the commands that can be used to control the projector using a computer.

■ Projector control command

Command	Details	Parameter/response string	Remark (parameter)
PON	Power on	—	To check if the power is on, use the “Power query” command.
POF	Power standby		
QPW	Power query	000 001	STANDBY Power on
IIS	Switching the input signal	DL1 AU1,SD1*1 AU1,SD2*1 AU1,SD3*2 AU1,SD4*2 AU2,SD1*3 AU2,SD2*3 AU2,SD3*4 AU2,SD4*4 AU1,HD1*1 AU1,HD2*1 AU2,HD3*4 AU2,HD4*4 AU1,DV1*1 AU1,DV2*1 AU2,DV3*4 AU2,DV4*4 AU1,DP1*1 AU1,DP2*1 AU2,DP3*4 AU2,DP4*4	DIGITAL LINK SDI1 [SLOT1] SDI2 [SLOT1] SDI3 [SLOT1] SDI4 [SLOT1] SDI1 [SLOT2] SDI2 [SLOT2] SDI3 [SLOT2] SDI4 [SLOT2] HDMI1 [SLOT1] HDMI2 [SLOT1] HDMI3 [SLOT2] HDMI4 [SLOT2] DVI-D1 [SLOT1] DVI-D2 [SLOT1] DVI-D3 [SLOT2] DVI-D4 [SLOT2] DisplayPort1 [SLOT1] DisplayPort2 [SLOT1] DisplayPort3 [SLOT2] DisplayPort4 [SLOT2]
OSH	Shutter control	0	Opened
QSH	Shutter status query	1	Closed
VSE	Aspect ratio switch	0 1 2 5 6	DEFAULT 4:3 16:9 THROUGH HV FIT
QSE	Aspect ratio settings query	9 10	H FIT V FIT
OCS	Sub memory switch	01 - 96	Sub memory number
QSB	Sub memory status query		

*1 This can be used when the optional Interface Board equipped with corresponding input is installed in <SLOT 1>.

*2 This can be used when the Interface Board for 12G-SDI (Model No.: ET-MDN12G10) is installed in <SLOT 1>.

*3 This can be used when the Interface Board for 12G-SDI (Model No.: ET-MDN12G10) is installed in <SLOT 2>.

*4 This can be used when the optional Interface Board equipped with corresponding input is installed in <SLOT 2>.

■ Lens control command

Command	Sub command	Details	Remark
VXX	LNSI2	Lens H shift	+00000 = Fine adjustment 1+, +00001 = Fine adjustment 1-, +00100 = Fine adjustment 2+, +00101 = Fine adjustment 2-, +00200 = Coarse adjustment+, +00201 = Coarse adjustment-
VXX	LNSI3	Lens V shift	
VXX	LNSI4	Lens focus	
VXX	LNSI5	Lens zoom	

<REMOTE 2 IN> terminal

It is possible to control the projector remotely (by contact control) from a control board located away from the projector where remote control signals cannot reach.

Use the <REMOTE 2 IN> terminal on the connecting terminals of the projector to connect to the control board.

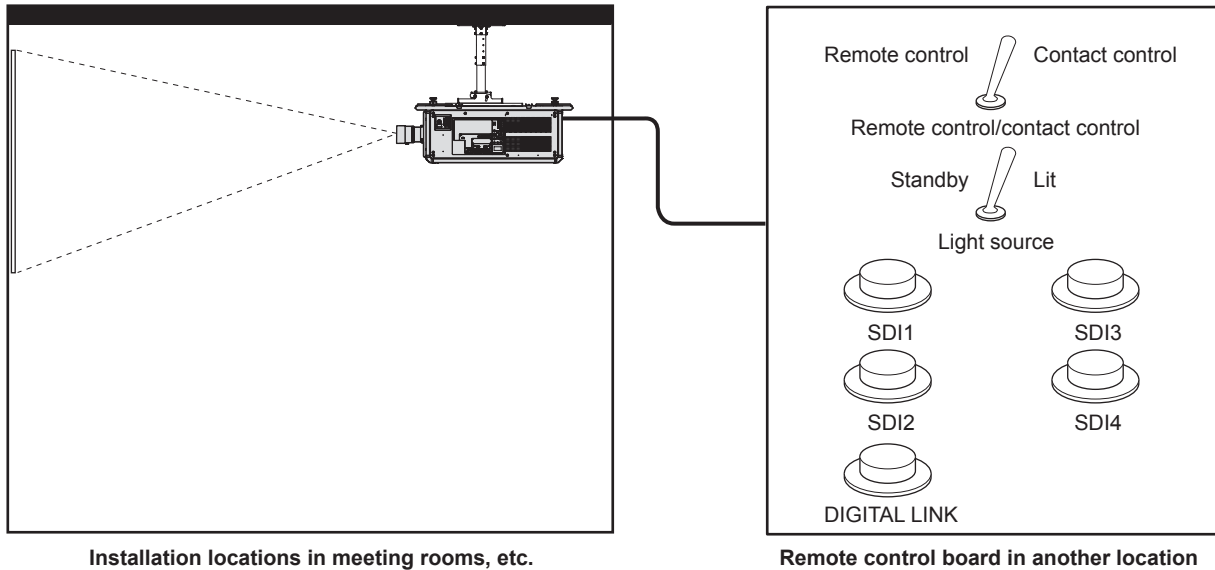

Pin assignments and signal names

D-Sub 9-pin Outside view	Pin No.	Signal name	Open (H)	Short (L)
	(1)	GND	—	GND
	(2)	POWER	OFF	ON
	(3)	None	—	—
	(4)	None	—	—
	(5)	None	—	—
	(6)	None	—	—
	(7)	DIGITAL LINK	Other	DIGITAL LINK
	(8)	SHUTTER	OFF	ON
	(9)	ENABLE / DISABLE	Controlled by remote control	Controlled by external contact

Attention

- When controlling, make sure to short-circuit pins (1) and (9).
- When pins (1) and (9) are short-circuited, the following buttons on the control panel and the remote control are disabled. Commands for RS-232C and network functions corresponding to these functions are also disabled.
 - Power on <|> button, power standby <ϕ> button, <SHUTTER> button
- When pins (1) and (9) are short-circuited, and then any pins from (3) to (7) and the pin (1) are short-circuited, the following buttons on the control panel and the remote control are disabled. Commands for RS-232C and network functions corresponding to these functions are also disabled.
 - Power on <|> button, power standby <ϕ> button, <SDI> button, <DIGITAL LINK> button, <HDMI> button, <DVI-D> button, <DISPLAYPORT> button, <SLOT 1> button, <SLOT 2> button, <INPUT MENU> button, <SHUTTER> button

Note

- To change the settings of pins (2) to (8), set [REMOTE2 MODE] to [USER]. (► page 172)

List of compatible signals

The following table specifies the video signals that the projector can project.

For details of DisplayPort signal, refer to “List of DisplayPort compatible signals” (➔ page 277).

For details of SDI signal, refer to “List of single link SDI compatible signals” (➔ page 279), “List of dual link SDI compatible signals” (➔ page 283), “List of quad link SDI compatible signals” (➔ page 286).

This projector supports the signal with ✓ in the compatible signal column.

- The content of the compatible signal column is as follows.
 - 1: Single link (displays one image using one input signal.)
 - 2: Quad link (displays one image using four input signals.)

Signal name (SIGNAL FORMAT)	Resolution (Dots)	Scanning freq.		Dot clock freq. (MHz)	Compatible signal				
		Horizontal (kHz)	Vertical (Hz)		DIGITAL LINK	HDMI ¹		DVI-D ²	
						1	1	2	1
480/60p	720 x 480	31.5	59.9	27.0	✓	✓	—	✓	—
576/50p	720 x 576	31.3	50.0	27.0	✓	✓	—	✓	—
720/60p	1 280 x 720	45.0	60.0 ³	74.3	✓	✓	—	✓	—
720/50p	1 280 x 720	37.5	50.0	74.3	✓	✓	—	✓	—
720/120p	1 280 x 720	90.0	120.0 ³	148.5	—	✓	—	—	—
1080/60i	1 920 x 1 080i	33.8	60.0 ³	74.3	✓	✓	—	✓	—
1080/50i	1 920 x 1 080i	28.1	50.0	74.3	✓	✓	—	✓	—
1080/24p	1 920 x 1 080	27.0	24.0 ³	74.3	✓	✓	—	✓	—
1080/24sF	1 920 x 1 080i	27.0	48.0 ³	74.3	✓	✓	—	✓	—
1080/25p	1 920 x 1 080	28.1	25.0	74.3	✓	✓	—	✓	—
1080/30p	1 920 x 1 080	33.8	30.0 ³	74.3	✓	✓	—	✓	—
1080/60p	1 920 x 1 080	67.5	60.0 ³	148.5	✓	✓	—	✓	—
1080/50p	1 920 x 1 080	56.3	50.0	148.5	✓	✓	—	✓	—
1080/120p	1 920 x 1 080	135.0	120.0 ³	297.0	—	✓	—	—	—
2K/24p	2 048 x 1 080	27.0	24.0 ³	74.3	✓	✓	—	✓	—
2K/25p	2 048 x 1 080	28.1	25.0	74.3	✓	✓	—	✓	—
2K/30p	2 048 x 1 080	33.8	30.0 ³	74.3	✓	✓	—	✓	—
2K/48p	2 048 x 1 080	54.0	48.0 ³	148.5	✓	✓	—	✓	—
2K/60p	2 048 x 1 080	67.5	60.0 ³	148.5	✓	✓	—	✓	—
2K/50p	2 048 x 1 080	56.3	50.0	148.5	✓	✓	—	✓	—
3840 x 2160/24p	3 840 x 2 160	54.0	24.0 ³	297.0	✓	✓	✓	—	✓
3840 x 2160/25p	3 840 x 2 160	56.3	25.0	297.0	✓	✓	✓	—	✓
3840 x 2160/30p	3 840 x 2 160	67.5	30.0 ³	297.0	✓	✓	✓	—	✓
3840 x 2160/60p	3 840 x 2 160	135.0	60.0 ³	297.0	✓ ^{*4}	✓ ^{*4}	—	—	—
	3 840 x 2 160	135.0	60.0 ³	594.0	—	✓	✓	—	✓
3840 x 2160/50p	3 840 x 2 160	112.5	50.0	297.0	✓ ^{*4}	✓ ^{*4}	—	—	—
	3 840 x 2 160	112.5	50.0	594.0	—	✓	✓	—	✓
4096 x 2160/24p	4 096 x 2 160	54.0	24.0 ³	297.0	✓	✓	✓	—	✓
4096 x 2160/25p	4 096 x 2 160	56.3	25.0	297.0	✓	✓	✓	—	✓
4096 x 2160/30p	4 096 x 2 160	67.5	30.0 ³	297.0	✓	✓	✓	—	✓
4096 x 2160/60p	4 096 x 2 160	135.0	60.0 ³	297.0	✓ ^{*4}	✓ ^{*4}	—	—	—
	4 096 x 2 160	135.0	60.0 ³	594.0	—	✓	✓	—	✓
4096 x 2160/50p	4 096 x 2 160	112.5	50.0	297.0	✓ ^{*4}	✓ ^{*4}	—	—	—
	4 096 x 2 160	112.5	50.0	594.0	—	✓	✓	—	✓
640 x 480/60	640 x 480	31.5	59.9	25.2	✓	✓	—	✓	—
1024 x 768/50	1 024 x 768	39.6	50.0	51.9	✓	✓	—	✓	—
1024 x 768/60	1 024 x 768	48.4	60.0	65.0	✓	✓	—	✓	—
1280 x 800/50	1 280 x 800	41.3	50.0	68.0	✓	✓	—	✓	—
1280 x 800/60	1 280 x 800	49.7	59.8	83.5	✓	✓	—	✓	—
1280 x 1024/50	1 280 x 1 024	52.4	50.0	88.0	✓	✓	—	✓	—
1280 x 1024/60	1 280 x 1 024	64.0	60.0	108.0	✓	✓	—	✓	—
1366 x 768/50	1 366 x 768	39.6	49.9	69.0	✓	✓	—	✓	—
1366 x 768/60	1 366 x 768	47.7	59.8	85.5	✓	✓	—	✓	—

Chapter 7 Appendix — Technical information

Signal name (SIGNAL FORMAT)	Resolution (Dots)	Scanning freq.		Dot clock freq. (MHz)	Compatible signal				
		Horizontal (kHz)	Vertical (Hz)		DIGITAL LINK	HDMI ^{*1}		DVI-D ^{*2}	
						1	1	2	1
1400 x 1050/50	1 400 x 1 050	54.1	50.0	99.9	✓	✓	—	✓	—
1400 x 1050/60	1 400 x 1 050	65.2	60.0	122.6	✓	✓	—	✓	—
1440 x 900/50	1 440 x 900	46.3	49.9	86.8	✓	✓	—	✓	—
1440 x 900/60	1 440 x 900	55.9	59.9	106.5	✓	✓	—	✓	—
1600 x 900/50	1 600 x 900	46.4	49.9	96.5	✓	✓	—	✓	—
1600 x 900/60	1 600 x 900	55.9	60.0	119.0	✓	✓	—	✓	—
1600 x 1200/50	1 600 x 1 200	61.8	49.9	131.5	✓	✓	—	✓	—
1600 x 1200/60	1 600 x 1 200	75.0	60.0	162.0	✓	✓	—	✓	—
1680 x 1050/50	1 680 x 1 050	54.1	50.0	119.5	✓	✓	—	✓	—
1680 x 1050/60	1 680 x 1 050	65.3	60.0	146.3	✓	✓	—	✓	—
1920 x 1200/50	1 920 x 1 200	61.8	49.9	158.3	✓	✓	—	✓	—
1920 x 1200/60RB	1 920 x 1 200 ^{*5}	74.0	60.0	154.0	✓	✓	—	✓	—

- *1 This is supported when the optional Interface Board for HDMI 2 input (Model No.: ET-MDNHM10) is installed in the slot.
Quad link is supported only when the optional Interface Board for HDMI 2 input (Model No.: ET-MDNHM10) is installed on both <SLOT 1> and <SLOT 2>.
- *2 This is supported when the optional Interface Board for DVI-D 2 input (Model No.: ET-MDNDV10) is installed in the slot.
Quad link is supported only when the optional Interface Board for DVI-D 2 input (Model No.: ET-MDNDV10) is installed on both <SLOT 1> and <SLOT 2>.
- *3 The signal with 1/1.001x vertical scanning frequency is also supported.
- *4 YP_BP_R 4:2:0 format only
- *5 VESA CVT-RB (Reduced Blanking)-compliant

Note

- The “i” at the end of the resolution indicates an interlaced signal.
- When interlaced signals are connected, flickering may occur on the projected image.
- Following settings will be disabled and fixed to [OFF] when an image with 720/120p or 1080/120p is being displayed.
 - The [POSITION] menu → [GEOMETRY]

List of plug and play compatible signals

The following table specifies the video signals compatible with plug and play.

Signal with ✓ in the plug and play compatible signal column is the signal described in the EDID (extended display identification data) of the projector. For the signal without ✓ in the plug and play compatible signal column, the resolution may not be selected on the computer even if the projector is supporting it.

Signal name (SIGNAL FORMAT)	Resolution (Dots)	Scanning freq.		Dot clock freq. (MHz)	Plug and play compatible signal								
		Horizontal (kHz)	Vertical (Hz)		DIGITAL LINK			HDMI ¹			DVI-D ²		
					4K/60p	4K/30p ³	2K	4K/60p ⁴	4K/30p	2K	EDID1	EDID2	EDID3
480/60p	720 x 480	31.5	59.9	27.0	✓	✓	✓	✓	✓	✓	✓	—	✓
576/50p	720 x 576	31.3	50.0	27.0	✓	✓	✓	✓	✓	✓	✓	—	✓
720/60p	1 280 x 720	45.0	60.0	74.3	✓	✓	✓	✓	✓	✓	✓	—	✓
720/50p	1 280 x 720	37.5	50.0	74.3	✓	✓	✓	✓	✓	✓	✓	—	✓
720/120p	1 280 x 720	90.0	120.0	148.5	—	—	—	—	—	—	—	—	—
1080/60i	1 920 x 1 080i	33.8	60.0	74.3	✓	✓	✓	✓	✓	✓	✓	—	✓
1080/50i	1 920 x 1 080i	28.1	50.0	74.3	✓	✓	✓	✓	✓	✓	✓	—	✓
1080/24p	1 920 x 1 080	27.0	24.0	74.3	✓	✓	✓	✓	✓	✓	✓	—	✓
1080/24sF	1 920 x 1 080i	27.0	48.0	74.3	—	—	—	—	—	—	—	—	—
1080/25p	1 920 x 1 080	28.1	25.0	74.3	✓	✓	✓	✓	✓	✓	✓	—	✓
1080/30p	1 920 x 1 080	33.8	30.0	74.3	✓	✓	✓	✓	✓	✓	✓	—	✓
1080/60p	1 920 x 1 080	67.5	60.0	148.5	✓	✓	✓	✓	✓	✓	✓	—	✓
1080/50p	1 920 x 1 080	56.3	50.0	148.5	✓	✓	✓	✓	✓	✓	✓	—	✓
1080/120p	1 920 x 1 080	135.0	120.0	297.0	—	—	—	—	—	—	—	—	—
2K/24p	2 048 x 1 080	27.0	24.0	74.3	—	—	—	—	—	—	—	—	—
2K/25p	2 048 x 1 080	28.1	25.0	74.3	—	—	—	—	—	—	—	—	—
2K/30p	2 048 x 1 080	33.8	30.0	74.3	—	—	—	—	—	—	—	—	—
2K/48p	2 048 x 1 080	54.0	48.0	148.5	—	—	—	—	—	—	—	—	—
2K/60p	2 048 x 1 080	67.5	60.0	148.5	—	—	—	—	—	—	—	—	—
2K/50p	2 048 x 1 080	56.3	50.0	148.5	—	—	—	—	—	—	—	—	—
3840 x 2160/24p	3 840 x 2 160	54.0	24.0	297.0	✓	✓	—	✓	✓	—	—	—	—
3840 x 2160/25p	3 840 x 2 160	56.3	25.0	297.0	✓	✓	—	✓	✓	—	—	—	—
3840 x 2160/30p	3 840 x 2 160	67.5	30.0	297.0	✓	✓	—	✓	✓	—	—	—	—
3840 x 2160/60p	3 840 x 2 160	135.0	60.0	297.0	✓ ^{*5}	—	—	✓ ^{*5}	—	—	—	—	—
	3 840 x 2 160	135.0	60.0	594.0	—	—	—	✓	—	—	—	—	—
3840 x 2160/50p	3 840 x 2 160	112.5	50.0	297.0	✓ ^{*5}	—	—	✓ ^{*5}	—	—	—	—	—
	3 840 x 2 160	112.5	50.0	594.0	—	—	—	✓	—	—	—	—	—
4096 x 2160/24p	4 096 x 2 160	54.0	24.0	297.0	✓	✓	—	✓	✓	—	—	—	—
4096 x 2160/25p	4 096 x 2 160	56.3	25.0	297.0	✓	✓	—	✓	✓	—	—	—	—
4096 x 2160/30p	4 096 x 2 160	67.5	30.0	297.0	✓	✓	—	✓	✓	—	—	—	—
4096 x 2160/60p	4 096 x 2 160	135.0	60.0	297.0	✓ ^{*5}	—	—	✓ ^{*5}	—	—	—	—	—
	4 096 x 2 160	135.0	60.0	594.0	—	—	—	✓	—	—	—	—	—
4096 x 2160/50p	4 096 x 2 160	112.5	50.0	297.0	✓ ^{*5}	—	—	✓ ^{*5}	—	—	—	—	—
	4 096 x 2 160	112.5	50.0	594.0	—	—	—	✓	—	—	—	—	—
640 x 480/60	640 x 480	31.5	59.9	25.2	✓	✓	✓	✓	✓	✓	✓	✓	✓
1024 x 768/50	1 024 x 768	39.6	50.0	51.9	—	—	—	—	—	—	—	—	—
1024 x 768/60	1 024 x 768	48.4	60.0	65.0	✓	✓	✓	✓	✓	✓	—	✓	✓
1280 x 800/50	1 280 x 800	41.3	50.0	68.0	—	—	—	—	—	—	—	—	—
1280 x 800/60	1 280 x 800	49.7	59.8	83.5	—	—	—	—	—	—	—	—	—
1280 x 1024/50	1 280 x 1 024	52.4	50.0	88.0	—	—	—	—	—	—	—	—	—
1280 x 1024/60	1 280 x 1 024	64.0	60.0	108.0	—	—	—	—	—	—	—	—	—
1366 x 768/50	1 366 x 768	39.6	49.9	69.0	—	—	—	—	—	—	—	—	—
1366 x 768/60	1 366 x 768	47.7	59.8	85.5	—	—	—	—	—	—	—	—	—
1400 x 1050/50	1 400 x 1 050	54.1	50.0	99.9	—	—	—	—	—	—	—	—	—
1400 x 1050/60	1 400 x 1 050	65.2	60.0	122.6	✓	✓	✓	✓	✓	✓	—	✓	✓
1440 x 900/50	1 440 x 900	46.3	49.9	86.8	—	—	—	—	—	—	—	—	—
1440 x 900/60	1 440 x 900	55.9	59.9	106.5	—	—	—	—	—	—	—	—	—
1600 x 900/50	1 600 x 900	46.4	49.9	96.5	—	—	—	—	—	—	—	—	—

Signal name (SIGNAL FORMAT)	Resolution (Dots)	Scanning freq.		Dot clock freq. (MHz)	Plug and play compatible signal								
		Horizontal (kHz)	Vertical (Hz)		DIGITAL LINK			HDMI ^{*1}			DVI-D ^{*2}		
					4K/60p	4K/30p ^{*3}	2K	4K/60p ^{*4}	4K/30p	2K	EDID1	EDID2	EDID3
1600 x 900/60	1 600 x 900	55.9	60.0	119.0	✓	✓	✓	✓	✓	✓	—	✓	✓
1600 x 1200/50	1 600 x 1 200	61.8	49.9	131.5	—	—	—	—	—	—	—	—	—
1600 x 1200/60	1 600 x 1 200	75.0	60.0	162.0	✓	✓	✓	✓	✓	✓	—	✓	✓
1680 x 1050/50	1 680 x 1 050	54.1	50.0	119.5	—	—	—	—	—	—	—	—	—
1680 x 1050/60	1 680 x 1 050	65.3	60.0	146.3	—	—	—	—	—	—	—	—	—
1920 x 1200/50	1 920 x 1 200	61.8	49.9	158.3	—	—	—	—	—	—	—	—	—
1920 x 1200/60RB	1 920 x 1 200 ^{*6}	74.0	60.0	154.0	✓	✓	✓	✓	✓	✓	—	✓	✓

*1 This is supported when the optional Interface Board for HDMI 2 input (Model No.: ET-MDNHM10) is installed in the slot.

*2 This is supported when the optional Interface Board for DVI-D 2 input (Model No.: ET-MDNDV10) is installed in the slot.

*3 4K/30p indicates 4K/30p/SDR and 4K/30p/HDR.

*4 4K/60p indicates 4K/60p/SDR and 4K/60p/HDR.

*5 YP_bP_R 4:2:0 format only

*6 VESA CVT-RB (Reduced Blanking)-compliant

List of DisplayPort compatible signals

The following table specifies the DisplayPort signals that the projector can project. This is supported when the optional Interface Board for DisplayPort 2 input (Model No.: ET-MDNDP10) is installed in the slot.

Signal with ✓ in the plug and play compatible signal column is the signal described in the EDID (extended display identification data) of the projector. For the signal without ✓ in the plug and play compatible signal column, the resolution may not be selected on the computer even if the projector is supporting it.

Signal name (SIGNAL FORMAT)	Resolution (Dots)	Scanning freq.		Dot clock freq. (MHz)	Plug and play compatible signal		
		Horizontal (kHz)	Vertical (Hz)		4K/60p/HDR 4K/60p/SDR	4K/30p	2K
720/60p	1 280 x 720	45.0	60.0 ^{*1}	74.3	✓	✓	✓
720/50p	1 280 x 720	37.5	50.0	74.3	✓	✓	✓
720/120p	1 280 x 720	90.0	120.0 ^{*1}	148.5	—	—	—
1080/24p	1 920 x 1 080	27.0	24.0 ^{*1}	74.3	✓	✓	✓
1080/25p	1 920 x 1 080	28.1	25.0	74.3	✓	✓	✓
1080/30p	1 920 x 1 080	33.8	30.0 ^{*1}	74.3	✓	✓	✓
1080/60p	1 920 x 1 080	67.5	60.0 ^{*1}	148.5	✓	✓	✓
1080/50p	1 920 x 1 080	56.3	50.0	148.5	✓	✓	✓
1080/120p	1 920 x 1 080	135.0	120.0 ^{*1}	297.0	—	—	—
2K/24p	2 048 x 1 080	27.0	24.0 ^{*1}	74.3	—	—	—
2K/25p	2 048 x 1 080	28.1	25.0	74.3	—	—	—
2K/30p	2 048 x 1 080	33.8	30.0 ^{*1}	74.3	—	—	—
2K/48p	2 048 x 1 080	54.0	48.0 ^{*1}	148.5	—	—	—
2K/60p	2 048 x 1 080	67.5	60.0 ^{*1}	148.5	—	—	—
2K/50p	2 048 x 1 080	56.3	50.0	148.5	—	—	—
3840 x 2160/24p	3 840 x 2 160	54.0	24.0 ^{*1}	297.0	✓	✓	—
3840 x 2160/25p	3 840 x 2 160	56.3	25.0	297.0	✓	✓	—
3840 x 2160/30p	3 840 x 2 160	67.5	30.0 ^{*1}	297.0	✓	✓	—
3840 x 2160/60p	3 840 x 2 160	135.0	60.0 ^{*1}	594.0	✓	—	—
3840 x 2160/50p	3 840 x 2 160	112.5	50.0	594.0	✓	—	—
4096 x 2160/24p	4 096 x 2 160	54.0	24.0 ^{*1}	297.0	✓	✓	—
4096 x 2160/25p	4 096 x 2 160	56.3	25.0	297.0	✓	✓	—
4096 x 2160/30p	4 096 x 2 160	67.5	30.0 ^{*1}	297.0	✓	✓	—
4096 x 2160/60p	4 096 x 2 160	135.0	60.0 ^{*1}	594.0	✓	—	—
4096 x 2160/50p	4 096 x 2 160	112.5	50.0	594.0	✓	—	—
640 x 480/60	640 x 480	31.5	59.9	25.2	✓	✓	✓
1024 x 768/50	1 024 x 768	39.6	50.0	51.9	—	—	—
1024 x 768/60	1 024 x 768	48.4	60.0	65.0	✓	✓	✓
1280 x 800/50	1 280 x 800	41.3	50.0	68.0	—	—	—
1280 x 800/60	1 280 x 800	49.7	59.8	83.5	—	—	—
1400 x 1050/50	1 400 x 1 050	54.1	50.0	99.9	—	—	—

Chapter 7 Appendix — Technical information

Signal name (SIGNAL FORMAT)	Resolution (Dots)	Scanning freq.		Dot clock freq. (MHz)	Plug and play compatible signal		
		Horizontal (kHz)	Vertical (Hz)		4K/60p/HDR 4K/60p/SDR	4K/30p	2K
1400 x 1050/60	1 400 x 1 050	65.2	60.0	122.6	✓	✓	✓
1600 x 900/50	1 600 x 900	46.4	49.9	96.5	—	—	—
1600 x 900/60	1 600 x 900	55.9	60.0	119.0	✓	✓	✓
1600 x 1200/50	1 600 x 1 200	61.8	49.9	131.5	—	—	—
1600 x 1200/60	1 600 x 1 200	75.0	60.0	162.0	✓	✓	✓
1920 x 1200/50	1 920 x 1 200	61.8	49.9	158.3	—	—	—
1920 x 1200/60RB	1 920 x 1 200*2	74.0	60.0	154.0	✓	✓	✓

*1 The signal with 1/1.001x vertical scanning frequency is also supported.

*2 VESA CVT-RB (Reduced Blanking)-compliant

Note

- Following settings will be disabled and fixed to [OFF] when an image with 720/120p or 1080/120p is being displayed.
 - The [POSITION] menu → [GEOMETRY]
- If connecting the projector to a computer that uses an early-type chipset or graphics card compatible with DisplayPort, the projector or computer may not be operated properly when the signal output from DisplayPort on the computer is input to the projector. In such a case, switch off the projector or computer and then switch it on.
If the signal output from DisplayPort is input to the projector, use of the computer equipped with the latest chipset or graphics card is recommended.

List of single link SDI compatible signals

The following table specifies the single link SDI signals that the projector can project.

- The content of the 4K division column is as follows.
 - SQ: Square (transmission format of Square Division)
 - IL: Interleave (transmission format of 2-Sample Interleave Division)

Signal name (SIGNAL FORMAT)	Resolution (Dots)	Scanning freq.		Dot clock freq. (MHz)	4K division	Format	Color format	Sampling
		Horizontal (kHz)	Vertical (Hz)					
720/60p	1 280 x 720	45.0	60.0 ^{*1}	74.3	—	HD-SDI	YP _B P _R	4:2:2 10bit
720/50p	1 280 x 720	37.5	50.0	74.3	—	HD-SDI	YP _B P _R	4:2:2 10bit
1080/60i	1 920 x 1 080i	33.8	60.0 ^{*1}	74.3	—	HD-SDI	YP _B P _R	4:2:2 10bit
	1 920 x 1 080i	33.8	60.0 ^{*1}	74.3	—	3G-SDI Level-A	YP _B P _R	4:4:4 10bit
	1 920 x 1 080i	33.8	60.0 ^{*1}	74.3	—	3G-SDI Level-B	YP _B P _R	4:4:4 10bit
	1 920 x 1 080i	33.8	60.0 ^{*1}	74.3	—	3G-SDI Level-A	YP _B P _R	4:4:4 12bit
	1 920 x 1 080i	33.8	60.0 ^{*1}	74.3	—	3G-SDI Level-B	YP _B P _R	4:4:4 12bit
	1 920 x 1 080i	33.8	60.0 ^{*1}	74.3	—	3G-SDI Level-A	RGB	4:4:4 10bit
	1 920 x 1 080i	33.8	60.0 ^{*1}	74.3	—	3G-SDI Level-B	RGB	4:4:4 10bit
	1 920 x 1 080i	33.8	60.0 ^{*1}	74.3	—	3G-SDI Level-A	RGB	4:4:4 12bit
1080/50i	1 920 x 1 080i	28.1	50.0	74.3	—	HD-SDI	YP _B P _R	4:2:2 10bit
	1 920 x 1 080i	28.1	50.0	74.3	—	3G-SDI Level-A	YP _B P _R	4:4:4 10bit
	1 920 x 1 080i	28.1	50.0	74.3	—	3G-SDI Level-B	YP _B P _R	4:4:4 10bit
	1 920 x 1 080i	28.1	50.0	74.3	—	3G-SDI Level-A	YP _B P _R	4:4:4 12bit
	1 920 x 1 080i	28.1	50.0	74.3	—	3G-SDI Level-B	YP _B P _R	4:4:4 12bit
	1 920 x 1 080i	28.1	50.0	74.3	—	3G-SDI Level-A	RGB	4:4:4 10bit
	1 920 x 1 080i	28.1	50.0	74.3	—	3G-SDI Level-B	RGB	4:4:4 10bit
	1 920 x 1 080i	28.1	50.0	74.3	—	3G-SDI Level-A	RGB	4:4:4 12bit
1080/24p	1 920 x 1 080	27.0	24.0 ^{*1}	74.3	—	HD-SDI	YP _B P _R	4:2:2 10bit
	1 920 x 1 080	27.0	24.0 ^{*1}	74.3	—	3G-SDI Level-A	YP _B P _R	4:4:4 10bit
	1 920 x 1 080	27.0	24.0 ^{*1}	74.3	—	3G-SDI Level-B	YP _B P _R	4:4:4 10bit
	1 920 x 1 080	27.0	24.0 ^{*1}	74.3	—	3G-SDI Level-A	YP _B P _R	4:4:4 12bit
	1 920 x 1 080	27.0	24.0 ^{*1}	74.3	—	3G-SDI Level-B	YP _B P _R	4:4:4 12bit
	1 920 x 1 080	27.0	24.0 ^{*1}	74.3	—	3G-SDI Level-A	RGB	4:4:4 10bit
	1 920 x 1 080	27.0	24.0 ^{*1}	74.3	—	3G-SDI Level-B	RGB	4:4:4 10bit
	1 920 x 1 080	27.0	24.0 ^{*1}	74.3	—	3G-SDI Level-A	RGB	4:4:4 12bit
1080/24sF	1 920 x 1 080i	27.0	48.0 ^{*1}	74.3	—	HD-SDI	YP _B P _R	4:2:2 10bit
	1 920 x 1 080i	27.0	48.0 ^{*1}	74.3	—	3G-SDI Level-A	RGB	4:4:4 10bit
	1 920 x 1 080i	27.0	48.0 ^{*1}	74.3	—	3G-SDI Level-B	RGB	4:4:4 10bit
	1 920 x 1 080i	27.0	48.0 ^{*1}	74.3	—	3G-SDI Level-A	RGB	4:4:4 12bit
	1 920 x 1 080i	27.0	48.0 ^{*1}	74.3	—	3G-SDI Level-B	RGB	4:4:4 12bit
1080/25p	1 920 x 1 080	28.1	25.0	74.3	—	HD-SDI	YP _B P _R	4:2:2 10bit
	1 920 x 1 080	28.1	25.0	74.3	—	3G-SDI Level-A	YP _B P _R	4:4:4 10bit
	1 920 x 1 080	28.1	25.0	74.3	—	3G-SDI Level-B	YP _B P _R	4:4:4 10bit
	1 920 x 1 080	28.1	25.0	74.3	—	3G-SDI Level-A	YP _B P _R	4:4:4 12bit
	1 920 x 1 080	28.1	25.0	74.3	—	3G-SDI Level-B	YP _B P _R	4:4:4 12bit
	1 920 x 1 080	28.1	25.0	74.3	—	3G-SDI Level-A	RGB	4:4:4 10bit
	1 920 x 1 080	28.1	25.0	74.3	—	3G-SDI Level-B	RGB	4:4:4 10bit
	1 920 x 1 080	28.1	25.0	74.3	—	3G-SDI Level-A	RGB	4:4:4 12bit
1 920 x 1 080	28.1	25.0	74.3	—	3G-SDI Level-B	RGB	4:4:4 12bit	

Chapter 7 Appendix — Technical information

Signal name (SIGNAL FORMAT)	Resolution (Dots)	Scanning freq.		Dot clock freq. (MHz)	4K division	Format	Color format	Sampling
		Horizontal (kHz)	Vertical (Hz)					
1080/30p	1 920 x 1 080	33.8	30.0 ¹	74.3	—	HD-SDI	YP _B P _R	4:2:2 10bit
	1 920 x 1 080	33.8	30.0 ¹	74.3	—	3G-SDI Level-A	YP _B P _R	4:4:4 10bit
	1 920 x 1 080	33.8	30.0 ¹	74.3	—	3G-SDI Level-B	YP _B P _R	4:4:4 10bit
	1 920 x 1 080	33.8	30.0 ¹	74.3	—	3G-SDI Level-A	YP _B P _R	4:4:4 12bit
	1 920 x 1 080	33.8	30.0 ¹	74.3	—	3G-SDI Level-B	YP _B P _R	4:4:4 12bit
	1 920 x 1 080	33.8	30.0 ¹	74.3	—	3G-SDI Level-A	RGB	4:4:4 10bit
	1 920 x 1 080	33.8	30.0 ¹	74.3	—	3G-SDI Level-B	RGB	4:4:4 10bit
	1 920 x 1 080	33.8	30.0 ¹	74.3	—	3G-SDI Level-A	RGB	4:4:4 12bit
	1 920 x 1 080	33.8	30.0 ¹	74.3	—	3G-SDI Level-B	RGB	4:4:4 12bit
1080/60p	1 920 x 1 080	67.5	60.0 ¹	148.5	—	3G-SDI Level-A	YP _B P _R	4:2:2 10bit
	1 920 x 1 080	67.5	60.0 ¹	148.5	—	3G-SDI Level-B	YP _B P _R	4:2:2 10bit
	1 920 x 1 080 ²	67.5	60.0 ¹	148.5	—	6G-SDI Type 1	YP _B P _R	4:4:4 10bit
	1 920 x 1 080 ²	67.5	60.0 ¹	148.5	—	6G-SDI Type 1	YP _B P _R	4:4:4 12bit
	1 920 x 1 080 ²	67.5	60.0 ¹	148.5	—	6G-SDI Type 1	RGB	4:4:4 10bit
	1 920 x 1 080 ²	67.5	60.0 ¹	148.5	—	6G-SDI Type 1	RGB	4:4:4 12bit
1080/50p	1 920 x 1 080	56.3	50.0	148.5	—	3G-SDI Level-A	YP _B P _R	4:2:2 10bit
	1 920 x 1 080	56.3	50.0	148.5	—	3G-SDI Level-B	YP _B P _R	4:2:2 10bit
	1 920 x 1 080 ²	56.3	50.0	148.5	—	6G-SDI Type 1	YP _B P _R	4:4:4 10bit
	1 920 x 1 080 ²	56.3	50.0	148.5	—	6G-SDI Type 1	YP _B P _R	4:4:4 12bit
	1 920 x 1 080 ²	56.3	50.0	148.5	—	6G-SDI Type 1	RGB	4:4:4 10bit
	1 920 x 1 080 ²	56.3	50.0	148.5	—	6G-SDI Type 1	RGB	4:4:4 12bit
2K/24p	2 048 x 1 080	27.0	24.0 ¹	74.3	—	3G-SDI Level-A	YP _B P _R	4:4:4 10bit
	2 048 x 1 080	27.0	24.0 ¹	74.3	—	3G-SDI Level-B	YP _B P _R	4:4:4 10bit
	2 048 x 1 080	27.0	24.0 ¹	74.3	—	3G-SDI Level-A	YP _B P _R	4:4:4 12bit
	2 048 x 1 080	27.0	24.0 ¹	74.3	—	3G-SDI Level-B	YP _B P _R	4:4:4 12bit
	2 048 x 1 080	27.0	24.0 ¹	74.3	—	3G-SDI Level-A	RGB	4:4:4 10bit
	2 048 x 1 080	27.0	24.0 ¹	74.3	—	3G-SDI Level-B	RGB	4:4:4 10bit
	2 048 x 1 080	27.0	24.0 ¹	74.3	—	3G-SDI Level-A	RGB	4:4:4 12bit
	2 048 x 1 080	27.0	24.0 ¹	74.3	—	3G-SDI Level-B	RGB	4:4:4 12bit
2K/25p	2 048 x 1 080	28.1	25.0	74.3	—	3G-SDI Level-A	YP _B P _R	4:4:4 10bit
	2 048 x 1 080	28.1	25.0	74.3	—	3G-SDI Level-B	YP _B P _R	4:4:4 10bit
	2 048 x 1 080	28.1	25.0	74.3	—	3G-SDI Level-A	YP _B P _R	4:4:4 12bit
	2 048 x 1 080	28.1	25.0	74.3	—	3G-SDI Level-B	YP _B P _R	4:4:4 12bit
	2 048 x 1 080	28.1	25.0	74.3	—	3G-SDI Level-A	RGB	4:4:4 10bit
	2 048 x 1 080	28.1	25.0	74.3	—	3G-SDI Level-B	RGB	4:4:4 10bit
	2 048 x 1 080	28.1	25.0	74.3	—	3G-SDI Level-A	RGB	4:4:4 12bit
	2 048 x 1 080	28.1	25.0	74.3	—	3G-SDI Level-B	RGB	4:4:4 12bit
2K/30p	2 048 x 1 080	33.8	30.0 ¹	74.3	—	3G-SDI Level-A	YP _B P _R	4:4:4 10bit
	2 048 x 1 080	33.8	30.0 ¹	74.3	—	3G-SDI Level-B	YP _B P _R	4:4:4 10bit
	2 048 x 1 080	33.8	30.0 ¹	74.3	—	3G-SDI Level-A	YP _B P _R	4:4:4 12bit
	2 048 x 1 080	33.8	30.0 ¹	74.3	—	3G-SDI Level-B	YP _B P _R	4:4:4 12bit
	2 048 x 1 080	33.8	30.0 ¹	74.3	—	3G-SDI Level-A	RGB	4:4:4 10bit
	2 048 x 1 080	33.8	30.0 ¹	74.3	—	3G-SDI Level-B	RGB	4:4:4 10bit
	2 048 x 1 080	33.8	30.0 ¹	74.3	—	3G-SDI Level-A	RGB	4:4:4 12bit
	2 048 x 1 080	33.8	30.0 ¹	74.3	—	3G-SDI Level-B	RGB	4:4:4 12bit
2K/48p	2 048 x 1 080	54.0	48.0 ¹	148.5	—	3G-SDI Level-A	YP _B P _R	4:2:2 10bit
	2 048 x 1 080	54.0	48.0 ¹	148.5	—	3G-SDI Level-B	YP _B P _R	4:2:2 10bit
2K/60p	2 048 x 1 080	67.5	60.0 ¹	148.5	—	3G-SDI Level-A	YP _B P _R	4:2:2 10bit
	2 048 x 1 080	67.5	60.0 ¹	148.5	—	3G-SDI Level-B	YP _B P _R	4:2:2 10bit
	2 048 x 1 080 ²	67.5	60.0 ¹	148.5	—	6G-SDI Type 1	YP _B P _R	4:4:4 10bit
	2 048 x 1 080 ²	67.5	60.0 ¹	148.5	—	6G-SDI Type 1	YP _B P _R	4:4:4 12bit
	2 048 x 1 080 ²	67.5	60.0 ¹	148.5	—	6G-SDI Type 1	RGB	4:4:4 10bit
	2 048 x 1 080 ²	67.5	60.0 ¹	148.5	—	6G-SDI Type 1	RGB	4:4:4 12bit

Chapter 7 Appendix — Technical information

Signal name (SIGNAL FORMAT)	Resolution (Dots)	Scanning freq.		Dot clock freq. (MHz)	4K division	Format	Color format	Sampling
		Horizontal (kHz)	Vertical (Hz)					
2K/50p	2 048 x 1 080	56.3	50.0	148.5	—	3G-SDI Level-A	YP _B P _R	4:2:2 10bit
	2 048 x 1 080	56.3	50.0	148.5	—	3G-SDI Level-B	YP _B P _R	4:2:2 10bit
	2 048 x 1 080 ²	56.3	50.0	148.5	—	6G-SDI Type 1	YP _B P _R	4:4:4 10bit
	2 048 x 1 080 ²	56.3	50.0	148.5	—	6G-SDI Type 1	YP _B P _R	4:4:4 12bit
	2 048 x 1 080 ²	56.3	50.0	148.5	—	6G-SDI Type 1	RGB	4:4:4 10bit
	2 048 x 1 080 ²	56.3	50.0	148.5	—	6G-SDI Type 1	RGB	4:4:4 12bit
3840 x 2160/24p	3 840 x 2 160 ²	54.0	24.0 ¹	297.0	SQ	6G-SDI Type 2	YP _B P _R	4:2:2 10bit
	3 840 x 2 160 ²	54.0	24.0 ¹	297.0	IL	6G-SDI Type 2	YP _B P _R	4:2:2 10bit
	3 840 x 2 160 ²	54.0	24.0 ¹	297.0	SQ	12G-SDI Type 1	YP _B P _R	4:2:2 12bit
	3 840 x 2 160 ²	54.0	24.0 ¹	297.0	IL	12G-SDI Type 1	YP _B P _R	4:2:2 12bit
	3 840 x 2 160 ²	54.0	24.0 ¹	297.0	SQ	12G-SDI Type 1	YP _B P _R	4:4:4 10bit
	3 840 x 2 160 ²	54.0	24.0 ¹	297.0	IL	12G-SDI Type 1	YP _B P _R	4:4:4 10bit
	3 840 x 2 160 ²	54.0	24.0 ¹	297.0	SQ	12G-SDI Type 1	YP _B P _R	4:4:4 12bit
	3 840 x 2 160 ²	54.0	24.0 ¹	297.0	IL	12G-SDI Type 1	YP _B P _R	4:4:4 12bit
	3 840 x 2 160 ²	54.0	24.0 ¹	297.0	SQ	12G-SDI Type 1	RGB	4:4:4 10bit
	3 840 x 2 160 ²	54.0	24.0 ¹	297.0	IL	12G-SDI Type 1	RGB	4:4:4 10bit
	3 840 x 2 160 ²	54.0	24.0 ¹	297.0	SQ	12G-SDI Type 1	RGB	4:4:4 12bit
	3 840 x 2 160 ²	54.0	24.0 ¹	297.0	IL	12G-SDI Type 1	RGB	4:4:4 12bit
3840 x 2160/25p	3 840 x 2 160 ²	56.3	25.0	297.0	SQ	6G-SDI Type 2	YP _B P _R	4:2:2 10bit
	3 840 x 2 160 ²	56.3	25.0	297.0	IL	6G-SDI Type 2	YP _B P _R	4:2:2 10bit
	3 840 x 2 160 ²	56.3	25.0	297.0	SQ	12G-SDI Type 1	YP _B P _R	4:2:2 12bit
	3 840 x 2 160 ²	56.3	25.0	297.0	IL	12G-SDI Type 1	YP _B P _R	4:2:2 12bit
	3 840 x 2 160 ²	56.3	25.0	297.0	SQ	12G-SDI Type 1	YP _B P _R	4:4:4 10bit
	3 840 x 2 160 ²	56.3	25.0	297.0	IL	12G-SDI Type 1	YP _B P _R	4:4:4 10bit
	3 840 x 2 160 ²	56.3	25.0	297.0	SQ	12G-SDI Type 1	YP _B P _R	4:4:4 12bit
	3 840 x 2 160 ²	56.3	25.0	297.0	IL	12G-SDI Type 1	YP _B P _R	4:4:4 12bit
	3 840 x 2 160 ²	56.3	25.0	297.0	SQ	12G-SDI Type 1	RGB	4:4:4 10bit
	3 840 x 2 160 ²	56.3	25.0	297.0	IL	12G-SDI Type 1	RGB	4:4:4 10bit
	3 840 x 2 160 ²	56.3	25.0	297.0	SQ	12G-SDI Type 1	RGB	4:4:4 12bit
	3 840 x 2 160 ²	56.3	25.0	297.0	IL	12G-SDI Type 1	RGB	4:4:4 12bit
3840 x 2160/30p	3 840 x 2 160 ²	67.5	30.0 ¹	297.0	SQ	6G-SDI Type 2	YP _B P _R	4:2:2 10bit
	3 840 x 2 160 ²	67.5	30.0 ¹	297.0	IL	6G-SDI Type 2	YP _B P _R	4:2:2 10bit
	3 840 x 2 160 ²	67.5	30.0 ¹	297.0	SQ	12G-SDI Type 1	YP _B P _R	4:2:2 12bit
	3 840 x 2 160 ²	67.5	30.0 ¹	297.0	IL	12G-SDI Type 1	YP _B P _R	4:2:2 12bit
	3 840 x 2 160 ²	67.5	30.0 ¹	297.0	SQ	12G-SDI Type 1	YP _B P _R	4:4:4 10bit
	3 840 x 2 160 ²	67.5	30.0 ¹	297.0	IL	12G-SDI Type 1	YP _B P _R	4:4:4 10bit
	3 840 x 2 160 ²	67.5	30.0 ¹	297.0	SQ	12G-SDI Type 1	YP _B P _R	4:4:4 12bit
	3 840 x 2 160 ²	67.5	30.0 ¹	297.0	IL	12G-SDI Type 1	YP _B P _R	4:4:4 12bit
	3 840 x 2 160 ²	67.5	30.0 ¹	297.0	SQ	12G-SDI Type 1	RGB	4:4:4 10bit
	3 840 x 2 160 ²	67.5	30.0 ¹	297.0	IL	12G-SDI Type 1	RGB	4:4:4 10bit
	3 840 x 2 160 ²	67.5	30.0 ¹	297.0	SQ	12G-SDI Type 1	RGB	4:4:4 12bit
	3 840 x 2 160 ²	67.5	30.0 ¹	297.0	IL	12G-SDI Type 1	RGB	4:4:4 12bit
3840 x 2160/60p	3 840 x 2 160 ²	135.0	60.0 ¹	594.0	SQ	12G-SDI Type 1	YP _B P _R	4:2:2 10bit
	3 840 x 2 160 ²	135.0	60.0 ¹	594.0	IL	12G-SDI Type 1	YP _B P _R	4:2:2 10bit
3840 x 2160/50p	3 840 x 2 160 ²	112.5	50.0	594.0	SQ	12G-SDI Type 1	YP _B P _R	4:2:2 10bit
	3 840 x 2 160 ²	112.5	50.0	594.0	IL	12G-SDI Type 1	YP _B P _R	4:2:2 10bit

Chapter 7 Appendix — Technical information

Signal name (SIGNAL FORMAT)	Resolution (Dots)	Scanning freq.		Dot clock freq. (MHz)	4K division	Format	Color format	Sampling
		Horizontal (kHz)	Vertical (Hz)					
4096 x 2160/24p	4 096 x 2 160 ^{*2}	54.0	24.0 ^{*1}	297.0	SQ	6G-SDI Type 2	YP _B P _R	4:2:2 10bit
	4 096 x 2 160 ^{*2}	54.0	24.0 ^{*1}	297.0	IL	6G-SDI Type 2	YP _B P _R	4:2:2 10bit
	4 096 x 2 160 ^{*2}	54.0	24.0 ^{*1}	297.0	SQ	12G-SDI Type 1	YP _B P _R	4:2:2 12bit
	4 096 x 2 160 ^{*2}	54.0	24.0 ^{*1}	297.0	IL	12G-SDI Type 1	YP _B P _R	4:2:2 12bit
	4 096 x 2 160 ^{*2}	54.0	24.0 ^{*1}	297.0	SQ	12G-SDI Type 1	YP _B P _R	4:4:4 10bit
	4 096 x 2 160 ^{*2}	54.0	24.0 ^{*1}	297.0	IL	12G-SDI Type 1	YP _B P _R	4:4:4 10bit
	4 096 x 2 160 ^{*2}	54.0	24.0 ^{*1}	297.0	SQ	12G-SDI Type 1	YP _B P _R	4:4:4 12bit
	4 096 x 2 160 ^{*2}	54.0	24.0 ^{*1}	297.0	IL	12G-SDI Type 1	YP _B P _R	4:4:4 12bit
	4 096 x 2 160 ^{*2}	54.0	24.0 ^{*1}	297.0	SQ	12G-SDI Type 1	RGB	4:4:4 10bit
	4 096 x 2 160 ^{*2}	54.0	24.0 ^{*1}	297.0	IL	12G-SDI Type 1	RGB	4:4:4 10bit
	4 096 x 2 160 ^{*2}	54.0	24.0 ^{*1}	297.0	SQ	12G-SDI Type 1	RGB	4:4:4 12bit
	4 096 x 2 160 ^{*2}	54.0	24.0 ^{*1}	297.0	IL	12G-SDI Type 1	RGB	4:4:4 12bit
4096 x 2160/25p	4 096 x 2 160 ^{*2}	56.3	25.0	297.0	SQ	6G-SDI Type 2	YP _B P _R	4:2:2 10bit
	4 096 x 2 160 ^{*2}	56.3	25.0	297.0	IL	6G-SDI Type 2	YP _B P _R	4:2:2 10bit
	4 096 x 2 160 ^{*2}	56.3	25.0	297.0	SQ	12G-SDI Type 1	YP _B P _R	4:2:2 12bit
	4 096 x 2 160 ^{*2}	56.3	25.0	297.0	IL	12G-SDI Type 1	YP _B P _R	4:2:2 12bit
	4 096 x 2 160 ^{*2}	56.3	25.0	297.0	SQ	12G-SDI Type 1	YP _B P _R	4:4:4 10bit
	4 096 x 2 160 ^{*2}	56.3	25.0	297.0	IL	12G-SDI Type 1	YP _B P _R	4:4:4 10bit
	4 096 x 2 160 ^{*2}	56.3	25.0	297.0	SQ	12G-SDI Type 1	YP _B P _R	4:4:4 12bit
	4 096 x 2 160 ^{*2}	56.3	25.0	297.0	IL	12G-SDI Type 1	YP _B P _R	4:4:4 12bit
	4 096 x 2 160 ^{*2}	56.3	25.0	297.0	SQ	12G-SDI Type 1	RGB	4:4:4 10bit
	4 096 x 2 160 ^{*2}	56.3	25.0	297.0	IL	12G-SDI Type 1	RGB	4:4:4 10bit
	4 096 x 2 160 ^{*2}	56.3	25.0	297.0	SQ	12G-SDI Type 1	RGB	4:4:4 12bit
	4 096 x 2 160 ^{*2}	56.3	25.0	297.0	IL	12G-SDI Type 1	RGB	4:4:4 12bit
4096 x 2160/30p	4 096 x 2 160 ^{*2}	67.5	30.0 ^{*1}	297.0	SQ	6G-SDI Type 2	YP _B P _R	4:2:2 10bit
	4 096 x 2 160 ^{*2}	67.5	30.0 ^{*1}	297.0	IL	6G-SDI Type 2	YP _B P _R	4:2:2 10bit
	4 096 x 2 160 ^{*2}	67.5	30.0 ^{*1}	297.0	SQ	12G-SDI Type 1	YP _B P _R	4:2:2 12bit
	4 096 x 2 160 ^{*2}	67.5	30.0 ^{*1}	297.0	IL	12G-SDI Type 1	YP _B P _R	4:2:2 12bit
	4 096 x 2 160 ^{*2}	67.5	30.0 ^{*1}	297.0	SQ	12G-SDI Type 1	YP _B P _R	4:4:4 10bit
	4 096 x 2 160 ^{*2}	67.5	30.0 ^{*1}	297.0	IL	12G-SDI Type 1	YP _B P _R	4:4:4 10bit
	4 096 x 2 160 ^{*2}	67.5	30.0 ^{*1}	297.0	SQ	12G-SDI Type 1	YP _B P _R	4:4:4 12bit
	4 096 x 2 160 ^{*2}	67.5	30.0 ^{*1}	297.0	IL	12G-SDI Type 1	YP _B P _R	4:4:4 12bit
	4 096 x 2 160 ^{*2}	67.5	30.0 ^{*1}	297.0	SQ	12G-SDI Type 1	RGB	4:4:4 10bit
	4 096 x 2 160 ^{*2}	67.5	30.0 ^{*1}	297.0	IL	12G-SDI Type 1	RGB	4:4:4 10bit
	4 096 x 2 160 ^{*2}	67.5	30.0 ^{*1}	297.0	SQ	12G-SDI Type 1	RGB	4:4:4 12bit
	4 096 x 2 160 ^{*2}	67.5	30.0 ^{*1}	297.0	IL	12G-SDI Type 1	RGB	4:4:4 12bit
4096 x 2160/60p	4 096 x 2 160 ^{*2}	135.0	60.0 ^{*1}	594.0	SQ	12G-SDI Type 1	YP _B P _R	4:2:2 10bit
	4 096 x 2 160 ^{*2}	135.0	60.0 ^{*1}	594.0	IL	12G-SDI Type 1	YP _B P _R	4:2:2 10bit
4096 x 2160/50p	4 096 x 2 160 ^{*2}	112.5	50.0	594.0	SQ	12G-SDI Type 1	YP _B P _R	4:2:2 10bit
	4 096 x 2 160 ^{*2}	112.5	50.0	594.0	IL	12G-SDI Type 1	YP _B P _R	4:2:2 10bit

*1 The signal with 1/1.001x vertical scanning frequency is also supported.

*2 Only the <SDI 1 IN> terminal and the <SDI 3 IN> terminal of the Interface Board for 12G-SDI (Model No.: ET-MDN12G10) are supported.

List of dual link SDI compatible signals

The following table specifies the dual link SDI signals that the projector can project.

- The content of the 4K division column is as follows.
 - SQ: Square (transmission format of Square Division)
 - IL: Interleave (transmission format of 2-Sample Interleave Division)

Signal name (SIGNAL FORMAT)	Resolution (Dots)	Scanning freq.		Dot clock freq. (MHz)	4K division	Format	Color format	Sampling
		Horizontal (kHz)	Vertical (Hz)					
1080/60p	1 920 x 1 080	67.5	60.0*1	148.5	—	HD-SDI	YP _B P _R	4:2:2 10bit
	1 920 x 1 080	67.5	60.0*1	148.5	—	3G-SDI Level-A	YP _B P _R	4:4:4 10bit
	1 920 x 1 080	67.5	60.0*1	148.5	—	3G-SDI Level-B	YP _B P _R	4:4:4 10bit
	1 920 x 1 080	67.5	60.0*1	148.5	—	3G-SDI Level-A	YP _B P _R	4:4:4 12bit
	1 920 x 1 080	67.5	60.0*1	148.5	—	3G-SDI Level-B	YP _B P _R	4:4:4 12bit
	1 920 x 1 080	67.5	60.0*1	148.5	—	3G-SDI Level-A	RGB	4:4:4 10bit
	1 920 x 1 080	67.5	60.0*1	148.5	—	3G-SDI Level-B	RGB	4:4:4 10bit
	1 920 x 1 080	67.5	60.0*1	148.5	—	3G-SDI Level-A	RGB	4:4:4 12bit
	1 920 x 1 080	67.5	60.0*1	148.5	—	3G-SDI Level-B	RGB	4:4:4 12bit
1080/50p	1 920 x 1 080	56.3	50.0	148.5	—	HD-SDI	YP _B P _R	4:2:2 10bit
	1 920 x 1 080	56.3	50.0	148.5	—	3G-SDI Level-A	YP _B P _R	4:4:4 10bit
	1 920 x 1 080	56.3	50.0	148.5	—	3G-SDI Level-B	YP _B P _R	4:4:4 10bit
	1 920 x 1 080	56.3	50.0	148.5	—	3G-SDI Level-A	YP _B P _R	4:4:4 12bit
	1 920 x 1 080	56.3	50.0	148.5	—	3G-SDI Level-B	YP _B P _R	4:4:4 12bit
	1 920 x 1 080	56.3	50.0	148.5	—	3G-SDI Level-A	RGB	4:4:4 10bit
	1 920 x 1 080	56.3	50.0	148.5	—	3G-SDI Level-B	RGB	4:4:4 10bit
	1 920 x 1 080	56.3	50.0	148.5	—	3G-SDI Level-A	RGB	4:4:4 12bit
	1 920 x 1 080	56.3	50.0	148.5	—	3G-SDI Level-B	RGB	4:4:4 12bit
2K/48p	2 048 x 1 080	54.0	48.0*1	148.5	—	3G-SDI Level-A	YP _B P _R	4:4:4 10bit
	2 048 x 1 080	54.0	48.0*1	148.5	—	3G-SDI Level-B	YP _B P _R	4:4:4 10bit
	2 048 x 1 080	54.0	48.0*1	148.5	—	3G-SDI Level-A	YP _B P _R	4:4:4 12bit
	2 048 x 1 080	54.0	48.0*1	148.5	—	3G-SDI Level-B	YP _B P _R	4:4:4 12bit
	2 048 x 1 080	54.0	48.0*1	148.5	—	3G-SDI Level-A	RGB	4:4:4 10bit
	2 048 x 1 080	54.0	48.0*1	148.5	—	3G-SDI Level-B	RGB	4:4:4 10bit
	2 048 x 1 080	54.0	48.0*1	148.5	—	3G-SDI Level-A	RGB	4:4:4 12bit
	2 048 x 1 080	54.0	48.0*1	148.5	—	3G-SDI Level-B	RGB	4:4:4 12bit
2K/50p	2 048 x 1 080	56.3	50.0	148.5	—	3G-SDI Level-A	YP _B P _R	4:4:4 10bit
	2 048 x 1 080	56.3	50.0	148.5	—	3G-SDI Level-B	YP _B P _R	4:4:4 10bit
	2 048 x 1 080	56.3	50.0	148.5	—	3G-SDI Level-A	YP _B P _R	4:4:4 12bit
	2 048 x 1 080	56.3	50.0	148.5	—	3G-SDI Level-B	YP _B P _R	4:4:4 12bit
	2 048 x 1 080	56.3	50.0	148.5	—	3G-SDI Level-A	RGB	4:4:4 10bit
	2 048 x 1 080	56.3	50.0	148.5	—	3G-SDI Level-B	RGB	4:4:4 10bit
	2 048 x 1 080	56.3	50.0	148.5	—	3G-SDI Level-A	RGB	4:4:4 12bit
	2 048 x 1 080	56.3	50.0	148.5	—	3G-SDI Level-B	RGB	4:4:4 12bit
2K/60p	2 048 x 1 080	67.5	60.0*1	148.5	—	3G-SDI Level-A	YP _B P _R	4:4:4 10bit
	2 048 x 1 080	67.5	60.0*1	148.5	—	3G-SDI Level-B	YP _B P _R	4:4:4 10bit
	2 048 x 1 080	67.5	60.0*1	148.5	—	3G-SDI Level-A	YP _B P _R	4:4:4 12bit
	2 048 x 1 080	67.5	60.0*1	148.5	—	3G-SDI Level-B	YP _B P _R	4:4:4 12bit
	2 048 x 1 080	67.5	60.0*1	148.5	—	3G-SDI Level-A	RGB	4:4:4 10bit
	2 048 x 1 080	67.5	60.0*1	148.5	—	3G-SDI Level-B	RGB	4:4:4 10bit
	2 048 x 1 080	67.5	60.0*1	148.5	—	3G-SDI Level-A	RGB	4:4:4 12bit
	2 048 x 1 080	67.5	60.0*1	148.5	—	3G-SDI Level-B	RGB	4:4:4 12bit

Chapter 7 Appendix — Technical information

Signal name (SIGNAL FORMAT)	Resolution (Dots)	Scanning freq.		Dot clock freq. (MHz)	4K division	Format	Color format	Sampling
		Horizontal (kHz)	Vertical (Hz)					
3840 x 2160/24p	3 840 x 2 160	54.0	24.0*1	297.0	SQ	3G-SDI Level-B Dual Stream	YP _B P _R	4:2:2 10bit
	3 840 x 2 160	54.0	24.0*1	297.0	IL	3G-SDI Level-B Dual Stream	YP _B P _R	4:2:2 10bit
	3 840 x 2 160 ²	54.0	24.0*1	297.0	SQ	6G-SDI Type 1	YP _B P _R	4:2:2 12bit
	3 840 x 2 160 ²	54.0	24.0*1	297.0	IL	6G-SDI Type 1	YP _B P _R	4:2:2 12bit
	3 840 x 2 160 ²	54.0	24.0*1	297.0	SQ	6G-SDI Type 1	YP _B P _R	4:4:4 10bit
	3 840 x 2 160 ²	54.0	24.0*1	297.0	IL	6G-SDI Type 1	YP _B P _R	4:4:4 10bit
	3 840 x 2 160 ²	54.0	24.0*1	297.0	SQ	6G-SDI Type 1	YP _B P _R	4:4:4 12bit
	3 840 x 2 160 ²	54.0	24.0*1	297.0	IL	6G-SDI Type 1	YP _B P _R	4:4:4 12bit
	3 840 x 2 160 ²	54.0	24.0*1	297.0	SQ	6G-SDI Type 1	RGB	4:4:4 10bit
	3 840 x 2 160 ²	54.0	24.0*1	297.0	IL	6G-SDI Type 1	RGB	4:4:4 10bit
	3 840 x 2 160 ²	54.0	24.0*1	297.0	SQ	6G-SDI Type 1	RGB	4:4:4 12bit
3 840 x 2 160 ²	54.0	24.0*1	297.0	IL	6G-SDI Type 1	RGB	4:4:4 12bit	
3840 x 2160/25p	3 840 x 2 160	56.3	25.0	297.0	SQ	3G-SDI Level-B Dual Stream	YP _B P _R	4:2:2 10bit
	3 840 x 2 160	56.3	25.0	297.0	IL	3G-SDI Level-B Dual Stream	YP _B P _R	4:2:2 10bit
	3 840 x 2 160 ²	56.3	25.0	297.0	SQ	6G-SDI Type 1	YP _B P _R	4:2:2 12bit
	3 840 x 2 160 ²	56.3	25.0	297.0	IL	6G-SDI Type 1	YP _B P _R	4:2:2 12bit
	3 840 x 2 160 ²	56.3	25.0	297.0	SQ	6G-SDI Type 1	YP _B P _R	4:4:4 10bit
	3 840 x 2 160 ²	56.3	25.0	297.0	IL	6G-SDI Type 1	YP _B P _R	4:4:4 10bit
	3 840 x 2 160 ²	56.3	25.0	297.0	SQ	6G-SDI Type 1	YP _B P _R	4:4:4 12bit
	3 840 x 2 160 ²	56.3	25.0	297.0	IL	6G-SDI Type 1	YP _B P _R	4:4:4 12bit
	3 840 x 2 160 ²	56.3	25.0	297.0	SQ	6G-SDI Type 1	RGB	4:4:4 10bit
	3 840 x 2 160 ²	56.3	25.0	297.0	IL	6G-SDI Type 1	RGB	4:4:4 10bit
	3 840 x 2 160 ²	56.3	25.0	297.0	SQ	6G-SDI Type 1	RGB	4:4:4 12bit
3 840 x 2 160 ²	56.3	25.0	297.0	IL	6G-SDI Type 1	RGB	4:4:4 12bit	
3840 x 2160/30p	3 840 x 2 160	56.3	30.0*1	297.0	SQ	3G-SDI Level-B Dual Stream	YP _B P _R	4:2:2 10bit
	3 840 x 2 160	56.3	30.0*1	297.0	IL	3G-SDI Level-B Dual Stream	YP _B P _R	4:2:2 10bit
	3 840 x 2 160 ²	56.3	30.0*1	297.0	SQ	6G-SDI Type 1	YP _B P _R	4:2:2 12bit
	3 840 x 2 160 ²	56.3	30.0*1	297.0	IL	6G-SDI Type 1	YP _B P _R	4:2:2 12bit
	3 840 x 2 160 ²	56.3	30.0*1	297.0	SQ	6G-SDI Type 1	YP _B P _R	4:4:4 10bit
	3 840 x 2 160 ²	56.3	30.0*1	297.0	IL	6G-SDI Type 1	YP _B P _R	4:4:4 10bit
	3 840 x 2 160 ²	56.3	30.0*1	297.0	SQ	6G-SDI Type 1	YP _B P _R	4:4:4 12bit
	3 840 x 2 160 ²	56.3	30.0*1	297.0	IL	6G-SDI Type 1	YP _B P _R	4:4:4 12bit
	3 840 x 2 160 ²	56.3	30.0*1	297.0	SQ	6G-SDI Type 1	RGB	4:4:4 10bit
	3 840 x 2 160 ²	56.3	30.0*1	297.0	IL	6G-SDI Type 1	RGB	4:4:4 10bit
	3 840 x 2 160 ²	56.3	30.0*1	297.0	SQ	6G-SDI Type 1	RGB	4:4:4 12bit
3 840 x 2 160 ²	56.3	30.0*1	297.0	IL	6G-SDI Type 1	RGB	4:4:4 12bit	
3840 x 2160/60p	3 840 x 2 160 ²	135.0	60.0*1	594.0	SQ	6G-SDI Type 1	YP _B P _R	4:2:2 10bit
	3 840 x 2 160 ²	135.0	60.0*1	594.0	IL	6G-SDI Type 1	YP _B P _R	4:2:2 10bit
3840 x 2160/50p	3 840 x 2 160 ²	112.5	50.0	594.0	SQ	6G-SDI Type 1	YP _B P _R	4:2:2 10bit
	3 840 x 2 160 ²	112.5	50.0	594.0	IL	6G-SDI Type 1	YP _B P _R	4:2:2 10bit

Chapter 7 Appendix — Technical information

Signal name (SIGNAL FORMAT)	Resolution (Dots)	Scanning freq.		Dot clock freq. (MHz)	4K division	Format	Color format	Sampling
		Horizontal (kHz)	Vertical (Hz)					
4096 x 2160/24p	4 096 x 2 160	54.0	24.0*1	297.0	SQ	3G-SDI Level-B Dual Stream	YP _B P _R	4:2:2 10bit
	4 096 x 2 160	54.0	24.0*1	297.0	IL	3G-SDI Level-B Dual Stream	YP _B P _R	4:2:2 10bit
	4 096 x 2 160 ²	54.0	24.0*1	297.0	SQ	6G-SDI Type 1	YP _B P _R	4:2:2 12bit
	4 096 x 2 160 ²	54.0	24.0*1	297.0	IL	6G-SDI Type 1	YP _B P _R	4:2:2 12bit
	4 096 x 2 160 ²	54.0	24.0*1	297.0	SQ	6G-SDI Type 1	YP _B P _R	4:4:4 10bit
	4 096 x 2 160 ²	54.0	24.0*1	297.0	IL	6G-SDI Type 1	YP _B P _R	4:4:4 10bit
	4 096 x 2 160 ²	54.0	24.0*1	297.0	SQ	6G-SDI Type 1	YP _B P _R	4:4:4 12bit
	4 096 x 2 160 ²	54.0	24.0*1	297.0	IL	6G-SDI Type 1	YP _B P _R	4:4:4 12bit
	4 096 x 2 160 ²	54.0	24.0*1	297.0	SQ	6G-SDI Type 1	RGB	4:4:4 10bit
	4 096 x 2 160 ²	54.0	24.0*1	297.0	IL	6G-SDI Type 1	RGB	4:4:4 10bit
	4 096 x 2 160 ²	54.0	24.0*1	297.0	SQ	6G-SDI Type 1	RGB	4:4:4 12bit
	4 096 x 2 160 ²	54.0	24.0*1	297.0	IL	6G-SDI Type 1	RGB	4:4:4 12bit
4096 x 2160/25p	4 096 x 2 160	56.3	25.0	297.0	SQ	3G-SDI Level-B Dual Stream	YP _B P _R	4:2:2 10bit
	4 096 x 2 160	56.3	25.0	297.0	IL	3G-SDI Level-B Dual Stream	YP _B P _R	4:2:2 10bit
	4 096 x 2 160 ²	56.3	25.0	297.0	SQ	6G-SDI Type 1	YP _B P _R	4:2:2 12bit
	4 096 x 2 160 ²	56.3	25.0	297.0	IL	6G-SDI Type 1	YP _B P _R	4:2:2 12bit
	4 096 x 2 160 ²	56.3	25.0	297.0	SQ	6G-SDI Type 1	YP _B P _R	4:4:4 10bit
	4 096 x 2 160 ²	56.3	25.0	297.0	IL	6G-SDI Type 1	YP _B P _R	4:4:4 10bit
	4 096 x 2 160 ²	56.3	25.0	297.0	SQ	6G-SDI Type 1	YP _B P _R	4:4:4 12bit
	4 096 x 2 160 ²	56.3	25.0	297.0	IL	6G-SDI Type 1	YP _B P _R	4:4:4 12bit
	4 096 x 2 160 ²	56.3	25.0	297.0	SQ	6G-SDI Type 1	RGB	4:4:4 10bit
	4 096 x 2 160 ²	56.3	25.0	297.0	IL	6G-SDI Type 1	RGB	4:4:4 10bit
	4 096 x 2 160 ²	56.3	25.0	297.0	SQ	6G-SDI Type 1	RGB	4:4:4 12bit
	4 096 x 2 160 ²	56.3	25.0	297.0	IL	6G-SDI Type 1	RGB	4:4:4 12bit
4096 x 2160/30p	4 096 x 2 160	67.5	30.0*1	297.0	SQ	3G-SDI Level-B Dual Stream	YP _B P _R	4:2:2 10bit
	4 096 x 2 160	67.5	30.0*1	297.0	IL	3G-SDI Level-B Dual Stream	YP _B P _R	4:2:2 10bit
	4 096 x 2 160 ²	67.5	30.0*1	297.0	SQ	6G-SDI Type 1	YP _B P _R	4:2:2 12bit
	4 096 x 2 160 ²	67.5	30.0*1	297.0	IL	6G-SDI Type 1	YP _B P _R	4:2:2 12bit
	4 096 x 2 160 ²	67.5	30.0*1	297.0	SQ	6G-SDI Type 1	YP _B P _R	4:4:4 10bit
	4 096 x 2 160 ²	67.5	30.0*1	297.0	IL	6G-SDI Type 1	YP _B P _R	4:4:4 10bit
	4 096 x 2 160 ²	67.5	30.0*1	297.0	SQ	6G-SDI Type 1	YP _B P _R	4:4:4 12bit
	4 096 x 2 160 ²	67.5	30.0*1	297.0	IL	6G-SDI Type 1	YP _B P _R	4:4:4 12bit
	4 096 x 2 160 ²	67.5	30.0*1	297.0	SQ	6G-SDI Type 1	RGB	4:4:4 10bit
	4 096 x 2 160 ²	67.5	30.0*1	297.0	IL	6G-SDI Type 1	RGB	4:4:4 10bit
	4 096 x 2 160 ²	67.5	30.0*1	297.0	SQ	6G-SDI Type 1	RGB	4:4:4 12bit
	4 096 x 2 160 ²	67.5	30.0*1	297.0	IL	6G-SDI Type 1	RGB	4:4:4 12bit
4096 x 2160/60p	4 096 x 2 160 ²	135.0	60.0*1	594.0	SQ	6G-SDI Type 1	YP _B P _R	4:2:2 10bit
	4 096 x 2 160 ²	135.0	60.0*1	594.0	IL	6G-SDI Type 1	YP _B P _R	4:2:2 10bit
4096 x 2160/50p	4 096 x 2 160 ²	112.5	50.0	594.0	SQ	6G-SDI Type 1	YP _B P _R	4:2:2 10bit
	4 096 x 2 160 ²	112.5	50.0	594.0	IL	6G-SDI Type 1	YP _B P _R	4:2:2 10bit

*1 The signal with 1/1.001x vertical scanning frequency is also supported.

*2 Only the combination of the <SDI 1 IN> terminal and the <SDI 3 IN> terminal of the Interface Board for 12G-SDI (Model No.: ET-MDN12G10) is supported.

List of quad link SDI compatible signals

The following table specifies the quad link SDI signals that the projector can project.

- The content of the 4K division column is as follows.
 - SQ: Square (transmission format of Square Division)
 - IL: Interleave (transmission format of 2-Sample Interleave Division)

Signal name (SIGNAL FORMAT)	Resolution (Dots)	Scanning freq.		Dot clock freq. (MHz)	4K division	Format	Color format	Sampling
		Horizontal (kHz)	Vertical (Hz)					
3840 x 2160/24p	3 840 x 2 160	54.0	24.0*1	297.0	SQ	HD-SDI	YP _B P _R	4:2:2 10bit
	3 840 x 2 160	54.0	24.0*1	297.0	SQ	3G-SDI Level-A	YP _B P _R	4:2:2 12bit
	3 840 x 2 160	54.0	24.0*1	297.0	IL	3G-SDI Level-A	YP _B P _R	4:2:2 12bit
	3 840 x 2 160	54.0	24.0*1	297.0	SQ	3G-SDI Level-B	YP _B P _R	4:2:2 12bit
	3 840 x 2 160	54.0	24.0*1	297.0	IL	3G-SDI Level-B	YP _B P _R	4:2:2 12bit
	3 840 x 2 160	54.0	24.0*1	297.0	SQ	3G-SDI Level-A	YP _B P _R	4:4:4 10bit
	3 840 x 2 160	54.0	24.0*1	297.0	IL	3G-SDI Level-A	YP _B P _R	4:4:4 10bit
	3 840 x 2 160	54.0	24.0*1	297.0	SQ	3G-SDI Level-B	YP _B P _R	4:4:4 10bit
	3 840 x 2 160	54.0	24.0*1	297.0	IL	3G-SDI Level-B	YP _B P _R	4:4:4 10bit
	3 840 x 2 160	54.0	24.0*1	297.0	SQ	3G-SDI Level-A	YP _B P _R	4:4:4 12bit
	3 840 x 2 160	54.0	24.0*1	297.0	IL	3G-SDI Level-A	YP _B P _R	4:4:4 12bit
	3 840 x 2 160	54.0	24.0*1	297.0	SQ	3G-SDI Level-B	YP _B P _R	4:4:4 12bit
	3 840 x 2 160	54.0	24.0*1	297.0	IL	3G-SDI Level-B	YP _B P _R	4:4:4 12bit
	3 840 x 2 160	54.0	24.0*1	297.0	SQ	3G-SDI Level-A	RGB	4:4:4 10bit
	3 840 x 2 160	54.0	24.0*1	297.0	IL	3G-SDI Level-A	RGB	4:4:4 10bit
	3 840 x 2 160	54.0	24.0*1	297.0	SQ	3G-SDI Level-B	RGB	4:4:4 10bit
	3 840 x 2 160	54.0	24.0*1	297.0	IL	3G-SDI Level-B	RGB	4:4:4 10bit
	3 840 x 2 160	54.0	24.0*1	297.0	SQ	3G-SDI Level-A	RGB	4:4:4 12bit
	3 840 x 2 160	54.0	24.0*1	297.0	IL	3G-SDI Level-A	RGB	4:4:4 12bit
	3840 x 2160/25p	3 840 x 2 160	56.3	25.0	297.0	SQ	HD-SDI	YP _B P _R
3 840 x 2 160		56.3	25.0	297.0	SQ	3G-SDI Level-A	YP _B P _R	4:2:2 12bit
3 840 x 2 160		56.3	25.0	297.0	IL	3G-SDI Level-A	YP _B P _R	4:2:2 12bit
3 840 x 2 160		56.3	25.0	297.0	SQ	3G-SDI Level-B	YP _B P _R	4:2:2 12bit
3 840 x 2 160		56.3	25.0	297.0	IL	3G-SDI Level-B	YP _B P _R	4:2:2 12bit
3 840 x 2 160		56.3	25.0	297.0	SQ	3G-SDI Level-A	YP _B P _R	4:4:4 10bit
3 840 x 2 160		56.3	25.0	297.0	IL	3G-SDI Level-A	YP _B P _R	4:4:4 10bit
3 840 x 2 160		56.3	25.0	297.0	SQ	3G-SDI Level-B	YP _B P _R	4:4:4 10bit
3 840 x 2 160		56.3	25.0	297.0	IL	3G-SDI Level-B	YP _B P _R	4:4:4 10bit
3 840 x 2 160		56.3	25.0	297.0	SQ	3G-SDI Level-A	YP _B P _R	4:4:4 12bit
3 840 x 2 160		56.3	25.0	297.0	IL	3G-SDI Level-A	YP _B P _R	4:4:4 12bit
3 840 x 2 160		56.3	25.0	297.0	SQ	3G-SDI Level-B	YP _B P _R	4:4:4 12bit
3 840 x 2 160		56.3	25.0	297.0	IL	3G-SDI Level-B	YP _B P _R	4:4:4 12bit
3 840 x 2 160		56.3	25.0	297.0	SQ	3G-SDI Level-A	RGB	4:4:4 10bit
3 840 x 2 160		56.3	25.0	297.0	IL	3G-SDI Level-A	RGB	4:4:4 10bit
3 840 x 2 160		56.3	25.0	297.0	SQ	3G-SDI Level-B	RGB	4:4:4 10bit
3 840 x 2 160		56.3	25.0	297.0	IL	3G-SDI Level-B	RGB	4:4:4 10bit
3 840 x 2 160		56.3	25.0	297.0	SQ	3G-SDI Level-A	RGB	4:4:4 12bit
3 840 x 2 160		56.3	25.0	297.0	IL	3G-SDI Level-A	RGB	4:4:4 12bit
3 840 x 2 160		56.3	25.0	297.0	SQ	3G-SDI Level-B	RGB	4:4:4 12bit
3 840 x 2 160	56.3	25.0	297.0	IL	3G-SDI Level-B	RGB	4:4:4 12bit	

Chapter 7 Appendix — Technical information

Signal name (SIGNAL FORMAT)	Resolution (Dots)	Scanning freq.		Dot clock freq. (MHz)	4K division	Format	Color format	Sampling
		Horizontal (kHz)	Vertical (Hz)					
3840 x 2160/30p	3 840 x 2 160	67.5	30.0*1	297.0	SQ	HD-SDI	YP _B P _R	4:2:2 10bit
	3 840 x 2 160	67.5	30.0*1	297.0	SQ	3G-SDI Level-A	YP _B P _R	4:2:2 12bit
	3 840 x 2 160	67.5	30.0*1	297.0	IL	3G-SDI Level-A	YP _B P _R	4:2:2 12bit
	3 840 x 2 160	67.5	30.0*1	297.0	SQ	3G-SDI Level-B	YP _B P _R	4:2:2 12bit
	3 840 x 2 160	67.5	30.0*1	297.0	IL	3G-SDI Level-B	YP _B P _R	4:2:2 12bit
	3 840 x 2 160	67.5	30.0*1	297.0	SQ	3G-SDI Level-A	YP _B P _R	4:4:4 10bit
	3 840 x 2 160	67.5	30.0*1	297.0	IL	3G-SDI Level-A	YP _B P _R	4:4:4 10bit
	3 840 x 2 160	67.5	30.0*1	297.0	SQ	3G-SDI Level-B	YP _B P _R	4:4:4 10bit
	3 840 x 2 160	67.5	30.0*1	297.0	IL	3G-SDI Level-B	YP _B P _R	4:4:4 10bit
	3 840 x 2 160	67.5	30.0*1	297.0	SQ	3G-SDI Level-A	YP _B P _R	4:4:4 12bit
	3 840 x 2 160	67.5	30.0*1	297.0	IL	3G-SDI Level-A	YP _B P _R	4:4:4 12bit
	3 840 x 2 160	67.5	30.0*1	297.0	SQ	3G-SDI Level-B	YP _B P _R	4:4:4 12bit
	3 840 x 2 160	67.5	30.0*1	297.0	IL	3G-SDI Level-B	YP _B P _R	4:4:4 12bit
	3 840 x 2 160	67.5	30.0*1	297.0	SQ	3G-SDI Level-A	RGB	4:4:4 10bit
	3 840 x 2 160	67.5	30.0*1	297.0	IL	3G-SDI Level-A	RGB	4:4:4 10bit
	3 840 x 2 160	67.5	30.0*1	297.0	SQ	3G-SDI Level-B	RGB	4:4:4 10bit
	3 840 x 2 160	67.5	30.0*1	297.0	IL	3G-SDI Level-B	RGB	4:4:4 10bit
	3 840 x 2 160	67.5	30.0*1	297.0	SQ	3G-SDI Level-A	RGB	4:4:4 12bit
	3 840 x 2 160	67.5	30.0*1	297.0	IL	3G-SDI Level-A	RGB	4:4:4 12bit
	3840 x 2160/60p	3 840 x 2 160	135.0	60.0*1	594.0	SQ	3G-SDI Level-A	YP _B P _R
3 840 x 2 160		135.0	60.0*1	594.0	IL	3G-SDI Level-A	YP _B P _R	4:2:2 10bit
3 840 x 2 160		135.0	60.0*1	594.0	SQ	3G-SDI Level-B	YP _B P _R	4:2:2 10bit
3 840 x 2 160		135.0	60.0*1	594.0	IL	3G-SDI Level-B	YP _B P _R	4:2:2 10bit
3840 x 2160/50p	3 840 x 2 160	112.5	50.0	594.0	SQ	3G-SDI Level-A	YP _B P _R	4:2:2 10bit
	3 840 x 2 160	112.5	50.0	594.0	IL	3G-SDI Level-A	YP _B P _R	4:2:2 10bit
	3 840 x 2 160	112.5	50.0	594.0	SQ	3G-SDI Level-B	YP _B P _R	4:2:2 10bit
	3 840 x 2 160	112.5	50.0	594.0	IL	3G-SDI Level-B	YP _B P _R	4:2:2 10bit
4096 x 2160/24p	4 096 x 2 160	54.0	24.0*1	297.0	SQ	HD-SDI	YP _B P _R	4:2:2 10bit
	4 096 x 2 160	54.0	24.0*1	297.0	SQ	3G-SDI Level-A	YP _B P _R	4:2:2 12bit
	4 096 x 2 160	54.0	24.0*1	297.0	IL	3G-SDI Level-A	YP _B P _R	4:2:2 12bit
	4 096 x 2 160	54.0	24.0*1	297.0	SQ	3G-SDI Level-B	YP _B P _R	4:2:2 12bit
	4 096 x 2 160	54.0	24.0*1	297.0	IL	3G-SDI Level-B	YP _B P _R	4:2:2 12bit
	4 096 x 2 160	54.0	24.0*1	297.0	SQ	3G-SDI Level-A	YP _B P _R	4:4:4 10bit
	4 096 x 2 160	54.0	24.0*1	297.0	IL	3G-SDI Level-A	YP _B P _R	4:4:4 10bit
	4 096 x 2 160	54.0	24.0*1	297.0	SQ	3G-SDI Level-B	YP _B P _R	4:4:4 10bit
	4 096 x 2 160	54.0	24.0*1	297.0	IL	3G-SDI Level-B	YP _B P _R	4:4:4 10bit
	4 096 x 2 160	54.0	24.0*1	297.0	SQ	3G-SDI Level-A	YP _B P _R	4:4:4 12bit
	4 096 x 2 160	54.0	24.0*1	297.0	IL	3G-SDI Level-A	YP _B P _R	4:4:4 12bit
	4 096 x 2 160	54.0	24.0*1	297.0	SQ	3G-SDI Level-B	YP _B P _R	4:4:4 12bit
	4 096 x 2 160	54.0	24.0*1	297.0	IL	3G-SDI Level-B	YP _B P _R	4:4:4 12bit
	4 096 x 2 160	54.0	24.0*1	297.0	SQ	3G-SDI Level-A	RGB	4:4:4 10bit
	4 096 x 2 160	54.0	24.0*1	297.0	IL	3G-SDI Level-A	RGB	4:4:4 10bit
	4 096 x 2 160	54.0	24.0*1	297.0	SQ	3G-SDI Level-B	RGB	4:4:4 10bit
	4 096 x 2 160	54.0	24.0*1	297.0	IL	3G-SDI Level-B	RGB	4:4:4 10bit
	4 096 x 2 160	54.0	24.0*1	297.0	SQ	3G-SDI Level-A	RGB	4:4:4 12bit
	4 096 x 2 160	54.0	24.0*1	297.0	IL	3G-SDI Level-A	RGB	4:4:4 12bit
	4 096 x 2 160	54.0	24.0*1	297.0	SQ	3G-SDI Level-B	RGB	4:4:4 12bit
4 096 x 2 160	54.0	24.0*1	297.0	IL	3G-SDI Level-B	RGB	4:4:4 12bit	

Chapter 7 Appendix — Technical information

Signal name (SIGNAL FORMAT)	Resolution (Dots)	Scanning freq.		Dot clock freq. (MHz)	4K division	Format	Color format	Sampling
		Horizontal (kHz)	Vertical (Hz)					
4096 x 2160/25p	4 096 x 2 160	56.3	25.0	297.0	SQ	HD-SDI	YP _B P _R	4:2:2 10bit
	4 096 x 2 160	56.3	25.0	297.0	SQ	3G-SDI Level-A	YP _B P _R	4:2:2 12bit
	4 096 x 2 160	56.3	25.0	297.0	IL	3G-SDI Level-A	YP _B P _R	4:2:2 12bit
	4 096 x 2 160	56.3	25.0	297.0	SQ	3G-SDI Level-B	YP _B P _R	4:2:2 12bit
	4 096 x 2 160	56.3	25.0	297.0	IL	3G-SDI Level-B	YP _B P _R	4:2:2 12bit
	4 096 x 2 160	56.3	25.0	297.0	SQ	3G-SDI Level-A	YP _B P _R	4:4:4 10bit
	4 096 x 2 160	56.3	25.0	297.0	IL	3G-SDI Level-A	YP _B P _R	4:4:4 10bit
	4 096 x 2 160	56.3	25.0	297.0	SQ	3G-SDI Level-B	YP _B P _R	4:4:4 10bit
	4 096 x 2 160	56.3	25.0	297.0	IL	3G-SDI Level-B	YP _B P _R	4:4:4 10bit
	4 096 x 2 160	56.3	25.0	297.0	SQ	3G-SDI Level-A	YP _B P _R	4:4:4 12bit
	4 096 x 2 160	56.3	25.0	297.0	IL	3G-SDI Level-A	YP _B P _R	4:4:4 12bit
	4 096 x 2 160	56.3	25.0	297.0	SQ	3G-SDI Level-B	YP _B P _R	4:4:4 12bit
	4 096 x 2 160	56.3	25.0	297.0	IL	3G-SDI Level-B	YP _B P _R	4:4:4 12bit
	4 096 x 2 160	56.3	25.0	297.0	SQ	3G-SDI Level-A	RGB	4:4:4 10bit
	4 096 x 2 160	56.3	25.0	297.0	IL	3G-SDI Level-A	RGB	4:4:4 10bit
	4 096 x 2 160	56.3	25.0	297.0	SQ	3G-SDI Level-B	RGB	4:4:4 10bit
	4 096 x 2 160	56.3	25.0	297.0	IL	3G-SDI Level-B	RGB	4:4:4 10bit
	4 096 x 2 160	56.3	25.0	297.0	SQ	3G-SDI Level-A	RGB	4:4:4 12bit
	4 096 x 2 160	56.3	25.0	297.0	IL	3G-SDI Level-A	RGB	4:4:4 12bit
	4096 x 2160/30p	4 096 x 2 160	67.5	30.0*1	297.0	SQ	HD-SDI	YP _B P _R
4 096 x 2 160		67.5	30.0*1	297.0	SQ	3G-SDI Level-A	YP _B P _R	4:2:2 12bit
4 096 x 2 160		67.5	30.0*1	297.0	IL	3G-SDI Level-A	YP _B P _R	4:2:2 12bit
4 096 x 2 160		67.5	30.0*1	297.0	SQ	3G-SDI Level-B	YP _B P _R	4:2:2 12bit
4 096 x 2 160		67.5	30.0*1	297.0	IL	3G-SDI Level-B	YP _B P _R	4:2:2 12bit
4 096 x 2 160		67.5	30.0*1	297.0	SQ	3G-SDI Level-A	YP _B P _R	4:4:4 10bit
4 096 x 2 160		67.5	30.0*1	297.0	IL	3G-SDI Level-A	YP _B P _R	4:4:4 10bit
4 096 x 2 160		67.5	30.0*1	297.0	SQ	3G-SDI Level-B	YP _B P _R	4:4:4 10bit
4 096 x 2 160		67.5	30.0*1	297.0	IL	3G-SDI Level-B	YP _B P _R	4:4:4 10bit
4 096 x 2 160		67.5	30.0*1	297.0	SQ	3G-SDI Level-A	YP _B P _R	4:4:4 12bit
4 096 x 2 160		67.5	30.0*1	297.0	IL	3G-SDI Level-A	YP _B P _R	4:4:4 12bit
4 096 x 2 160		67.5	30.0*1	297.0	SQ	3G-SDI Level-B	YP _B P _R	4:4:4 12bit
4 096 x 2 160		67.5	30.0*1	297.0	IL	3G-SDI Level-B	YP _B P _R	4:4:4 12bit
4 096 x 2 160		67.5	30.0*1	297.0	SQ	3G-SDI Level-A	RGB	4:4:4 10bit
4 096 x 2 160		67.5	30.0*1	297.0	IL	3G-SDI Level-A	RGB	4:4:4 10bit
4 096 x 2 160		67.5	30.0*1	297.0	SQ	3G-SDI Level-B	RGB	4:4:4 10bit
4 096 x 2 160		67.5	30.0*1	297.0	IL	3G-SDI Level-B	RGB	4:4:4 10bit
4 096 x 2 160		67.5	30.0*1	297.0	SQ	3G-SDI Level-A	RGB	4:4:4 12bit
4 096 x 2 160		67.5	30.0*1	297.0	IL	3G-SDI Level-A	RGB	4:4:4 12bit
4096 x 2160/60p		4 096 x 2 160	135.0	60.0*1	594.0	SQ	3G-SDI Level-A	YP _B P _R
	4 096 x 2 160	135.0	60.0*1	594.0	IL	3G-SDI Level-A	YP _B P _R	4:2:2 10bit
	4 096 x 2 160	135.0	60.0*1	594.0	SQ	3G-SDI Level-B	YP _B P _R	4:2:2 10bit
	4 096 x 2 160	135.0	60.0*1	594.0	IL	3G-SDI Level-B	YP _B P _R	4:2:2 10bit
4096 x 2160/50p	4 096 x 2 160	112.5	50.0	594.0	SQ	3G-SDI Level-A	YP _B P _R	4:2:2 10bit
	4 096 x 2 160	112.5	50.0	594.0	IL	3G-SDI Level-A	YP _B P _R	4:2:2 10bit
	4 096 x 2 160	112.5	50.0	594.0	SQ	3G-SDI Level-B	YP _B P _R	4:2:2 10bit
	4 096 x 2 160	112.5	50.0	594.0	IL	3G-SDI Level-B	YP _B P _R	4:2:2 10bit

*1 The signal with 1/1.001x vertical scanning frequency is also supported.

List of simultaneous input compatible signals

The following table specifies the simultaneous input compatible video signals that the projector can project.

Signal name (SIGNAL FORMAT)	Resolution (Dots)	Scanning freq.		Dot clock freq. (MHz)	Simultaneous input compatible signal			
		Horizontal (kHz)	Vertical (Hz)		HDMI*1	DVI-D*2	DisplayPort*3	SDI
1080/60p	1 920 x 1 080	67.5	60.0	148.5	✓	✓	✓	✓
1080/50p	1 920 x 1 080	56.3	50.0	148.5	✓	✓	✓	✓
3840 x 2160/60	3 840 x 2 160	135.0	60.0	594.0	✓*4	—	✓	✓*5
3840 x 2160/50	3 840 x 2 160	112.5	50.0	594.0	✓*4	—	✓	✓*5
4096 x 2160/60	4 096 x 2 160	135.0	60.0	594.0	✓*4	—	✓	✓*5
4096 x 2160/50	4 096 x 2 160	112.5	50.0	594.0	✓*4	—	✓	✓*5

*1 This is supported when the optional Interface Board for HDMI 2 input (Model No.: ET-MDNHM10) is installed in both of the slots.

*2 This is supported when the optional Interface Board for DVI-D 2 input (Model No.: ET-MDNDV10) is installed in both of the slots.

*3 This is supported when the optional Interface Board for DisplayPort 2 input (Model No.: ET-MDNDP10) is installed in both of the slots.

*4 When performing the simultaneous input of the 4K image (resolution of 3 840 x 2 160 or 4 096 x 2 160) using the Interface Board for HDMI 2 input (Model No.: ET-MDNHM10), it is necessary for the firmware version of the Interface Board for HDMI 2 input to be 2.00 or later. If the version is earlier than 2.00, the simultaneous process is not performed even if corresponding signal is input. Consult your dealer regarding the version update to the latest firmware.

For details on how to confirm the firmware version, refer to "How to confirm the firmware version of the Interface Board" (➔ page 36).

*5 This is supported when Interface Board for 12G-SDI (Model No.: ET-MDN12G10) is installed in both of the slots.

Note

- The geometric adjustment function cannot be used when the video signal in simultaneous format is input.

Specifications

The specifications of the projector are as follows.

Power supply		100 V - 120 V / 200 V - 240 V ~ (100 V - 120 V / 200 V - 240 V alternating current), 50 Hz/60 Hz	
Power consumption		1 100 W (11.5 A) / 4 100 W (20.8 A)	
Power consumption (during standby)		6 W	
DLP chip	Size	35.1 mm (1.38") (aspect ratio 17:9)	
	Display system	DLP chip x 3, DLP projection system	
	Number of pixels	8 847 360 pixels (4 096 x 2 160 dots)	
Lens		Optional	
Light source		Laser diode x 2	
Light output*1,2		50 000 lm	When [OPERATING MODE] is set to [NORMAL]
		40 000 lm	When [OPERATING MODE] is set to [ECO]
Center to corner zone ratio*1		90 %	
Contrast ratio*1		20 000:1 (when [DYNAMIC CONTRAST] is set to [3])	
Projected image size		2.54 m (100") to 38.10 m (1 500")	
Image aspect ratio		17:9	
Projection method		[FRONT/CEILING], [FRONT/FLOOR], [REAR/CEILING], [REAR/FLOOR]	
Power cord length		3.0 m (118-1/8")	
Outer case		Fabricated metal and molded plastic	
Outer color		Black	
Dimensions	Width	720 mm (28-11/32") (excluding protrusions)	
	Height	511 mm (20-1/8") (with the feet at shortest position)	
		445 mm (17-17/32") (excluding the feet and protrusions)	
Depth	1 070 mm (42-1/8") (excluding protrusions)		
Weight		Approx. 126 kg (278 lbs.)*3	
Noise level*1		52 dB	
Laser Classification	Laser Class	USA and Canada: Class 3R (IEC 60825-1:2007)	
	Risk Group	Other countries or regions: Class 1 (IEC/EN 60825-1:2014) Risk Group 3 (IEC 62471-5:2015)	
Operating environment	Operating environment temperature	0 °C (32 °F) to 45 °C (113 °F)*4,5,6	
	Operating environment humidity	10 % to 80 % (no condensation)	
Remote control	Power supply	DC 3 V (AA/R6/LR6 battery x 2)	
	Operating range	Within approx. 30 m (98'5") (when operated directly in front of signal receiver)	
	Weight	150 g (5.3 ozs.) (including batteries)	
	Dimensions	Width: 47.5 mm (1-7/8"), Height: 181.5 mm (7-5/32"), Depth: 27.5 mm (1-3/32")	

*1 Measurement, measuring conditions, and method of notation all comply with ISO/IEC 21118:2012 international standards.

*2 When the projector is used with the power supply voltage of AC 200 V

*3 Average value. Weight varies for each product.

*4 The operating environment temperature should be between 0 °C (32 °F) and 40 °C (104 °F) if the projector is used at an altitude between 1 400 m (4 593') and 4 200 m (13 780') above sea level.

*5 The operating environment temperature should be between 0 °C (32 °F) and 40 °C (104 °F) when the optional Wireless Module (Model No.: AJ-WM50 Series) is attached.

*6 When the [PROJECTOR SETUP] menu → [OPERATION SETTING] → [OPERATING MODE] is set to [NORMAL] or [ECO], and the operating environment temperature exceeds the following value, the light output may be reduced to protect the projector.

- When using the projector at an altitude lower than 2 700 m (8 858') above sea level: 30 °C (86 °F)

- When using the projector at an altitude between 2 700 m (8 858') and 4 200 m (13 780') above sea level: 25 °C (77 °F)

Note

- The light output will decrease to approximately 1/5 when using the projector with AC 100 V to AC 120 V.
- The model numbers of accessories and optional accessories are subject to change without prior notice.

■ Connecting terminal/slot

<MULTI PROJECTOR SYNC IN> terminal	1 set (BNC) TTL high impedance
<MULTI PROJECTOR SYNC OUT> terminal	1 set (BNC) TTL output: Maximum 10 mA
<SERIAL IN> terminal <SERIAL OUT> terminal	D-Sub 9 p, 1 set each, RS-232C compliant, for computer control
<REMOTE 1 IN> terminal <REMOTE 1 OUT> terminal	M3 stereo mini jack, 1 set each, for remote control (wired)/for projector connection control
<REMOTE 2 IN> terminal	1 set, D-Sub 9 p, for contact control
<DIGITAL LINK> terminal	1 set, RJ-45, for network and DIGITAL LINK connections (HDBaseT™ compliant), PLink (class 2) compatible, 100Base-TX, Art-Net compatible, HDCP 2.2 compatible, Deep Color compatible
<LAN> terminal	1 set, RJ-45, for network connection, PLink (class 2) compatible, 10Base-T/100Base-TX, Art-Net compatible
<SLOT 1> <SLOT 2>	Total 2 sets (1 free slot), SLOT NX specification, for installing the Interface Board The supplied Interface Board for 12G-SDI (Model No.: ET-MDN12G10) is already installed in <SLOT 1>.
<USB> terminal	1 set, USB connector (type A), for connecting the optional Wireless Module (Model No.: AJ-WM50 Series), for connecting USB memory
<DC OUT 1> terminal <DC OUT 2> terminal	2 sets, USB connector (type A), for power supply only (DC 5 V, 2 A total for two sets)

■ Wireless LAN

To use the wireless LAN function with the projector, it is necessary to attach the optional Wireless Module (Model No.: AJ-WM50 Series).

Compliance standards	IEEE802.11b/g/n	
Transmission method	DSSS, OFDM	
Frequency range (Channel)	2 412 MHz to 2 462 MHz (1 to 11ch)	
Data transfer speed (Standard value)	IEEE802.11n	Maximum 144 Mbps
	IEEE802.11g	Maximum 54 Mbps
	IEEE802.11b	Maximum 11 Mbps
Encryption method	WPA2-PSK (AES)	

■ Compatible signal

For details of the types of video signals that can be used with the projector, refer to “List of compatible signals” (➔ page 274).

SDI signal input^{*1}
HD-SDI signal 3G-SDI signal 6G-SDI signal 12G-SDI signal
DIGITAL LINK signal input
<ul style="list-style-type: none"> Moving image signal resolution: 480/60p, 576/50p to 4 096 x 2 160 Still image signal resolution: 640 x 400 to 1 920 x 1 200 (non-interlace) Dot clock frequency: 25 MHz to 297 MHz
HDMI signal input^{*2}
<ul style="list-style-type: none"> Moving image signal resolution: 480/60p, 576/50p to 4 096 x 2 160 Still image signal resolution: 640 x 400 to 1 920 x 1 200 (non-interlace) Dot clock frequency: 25 MHz to 594 MHz
DVI-D signal input^{*3}
<ul style="list-style-type: none"> Moving image signal resolution: 480/60p, 576/50p to 2 048 x 1 080 Still image signal resolution: 640 x 400 to 1 920 x 1 200 (non-interlace) Dot clock frequency: 25 MHz to 162 MHz
DisplayPort signal input^{*4}
<ul style="list-style-type: none"> Moving image signal resolution: 720/60p to 4 096 x 2 160/60p Still image signal resolution: 640 x 480 to 1 920 x 1 200 (non-interlace) Dot clock frequency: 25 MHz to 594 MHz

*1 This is supported when the Interface Board for 12G-SDI (Model No.: ET-MDN12G10) is installed in the slot.

*2 This is supported when the optional Interface Board for HDMI 2 input (Model No.: ET-MDNHM10) is installed in the slot.

*3 This is supported when the optional Interface Board for DVI-D 2 input (Model No.: ET-MDNDV10) is installed in the slot.

*4 This is supported when the optional Interface Board for DisplayPort 2 input (Model No.: ET-MDNDP10) is installed in the slot.

Note

- When performing the simultaneous input of the 4K image (resolution of 3 840 x 2 160 or 4 096 x 2 160) using the Interface Board for HDMI 2 input (Model No.: ET-MDNHM10), it is necessary for the firmware version of the Interface Board for HDMI 2 input to be 2.00 or later. If the version is earlier than 2.00, the simultaneous process is not performed even if corresponding signal is input. Consult your dealer regarding the version update to the latest firmware.

For details on how to confirm the firmware version, refer to “How to confirm the firmware version of the Interface Board” (➔ page 36).

Dimensions

Unit: mm

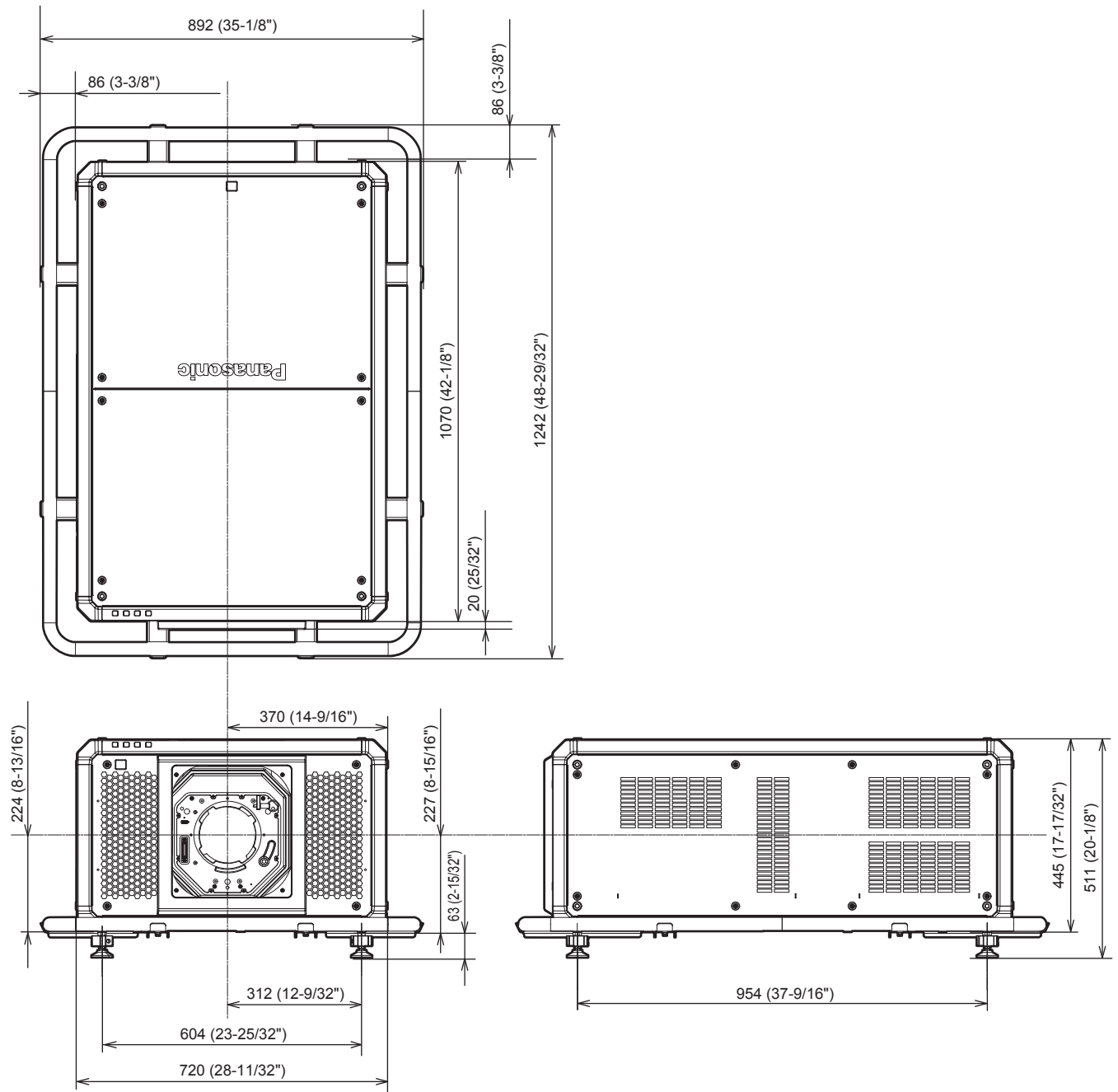

* Actual dimensions may differ depending on the product.

Installing the Interface Board

This projector is equipped with two SLOT NX-specification slots.

There is one DIGITAL LINK input equipped on this projector as the standard video input terminal. The input for HDMI, DVI-D, and SDI can be added by installing the optional Interface Board in the slot.

Requesting a qualified technician to install or remove the optional Interface Board is recommended. A malfunction may occur due to static electricity. Consult your dealer.

Before installing or removing

- Always turn off the power of the projector before installing or removing the Interface Board.
 - Always follow the procedure of “Switching off the projector” (➔ page 68) when turning off the power.
- Do not touch the connector section of the Interface Board directly with your hands.
 - The component may be damaged by the static electricity.
- Remove the static electricity from your body by touching to surrounding metal, etc., in advance to prevent the static electricity damage.
- Take care not to get injured when installing or removing the Interface Board.
 - Hands may be injured by the opening of the blank slot or the edge of the bracket of the Interface Board.
- When installing the Interface Board to the slot, insert it into the connector straight and slowly.
 - It may not operate or cause malfunction if it is not correctly installed.
- The figure indicating the installation and removal of the Interface Board is using the Interface Board for HDMI 2 input (Model No.: ET-MDNHM10) as an example.

How to install the Interface Board

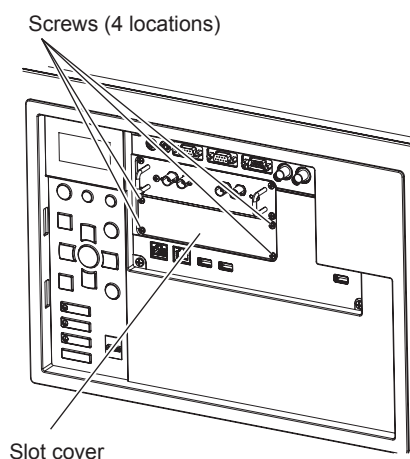

Fig. 1

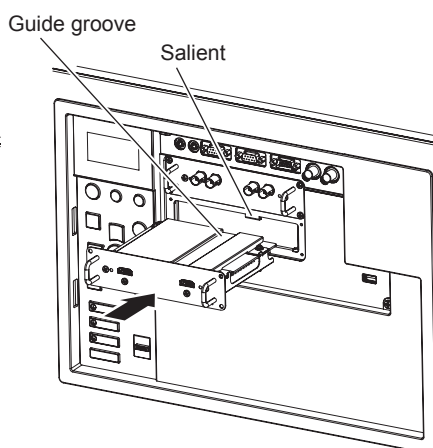

Fig. 2

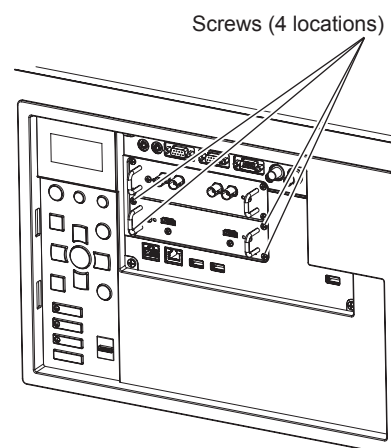

Fig. 3

1) Remove the slot cover. (Fig. 1)

- Remove the four screws fixing the slot cover by rotating counterclockwise with a Phillips screwdriver. The removed screws are used to fix the Interface Board.
- When removing the fourth screw, hold the slot cover with your hand so it will not fall.
- To replace from other Interface Board, remove the Interface Board following the procedure in “How to remove the Interface Board” (➔ page 295).

2) Install the Interface Board to the projector. (Fig. 2)

- Insert the guide groove of the Interface Board aligned to the salient of the slot. Insert the bracket firmly all the way in.

3) Fix the Interface Board. (Fig. 3)

- Tighten and fix with the four screws removed in Step 1).

Attention

- The removed slot cover is required when the unnecessary Interface Board is removed. Store it so it can be attached in the future.

How to remove the Interface Board

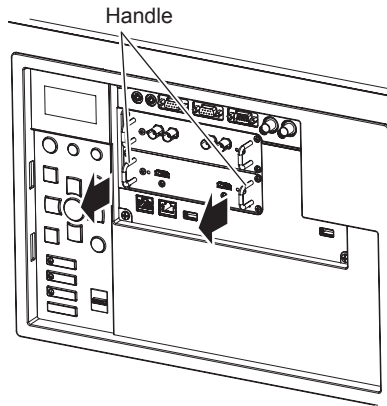

Fig. 1

1) Remove the Interface Board. (Fig. 1)

- Remove the four screws fixing the Interface Board by rotating counterclockwise with a Phillips screwdriver. The removed screws are used to fix the slot cover.
- Hold the handle of the Interface Board and remove it slowly.

2) Attach the slot cover.

- Attach the stored slot cover, and tighten and fix with the four screws removed in Step 1).
- To replace with other Interface Board, attach the Interface Board following the procedure in “How to install the Interface Board” (➔ page 294).

Attention

- Always attach the slot cover on the blank slot.
- Store the removed Interface Board inside an antistatic bag.