

## Projector

# CP-X809W

## User's Manual (detailed) – Operating Guide

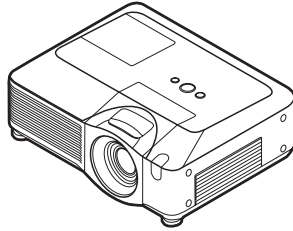

Thank you for purchasing this projector.

**▲ WARNING** ► Before using this product, please read the "User's Manual - Safety Guide" and related manuals to ensure the proper use of this product. After reading them, store them in a safe place for future reference.

### About this manual

Various symbols are used in this manual. The meanings of these symbols are described below.

- ▲ WARNING** This symbol indicates information that, if ignored, could possibly result in personal injury or even death due to incorrect handling.
- ▲ CAUTION** This symbol indicates information that, if ignored, could possibly result in personal injury or physical damage due to incorrect handling.

 Please refer to the pages written following this symbol.

**NOTE** • The information in this manual is subject to change without notice.  
• The manufacturer assumes no responsibility for any errors that may appear in this manual.  
• The reproduction, transfer or copy of all or any part of this document is not permitted without express written consent.

### Trademark acknowledgment

- Microsoft and Internet Explorer, Windows, Windows NT, Windows Me, Windows Vista are registered trademark of Microsoft Corporation.
- PowerPC is a registered trademark of International Business Machines Corporation.
- VESA and DDC are trademarks of the Video Electronics Standard Association.
- Apple and Macintosh, Mac, Mac OS are registered trademarks of Apple Inc.
- Pentium is a registered trademark of Intel Corporation.
- JavaScript is a registered trademark of Sun Microsystems, Inc.
- DVI is a trademark of Digital Display Working Group.
- HDMI, the HDMI logo and High-Definition Multimedia Interface are trademarks or registered trademarks of HDMI Licensing LLC.
-  is a trademark of SRS Labs, Inc. WOW technology is incorporated under license from SRS Labs, Inc.

All other trademarks are the properties of their respective owners.

Contents



<b>About this manual</b> . . . . .	<b>1</b>	(EASY MENU continued . . . . .26)
<b>Contents</b> . . . . .	<b>2</b>	MIRROR, RESET, FILTER TIME, LANGUAGE, Go to Advanced Menu...
<b>Projector features</b> . . . . .	<b>3</b>	
<b>Preparations</b> . . . . .	<b>3</b>	<b>PICTURE menu</b> . . . . . <b>27</b> BRIGHTNESS, CONTRAST, GAMMA, COLOR TEMP, COLOR, TINT, SHARPNESS, ACTIVE IRIS, MY MEMORY
Contents of package . . . . .	3	
Fastening the lens cover . . . . .	3	
<b>Part names</b> . . . . .	<b>4</b>	<b>IMAGE menu</b> . . . . . <b>30</b> ASPECT, OVER SCAN, V POSITION, H POSITION, H PHASE, H SIZE, AUTO ADJUST EXECUTE
Projector . . . . .	4	
Control panel . . . . .	5	
Rear panel . . . . .	5	
Remote control . . . . .	6	
<b>Setting up</b> . . . . .	<b>7</b>	<b>INPUT menu</b> . . . . . <b>32</b> PROGRESSIVE, VIDEO NR, 3D-YCS, COLOR SPACE, COMPONENT, VIDEO FORMAT, HDMI, FRAME LOCK, RGB IN, RESOLUTION
Arrangement . . . . .	8	
Adjusting the projector's elevator . . . . .	9	
Using the security bar and slot . . . . .	9	
Connecting your devices . . . . .	10	
Using a USB storage . . . . .	12	
Using an SD card . . . . .	12	
Connecting power supply . . . . .	13	
<b>Remote control</b> . . . . .	<b>14</b>	<b>SETUP menu</b> . . . . . <b>36</b> AUTO KEYSTONE  EXECUTE, KEYSTONE , KEYSTONE , WHISPER, MIRROR, MONITOR OUT
Laser pointer . . . . .	14	
Installing the batteries . . . . .	14	
About the remote control signal . . . . .	15	
Changing the frequency of remote control signal . . . . .	15	
Using as a wired remote control . . . . .	16	
Using as a simple PC mouse & keyboard . . . . .	16	
<b>Power on/off</b> . . . . .	<b>17</b>	<b>AUDIO menu</b> . . . . . <b>38</b> VOLUME, TREBLE, BASS, SRS WOW, SPEAKER, AUDIO, HDMI AUDIO
Turning on the power . . . . .	17	
Turning off the power . . . . .	17	
<b>Operating</b> . . . . .	<b>18</b>	<b>SCREEN menu</b> . . . . . <b>39</b> LANGUAGE, MENU POSITION, BLANK, START UP, MyScreen, MyScreen Lock, MESSAGE, SOURCE NAME, TEMPLATE
Adjusting the volume . . . . .	18	
Temporarily muting the sound . . . . .	18	
Selecting an input signal . . . . .	18	
Searching an input signal . . . . .	19	
Selecting an aspect ratio . . . . .	19	
Adjusting the zoom and focus . . . . .	20	
Adjusting the lens shift . . . . .	20	
Using the automatic adjustment feature . . . . .	20	
Adjusting the position . . . . .	21	
Correcting the keystone distortions . . . . .	21	
Using the magnify feature . . . . .	22	
Freezing the screen . . . . .	22	
Temporarily blanking the screen . . . . .	23	
Using the menu function . . . . .	24	
<b>EASY MENU</b> . . . . .	<b>25</b>	<b>OPTION menu</b> . . . . . <b>44</b> AUTO SEARCH, AUTO KEYSTONE , AUTO ON, AUTO OFF, LAMP TIME, FILTER TIME, MY BUTTON, MY SOURCE, SERVICE, SECURITY
ASPECT, AUTO KEYSTONE  EXECUTE, KEYSTONE , KEYSTONE , PICTURE MODE, BRIGHTNESS, CONTRAST, COLOR, TINT, SHARPNESS, WHISPER,		<b>MIU menu</b> . . . . . <b>55</b> LIVE MODE, LIVE MODE SETTING, PC-LESS PRESENTATION, SETUP, PROJECTOR NAME, MY IMAGE, INFORMATION, SERVICE
		<b>C.C. (Closed Caption) menu</b> . . . . . <b>64</b> DISPLAY, MODE, CHANNEL
		<b>Maintenance</b> . . . . . <b>65</b> Lamp . . . . . 65 Air filter . . . . . 67 Internal clock battery . . . . . 68 Other care . . . . . 69
		<b>Troubleshooting</b> . . . . . <b>70</b> Related messages . . . . . 70 Regarding the indicator lamps . . . . . 71 Phenomena that may be easy to be mistaken for machine defects . . . . . 73
		<b>Warranty and after-service</b> . . . . . <b>76</b>
		<b>Specifications</b> . . . . . <b>76</b>

## Projector features

This projector has a capability to project various picture signals onto a screen. This projector requires only a minimal amount of space for installation and can produce a large projected image from even a short distance. Moreover, the projector has the following features to extend its potentiality for broad use.

- ✓ The **HDMI** port can support various image equipment which have digital interface to get clearer pictures on a screen.

## Preparations

### Contents of package

Please see the “Contents of package” in the “User’s Manual (concise)” which is a book. Your projector should come with the items shown there. Contact immediately your dealer if anything is missing.

**NOTE** • Keep the original packing materials for future reshipment. Be sure to use the original packing materials when moving the projector. Use special caution for the lens.

### Fastening the lens cover

To avoid losing the lens cover, please fasten the lens cover to the projector using the included strap.

1. Fix the strap to the strap hole of the lens cover.
2. Put one side of the strap into the groove on the rivet.
3. Push the rivet into the rivet hole.

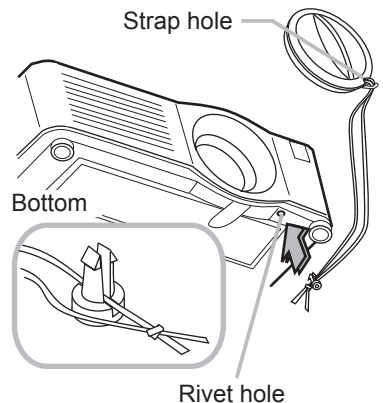

Part names

**Projector**

- (1) Speakers (x 4) (📖38)
- (2) Focus ring (📖20)
- (3) Zoom ring (📖20)
- (4) Lamp cover (📖65)
- The lamp unit is inside.
- (5) Lens shift cover (📖20)
- (6) Horizontal lens shift dial (📖20)
- (7) Vertical lens shift dial (📖20)
- (8) Front cover
- (9) Lens (📖69)
- (10) Lens cover (📖3)
- (11) Remote sensors (x 3) (📖15)
- (12) Elevator feet (x 2) (📖9)
- (13) Elevator knobs (x 2) (📖9)
- (14) Filter cover (📖67)

The air filter and intake vent are inside.

- (15) Exhaust vents
- (16) Intake vents
- (17) Rivet hole (📖3)
- (18) Handle
- (19) Battery cover (📖68)
- (20) Control panel (📖5)
- (21) Rear panel (📖5)

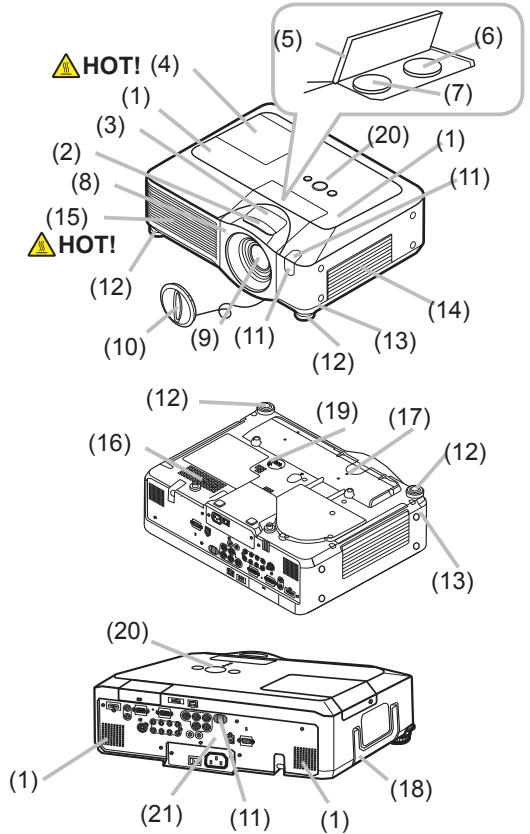

**⚠ WARNING ▶HOT!** : Do not touch around the lamp cover and the exhaust vents during use or just after use, since it is too hot.

- ▶ Do not look into the lens or vents while the lamp is on, since the strong light is not good for your eyes.
- ▶ Do not grab the front cover to hold the projector up, since the projector may drop down.
- ▶ Do not handle the elevator knobs without holding the projector, since the projector may drop down.

**⚠ CAUTION ▶** Maintain normal ventilation to prevent the projector from heating up. Do not cover, block or plug up the vents. Do not place anything that can stick or be sucked to the vents, around the intake vents. Clean the air filter periodically.

## Control panel

- (1) **STANDBY/ON** button (📖17)
- (2) **MENU** button (📖24)  
It consists of four cursor buttons.
- (3) **INPUT** button (📖18)
- (4) **POWER** indicator (📖17, 71)
- (5) **TEMP** indicator (📖71)
- (6) **LAMP** indicator (📖71)

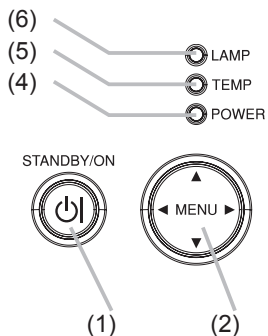

## Rear panel

- (1) Shutdown switch (📖73)
- (2) Security slot (📖9)
- (3) Security bar (📖9)
- (4) **AC IN** (AC inlet) (📖13)
- (5) Power switch (📖17)
- (6) **RGB1** port (📖10)
- (7) **RGB2**(G/Y, B/C<sub>B</sub>/P<sub>B</sub>, R/C<sub>R</sub>/P<sub>R</sub>, H, V) port (📖10)
- (8) **CONTROL** port (📖10)
- (9) **HDMI** port (📖10)
- (10) **VIDEO** port (📖10)
- (11) **S-VIDEO** port (📖10)
- (12) **COMPONENT** (Y, C<sub>B</sub>/P<sub>B</sub>, C<sub>R</sub>/P<sub>R</sub>) ports (📖10)
- (13) **AUDIO IN1** port (📖10)
- (14) **AUDIO IN2** port (📖10)
- (15) **AUDIO IN3** (R/L) ports (📖10)
- (16) **AUDIO IN4** (R/L) ports (📖10)
- (17) **RGB OUT** port (📖10)
- (18) **AUDIO OUT** port (📖10)
- (19) **REMOTE CONTROL** port (📖10)
- (20) **LAN** port (📖10)
- (21) **SD card slot cover** (📖12)  
The SD card slot is inside.
- (22) **AUX I/O** port (📖12)
- (23) **USB** port (📖10)

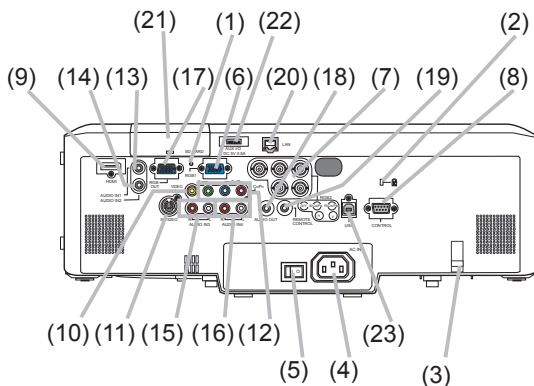

**⚠ CAUTION** ▶ Do not use the security bar and the security slot to prevent the projector from falling down, since it is not designed for it.

▶ Use the shutdown switch only when the projector is not turned off by normal procedure, since pushing this switch stops operation of the projector without cooling it down.

## Remote control

- (1) Laser pointer (14)  
It is a beam outlet.
- (2) LASER INDICATOR (14)
- (3) LASER button (14)
- (4) STANDBY/ON button (14)
- (5) VOLUME+/- buttons (18)
- (6) MUTE button (18)
- (7) VIDEO button (19)
- (8) RGB button (18)
- (9) SEARCH button (19)
- (10) AUTO button (20)
- (11) ASPECT button (19)
- (12) POSITION button (21)
- (13) KEYSTONE button (21)
- (14) MY SOURCE/DOC.CAMERA button (19)
- (15) MAGNIFY - ON/- OFF buttons (22)
- (16) FREEZE button (22)
- (17) BLANK button (23)
- (18) MY BUTTON - 1 button (46)
- (19) MY BUTTON - 2 button (46)
- (20) MENU button (24)
- (21) Lever switch (24) : acting 3 functions as below.  
Cursor button ▲ : to slide toward the side marked ▲ .  
Cursor button ▼ : to slide toward the side marked ▼ .  
ENTER button : to push down the center point.
- (22) Cursor button ◀ (24)
- (23) Cursor button ▶ (24)
- (24) RESET button (24)
- (25) ESC button (24)
- (26) Mouse left button (16)
- (27) Mouse right button (16)
- (28) PAGE UP button (16)
- (29) PAGE DOWN button (16)
- (30) Wired remote control port (16)
- (31) Battery cover (14)
- (32) Battery holder (14)
- (33) Frequency switch (15)

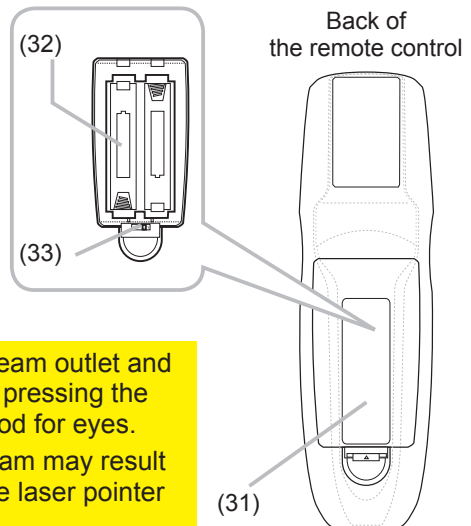
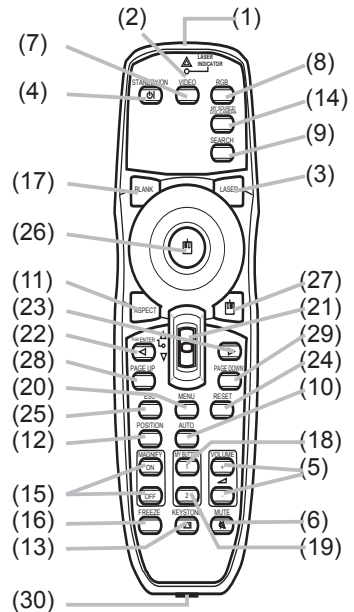

**⚠ WARNING** ▶ Do not look into the beam outlet and point the beam at people and pets while pressing the LASER button, since the beam is not good for eyes.

**⚠ CAUTION** ▶ Note that the laser beam may result in hazardous radiation exposure. Use the laser pointer only for pointing on the screen.

## Setting up

Install the projector according to the environment and manner the projector will be used in.

**⚠ WARNING** ► Place the projector in a stable horizontal position. If the projector falls or is knocked over, it could cause injury and/or damage to the projector. Using a damaged projector could then result in fire and/or electric shock.

- Do not place the projector on an unstable, slanted or vibrational surface such as a wobbly or inclined stand.
- Do not place the projector on its side, front or rear position.
- Consult with your dealer before a special installation such as suspending from a ceiling.
- Place the projector in a cool place, and ensure that there is sufficient ventilation. The high temperature of the projector could cause fire, burns and/or malfunction of the projector.
- Do not stop-up, block or otherwise cover the projector's vents.
- Keep a space of 30 cm or more between the sides of the projector and other objects such as walls.
- Do not place the projector on metallic thing or anything weak in heat.
- Do not place the projector on carpet, cushions or bedding.
- Do not place the projector in direct sunlight or near hot objects such as heaters.
- Do not place anything near the projector lens or vents, or on top of the projector.
- Do not place anything that may be sucked into or stick to the vents on the bottom of the projector. This projector has some intake vents also on the bottom.
- Do not place the projector anyplace where it may get wet. Getting the projector wet or inserting liquid into the projector could cause fire, electric shock and/or malfunction of the projector.
- Do not place the projector in a bathroom or the outdoors.
- Do not place anything containing liquid near the projector.

**⚠ CAUTION** ► Avoid placing the projector in smoky, humid or dusty place. Placing the projector in such places could cause fire, electric shock and/or malfunction of the projector.

- Do not place the projector near humidifiers, smoking spaces or a kitchen.
- Position the projector to prevent light from directly hitting the projector's remote sensor.

## Arrangement

Refer to the illustrations and tables below to determine screen size and projection distance. The values shown in the table are calculated for a full size screen: 1024×768

(a) Screen size (diagonal)

(b) Projection distance (±10%)

(c) Screen height (±10%), when the vertical lens shift (📖 20) is set full upward.

### On a horizontal surface

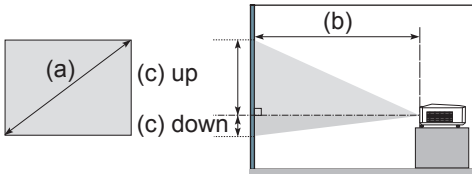

### Suspended from the ceiling

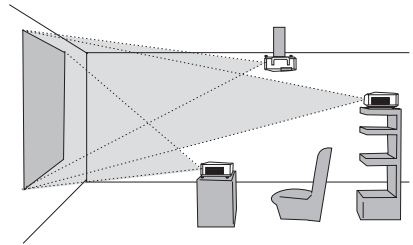
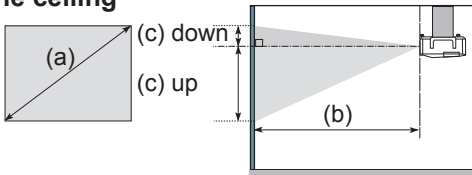

- Keep a space of 30 cm or more between the sides of the projector and other objects such as walls.
- Consult with your dealer before a special installation such as suspending from a ceiling.

(a) Screen size [inch (m)]	4 : 3 screen				16 : 9 screen			
	(b) Projection distance [m (inch)]		(c) Screen height [cm (inch)]		(b) Projection distance [m (inch)]		(c) Screen height [cm (inch)]	
	min.	max.	down	up	min.	max.	down	up
30 (0.8)	0.9 (35)	1.1 (42)	5 (2)	41 (16)	1.0 (38)	1.2 (46)	-1 (0)	39 (15)
40 (1.0)	1.2 (47)	1.4 (57)	6 (2)	55 (22)	1.3 (51)	1.6 (62)	-2 (-1)	51 (20)
60 (1.5)	1.8 (71)	2.2 (86)	9 (4)	82 (32)	2.0 (78)	2.4 (94)	-2 (-1)	77 (30)
70 (1.8)	2.1 (83)	2.6 (100)	11 (4)	96 (38)	2.3 (91)	2.8 (110)	-3 (-1)	90 (35)
80 (2.0)	2.4 (96)	2.9 (115)	12 (5)	110 (43)	2.6 (104)	3.2 (126)	-3 (-1)	103 (41)
90 (2.3)	2.7 (108)	3.3 (130)	14 (5)	123 (49)	3.0 (117)	3.6 (141)	-4 (-1)	116 (46)
100 (2.5)	3.0 (120)	3.7 (144)	15 (6)	137 (54)	3.3 (131)	4.0 (157)	-4 (-2)	129 (51)
120 (3.0)	3.7 (144)	4.4 (174)	18 (7)	165 (65)	4.0 (157)	4.8 (189)	-5 (-2)	154 (61)
150 (3.8)	4.6 (181)	5.5 (217)	23 (9)	206 (81)	5.0 (197)	6.0 (237)	-6 (-2)	193 (76)
200 (5.1)	6.1 (241)	7.4 (291)	30 (12)	274 (108)	6.7 (263)	8.0 (317)	-8 (-3)	257 (101)
250 (6.4)	7.7 (302)	9.2 (364)	38 (15)	343 (135)	8.4 (329)	10.1 (396)	-10 (-4)	322 (127)
300 (7.6)	9.2 (363)	11.1 (437)	46 (18)	411 (162)	10.0 (395)	12.1 (476)	-12 (-5)	386 (152)
350 (8.9)	10.8 (424)	13.0 (510)	53 (21)	480 (189)	11.7 (462)	14.1 (556)	-15 (-6)	450 (177)



## Adjusting the projector's elevator

When the place to put the projector is slightly uneven to the left or right, use the elevator feet to place the projector horizontally.

Using the feet can also tilt the projector in order to project at a suitable angle to the screen, elevating the front side of the projector within 10 degrees.

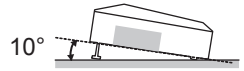

This projector has 2 elevator feet and 2 elevator knobs. An elevator foot is adjustable while pulling up the elevator knob on the same side as it.

1. Holding the projector, pull the elevator knobs up to loose the elevator feet.
2. Position the front side of the projector to the desired height.
3. Release the elevator knobs in order to lock the elevator feet.
4. After making sure that the elevator feet are locked, put the projector down gently.
5. If necessary, the elevator feet can be manually twisted to make more precise adjustments. Hold the projector when twisting the feet.

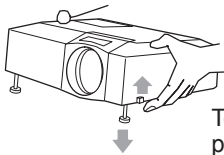

To loose an elevator foot, pull up the elevator knob on the same side as it.

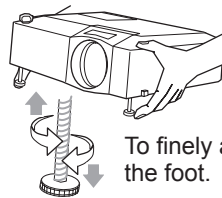

To finely adjust, twist the foot.

**⚠ CAUTION** ▶ Do not handle the elevator knobs without holding the projector, since the projector may drop down.  
▶ Do not tilt the projector other than elevating its front within 10 degrees using the adjuster feet. A tilt of the projector exceeding the restriction could cause malfunction or shortening the lifetime of consumables, or the projector itself.

## Using the security bar and slot

A commercial anti-theft chain or wire up to 10 mm in diameter can be attached to the security bar on the projector.

Also this product has the security slot for the Kensington lock.

For details, see the manual of the security tool.

**⚠ WARNING** ▶ Do not use the security bar and the security slot to prevent the projector from falling down, since it is not designed for it.

**NOTE** • The security bar and the security slot are not comprehensive theft prevention measures. They are intended to be used as supplemental theft prevention measure.

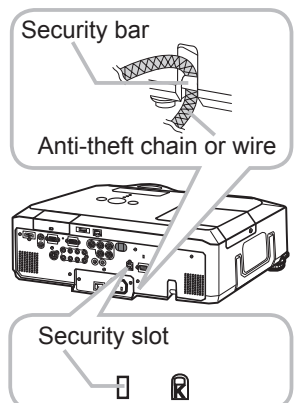

## Connecting your devices

Be sure to read the manuals for devices before connecting them to the projector. Make sure that all the devices are suitable to be connected with this product, and prepare the cables required to connect. Please refer to the following illustrations to connect them.

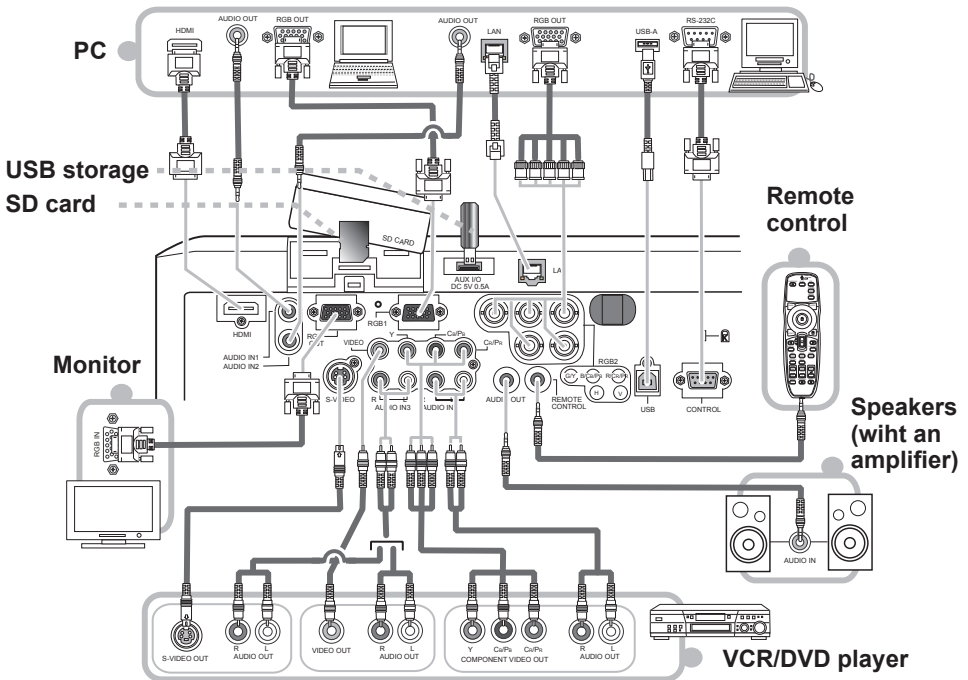

- ⚠ **WARNING** ▶ Do not disassemble or modify the projector.
- ▶ Be careful not to damage the cables, and do not use damaged cables.
- ⚠ **CAUTION** ▶ Turn off all devices and unplug their power cords prior to connecting them to projector. Connecting a live device to the projector may generate extremely loud noises or other abnormalities that may result in malfunction or damage to the device and the projector.
- ▶ Use appropriate accessory or designated cables. Ask your dealer about non-accessory cables which may be required a specific length or a ferrite core by the regulations. For cables with a core only at one end, connect the end with the core to the projector.
- ▶ Make sure that devices are connected to the correct ports. An incorrect connection may result in malfunction or damage to the device and the projector.

## Connecting your devices (continued)

**NOTE** • Be sure to read the manuals for devices before connecting them to the projector, and make sure that all the devices are suitable to be connected with this product. Before connecting to a PC, check the signal level, the signal timing, and the resolution.

- Be sure to consult to the administrator of the network. Do not connect **LAN** port to any network that might have the excessive voltage.
- Some signal may need an adapter to input this projector.
- Some PCs have multiple screen display modes that may include some signals which are not supported by this projector.
- Although the projector can display signals with resolution up to UXGA (1600X1200), the signal will be converted to the projector's panel resolution before being displayed. The best display performance will be achieved if the resolutions of the input signal and the projector panel are identical.
- While connecting, make sure that the shape of the cable's connector fits the port to connect with. And be sure to tighten the screws on connectors with screws.
- When connecting a laptop PC to the projector, be sure to activate the PC's external RGB output. (Set the laptop PC to CRT display or to simultaneous LCD and CRT display.) For details on how this is done, please refer to the instruction manual of the corresponding laptop PC.
- When the picture resolution is changed on a computer depending on an input, automatic adjustment function may take some time and may not be completed. In this case, you may not be able to see a check box to select "Yes/No" for the new resolution on Windows. Then the resolution will go back to the original. It might be recommended to use other CRT or LCD monitors to change the resolution.
- In some cases, this projector may not display a proper picture or display any picture on screen. For example, automatic adjustment may not function correctly with some input signals. An input signal of composite sync or sync on G may confuse this projector, so the projector may not display a proper picture.
- The **HDMI** port of this model is compatible with HDCP (High-bandwidth Digital Content Protection) and therefore capable of displaying a video signal from HDCP compatible DVD players or the like.

### About Plug-and-Play capability

Plug-and-Play is a system composed of a computer, its operating system and peripheral equipment (i.e. display devices). This projector is VESA DDC 2B compatible. Plug-and-Play can be used by connecting this projector to a computer that is VESA DDC (display data channel) compatible.

- Take advantage of this feature by connecting an RGB cable to the **RGB1** port (DDC 2B compatible). Plug-and-Play may not work properly if any other type of connection is attempted.
- Please use the standard drivers in your computer as this projector is a Plug-and-Play monitor.

### NOTE for HDMI

- The **HDMI** supports the following signals.
  - Video signal : 480i@60,480p@60,576i@50,720p@50/60,1080i@50/60,1080p@50/60
  - PC signals : See User's Manual (detailed) Technical
  - Audio signal : Format Linear PCM  
Sampling Frequency 48kHz / 44.1kHz / 32kHz
- This projector can be connected with another equipment that has HDMI or DVI connector, but with some equipment the projector may not work properly, something like no video or no audio.
- Be sure to use an HDMI cable that has the HDMI logo.
- When the projector is connected with a device having DVI connector, use a DVI to HDMI cable to connect with the **HDMI** input and an audio cable to connect with one of the **AUDIO** input.

## Using a USB storage

In order to view images stored in a USB storage, such as a USB memory, insert the device into the **AUX I/O** port. Before removing the USB storage, be sure to perform the REMOVE MEDIA procedure using the PC-LESS PRESENTATION menu under the MIU menu.

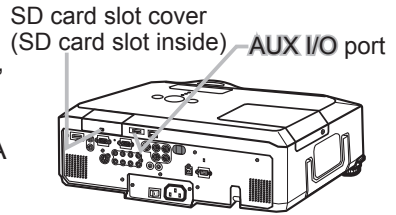

## Using an SD card

In order to view images stored in an SD storage, such as an SD memory card, insert the device into the SD card slot. Or, in order to use the wireless network function, load the internal clock battery (🔋68) and insert the designated wireless network card that is sold as an option (🔋76) into the slot.

### Inserting the SD card

1. Make sure that the power code is not plugged into the projector for the wireless network card only.
2. Remove the SD card slot cover. After slowly insert the SD card completely into the SD card slot, replace the SD card slot cover.



Angled corner



### Using the slot cover lock for security

Using the enclosed slot cover lock can prevent the SD card slot cover from being opened.

1. Open the two plates of the slot cover lock to put the tips of two plates together, and then insert the tips to the lock hole of the SD card slot cover.
2. Put the body of the two plates together. Then, hook a padlock or combination lock to the hole of the slot cover lock.



### Removing the SD card

1. Perform the REMOVE MEDIA procedure using the PC-LESS PRESENTATION menu under the MIU menu for SD storage card only.
2. Turn the projector off and unplug the power code from the projector for the wireless network card only.
3. Remove the SD card slot cover. After taking the SD card away, replace the SD card slot cover.

**⚠ CAUTION** ▶ Do not touch the SD card while being accessed.

▶ To use the wireless network function, the designated wireless network card that is sold as an option is required.

- The wireless network card is not permitted to be sold or used in some countries and regions. Use the card only in the country or region where you buy it. For more information, ask your local dealer.

- When using the wireless network card, to comply with FCC RF exposure compliance requirements, the antenna used for this transmitter must be installed to provide a separation distance of at least 20 cm from all persons and must not be co-located or operating in conjunction with any other antenna or transmitter.

- Before using the projector with a wired LAN, remove the wireless network card.

## Connecting power supply

1. Connect the connector of the power cord to the **AC IN** (AC inlet) of the projector.
2. Firmly plug the power cord's plug into the outlet.

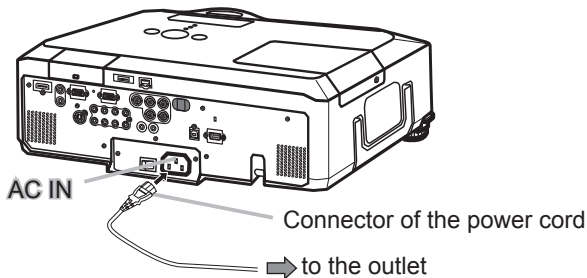

**⚠ WARNING** ▶ Please use extra caution when connecting the power cord, as incorrect or faulty connections may result in fire and/or electrical shock.

- Only use the power cord that came with the projector. If it is damaged, contact your dealer to get a new one.
- Only plug the power cord into an outlet whose voltage is matched to the power cord. The power outlet should be close to the projector and easily accessible. Remove the power cord for complete separation.
- Never modify the power cord.

## Remote control

### Laser pointer

This remote control has a laser pointer in place of a finger or rod. The laser beam works and the **LASER INDICATOR** lights while the **LASER** button is pressed.

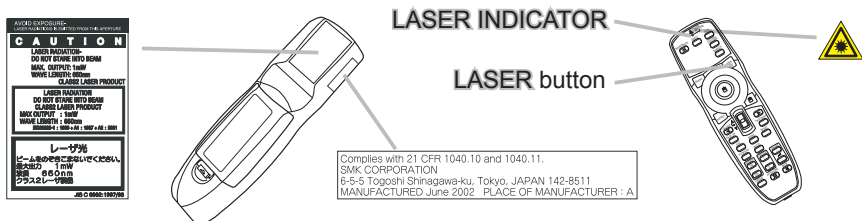

**⚠ WARNING** ▶ The laser pointer of the remote control is used in place of a finger or rod. Never look directly into the laser beam outlet or point the laser beam at other people. The laser beam can cause vision problems.

**⚠ CAUTION** ▶ Use of controls or adjustments or performance of procedures other than those specified herein may result in hazardous radiation exposure.

### Installing the batteries

Please insert the batteries before using the remote control. If the remote control starts to malfunction, replace the batteries. If you will not use the remote control for an extended period, remove the batteries from the remote control and store them in a safe place.

1. Slide back and remove the battery cover in the direction of the arrow.
2. Align and insert the two AA batteries (**HITACHI MAXELL, Part No.LR6 or R6P**) according to their plus and minus terminals as indicated in the remote control.
3. Replace the battery cover in the direction of the arrow and snap it back into place.

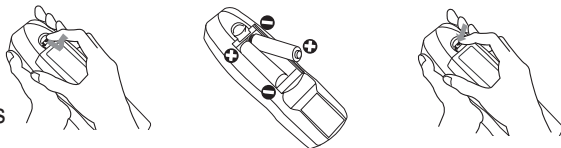

**⚠ WARNING** ▶ Always handle the batteries with care and use them only as directed. Improper use may result in battery explosion, cracking or leakage, which could result in fire, injury and/or pollution of the surrounding environment.

- Be sure to use only the batteries specified. Do not use batteries of different types at the same time. Do not mix a new battery with used one.
- Make sure the plus and minus terminals are correctly aligned when loading a battery.
- Keep a battery away from children and pets.
- Do not recharge, short circuit, solder or disassemble a battery.
- Do not place a battery in a fire or water. Keep batteries in a dark, cool and dry place.
- If you observe battery leakage, wipe out the leakage and then replace a battery. If the leakage adheres to your body or clothes, rinse well with water immediately.
- Obey the local laws on disposing the battery.

## About the remote control signal

The remote control works with the projector's remote sensors. This projector has three remote sensors on the front, on the top, and on the back.

The sensors can be respectively turned active or inactive using the "REMOTE RECEIV." in the SERVICE item of OPTION menu (📖48). Each sensor senses the signal within the following range when the sensor is active.

### The front and top sensors:

60 degrees (30 degrees to the left and right of the sensor) within 3 meters about.

### The back sensor:

40 degrees (20 degrees to the left and right of the sensor) within 3 meters about.

**NOTE** • The remote control signal reflected in the screen or the like may be available. If it is difficult to send the signal to the sensor directly, attempt to make the signal reflect.

- The remote control uses infrared light to send signals to the projector (Class 1 LED), so be sure to use the remote control in an area free from obstacles that could block the remote control's signal to the projector.

- The remote control may not work correctly if strong light (such as direct sun light) or light from an extremely close range (such as from an inverter fluorescent lamp) shines on the remote sensor of the projector. Adjust the position of projector avoiding those lights.

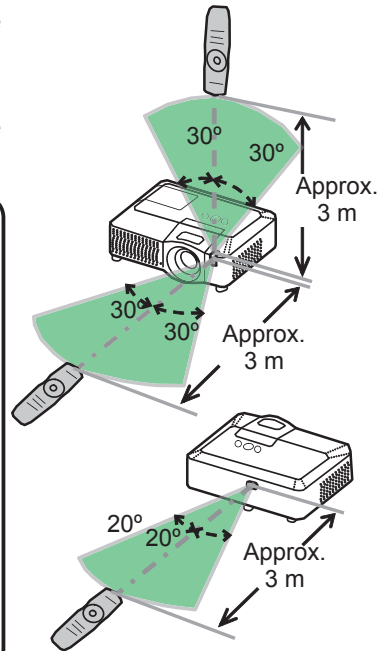

## Changing the frequency of remote control signal

The accessory remote control has the choice of the mode 1 or the mode 2, in the frequency of its signal. If the remote control does not function properly, attempt to change the signal frequency. Please remember that the "REMOTE FREQ." in SERVICE item of OPTION menu (📖48) of the projector to be controlled should be set to the same mode as the remote control.

To set the mode of the remote control, slide the knob of the frequency switch inside the battery cover into the position indicated by the mode number to choose.

Back of the remote control

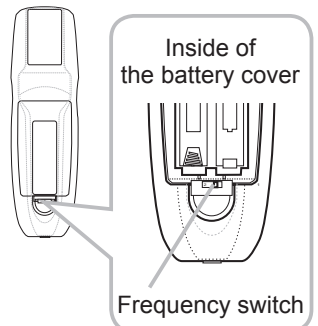

## Using as a wired remote control

The accessory remote control works as a wired remote control, when the wired control port at the bottom of the remote control connects with the **REMOTE CONTROL** port on the back of the projector via an audio cable with 3.5 diameter stereo mini plugs.

When the remote control signal is hard to reach surely to the projector in the environment, this function is effective.

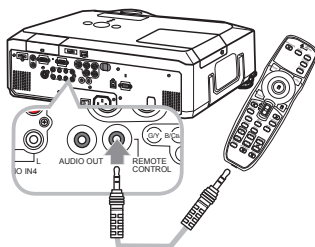

**NOTE** • To connect the remote control with the projector, use an audio cable with 3.5 diameter stereo mini plugs.

## Using as a simple PC mouse & keyboard

The accessory remote control works as a simple mouse and keyboard of the PC, when the projector's **USB** port(B type) connect with the PC's USB port(A type) via a USB cable.

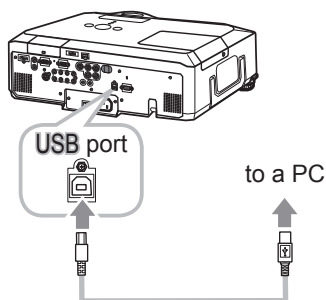

### (1) Mouse left button

Pushing the button into the center point works instead of clicking the mouse's left button.

Tilting this button to one of eight directions moves the PC's move pointer on the screen in the direction.

### (2) Mouse right button

Pressing the button works instead of clicking the mouse's right button.

### (3) Lever switch

Sliding toward the side marked ▲ works instead of the [↑] key on the keyboard. Sliding toward the side marked ▼ works instead of the [↓] key on the keyboard.

### (4) Cursor button ◀

This button works instead of the [←] key on the keyboard.

### (5) Cursor button ▶

This button works instead of the [→] key on the keyboard.

### (6) PAGE UP button

This button works instead of the PAGE UP key on the key board.

### (7) PAGE DOWN button

This button works instead of the PAGE DOWN key on the key board.

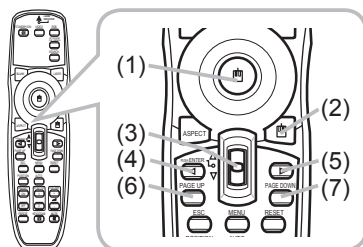

**NOTE** • When the simple mouse & keyboard function of this product does not work correctly, please check the following.

- When a USB cable connects this projector with a PC having a built-in pointing device (e.g. track ball) like a notebook PC, open BIOS setup menu, then select the external mouse and disable the built-in pointing device, because the built-in pointing device may have priority to this function.
- Windows 95 OSR 2.1 or higher is required for this function. And also this function may not work depending on the PC's configurations and mouse drivers.
- Operating simultaneously two or more keys is void except for mouse drag and drop operation.
- This function is activated only when the projector is working properly.



## Power on/off

## Turning on the power

1. Make sure that the power cord is firmly and correctly connected to the projector and the outlet.
2. Remove the lens cover, and set the power switch to the ON position (marked "I").  
The **POWER** indicator will light up in steady orange (📖71). Then wait several seconds because the buttons may not function for these several seconds.
3. Press the **STANDBY/ON** button on the projector or the remote control.

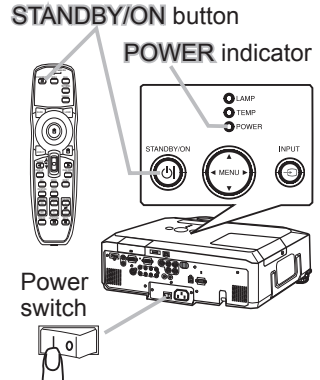

The projection lamp will light up and the **POWER** indicator will begin blinking in green. When the power is completely on, the indicator will stop blinking and light in steady green.

To display the picture, select an input signal according to the section "Selecting an input signal" (📖18,19).

## Turning off the power

1. Press the **STANDBY/ON** button on the projector or the remote control.  
The message "Power off?" will appear on the screen for about 5 seconds.
2. Press the **STANDBY/ON** button on the projector or the remote control again while the message appears.  
The projector lamp will go off, and the **POWER** indicator will begin blinking in orange. Then the **POWER** indicator will stop blinking and light in steady orange when the lamp cooling is complete.
3. Make sure that the **POWER** indicator lights in steady orange, and set the power switch to the OFF position (marked "O").  
The **POWER** indicator will go off. Attach the lens cover.

Do not turn the projector on for 10 minutes or more after turning it off. Turning the projector on again too soon could shorten the lifetime of some consumable parts of the projector.

**⚠ WARNING** ▶ A strong light is emitted when the projector's power is on. Do not look into the lens of the projector or look inside of the projector through any of the projector's openings.

▶ Do not touch around the lamp cover and the exhaust vents during use or just after use, since it is too hot.

**NOTE** • Turn the power on/off in right order. Please power on the projector prior to the connected devices. Power off the projector later than the connected devices.

- When the AUTO ON of the OPTION menu is set to the TURN ON, and the power was turned off by the power switch last time, turning the power switch on makes the projection lamp light on without pushing the **STANDBY/ON** button (📖44).
- Use the shutdown switch (📖73) only when the projector is not turned off by normal procedure.

## Operating

### Adjusting the volume

- Use the **VOLUME + / VOLUME -** buttons to adjust the volume.  
A dialog will appear on the screen to aid you in adjusting the volume. If you do not do anything, the dialog will automatically disappear after a few seconds.

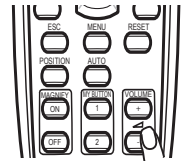

- When  $\times$  is selected for current picture input port, the volume adjustment is disabled. Please see AUDIO item of AUDIO menu (📖38).
- When the projector is in the standby mode, the volume can be adjusted if  $\times$  is not selected for the AUDIO OUT STANDBY of AUDIO (📖38).

### Temporarily muting the sound

- Press **MUTE** button on the remote control.  
A dialog will appear on the screen indicating that you have muted the sound.  
To restore the sound, press the **MUTE**, **VOLUME +** or **VOLUME -** button. Even if you do not do anything, the dialog will automatically disappear after a few seconds.



- When  $\times$  is selected for current picture input port, the sound is always muted. Please see AUDIO item of AUDIO menu (📖38).
- When the sound is muted while a signal from **VIDEO**(NTSC), **S-VIDEO**(NTSC) or **COMPONENT**(480i@60) port is selected, the C.C. (Closed Caption) is automatically activated if the DISPLAY item of the C.C. menu is set to AUTO and the input signal supports the C.C. feature (📖64).

### Selecting an input signal

- Press the **INPUT** button on the projector.  
Each time you press the button, the projector switches its input from the current port as below.

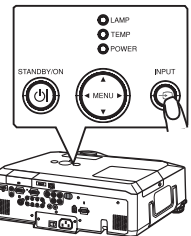

- Press the **RGB** button on the remote control to select an input port for the RGB signal.  
Each time you press the button, the projector switches its RGB input from the current port as below.

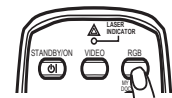
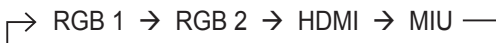

- While TURN ON is selected for AUTO SEARCH item in OPTION menu, the projector will keep checking every port sequentially till an input signal is detected (📖44). If **RGB** button is pushed when **VIDEO**, **S-VIDEO** or **COMPONENT** port is selected, the projector will check **RGB1** port first.

(continued on next page)

### Selecting an input signal (continued)

1. Press the **VIDEO** button on the remote control to select an input for video signal.  
Each time you press the button, the projector switches its video input port as below.

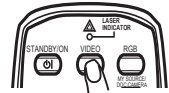

COMPONENT (Y, C<sub>B</sub>/P<sub>B</sub>, C<sub>R</sub>/P<sub>R</sub>) → S-VIDEO → VIDEO



- While **TURN ON** is selected for **AUTO SEARCH** item in **OPTION** menu, the projector will keep checking every port sequentially till an input signal is detected (44). If **VIDEO** button is pushed when **RGB 1** or **RGB 2** port is selected, the projector will check **COMPONENT** port first.
1. Press the **MY SOURCE / DOC. CAMERA** button on the remote control. The input signal will be changed into the signal you set as **MY SOURCE** (46).

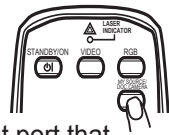

- This function also can use for document camera. Select the input port that connected the document camera.

### Searching an input signal

1. Press the **SEARCH** button on the remote control.  
The projector will start to check its input ports in order to find any input signals.  
When an input is found, the projector will stop searching and display the image. If no signal is found, the projector will return to the state selected before the operation.

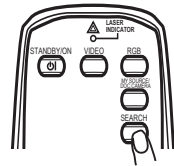

### Selecting an aspect ratio

1. Press the **ASPECT** button on the remote control.  
Each time you press the button, the projector switches the mode for aspect ratio in turn.

- For an **RGB** or **MIU** signal  
NORMAL → 4:3 → 16:9 → SMALL



- For an **HDMI** signal  
NORMAL → 4:3 → 16:9 → 14:9 → SMALL



- For a **video signal, s-video signal or component video signal**  
4:3 → 16:9 → 14:9 → SMALL



- For **no signal**  
4:3 (fixed)

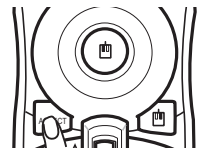

- The **NORMAL** mode keeps the original aspect ratio of the signal.

## Adjusting the zoom and focus

1. Use the zoom ring to adjust the screen size.
2. Use the focus ring to focus the picture.

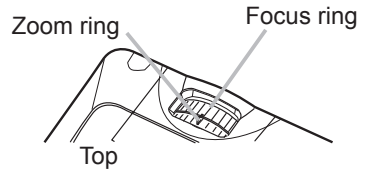

## Adjusting the lens shift

1. Use the vertical lens shift dial to shift the picture upward or downward.
2. Use the horizontal lens shift dial to shift the picture left or right.

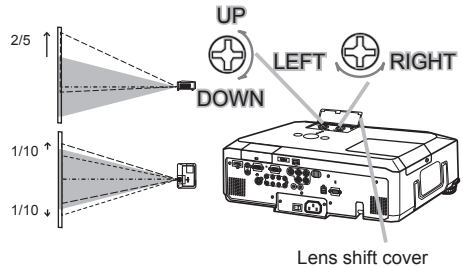

**NOTE** • When the vertical lens shift is adjusted, it is recommended to shift the picture upward.

## Using the automatic adjustment feature

1. Press the **AUTO** button on the remote control.
  - Pressing this button performs the following.
    - **For an RGB or MIU signal**  
The vertical position, the horizontal position and the horizontal phase will be automatically adjusted. Make sure that the application window is set to its maximum size prior to attempting to use this feature. A dark picture may still be incorrectly adjusted. Use a bright picture when adjusting.
    - **For a video signal and s-video signal**  
The video format best suited for the respective input signal will be selected automatically. This function is available only when the AUTO is selected for the VIDEO FORMAT item in the INPUT menu ( 33 ). The vertical position and horizontal position will be automatically set to the default.
    - **For a component video signal**  
The vertical position, horizontal position and horizontal phase will be automatically set to the default.
  - The automatic adjustment operation requires approx. 10 seconds. Also please note that it may not function correctly with some input. When this function is performed for a video signal, a certain extra such as a line may appear outside a picture.
  - The items adjusted by this function may vary when the FINE or DISABLE is selected for the AUTO ADJUST item of the SERVICE item in the OPTION menu ( 47 ).

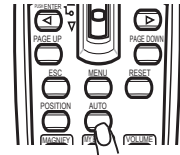

## Adjusting the position

1. Press the **POSITION** button on the remote control when no menu is indicated.  
The “POSITION” indication will appear on the screen.
2. Use the **▲/▼/◀/▶** cursor buttons to adjust the picture position.  
When you want to reset the operation, press the **RESET** button on the remote control during the operation.  
To complete this operation, press the **POSITION** button again. Even if you do not do anything, the dialog will automatically disappear after a few seconds.

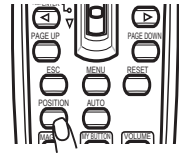

- When this function is performed on a video signal, s-video signal or component video signal, some image such as an extra-line may appear at outside of the picture.
- When this function is performing on a Video signal, S-Video signal, or component signal of 480i@60 or 576i@50 input the range of this adjustment depends on the OVER SCAN in IMAGE menu (📖30). It is not possible to adjust when the OVER SCAN is set to 10.

## Correcting the keystone distortions

1. Press the **KEYSTONE** button on the remote control. A dialog will appear on the screen to aid you in correcting the distortion.
2. Use the **▲/▼** cursor buttons to select **AUTO** or **MANUAL** operation, and press the **▶** button to perform the following.
  - 1) **AUTO** executes automatic vertical keystone correction.
  - 2) **MANUAL** displays a dialog for keystone correction.  
Use the **◀/▶** cursor buttons to select the direction to correct (📐 or 📏) then use the **▲/▼** buttons for adjustment.



To close the dialog and complete this operation, press the **KEYSTONE** button again. Even if you don't do anything, the dialog will automatically disappear after a few seconds.

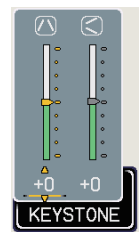

- The adjustable range of this function will vary among inputs. For some input, this function may not work well.
- When V:INVERT or H&V:INVERT is selected to the MIRROR item in the SETUP menu, if the projector screen is inclined or angled downward, this function may not work correctly.
- When the zoom adjustment is set to the TELE (telephoto focus), this function may be excessive. This function should be used when the zoom adjustment is set to the full WIDE (wide-angle focus) whenever possible.
- When the projector is placed on the level (about  $\pm 3^\circ$ ), this function may not work.
- When the projector is inclined to near  $\pm 30$  degree or over, this function may not work well.
- When the vertical lens shift is not set fully upward (not set fully downward for the optional lens type FL-601 only (📖47)), this function may not work well.
- When the horizontal lens shift is not set to the center, this function may not work well.
- This function will be unavailable when Transition Detector is on (📖52).

## Using the magnify feature

1. Press the **ON** button of **MAGNIFY** on the remote control.  
The “MAGNIFY” indication will appear on the screen and the projector will go into the MAGNIFY mode. In the Magnify mode, the picture will be zoomed. The indication will disappear in several seconds with no operation.

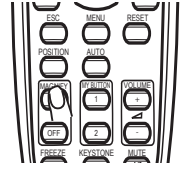

2. Use the **▲/▼** cursor buttons to adjust the zoom level. To move the zoom area, press the **POSITION** button in the MAGNIFY mode, then use the **▲/▼/◀/▶** cursor buttons to move the area. And to finalize the zoom area, press the **POSITION** button again.

To exit from the MAGNIFY mode and restore the screen to normal, press the **OFF** button of **MAGNIFY** on the remote control.

- The projector automatically exits from the MAGNIFY mode when the input signal is changed or when the display condition is changed.
- In the MAGNIFY mode, the keystone distortion condition may vary, it will be restored when the projector exits from the MAGNIFY mode.

**NOTE** • The zoom level can be finely adjusted. Closely watch the screen to find the level you want.

## Freezing the screen

1. Press the **FREEZE** button on the remote control.  
The “FREEZE” indication will appear on the screen (however, the indication will not appear when the TURN OFF is selected for the MESSAGE item in the SCREEN menu (42)), and the projector will go into the FREEZE mode, which the picture is frozen.

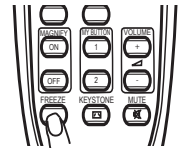

To exit the FREEZE mode and restore the screen to normal, press the **FREEZE** button again.

- The projector automatically exits from the FREEZE mode when some control buttons are pressed.
- If the projector continues projecting a still image for a long time, the LCD panel might possibly be burned in. Do not leave the projector in the FREEZE mode for too long.

## Temporarily blanking the screen

1. Press the **BLANK** button on the remote control.
  - The blank screen will be displayed instead of the screen of input signal. Please refer to the BLANK item in SCREEN menu (📖 39).  
To exit from the blank screen and return to the input signal screen, press the **BLANK** button again.

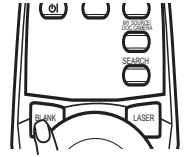

- The projector automatically exits from the BLANK mode when some control buttons are pressed.

**NOTE** • The sound is not connected with the blank screen function. If necessary, set the volume or mute first.

## Using the menu function

This projector has the following menus: PICTURE, IMAGE, INPUT, SETUP, AUDIO, SCREEN, OPTION, MIU, C.C. and EASY MENU. The EASY MENU consists of functions often used, and the other menus are classified into each purpose and brought together as the Advanced Menu. Each of these menus is operated using the same methods. The basic operations of these menus are as follows.

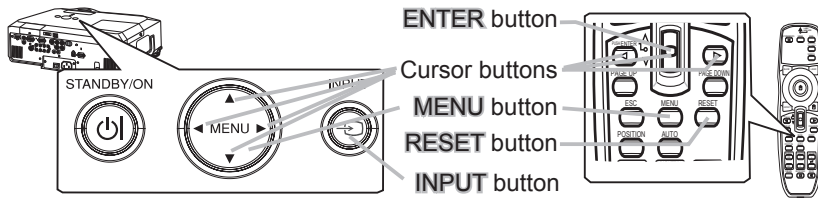

1. Press the **MENU** button on the remote control or one of the cursor buttons on the projector.  
The Advanced MENU, or EASY MENU that has priority just after powered on, will appear.  
If you want to move the menu position, use the cursor buttons after pressing the **POSITION** button. While the projector is displaying any menu, the **MENU** button on the projector works as the cursor buttons.

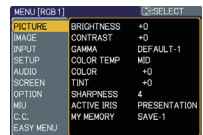

### In the EASY MENU

2. If you want to change it to the Advanced MENU, select the "Go to Advanced Menu..."
3. Use the ▲/▼ cursor buttons to select an item to operate.
4. Use the ◀/▶ cursor buttons to operate the item.



### In the Advanced MENU

2. Use the ▲/▼ cursor buttons to select a menu.  
If you want to change it to the EASY MENU, select the EASY MENU.  
Then press the ▶ cursor button on the projector or remote control, or the **ENTER** button on the remote control to select an item. The display of the selected menu will be active.
3. Use the ▲/▼ cursor buttons to select an item to operate.  
Then press the ▶ cursor button on the projector or remote control, or the **ENTER** button on the remote control to progress. The operation menu of the selected item will appear.
4. Use the ▲/▼ cursor buttons to operate the item.
  - Some functions cannot be performed when a certain input port is selected, or when a certain input signal is displayed.
  - When you want to reset the operation, press the **RESET** button on the remote control during the operation. Note that items whose functions are performed simultaneously with operation (ex. LANGUAGE, H PHASE, VOLUME etc.) cannot be reset.
  - In the Advanced MENU, when you want to return to the previous display, press the ◀ cursor button on the projector or remote control, or the **ESC** button on the remote control.
5. Press the **MENU** button on the remote control again to close the menu and complete this operation.  
Even if you do not do anything, the dialog will automatically disappear after about 10 seconds.



## EASY MENU

From the EASY MENU, items shown in the table below can be performed.

Select an item using the ▲/▼ cursor buttons on the projector or remote control. Then perform it according to the following table.

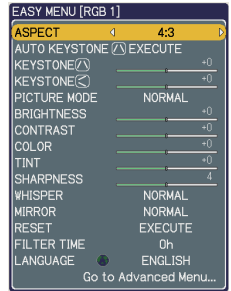

Item	Description																								
<b>ASPECT</b>	Using the ◀/▶ buttons switches the mode for aspect ratio. See the ASPECT item in IMAGE menu (📖30).																								
<b>AUTO KEYSTONE EXECUTE</b>	Using the ▶ button executes the auto keystone function. See the AUTO KEYSTONE EXECUTE item in SETUP menu (📖36).																								
<b>KEYSTONE</b>	Using the ◀/▶ buttons corrects the vertical keystone distortion. See the KEYSTONE item in SETUP menu (📖36).																								
<b>KEYSTONE</b>	Using the ◀/▶ buttons corrects the horizontal keystone distortion. See the KEYSTONE item in SETUP menu (📖37).																								
<b>PICTURE MODE</b>	<p>Using the ◀/▶ buttons switches the picture mode. The picture modes are combinations of GAMMA and COLOR TEMP settings. Choose a suitable mode according to the projected source.</p> <p style="text-align: center;"> </p> <table border="1" style="width: 100%; border-collapse: collapse;"> <thead> <tr> <th></th> <th>COLOR TEMP</th> <th>GAMMA</th> </tr> </thead> <tbody> <tr> <td>NORMAL</td> <td>#2 MID</td> <td>#1 DEFAULT</td> </tr> <tr> <td>CINEMA</td> <td>#3 LOW</td> <td>#2 DEFAULT</td> </tr> <tr> <td>DYNAMIC</td> <td>#1 HIGH</td> <td>#3 DEFAULT</td> </tr> <tr> <td>BOARD(BLACK)</td> <td>#4 Hi-BRIGHT-1</td> <td>#4 DEFAULT</td> </tr> <tr> <td>BOARD(GREEN)</td> <td>#5 Hi-BRIGHT-2</td> <td>#4 DEFAULT</td> </tr> <tr> <td>WHITEBOARD</td> <td>#2 MID</td> <td>#5 DEFAULT</td> </tr> <tr> <td>DAYTIME</td> <td>#6 Hi-BRIGHT-3</td> <td>#6 DEFAULT</td> </tr> </tbody> </table> <ul style="list-style-type: none"> <li>When the combination of GAMMA and COLOR TEMP differs from pre-assigned modes above, the display on the menu for the PICTURE MODE is “CUSTOM”. Please refer to the GAMMA and COLOR TEMP (📖27, 28) items in PICTURE menu.</li> <li>When this function is performed, a certain extra such as a line may appear.</li> </ul>		COLOR TEMP	GAMMA	NORMAL	#2 MID	#1 DEFAULT	CINEMA	#3 LOW	#2 DEFAULT	DYNAMIC	#1 HIGH	#3 DEFAULT	BOARD(BLACK)	#4 Hi-BRIGHT-1	#4 DEFAULT	BOARD(GREEN)	#5 Hi-BRIGHT-2	#4 DEFAULT	WHITEBOARD	#2 MID	#5 DEFAULT	DAYTIME	#6 Hi-BRIGHT-3	#6 DEFAULT
	COLOR TEMP	GAMMA																							
NORMAL	#2 MID	#1 DEFAULT																							
CINEMA	#3 LOW	#2 DEFAULT																							
DYNAMIC	#1 HIGH	#3 DEFAULT																							
BOARD(BLACK)	#4 Hi-BRIGHT-1	#4 DEFAULT																							
BOARD(GREEN)	#5 Hi-BRIGHT-2	#4 DEFAULT																							
WHITEBOARD	#2 MID	#5 DEFAULT																							
DAYTIME	#6 Hi-BRIGHT-3	#6 DEFAULT																							

(continued on next page)

**EASY MENU (continued)**

Item	Description
<b>BRIGHTNESS</b>	Using the ◀/▶ buttons adjusts the brightness. See the BRIGHTNESS item in PICTURE menu (📖27).
<b>CONTRAST</b>	Using the ◀/▶ buttons adjusts the contrast. See the CONTRAST item in PICTURE menu (📖27).
<b>COLOR</b>	Using the ◀/▶ buttons adjusts the strength of whole color. See the COLOR item in PICTURE menu (📖28).
<b>TINT</b>	Using the ◀/▶ buttons adjusts the tint. See the TINT item in PICTURE menu (📖28).
<b>SHARPNESS</b>	Using the ◀/▶ buttons adjusts the sharpness. See the SHARPNESS item in PICTURE menu (📖28).
<b>WHISPER</b>	Using the ◀/▶ buttons turns off/on the whisper mode. See the WHISPER item in SETUP menu (📖37).
<b>MIRROR</b>	Using the ◀/▶ buttons switches the mode for mirror status. See the MIRROR item in SETUP menu (📖37).
<b>RESET</b>	Performing this item resets all of the EASY MENU items except the FILTER TIME and LANGUAGE. A dialog is displayed for confirmation. Selecting the RESET using the ▲ button performs resetting.
<b>FILTER TIME</b>	The usage time of the air filter is shown in the menu. Performing this item resets the filter time which counts usage time of the air filter. A dialog is displayed for confirmation. Selecting the RESET using the ▲ button performs resetting. See the FILTER TIME item in OPTION menu (📖45).
<b>LANGUAGE</b>	Using the ◀/▶ buttons changes the display language. See the LANGUAGE item in SCREEN menu (📖39).
<b>Go to Advanced Menu...</b>	Select "Go to Advanced Menu..." on the menu, and press the ▶ or <b>ENTER</b> button to use the menu of PICTURE, IMAGE, INPUT, SETUP, AUDIO, SCREEN, OPTION, MIU or C.C..

PICTURE menu

From the PICTURE menu, items shown in the table below can be performed.

Select an item using the ▲/▼ cursor buttons on the projector or remote control, and press the ► cursor button on the projector or remote control, or the **ENTER** button on the remote control to execute the item. Then perform it according to the following table.

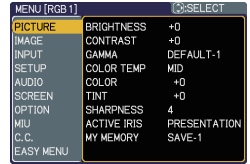



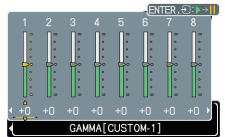

Item	Description
<b>BRIGHTNESS</b>	Using the ▲/▼ buttons adjusts the brightness. Light ⇔ Dark
<b>CONTRAST</b>	Using the ▲/▼ buttons adjusts the contrast. Strong ⇔ Weak
<b>GAMMA</b>	<p>Using the ▲/▼ buttons switches the gamma mode.</p> <p>#1 DEFAULT ⇔ #1 CUSTOM ⇔ #2 DEFAULT ⇔ #2 CUSTOM ⇔ #3 DEFAULT                      ⇕ ⇕                      #6 CUSTOM #3 CUSTOM                      ⇕ ⇕                      #6 DEFAULT ⇔ #5 CUSTOM ⇔ #5 DEFAULT ⇔ #4 CUSTOM ⇔ #4 DEFAULT</p> <p><b>To adjust CUSTOM</b></p> <p>Selecting a mode whose name includes <b>CUSTOM</b> and then pressing the ► button or the <b>ENTER</b> button displays a dialog to aid you in adjusting the mode.</p> <p>This function is useful when you want to change the brightness of particular tones.</p> <p>Choose an item using the ◀/▶ buttons, and adjust the level using the ▲/▼ buttons.</p> <p>You can display a test pattern for checking the effect of your adjustment by pressing the <b>ENTER</b> button. Each time you press the <b>ENTER</b> button, the pattern changes as below.</p> <p>No pattern ⇒ Gray scale of 9 steps ⇐</p> <p>⇑ Ramp ⇐ Gray scale of 15 steps</p> <p>The eight equalizing bars correspond to eight tone levels of the test pattern (Gray scale of 9 steps) except the darkest in the left end. If you want to adjust the 2nd tone from left end on the test pattern, use the equalizing adjustment bar "1". The darkest tone at the left end of the test pattern cannot be controlled with any of equalizing adjustment bar.</p> <ul style="list-style-type: none"> <li>• When this function is performed, lines or other distortion may appear.</li> </ul>

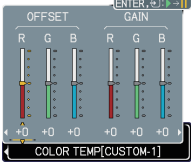

(continued on next page)

PICTURE menu (continued)

Item	Description
<p><b>COLOR TEMP</b></p>	<p>Using the ▲/▼ buttons switches the color temperature mode.</p> <pre> #1 HIGH ⇄ #1 CUSTOM ⇄ #2 MID ⇄ #2 CUSTOM ⇄ #3 LOW   ⚡ #6 CUSTOM                                     #3 CUSTOM   ⚡ #6 HI-BRIGHT-3                             #4 HI-BRIGHT-1   ⚡ #5 CUSTOM ⇄ #5 HI-BRIGHT-2 ⇄ #4 CUSTOM                     </pre> <p><b>To adjust CUSTOM</b></p> <p>Selecting a mode whose name includes CUSTOM and then pressing the ► button or the <b>ENTER</b> button displays a dialog to aid you in adjusting the OFFSET and GAIN of the selected mode.</p>  <p>OFFSET adjustments change the color intensity on the whole tones of the test pattern.</p> <p>GAIN adjustments mainly affect color intensity on the brighter tones of the test pattern.</p> <p>Choose an item using the ◀/▶ buttons, and adjust the level using the ▲/▼ buttons.</p> <p>You can display a test pattern for checking the effect of your adjustment by pressing the <b>ENTER</b> button. Each time you press the <b>ENTER</b> button, the pattern changes as below.</p> <p>No pattern ⇄ Gray scale of 9 steps </p> <p>⤴ Ramp ⇄ Gray scale of 15 steps </p> <ul style="list-style-type: none"> <li>When this function is performed, lines or other distortion may appear.</li> </ul> 
<p><b>COLOR</b></p>	<p>Using the ▲/▼ buttons adjusts the strength of whole color.</p> <p>Strong ⇄ Weak</p> <ul style="list-style-type: none"> <li>This item can be selected only for a video signal, s-video, component video or HDMI signal.</li> </ul>
<p><b>TINT</b></p>	<p>Using the ▲/▼ buttons adjusts the tint.</p> <p>Greenish ⇄ Reddish</p> <ul style="list-style-type: none"> <li>This item can be selected only for a video signal, s-video, component video or HDMI signal.</li> </ul>
<p><b>SHARPNESS</b></p>	<p>Using the ▲/▼ buttons adjusts the sharpness.</p> <p>Strong ⇄ Weak</p> <ul style="list-style-type: none"> <li>There may be some noise and/or the screen may flicker for a moment when an adjustment is made. This is not a malfunction.</li> </ul>

(continued on next page)

PICTURE menu (continued)

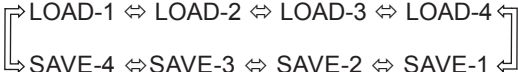



Item	Description								
<p><b>ACTIVE IRIS</b></p>	<p>Using the ▲/▼ cursor buttons changes the active iris control mode.            PRESENTATION ⇄ THEATER ⇄ TURN OFF  </p> <table border="1" data-bbox="316 336 1014 504"> <thead> <tr> <th></th> <th>Feature</th> </tr> </thead> <tbody> <tr> <td>PRESENTATION</td> <td>The active iris displays the best presentation image for both bright and dark scenes.</td> </tr> <tr> <td>THEATER</td> <td>The active iris displays the best theater image for both bright and dark scenes.</td> </tr> <tr> <td>TURN OFF</td> <td>The active iris is always open.</td> </tr> </tbody> </table> <ul style="list-style-type: none"> <li>• The screen may flicker when the PRESENTATION or THEATER modes are selected. If this occurs select TURN OFF.</li> </ul>		Feature	PRESENTATION	The active iris displays the best presentation image for both bright and dark scenes.	THEATER	The active iris displays the best theater image for both bright and dark scenes.	TURN OFF	The active iris is always open.
	Feature								
PRESENTATION	The active iris displays the best presentation image for both bright and dark scenes.								
THEATER	The active iris displays the best theater image for both bright and dark scenes.								
TURN OFF	The active iris is always open.								
<p><b>MY MEMORY</b></p>	<p>This projector has 4 memories for adjustment data (for all the items of the PICTURE menu).            Selecting a function using the ▲/▼ buttons and pressing the ► or ENTER button performs each function.</p> <p></p> <p><b><u>LOAD-1, LOAD-2, LOAD-3, LOAD-4</u></b></p> <p>Performing a LOAD function loads the data from the memory linked in the number included in the function's name, and adjusts the picture automatically depending on the data.</p> <ul style="list-style-type: none"> <li>• The LOAD functions whose linked memory has no data are skipped.</li> <li>• Remember that the current adjusted condition will be lost by loading data. If you want to keep the current adjustment, please save it before performing a LOAD function.</li> <li>• There may be some noise and the screen may flicker for a moment when loading data. This is not malfunction.</li> <li>• The LOAD functions can be also performed by the MY MEMORY button which can be set by the MY BUTTON item in OPTION menu (46).</li> </ul> <p><b><u>SAVE-1, SAVE-2, SAVE-3, SAVE-4</u></b></p> <p>Performing a SAVE function saves the current adjustment data into the memory linked in the number included in the function's name.</p> <ul style="list-style-type: none"> <li>• Remember that the current data being stored of a memory will be lost by saving a new data into the memory.</li> </ul>								

## IMAGE menu

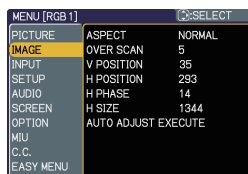
From the IMAGE menu, items shown in the table below can be performed.

Select an item using the ▲/▼ cursor buttons on the projector or remote control, and press the ► cursor button on the projector or remote control, or **ENTER** button on the remote control to execute the item. Then perform it according to the following table.



Item	Description
<b>ASPECT</b>	<p>Using the ▲/▼ buttons switches the mode for aspect ratio.</p> <p><b>For an RGB or MIU signal</b>            NORMAL ⇄ 4:3 ⇄ 16:9 ⇄ SMALL  </p> <p><b>For an HDMI signal</b>            NORMAL ⇄ 4:3 ⇄ 16:9 ⇄ 14:9 ⇄ SMALL  </p> <p><b>For a Video signal, S-video signal or Component video signal</b>            4:3 ⇄ 16:9 ⇄ 14:9 ⇄ SMALL  </p> <p><b>For no signal</b>            4:3 (fixed)</p> <ul style="list-style-type: none"> <li>• The NORMAL mode keeps the original aspect ratio of the signal.</li> </ul>
<b>OVER SCAN</b>	<p>Using the ▲/▼ buttons adjusts the over-scan ratio.</p> <p>Large (It reduces picture) ⇄ Small (It magnifies picture)</p> <ul style="list-style-type: none"> <li>• This item can be selected only for a video, s-video, component and HDMI signal.</li> <li>• When this adjustment is too large, certain degradation may appear at the frame area of the picture. In such a case, please adjust small.</li> </ul>
<b>V POSITION</b>	<p>Using the ▲/▼ buttons adjusts the vertical position.</p> <p>Up ⇄ Down</p> <ul style="list-style-type: none"> <li>• Over-adjusting the vertical position may cause noise to appear on the screen. If this occurs, please reset the vertical position to the default setting. Pressing the <b>RESET</b> button when the V POSITION is selected will reset the V POSITION to the default setting.</li> <li>• When this function is performed on a video signal, s-video signal, or component video signal of 480i@60 or 576i@50 input the range of this adjustment depends on the OVER SCAN (above) setting. It is not possible to adjust when the OVER SCAN is set to 10.</li> <li>• This item cannot be selected for an HDMI signal.</li> </ul>
<b>H POSITION</b>	<p>Using the ▲/▼ buttons adjusts the horizontal position.</p> <p>Left ⇄ Right</p> <ul style="list-style-type: none"> <li>• Over-adjusting the horizontal position may cause noise to appear on the screen. If this occurs, please reset the horizontal position to the default setting. Pressing the <b>RESET</b> button when the H POSITION is selected will reset the H POSITION to the default setting.</li> <li>• When this function is performed on a video signal, s-video signal, or component video signal of 480i@60 or 576i@50 input the range of this adjustment depends on the OVER SCAN (above) setting. It is not possible to adjust when the OVER SCAN is set to 10.</li> <li>• This item cannot be selected for an HDMI signal.</li> </ul>

(continued on next page)

**IMAGE menu (continued)**

Item	Description
<b>H PHASE</b>	<p>Using the ▲/▼ buttons adjusts the horizontal phase to eliminate flicker. Right ⇔ Left</p> <ul style="list-style-type: none"> <li>• This item can be selected only for an RGB signal or a component video signal. (except 480i@60, 576i@50, SCART RGB input. )</li> </ul>
<b>H SIZE</b>	<p>Using the ▲/▼ buttons adjusts the horizontal size. Large ⇔ Small</p> <ul style="list-style-type: none"> <li>• This item can be selected only for an RGB signal.</li> <li>• When this adjustment is excessive, the picture may not be displayed correctly. In such a case, please reset the adjustment by pressing the <b>RESET</b> button on the remote control during this operation.</li> </ul>
<b>AUTO ADJUST EXECUTE</b>	<p>Selecting this item performs the automatic adjustment feature.</p> <p><b>For an RGB signal</b> The vertical position, the horizontal position and the horizontal phase will be automatically adjusted. Make sure that the application window is set to its maximum size prior to attempting to use this feature. A dark picture may still be incorrectly adjusted. Use a bright picture when adjusting.</p> <p><b>For a video signal and s-video signal</b> The video format best suited for the respective input signal will be selected automatically. This function is available only when the AUTO is selected for the VIDEO FORMAT item in the INPUT menu (43). The vertical position and horizontal position will be automatically set to the default.</p> <p><b>For a component video signal</b> The vertical position, horizontal position and horizontal phase will be automatically set to the default.</p> <ul style="list-style-type: none"> <li>• The automatic adjustment operation requires approx. 10 seconds. Also please note that it may not function correctly with some input. When this function is performed for a video signal, a certain extra such as a line may appear outside a picture.</li> <li>• The items adjusted by this function may vary when the FINE or DISABLE is selected for the AUTO ADJUST item of the SERVICE item in the OPTION menu (47).</li> </ul>

## INPUT menu

From the INPUT menu, items shown in the table below can be performed.

Select an item using the ▲/▼ cursor buttons on the projector or remote control, and press the ► cursor button on the projector or remote control, or **ENTER** button on the remote control to execute the item. Then perform it according to the following table.

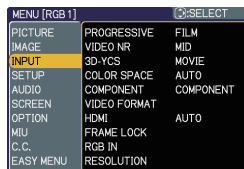



Item	Description
<b>PROGRESSIVE</b>	<p>Using the ▲/▼ buttons switches the progress mode.            TV ⇔ FILM ⇔ TURN OFF            ↑—————↑</p> <ul style="list-style-type: none"> <li>• This function is performed only for an interlaced signal at the <b>VIDEO</b> or <b>S-VIDEO</b> input, and for 480i@60, 576i@50 or 1080i@50/60 signal at the <b>COMPONENT</b> or <b>HDMI</b> input.</li> <li>• When TV or FILM is selected, the screen image will be sharp. FILM adapts to the 2-3 Pull-Down conversion system. But these may cause a certain defect (for example, jagged line) of the picture for a quick moving object. In such a case, please select TURN OFF, even though the screen image may lose the sharpness.</li> </ul>
<b>VIDEO NR</b>	<p>Using the ▲/▼ buttons switches the noise reduction mode.            HIGH ⇔ MID ⇔ LOW            ↑—————↑</p> <ul style="list-style-type: none"> <li>• This function is performed only for the <b>VIDEO</b> or <b>S-VIDEO</b> input, and for 480i@60, 576i@50 or 1080i@50/60 signal at the <b>COMPONENT</b> or <b>HDMI</b> input.</li> <li>• When this function is excessive, it may cause a certain degradation of the picture.</li> </ul>
<b>3D-YCS</b>	<p>Using the ▲/▼ buttons switches the 3D-YCS mode.            STILL ⇔ MOVIE ⇔ TURN OFF            ↑—————↑</p> <ul style="list-style-type: none"> <li>• This function performs only at a <b>VIDEO</b> input of NTSC, and PAL.</li> <li>• MOVIE is the mode for images with a lot of motions like movies, and STILL is the mode for images with few motions or completely still ones like slides.</li> </ul>
<b>COLOR SPACE</b>	<p>Using the ▲/▼ buttons switches the mode for color space.            AUTO ⇔ RGB ⇔ SMPTE240 ⇔ REC709 ⇔ REC601            ↑—————↑</p> <ul style="list-style-type: none"> <li>• This item can be selected only for an RGB signal or a component video signal (except 480i@60, 576i@50 and SCART RGB).</li> <li>• The AUTO mode automatically selects the optimum mode.</li> <li>• The AUTO operation may not work well at some signals. In such a case, it might be good to select a suitable mode except AUTO.</li> </ul>

(continued on next page)

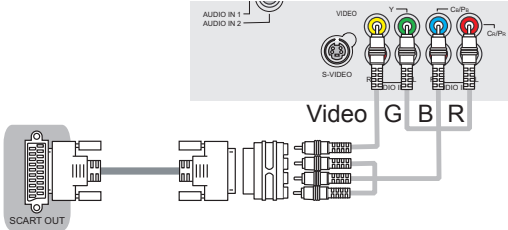

INPUT menu (continued)

Item	Description								
<p><b>COMPONENT</b></p>	<p>Using the ▲/▼ buttons switches the function of the <b>COMPONENT (Y, C<sub>B</sub>/P<sub>B</sub>, C<sub>R</sub>/P<sub>R</sub>)</b> port.  <b>COMPONENT ↔ SCART RGB</b></p> <p>When the SCART RGB is selected, the <b>COMPONENT (Y, C<sub>B</sub>/P<sub>B</sub>, C<sub>R</sub>/P<sub>R</sub>)</b> and <b>VIDEO</b> ports will function as a <b>SCART RGB</b> port. A SCART adapter or SCART cable is required for a <b>SCART RGB</b> input to the projector. For details, contact your dealer.</p> 								
<p><b>VIDEO FORMAT</b></p>	<p>Set the video format for the <b>S-VIDEO</b> port and <b>VIDEO</b> port.</p> <p>(1) Use the ◀/▶ buttons to select the input port.          (2) Using the ▲/▼ buttons switches the mode for video format.</p> <p><b>AUTO ↔ NTSC ↔ PAL ↔ SECAM</b>          ⤴ N-PAL ↔ M-PAL ↔ NTSC4.43 ⤴</p> <ul style="list-style-type: none"> <li>• This item is performed only for a video signal from the <b>VIDEO</b> port or the <b>S-VIDEO</b> port.</li> <li>• The <b>AUTO</b> mode automatically selects the optimum mode.</li> <li>• The <b>AUTO</b> operation may not work well for some signals. If the picture becomes unstable (e.g. an irregular picture, lack of color), please select the mode according to the input signal.</li> </ul> 								
<p><b>HDMI</b></p>	<p>Using the ▲/▼ cursor buttons changes the HDMI signal mode.  <b>AUTO ↔ NORMAL ↔ ENHANCED</b></p> <table border="1" data-bbox="316 1161 1014 1278"> <thead> <tr> <th></th> <th>Feature</th> </tr> </thead> <tbody> <tr> <td>AUTO</td> <td>Selecting the optimum mode automatically.</td> </tr> <tr> <td>NORMAL</td> <td>Suitable for DVD signals (16-235)</td> </tr> <tr> <td>ENHANCED</td> <td>Suitable for VGA signals (0-255)</td> </tr> </tbody> </table> <ul style="list-style-type: none"> <li>• If the contrast of the screen image is too strong or too weak, try finding a more suitable mode.</li> </ul>		Feature	AUTO	Selecting the optimum mode automatically.	NORMAL	Suitable for DVD signals (16-235)	ENHANCED	Suitable for VGA signals (0-255)
	Feature								
AUTO	Selecting the optimum mode automatically.								
NORMAL	Suitable for DVD signals (16-235)								
ENHANCED	Suitable for VGA signals (0-255)								

(continued on next page)



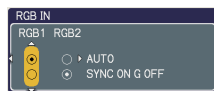

**INPUT menu (continued)**

Item	Description
<p><b>FRAME LOCK</b></p>	<p>Set the frame lock function on/off for each port.</p> <p>(1) Use the ▲/▼ buttons to select one of following ports.            QUIT ⇄ RGB1 ⇄ RGB2 ⇄ HDMI</p>  <p>(2) Use the ◀/▶ buttons to turns the frame lock function on/off .            TURN ON ⇄ TURN OFF</p> <ul style="list-style-type: none"> <li>• This item can be performed only on a signal with a vertical frequency of 50 to 60 Hz.</li> <li>• When the TURN ON is selected, moving pictures are displayed more smoothly.</li> <li>• This function may cause a certain degradation of the picture. In such a case, please select the TURN OFF.</li> </ul>
<p><b>RGB IN</b></p>	<p>Set the RGB input signal type for the <b>RGB</b> port.</p> <p>(1) Use the ◀/▶ buttons to select the <b>RGB</b> port to be set.            RGB1 ⇄ RGB2</p> <p>(2) Use the ▲/▼ buttons to select the RGB input signal type.            AUTO ⇄ SYNC ON G OFF</p> <ul style="list-style-type: none"> <li>• Selecting the AUTO mode allows you to input a sync on G signal or component signal from the port.</li> <li>• In the AUTO mode, the picture may be distorted with certain input signals. In such a case, remove the signal connector so that no signal is received and select the SYNC ON G OFF, and then reconnect the signal.</li> </ul>

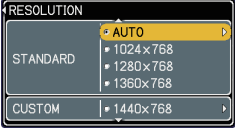

(continued on next page)

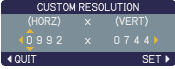
INPUT menu (continued)

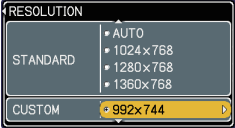

Item	Description
<p><b>RESOLUTION</b></p>	<p>The resolution for the <b>RGB1</b> and <b>RGB2</b> input signals can be set on this projector.</p> <p>(1) In the INPUT menu select the RESOLUTION using the ▲/▼ buttons and press the ► button. The RESOLUTION menu will be displayed.</p>  <p>(2) In the RESOLUTION menu select the resolution you wish to display using the ▲/▼ buttons. Selecting AUTO will set a resolution appropriate to the input signal.</p> <p>(3) Pressing the ► or <b>ENTER</b> button when selecting a STANDARD resolution will automatically adjust the horizontal and vertical positions, clock phase and horizontal size. The INPUT-INFORMATION- dialog (48) will be displayed.</p>  <p>(4) To set a custom resolution use the ▲/▼ buttons to select the CUSTOM and the CUSTOM RESOLUTION BOX will be displayed. Set the horizontal (HORZ) and vertical (VERT) resolutions using the ▲/▼/◀/▶ buttons. It is not guaranteed to work this function properly on any resolutions.</p>  <p>(5) To save the setting place the cursor on the right-most digit and press the ► button. The horizontal and vertical positions, clock phase and horizontal size will be automatically adjusted. After the INPUT-INFORMATION- dialog (48) has displayed for about 10 seconds the screen will return to the RESOLUTION menu displaying the changed resolution.</p>  <p>(6) To revert back to the previous resolution without saving changes place the cursor on the left-most digit and press the ◀ button. The screen will then return to the RESOLUTION menu displaying the previous resolution.</p>  <p>• For some pictures, this function may not work well.</p>

## SETUP menu

From the SETUP menu, items shown in the table below can be performed.

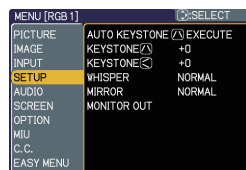
Select an item using the ▲/▼ cursor buttons on the projector or remote control, and press the ► cursor button on the projector or remote control, or the **ENTER** button on the remote control to execute the item. Then perform it according to the following table.



Item	Description
<p><b>AUTO KEYSTONE</b>  <b>EXECUTE</b></p>	<p>Selecting this item performs the Automatic keystone distortion correction. Projector automatically corrects vertical keystone distortion due to the (forward/backward) setup angle by itself.</p> <p>This function will be executed only once when selected in the menu. When the slant of the projector is changed, execute this function again.</p> <ul style="list-style-type: none"> <li>• The adjustable range of this function will vary among inputs. For some input, this function may not work well.</li> <li>• When V:INVERT or H&amp;V:INVERT is selected to the MIRROR item in the SETUP menu, if the projector screen is inclined or angled downward, this function may not work correctly.</li> <li>• When the zoom adjustment is set to the TELE (telephoto focus), this function may be excessive. This function should be used when the zoom adjustment is set to the full WIDE (wide-angle focus) whenever possible.</li> <li>• When the projector is placed on the level (about <math>\pm 3^\circ</math>), this function may not work.</li> <li>• When the projector is inclined to near <math>\pm 30</math> degree or over, this function may not work well.</li> <li>• When the vertical lens shift is not set fully upward (not set fully downward for the optional lens type FL-601 only (<a href="#">47</a>), this function may not work well.</li> <li>• When the horizontal lens shift is not set to the center, this function may not work well.</li> <li>• This function will be unavailable when the Transition Detector is on (<a href="#">52</a>).</li> </ul>
<p><b>KEYSTONE</b> </p>	<p>Using the ▲/▼ buttons corrects the vertical keystone distortion.</p> <p>Shrink the top of the image ⇔ Shrink the bottom of the image</p> <ul style="list-style-type: none"> <li>• The adjustable range of this function will vary among inputs. For some input, this function may not work well.</li> <li>• When the horizontal lens shift is not set to the center, this function may not work well.</li> <li>• This function will be unavailable when the Transition Detector is on (<a href="#">52</a>).</li> </ul>

(continued on next page)



## AUDIO menu

From the AUDIO menu, items shown in the table below can be performed.

Select an item using the ▲/▼ cursor buttons on the projector or remote control, and press the ► cursor button on the projector or remote control, or **ENTER** button on the remote control to execute the item. Then perform it according to the following table.

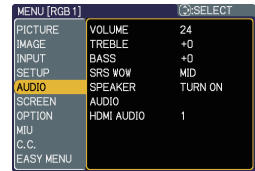

**NOTE** • The speaker sound may distorted or the case may be trembling when the volume is too high or treble/bass is emphasized or WOW is activated. In that case, make the volume reduced, bass/treble low or WOW effect to be weakend.

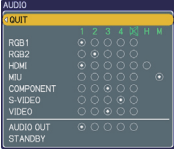
Item	Description
<b>VOLUME</b>	Using the ▲/▼ buttons adjusts the volume. High ⇄ Low
<b>TREBLE</b>	Using the ▲/▼ buttons adjusts the treble level. High ⇄ Low
<b>BASS</b>	Using the ▲/▼ buttons adjusts the bass level. High ⇄ Low
<b>SRS WOW</b> 	Using the ▲/▼ buttons switches the mode for SRS WOW mode. HIGH ⇄ MID ⇄ TURN OFF ↑ ⇄ ↓ <ul style="list-style-type: none"> <li>• SRS WOW® accomplishes this by providing a panoramic three-dimensional audio image that extends the sound field in both the horizontal and vertical planes, and lowers the perceived bass response well beyond the low frequency limitations of the drivers. Adjust it depending on the user's preference.</li> </ul>
<b>SPEAKER</b>	Using the ▲/▼ buttons turns the speaker function on/off. TURN ON ⇄ TURN OFF <ul style="list-style-type: none"> <li>• When the TURN ON is selected the built-in speaker works.</li> </ul>
<b>AUDIO</b>	Allocates the audio ports. (1) Choose a picture input port using the ▲/▼ buttons. ⇨ QUIT ⇄ RGB1 ⇄ RGB2 ⇄ HDMI ⇄ MIU ⇄ AUDIO OUT STANDBY ⇄ VIDEO ⇄ S-VIDEO ⇄ COMPONENT (2) Select the audio port to be interlocked with the input port using the ◀/▶ buttons. 1 ⇄ 2 ⇄ 3 ⇄ 4 ⇄ ✕ ⇄ H/M ↑ ⇄ ↓ <ul style="list-style-type: none"> <li>• “M” and “H” are abbreviations of MIU and HDMI.</li> <li>• M or H can be selected for MIU or <b>HDMI</b> port only.</li> <li>• When M or H is selected, the audio signal to MIU or <b>HDMI</b> port will be output if MIU or HDMI is chosen as a display source.</li> <li>• ✕ disables the audio output.</li> <li>• When ✕ is selected to <b>VIDEO</b>, <b>S-VIDEO</b> or <b>COMPONENT</b> port, the C.C. (Closed Caption) is automatically activated, if the C.C. is set to AUTO in the DISPLAY item of the C.C. menu and the signal from the input port supports the C.C. feature (64).</li> </ul> 
<b>HDMI AUDIO</b>	The HDMI AUDIO is set to 1 as default. In case the HDMI audio does not work well, try 2. 1 ⇄ 2



**SCREEN menu (continued)**

Item	Description								
<p><b>START UP</b></p>	<p>Using the ▲/▼ buttons switches the mode for the start-up screen. The start-up screen is a screen displayed when no signal or an unsuitable signal is detected.</p> <p>MyScreen ⇔ ORIGINAL ⇔ TURN OFF</p> <p>↑—————↑</p>								
	<table border="1"> <thead> <tr> <th data-bbox="318 395 535 427"></th> <th data-bbox="535 395 1016 427">Feature</th> </tr> </thead> <tbody> <tr> <td data-bbox="318 427 535 481">MyScreen</td> <td data-bbox="535 427 1016 481">Screen can be registered by the MyScreen item (41).</td> </tr> <tr> <td data-bbox="318 481 535 507">ORIGINAL</td> <td data-bbox="535 481 1016 507">Screen preset as the standard screen.</td> </tr> <tr> <td data-bbox="318 507 535 539">TURN OFF</td> <td data-bbox="535 507 1016 539">Plain black screen.</td> </tr> </tbody> </table>		Feature	MyScreen	Screen can be registered by the MyScreen item (41).	ORIGINAL	Screen preset as the standard screen.	TURN OFF	Plain black screen.
		Feature							
	MyScreen	Screen can be registered by the MyScreen item (41).							
	ORIGINAL	Screen preset as the standard screen.							
TURN OFF	Plain black screen.								
	<ul style="list-style-type: none"> <li>• To avoid remaining as an afterimage, the MyScreen or ORIGINAL screen will change to the BLANK screen (39) after several minutes. If also the BLANK screen is the MyScreen or ORIGINAL, the plain black screen is instead used.</li> <li>• When the TURN ON is selected to the MyScreen PASSWORD of SECURITY item in OPTION menu (50), the START UP is fixed to MyScreen.</li> </ul>								

(continued on next page)





## SCREEN menu (continued)

Item	Description
MyScreen	<p>This item allows you to capture an image for use as a MyScreen image which can be used as the BLANK screen and START UP screen. Display the image you want to capture before executing the following procedure.</p> <ol style="list-style-type: none"> <li>1. Selecting this item displays a dialog titled "MyScreen". It will ask you if you start capturing an image from the current screen.           <div data-bbox="833 379 1023 424" data-label="Image"> </div> <p>Please wait for the target image to be displayed, and press the <b>ENTER</b> button on the remote control when the image is displayed. The image will freeze and the frame for capturing will appear.</p> <p>To stop performing, press the <b>RESET</b> or <b>ESC</b> button on the remote control.</p> </li> <li>2. Using the <b>▲/▼/◀/▶</b> buttons adjusts the frame position.           <div data-bbox="805 627 1023 762" data-label="Image"> </div> <p>Please move the frame to the position of the image which you want to use. The frame may not be able to be moved for some input signals.</p> <p>To start registration, press the <b>ENTER</b> button on the remote control.</p> <p>To restore the screen and return to the previous dialog, press the <b>RESET</b> or <b>ESC</b> button on the remote control.</p> <p>Registration takes several minutes.</p> <p>When the registration is completed, the registered screen and the following message is displayed for several seconds:  <b>"MyScreen registration is finished."</b></p> <p>If the registration failed, the following message is displayed:  <b>"A capturing error has occurred. Please try again."</b></p> <ul style="list-style-type: none"> <li>• This item cannot be selected for an HDMI signal.</li> <li>• This function cannot be selected when the TURN ON is selected to the MyScreen Lock item (<a href="#">📖 below</a>).</li> <li>• This function cannot be selected when the TURN ON is selected to the MyScreen PASSWORD of SECURITY item in OPTION menu (<a href="#">📖 50</a>).</li> </ul> </li> </ol>
MyScreen Lock	<p>Using the <b>▲/▼</b> buttons turns on/off the MyScreen lock function.</p> <p>TURN ON ⇔ TURN OFF</p> <p>When the TURN ON is selected, the item MyScreen is locked. Use this function for protecting the current MyScreen.</p> <ul style="list-style-type: none"> <li>• This function cannot be selected when the TURN ON is selected to the MyScreen PASSWORD of SECURITY item in OPTION menu (<a href="#">📖 50</a>).</li> </ul>

(continued on next page)

**SCREEN menu (continued)**

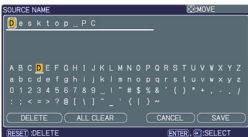
Item	Description
<p><b>MESSAGE</b></p>	<p>Using the ▲/▼ buttons turns on/off the message function.                      TURN ON ⇔ TURN OFF</p> <p>When the TURN ON is selected, the following message function works.                      “AUTO IN PROGRESS” while automatically adjusting                      “NO INPUT IS DETECTED”                      “SYNC IS OUT OF RANGE”                      “INVALID SCAN FREQ”                      “Searching....” while searching for the input                      “Detecting....” while an input signal is detected                      The indication of the input signal displayed by changing                      The indication of the aspect ratio displayed by changing                      The indication of the PICTURE MODE displayed by changing                      The indication of the ACTIVE IRIS displayed by changing                      The indication of the MY MEMORY displayed by changing                      The indication of “FREEZE” and “II” while freezing the screen by pressing the <b>FREEZE</b> button.</p> <ul style="list-style-type: none"> <li>• When the TURN OFF is selected, please remember if the picture is freezing. Do not mistake freezing for a malfunction (■22).</li> </ul>
<p><b>SOURCE NAME</b></p>	<p>Each input port for this projector can have a name applied to it.                      (1) Use the ▲/▼ buttons on the SCREEN menu to select SOURCE NAME and press the ► button. The SOURCE NAME menu will be displayed.</p>  <p>(2) Use the ▲/▼ buttons on the SOURCE NAME menu to select the port to be named and press the ► button. Right side of the menu is blank until a name is specified. The SOURCE NAME dialog will be displayed.</p>  <p>(3) The current name will be displayed on the first line. Use the ▲/▼/◀/▶ buttons and the <b>ENTER</b> or <b>INPUT</b> button to select and enter characters. The <b>RESET</b> button can be used to erase 1 character at a time. Also if you move the cursor to DELETE or ALL CLEAR on screen and push the <b>ENTER</b> or <b>INPUT</b> button, 1 character or all characters will be erased. The name can be a maximum of 16 characters.</p>  <p>(4) To change an already inserted character, press the ▲ button to move the cursor to the first line, and use the ◀/▶ buttons to move the cursor on the character to be changed. After pressing the <b>ENTER</b> or <b>INPUT</b> button, the character is selected. Then, follow the same procedure as described at the item (3) above.</p>  <p>(5) To finish entering text, move the cursor to the SAVE on screen and press the <b>ENTER</b> or <b>INPUT</b> button. To revert to the previous name without saving changes, move the cursor to the CANCEL on screen and press the <b>ENTER</b> or <b>INPUT</b> button.</p>

(continued on next page)

**SCREEN menu (continued)**

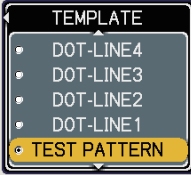
Item	Description
<b>TEMPLATE</b>	<p>Using ▲/▼ buttons switches the mode for the template screen. The selected template pattern can be displayed when the <b>MY BUTTON</b> allocated to the TEMPLATE function is pressed (46).</p> <p>↓↔ DOT-LINE4 ↔ DOT-LINE3 ↔ DOT-LINE2  TEST PATTERN ↔ DOT-LINE1←↔↑</p> 

OPTION menu

From the OPTION menu, items shown in the table below can be performed.

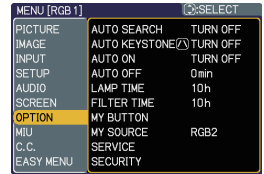

Select an item using the ▲/▼ cursor buttons on the projector or remote control, and press the ► cursor button on the projector or remote control, or **ENTER** button on the remote control to execute the item, except for the items LAMP TIME and FILTER TIME. Then perform it according to the following table.



Item	Description
<b>AUTO SEARCH</b>	<p>Using the ▲/▼ buttons turns on/off the automatic signal search function. TURN ON ⇔ TURN OFF</p> <p>When the TURN ON is selected, detecting no signal automatically cycles through input ports in the following order. The search is started from the current port. Then when an input is found, the projector will stop searching and display the image.</p> <p>RGB 1 ⇨ RGB 2 ⇨ HDMI ⇨ MIU ⇨ COMPONENT ⇨ S-VIDEO ⇨ VIDEO</p> <p>↑</p> <ul style="list-style-type: none"> <li>• The MIU input is skipped, as long as no image is sent from PC on the "Live Mode" (45).</li> </ul>
<b>AUTO KEYSTONE</b> [Z]	<p>Using the ▲/▼ buttons turns on/off the automatic keystone function. TURN ON ⇔ TURN OFF</p> <p>TURN ON : Automatic keystone distortion correction will be executed whenever changing the slant of the projector.</p> <p>TURN OFF : This function is disabled. Please execute the AUTO KEYSTONE [Z] EXECUTE in the SETUP menu for automatic keystone distortion correction.</p> <ul style="list-style-type: none"> <li>• When the projector is suspended from the ceiling this feature will not function properly so select the TURN OFF.</li> <li>• This function will be unavailable when the Transition Detector is on (45).</li> </ul>
<b>AUTO ON</b>	<p>Using the ▲/▼ buttons turns on/off the AUTO ON function. TURN ON ⇔ TURN OFF</p> <p>When set to the TURN ON, the lamp in projector will be automatically turned on without the usual procedure (17), only when the projector is supplied with the power after the power was cut while the lamp was on.</p> <ul style="list-style-type: none"> <li>• This function does not work as long as the power has been supplied to the projector while the lamp is off.</li> <li>• After turning the lamp on by the AUTO ON function, if neither input nor operation is detected for about 30 minutes, the projector is turned off, even though the AUTO OFF function (45) is disabled.</li> </ul>



(continued on next page)

## OPTION menu (continued)

Item	Description
<b>AUTO OFF</b>	<p>Using the ▲/▼ buttons adjusts the time to count down to automatically turn the projector off.            Long (max. 99 minutes) ⇔ Short (min. 0 minute = DISABLE)</p> <div style="display: flex; justify-content: space-around; align-items: center;">   </div> <p>When the time is set to 0, the projector is not turned off automatically. When the time is set to 1 to 99, and when the passed time with no-signal or an unsuitable signal reaches at the set time, the projector lamp will be turned off.            If one of the projector's buttons or the remote control buttons is pressed or one of the commands (except get commands) is transmitted to the <b>CONTROL</b> port during the corresponding time, projector will not be turned off.            Please refer to the section "Turning off the power" (17).</p>
<b>LAMP TIME</b>	<p>The lamp time is the usage time of the lamp, counted after the last resetting. It is shown in the OPTION menu.            Pressing the <b>RESET</b> button on the remote control or the ► button of the projector displays a dialog.            To reset the lamp time, select the <b>RESET</b> using the ▲ button.            RESET ⇔ CANCEL</p> <ul style="list-style-type: none"> <li>• Please reset the lamp time only when you have replaced the lamp, for a suitable indication about the lamp.</li> <li>• For the lamp replacement, see the section "Lamp" (65, 66).</li> </ul>
<b>FILTER TIME</b>	<p>The filter time is the usage time of the air filter, counted after the last resetting. It is shown in the OPTION menu.            Pressing the <b>RESET</b> button on the remote control or the ► button of the projector displays a dialog.            To reset the filter time, select the <b>RESET</b> using the ▲ button.            RESET ⇔ CANCEL</p> <ul style="list-style-type: none"> <li>• Please reset the filter time only when you have cleaned or replaced the air filter, for a suitable indication about the air filter.</li> <li>• For the air filter cleaning, see the section "Air filter" (67).</li> </ul>





(continued on next page)

OPTION menu (continued)



Item	Description
<p><b>MY BUTTON</b></p>	<p>This item is to assign one of the following function to <b>MY BUTTON 1</b> and <b>2</b> on the remote control ( 6 ).</p> <p>Choose 1 or 2 on the MY BUTTON menu using the ◀/▶ button first. Then using the ▲/▼ buttons sets one of the following functions to the chosen button.</p> <ul style="list-style-type: none"> <li>• RGB1: Sets port to <b>RGB1</b>.</li> <li>• RGB2: Sets port to <b>RGB2</b>.</li> <li>• HDMI: Sets port to <b>HDMI</b>.</li> <li>• MIU: Sets port to <b>MIU</b>.</li> <li>• COMPONENT: Sets port to <b>COMPONENT (Y, Cb/Pb, Cr/Pr)</b>.</li> <li>• S-VIDEO: Sets port to <b>S-VIDEO</b>.</li> <li>• VIDEO: Sets port to <b>VIDEO</b>.</li> <li>• INFORMATION: Displays the INPUT -INFORMATION- ( 48 ) or MIU -INFORMATION- ( 63 ) or nothing.</li> <li>• AUTO KEYSTONE □ : Performs automatic keystone distortion correction ( 36 ).</li> <li>• MY MEMORY: Loads one of adjustment data stored ( 29 ). When more than one data are saved, the adjustment changes every time the <b>MY BUTTON</b> is pushed. When no data is saved in memory, the dialog "No saved data" appears.</li> </ul> <p>When the current adjustment is not saved to memory, the dialog as shown in the right appears.</p> <p>If you want to keep the current adjustment, please press the ◀ button to quit. Otherwise loading a data will overwrite the current adjusted condition.</p> <ul style="list-style-type: none"> <li>• ACTIVE IRIS: Changes the active iris mode.</li> <li>• PICTURE MODE: Changes the PICTURE MODE ( 25 ).</li> <li>• FILTER RESET: Displays the filter time reset confirmation dialogue ( 45 ).</li> <li>• AV MUTE : Turns the picture and audio on/off.</li> <li>• TEMPLATE: Makes the template pattern selected to the TEMPLATE item ( 43 ) appear or disappear.</li> <li>• MY IMAGE: Displays the MY IMAGE menu ( 62 ).</li> <li>• LIVE MODE : Sets port to MIU and display an image on the LIVE mode. While using the LIVE mode, the LIVE MODE SETTING menu is displayed.</li> <li>• THUMBNAIL : Sets port to MIU and displays the THUMBNAIL screen.</li> <li>• SLIDE SHOW : Sets port to MIU and starts the SLIDE SHOW display.</li> <li>• DIRECTORY : Sets port to MIU and displays the DIRECTORY screen.</li> <li>• REMOVE MEDIA : Displays the REMOVE MEDIA menu.</li> </ul>
<p><b>MY SOURCE</b></p>	<p>This item is to assign an input signals to <b>MY SOURCE / DOC. CAMERA</b> button on the remote control ( 6, 19 ).</p> <p>Using the ▲/▼ buttons sets one of the following input signal.</p> <p>            RGB1 ↔ RGB2 ↔ HDMI ↔ MIU ↔ VIDEO ↔ S-VIDEO ↔ COMPONENT     </p> 
<p><b>SERVICE</b></p>	<p>Selecting this item displays the SERVICE menu.</p> <p>Select an item using the ▲/▼ buttons, and press the ▶ button or the <b>ENTER</b> button on the remote control to execute the item.</p> <p>            FANSPEED ↔ AUTO ADJUST ↔ GHOST ↔ FILTER MESSAGE ↔ LENS TYPE ↔ FACTORY RESET ↔ INFORMATION ↔ REMOTE FREQ. ↔ REMOTE RECEIV. ↔ KEY LOCK     </p>

(continued on next page)

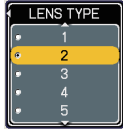
OPTION menu (continued)

Item	Description
<p><b>SERVICE (continued)</b></p>	<p><b>FANSPEED</b> Using the ▲/▼ buttons switches the rotation speed of the cooling fans. The HIGH is the mode for use at highlands etc. Note that the projector is noisier when the HIGH is selected. HIGH ⇄ NORMAL</p> 
	<p><b>AUTO ADJUST</b> Using the ▲/▼ buttons to select one of the mode. When the DISABLE is selected, the automatic adjustment feature is disabled. FINE ⇄ FAST ⇄ DISABLE</p> <p style="text-align: center;">↑ ← → ↓</p> <p>FINE: Finer tuning including H.SIZE adjustment. FAST: Faster tuning, setting H.SIZE to prearranged data for the input signal.</p> <ul style="list-style-type: none"> <li>Depending on conditions, such as input image, signal cable to the projector, environment around the projector, etc., the automatic adjustment may not work correctly. In such a case, please choose DISABLE to disable the automatic adjustment, and make adjustment manually.</li> </ul> 
	<p><b>GHOST</b></p> <ol style="list-style-type: none"> <li>Select a color element of ghost using the ◀/▶ buttons.</li> <li>Adjust the selected element using the ▲/▼ buttons to disappear ghost.</li> </ol> 
	<p><b>FILTER MESSAGE</b> Use the ▲/▼ button to set the timer for the interval to show the message for cleaning up the air filter. 500h ⇄ 1000h ⇄ 1500h ⇄ 2000h ⇄ TURN OFF After choosing an item except TURN OFF, the message "REMINDER *** HRS PASSED AFTER THE LAST FILTER CHECK" will appear after the timer reaches the interval time set by this feature (70). When the TURN OFF is chosen, the message will not appear. Utilize this feature to keep the air filter clean, setting the suitable time according to your environment of this projector.</p> <ul style="list-style-type: none"> <li>Please check and clean the air filter periodically, even if there is no message. If the air filter becomes to be blocked by dust or others, the internal temperature will rise, which could cause malfunction, or reduce the lifetime of the projector.</li> <li>Please be careful with the operating environment of the projector and the condition of the air filter.</li> <li>This setting has an influence on the keystone distortion etc.</li> <li>About the optional lens, ask you dealer.</li> </ul> 
	<p><b>LENS TYPE</b> Select the lens type currently used using the ▲/▼ buttons. 1 ⇄ 2 ⇄ 3 ⇄ 4 ⇄ 5</p> <p style="text-align: center;">↑ ← → ↓</p> <p>Please select one of them referring to the following.</p> <ol style="list-style-type: none"> <li>for a standard lens (Type NL-600)</li> <li>for a fixed short throw lens (Type FL-601)</li> <li>for a short throw lens (Type SL-602)</li> <li>for a long throw lens (Type LL-603)</li> <li>for an ultra long throw lens (Type UL-604)</li> </ol> 

OPTION menu (continued)

Item	Description
<p><b>SERVICE (continued)</b></p>	<p><b>KEY LOCK</b>                      Using the ▲/▼ buttons turns on/off the key lock feature. When TURN ON is selected, the buttons on the projector except the <b>STANDBY/ON</b> button are locked.                      TURN ON ⇔ TURN OFF</p> <ul style="list-style-type: none"> <li>• Please use to avoid a mischief and touching accidentally. This function does not have any effect on the remote control.</li> </ul> <p><b>REMOTE RECEIV.</b>                      (1) Select a remote sensor using the ▲/▼ button.                      1:FRONT ⇔ 2:TOP ⇔ 3:REAR</p>  <p>(2) Switch it using the <b>ENTER</b> or <b>INPUT</b> button.  <input type="checkbox"/> (off) ⇔ <input checked="" type="checkbox"/> (on)</p> <ul style="list-style-type: none"> <li>• A sensor cannot be turned off when the other two are off. Always at least one sensor is on.</li> </ul> <p><b>REMOTE FREQ.</b>                      Use the ▲/▼ button to change the Projector's remote sensor setting (📖15).                      1:NORMAL ⇔ 2:HIGH</p>  <p>Items with a checkmark are on. The factory default setting is for both 1:NORMAL and 2:HIGH to be on. If the remote control does not function correctly, set the this to either only 1 or only 2 as described in Remote Control Settings (📖15).                      Neither can be turned off at the same time.</p> <p><b>INFORMATION</b>                      Selecting this item displays a dialog titled “INPUT-INFORMATION-”. It shows the information about the current input.</p>  <ul style="list-style-type: none"> <li>• The “FRAME LOCK” message on the dialog means the frame lock function is working.</li> <li>• The “SCART RGB” message means the <b>COMPONENT</b> port is working as a SCART RGB input port. Please refer to the COMPONENT item in INPUT menu (📖33).</li> <li>• This item can't be selected for no signal and sync out.</li> <li>• When the MY TEXT DISPLAY is set to TURN ON, the MY TEXT is displayed together with the input information in the INPUT-INFORMATION- box (📖53).</li> </ul> <p><b>FACTORY RESET</b>                      Selecting RESET using the button ▲ performs this function. By this function, all the items in all of menus will collectively return to the initial setting. Note that the items LAMP TIME, FILTER TIME, LANGUAGE, SECURITY and MIU settings are not reset.                      RESET ⇔ CANCEL</p>

(continued on next page)





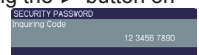
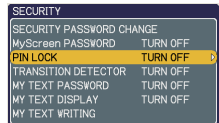

OPTION menu (continued)



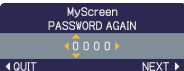

Item	Description
<p><b>SECURITY</b></p>	<p>This projector is equipped with security functions. User registration is required before using the security functions. Please contact your local dealer.</p> <p><b>1. Using Security Features</b></p> <p><b>1.1 Inputting the PASSWORD</b></p> <p>1.1-1 Use the ▲/▼ buttons on the OPTION menu to select SECURITY and press the ► button. The ENTER PASSWORD box will be displayed. The factory default PASSWORD is <b>2600</b>. This PASSWORD can be changed (1.2 Changing the PASSWORD).</p> <ul style="list-style-type: none"> <li>• It is strongly recommended the factory default PASSWORD to be changed as soon as possible.</li> </ul> <p>1.1-2 Use the ▲/▼/◀/▶ buttons to enter the registered PASSWORD. Move the cursor to the right side of the ENTER PASSWORD BOX and press the ► button to display the SECURITY menu.</p> <ul style="list-style-type: none"> <li>• If an incorrect PASSWORD is input, the ENTER PASSWORD BOX will be displayed again. If incorrect PASSWORD is input 3 times, the projector will turn off. Afterwards the projector will turn off every time an incorrect PASSWORD is input.</li> </ul> <p><b>1.2 Changing the PASSWORD</b></p> <p>1.2-1 Use the ▲/▼ buttons on the SECURITY menu to select SECURITY PASSWORD CHANGE and press the ► button to display the ENTER NEW PASSWORD BOX.</p> <p>1.2-2 Use the ▲/▼/◀/▶ buttons to enter the new PASSWORD.</p> <p>1.2-3 Move the cursor to the right side of the ENTER NEW PASSWORD BOX and press the ► button to display the NEW PASSWORD AGAIN BOX, enter the same PASSWORD again.</p> <p>1.2-4 Move the cursor to the right side of the NEW PASSWORD AGAIN BOX and press the ► button and the NOTE NEW PASSWORD BOX will be displayed for about 20 seconds, please make note of the PASSWORD during this time. Pressing the <b>ENTER</b> button on the remote control or <b>INPUT</b> button on the projector will close the NOTE NEW PASSWORD BOX.</p> <ul style="list-style-type: none"> <li>• Please do not forget your PASSWORD.</li> </ul> <p><b>1.3 If you have forgotten your PASSWORD</b></p> <p>1.3-1 Follow the procedure in 1.1-1 to display the ENTER PASSWORD BOX.</p> <p>1.3-2 While the ENTER PASSWORD BOX is displayed, press and hold the <b>RESET</b> button on the remote control for about 3 seconds or press and hold the <b>INPUT</b> button for 3 seconds while pressing the ► button on the projector.</p> <p>The 10 digit Inquiring Code will be displayed.</p> <ul style="list-style-type: none"> <li>• If there is no key input for about 55 seconds while the Inquiring Code is displayed, the menu will close. If necessary, repeat the process from 1.3-1.</li> </ul> <p>1.3-3 Contact your dealer with the 10 digit Inquiring Code. Your PASSWORD will be sent after your user registration information is confirmed.</p>

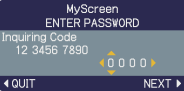

OPTION menu (continued)





Item	Description
<p><b>SECURITY (continued)</b></p>	<p><b>2. Using the MyScreen PASSWORD Function</b>                      The MyScreen PASSWORD function can be used to prohibit access to the MyScreen function and prevent the currently registered MyScreen image from being overwritten.</p> <p><b>2.1 Turning on the MyScreen PASSWORD Function</b></p> <p>2.1-1 Use the ▲/▼ buttons on the SECURITY menu to select MyScreen PASSWORD and press the ► button to display the MyScreen PASSWORD on/off menu.</p>  <p><b>2.2 Setting the PASSWORD</b></p> <p>2.2-1 Display the MyScreen on/off menu using the procedure in 2.1-1.</p> <p>2.2-2 Use the ▲/▼ buttons on the MyScreen PASSWORD on/off menu to select TURN ON. The ENTER PASSWORD BOX (small) will be displayed.</p>  <p>ENTER PASSWORD BOX (small)</p> <p>2.2-3 Use the ▲/▼/◀/▶ buttons to enter the PASSWORD. Move the cursor to the right side of the ENTER PASSWORD BOX (small) and press the ► button to display the PASSWORD AGAIN BOX, enter the same PASSWORD again.</p>  <p>2.2-4 Move the cursor to the right side of the PASSWORD AGAIN BOX and press the ► button to display the PASSWORD for about 20 seconds, please make note of the PASSWORD during this time.</p>  <p>Pressing the <b>ENTER</b> button on the remote control or <b>INPUT</b> button on the projector will return to MyScreen PASS WORD on/off menu.                      When a PASSWORD is set for MyScreen:</p> <ul style="list-style-type: none"> <li>• The MyScreen registration function (and menu) will be unavailable.</li> <li>• The MyScreen Lock menu will be unavailable.</li> <li>• The START UP setting will be locked on MyScreen (and the menu will be unavailable).</li> </ul> <p>Turning the MyScreen PASSWORD off will allow normal operation of these functions.</p> <ul style="list-style-type: none"> <li>• Please do not forget your MyScreen PASSWORD.</li> </ul> <p><b>2.3 Turning the PASSWORD off</b></p> <p>2.3-1 Follow the procedure in 2.1-1 to display the MyScreen PASSWORD on/off menu.</p> <p>2.3-2 Select TURN OFF to display the ENTER PASSWORD BOX (large). Enter the registered PASSWORD and the screen will return to the MyScreen on/off menu.</p> <p>If an incorrect PASSWORD is input, the menu will close. If necessary, repeat the process from 2.3-1.</p> <p><b>2.4 If you have forgotten your PASSWORD</b></p> <p>2.4-1 Follow the procedure in 2.1-1 to display the MyScreen PASSWORD on/off menu.</p> <p>2.4-2 Select TURN OFF to display the ENTER PASSWORD BOX (large). The 10 digit Inquiring Code will be displayed inside the BOX.</p>  <p>2.4-3 Contact your dealer with the 10 digit Inquiring Code. Your PASSWORD will be sent after your user registration information is confirmed.</p> <p>ENTER PASSWORD BOX (large)</p>

**OPTION menu (continued)**

Item	Description
<p><b>SECURITY (continued)</b></p>	<p><b>3. Using the PIN LOCK Function</b>                      PIN LOCK is a function which prevents the projector from being used unless a registered Code is input.</p> <p><b>3.1 Registering the PIN Code</b></p> <p>3.1-1 Use the ▲/▼ buttons on the SECURITY menu to select PIN LOCK and press the ► button or the <b>ENTER</b> button to display the PIN LOCK on/off menu.</p>  <p>3.1-2 Use the ▲/▼ buttons on the PIN LOCK on/off menu to select TURN ON and the PIN BOX will be displayed.</p>  <p>3.1-3 Input a 4 part PIN Code using the ▲/▼/◀/▶, <b>RGB</b> and <b>INPUT</b> buttons. The PIN CODE AGAIN BOX will appear. Reenter the same PIN Code. This will complete the PIN Code registration.</p>  <ul style="list-style-type: none"> <li>• If there is no key input for about 55 seconds while the PIN BOX or the PIN CODE AGAIN BOX is displayed, the menu will close. If necessary, repeat the process from 3.1-1.</li> </ul> <p>Afterwards, anytime the projector is restarted after the power switch is turned off the PIN BOX will be displayed. Enter the registered PIN Code. The projector can be used after entering the registered PIN Code. If an incorrect PIN Code is input, the PIN BOX will be displayed again. If an incorrect PIN Code is input 3 times, the projector will turn off. Afterwards the projector will turn off every time an incorrect PIN Code is input. The projector will also turn off if there is no key input for about 5 minutes while the PIN BOX is displayed. This function will activate only when the projector is started after the power switch was turned off.</p> <ul style="list-style-type: none"> <li>• Please do not forget your PIN Code.</li> </ul> <p><b>3.2 Turning Off the PIN LOCK Function</b></p> <p>3.2-1 Follow the procedure in 3.1-1 to display the PIN LOCK on/off menu. Use the ▲/▼ buttons to select TURN OFF and the PIN BOX will be displayed. Enter the registered PIN Code to turn the PIN LOCK function off. If an incorrect PASSWORD is input 3 times, the menu will close.</p> <p><b>3.3 If you have forgotten your PIN Code</b></p> <p>3.3-1 While the PIN BOX is displayed, press and hold the <b>RESET</b> button for three seconds or press and hold the <b>INPUT</b> button for 3 seconds while pressing the ► button on the projector. The 10 digit Inquiring Code will be displayed.</p>  <ul style="list-style-type: none"> <li>• If there is no key input for about 5 minutes while the Inquiring Code is displayed, the projector will turn off.</li> </ul> <p>3.3-2 Contact your dealer with the 10 digit Inquiring Code. Your PASSWORD will be sent after your user registration information is confirmed.</p>

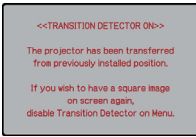
(continued on next page)

OPTION menu (continued)



Item	Description
<p><b>SECURITY (continued)</b></p>	<p><b>4. Using the Transition Detector Function</b>                      While the Transition Detector function is ON, when power switch is started to supply to the projector, it might react as below.</p> <ul style="list-style-type: none"> <li>• Transition Detector alarm shown below might appear on screen, if the projector has been moved or re-installed.</li> <li>• Transition Detector alarm might appear on screen, if the MIRROR setting has been changed.</li> <li>• Keystone adjustment feature has been prohibited as long as the Transition Detector function is ON.</li> </ul> <p><b>4.1 Turning On the Transition Detector Function</b></p> <p>4.1-1 Use the ▲/▼ buttons on the SECURITY menu to select Transition Detector and press the ► or the <b>ENTER</b> button to display the Transition Detector on/off menu. Select <b>TURN ON</b> and the current angle and mirror setting will be recorded.</p> <ul style="list-style-type: none"> <li>• This feature may not function properly if the projector is not in a stable position when <b>TURN ON</b> is selected.</li> </ul> <p>4.1-2 If this function is set to <b>TURN ON</b> when the vertical angle of the projector or mirror setting at which the projector is turned on is different than the previously recorded, the Transition Detector Alarm will be displayed and the projector will not display the input signal.</p> <p>Set the Transition Detector off in the SECURITY menu to display the input signal. If the Transition Detector ALARM is displayed for about 5 minutes, the lamp will turn off. This function will activate only when the projector is started after the power switch was turned off.</p> <p><b>4.2 Setting the Transition Detector PASSWORD</b></p> <p>4.2-1 Use the ▲/▼ buttons on the SECURITY menu to select Transition Detector and press the ► or the <b>ENTER</b> button to display the Transition Detector on/off menu.</p> <p>4.2-2 Use the ▲/▼ buttons on the Transition Detector on/off menu to select <b>TURN ON</b>. The <b>ENTER PASSWORD BOX (small)</b> will be displayed.</p> <p>4.2-3 Use the ▲/▼/◀/▶ buttons to enter a <b>PASSWORD</b>. Move the cursor to the right side of the <b>ENTER PASSWORD BOX (small)</b> and press the ► button to display the <b>PASSWORD AGAIN BOX</b>, enter the same <b>PASSWORD</b> again.</p> <p>4.2-4 Move the cursor to the right side of the <b>PASSWORD AGAIN BOX</b> and press the ► button to display the <b>PASSWORD</b> for about 20 seconds, please make note of the <b>PASSWORD</b> during this time.</p> <p>Pressing the <b>ENTER</b> button on the remote control or the <b>INPUT</b> button on the projector will return to the Transition Detector on/off menu.</p> <ul style="list-style-type: none"> <li>• Please do not forget your Transition Detector <b>PASSWORD</b>.</li> </ul> <p><b>4.3 Setting the Transition Detector off</b></p> <p>4.3-1 Follow the procedure in 4.1-1 to display the Transition Detector on/off menu.</p> <p>4.3-2 Select <b>TURN OFF</b> to display the <b>ENTER PASSWORD BOX (large)</b>. Enter the registered <b>PASSWORD</b> and the screen will return to the Transition Detector on/off menu.</p> <p>If an incorrect <b>PASSWORD</b> is input, the menu will close. If necessary, repeat the process from 4.3-1.</p>
	   <p>ENTER PASSWORD BOX (small)</p>  

OPTION menu (continued)

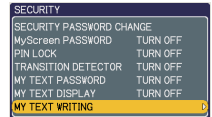
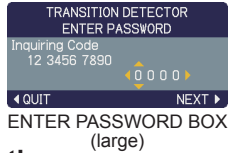
Item	Description
<p><b>SECURITY</b> (continued)</p>	<p><b>4.4 If you have forgotten your PASSWORD</b></p> <p>4.4-1 Follow the procedure in 4.1-1 to display the Transition Detector on/off menu.</p> <p>4.4-2 Select TURN OFF to display the ENTER PASSWORD BOX (large). The 10 digit Inquiring Code will be displayed inside the BOX.</p> <p>4.4-3 Contact your dealer with the 10 digit Inquiring Code. Your PASSWORD will be sent after your user registration information is confirmed.</p>
	<p><b>5. Using the MY TEXT PASSWORD function</b></p> <p>This item allows you to display your own message (MY TEXT) on the START UP screen and INPUT-INFORMATION-. It can be protected by a password to prevent it from being overwritten.</p>
	<p><b>5.1 Writing the MY TEXT</b></p> <p>(1) Use the ▲/▼ buttons on the SECURITY menu to select the MY TEXT WRITING menu and press the ► button. The MY TEXT WRITING dialog will be displayed.</p>
	<p>(2) The current MY TEXT will be displayed on the first 3 lines. If not yet written, the lines will be blank.</p> <p>Use the ▲/▼/◀/▶ buttons and the ENTER or INPUT button to select and enter characters. The RESET button can be used to erase 1 character at a time. Also if you move the cursor to DELETE or ALL CLEAR on screen and push the ENTER or INPUT button, 1 character or all characters will be erased. The MY TEXT can be input up to 24 characters on each line.</p>
	<p>(3) To change an already inserted character, press the ▲/▼ button to move the cursor to one of the first 3 lines, and use the ◀/▶ buttons to move the cursor on the character to be changed. After pressing the ENTER or INPUT button, the character is selected. Then, follow the same procedure as described at the item (2) above.</p> <p>(4) To finish entering text, move the cursor to the SAVE on screen and press the ENTER or INPUT button. To revert to the previous MY TEXT without saving changes, move the cursor to the CANCEL on screen and press the ENTER or INPUT button.</p>
<p>• The MY TEXT WRITING function is available only when the MY TEXT PASSWORD function is set to TURN OFF.</p>	
<p><b>5.2 Displaying the MY TEXT</b></p> <p>(1) Use the ▲/▼ buttons on the SECURITY menu to select the MY TEXT DISPLAY menu and press the ► button to display the MY TEXT DISPLAY on/off menu.</p> <p>(2) Use the ▲/▼ buttons on the MY TEXT DISPLAY on/off menu to select on or off.</p> <p>TURN ON ⇔ TURN OFF</p>	
<p>When it is set TURN ON, the MY TEXT will be displayed on the START UP screen and the INPUT-INFORMATION- when the INFORMATION on the SERVICE menu is chosen.</p> <p>• This function is available only when the MY TEXT PASSWORD function is set to the TURN OFF.</p>	

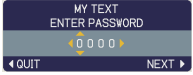
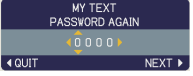

OPTION menu (continued)

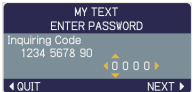
Item	Description
<p><b>SECURITY</b> (continued)</p>	<p><b>5.3 Turning on the MY TEXT PASSWORD</b> The MY TEXT PASSWORD function can prevent the MY TEXT from being overwritten.</p> <p><b>5.3-1 Turning on the MY TEXT PASSWORD function</b> (1) Use the ▲/▼ buttons on the SECURITY menu to select the MY TEXT PASSWORD menu and press the ► button to display the MY TEXT PASSWORD on/off menu.</p>  <p><b>5.3-2 Setting the MY TEXT PASSWORD</b> (1) Display the MY TEXT PASSWORD on/off menu using the procedure in 5.3-1</p> <p>(2) Use the ▲/▼ buttons on the MY TEXT PASSWORD menu to select TURN ON. The ENTER PASSWORD BOX (small) will be displayed.</p>  <p><b>ENTER PASSWORD BOX (small)</b></p> <p>(3) Use the ▲/▼/◀/▶ buttons to enter the PASSWORD. Move the cursor to the right side of the ENTER PASSWORD BOX (small) and press the ► button to display the PASSWORD AGAIN BOX, and then enter the same PASSWORD again.</p>  <p><b>ENTER PASSWORD BOX (small)</b></p> <p>(4) Move the cursor to the right side of the PASSWORD AGAIN BOX and press ► button to display the PASSWORD for about 20 seconds, then please make note of the PASSWORD during this time.</p>  <p>Pressing the <b>ENTER</b> button on the remote control or <b>INPUT</b> button on the projector will return to the MY TEXT PASSWORD on/off menu. When the PASSWORD is set for the MY TEXT;</p> <ul style="list-style-type: none"> <li>• The MY TEXT DISPLAY menu will be unavailable, which can prohibit changing the DISPLAY setting.</li> <li>• The MY TEXT WRITING menu will be unavailable, which can prevent the MY TEXT from being overwritten.</li> </ul> <p><b>5.3-3 Turning the MY TEXT PASSWORD off</b> (1) Follow the procedure in 5.3-1 to display the MY TEXT PASSWORD on/off menu.</p> <p>(2) Select TURN OFF to display the ENTER PASSWORD BOX (large). Enter the registered PASSWORD and the screen will return to the MY TEXT PASSWORD on/off menu.</p>  <p><b>ENTER PASSWORD BOX (large)</b></p> <p>If an incorrect PASSWORD is input, the menu will close. If necessary, repeat the process from 5.3-3(1)</p> <p><b>5.3.4 If you have forgotten your PASSWORD.</b> (1) Follow the procedure in 5.3-1 to display the MY TEXT PASSWORD on/off menu.</p> <p>(2) Select TURN OFF to display the ENTER PASSWORD BOX (large). The 10 digit inquiring code will be displayed inside the box.</p> <p>(3) Contact your dealer with the 10 digit inquiring code. Your PASSWORD will be sent after your user registration information is confirmed.</p>

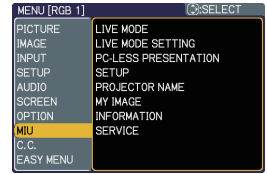

## MIU menu

The MIU (Multi Information processing Unit) is a function to support the Network features and PC-LESS Presentation. Consult with your network administrator before connecting to an existing access point on your network. Incorrect network settings on this projector may cause trouble on the network. Select “MIU” from the main menu to access the following functions.





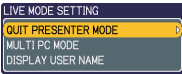

Select an item using the ▲/▼ cursor buttons on the projector or remote control, and press the ► cursor button on the projector or remote control, or **ENTER** button on the remote control to execute the item. Then perform it according to the following table. See the User’s Manual - Network Guide for details of MIU operation.

**NOTE** • The factory default setting for DHCP is TURN OFF. If your network has DHCP enabled, and needs to set IP ADDRESS, SUBNET MASK and DEFAULT GATEWAY automatically, please set DHCP to TURN ON (📖58).  
 • If you are not utilizing SNTP (📖Date/Time Settings of the User’s Manual - Network Guide), then you must set the DATE AND TIME (📖59) during the initial installation.

Item	Description	
<b>LIVE MODE</b>	Selecting this item sets the projector onto the “Live Mode”. On the “Live Mode”, the projector displays the images from the PC via Network, supported by “Live Viewer 3” software. <b>(Live Mode of the User’s Manual - Network Guide 📖5)</b>	
<b>LIVE MODE SETTING</b>		Selecting this item displays the LIVE MODE SETTING menu. Use the ▲/▼ buttons to select an item, and the ► or <b>ENTER</b> button to perform the item. 
	<b>QUIT PRESENTER MODE</b>	The Presenter Mode that is set in the "Live Viewer 3" software installed into your PC can be turned off. A message, QUIT PRESENTER MODE, will be displayed in about 3 seconds when the function is performed. The function is available only when the Presenter Mode is set to on in the the "Live Viewer 3" software. The current setting of the Presenter Mode is shown in the menu. <ul style="list-style-type: none"> <li>• The Presenter mode is a function that allows the projector to display an image sent by 1 PC only, even though the MIU feature on this projector support Multi PC mode.</li> <li>• If the projector is required to display an image sent by other PC, execute the QUIT PRESENTER MODE function.</li> <li>• See the 📖User’s Manual – Network Guide for details.</li> </ul> 

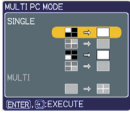
(continued on next page)





MIU menu (continued)

Item	Description									
<p><b>LIVE MODE SETTING (continued)</b></p>	<p>The projector supports the Single PC mode that displays an image on full screen sent by 1 PC, and the Multi PC mode that divides the screen into 4 zone and displays images in each zone sent by up to 4 PCs. The MULTI PC MODE function switches these modes.</p>  <p><b>SINGLE</b> Use the ▲/▼ buttons to select an item, and the <b>ENTER</b> or <b>INPUT</b> button to perform the item. The mode will be switched from the Multi PC mode to the Single PC mode and the quarter screen identified in the menu will be displayed on full screen.</p> <p><b>MULTI PC MODE</b></p> <p><b>MULTI</b> Use the <b>ENTER</b> or <b>INPUT</b> button to perform the item. The mode will be switched to the Multi PC mode and the screen will be divided to 4 zones.</p> <ul style="list-style-type: none"> <li>• If the Presenter Mode is set to on in the PC whose image is currently displayed on screen, a message, QUIT PRESENTER MODE, will be displayed in about 3 seconds when the function is performed.</li> <li>• The function is available when there is any PC connected to the projector in the Multi PC mode set in the "Live Viewer 3" software.</li> </ul>									
	<p>Selecting this item displays the Display User Name defined in the "Live Viewer 3" software in the PC whose image is on screen.</p> <p><b>SINGLE PC mode</b></p>  <p>The Display User Name will be shown in the DISPLAY USER NAME box.</p> <p>Examples</p> <table border="0"> <tr> <td>Display User name</td> <td>Shown in the DISPLAY USER NAME box</td> </tr> <tr> <td>PC_NAME0001</td> <td>PC_NAME0001</td> </tr> <tr> <td>(remained as default)</td> <td>Unnamed</td> </tr> <tr> <td>(blank space)</td> <td>(Anonymous)</td> </tr> <tr> <td>(prohibited showing)</td> <td></td> </tr> </table> <p>If there is no PC in the Single PC mode connected to the projector, the DISPLAY USER NAME box is shown as right.</p>  <p><b>MULTI PC mode</b></p>  <p>The Display User Names will be shown in the DISPLAY USER NAME box.</p> <ul style="list-style-type: none"> <li>• See the  User's Manual – Network Guide for details of the Display User Name setting.</li> </ul>	Display User name	Shown in the DISPLAY USER NAME box	PC_NAME0001	PC_NAME0001	(remained as default)	Unnamed	(blank space)	(Anonymous)	(prohibited showing)
Display User name	Shown in the DISPLAY USER NAME box									
PC_NAME0001	PC_NAME0001									
(remained as default)	Unnamed									
(blank space)	(Anonymous)									
(prohibited showing)										

(continued on next page)

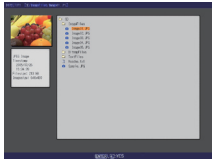





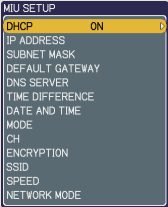

MIU menu (continued)

Item	Description		
<p><b>PC-LESS PRESENTATION</b></p>	<p>Selecting this item displays the PC-LESS PRESENTATION menu. Using the menu is able to make the projector display the images stored in an SD memory card or a USB memory, and realizes a presentation without a PC.</p> <p>Use the ▲/▼/◀/▶ buttons to select an item, and the ► or ENTER button to perform the item.</p> <ul style="list-style-type: none"> <li>• While displaying the image, to press the MENU button displays the PC-LESS PRESENTATION menu.</li> </ul>		
	<p><b>THUMBNAIL</b></p>	<p>Use the ▲/▼/◀/▶ buttons to select an image, and press the ENTER or INPUT button to display the image.</p>	
	<p><b>SLIDE SHOW</b></p>	<p>Slide show will start when you press the ENTER or ► button.</p>	
	<p><b>DIRECTORY</b></p>	<p>Use the ▲/▼ buttons to select an image or a folder, and press the ENTER or INPUT button to display the image or turn into the THUMBNAIL.</p> <p>To open or close the folder, press the ►/◀ buttons.</p>	
	<p><b>DISPLAY SIZE</b></p>	<p>Use the ▲/▼ buttons to set the display size.</p>	
	<p><b>KEY CONFIG.</b></p>	<p>Use the ▲/▼ buttons to select key configuration from the 2 patterns.</p>	
	<p><b>REMOVE MEDIA</b></p>	<p>Use the ▲/▼ buttons to select a remove mode, and then the ENTER or ► button is pressed so the menu to excuse will appear.</p>	
	<ul style="list-style-type: none"> <li>• Also these items can be set with Web Remote Control (Refer to Network Guide) except DISPLAY SIZE, KEY CONFIG. and REMOVE MEDIA.</li> </ul>		





(continued on next page)

MIU menu (continued)

Item	Description	
<b>SETUP</b>	<p>Selecting this item displays the MIU SETUP menu. Use the ▲/▼ buttons to select an item, and the ► or ENTER button on the remote control to perform the item.</p> 	
	<p style="text-align: center;"><b>DHCP (Dynamic Host Configuration Protocol)</b></p>	<p>Use the ▲/▼ buttons to turn DHCP on/off. ON ⇔ OFF</p>  <p>Select OFF when the network does not have DHCP enabled.</p> <ul style="list-style-type: none"> <li>• When the “DHCP” setting changes to “ON”, it takes a little time to obtain IP address from DHCP server.</li> <li>• Auto IP function will be assigned an IP address if the projector could not obtain an IP address from server even if DHCP is “ON”.</li> </ul>
	<p style="text-align: center;"><b>IP ADDRESS</b></p>	<p>Use the ▲/▼/◀/▶ buttons to enter the IP ADDRESS. This function can only be used when DHCP is set to OFF.</p>  <ul style="list-style-type: none"> <li>• The IP ADDRESS is the number that identifies this projector on the network. You cannot have two devices with the same IP ADDRESS on the same network.</li> <li>• The IP ADDRESS “0.0.0.0” is prohibited.</li> </ul>
	<p style="text-align: center;"><b>SUBNET MASK</b></p>	<p>Use the ▲/▼/◀/▶ buttons to enter the same SUBNET MASK used by your PC. This function can only be used when DHCP is set to OFF.</p>  <ul style="list-style-type: none"> <li>• The SUBNET MASK “0.0.0.0” is prohibited.</li> </ul>
	<p style="text-align: center;"><b>DEFAULT GATEWAY</b></p>	<p>Use the ▲/▼/◀/▶ buttons to enter the DEFAULT GATEWAY (a node on a computer network that serves as an access point to another network) address. This function can only be used when DHCP is set to OFF.</p> 
	<p style="text-align: center;"><b>DNS SERVER</b></p>	<p>Use the ▲/▼/◀/▶ buttons to input the DNS server address. The DNS server is a system to control domain names and IP addresses on the Network.</p> 

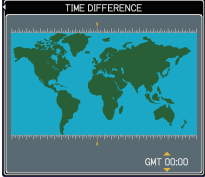

(continued on next page)

MIU menu (continued)

Item	Description	
<p><b>SETUP</b> (continued)</p>	<p><b>TIME DIFFERENCE</b></p>	<p>Use the ▲/▼ buttons to enter the TIME DIFFERENCE. Set the same TIME DIFFERENCE as the one set on your PC. If unsure, consult your IT manager. Use the ◀ button to return to the menu after setting the TIME DIFFERENCE.</p> 
	<p><b>DATE AND TIME</b></p>	<p>Use the ▲/▼/◀/▶ buttons to enter the Year (last two digits), Month, Date, Hour and Minute.</p>  <ul style="list-style-type: none"> <li>The projector will override this setting and retrieve DATE AND TIME information from the Time server when SNTP is enabled.</li> </ul> <p><a href="#">(Date/Time Settings of the User's Manual - Network Guide)</a></p>
	<p><b>MODE</b></p>	<p>Use the ▲/▼ buttons to select the mode of the network communication system. Select it according to the setting of your PC.</p>  <p>ADHOC ⇔ INFRASTRUCTURE</p>
	<p><b>CH</b></p>	<p>Use the ▲/▼ buttons to select the channel of the wireless LAN while using it. Select it according to the setting of your PC. The channels 1 to 11 are available.</p>  <ul style="list-style-type: none"> <li>The available channels would be various depending on a country. In addition, wireless network card might be required due to the standard.</li> </ul>
	<p><b>ENCRYPTION</b></p>	<p>Use the ▲/▼ buttons to select the encryption method to be used.</p>  <p>WPA2-PSK(AES) ⇔ WPA-PSK(AES) ⇔ WPA-PSK(TKIP) ⇔ WEP 128bit ⇔ WEP 64bit ⇔ OFF</p>

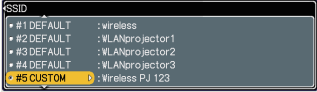

(continued on next page)

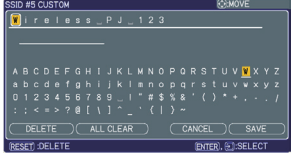
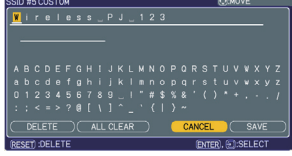
MIU menu (continued)

Item	Description
<p>SETUP (continued)</p>	<p>SSID</p> <p>Use the ▲/▼ buttons to select the SSID to display the SSID menu.</p>  <p><b>DEFAULT</b> Pressing the ► or ENTER button when one of the DEFAULT (#1~#4) is selected.</p> <p><b>CUSTOM</b> Press the ► or ENTER button when the # 5 CUSTOM is selected. The SSID #5 CUSTOM menu will be appeared.</p> <p>(1) The current SSID will be displayed on the first line. If not yet written, the line will be blank. Use the ▲/▼/◀/► buttons and the ENTER or INPUT button to select and enter characters. The RESET button can be used to erase 1 character at a time. Also if you move the cursor to DELETE or ALL CLEAR on screen and push the ENTER or INPUT button, 1 character or all characters will be erased. The SSID can be input up to 32 characters.</p>  <p>(2) To change an already inserted character, press the ▲/▼ button to move the cursor to one of the first 2 lines, and use the ◀/► buttons to move the cursor on the character to be changed. After pressing the ENTER or INPUT button, the character is selected. Then, follow the same procedure as described at the item (1) above.</p>   <p>(3) To finish entering text, move the cursor to the SAVE on screen and press the ENTER or INPUT button. To revert to the previous SSID without saving changes, move the cursor to the CANCEL on screen and press the ENTER or INPUT button.</p>

(continued on next page)

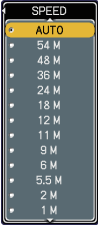
MIU menu (continued)

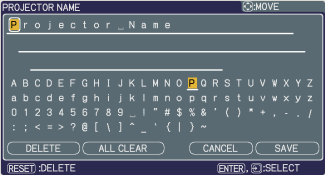
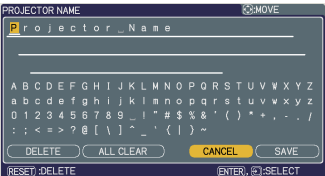
Item	Description	
<p><b>SETUP</b> (continued)</p>	<p><b>SPEED</b></p>	<p>Use the ▲/▼ buttons to select the transfer rate. (M : Mbps : Megabits per second)</p> <p>AUTO ⇄ 54M ⇄ 48M ⇄ 36M ⇄ 24M ⇄ 18M                      ⇕                      1M ⇄ 2M ⇄ 5.5M ⇄ 6M ⇄ 9M ⇄ 11M ⇄ 12M</p> <ul style="list-style-type: none"> <li>• The AUTO mode automatically selects the optimum rate.</li> <li>• Transfer rates may change due to the network situation.</li> </ul> 
	<p><b>NETWORK MODE</b></p>	<p>Use the ▲/▼ buttons to select the network mode.</p> <p>WIRELESS ⇄ WIRED</p>  <ul style="list-style-type: none"> <li>• The network mode will be initialized whenever the power is turned on with the power switch.</li> <li>• The WIRELESS will be enabled when the wireless network card is inserted.</li> <li>• The WIRED will be enabled when the wireless network card is not inserted.</li> </ul>
<p><b>PROJECTOR NAME</b></p>	<ol style="list-style-type: none"> <li>(1) Use the ▲/▼ buttons on the MIU menu to select the PROJECTOR NAME menu and press the ► button. The PROJECTOR NAME dialog will be displayed.</li> <li>(2) The current PROJECTOR NAME will be displayed on the first 3 lines. If not yet written, the lines will be blank. Use the ▲/▼/◀/▶ buttons and the ENTER or INPUT button to select and enter characters. The RESET button can be used to erase 1 character at a time. Also if you move the cursor to DELETE or ALL CLEAR on screen and push the ENTER or INPUT button, 1 character or all characters will be erased. The PROJECTOR NAME can be input up to 64 characters.</li> <li>(3) To change an already inserted character, press the ▲/▼ button to move the cursor to one of the first 3 lines, and use the ◀/▶ buttons to move the cursor on the character to be changed. After pressing the ENTER or INPUT button, the character is selected. Then, follow the same procedure as described at the item (2) above.</li> <li>(4) To finish entering text, move the cursor to the SAVE on screen and press the ENTER or INPUT button. To revert to the previous PROJECTOR NAME without saving changes, move the cursor to the CANCEL on screen and press the ENTER or INPUT button.</li> </ol>   	

(continued on next page)



**MIU menu (continued)**

Item	Description
<p><b>MY IMAGE</b></p>	<p>Selecting this item displays the MY IMAGE menu.</p> <p>Insert the SD memory card or USB memory into the projector before you use the MY IMAGE function (12). The application software “PJTransfer” is required to store image(s) into the projector.</p> <p>Use the ▲/▼ buttons to select an item which is a still image by the MY IMAGE (MY IMAGE (Still Image Transfer) Display of the User’s Manual - Network Guide) and the ► or ENTER button to display the image.</p> <ul style="list-style-type: none"> <li>• The item without image stored cannot be selected.</li> <li>• The image names are each displayed in 16 characters or less.</li> </ul> <p><b>To switch the image displayed</b></p> <p>Use the ▲/▼ buttons.</p> <p><b>To return to the menu</b></p> <p>Press the ◀ or ESC button on the remote control.</p> <p><b>To erase the image displayed and its source file in the SD memory card or USB memory</b></p> <p>(1) Press the RESET button on the remote control while displaying an image to display the MY IMAGE - RESET menu.</p> <p>(2) Press the ENTER button on the remote control or the INPUT button on the projector to perform to erase. To stop erasing, press the ESC button on the remote control or the ◀ button on the projector.</p>

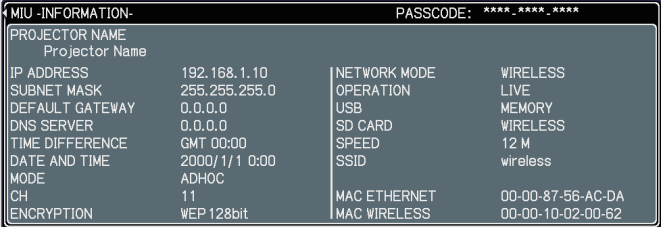

(continued on next page)

MIU menu (continued)

Item	Description
<p><b>INFORMATION</b></p>	<p>Selecting this item displays the MIU-INFORMATION- dialog for confirming the network settings.</p>  <ul style="list-style-type: none"> <li>• The PROJECTOR NAME is displayed.</li> <li>• Nothing (blank) is shown in the "PROJECTOR NAME" and "SSID" field until you setup those items. (M63, 64)</li> <li>• When the voltage level of the battery for the built in clock decreases, the set time may become incorrect even though accurate date and time are input. Replace the battery suitably. (M71)</li> <li>• MAC wireless will not be displayed when the NETWORK MODE is set to the WIRED even if the wireless network card is mounted.</li> <li>• IP ADDRESS, SUBNET MASK and DEFAULT GATEWAY indicate "0.0.0.0" in the following condition.             <ol style="list-style-type: none"> <li>(1) The NETWORK MODE is set to the WIRELESS and the wireless network card is not mounted.</li> <li>(2) DHCP is ON and the projector does not get address from DHCP server.</li> </ol> </li> <li>• Nothing (blank) is shown in the "CH", "SPEED" and "MAC WIRELESS" field in case of either no wireless network card is inserted or "WIRED" mode is selected at NETWORK MODE, or both.</li> <li>• The actual performance and setting will be shown in the "CH" and "SPEED" field, instead of the setting value in the SETUP menu.</li> </ul>
<p><b>SERVICE</b></p>	<p>Selecting this item displays the SERVICE menu. Use the ▲/▼ buttons to select an item, and the ► or ENTER button on the remote control to perform the item.</p>  <p><b>MIU RESTART</b></p> <p>Use the ▲ button to restart the network communication. The network communication will be cut off once and restarted.</p>  <p>EXECUTE ⇄ CANCEL</p> <ul style="list-style-type: none"> <li>• After selecting the EXECUTE, the MIU menu may not be controlled approximately 20 seconds.</li> <li>• If DHCP is ON, IP address may be changed.</li> </ul>

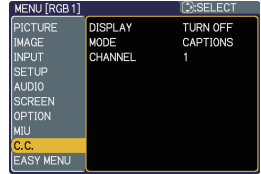

## C.C. (Closed Caption) menu

The closed caption setting can be changed through C.C. menu in the advance menu. Please select the item that you will change using ▲/▼ cursor buttons.

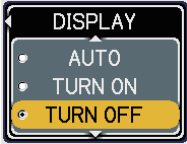

- The C.C. (Closed Caption) is the function that displays a transcript or dialog of the audio portion of a video, files or other presentation or other relevant sounds. It is required to have NTSC format video or 480i@60 format component video source supporting C.C. feature to utilize this function.

It may not work properly, depending on equipment or signal source. In this case, please turn off the Closed Caption.

Item	Description
<p><b>DISPLAY</b></p>	<p>Select Closed Caption DISPLAY setting from following options using ▲/▼ buttons.</p> <p>TURN OFF ⇄ TURN ON ⇄ AUTO</p> <p style="text-align: center;">↑—————↑</p> <p>TURN OFF: Closed Caption is OFF            TURN ON: Closed Caption is ON            AUTO: Closed Caption automatically displays when the volume is muted.</p> <ul style="list-style-type: none"> <li>• The caption is not displayed when the OSD menu is active.</li> <li>• The Closed Caption is the function to display the dialogue, narration, and / or sound effects of a television program or other video sources. The Closed Caption availability is depending upon broadcaster and/or content.</li> </ul> 
<p><b>MODE</b></p>	<p>Select Closed Caption MODE setting from following options using ▲/▼ buttons.</p> <p>CAPTIONS ⇄ TEXT</p> <p>CAPTIONS: Display Closed Caption            TEXT: Display Text data, which is for additional information such as news reports or a TV program guide. The information covers the entire screen. Not all of the C.C. program has Text information.</p> 
<p><b>CHANNEL</b></p>	<p>Select Closed Caption CHANNEL from following options using ▲/▼ buttons.</p> <p>4 ⇄ 3 ⇄ 2 ⇄ 1</p> <p style="text-align: center;">↑—————↑</p> <p>1: Channel 1, primary channel / language            2: Channel 2            3: Channel 3            4: Channel 4</p> <p>The channel data may vary, depending on the content. Some channel might be used for secondary language or empty.</p> 



## Maintenance

### Lamp

A lamp has finite product life. Using the lamp for long periods of time could cause the pictures darker or the color tone poor. Note that each lamp has a different lifetime, and some may burst or burn out soon after you start using them.

Preparation of a new lamp and early replacement are recommended. To prepare a new lamp, contact your dealer and tell the lamp type number.

**Type number = DT00873**

### Replacing the lamp

1. Turn the projector off, and unplug the power cord.  
Allow the projector to cool for at least 45 minutes.
2. Prepare a new lamp.  
If the projector is mounted on a ceiling, or if the lamp has broken, also ask the dealer to replace the lamp.

### In case of replacement by yourself,

3. Loosen the screw (marked by arrow) of the lamp cover and then slide the lamp cover to the side to remove it.
4. Loosen the 3 screws (marked by arrow) of the lamp, and slowly pick up the lamp by the handles.
5. Insert the new lamp, and retighten firmly the 3 screws of the lamp that are loosened in the previous process to lock it in place.
6. Slide the lamp cover back in place and firmly fasten the screw of the lamp cover.
7. Turn the projector on and reset the lamp time using the LAMP TIME item in the OPTION menu (45).
  - (1) Press the **MENU** button to display a menu.
  - (2) Point at the "Go to Advanced Menu ..." in the menu using the **▼/▲** button, then press the **▶** button.
  - (3) Point at the "OPTION" in the left column of the menu using the **▼/▲** button, then press the **▶** button.
  - (4) Point at the "LAMP TIME" using the **▼/▲** button, then press the **▶** button. A dialog will appear.
  - (5) Press the **▲** button to select "RESET" on the dialog. It performs resetting the lamp time.

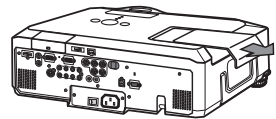
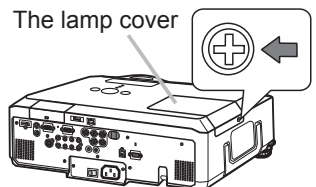

The handles

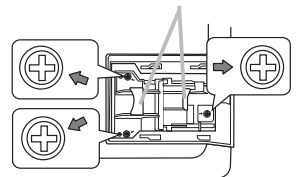

**NOTE** • Please reset the lamp time only when you have replaced the lamp, for a suitable indication about the lamp.

**Lamp (continued)****Lamp warning**

 **HIGH VOLTAGE**     **HIGH TEMPERATURE**     **HIGH PRESSURE**

**⚠ WARNING** ▶ The projector uses a high-pressure mercury glass lamp. The lamp can break with a loud bang, or burn out, if jolted or scratched, handled while hot, or worn over time. Note that each lamp has a different lifetime, and some may burst or burn out soon after you start using them. In addition, when the bulb bursts, it is possible for shards of glass to fly into the lamp housing, and for gas containing mercury to escape from the projector's vent holes.

▶ **About disposal of a lamp:** This product contains a mercury lamp; do not put it in a trash. Dispose of it in accordance with environmental laws.

- For lamp recycling, go to [www.lamprecycle.org](http://www.lamprecycle.org) (in the US).
- For product disposal, contact your local government agency or [www.eiae.org](http://www.eiae.org) (in the US) or [www.epsc.ca](http://www.epsc.ca) (in Canada).

For more information, call your dealer.



Disconnect the plug from the power outlet

- If the lamp should break (it will make a loud bang when it does), unplug the power cord from the outlet, and make sure to request a replacement lamp from your local dealer. Note that shards of glass could damage the projector's internals, or cause injury during handling, so please do not try to clean the projector or replace the lamp yourself.
- If the lamp should break (it will make a loud bang when it does), ventilate the room well, and make sure not to breathe the gas that comes out of the projector vents, or get it in your eyes or mouth.
- Before replacing the lamp, turn the projector off and unplug the power cord, then wait at least 45 minutes for the lamp to cool sufficiently. Handling the lamp while hot can cause burns, as well as damaging the lamp.



- Never unscrew except the appointed (marked by an arrow) screws.
- Do not open the lamp cover while the projector is suspended from a ceiling. This is dangerous, since if the lamp's bulb has broken, the shards will fall out when the cover is opened. In addition, working in high places is dangerous, so ask your local dealer to have the lamp replaced even if the bulb is not broken.
- Do not use the projector with the lamp cover removed. At the lamp replacing, make sure that the screws are screwed in firmly. Loose screws could result in damage or injury.



- Use only the lamp of the specified type.
- If the lamp breaks soon after the first time it is used, it is possible that there are electrical problems elsewhere besides the lamp. If this happens, contact your local dealer or a service representative.
- Handle with care: jolting or scratching could cause the lamp bulb to burst during use.
- Using the lamp for long periods of time, could cause it dark, not to light up or to burst. When the pictures appear dark, or when the color tone is poor, please replace the lamp as soon as possible. Do not use old (used) lamps; this is a cause of breakage.

## Air filter

Please check and clean the air filter periodically. When the indicators or a message prompts you to clean the air filter, comply with it as soon as possible. The air filter has two kinds of filters inside. Replace the filters when they are damaged or too soiled. To prepare the new filters, make contact with your dealer and tell the following type number.

### Type number = MU05661

When you replace the lamp, please replace the air filter. An air filter of specified type will come together with a replacement lamp for this projector.

- 1 Turn the projector off, and unplug the power cord. Allow the projector to sufficiently cool down.
  - 2 Use a vacuum cleaner on and around the filter cover.
  - 3 Pull the filter cover knobs while lifting it, to take the filter unit off.
  - 4 Use a vacuum cleaner for the filter vent of the projector and both sides of the filter unit.
- If the filters are damaged or too soiled, replace them according to the following procedure number 5 to 7. Otherwise, please jump to the procedure number 8.
- 5 Pull the filter frame's knob up while holding the filter cover to remove the filter frame, then take the filters out.
  - 6 Set new filters where former filters were. Put the larger meshed filter into a filter cover first. Then put the finer meshed filter on the larger meshed one.
  - 7 Put the filter frame back where it was.
  - 8 Put the filter unit back into the projector.
  - 9 Turn the projector on and reset the filter time using the FILTER TIME item in the EASY MENU
    - (1) Press the **MENU** button to display a menu.
    - (2) Point at the "FILTER TIME" using the **▼/▲** button, then press the **▶** button. A dialog will appear.
    - (3) Press the **▲** button to select RESET on the dialog. It performs resetting the filter time.

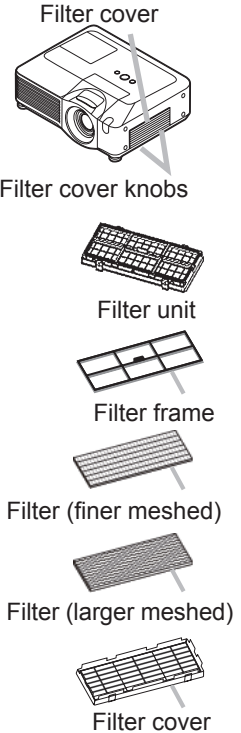

**⚠ WARNING** ▶ Before taking care of the air filter, make sure the power cable is not plugged in, then allow the projector to cool sufficiently.

▶ Use only the air filter of the specified type. Do not use the projector without the air filter or the filter cover. It could result in a fire or malfunction to the projector.

▶ Clean the air filter periodically. If the air filter becomes clogged by dust or the like, internal temperatures rise and could cause a fire, a burn or malfunction to the projector.

**NOTE** • Please reset the filter time only when you have cleaned or replaced the air filter, for a suitable indication about the air filter.

• The projector may display the message such as "CHECK THE AIR FLOW" or turn off the projector, to prevent the internal heat level rising.

## Internal clock battery

Consumption of the battery makes the clock not to work correctly. When the clock is wrong or it has stopped, please replace the battery according to the following procedures.

1. Turn the projector off, and unplug the power cord. Allow the projector to cool sufficiently.
2. After making sure that the projector has cooled adequately, slowly turn over the projector, so that the bottom is facing.
3. Remove the battery cover.  
Turn the battery cover in the direction indicated "OPEN" using such as coins. Then the battery cover will come up. While removing the battery cover, pick its knob.
4. Take the old battery out.  
Press the metal claw of the battery holder. Then the battery will come up. Remove the battery.
5. Put a new battery in.  
**Replace battery with HITACHI MAXELL, Part No.CR2032 only. Use of another battery may present a risk of fire or explosion.**  
Insert a new battery in the battery holder according to its minus terminal  $\ominus$  as indicated in the battery holder, so that the side marked by + is facing. And push the battery into the battery holder fully to fix.
6. Close the battery cover.  
Replace the battery cover in place, then turn it in the direction indicated "CLOSE" using such as coins, to fix.

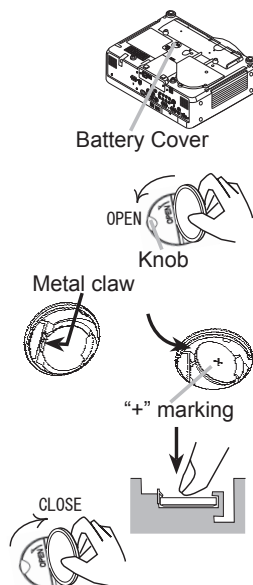

**⚠ WARNING** ▶ Always handle the batteries with care and use them only as directed. Battery may explode if mistreated. Do not recharge, disassemble or dispose of in fire.

And also improper use may result in cracking or leakage, which could result in fire, injury and/or pollution of the surrounding environment.

- Be sure to use only the batteries specified.
- Make sure the plus and minus terminals are correctly aligned when loading a battery. If the battery is placed in the battery holder upside-down, it may be hard to remove.
- Keep a battery away from children and pets. If swallowed consult a physician immediately for emergency treatment.
- Do not short circuit or solder a battery.
- Do not allow a battery in a fire or water. Keep batteries in a dark, cool and dry place.
- If you observe battery leakage, wipe out the leakage and then replace a battery. If the leakage adheres to your body or clothes, rinse well with water immediately.
- Obey the local laws on disposing the battery.

**NOTE** • If the battery is placed in the battery holder upside-down, follow the procedure below to remove and reload it properly.

1. Remove the battery cover as described in steps 1 through 3 above.
2. Turn the projector over again, so that the top of the projector is facing up.
3. While lifting the side of the projector closest to the lens, press the metal claw of the battery holder. The battery will fall out of the holder, so be careful not to lose it.
4. Turn the projector over once more, so that the bottom faces up, and reload the battery correctly.

• The internal clock's time will be reset when the battery is removed.

Please reconfigure the time via the menu or a web browser after replacing the battery.

**Date/Time Settings in the User's Manual (detailed) - Network Guide**

## Other care

### Inside of the projector

In order to ensure the safe use of your projector, please have it cleaned and inspected by your dealer about once every year.

### Caring for the lens

If the lens is flawed, soiled or fogged, it could cause deterioration of display quality. Please take care of the lens, being cautious of handling.

1. Turn the projector off, and unplug the power cord. Allow the projector to cool sufficiently.
2. After making sure that the projector is cool adequately, lightly wipe the lens with a commercially available lens-cleaning wipe. Do not touch the lens directly with your hand.

### Caring for the cabinet and remote control

Incorrect care could have adverse influence such as discoloration, peeling paint, etc.

1. Turn the projector off, and unplug the power cord. Allow the projector to cool sufficiently.
2. After making sure that the projector is cool adequately, lightly wipe with gauze or a soft cloth.  
If the projector is extremely dirty, dip soft cloth in water or a neutral cleaner diluted in water, and wipe lightly after wringing well. Then, wipe lightly with a soft, dry cloth.

**⚠ WARNING** ▶ Before caring, make sure the power switch is off and the power cable is not plugged in, and then allow the projector to cool sufficiently. The care in a high temperature state of the projector could cause a burn and/or malfunction to the projector.

▶ Never try to care for the inside of the projector personally. Doing is so dangerous.

▶ Avoid wetting the projector or inserting liquids in the projector. It could result in a fire, an electric shock, and/or malfunction to the projector.

- Do not put anything containing water, cleaners or chemicals near the projector.
- Do not use aerosols or sprays.

**⚠ CAUTION** ▶ Please take right care of the projector according to the following. Incorrect care could cause not only an injury but adverse influence such as discoloration, peeling paint, etc.





- ▶ Do not use cleaners or chemicals other than those specified in this manual.
- ▶ Do not polish or wipe with hard objects.

## Troubleshooting

### Related messages

When the unit's power is on, messages such as those shown below may be displayed. When any such message is displayed on the screen, please follow the instructions described below. If the same message is displayed after the remedy, or if a message other than the following appears, please contact your dealer or service company.

Although these messages will be automatically disappeared around several minutes, it will be reappeared every time the power is turned on.

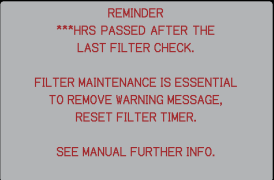
Message	Description
 <p>NO INPUT IS DETECTED ***</p>	<p><b>There is no input signal.</b> Please confirm the signal input connection, and the status of the signal source.</p>
 <p>SYNC IS OUT OF RANGE *** f<sup>hd</sup> **kHz      f<sup>vd</sup> **Hz</p>	<p><b>The horizontal or vertical frequency of the input signal is not within the specified range.</b> Please confirm the specs for your projector or the signal source specs.</p>
 <p>INVALID SCAN FREQ. ***</p>	<p><b>An improper signal is input.</b> Please confirm the specs for your projector or the signal source specs.</p>
 <p>CHECK THE AIR FLOW</p>	<p><b>The internal temperature is rising.</b> Please turn the power off, and allow the projector to cool down at least 20 minutes. After having confirmed the following items, please turn the power ON again.</p> <ul style="list-style-type: none"> <li>• Is there blockage of the air passage aperture?</li> <li>• Is the air filter dirty?</li> <li>• Does the peripheral temperature exceed 35°C?</li> </ul> <p>If the same indication is displayed after the remedy, please set FAN SPEED of the SERVICE item in the OPTION menu to HIGH.</p>
 <p>REMINDER ***HRS PASSED AFTER THE LAST FILTER CHECK.  FILTER MAINTENANCE IS ESSENTIAL TO REMOVE WARNING MESSAGE, RESET FILTER TIMER.  SEE MANUAL FURTHER INFO.</p>	<p><b>A note of precaution when cleaning the air filter.</b> Please immediately turn the power off, and clean or change the air filter referring to the “Air filter” section of this manual (📖67). After you have cleaned or changed the air filter, please be sure to reset the filter timer (📖26, 45).</p>

## Regarding the indicator lamps

Lighting and flashing of the **POWER** indicator, the **LAMP** indicator, and the **TEMP** indicator have the meanings as described in the table below. Please follow the instructions within the table. If the same indication is displayed after the remedy, or if an indication other than the following is displayed, please contact your dealer or service company.

POWER indicator	LAMP indicator	TEMP indicator	Description
Lighting In <b>Orange</b>	Turned <b>off</b>	Turned <b>off</b>	<b>The projector is in a standby state.</b> Please refer to the section "Power On/Off".
<i>Blinking</i> In <b>Green</b>	Turned <b>off</b>	Turned <b>off</b>	<b>The projector is warming up.</b> Please wait.
Lighting In <b>Green</b>	Turned <b>off</b>	Turned <b>off</b>	<b>The projector is in an on state.</b> Ordinary operations may be performed.
<i>Blinking</i> In <b>Orange</b>	Turned <b>off</b>	Turned <b>off</b>	<b>The projector is cooling down.</b> Please wait.
<i>Blinking</i> In <b>Red</b>	(discretionary)	(discretionary)	<b>The projector is cooling down. A certain error has been detected.</b> Please wait until the <b>POWER</b> indicator finishes blinking, and then perform the proper measure using the item descriptions below.
<i>Blinking</i> In <b>Red</b> or Lighting In <b>Red</b>	Lighting In <b>Red</b>	Turned <b>off</b>	<b>The lamp does not light, and there is a possibility that interior portion has become heated.</b> Please turn the power off, and allow the projector to cool down at least 20 minutes. After the projector has sufficiently cooled down, please make confirmation of the following items, and then turn the power on again. <ul style="list-style-type: none"> <li>• Is there blockage of the air passage aperture?</li> <li>• Is the air filter dirty?</li> <li>• Does the peripheral temperature exceed 35°C?</li> </ul> If the same indication is displayed after the remedy, please change the lamp referring to the section "Lamp".
<i>Blinking</i> In <b>Red</b> or Lighting In <b>Red</b>	<i>Blinking</i> In <b>Red</b>	Turned <b>off</b>	<b>The lamp cover has not been properly fixed.</b> Please turn the power off, and allow the projector to cool down at least 45 minutes. After the projector has sufficiently cooled down, please make confirmation of the attachment state of the lamp cover. After performing any needed maintenance, turn the power on again. If the same indication is displayed after the remedy, please contact your dealer or service company.

(Continued on next page)

Regarding the indicator lamps (continued)

POWER indicator	LAMP indicator	TEMP indicator	Description
Blinking In <b>Red</b> or Lighting In <b>Red</b>	Turned off	Blinking In <b>Red</b>	<b>The cooling fan is not operating.</b> Please turn the power off, and allow the projector to cool down at least 20 minutes. After the projector has sufficiently cooled down, please make confirmation that no foreign matter has become caught in the fan, etc., and then turn the power on again. If the same indication is displayed after the remedy, please contact your dealer or service company.
Blinking In <b>Red</b> or Lighting In <b>Red</b>	Turned off	Lighting In <b>Red</b>	<b>There is a possibility that the interior portion has become heated.</b> Please turn the power off, and allow the projector to cool down at least 20 minutes. After the projector has sufficiently cooled down, please make confirmation of the following items, and then turn the power on again. <ul style="list-style-type: none"> <li>• Is there blockage of the air passage aperture?</li> <li>• Is the air filter dirty?</li> <li>• Does the peripheral temperature exceed 35°C?</li> </ul> If the same indication is displayed after the remedy, please set FANSPEED of the SERVICE item in the OPTION menu to HIGH.
Lighting In <b>Green</b>	Simultaneous blinking in <b>Red</b>		<b>It is time to clean the air filter.</b> Please immediately turn the power off, and clean or change the air filter referring to the section “Air Filter”. After cleaning or changing the air filter, please be sure to reset the filter timer. After the remedy, reset the power to ON.
Lighting In <b>Green</b>	Alternative blinking in <b>Red</b>		<b>There is a possibility that the interior portion has become overcooled.</b> Please use the unit within the usage temperature parameters (5°C to 35°C). After the treatment, reset the power to ON.
Blinking in <b>Green</b> for approx. 3 seconds	Turned off	Turned off	<b>At least 1 “Power ON” schedule is saved to the projector.</b> (Please refer to the  User’s Manual - Network Guide: Schedule Settings for more information.)

**NOTE** • When the interior portion has become overheated, for safety purposes, the power source is automatically turned off, and the indicator lamps may also be turned off. In such a case, press the “O” (OFF) side of the power switch, and wait at least 45 minutes. After the projector has sufficiently cooled down, please make confirmation of the attachment state of the lamp and lamp cover, and then turn the power on again.



## Phenomena that may be easy to be mistaken for machine defects

**⚠ WARNING** ▶ Never use the projector if abnormal operations such as smoke, strange odor, excessive sound, damaged casing or elements or cables, penetration of liquids or foreign matter, etc. should occur. In such cases, immediately turn off the power switch and then disconnect the power plug from the power outlet. After making sure that the smoke or odor has stopped, contact your dealer or service company.

1. Before requesting repair, please check in accordance with the following chart. This operation sometimes resolves your problem. If the situation cannot be corrected,
2. The projector's microprocessor may need to be reset. Please push the Shutdown switch by using a pin or similar and the projector will be turned off immediately. Before turning it again, wait at least 10 minutes to make the projector cool down enough.
3. Some setting may be wrong. Please use the FACTORY RESET function of the SERVICE item in the OPTION menu (U48) to reset all settings to factory default. Then, if the problem is not removed after the remedy, please contact your dealer or service company.

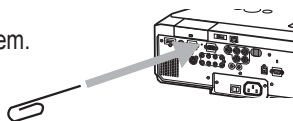

Phenomenon	Cases not involving a machine defect	Reference page
Power does not come on.	<b>The electrical power cord is not plugged in.</b> Correctly connect the power cord.	13
	<b>The power switch is not set to the on position.</b> Set the power switch to [ ] (On).	17
	<b>The main power source has been interrupted during operation such as by a power outage (blackout), etc.</b> Please turn the power off, and allow the projector to cool down at least 2 minutes, then turn the power on again.	17
	<b>Either there is no lamp and/or lamp cover, or either of these has not been properly fixed.</b> Please turn the power off, and allow the projector to cool down at least 45 minutes. After the projector has sufficiently cooled down, please make confirmation of the attachment state of the lamp and lamp cover, and then turn the power on again.	65
Neither sounds nor pictures are outputted.	<b>The signal cables are not correctly connected.</b> Correctly connect the connection cables.	10
	<b>Signal source does not correctly work.</b> Correctly set up the signal source device by referring to the manual of the source device.	–
	<b>The input changeover settings are mismatched.</b> Select the input signal, and correct the settings.	18, 19
	<b>The BLANK function for pictures and the MUTE function for sounds are working.</b> AV mute may be active. Refer to the item “Sound does not come out” and “No pictures are displayed” on the next page to turn off the MUTE and BLANK functions.	18, 23

(Continued on next page)

**Phenomena that may be easily mistaken for machine defects (continued)**

Phenomenon	Cases not involving a machine defect	Reference page
Sound does not come out.	<b>The signal cables are not correctly connected.</b> Correctly connect the audio cables.	10
	<b>The MUTE function is working.</b> Restore the sound pressing the <b>MUTE</b> or <b>VOLUME</b> button on the remote control.	18
	<b>The volume is adjusted to an extremely low level.</b> Adjust the volume to a higher level using the menu function or the remote control.	18
	<b>The AUDIO setting is not correct.</b> Correctly set the items in the AUDIO menu.	38
	<b>The audio on your HDMI equipment is not set to Linear PCM.</b> The <b>HDMI</b> input on this projector supports Linear PCM audio only. Check the audio setting on your HDMI equipment.	11
	<b>The audio on the HDMI input is muted.</b> Change the audio setting in the AUDIO menu.	38
	<b>The digital audio in HDMI signal does not work well.</b> Use the analogue audio, connecting either an RCA audio cable or stereo mini cable.	10
No pictures are displayed.	<b>The lens cover is attached.</b> Remove the lens cover.	3, 17
	<b>The signal cables are not correctly connected.</b> Correctly connect the connection cables.	10
	<b>The brightness is adjusted to an extremely low level.</b> Adjust <b>BRIGHTNESS</b> to a higher level using the menu function or the remote control.	26
	<b>The computer cannot detect the projector as a plug and play monitor.</b> Make sure that the computer can detect a plug and play monitor using another plug and play monitor.	11
	<b>The BLANK screen is displayed.</b> Press the <b>BLANK</b> button on the remote control.	23
No pictures or disturbed pictures are displayed on <b>HDMI</b> input.	<b>The HDMI cable is not correctly connected.</b> Correctly connect the HDMI cable.	10
	<b>Your HDMI equipment is not compatible with the projector</b> This projector can be connected with another equipment that has HDMI or DVI connector, but with some equipment the projector may not work properly.	11
	<b>Your HDMI equipment and the projector are not harmonized.</b> Turn off the both equipment, and turn on them again	–
	<b>The signal format on the HDMI is not supported.</b> Check the video setting on your HDMI equipment.	11

**Phenomena that may be easily mistaken for machine defects (continued)**

Phenomenon	Cases not involving a machine defect	Reference page
Video screen display freezes.	<b>The FREEZE function is working.</b> Press the <b>FREEZE</b> button to restore the screen to normal.	22
Colors have a faded- out appearance, or Color tone is poor.	<b>Color settings are not correctly adjusted.</b> Perform picture adjustments by changing the COLOR TEMP, COLOR, TINT and/or COLOR SPACE settings, using the menu functions.	26, 28, 32
	<b>COLOR SPACE setting is not suitable.</b> Change the COLOR SPACE setting to AUTO, RGB, SMPTE240, REC709 or REC601.	32
Pictures appear dark.	<b>The brightness and/or contrast are adjusted to an extremely low level.</b> Adjust BRIGHTNESS and/or CONTRAST settings to a higher level using the menu function.	26
	<b>The WHISPER function is working.</b> Select NORMAL for the WHISPER item in the SETUP menu.	26, 37
	<b>The lamp is approaching the end of its product lifetime.</b> Replace the lamp.	65, 66
Pictures appear blurry.	<b>Either the focus and/or horizontal phase settings are not properly adjusted.</b> Adjust the focus using the focus ring, and/or H PHASE using the menu function.	20, 31
	<b>The lens is dirty or misty.</b> Clean the lens referring to the section "Caring for the lens".	69
Pictures are trembling.	<b>The exhaust ventilation holes at front is blocked by some objects.</b> Remove any objects from front side of the projector.	4

**NOTE** • Although bright spots or dark spots may appear on the screen, this is a unique characteristic of liquid crystal displays, and it does not constitute or imply a machine defect.

## Warranty and after-service

If a problem occurs with the equipment, first refer to the “Troubleshooting” and run through the suggested checks. If this does not resolve the problem, please contact your dealer or service company. They will tell you what warranty condition is applied.

## Specifications

Item	Specifications
Product name	Liquid crystal projector
Liquid Crystal Panel	1024 horizontal x 768 vertical
Lens	Zoom lens F=1.7 ~ 1.9 f=24 ~ 29 mm (approx.)
Lamp	275W UHB
Audio output	4W x 4
Power supply	AC 100-120V/5.0A, AC220-240V/2.1A
Power consumption	460W
Temperature range	5 ~ 35°C (Operating)
Weight (mass)	7.1kg (approx.)
Ports	RGB1 ..... D-sub 15 pin mini x 1 RGB2 G/Y, B/CB/P <sub>B</sub> , R/CR/P <sub>R</sub> , H, V ..... BNC x 5 S-VIDEO ..... mini DIN 4 pin x 1 VIDEO ..... RCA x 1 Y, CB/P <sub>B</sub> , CR/P <sub>R</sub> (component video) ..... RCA x 3 HDMI ..... HDMI x 1 AUDIO IN1 ..... Stereo mini x 1 AUDIO IN2 ..... Stereo mini x 1 AUDIO IN3 R/L ..... RCA x 2 AUDIO IN4 R/L ..... RCA x 2 RGB OUT ..... D-sub 15 pin mini x 1 AUDIO OUT ..... Stereo mini x 1 USB ..... USB (B) x 1 REMOTE CONTROL ..... Stereo mini x 1 CONTROL ..... D-sub 9 pin x 1 LAN ..... RJ45 x 1 AUX I/O ..... USB (A) x 1 SD CARD ..... SD card slot x 1
Optional parts	<b>Lamp:</b> DT00873 <b>Air filter:</b> MU05661 <b>Wireless network card:</b> VA0833x* * For more information, please consult your dealer.

**NOTE** • These specifications are subject to change without notice.

Specifications (continued)

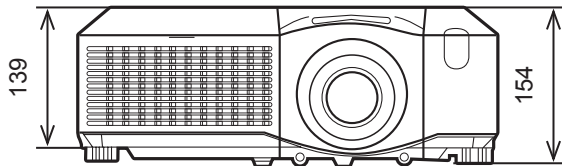
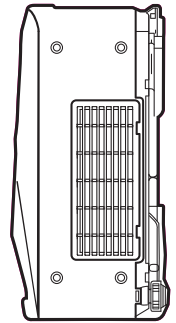
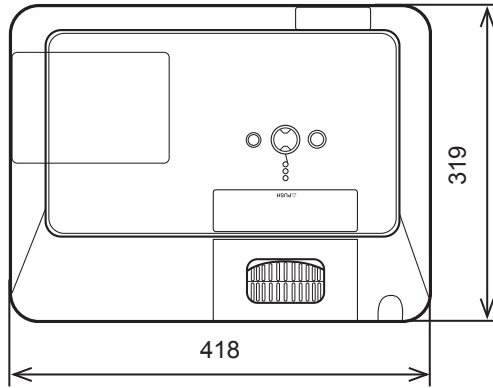
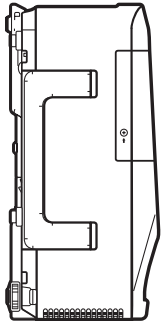
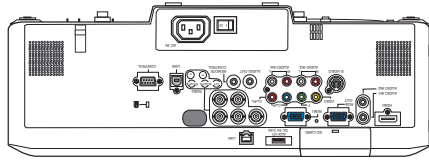

[unit: mm]