



ILLUMINATION.  
DEFINITION.  
DIAMOND.

Specifications

Model		HC6500		
Projection system		Transmissive liquid crystal system		
Panel specs	Panel size	0.74type x3 Aspect ratio 16:9 with micro lens		
	Number of pixels	1920x1080 (total 2,073,600 pixels)		
	Drive system	3 primary color liquid crystal shutter system		
Optical specs	Array	Stripe pattern		
	Zoom / focus operation	1.6-power zoom / motorized		
	Lens shift	Motorized up-down 75% / right-left 5%		
	Throw ratio	1.42-2.26		
	Projection lens	f=23.5-37.6mm / 0.9"-1.5" F1.8-2.3		
	Light source lamp	160W		
	Optical system	Mirror color separation / prism synthesis system		
Projection screen size (inches)		50-300: (Diagonal)		
	Brightness (lm)	1200		
Images	Contrast ratio	15000:1 (auto-iris) typ.		
	Resolution	PC input	VGA* 640x480 - UXGA* 1600x1200	
	Scan frequency	Horizontal (kHz)	15-100kHz	
		Vertical (Hz)	24, 50Hz-120Hz	
Input signal system	Video	NTSC, NTSC4.43, PAL (including PAL-M and N), SECAM, PAL-60 Video input: 480i/p, 576i/p, 1080i 60/50, 1080p 60/50/24, 720p 60/50		
	PC	PC/AT compatibles, Mac		
Input	PC input	Mini D-Sub 15 pin	1 terminal	
		HDMI input	HDMI terminal	
	Video	Composites	RCA terminal	
		S	S-Video terminal	
	Components	RCA terminal	1 terminal (component can be also input to Mini D-Sub 15 pin)	
		Serial / RS-232C standard		1 terminal (D-Sub 9 pin)
Output	Trigger terminal		1 terminal	
	Digital keystone		Vertical ±15steps	
Functions	Fan noise		17dBA (at low mode)	
	Power source voltage		AC100V 50/60Hz	
	Power consumption (W)		250 (at stand by 7W)	
	Weight (kg / lbs)		7.5 / 16.5	
	Main unit dimensions	WxDxH	427x440x159mm / 16.8"x17.3"x6.3" (excluding height adjustment)	
Other	Supplied accessories	Power source cord (2.9m), Remote control, AA batteries (x2), RGB signal cable, RS-232C cable, Lens cap, Lamp replacement tray		
Warranty		2-years parts and labor, 1-year or 500 hours on lamp (whichever comes first)		

\*: SVGA, XGA, WXGA, SXGA, UXGA are registered trademarks of IBM Corporation of the United States

Projection distance

Screen size (16:9)				Projection distance				Up-down lens shift		Right-Left lens shift	
Diagonal	W (width)	H (height)	Max Zoom	Min Zoom	Down	Up	Left	Right	Diagonal	W (width)	H (height)
50	127	43.7	24.4	59	98	19 ← 0 → 19	2.4 ← 0 → 2.4		50	127	43.7
60	152	52.4	29.5	71	118	22 ← 0 → 22	2.8 ← 0 → 2.8		60	152	52.4
70	178	61.0	34.3	87	138	26 ← 0 → 26	3.1 ← 0 → 3.1		70	178	61.0
80	203	69.7	39.4	98	158	30 ← 0 → 30	3.5 ← 0 → 3.5		80	203	69.7
90	229	78.3	44.1	110	177	33 ← 0 → 33	3.9 ← 0 → 3.9		90	229	78.3
100	254	87.0	49.2	122	197	37 ← 0 → 37	4.3 ← 0 → 4.3		100	254	87.0
110	279	96.1	53.9	134	217	41 ← 0 → 41	4.7 ← 0 → 4.7		110	279	96.1
120	305	104.7	58.7	150	236	44 ← 0 → 44	5.1 ← 0 → 5.1		120	305	104.7
130	330	113.4	63.8	161	256	48 ← 0 → 48	5.5 ← 0 → 5.5		130	330	113.4
140	356	122.0	68.5	173	276	52 ← 0 → 52	5.9 ← 0 → 5.9		140	356	122.0
150	381	130.7	73.6	185	299	55 ← 0 → 55	6.7 ← 0 → 6.7		150	381	130.7
200	508	174.4	96.0	248	398	74 ← 0 → 74	8.7 ← 0 → 8.7		200	508	174.4
250	635	217.7	122.4	311	496	92 ← 0 → 92	11 ← 0 → 11		250	635	217.7
300	762	261.4	147.2	374	598	110 ← 0 → 110	13 ← 0 → 13		300	762	261.4

\* The above figures are approximate and may be slightly different from the actual measurements.

Vertical direction

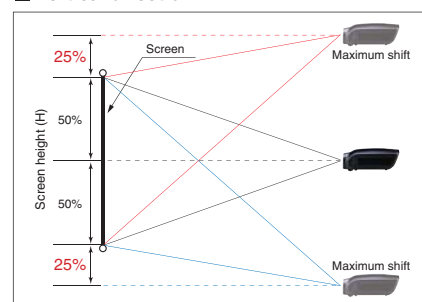

Horizontal direction

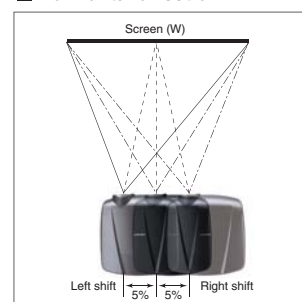

Dimensions

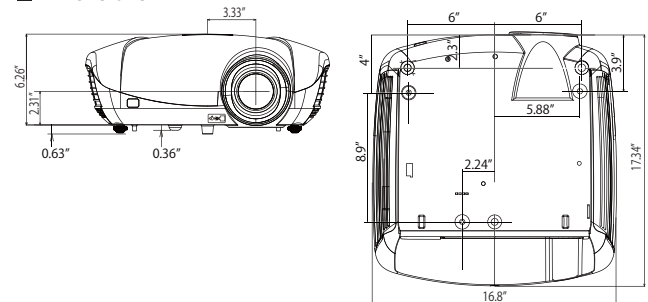

MITSUBISHI DIGITAL ELECTRONICS AMERICA, INC.  
Presentation Products Division  
Phone: 888.307.0349  
Email: ppdinfo@mdea.com  
www.mitsubishi-presentations.com

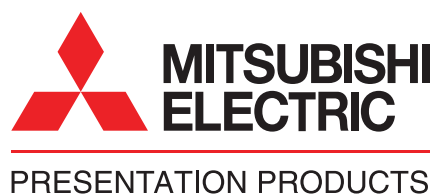

MITSUBISHI ELECTRIC SALES CANADA, INC.  
Information Technologies Group  
Phone: 905.475.7728  
www.mitsubishielectric.ca

NEW HC6500

# Today, Exceptional Performance Means Exceptional Design

And that's exactly what you'll find in the new HC6500 home theater projector. Exquisite colors, high-contrast images and impressive picture reproduction are ensured with Mitsubishi's innovative hybrid D6 drive and Auto Iris 15000:1 high-contrast technologies. These and other advanced functions are packaged into an ergonomic and aesthetically pleasing black chassis that blends easily with any room environment. In a single word, it's "Futuristic".

Pioneering the future of home theater systems.



**NEW HC6500**



## Newly Developed Auto-Iris Algorithm with Quick 1/60-sec Control

Astoundingly beautiful color reproduction is what the HC6500 offers thanks to the incorporation of the Auto-Iris control algorithm—a feature commonly found in higher priced models. The technology has been evolved to be faster and more accurate, and now provides picture reproduction at a maximum high-contrast ratio of 15000:1. The light intensity of the pixel level for each image displayed on the screen is calculated precisely so that dark scenes are toned down to the appropriate black level even when scene sequences continuously switch between bright and dark images. This ensures the faithful reproduction of every scene detail with vivid clarity. Combined with Mitsubishi's original contrast control function, Auto-Iris delivers the richest blacks, the brightest whites, and the vivid richness of every color in between.



### ■ New Auto-Iris (HC6500)



### ■ Previous Auto-Iris (HC5000)



## Extra-low Dispersion Glass Lenses for Full High-definition Resolution (1920x1080)

Superior image reproduction is achieved as the result of adopting a 17-lens/14-group optical system equipped with extra-low dispersion (ED) glass lenses. Far exceeding the performance of conventional glass lenses, improved resolution is apparent across the entire screen and chromatic aberration is virtually eliminated, even in peripheral areas.

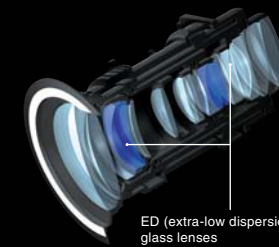

## Power Zoom/Focus Adjustment and Lens Shift Functions Greatly Simplify Set-up

The HC6500 is equipped with a powered 1.6x zoom/focus lens, making it easy to set-up and show impressive big-screen images even in the smallest of rooms. A powered Lens Shift function is included as well, making vertical and horizontal adjustment.

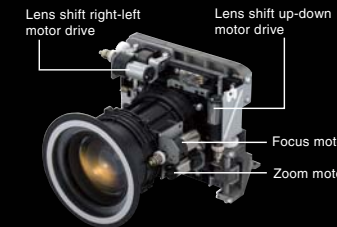

## Quiet 17dBa Operation (at low mode)

The new cooling duct design contributes to improved cooling performance, and a smaller fan motor is adopted to secure a larger air-intake area and better intake-air efficiency for the large (low-noise) Sirocco fan. Furthermore, always striving unprecedented quietness, a seemingly seamless structure was developed for the new chassis, effectively preventing sound permeation and realizing a hushed 17dBa during operation—the quietest in the industry.

### ■ Conventional cooling structure ■ New cooling structure

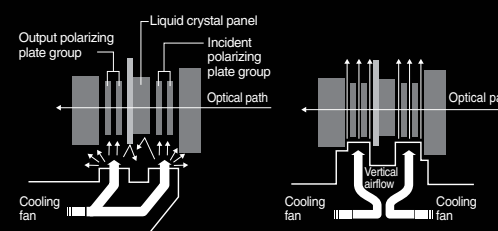

## HQV – Unparalleled Image Reproduction Performance

### ■ Reon-VX: Next-generation high-performance processor

The Reon-VX is the successor to the Realta chip manufactured by Silicon Optics Inc., renowned for delivering Hollywood Quality Video (HQV). This high-performance chip excels behind the scenes as the genuine core of the superior high picture quality and visual impact of the HC6500.

### ■ High-precision I/P conversion for all signal sources

Extremely accurate rendering is provided by Mitsubishi's 10-bit interlace/progressive (I/P) conversion image processing technology. Regardless of the source, signals are detected and processed quickly and with the utmost precision—even signals from mixed video/film media. Signals received broadcast satellite digital movies are processed using 2-3 pulldown technology, which removes the jaggies (jagged outlines) for vivid, clear images. Highly precise three-dimensional (3D) processing is included to convert video signals into scenes with meticulous picture quality, and new-generation 24P disc is supported as well.

### ■ High-performance video scaler

This ultra-precise image scaling function guarantees superior pixel conversion processing when converting resolution up from 720x480p to 1920x1080p. A unique filtering technique enables adaptive switching to a total of 1024 filter tabs each horizontally and vertically, further contributing to the high-definition picture quality of the images.

### ■ Chromatic up-sampling errors reduced

The Reon-VX chip also properly compensates for the loss of color data resulting from signal compression at the production level of most DVD titles. This function enables a more faithful reproduction of the full color spectrum in high-definition images without color blur or loss.



## Two HDMI 1.3 Input Terminals Compatible with "Deep Color"

The HC6500 is capable of processing 10 and 12-bit video signals in addition to conventional 8-bit signal, thereby reproducing high-contrast images utilizing full-color gradation.



## 14-bit Digital Gamma Correction

Mitsubishi's original 14-bit gamma correction processing function expands gradation expression power 16-fold over the conventional 10-bit technology. This dramatically raises the projector's ability to reproduce the subtleties in dark images.

## Next-generation High-definition Liquid crystal Panel (1920x1080)

This next-generation inorganic liquid crystal panel generates high-definition images with the richest blacks and sharpest colors. The rated panel service life is approximately 10 times longer than that of conventional organic film panels, translating into years of enjoyment viewing high-definition images that come to life through vibrant color reproduction.

## 24P Blu-ray Direct Input Compatibility Reproduction of Original Images and Motion

The HC6500 can play signals from most media, including the next-generation Blu-ray 24P optical disk. Compatible with an output of up to 48P (96Hz liquid crystal panel driver), twice the speed of conventional movie signals (24 frames/sec), amazingly life-like images and motion are reproduced with a smoothness and texture detail that mirror the original.

### 2-3 pulldown

When processing images at 60 frames/sec, lining up the signals up in 2- or 3-frame sequences causes overflow into the third B-frame, thereby detracting from motion smoothness.

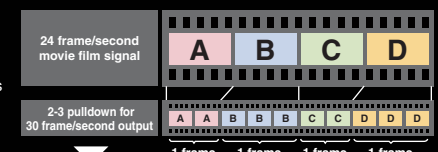

### 24P direct output

With the signal processing speed of 24 frames/sec increased to 48 frames/sec, a sequence is created that aligns the signals. The bottom line is a smooth and fluid reproduction of the original image.

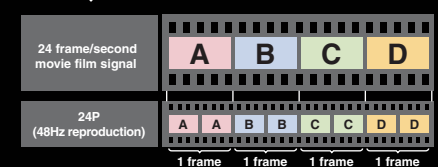

## ■ 3D Micro-surface Structure Air Filter

## ■ Side-loading, Long-life Lamp (max.5000 hours)

## ■ Trigger Terminal

The Mitsubishi HC6500 is designed to match the needs of the most sophisticated home theater, yet can be quickly integrated into the simplest of entertainment systems as well. A trigger connector for controlling a powered-screen drive is included, enabling quick set-up and operation and contributing further to your home theater enjoyment experience.