

# Projector

## CP-WX410

### User's Manual (detailed) Operating Guide

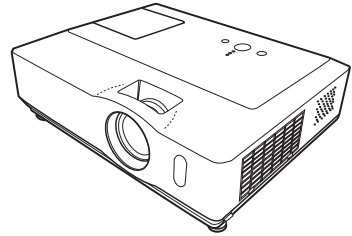

Thank you for purchasing this projector.

**⚠ WARNING** ▶ Before using this product, please read all manuals for this product. Be sure to read "Safety Guide" first. After reading them, store them in a safe place for future reference.

#### About this manual

Various symbols are used in this manual. The meanings of these symbols are described below.

**⚠ WARNING** This symbol indicates information that, if ignored, could possibly result in personal injury or even death due to incorrect handling.

**⚠ CAUTION** This symbol indicates information that, if ignored, could possibly result in personal injury or physical damage due to incorrect handling.

 Please refer to the pages written following this symbol.

**NOTE** • The information in this manual is subject to change without notice.  
• The manufacturer assumes no responsibility for any errors that may appear in this manual.  
• The reproduction, transfer or copy of all or any part of this document is not permitted without express written consent.

#### Trademark acknowledgment

- Mac is a registered trademark of Apple Inc.
  - Windows is a registered trademark of Microsoft Corporation.
  - VESA and DDC are trademarks of the Video Electronics Standard Association.
  - PowerPC is a registered trademark of International Business Machines Corporation.
  - DVI is a trademark of Digital Display Working Group.
  - HDMI, the HDMI logo and High-Definition Multimedia Interface are trademarks or registered trademarks of HDMI Licensing LLC.
- All other trademarks are the properties of their respective owners.

Contents

			
<b>About this manual</b> . . . . .	<b>1</b>	<b>PICTURE menu</b> . . . . .	<b>26</b>
<b>Contents</b> . . . . .	<b>2</b>	BRIGHTNESS, CONTRAST, GAMMA,	
<b>Projector features</b> . . . . .	<b>3</b>	COLOR TEMP, COLOR, TINT, SHARPNESS,	
<b>Preparations</b> . . . . .	<b>3</b>	MY MEMORY	
Contents of package . . . . .	3	<b>IMAGE menu</b> . . . . .	<b>29</b>
Fastening the lens cover . . . . .	3	ASPECT, OVER SCAN, V POSITION,	
<b>Part names</b> . . . . .	<b>4</b>	H POSITION, H PHASE, H SIZE,	
Projector . . . . .	4	AUTO ADJUST EXECUTE	
Control panel . . . . .	5	<b>INPUT menu</b> . . . . .	<b>31</b>
Rear panel . . . . .	5	PROGRESSIVE, VIDEO NR, COLOR SPACE,	
Remote control . . . . .	6	COMPONENT, VIDEO FORMAT, HDMI,	
<b>Setting up</b> . . . . .	<b>7</b>	FRAME LOCK, COMPUTER IN, RESOLUTION	
Arrangement . . . . .	7	<b>SETUP menu</b> . . . . .	<b>34</b>
Connecting your devices . . . . .	9	AUTO KEYSTONE  EXECUTE,	
Connecting power supply . . . . .	11	KEYSTONE  , WHISPER, MIRROR,	
Using the security bar and slot . . . . .	11	STANDBY MODE, MONITOR OUT	
<b>Remote control</b> . . . . .	<b>12</b>	<b>AUDIO menu</b> . . . . .	<b>36</b>
Installing the batteries . . . . .	12	VOLUME, SPEAKER, AUDIO, HDMI AUDIO	
About the remote control signal . . . . .	12	<b>SCREEN menu</b> . . . . .	<b>37</b>
Changing the frequency of remote control signal . . . . .	13	LANGUAGE, MENU POSITION, BLANK,	
Using as a simple PC mouse & keyboard . . . . .	13	START UP, MyScreen, MyScreen Lock,	
<b>Power on/off</b> . . . . .	<b>14</b>	MESSAGE, SOURCE NAME, TEMPLATE	
Turning on the power . . . . .	14	<b>OPTION menu</b> . . . . .	<b>41</b>
Turning off the power . . . . .	14	AUTO SEARCH, AUTO KEYSTONE  ,	
<b>Operating</b> . . . . .	<b>15</b>	AUTO ON, AUTO OFF, LAMP TIME,	
Adjusting the volume . . . . .	15	FILTER TIME, MY BUTTON,	
Temporarily muting the sound . . . . .	15	MY SOURCE, SERVICE, SECURITY	
Selecting an input signal . . . . .	15	<b>C.C. (closed caption) menu</b> . . . . .	<b>54</b>
Searching an input signal . . . . .	17	DISPLAY, MODE, CHANNEL	
Selecting an aspect ratio . . . . .	17	<b>Maintenance</b> . . . . .	<b>55</b>
Adjusting the projector's elevator . . . . .	18	Replacing the lamp . . . . .	55
Adjusting the zoom and focus . . . . .	18	Cleaning and replacing the air filter . . . . .	57
Using the automatic adjustment feature . . . . .	19	Other care . . . . .	59
Adjusting the position . . . . .	19	<b>Troubleshooting</b> . . . . .	<b>60</b>
Correcting the keystone distortions . . . . .	20	Related messages . . . . .	60
Using the magnify feature . . . . .	20	Regarding the indicator lamps . . . . .	61
Freezing the screen . . . . .	21	Shutting the projector down . . . . .	62
Temporarily blanking the screen . . . . .	21	Resetting all settings . . . . .	62
Using the menu function . . . . .	22	Phenomena that may be easy	
<b>EASY MENU</b> . . . . .	<b>24</b>	to be mistaken for machine defects . . . . .	63
ASPECT, AUTO KEYSTONE  EXECUTE,		<b>Specifications</b> . . . . .	<b>66</b>
KEYSTONE  , PICTURE MODE, BRIGHTNESS,			
CONTRAST, COLOR, TINT, SHARPNESS,			
WHISPER, MIRROR, RESET, FILTER TIME,			
LANGUAGE, Go to Advanced Menu . . . . .			

## Projector features

The projector provides you with the broad use by the following features.

- ✓ This projector has a variety of I/O ports that supposedly cover for any business scene.
- ✓ This projector realizes the large projection image, even if in a small space.
- ✓ The new double layer filter system is expected to function longer and offers you less maintenance frequency.
- ✓ The WXGA (1280x800) native resolution can support Widescreen PCs to realize your original images on a screen.
- ✓ The **HDMI** port can support various image equipment which have digital interface to get clearer pictures on a screen.

## Preparations

### Contents of package

Please see the “Contents of package” section in the User’s Manual (concise) which is a book. Your projector should come with the items shown there. Contact immediately your dealer if anything is missing.

**NOTE** • Keep the original packing materials, for future reshipment. Be sure to use the original packing materials when moving the projector. Use special caution for the lens.

### Fastening the lens cover

To avoid losing the lens cover, please fasten the lens cover to the projector using the enclosed strap.

1. Fix the strap to the strap hole of the lens cover.  
Thread one end of the strap through the strap hole of the lens cover and make the loop at the end, and let the other end of the strap through the loop. Not have a knot in the strap at either end.
2. Fix the strap to the strap hole of the projector.  
Thread the other end of the strap through the strap hole of the projector and make the loop there. Let the lens cover with the one end of strap though the loop.

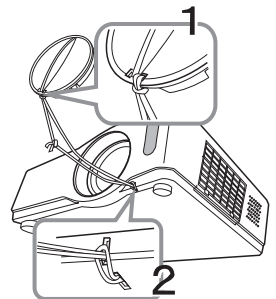

Part names

**Projector**

- (1) Lamp cover (📖55)  
The lamp unit is inside.
- (2) Focus ring (📖18)
- (3) Zoom ring (📖18)
- (4) Control panel (📖5)
- (5) Elevator buttons (x 2) (📖18)
- (6) Elevator feet (x 2) (📖18)
- (7) Remote sensor (📖12)
- (8) Lens (📖59)
- (9) Lens cover (📖3)
- (10) Intake vents
- (11) Filter cover (📖57)  
The air filter and intake vent are inside.
- (12) Speaker (📖36)
- (13) Exhaust vent
- (14) **AC IN** (AC inlet) (📖11)
- (15) Power switch (📖14)
- (16) Rear panel (📖5)
- (17) Security bar (📖11)
- (18) Security slot (📖11)

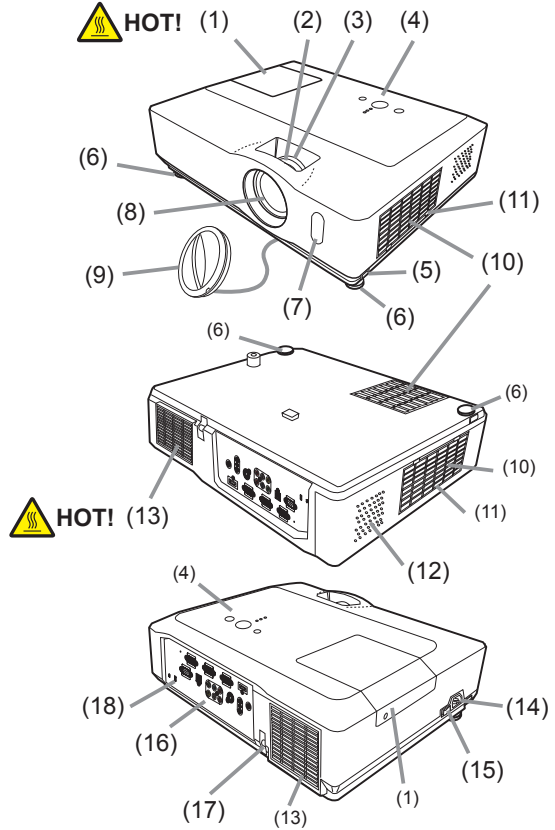

**⚠ WARNING ►HOT!** : Do not touch around the lamp cover and the exhaust vents during use or just after use, since it is too hot.

- Do not look into the lens or vents while the lamp is on, since the strong light is not good for your eyes.
- Do not handle the elevator buttons without holding the projector, since the projector may drop down.

**⚠ CAUTION** ► Maintain normal ventilation to prevent the projector from heating up. Do not cover, block or plug up the vents. Do not place anything that can stick or be sucked to the vents, around the intake vents. Clean the air filter periodically.

- Do not use the security bar and slot to prevent the projector from falling down, since it is not designed for it.

## Control panel

- (1) **STANDBY/ON** button (📖14)
  - (2) **INPUT** button (📖15, 22)
  - (3) **MENU** button (📖22)
- It consists of four cursor buttons.
- (4) **POWER** indicator (📖14, 61)
  - (5) **TEMP** indicator (📖61)
  - (6) **LAMP** indicator (📖61)

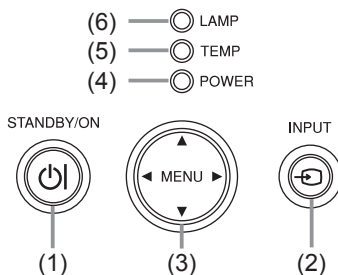

## Rear panel (📖9)

- (1) **AUDIO IN1** port
- (2) **AUDIO IN2** port
- (3) **AUDIO OUT** port
- (4) **COMPUTER IN1** port
- (5) **COMPUTER IN2** port
- (6) **MONITOR OUT** port
- (7) Shutdown switch (📖62)
- (8) **CONTROL** port
- (9) **USB** port
- (10) **COMPONENT** (Y, Cb/Pb, Cr/Pr) ports
- (11) **VIDEO** port
- (12) **S-VIDEO** port
- (13) **AUDIO IN3 (L,R)** ports
- (14) **HDMI** port

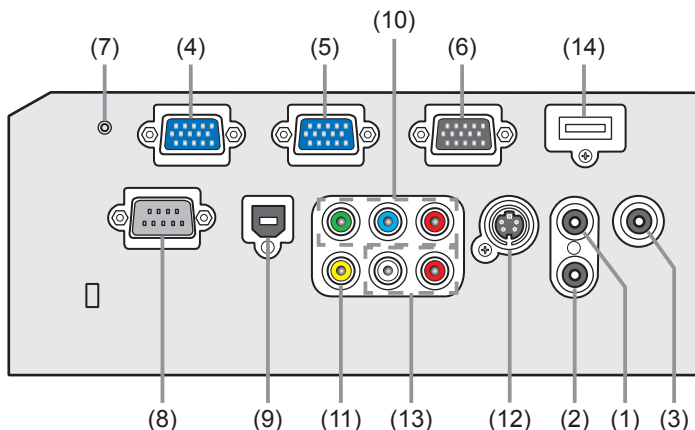

**⚠ CAUTION** ▶ Use the shutdown switch only when the projector is not turned off by normal procedure, since pushing this switch stops operation of the projector without cooling it down.

## Remote control

- (1) **VIDEO** button (📖16)
- (2) **COMPUTER** button (📖15)
- (3) **SEARCH** button (📖17)
- (4) **STANDBY/ON** button (📖14)
- (5) **ASPECT** button (📖17)
- (6) **AUTO** button (📖19)
- (7) **BLANK** button (📖21)
- (8) **MAGNIFY - ON** button (📖20)
- (9) **MAGNIFY - OFF** button (📖13, 20)
- (10) **MY SOURCE/DOC.CAMERA** button (📖16, 43)
- (11) **VOLUME -** button (📖15)
- (12) **PAGE UP** button (📖13)
- (13) **PAGE DOWN** button (📖13)
- (14) **VOLUME +** button (📖15)
- (15) **MUTE** button (📖15)
- (16) **FREEZE** button (📖21)
- (17) **MY BUTTON - 1** button (📖43)
- (18) **MY BUTTON - 2** button (📖43)
- (19) **KEYSTONE** button (📖20)
- (20) **POSITION** button (📖19, 22)
- (21) **MENU** button (📖22)
- (22) **▲/▼/◀/▶** cursor buttons (📖13, 22, 23)
- (23) **ENTER** button (📖13, 22, 23)
- (24) **ESC** button (📖13, 22)
- (25) **RESET** button (📖13, 22, 23)
- (26) Battery cover (📖12)

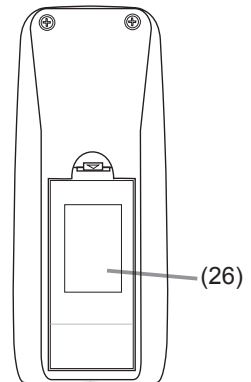
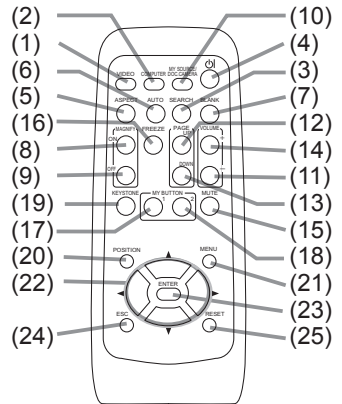

Back of  
the remote control

## Setting up

Install the projector according to the environment and manner the projector will be used in.

### Arrangement

Refer to the illustrations and tables below to determine screen size and projection distance.

The values shown in the table are calculated for a full size screen: 1280×800

(a) Screen size (diagonal)

(b) Projection distance ( $\pm 10\%$ )

(c1), (c2) Screen height ( $\pm 10\%$ )

#### On a horizontal surface

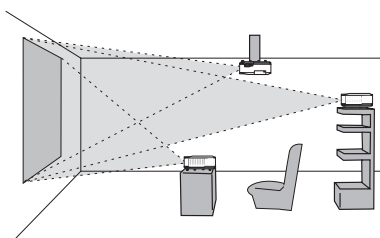
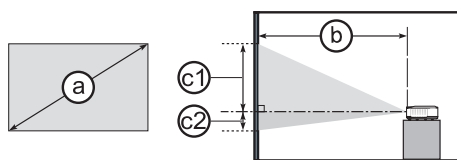

#### Suspended from the ceiling

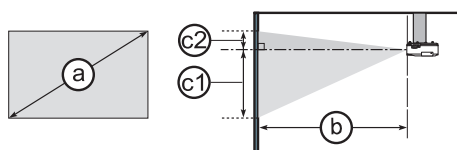

- Keep a space of 30 cm or more between the sides of the projector and other objects such as walls.
- Consult with your dealer before a special installation such as suspending from a ceiling.

(a) Screen size (diagonal)		16 : 10 screen								4 : 3 screen							
		(b) Projection distance				(c1) Screen height		(c2) Screen height		(b) Projection distance				(c1) Screen height		(c2) Screen height	
type (inch)	m	min.		max.		cm		inch		min.		max.		cm		inch	
		m	inch	m	inch	cm	inch	cm	inch	m	inch	m	inch	cm	inch	cm	inch
30	0.8	0.9	36	1.1	44	40	16	1	0	1.1	41	1.3	50	45	18	1	0
40	1.0	1.2	49	1.5	59	53	21	1	0	1.4	56	1.7	67	60	24	1	0
50	1.3	1.6	61	1.9	74	66	26	1	1	1.8	70	2.1	84	75	31	2	1
60	1.5	1.9	74	2.3	89	79	31	2	1	2.1	84	2.6	101	90	37	2	1
70	1.8	2.2	86	2.6	104	92	36	2	1	2.5	98	3.0	118	105	43	2	1
80	2.0	2.5	99	3.0	119	106	42	2	1	2.8	112	3.4	135	119	49	2	1
90	2.3	2.8	111	3.4	134	119	47	2	1	3.2	126	3.9	152	134	55	3	1
100	2.5	3.1	124	3.8	149	132	52	3	1	3.6	140	4.3	169	149	61	3	1
120	3.0	3.8	149	4.5	179	158	62	3	1	4.3	169	5.1	203	179	74	4	1
150	3.8	4.7	186	5.7	224	198	78	4	2	5.4	211	6.4	254	224	92	5	2
200	5.1	6.3	249	7.6	299	264	104	5	2	7.2	282	8.6	338	299	123	6	2
250	6.4	7.9	311	9.5	374	330	130	7	3	9.0	352	10.8	423	373	153	8	3
300	7.6	9.5	374	11.4	449	396	156	8	3	10.7	423	12.9	508	448	184	9	4

**Arrangement (continued)**

**⚠ WARNING** ► Place the projector in a stable horizontal position. If the projector falls or is knocked over, it could cause injury and/or damage to the projector. Using a damaged projector could then result in fire and/or electric shock.

- Do not place the projector on an unstable, slanted or vibrational surface such as a wobbly or inclined stand.
  - Do not place the projector on its side, front or rear position.
  - Consult with your dealer before a special installation such as suspending from a ceiling or somewhere else.
- Place the projector in a cool place, and ensure that there is sufficient ventilation. The high temperature of the projector could cause fire, burns and/or malfunction of the projector.
- Do not stop-up, block or otherwise cover the projector's vents.
  - Keep a space of 30 cm or more between the sides of the projector and other objects such as walls.
  - Do not place the projector on metallic thing or anything weak in heat.
  - Do not place the projector on carpet, cushions or bedding.
  - Do not place the projector in direct sunlight or near hot objects such as heaters.
  - Do not place anything near the projector lens or vents, or on top of the projector.
  - Do not place anything that may be sucked into or stick to the vents on the bottom of the projector. This projector has some intake vents also on the bottom.
- Do not place the projector anyplace where it may get wet. Getting the projector wet or inserting liquid into the projector could cause fire, electric shock and/or malfunction of the projector.
- Do not place the projector in a bathroom or the outdoors.
  - Do not place anything containing liquid near the projector.

**⚠ CAUTION** ► Avoid placing the projector in smoky, humid or dusty place. Placing the projector in such places could cause fire, electric shock and/or malfunction of the projector.

- Do not place the projector near humidifiers, smoking spaces or a kitchen.
- Position the projector to prevent light from directly hitting the projector's remote sensor.



## Connecting your devices

Be sure to read the manuals for devices before connecting them to the projector. Make sure that all the devices are suitable to be connected with this product, and prepare the cables required to connect. Please refer to the following illustrations to connect them.

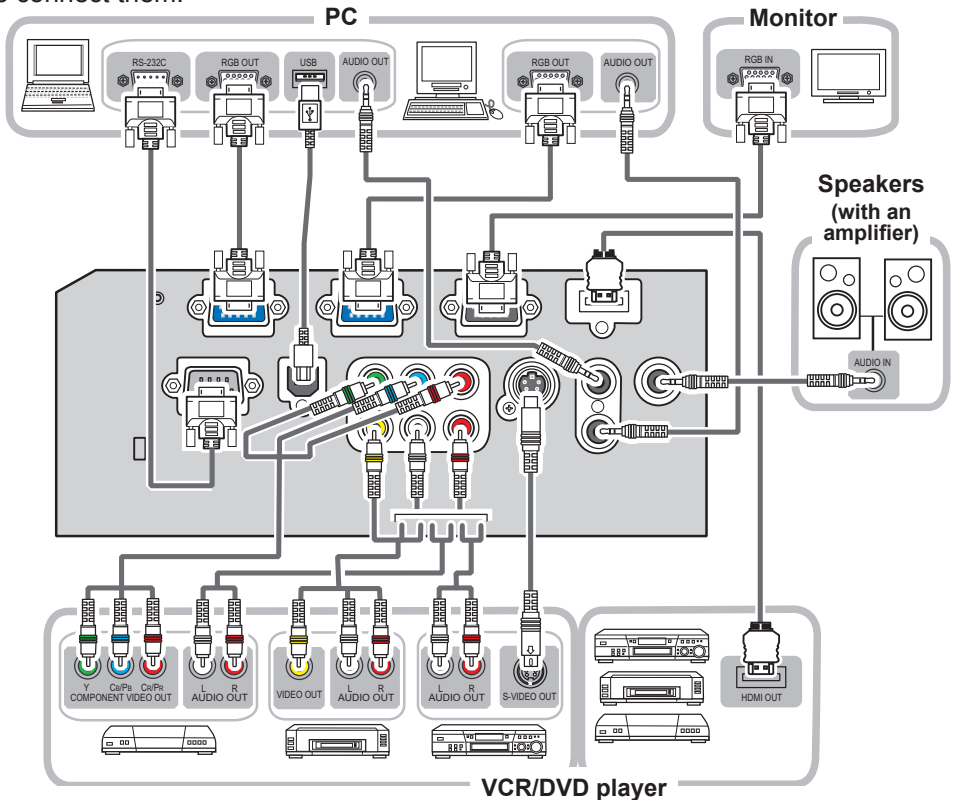

- ▲ **WARNING** ▶ Do not disassemble or modify the projector and accessories.
- ▶ Be careful not to damage the cables, and do not use damaged cables.
- ▲ **CAUTION** ▶ Turn off all devices and unplug their power cords prior to connecting them to projector. Connecting a live device to the projector may generate extremely loud noises or other abnormalities that may result in malfunction or damage to the device and the projector.
- ▶ Use appropriate accessory or designated cables. Ask your dealer about non-accessory cables which may be required a specific length or a ferrite core by the regulations. For cables with a core only at one end, connect the end with the core to the projector.
- ▶ Make sure that devices are connected to the correct ports. An incorrect connection may result in malfunction or damage to the device and the projector.

## Connecting your devices (continued)

**NOTE** • Be sure to read the manuals for devices before connecting them to the projector, and make sure that all the devices are suitable to be connected with this product. Before connecting to a PC, check the signal level, the signal timing, and the resolution.

- Some signal may need an adapter to input this projector.
- Some PCs have multiple screen display modes that may include some signals which are not supported by this projector.
- Although the projector can display signals with resolution up to UXGA (1600X1200), the signal will be converted to the projector's panel resolution before being displayed. The best display performance will be achieved if the resolutions of the input signal and the projector panel are identical.
- While connecting, make sure that the shape of the cable's connector fits the port to connect with. And be sure to tighten the screws on connectors with screws.
- When connecting a laptop PC to the projector, be sure to activate the PC's external RGB output. (Set the laptop PC to CRT display or to simultaneous LCD and CRT display.) For details on how this is done, please refer to the instruction manual of the corresponding laptop PC.
- When the picture resolution is changed on a PC depending on an input, automatic adjustment function may take some time and may not be completed. In this case, you may not be able to see a check box to select "Yes/No" for the new resolution on Windows. Then the resolution will go back to the original. It might be recommended to use other CRT or LCD monitors to change the resolution.
- In some cases, this projector may not display a proper picture or display any picture on screen. For example, automatic adjustment may not function correctly with some input signals. An input signal of composite sync or sync on G may confuse this projector, so the projector may not display a proper picture.
- The **HDMI** port of this model is compatible with HDCP (High-bandwidth Digital Content Protection) and therefore capable of displaying a video signal from HDCP compatible DVD players or the like.

### About Plug-and-Play capability

Plug-and-Play is a system composed of a PC, its operating system and peripheral equipment (i.e. display devices). This projector is VESA DDC 2B compatible. Plug-and-Play can be used by connecting this projector to a PC that is VESA DDC (display data channel) compatible.

- Take advantage of this feature by connecting an RGB cable to the **COMPUTER IN1** port (DDC 2B compatible). Plug-and-Play may not work properly if any other type of connection is attempted.
- Please use the standard drivers in your PC as this projector is a Plug-and-Play monitor.

### NOTE for HDMI

- The **HDMI** supports the following signals.
  - Video signal : 480i@60,480p@60,576i@50,720p@50/60,1080i@50/60,1080p@50/60
  - PC signals : See Operating Guide - Technical
  - Audio signal : Format Linear PCM  
Sampling Frequency 48kHz / 44.1kHz / 32kHz
- This projector can be connected with another equipment that has HDMI or DVI connector, but with some equipment the projector may not work properly, something like no video or no audio.
- Be sure to use an HDMI cable that has the HDMI logo.
- When the projector is connected with a device having DVI connector, use a DVI to HDMI cable to connect with the **HDMI** input and an audio cable to connect with one of the **AUDIO** input.

## Connecting power supply

At first, make sure that the power switch of the projector is set to OFF position (marked “O”).

1. Put the connector of the power cord into the **AC IN** (AC inlet) of the projector.
2. Firmly plug the power cord's plug into the outlet.

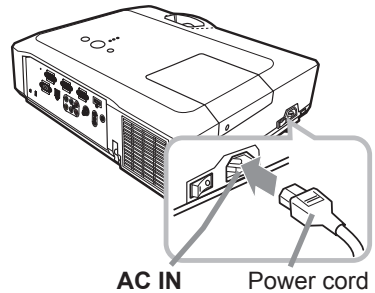

**⚠ WARNING** ▶ Please use extra caution when connecting the power cord, as incorrect or faulty connections may result in fire and/or electrical shock.

- Only use the power cord that came with the projector. If it is damaged, consult your dealer to get a new one.
- Only plug the power cord into an outlet whose voltage is matched to the power cord. The power outlet should be close to the projector and easily accessible. Remove the power cord for complete separation.
- Never modify the power cord.

## Using the security bar and slot

A commercial anti-theft chain or wire up to 10 mm in diameter can be attached to the security bar on the projector.

Also this product has the security slot for the Kensington lock.

For details, see the manual of the security tool.

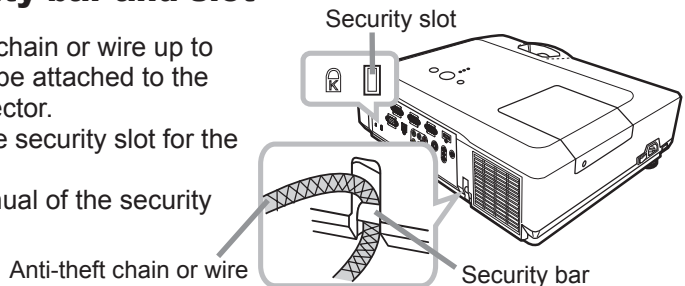

**⚠ WARNING** ▶ Do not use the security bar and slot to prevent the projector from falling down, since it is not designed for it.

**⚠ CAUTION** ▶ Do not place anti-theft chain or wire near the exhaust vents. It may become too hot.

**NOTE** • The security bar and slot is not comprehensive theft prevention measures. It is intended to be used as supplemental theft prevention measure.

## Remote control

**Installing the batteries**

Please insert the batteries into the remote control before using it. If the remote control starts to malfunction, try to replace the batteries. If you will not use the remote control for long period, remove the batteries from the remote control and store them in a safe place.

1. Holding the hook part of the battery cover, remove it.
2. Align and insert the two AA batteries (**HITACHI MAXELL, Part No. LR6 or R6P**) according to their plus and minus terminals as indicated in the remote control.
3. Replace the battery cover in the direction of the arrow and snap it back into place.

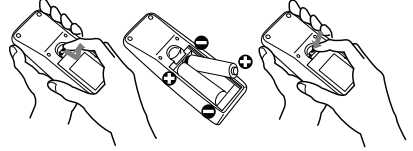

**⚠ WARNING** ▶ Always handle the batteries with care and use them only as directed. Improper use may result in battery explosion, cracking or leakage, which could result in fire, injury and/or pollution of the surrounding environment.

- Be sure to use only the batteries specified. Do not use batteries of different types at the same time. Do not mix a new battery with used one.
- Make sure the plus and minus terminals are correctly aligned when loading a battery.
- Keep a battery away from children and pets.
- Do not recharge, short circuit, solder or disassemble a battery.
- Do not place a battery in a fire or water. Keep batteries in a dark, cool and dry place.
- If you observe battery leakage, wipe out the leakage and then replace a battery. If the leakage adheres to your body or clothes, rinse well with water immediately.
- Obey the local laws on disposing the battery.

**About the remote control signal**

The remote control works with the projector's remote sensor. This projector has a remote sensor on the front. The sensor senses the signal within the following range when the sensor is active:

60 degrees (30 degrees to the left and right of the sensor) within 3 meters about.

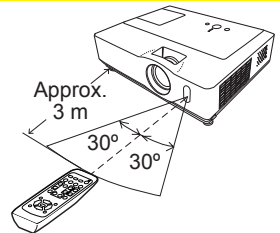

**NOTE** • The remote control signal reflected in the screen or the like may be available. If it is difficult to send the signal to the sensor directly, attempt to make the signal reflect.

- The remote control uses infrared light to send signals to the projector (Class 1 LED), so be sure to use the remote control in an area free from obstacles that could block the remote control's signal to the projector.
- The remote control may not work correctly if strong light (such as direct sun light) or light from an extremely close range (such as from an inverter fluorescent lamp) shines on the remote sensor of the projector. Adjust the position of projector avoiding those lights.

## Changing the frequency of remote control signal

The accessory remote control has the two choices on signal frequency Mode 1:NORMAL and Mode 2:HIGH. If the remote control does not function properly, attempt to change the signal frequency. In order to set the Mode, please keep pressing the combination of two buttons listed below simultaneously for about 3 seconds.

- (1) Set to Mode 1:NORMAL... **VOLUME -** and **RESET** buttons
- (2) Set to Mode 2:HIGH... **MAGNIFY OFF** and **ESC** buttons

Please remember that the REMOTE FREQ. in the SERVICE item of the OPTION menu (45) of the projector to be controlled should be set to the same mode as the remote control.

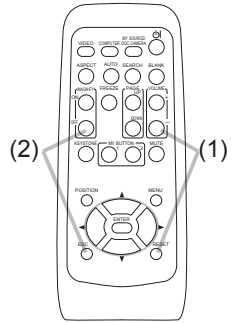

## Using as a simple PC mouse & keyboard

The accessory remote control works as a simple mouse and keyboard of the PC, when the projector's **USB** port (B type) connects with the PC's USB port (A type) port via a mouse cable.

- (1) **PAGE UP** key: Press **PAGE UP** button.
- (2) **PAGE DOWN** key: Press **PAGE DOWN** button.
- (3) **Mouse left** button: Press **ENTER** button.
- (4) **Move pointer**: Use the cursor buttons **▲**, **▼**, **◀** and **▶**.
- (5) **ESC** key: Press **ESC** button.
- (6) **Mouse right** button: Press **RESET** button.

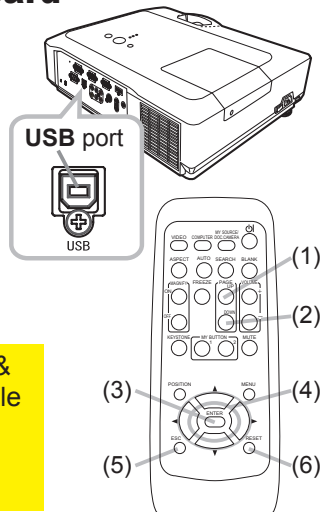

**⚠ WARNING** ▶ Improper use of the simple mouse & keyboard function could damage your equipment. While using this function, please connect this product only to a PC. Be sure to check your PC's manuals before connecting this product to the PC.

**NOTE** • When the simple mouse & keyboard function of this product does not work correctly, please check the following.

- When a USB cable connects this projector with a PC having a built-in pointing device (e.g. track ball) like a notebook PC, open BIOS setup menu, then select the external mouse and disable the built-in pointing device, because the built-in pointing device may have priority to this function.
- Windows 95 OSR 2.1 or higher is required for this function. And also this function may not work depending on the PC's configurations and mouse drivers. This function can work with the PC which can operate general USB mouse or keyboard.
- You cannot do things like press two buttons at once (for instance, pressing two buttons at the same time to move the mouse pointer diagonally).
- This function is activated only when the projector is working properly. This function is not available while the lamp is warming up (the **POWER** indicator blinks green), and while adjusting the volume and display, correcting for keystone, zooming in on the screen, using the **BLANK** function, or displaying the menu screen.

## Power on/off

## Turning on the power

1. Make sure that the power cord is firmly and correctly connected to the projector and the outlet.
2. Remove the lens cover, and set the power switch to ON position (marked "I").  
The **POWER** indicator will light up in steady orange (📖61). Then wait several seconds because the buttons may not function for these several seconds.
3. Press **STANDBY/ON** button on the projector or the remote control.  
The projection lamp will light up and **POWER** indicator will begin blinking in green. When the power is completely on, the indicator will stop blinking and light in steady green (📖61).

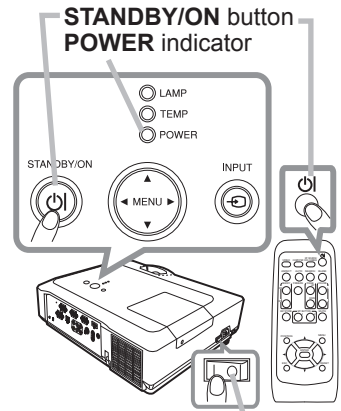

Power switch

To display the picture, select an input signal according to the section "Selecting an input signal" (📖15).

## Turning off the power

1. Press the **STANDBY/ON** button on the projector or the remote control. The message "Power off?" will appear on the screen for about 5 seconds.
2. Press the **STANDBY/ON** button again while the message appears.  
The projector lamp will go off, and the **POWER** indicator will begin blinking in orange. Then **POWER** indicator will stop blinking and light in steady orange when the lamp cooling is complete (📖61).
3. Make sure that **POWER** indicator lights in steady orange, and set the power switch to OFF position (marked "O").  
**POWER** indicator will go off. Attach the lens cover.

Do not turn the projector on for about 10 minutes or more after turning it off. Turning the projector on again too soon could shorten the lifetime of some consumable parts of the projector.



Power switch

**⚠ WARNING** ▶ A strong light is emitted when the projector's power is on. Do not look into the lens of the projector or look inside of the projector through any of the projector's openings.  
▶ Do not touch around the lamp cover and the exhaust vents during use or just after use, since it is too hot.

**NOTE** • Turn the power on/off in right order. Please power on the projector prior to the connected devices.  
• When the AUTO ON of the OPTION menu is set to the TURN ON, and the power was turned off by the power switch last time, turning the power switch on makes the projection lamp light on without pushing the **STANDBY/ON** button (📖41).  
• Use the shutdown switch (📖62) only when the projector is not turned off by normal procedure.

## Operating

### Adjusting the volume

VOLUME +/- button

- Use the **VOLUME +/VOLUME -** buttons to adjust the volume.
  - A dialog will appear on the screen to aid you in adjusting the volume. If you do not do anything, the dialog will automatically disappear after a few seconds.
  - When  $\times$  is selected for current picture input port, the volume adjustment is disabled. Please see AUDIO item of AUDIO menu (📖36).
  - When the projector is in the standby mode, the volume can be adjusted if  $\times$  is not selected for the AUDIO OUT STANDBY of AUDIO (📖36).

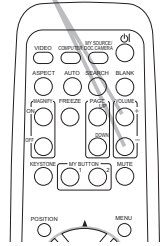

### Temporarily muting the sound

- Press **MUTE** button on the remote control.
  - A dialog will appear on the screen indicating that you have muted the sound. To restore the sound, press the **MUTE**, **VOLUME +** or **VOLUME -** button. Even if you do not do anything, the dialog will automatically disappear after a few seconds.
  - When  $\times$  is selected for current picture input port, the sound is always muted. Please see AUDIO item of AUDIO menu (📖36).
  - When the sound is muted while a signal from **VIDEO**(NTSC), **S-VIDEO**(NTSC), **COMPONENT**(480i@60), **COMPUTER IN1** (480i@60) or **COMPUTER IN2**(480i@60) port is selected, the C.C. (Closed Caption) is automatically activated if the DISPLAY item of the C.C. menu is set to AUTO and the input signal supports the C.C. feature (📖54).

MUTE button

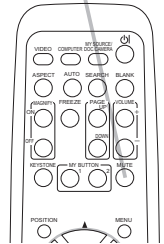

### Selecting an input signal

- Press **INPUT** button on the projector.
  - Each time you press the button, the projector switches its input port from the current port as below.



- While TURN ON is selected for AUTO SEARCH item in OPTION menu (📖41), the projector will keep checking the ports in above order repeatedly till an input signal is detected.

INPUT button

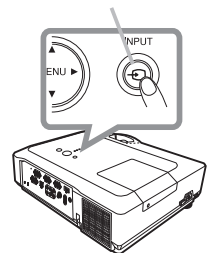

(continued on next page)

## Selecting an input signal (continued)

1. Press **COMPUTER** button on the remote control.
  - Each time you press the button, the projector switches its input port from the current port as below.

→ COMPUTER IN 1 → COMPUTER IN 2 → HDMI

- While **TURN ON** is selected for **AUTO SEARCH** item in **OPTION** menu, the projector will keep checking every port sequentially till an input signal is detected (44). If **COMPUTER** button is pushed when **VIDEO**, **S-VIDEO** or **COMPONENT** port is selected, the projector will check **COMPUTER IN1** port first.

**COMPUTER** button

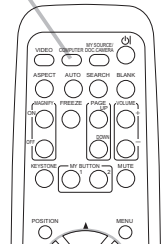

1. Press **VIDEO** button on the remote control.
  - Each time you press the button, the projector switches its input port from the current port as below.

COMPONENT (Y, Cb/Pb, Cr/Pr) → S-VIDEO → VIDEO



- While **TURN ON** is selected for **AUTO SEARCH** item in **OPTION** menu, the projector will keep checking every port sequentially till an input signal is detected (44). If **VIDEO** button is pushed when **COMPUTER IN1**, **COMPUTER IN2** or **HDMI** port is selected, the projector will check **COMPONENT** port first.

**VIDEO** button

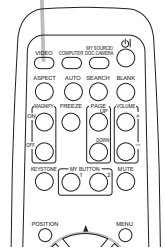

1. Press the **MY SOURCE / DOC. CAMERA** button on the remote control. The input signal will be changed into the signal you set as **MY SOURCE** (43).

- This function also can use for document camera. Select the input port that connected the document camera.

**MY SOURCE / DOC. CAMERA** button

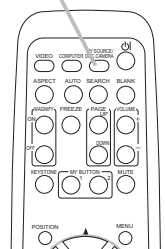



## Searching an input signal

1. Press **SEARCH** button on the remote control.
  - The projector will start to check its input ports as below in order to find any input signals.  
When an input is found, the projector will stop searching and display the image. If no signal is found, the projector will return to the state selected before the operation.



- While **TURN ON** is selected for **AUTO SEARCH** item in **OPTION** menu (41), the projector will keep checking the ports in above order repeatedly till an input signal is detected.

SEARCH button

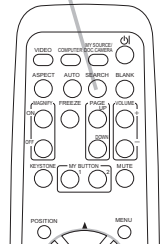

## Selecting an aspect ratio

1. Press **ASPECT** button on the remote control.
  - Each time you press the button, the projector switches the mode for aspect ratio in turn.

○ **For a computer signal**

NORMAL → 4:3 → 16:9 → 16:10 → REAL



○ **For an HDMI signal**

NORMAL → 4:3 → 16:9 → 16:10 → 14:9 → REAL



○ **For a video signal, s-video signal or component video signal**

4:3 → 16:9 → 16:10 → 14:9 → REAL



○ **For no signal**

16:10 (fixed)

- **ASPECT** button does not work when no proper signal is inputted.
- **NORMAL** mode keeps the original aspect ratio setting.

ASPECT button

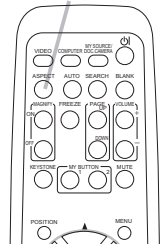

## Adjusting the projector's elevator

When the place to put the projector is slightly uneven to the left or right, use the elevator feet to place the projector horizontally.

Using the feet can also tilt the projector in order to project at a suitable angle to the screen, elevating the front side of the projector within 10 degrees.

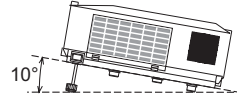

This projector has 2 elevator feet and 2 elevator buttons. An elevator foot is adjustable while pushing the elevator button on the same side as it.

1. Holding the projector, push the elevator buttons to loose the elevator feet.
2. Position the front side of the projector to the desired height.
3. Release the elevator buttons in order to lock the elevator feet.
4. After making sure that the elevator feet are locked, put the projector down gently.
5. If necessary, the elevator feet can be manually twisted to make more precise adjustments. Hold the projector when twisting the feet.

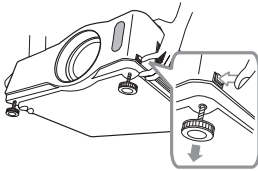

To loose an elevator foot, push the elevator button on the same side as it.

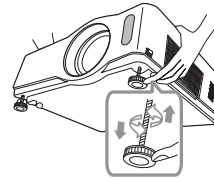

To finely adjust, twist the foot.

**⚠ CAUTION** ► Do not handle the elevator buttons without holding the projector, since the projector may drop down.

► Do not tilt the projector other than elevating its front within 10 degrees using the adjuster feet. A tilt of the projector exceeding the restriction could cause malfunction or shortening the lifetime of consumables, or the projector itself.

## Adjusting the zoom and focus

1. Use the zoom ring to adjust the screen size.
2. Use the focus ring to focus the picture.

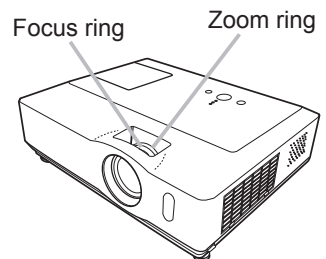

## Using the automatic adjustment feature

1. Press **AUTO** button on the remote control.
  - Pressing this button performs the following.
    - **For a computer signal**

The vertical position, the horizontal position and the horizontal phase will be automatically adjusted.  
 Make sure that the application window is set to its maximum size prior to attempting to use this feature. A dark picture may still be incorrectly adjusted. Use a bright picture when adjusting.
    - **For a video signal and s-video signal**

The video format best suited for the respective input signal will be selected automatically. This function is available only when the **AUTO** is selected for the **VIDEO FORMAT** item in the **INPUT** menu (☰32). The vertical position and horizontal position will be automatically set to the default.
    - **For a component video signal**

The vertical position, horizontal position and horizontal phase will be automatically set to the default.
  - The automatic adjustment operation requires approx. 10 seconds. Also please note that it may not function correctly with some input. When this function is performed for a video signal, a certain extra such as a line may appear outside a picture.
  - The items adjusted by this function may vary when the **FINE** or **DISABLE** is selected for the **AUTO ADJUST** item of the **SERVICE** item in the **OPTION** menu (☰44).

**AUTO** button

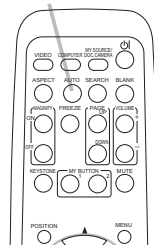

## Adjusting the position

1. Press **POSITION** button on the remote control when no menu is indicated.
  - The “POSITION” indication will appear on the screen.
2. Use the **▲/▼/◀/▶** cursor buttons to adjust the picture position.
  - When you want to reset the operation, press **RESET** button on the remote control during the operation.  
 To complete this operation, press **POSITION** button again.  
 Even if you do not do anything, the dialog will automatically disappear after a few seconds.

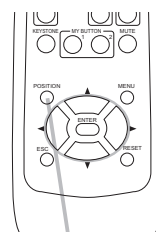

**POSITION** button

- When this function is performed on a video signal, s-video signal or component video signal, some image such as an extra-line may appear at outside of the picture.
- When this function is performed on a video signal, s-video signal or component video signal, the range of this adjustment depends on **OVER SCAN** in **IMAGE** menu (☰29) setting. It is not possible to adjust when **OVER SCAN** is set to 10.
- If **POSITION** button is pressed when a menu is indicated on screen, the displayed picture does not move its position but the menu does.
- This function can not be performed on a **HDMI** signal.

## Correcting the keystone distortions

### KEYSTONE button

1. Press **KEYSTONE** button on the remote control. A dialog will appear on the screen to aid you in correcting the distortion.
 
2. Use the ▲/▼ cursor buttons to select **AUTO** or **MANUAL** operation, and press the ► button to perform the following.
  - (1) **AUTO** executes automatic vertical keystone correction.
  - (2) **MANUAL** displays a dialog for keystone correction.
 

Use the ▲/▼ buttons for adjustment.

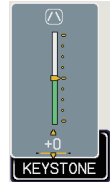
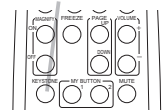

To close the dialog and complete this operation, press **KEYSTONE** button again. Even if you do not do anything, the dialog will automatically disappear after a few seconds.

- The adjustable range of this correction will vary among inputs. For some input, this function may not work well.
- When V:INVERT or H&V:INVERT is selected to the MIRROR item in the SETUP menu, if the projector screen is inclined or angled downward, this function may not work correctly.
- When the zoom adjustment is set to the TELE (telephoto focus), the automatic keystone distortion correction may be excessive. This function should be used when the zoom adjustment is set to the full WIDE (wide-angle focus) whenever possible.
- When the projector is placed on the level (about  $\pm 3^\circ$ ), the automatic keystone distortion correction may not work.
- When the projector is inclined to near  $\pm 30$  degree or over, this function may not work well.
- This function will be unavailable when Transition Detector is on (  50).

## Using the magnify feature

### MAGNIFY ON/OFF button

1. Press the **ON** button of **MAGNIFY** on the remote control.
    - The “MAGNIFY” indication will appear on the screen and the projector will go into the MAGNIFY mode. When the **ON** button of **MAGNIFY** is pressed first after the projector is started, the picture will be zoomed twice. The indication will disappear in several seconds with no operation.
  2. Use the ▲/▼ cursor buttons to adjust the zoom level.
    - To move the zoom area, press the **POSITION** button in the MAGNIFY mode, then use the ▲/▼/◀/▶ cursor buttons to move the area. And to finalize the zoom area, press the **POSITION** button again.
    - To exit from the MAGNIFY mode and restore the screen to normal, press the **OFF** button of **MAGNIFY** on the remote control.
- The projector automatically exits from the MAGNIFY mode when the input signal is changed or when the display condition is changed.
  - In the MAGNIFY mode, the keystone distortion condition may vary, it will be restored when the projector exits from the MAGNIFY mode.

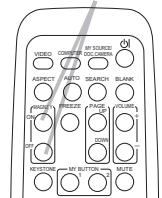

**NOTE**• The zoom level can be finely adjusted. Closely watch the screen to find the level you want.

## Freezing the screen

1. Press the **FREEZE** button on the remote control.
  - The “FREEZE” indication will appear on the screen (however, the indication will not appear when the TURN OFF is selected for the MESSAGE item in the SCREEN menu (📖39)), and the projector will go into the FREEZE mode, which the picture is frozen.  
To exit the FREEZE mode and restore the screen to normal, press the **FREEZE** button again.

**FREEZE** button

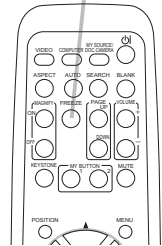

- The projector automatically exits from the FREEZE mode when some control buttons are pressed.
- If the projector continues projecting a still image for a long time, the LCD panel might possibly be burned in. Do not leave the projector in the FREEZE mode for too long.

## Temporarily blanking the screen

1. Press **BLANK** button on the remote control.
  - The BLANK screen will be displayed instead of the screen of input signal. Please refer to BLANK item in SCREEN menu (📖37).  
To exit from the BLANK screen and return to the input signal screen, press **BLANK** button again.
- The projector automatically exits from the BLANK mode when some control buttons are pressed.

**BLANK** button

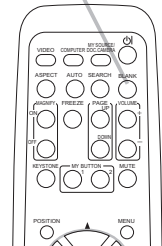

**NOTE** • The sound is not connected with the BLANK screen function. If necessary, set the volume or mute first. To display the BLANK screen and mute the sound at one time, use AV MUTE function (📖43).

## Using the menu function

This projector has the following menus:

PICTURE, IMAGE, INPUT, SETUP, AUDIO, SCREEN, OPTION, C.C. and EASY MENU.

EASY MENU consists of functions often used, and the other menus are classified into each purpose and brought together as the Advanced Menu.

Each of these menus is operated using the same methods. The basic operations of these menus are as follows.

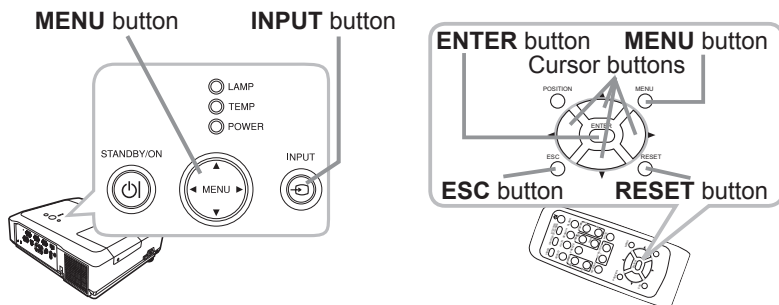

1. Press the **MENU** button on the remote control or the projector.  
The Advanced Menu or EASY MENU, which has priority just after powered on will appear.

If you want to move the menu position, use the cursor buttons after pressing the **POSITION** button. While the projector is displaying any menu, the **MENU** button on the projector works as the cursor buttons.

### In the EASY MENU

2. If you want to change it to the Advanced Menu, select the Go to Advanced Menu...
3. Use the **▲/▼** cursor buttons to select an item to operate.
4. Use the **◀/▶** cursor buttons to operate the item.



EASY MENU

(continued on next page)

## Using the menu function (continued)

### In the Advanced Menu

2. Use the ▲/▼ cursor buttons to select a menu. If you want to change it to the EASY MENU, select EASY MENU.

Then press the ► cursor button, or **ENTER** button to select an item. The lower layer menu of the selected item will appear.

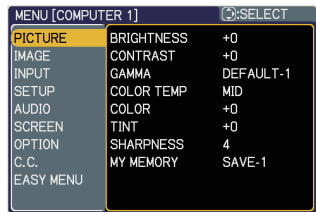

Advanced Menu





3. Use the ▲/▼ cursor buttons to select an item to operate. Then press the ► cursor button, or **ENTER** button to progress. The operation menu of the selected item will appear.
4. Use the ▲/▼ cursor buttons to operate the item.
  - Some functions cannot be performed when a certain input port is selected, or when a certain input signal is displayed.
  - When you want to reset the operation, press **RESET** button on the remote control during the operation. Note that some items (ex. LANGUAGE, H PHASE, VOLUME) cannot be reset.
  - In the Advanced Menu, when you want to return to the previous display, press the ◀ cursor button or **ESC** button on the remote control.
5. Press **MENU** button on the remote control again to close the menu and complete this operation. Even if you do not do anything, the dialog will automatically disappear after about 10 seconds.

## EASY MENU

From the EASY MENU, items shown in the table below can be performed.

Select an item using the ▲/▼ cursor buttons. Then perform it according to the following table.



Item	Description																								
<b>ASPECT</b>	Using the ◀/▶ buttons switches the mode for aspect ratio. See the ASPECT item in IMAGE menu (📖 29).																								
<b>AUTO KEYSTONE EXECUTE</b> 	Using the ▶ button executes the auto keystone function. See AUTO KEYSTONE  EXECUTE item in SETUP menu (📖 34).																								
<b>KEYSTONE</b> 	Using the ◀/▶ buttons corrects the vertical keystone distortion. See KEYSTONE  item in SETUP menu (📖 34).																								
<b>PICTURE MODE</b>	<p>Using the ◀/▶ buttons switches the picture mode. The picture modes are combinations of GAMMA and COLOR TEMP settings. Choose a suitable mode according to the projected source.</p> <p>  </p> <table border="1"> <thead> <tr> <th></th> <th>COLOR TEMP</th> <th>GAMMA</th> </tr> </thead> <tbody> <tr> <td>NORMAL</td> <td>#2 MID</td> <td>#1 DEFAULT</td> </tr> <tr> <td>CINEMA</td> <td>#3 LOW</td> <td>#2 DEFAULT</td> </tr> <tr> <td>DYNAMIC</td> <td>#1 HIGH</td> <td>#3 DEFAULT</td> </tr> <tr> <td>BOARD(BLACK)</td> <td>#4 Hi-BRIGHT-1</td> <td>#4 DEFAULT</td> </tr> <tr> <td>BOARD(GREEN)</td> <td>#5 Hi-BRIGHT-2</td> <td>#4 DEFAULT</td> </tr> <tr> <td>WHITEBOARD</td> <td>#2 MID</td> <td>#5 DEFAULT</td> </tr> <tr> <td>DAYTIME</td> <td>#6 Hi-BRIGHT-3</td> <td>#6 DEFAULT</td> </tr> </tbody> </table> <ul style="list-style-type: none"> <li>• When the combination of GAMMA and COLOR TEMP differs from pre-assigned modes above, the display on the menu for the PICTURE MODE is “CUSTOM”. Please refer to GAMMA (📖 26) and COLOR TEMP (📖 27) items in PICTURE menu.</li> <li>• When this function is performed, a certain extra such as a line may appear.</li> </ul>		COLOR TEMP	GAMMA	NORMAL	#2 MID	#1 DEFAULT	CINEMA	#3 LOW	#2 DEFAULT	DYNAMIC	#1 HIGH	#3 DEFAULT	BOARD(BLACK)	#4 Hi-BRIGHT-1	#4 DEFAULT	BOARD(GREEN)	#5 Hi-BRIGHT-2	#4 DEFAULT	WHITEBOARD	#2 MID	#5 DEFAULT	DAYTIME	#6 Hi-BRIGHT-3	#6 DEFAULT
	COLOR TEMP	GAMMA																							
NORMAL	#2 MID	#1 DEFAULT																							
CINEMA	#3 LOW	#2 DEFAULT																							
DYNAMIC	#1 HIGH	#3 DEFAULT																							
BOARD(BLACK)	#4 Hi-BRIGHT-1	#4 DEFAULT																							
BOARD(GREEN)	#5 Hi-BRIGHT-2	#4 DEFAULT																							
WHITEBOARD	#2 MID	#5 DEFAULT																							
DAYTIME	#6 Hi-BRIGHT-3	#6 DEFAULT																							

(continued on next page)



**EASY MENU (continued)**

Item	Description
<b>BRIGHTNESS</b>	Using the ◀/▶ buttons adjusts the brightness. See BRIGHTNESS item in PICTURE menu (📖26).
<b>CONTRAST</b>	Using the ◀/▶ buttons adjusts the contrast. See CONTRAST item in PICTURE menu (📖26).
<b>COLOR</b>	Using the ◀/▶ buttons adjusts the strength of whole color. See COLOR item in PICTURE menu (📖27).
<b>TINT</b>	Using the ◀/▶ buttons adjusts the tint. See TINT item in PICTURE menu (📖27).
<b>SHARPNESS</b>	Using the ◀/▶ buttons adjusts the sharpness. See SHARPNESS item in PICTURE menu (📖28).
<b>WHISPER</b>	Using the ◀/▶ buttons turns off/on the whisper mode. See WHISPER item in SETUP menu (📖34).
<b>MIRROR</b>	Using the ◀/▶ buttons switches the mode for mirror status. See MIRROR item in SETUP menu (📖35).
<b>RESET</b>	Performing this item resets all of EASY MENU items except FILTER TIME and LANGUAGE. A dialog is displayed for confirmation. Selecting RESET using the ▲ button performs resetting.
<b>FILTER TIME</b>	The usage time of the air filter is shown in the menu. Performing this item resets the filter time which counts usage time of the air filter. A dialog is displayed for confirmation. Selecting RESET using the ▲ button performs resetting. See FILTER TIME item in OPTION menu (📖42).
<b>LANGUAGE</b>	Using the ◀/▶ buttons changes the display language. See LANGUAGE item in SCREEN menu (📖37).
<b>Go to Advanced Menu...</b>	Select Go to Advanced Menu... on the menu, and press the ▶ or <b>ENTER</b> button to use the menu of PICTURE, IMAGE, INPUT, SETUP, AUDIO, SCREEN, OPTION or C.C..

## PICTURE menu

From the PICTURE menu, items shown in the table below can be performed.

Select an item using the ▲/▼ cursor buttons, and press the ► cursor button or **ENTER** button to execute the item. Then perform it according to the following table.

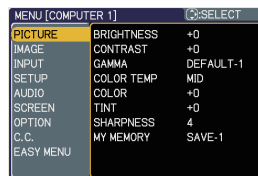

Item	Description
<b>BRIGHTNESS</b>	Using the ▲/▼ buttons adjusts the brightness. Light ⇄ Dark
<b>CONTRAST</b>	Using the ▲/▼ buttons adjusts the contrast. Strong ⇄ Weak
<b>GAMMA</b>	<p>Using the ▲/▼ buttons switches the gamma mode.</p> <p>#1 DEFAULT ⇄ #1 CUSTOM ⇄ #2 DEFAULT ⇄ #2 CUSTOM                      ⇕ ⇕                      #6 CUSTOM #3 DEFAULT                      ⇕ ⇕                      #6 DEFAULT #3 CUSTOM                      ⇕ ⇕                      #5 CUSTOM ⇄ #5 DEFAULT ⇄ #4 CUSTOM ⇄ #4 DEFAULT</p> <p><b>To adjust CUSTOM</b></p> <p>Selecting a mode whose name includes CUSTOM and then pressing the ► button or the <b>ENTER</b> button displays a dialog to aid you in adjusting the mode. This function is useful when you want to change the brightness of particular tones.</p> <p>Choose an item using the ◀/▶ buttons, and adjust the level using the ▲/▼ buttons.</p> <p>You can display a test pattern for checking the effect of your adjustment by pressing the <b>ENTER</b> button. Each time you press the <b>ENTER</b> button, the pattern changes as below.</p> <p>No pattern ⇄ Gray scale of 9 steps ⇐                      ⇑ ⇐ Ramp ⇄ Gray scale of 15 steps</p> <p>The eight equalizing bars correspond to eight tone levels of the test pattern (Gray scale of 9 steps), except the darkest in the left end. If you want to adjust the 2nd tone from left end on the test pattern, use the equalizing adjustment bar "1". The darkest tone at the left end of the test pattern cannot be controlled with any of equalizing adjustment bar.</p> <ul style="list-style-type: none"> <li>• When this function is performed, lines or other distortion may appear.</li> </ul>

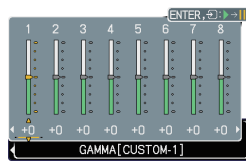

(continued on next page)

PICTURE menu (continued)

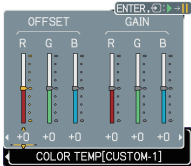
Item	Description
<p><b>COLOR TEMP</b></p>	<p>Using the ▲/▼ buttons switches the color temperature mode.</p> <p>#1 HIGH ⇔ #1 CUSTOM ⇔ #2 MID ⇔ #2 CUSTOM            ⇕            #6 CUSTOM #3 LOW            ⇕            #6 HI-BRIGHT-3 #3 CUSTOM            ⇕            #5 CUSTOM ⇔ #5 HI-BRIGHT-2 ⇔ #4 CUSTOM ⇔ #4 HI-BRIGHT-1</p> <p><b>To adjust CUSTOM</b></p> <p>Selecting a mode whose name includes CUSTOM and then pressing the ► button or the <b>ENTER</b> button displays a dialog to aid you in adjusting the OFFSET and GAIN of the selected mode.</p>  <p>OFFSET adjustments change the color intensity on the whole tones of the test pattern.</p> <p>GAIN adjustments mainly affect color intensity on the brighter tones of the test pattern.</p> <p>Choose an item using the ◀/▶ buttons, and adjust the level using the ▲/▼ buttons.</p> <p>You can display a test pattern for checking the effect of your adjustment by pressing the <b>ENTER</b> button. Each time you press the <b>ENTER</b> button, the pattern changes as below.</p> <p>No pattern ⇔ Gray scale of 9 steps ⇐            ⇐ Ramp ⇔ Gray scale of 15 steps</p> <ul style="list-style-type: none"> <li>• When this function is performed, lines or other distortion may appear.</li> </ul>
<p><b>COLOR</b></p>	<p>Using the ▲/▼ buttons adjusts the strength of whole color.</p> <p>Strong ⇔ Weak</p> <ul style="list-style-type: none"> <li>• This item can be selected only for a video, s-video, component video and HDMI signal.</li> </ul>
<p><b>TINT</b></p>	<p>Using the ▲/▼ buttons adjusts the tint.</p> <p>Greenish ⇔ Reddish</p> <ul style="list-style-type: none"> <li>• This item can be selected only for a video, s-video, component video and HDMI signal.</li> </ul>

(continued on next page)

**PICTURE menu (continued)**

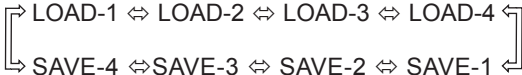

Item	Description
<p><b>SHARPNESS</b></p>	<p>Using the ▲/▼ buttons adjusts the sharpness.</p> <p>Strong ⇄ Weak</p> <ul style="list-style-type: none"> <li>• There may be some noise and/or the screen may flicker for a moment when an adjustment is made. This is not a malfunction.</li> </ul>
<p><b>MY MEMORY</b></p>	<p>This projector has 4 memories for adjustment data (for all the items of PICTURE menu).</p> <p>Selecting a function using the ▲/▼ buttons and pressing the ► or <b>ENTER</b> button performs each function.</p> <div style="text-align: center;">  <p>LOAD-1 ⇄ LOAD-2 ⇄ LOAD-3 ⇄ LOAD-4</p> <p>SAVE-4 ⇄ SAVE-3 ⇄ SAVE-2 ⇄ SAVE-1</p> </div> <p><b><u>LOAD-1, LOAD-2, LOAD-3, LOAD-4</u></b></p> <p>Performing a LOAD function loads the data from the memory linked in the number included in the function's name, and adjusts the picture automatically depending on the data.</p> <ul style="list-style-type: none"> <li>• The LOAD functions whose linked memory has no data are skipped.</li> <li>• Remember that the current adjusted condition will be lost by loading data. If you want to keep the current adjustment, please save it before performing a LOAD function.</li> <li>• There may be some noise and the screen may flicker for a moment when loading data. This is not malfunction.</li> <li>• You can perform the LOAD function using <b>MY BUTTONS</b>. Please see MY BUTTON item in OPTION menu (43).</li> </ul> <p><b><u>SAVE-1, SAVE-2, SAVE-3, SAVE-4</u></b></p> <p>Performing a SAVE function saves the current adjustment data into the memory linked in the number included in the function's name.</p> <ul style="list-style-type: none"> <li>• Remember that the current data being stored of a memory will be lost by saving a new data into the memory.</li> </ul>

## IMAGE menu

From the IMAGE menu, items shown in the table below can be performed.

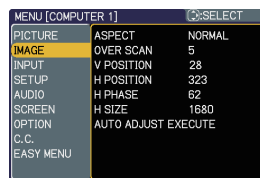
Select an item using the **▲/▼** cursor buttons, and press the **▶** cursor button or **ENTER** button to execute the item. Then perform it according to the following table.



Item	Description
<b>ASPECT</b>	<p>Using the <b>▲/▼</b> buttons switches the mode for aspect ratio.</p> <p><b>For a computer signal</b>            NORMAL ⇄ 4:3 ⇄ 16:9 ⇄ 16:10 ⇄ REAL  </p> <p><b>For an HDMI signal</b>            NORMAL ⇄ 4:3 ⇄ 16:9 ⇄ 16:10 ⇄ 14:9 ⇄ REAL  </p> <p><b>For a video signal, s-video signal or component video signal</b>            4:3 ⇄ 16:9 ⇄ 16:10 ⇄ 14:9 ⇄ REAL  </p> <p><b>For no signal</b>            16:10 (fixed)</p> <ul style="list-style-type: none"> <li>• The NORMAL mode keeps the original aspect ratio of the signal.</li> </ul>
<b>OVER SCAN</b>	<p>Using the <b>▲/▼</b> buttons adjusts the over-scan ratio.</p> <p>Large (It reduces picture) ⇄ Small (It magnifies picture)</p> <ul style="list-style-type: none"> <li>• This item can be selected only for a video, s-video, component video and HDMI signal.</li> <li>• When this adjustment is too large, certain degradation may appear at the frame area of the picture. In such a case, please adjust small.</li> </ul>
<b>V POSITION</b>	<p>Using the <b>▲/▼</b> buttons adjusts the vertical position.</p> <p>Up ⇄ Down</p> <ul style="list-style-type: none"> <li>• Over-adjusting the vertical position may cause noise to appear on the screen. If this occurs, please reset the vertical position to the default setting.</li> </ul> <p>Pressing <b>RESET</b> button when V POSITION is selected will reset V POSITION to the default setting.</p> <ul style="list-style-type: none"> <li>• When this function is performed on a video signal, s-video signal, or component video signal, the range of this adjustment depends on OVER SCAN (<b>above</b>) setting. It is not possible to adjust when OVER SCAN is set to 10.</li> <li>• This item cannot be selected for an HDMI signal.</li> </ul>

(continued on next page)

IMAGE menu (continued)

Item	Description
<p><b>H POSITION</b></p>	<p>Using the ▲/▼ buttons adjusts the horizontal position.                      Left ⇄ Right</p> <ul style="list-style-type: none"> <li>• Over-adjusting the horizontal position may cause noise to appear on the screen. If this occurs, please reset the horizontal position to the default setting. Pressing <b>RESET</b> button when H POSITION is selected will reset H POSITION to the default setting.</li> <li>• When this function is performed on a video signal, s-video signal, or component video signal, the range of this adjustment depends on OVER SCAN (📖29) setting. It is not possible to adjust when OVER SCAN is set to 10.</li> <li>• This item cannot be selected for an HDMI signal.</li> </ul>
<p><b>H PHASE</b></p>	<p>Using the ▲/▼ buttons adjusts the horizontal phase to eliminate flicker.                      Right ⇄ Left</p> <ul style="list-style-type: none"> <li>• This item can be selected only for a computer signal or component video signal.</li> </ul>
<p><b>H SIZE</b></p>	<p>Using the ▲/▼ buttons adjusts the horizontal size.                      Large ⇄ Small</p> <ul style="list-style-type: none"> <li>• This item can be selected only for a computer signal.</li> <li>• When this adjustment is excessive, the picture may not be displayed correctly. In such a case, please reset the adjustment by pressing the <b>RESET</b> button during this operation.</li> </ul>
<p><b>AUTO ADJUST EXECUTE</b></p>	<p>Executing this item performs the automatic adjustment feature.</p> <p><b>For a computer signal</b>                      The vertical position, the horizontal position and the horizontal phase (📖44) will be automatically adjusted. Make sure that the application window is set to its maximum size prior to attempting to use this feature. A dark picture may still be incorrectly adjusted. Use a bright picture when adjusting.</p> <p><b>For a video signal and s-video signal</b>                      The video format best suited for the respective input signal will be selected automatically. This function is available only when the AUTO is selected for the VIDEO FORMAT item in the INPUT menu (📖32). The vertical position and horizontal position will be automatically set to the default.</p> <p><b>For a component video signal</b>                      The vertical position, horizontal position and horizontal phase will be automatically set to the default.</p> <ul style="list-style-type: none"> <li>• The automatic adjustment operation requires approx. 10 seconds. Also please note that it may not function correctly with some input. When this function is performed for a video signal, a certain extra such as a line may appear outside a picture.</li> <li>• The items adjusted by this function may vary when the FINE or DISABLE is selected for the AUTO ADJUST item of the SERVICE item in the OPTION menu (📖44).</li> </ul>

## INPUT menu

From the INPUT menu, items shown in the table below can be performed.

Select an item using the ▲/▼ cursor buttons, and press the ► cursor button or **ENTER** button to execute the item. Then perform it according to the following table.

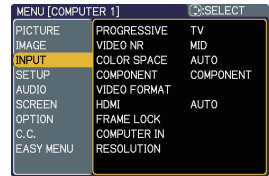

Item	Description
<b>PROGRESSIVE</b>	<p>Using the ▲/▼ buttons switches the progress mode.            TV ⇔ FILM ⇔ TURN OFF            ↑</p> <ul style="list-style-type: none"> <li>• This function is performed only for an interlaced signal at the <b>VIDEO</b> or <b>S-VIDEO</b> input, and for 480i@60 or 576i@50 signal at the <b>COMPONENT</b> or <b>HDMI</b> input.</li> <li>• When TV or FILM is selected, the screen image will be sharp. FILM adapts to the 2-3 Pull-Down conversion system. But these may cause a certain defect (for example, jagged line) of the picture for a quick moving object. In such a case, please select TURN OFF, even though the screen image may lose the sharpness.</li> </ul>
<b>VIDEO NR</b>	<p>Using the ▲/▼ buttons switches the noise reduction mode.            HIGH ⇔ MID ⇔ LOW            ↑</p> <ul style="list-style-type: none"> <li>• This function is performed only for the <b>VIDEO</b> or <b>S-VIDEO</b> input, and for 480i@60 or 576i@50 signal at the <b>COMPONENT</b> or <b>HDMI</b> input.</li> <li>• When this function is excessive, it may cause a certain degradation of the picture.</li> </ul>
<b>COLOR SPACE</b>	<p>Using the ▲/▼ buttons switches the mode for color space.            AUTO ⇔ RGB ⇔ SMPTE240 ⇔ REC709 ⇔ REC601            ↑</p> <ul style="list-style-type: none"> <li>• This item can be selected only for a computer signal or component video signal except SCART RGB signal.</li> <li>• The AUTO mode automatically selects the optimum mode.</li> <li>• The AUTO operation may not work well at some signals. In such a case, it might be good to select a suitable mode except AUTO.</li> </ul>
<b>COMPONENT</b>	<p>Using the ▲/▼ buttons switches the function of the <b>COMPONENT (Y, Cb/Pb, Cr/Pr)</b> port.            COMPONENT ⇔ SCART RGB</p> <p>When the SCART RGB is selected, <b>COMPONENT (Y, Cb/Pb, Cr/Pr)</b> and <b>VIDEO</b> ports will function as a SCART RGB port. A SCART cable is required for a SCART RGB input to the projector. For your reference, see the TECHNICAL part.</p>

(continued on next page)



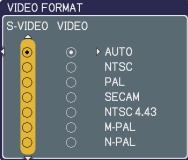
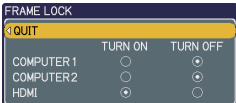
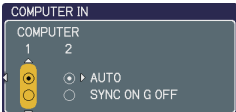

INPUT menu (continued)

Item	Description								
<p><b>VIDEO FORMAT</b></p>	<p>The video format for <b>S-VIDEO</b> port and <b>VIDEO</b> port can be set.</p> <p>(1) Use the ◀/▶ buttons to select the input port.</p> <p>(2) Using the ▲/▼ buttons switches the mode for video format.</p> <p>AUTO ⇔ NTSC ⇔ PAL ⇔ SECAM          ↕ N-PAL ⇔ M-PAL ⇔ NTSC4.43 ↕</p> <ul style="list-style-type: none"> <li>• This item is performed only for a video signal from <b>VIDEO</b> port or <b>S-VIDEO</b> port.</li> <li>• The AUTO mode automatically selects the optimum mode.</li> <li>• The AUTO operation may not work well for some signals. If the picture becomes unstable (e.g. an irregular picture, lack of color), please select the mode according to the input signal.</li> </ul> 								
<p><b>HDMI</b></p>	<p>Using the ▲/▼ cursor buttons changes the HDMI signal mode.</p> <p>AUTO ⇔ NORMAL ⇔ ENHANCED</p> <table border="1" data-bbox="333 679 997 799"> <thead> <tr> <th>Feature</th> <th></th> </tr> </thead> <tbody> <tr> <td>AUTO</td> <td>Selecting the optimum mode automatically</td> </tr> <tr> <td>NORMAL</td> <td>Suitable for DVD signals(16-235)</td> </tr> <tr> <td>ENHANCED</td> <td>Suitable for VGA signals(0-255)</td> </tr> </tbody> </table> <ul style="list-style-type: none"> <li>• If the contrast of the screen image is too strong or too weak, try finding a more suitable mode</li> </ul>	Feature		AUTO	Selecting the optimum mode automatically	NORMAL	Suitable for DVD signals(16-235)	ENHANCED	Suitable for VGA signals(0-255)
Feature									
AUTO	Selecting the optimum mode automatically								
NORMAL	Suitable for DVD signals(16-235)								
ENHANCED	Suitable for VGA signals(0-255)								
<p><b>FRAME LOCK</b></p>	<p>Set the frame lock function on/off for each port.</p> <p>(1) Using the ▲/▼ buttons to select one of following ports.</p> <p>QUIT ⇔ COMPUTER(IN)1 ⇔ COMPUTER(IN)2 ⇔ HDMI</p> <p>(2) Using the ◀/▶ buttons to turns the frame lock function on/off.</p> <p>TURN ON ⇔ TURN OFF</p> <ul style="list-style-type: none"> <li>• This item can be performed only on a signal with a vertical frequency of 50 to 60 Hz.</li> <li>• When the TURN ON is selected, the moving pictures are displayed more smoothly.</li> <li>• This function may cause a certain degradation of the picture. In such a case, please select TURN OFF.</li> </ul> 								
<p><b>COMPUTER IN</b></p>	<p>The computer input signal type for <b>COMPUTER IN1</b> and <b>IN2</b> ports can be set.</p> <p>(1) Use the ◀/▶ buttons to select the input port to be set.</p> <p>COMPUTER (IN)1 ⇔ COMPUTER (IN)2</p> <p>(2) Use the ▲/▼ buttons to select the computer input signal type.</p> <p>AUTO ⇔ SYNC ON G OFF</p> <p>(continued on next page)</p> 								

(continued on next page)

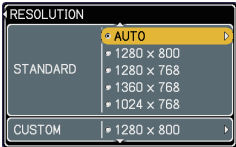

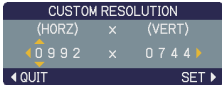
INPUT menu (continued)

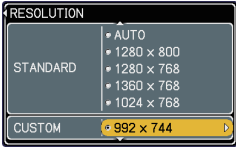
Item	Description
<p><b>COMPUTER IN (continued)</b></p>	<p>Selecting the AUTO mode allows you to input a sync on G signal or component signal from the port.</p> <ul style="list-style-type: none"> <li>In the AUTO mode, the picture may be distorted with certain input signals. In such a case, remove the signal connector so that no signal is received and select the SYNC ON G OFF, and then reconnect the signal.</li> </ul>
<p><b>RESOLUTION</b></p>	<p>The resolution for the <b>COMPUTER IN1</b> and <b>IN2</b> input signals can be set on this projector.</p> <p>(1) In the INPUT menu, select the RESOLUTION using the ▲/▼ buttons and press the ► button. The RESOLUTION menu will be displayed.</p>  <p>(2) In the RESOLUTION menu, select the resolution you wish to display using the ▲/▼ buttons. Selecting AUTO will set a resolution appropriate to the input signal.</p> <p>(3) STANDARD Pressing the ► or <b>ENTER</b> button when selecting a STANDARD resolution will automatically adjust the horizontal and vertical positions, clock phase and horizontal size and automatically select an aspect ratio.</p>  <p>(3) CUSTOM (3)-1 To set a custom resolution, use the ▲/▼ buttons to select the CUSTOM and the CUSTOM RESOLUTION box will be displayed. Set the horizontal (HORZ) and vertical (VERT) resolutions using the ▲/▼/◀/▶ buttons. It is not guaranteed to work this function properly on any resolutions.</p>  <p>(3)-2 To save the setting place the cursor on the right-most digit and press the ► button. The horizontal and vertical positions, clock phase and horizontal size will be automatically adjusted.</p>  <p>(3)-3 To revert back to the previous resolution without saving changes place, the cursor on the left-most digit and press the ◀ button. The screen will then return to the RESOLUTION menu displaying the previous resolution.</p>  <ul style="list-style-type: none"> <li>For some pictures, this function may not work well.</li> </ul>

## SETUP menu

From the SETUP menu, items shown in the table below can be performed.

Select an item using the ▲/▼ cursor buttons, and press the ► cursor button or the **ENTER** button to execute the item. Then perform it according to the following table.

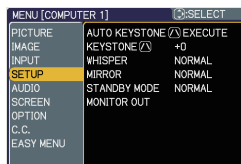

Item	Description
<b>AUTO KEYSTONE EXECUTE</b> [Z]	<p>Selecting this item performs the automatic keystone distortion correction. Projector automatically corrects vertical keystone distortion due to the (forward/backward) setup angle by itself.</p> <p>This function will be executed only once when selected in the menu. When the slant of the projector is changed, execute this function again.</p> <ul style="list-style-type: none"> <li>• The adjustable range for correction will vary among inputs. For some input, this function may not work well.</li> <li>• When V:INVERT or H&amp;V:INVERT is selected to the MIRROR item in the SETUP menu, if the projector screen is inclined or angled downward, this function may not work correctly.</li> <li>• When the zoom adjustment is set to the TELE (telephoto focus), this function may be excessive. This function should be used when the zoom adjustment is set to the full WIDE (wide-angle focus) whenever possible.</li> <li>• When the projector is placed on the level (about <math>\pm 3^\circ</math>), this function may not work.</li> <li>• When the projector is inclined to near <math>\pm 30</math> degree or over, this function may not work well.</li> <li>• This function will be unavailable when the Transition Detector is on (50).</li> </ul>
<b>KEYSTONE</b> [Z]	<p>Using the ▲/▼ buttons corrects the vertical keystone distortion.</p> <p>Shrink the top of the image ⇔ Shrink the bottom of the image</p> <ul style="list-style-type: none"> <li>• The adjustable range of this function will vary with the type of input signal. For some input, this function may not work well.</li> <li>• This function will be unavailable when the Transition Detector is on (50).</li> </ul>
<b>WHISPER</b>	<p>Using the ▲/▼ buttons turns off/on the whisper mode.</p> <p>NORMAL ⇔ WHISPER</p> <ul style="list-style-type: none"> <li>• When WHISPER is selected, acoustic noise and screen brightness are reduced.</li> </ul>

(continued on next page)

SETUP menu (continued)

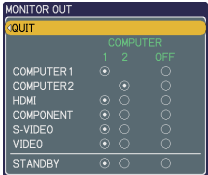
Item	Description
<p><b>MIRROR</b></p>	<p>Using the ▲/▼ buttons switches the mode for mirror status.</p>  <p>NORMAL ⇔ H:INVERT ⇔ V:INVERT ⇔ H&amp;V:INVERT</p> <p>↑</p> <p>If the Transition Detector is TURN ON and MIRROR status is changed, Transition Detector Alarm (🔊50) will be displayed when projector is restarted after the power switch is turned off.</p>
<p><b>STANDBY MODE</b></p>	<p>Using ▲/▼ buttons switches the standby mode setting between NORMAL and SAVING.</p> <p>NORMAL ⇔ SAVING</p> <p>When SAVING is selected, the power consumption in the standby mode is lowered with some functional restriction as below:</p> <ul style="list-style-type: none"> <li>• When SAVING is selected, the RS-232C communication control is disabled except to turn the projector on while the projector is in the standby mode.</li> <li>• When SAVING is selected, AUDIO OUT STANDBY setting of AUDIO (🔊36) is invalid, and no signal is output from <b>AUDIO OUT</b> ports in the standby mode.</li> </ul>
<p><b>MONITOR OUT</b></p>	<p>The combination of a picture shown on screen and output from the <b>MONITOR OUT</b> port can be arranged in the menu.</p> <p>The picture coming into the port selected in the (2) is output to the <b>MONITOR OUT</b> port while an image from the port chosen in the (1) is on screen.</p> <p>(1) Choose a picture input port using ▲/▼ buttons.</p> <p style="text-align: center;">QUIT ⇔ COMPUTER(IN)1 ⇔ COMPUTER(IN)2</p> <p style="text-align: center;">⇕</p> <p>STANDBY <span style="float: right;">HDMI</span></p> <p style="text-align: center;">⇕</p> <p>VIDEO ⇔ S-VIDEO ⇔ COMPONENT (Y, Cb/Pb, Cr/Pr)</p> <p>• Choose STANDBY, to select the output signal from the <b>MONITOR OUT</b> port in the standby mode.</p> <p>• While QUIT is selected, pressing the ◀ button returns to the previous menu.</p> <p>(2) Select one of the <b>COMPUTER IN</b> ports using ◀/▶ buttons.</p> <p>Choosing the COMPUTER 1 allows the following choice.</p> <p style="text-align: center;">1 (COMPUTER IN1) ⇔ OFF</p> <p>Choosing the COMPUTER 2 allows the following choice.</p> <p style="text-align: center;">2 (COMPUTER IN2) ⇔ OFF</p> <p>Choosing other input or STANDBY allows the following choice.</p> <p style="text-align: center;">1 (COMPUTER IN1) ⇔ 2 (COMPUTER IN2) ⇔ OFF</p> <p>↑</p> <p>• OFF disables the <b>MONITOR OUT</b> port.</p> 

## AUDIO menu

From the AUDIO menu, items shown in the table below can be performed. Select an item using the ▲/▼ cursor buttons, and press the ► cursor button or the **ENTER** button to execute the item. Then perform it according to the following table.

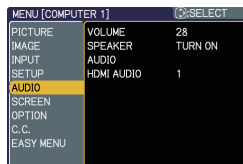

Item	Description
<b>VOLUME</b>	Using the ▲/▼ buttons adjusts the volume. High ⇄ Low
<b>SPEAKER</b>	Using the ▲/▼ buttons turns on/off the built-in speaker. TURN ON ⇄ TURN OFF When TURN OFF is selected, the built-in speaker does not work.
<b>AUDIO</b>	<p>The combination of a picture and audio input port can be arranged in the menu. The audio coming into the port selected in the (2) is output while an image from the port chosen in the (1) is on screen.</p> <p>(1) Choose a picture input port using the ▲/▼ buttons.            QUIT ⇄ COMPUTER(IN)1 ⇄ COMPUTER(IN)2            ⇕            AUDIO OUT STANDBY ⇄ HDMI            ⇕            VIDEO ⇄ S-VIDEO ⇄ COMPONENT            (Y, Cb/Pb, Cr/Pr)</p> <p>• Choose <b>AUDIO OUT STANDBY</b>, to select the audio output to the <b>AUDIO OUT</b> port in the standby mode. The built-in speaker does not work in the standby mode.            • While <b>QUIT</b> is selected, pressing the ◀ button returns to the previous menu.</p> <p>(2) Select one of the <b>AUDIO IN</b> ports using ◀/▶ buttons.            1 (AUDIO IN1) ⇄ 2 (AUDIO IN2) ⇄ 3 (AUDIO IN3) ⇄ ✕ ⇄ H            ⇕            ⇕</p> <p>• H is abbreviation of HDMI.            • H can be selected for <b>HDMI</b> port only. When H is selected, the audio signal to <b>HDMI</b> port will be output if HDMI is chosen as a display source.            • ✕ disables the audio output.            • When ✕ is selected to <b>VIDEO</b>(NTSC), <b>S-VIDEO</b>(NTSC), <b>COMPONENT</b>(480i@60), <b>COMPUTER IN1</b>(480i@60) and <b>COMPUTER IN2</b>(480i@60), the C.C.(Closed Caption) is automatically activated, if the C.C. is set to <b>AUTO</b> in the <b>DISPLAY</b> menu of the C.C. menu and the signal from the input port supports the C.C. feature (📺 54).</p>
<b>HDMI AUDIO</b>	The HDMI AUDIO is set to 1 as default. In case the HDMI audio does not work well, try 2. 1 ⇄ 2

## SCREEN menu

From the SCREEN menu, items shown in the table below can be performed.

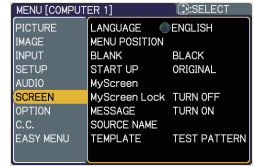

Select an item using the ▲/▼ cursor buttons, and press the ► cursor button or **ENTER** button to execute the item. Then perform it according to the following table.



Item	Description								
<b>LANGUAGE</b>	<p>Using the ▲/▼ buttons switches the OSD (On Screen Display) language.</p> <p>ENGLISH ⇄ FRANÇAIS ⇄ DEUTSCH ⇄ ESPAÑOL ⇄ ITALIANO                      ⇄                      TÜRKÇE                      ⇄                      POLSKI                      ⇄                      SUOMI                      ⇄                      РУССКИЙ ⇄ SVENSKA ⇄ 한글 ⇄ 繁體中文 ⇄ 简体中文 ⇄ 日本語</p>								
<b>MENU POSITION</b>	<p>Using the ▲/▼/◀/▶ buttons adjusts the menu position.                      To quit the operation, press <b>MENU</b> button on the remote control or keep no operation for about 10 seconds.</p>								
<b>BLANK</b>	<p>Using the ▲/▼ buttons switches the mode for the BLANK screen. The BLANK screen is a screen for the temporarily blanking feature (📺21). It is displayed by pressing <b>BLANK</b> button.</p> <p>MyScreen ⇄ ORIGINAL ⇄ BLUE ⇄ WHITE ⇄ BLACK</p> <table border="1" style="margin-left: 40px;"> <thead> <tr> <th></th> <th>Feature</th> </tr> </thead> <tbody> <tr> <td>MyScreen</td> <td>Screen can be registered by the MyScreen item (📺38).</td> </tr> <tr> <td>ORIGINAL</td> <td>Screen preset as the standard screen.</td> </tr> <tr> <td>BLUE, WHITE, BLACK</td> <td>Plain screens in each color.</td> </tr> </tbody> </table> <p>• To avoid remaining as an afterimage, the MyScreen or ORIGINAL screen will change to the plain black screen after several minutes.</p>		Feature	MyScreen	Screen can be registered by the MyScreen item (📺38).	ORIGINAL	Screen preset as the standard screen.	BLUE, WHITE, BLACK	Plain screens in each color.
	Feature								
MyScreen	Screen can be registered by the MyScreen item (📺38).								
ORIGINAL	Screen preset as the standard screen.								
BLUE, WHITE, BLACK	Plain screens in each color.								

(continued on next page)

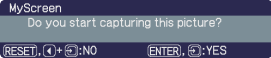
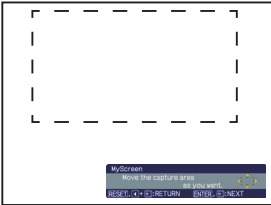
SCREEN menu (continued)

Item	Description								
<p><b>START UP</b></p>	<p>Using the ▲/▼ buttons switches the mode for the start-up screen. The start-up screen is a screen displayed when no signal or an unsuitable signal is detected.</p> <p>MyScreen ⇄ ORIGINAL ⇄ TURN OFF</p>  <table border="1" data-bbox="320 384 1016 528"> <thead> <tr> <th></th> <th>Feature</th> </tr> </thead> <tbody> <tr> <td>MyScreen</td> <td>Screen can be registered by the MyScreen item (see below).</td> </tr> <tr> <td>ORIGINAL</td> <td>Screen preset as the standard screen.</td> </tr> <tr> <td>TURN OFF</td> <td>Plain black screen.</td> </tr> </tbody> </table> <ul style="list-style-type: none"> <li>• To avoid remaining as an afterimage, the MyScreen or ORIGINAL screen will change to the BLANK screen (see 37) after several minutes. If also the BLANK screen is the MyScreen or ORIGINAL, the plain black screen is instead used.</li> <li>• When the TURN ON is selected to the MyScreen PASSWORD of SECURITY item in OPTION menu (see 47), the START UP is fixed to MyScreen.</li> </ul>		Feature	MyScreen	Screen can be registered by the MyScreen item (see below).	ORIGINAL	Screen preset as the standard screen.	TURN OFF	Plain black screen.
	Feature								
MyScreen	Screen can be registered by the MyScreen item (see below).								
ORIGINAL	Screen preset as the standard screen.								
TURN OFF	Plain black screen.								
<p><b>MyScreen</b></p>	<p>This item allows you to capture an image for use as a MyScreen image which can be used as the BLANK screen and START UP screen. Display the image you want to capture before executing the following procedure.</p> <ol style="list-style-type: none"> <li>1. Selecting this item displays a dialog titled "MyScreen". It will ask you if you start capturing an image from the current screen.                      <p>Please wait for the target image to be displayed, and press the <b>ENTER</b> button when the image is displayed. The image will freeze and the frame for capturing will appear. To stop performing, press the <b>RESET</b> or <b>ESC</b> button.</p> </li> <li>2. Using the ▲/▼/◀/▶ buttons adjusts the frame position. Please move the frame to the position of the image which you want to use. The frame may not be able to be moved for some input signals. To start registration, press the <b>ENTER</b> button. To restore the screen and return to the previous dialog, press the <b>RESET</b> or <b>ESC</b> button. Registration takes several minutes.                       </li> </ol> <p>(continued on next page)</p>								

(continued on next page)

## SCREEN menu (continued)

Item	Description
<b>MyScreen</b> (continued)	<p>When the registration is completed, the registered screen and the following message are displayed for several seconds:  <b>“MyScreen registration is finished.”</b></p> <p>If the registration failed, the following message is displayed:  <b>“A capturing error has occurred. Please try again.”</b></p> <ul style="list-style-type: none"> <li>• This item cannot be selected for an HDMI signal.</li> <li>• This function cannot be selected when the TURN ON is selected to the MyScreen Lock item (📖<a href="#">below</a>).</li> <li>• This function cannot be selected when TURN ON is selected to the MyScreen PASSWORD of SECURITY item in OPTION menu (📖<a href="#">47</a>).</li> </ul>
<b>MyScreen Lock</b>	<p>Using the ▲/▼ buttons turns on/off the MyScreen lock function.  TURN ON ⇔ TURN OFF</p> <p>When the TURN ON is selected, the MyScreen item is locked. Use this function for protecting the current MyScreen.</p> <ul style="list-style-type: none"> <li>• This function cannot be selected when TURN ON is selected to the MyScreen PASSWORD of SECURITY item in OPTION menu (📖<a href="#">47</a>).</li> </ul>
<b>MESSAGE</b>	<p>Using the ▲/▼ buttons turns on/off the message function.  TURN ON ⇔ TURN OFF</p> <p>When the TURN ON is selected, the following message function works.</p> <p>“AUTO IN PROGRESS” while automatically adjusting  “NO INPUT IS DETECTED”  “SYNC IS OUT OF RANGE”  “INVALID SCAN FREQ.”  “Searching...” while searching for the input  “Detecting...” while an input signal is detected</p> <p>The indication of the input signal displayed by changing  The indication of the aspect ratio displayed by changing  The indication of the PICTURE MODE displayed by changing  The indication of the MY MEMORY displayed by changing  The indication of “FREEZE” and “II” while the projector is in the FREEZE mode.</p> <ul style="list-style-type: none"> <li>• If the projector goes into the FREEZE mode while the TURN OFF is selected, the picture on screen is frozen without any messages, which is not a malfunction (📖<a href="#">21</a>).</li> </ul>

(continued on next page)

SCREEN menu (continued)

Item	Description
<p><b>SOURCE NAME</b></p>	<p>Each input port for this projector can have a name applied to it.</p> <p>(1) Use the ▲/▼ buttons on the SCREEN menu to select SOURCE NAME and press the ► button. The SOURCE NAME menu will be displayed.</p> <p>(2) Use the ▲/▼ buttons on the SOURCE NAME menu to select the port to be named and press the ► button. Right side of the menu is blank until a name is specified. The SOURCE NAME dialog will be displayed.</p> <p>(3) The current name will be displayed on the first line. Use the ▲/▼/◀/▶ buttons and the <b>ENTER</b> or <b>INPUT</b> button to select and enter characters. The <b>RESET</b> button can be used to erase 1 character at a time. Also if you move the cursor to <b>DELETE</b> or <b>ALL CLEAR</b> on screen and push the <b>ENTER</b> or <b>INPUT</b> button, 1 character or all characters will be erased. The name can be a maximum of 16 characters.</p> <p>(4) To change an already inserted character, press the ▲ button to move the cursor to the first line, and use the ◀/▶ buttons to move the cursor on the character to be changed. After pressing the <b>ENTER</b> or <b>INPUT</b> button, the character is selected. Then, follow the same procedure as described at the item (3) above.</p> <p>(5) To finish entering text, move the cursor to the <b>SAVE</b> on screen and press the <b>ENTER</b> or <b>INPUT</b> button. To revert to the previous name without saving changes, move the cursor to the <b>CANCEL</b> on screen and press the <b>ENTER</b> or <b>INPUT</b> button.</p> <div data-bbox="796 363 1024 491" data-label="Image"> </div> <div data-bbox="788 517 1031 644" data-label="Image"> </div> <div data-bbox="788 683 1031 810" data-label="Image"> </div> <div data-bbox="788 849 1031 976" data-label="Image"> </div>
<p><b>TEMPLATE</b></p>	<p>Using ▲/▼ buttons switches the mode for the template screen. The selected template pattern can be displayed when the <b>MY BUTTON</b> allocated to the TEMPLATE function is pressed (43).</p> <p style="text-align: center;">DOT-LINE4 ⇔ DOT-LINE3 ⇔ DOT-LINE2  <span style="display: inline-block; width: 1em; text-align: center;">⇕</span> <span style="display: inline-block; width: 1em; text-align: center;">⇕</span>          TEST PATTERN ⇔ DOT-LINE1</p>



OPTION menu

From the OPTION menu, items shown in the table below can be performed.

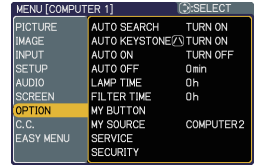

Select an item using the ▲/▼ cursor buttons, and press the ► cursor button or **ENTER** button to execute the item, except for the items LAMP TIME and FILTER TIME. Then perform it according to the following table.



Item	Description
<b>AUTO SEARCH</b>	<p>Using the ▲/▼ buttons turns on/off the automatic signal search function. TURN ON ⇔ TURN OFF</p> <p>When the TURN ON is selected, detecting no signal automatically cycles through input ports in the following order. The search is started from the current port. Then when an input is found, the projector will stop searching and display the image.</p> <p> </p>
<b>AUTO KEYSTONE</b>	<p>Using the ▲/▼ buttons turns on/off the automatic keystone function. TURN ON ⇔ TURN OFF</p> <p>TURN ON : Automatic keystone distortion correction will be executed whenever changing the slant of the projector. TURN OFF : This function is disabled. Please execute the AUTO KEYSTONE  EXECUTE in the SETUP Menu for automatic keystone distortion correction.</p> <ul style="list-style-type: none"> <li>• When the projector is suspended from the ceiling this feature will not function properly so select the TURN OFF.</li> <li>• This function will be unavailable when the Transition Detector is on (50).</li> </ul>
<b>AUTO ON</b>	<p>Using the ▲/▼ buttons turns on/off the AUTO ON function. TURN ON ⇔ TURN OFF</p> <p>When set to the TURN ON, the lamp in projector will be automatically turned on without the usual procedure (14), only when the projector is supplied with the power after the power was cut while the lamp was on.</p> <ul style="list-style-type: none"> <li>• This function does not work as long as the power has been supplied to the projector while the lamp is off.</li> <li>• After turning the lamp on by the AUTO ON function, if neither input nor operation is detected for about 30 minutes, the projector is turned off, even though the AUTO OFF function (42) is disabled.</li> </ul>

(continued on next page)

OPTION menu (continued)

Item	Description
<p><b>AUTO OFF</b></p>	<p>Using the ▲/▼ buttons adjusts the time to count down to automatically turn the projector off.                      Long (max. 99 minutes) ⇔ Short (min. 0 minute = DISABLE)</p> <div style="display: flex; justify-content: space-around; align-items: center;">   </div> <p>When the time is set to 0, the projector is not turned off automatically. When the time is set to 1 to 99, and when the passed time with no-signal or an unsuitable signal reaches at the set time, the projector lamp will be turned off.                      If one of the projector's buttons or the remote control buttons is pressed or one of the commands (except get commands) is transmitted to the <b>CONTROL</b> port during the corresponding time, projector will not be turned off.                      Please refer to the section "Turning off the power" (14).</p>
<p><b>LAMP TIME</b></p>	<p>The lamp time is the usage time of the lamp, counted after the last resetting. It is shown in the OPTION menu.                      Pressing <b>RESET</b> button or the ► button displays a dialog.                      To reset the lamp time, select RESET using the ▲ button.                      RESET ⇔ CANCEL</p> <ul style="list-style-type: none"> <li>• Please reset the lamp time only when you have replaced the lamp, for a suitable indication about the lamp.</li> <li>• For the lamp replacement, see the section "Replacing the lamp" (55).</li> </ul>
<p><b>FILTER TIME</b></p>	<p>The filter time is the usage time of the air filter, counted after the last resetting. It is shown in the OPTION menu.                      Pressing the <b>RESET</b> button or the ► button displays a dialog.                      To reset the filter time, select the RESET using the ▲ button.                      RESET ⇔ CANCEL</p> <ul style="list-style-type: none"> <li>• Please reset the filter time only when you have cleaned or replaced the air filter, for a suitable indication about the air filter.</li> <li>• For the air filter cleaning, see the section "Cleaning and replacing the air filter" (57).</li> </ul>

(continued on next page)



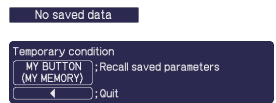

OPTION menu (continued)

Item	Description
<p><b>MY BUTTON</b></p>	<p>This item is to assign one of the following functions to <b>MY BUTTON 1</b> and <b>2</b> on the remote control (116).            Choose 1 or 2 on the MY BUTTON menu using the ◀/▶ button first. Then using the ▲/▼ buttons sets one of the following functions to the chosen button.</p> <ul style="list-style-type: none"> <li>• COMPUTER1: Sets port to <b>COMPUTER IN1</b>.</li> <li>• COMPUTER2: Sets port to <b>COMPUTER IN2</b>.</li> <li>• HDMI: Sets port to <b>HDMI</b>.</li> <li>• COMPONENT: Sets port to <b>COMPONENT (Y, Cb/Pb, Cr/Pr)</b>.</li> <li>• S-VIDEO: Sets port to <b>S-VIDEO</b>.</li> <li>• VIDEO: Sets port to <b>VIDEO</b>.</li> <li>• INFORMATION: Displays the INPUT -INFORMATION- dialog (145).            When an input signal is not found, the dialog is not displayed.</li> <li>• AUTO KEYSTONE (17) :            Performs automatic keystone distortion correction (134).</li> <li>• MY MEMORY: Loads one of adjustment data stored (128).            When more than one data are saved, the adjustment changes every time the <b>MY BUTTON</b> is pushed.            When no data is saved in memory, the dialog “No saved data” appears.            When the current adjustment is not saved to memory, the dialog as shown in the right appears.</li> </ul> <p>If you want to keep the current adjustment, please press the ◀ button to quit. Otherwise loading a data will lose the current adjusted condition.</p> <ul style="list-style-type: none"> <li>• PICTURE MODE: Changes the PICTURE MODE (124).</li> <li>• FILTER RESET: Displays the filter time reset confirmation dialog (142).</li> <li>• AV MUTE: Turns the picture and audio on/off.</li> <li>• TEMPLATE: Makes the template pattern selected to the TEMPLATE item (140) appear or disappear.</li> </ul>
<p><b>MY SOURCE</b></p>	<p>Using ▲/▼ buttons selects the picture input port to be selected with pressing the <b>MY SOURCE/DOC.CAMERA</b> button on the remote control.            Select the picture input that is connected with a document camera.</p> <p>COMPUTER (IN)1 ⇄ COMPUTER (IN)2 ⇄ HDMI            ↕            VIDEO ⇄ S-VIDEO ⇄ COMPONENT ↕</p>
<p><b>SERVICE</b></p>	<p>Selecting this item displays the SERVICE menu.            Select an item using the ▲/▼ buttons, and press the ▶ button or the <b>ENTER</b> button to execute the item.</p> <p>FAN SPEED ⇄ AUTO ADJUST ⇄ GHOST ⇄ FILTER MESSAGE            ⇅            FACTORY RESET ⇄ INFORMATION ⇄ REMOTE FREQ ⇄ KEY LOCK</p>



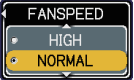

(continued on next page)

OPTION menu (continued)

Item	Description
<p><b>SERVICE</b> (continued)</p>	<p><b>FAN SPEED</b></p> <p>Using the ▲/▼ buttons the rotation speed of the cooling fans. The HIGH is the mode for use at highlands etc. Note that the projector is noisier when the HIGH is selected.</p> <p>HIGH ⇄ NORMAL</p> 
	<p><b>AUTO ADJUST</b></p> <p>Using the ▲/▼ buttons to select one of the mode. When the DISABLE is selected, the automatic adjustment feature is disabled.</p> <p>FINE ⇄ FAST ⇄ DISABLE</p>  <p>↑—————↑</p> <p>FINE: Finer tuning including H.SIZE adjustment. FAST: Faster tuning, setting H.SIZE to prearranged data for the input signal.</p> <ul style="list-style-type: none"> <li>Depending on conditions, such as input image, signal cable to the projector, environment around the projector, etc., the automatic adjustment may not work correctly. In such a case, please choose DISABLE to disable the automatic adjustment, and make adjustment manually.</li> </ul>
	<p><b>GHOST</b></p> <ol style="list-style-type: none"> <li>Select a color element of ghost using the ◀/▶ buttons.</li> <li>Adjust the selected element using the ▲/▼ buttons to disappear ghost.</li> </ol> 
	<p><b>FILTER MESSAGE</b></p> <p>Use the ▲/▼ button to set the timer for the interval to show the message for cleaning up the air filter.</p> <p>500h ⇄ 1000h ⇄ 1500h ⇄ 2000h ⇄ TURN OFF</p> <p>After choosing an item except TURN OFF, the message "REMINDER *** HRS PASSED AFTER THE LAST FILTER CHECK" will appear after the timer reaches the interval time set by this feature (📄 60).</p> <p>When the TURN OFF is chosen, the message will not appear. Utilize this feature to keep the air filter clean, setting the suitable time according to your environment of this projector.</p> <ul style="list-style-type: none"> <li>Please check and clean the air filter periodically, even if there is no message. If the air filter becomes to be blocked by dust or others, the internal temperature will rise, which could cause malfunction, or reduce the lifetime of the projector.</li> <li>Please be careful with the operating environment of the projector and the condition of the air filter.</li> </ul> 



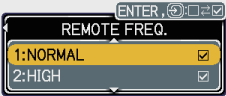

(continued on next page)

OPTION menu (continued)

Item	Description
<p><b>SERVICE</b> (continued)</p>	<p><b>KEY LOCK</b> Using the ▲/▼ buttons turns on/off the key lock feature. When <b>TURN ON</b> is selected, the buttons on the projector except the <b>STANDBY/ON</b> button are locked. TURN ON ⇔ TURN OFF</p> <ul style="list-style-type: none"> <li>• Please use to avoid a mischief and touching accidentally. This function does not have any effect on the remote control.</li> </ul>
	<p><b>REMOTE FREQ.</b> Use the ▲/▼ button to change the projector's remote sensor setting. 1:NORMAL ⇔ 2:HIGH</p> <p>Items with a checkmark are on. The factory default setting is for both 1:NORMAL and 2:HIGH to be on. If the remote control does not function correctly, set this to either only 1 or only 2 (☞13). Neither can be turned off at the same time.</p> 
	<p><b>INFORMATION</b> Selecting this item displays a dialog titled "INPUT -INFORMATION-". It shows the information about the current input.</p>  <ul style="list-style-type: none"> <li>• The "FRAME LOCK" message on the dialog means the frame lock function is working (☞32).</li> <li>• The "SCART RGB" message means the <b>COMPONENT</b> port is working as a SCART RGB input port. Please refer to the <b>COMPONENT</b> item in <b>INPUT</b> menu (☞31).</li> <li>• This item can't be selected for no signal and sync out.</li> <li>• When the <b>MY TEXT DISPLAY</b> is set to <b>TURN ON</b>, the <b>MY TEXT</b> is displayed together with the input information in the <b>INPUT -INFORMATION-</b> box (☞52).</li> </ul>
	<p><b>FACTORY RESET</b> Selecting <b>RESET</b> using the button ▲ performs this function. By this function, all the items in all of menus will collectively return to the initial setting. Note that the items <b>LAMP TIME</b>, <b>FILTER TIME</b>, <b>LANGUAGE</b> and <b>SECURITY</b> settings are not reset. RESET ⇔ CANCEL</p>

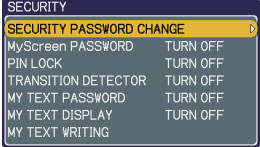
(continued on next page)

OPTION menu (continued)

Item	Description
<p style="text-align: center;"><b>SECURITY</b></p>	<p>This projector is equipped with security functions. User registration is required before using the security functions. Please ask your local dealer.</p>
	<p><b>1. Using Security Features</b></p> <p><b>1.1 Inputting the PASSWORD</b></p> <p>1.1-1 Use the ▲/▼ buttons on the OPTION menu to select SECURITY and press the ► button. The ENTER PASSWORD box will be displayed.                         The factory default PASSWORD is <b>6971</b>. This PASSWORD can be changed (1.2 Changing the PASSWORD (below)).</p> <ul style="list-style-type: none"> <li>It is strongly recommended the factory default PASSWORD to be changed as soon as possible.</li> </ul> <p>1.1-2 Use the ▲/▼/◀/▶ buttons to enter the registered PASSWORD. Move the cursor to the right side of the ENTER PASSWORD box and press the ► button to display the SECURITY menu.                         If an incorrect PASSWORD is input, the ENTER PASSWORD box will be displayed again. If incorrect PASSWORD is input 3 times, the projector will turn off. Afterwards the projector will turn off every time an incorrect PASSWORD is input.</p> <p><b>1.2 Changing the PASSWORD</b></p> <p>1.2-1 Use the ▲/▼ buttons on the SECURITY menu to select SECURITY PASSWORD CHANGE and press the ► button to display the ENTER NEW PASSWORD box.   </p> <p>1.2-2 Use the ▲/▼/◀/▶ buttons to enter the new PASSWORD.</p> <p>1.2-3 Move the cursor to the right side of the ENTER NEW PASSWORD box and press the ► button to display the NEW PASSWORD AGAIN box, enter the same PASSWORD again.   </p> <p>1.2-4 Move the cursor to the right side of the NEW PASSWORD AGAIN box and press the ► button and the NOTE NEW PASSWORD box will be displayed for about 20 seconds, please make note of the PASSWORD during this time.                         Pressing the <b>ENTER</b> button will close the NOTE NEW PASSWORD box.</p> <ul style="list-style-type: none"> <li>Please do not forget your PASSWORD.</li> </ul>

(continued on next page)

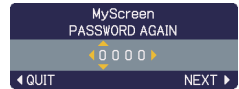

OPTION menu (continued)

Item	Description
<p><b>SECURITY</b> (continued)</p>	<p><b>1.3 If you have forgotten your PASSWORD</b></p> <p>1.3-1 Follow the procedure in 1.1-1 to display the ENTER PASSWORD box.</p> <p>1.3-2 While the ENTER PASSWORD box is displayed, press and hold the <b>RESET</b> button for about 3 seconds, or press and hold the <b>INPUT</b> button for 3 seconds while pressing the ► button on the projector. The 10-digit Inquiring Code will be displayed.</p> <ul style="list-style-type: none"> <li>• If there is no key input for about 55 seconds while the Inquiring Code is displayed, the menu will close. If necessary, repeat the process from 1.3-1.</li> </ul> <p>1.3-3 Contact your dealer with the 10-digit Inquiring Code. Your PASSWORD will be sent after your user registration information is confirmed.</p>
	<p><b>2. Using the MyScreen PASSWORD Function</b></p> <p>The MyScreen PASSWORD function can be used to prohibit access to the MyScreen function and prevent the currently registered MyScreen image from being overwritten.</p> <p><b>2.1 Turning on the MyScreen PASSWORD Function</b></p> <p>2.1-1 Use the ▲/▼ buttons on the SECURITY menu to select MyScreen PASSWORD and press the ► button to display the MyScreen PASSWORD on/off menu.</p> <p><b>2.2 Setting the PASSWORD</b></p> <p>2.2-1 Display the MyScreen PASSWORD on/off menu using the procedure in 2.1-1.</p> <p>2.2-2 Use the ▲/▼ buttons on the MyScreen PASSWORD on/off menu to select TURN ON. The ENTER PASSWORD box (small) will be displayed.</p> <p>2.2-3 Use the ▲/▼/◀/▶ buttons to enter the PASSWORD. Move the cursor to the right side of the ENTER PASSWORD box (small) and press the ► button to display the PASSWORD AGAIN box, enter the same PASSWORD again.</p>

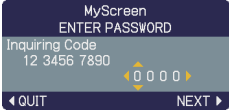

(continued on next page)

OPTION menu (continued)

Item	Description
<p><b>SECURITY</b> (continued)</p>	<p>2.2-4 Move the cursor to the right side of the PASSWORD AGAIN box and press the ► button to display the PASSWORD for about 20 seconds, please make note of the PASSWORD during this time.</p>  <p>Pressing the <b>ENTER</b> button will return to MyScreen PASSWORD on/off menu. When a PASSWORD is set for MyScreen:</p> <ul style="list-style-type: none"> <li>• The MyScreen registration function (and menu) will be unavailable.</li> <li>• The MyScreen Lock menu will be unavailable.</li> <li>• The START UP setting will be locked on MyScreen (and the menu will be unavailable).</li> </ul> <p>Turning the MyScreen PASSWORD off will allow normal operation of these functions.</p> <ul style="list-style-type: none"> <li>• Please do not forget your MyScreen PASSWORD.</li> </ul> <p><b>2.3 Turning the PASSWORD off</b></p> <p>2.3-1 Follow the procedure in 2.1-1 to display the MyScreen PASSWORD on/off menu.</p> <p>2.3-2 Select TURN OFF to display the ENTER PASSWORD box (large). Enter the registered PASSWORD and the screen will return to the MyScreen on/off menu.</p> <p>If an incorrect PASSWORD is input, the menu will close. If necessary, repeat the process from 2.3-1.</p> <p><b>2.4 If you have forgotten your PASSWORD</b></p> <p>2.4-1 Follow the procedure in 2.1-1 to display the MyScreen PASSWORD on/off menu.</p> <p>2.4-2 Select TURN OFF to display the ENTER PASSWORD box (large). The 10-digit Inquiring Code will be displayed inside the box.</p>  <p>2.4-3 Contact your dealer with the 10-digit Inquiring Code. Your PASSWORD will be sent after your user registration information is confirmed.</p>
	<p><b>3. Using the PIN LOCK Function</b></p> <p>PIN LOCK is a function which prevents the projector from being used unless a registered Code is input.</p> <p><b>3.1 Registering the PIN Code</b></p> <p>3.1-1 Use the ▲/▼ buttons on the SECURITY menu to select PIN LOCK and press the ► button or the <b>ENTER</b> button to display the PIN LOCK on/off menu.</p> 

(continued on next page)

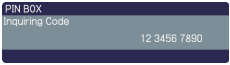

**OPTION menu (continued)**

Item	Description
<p><b>SECURITY</b> (continued)</p>	<p>3.1-2 Use the ▲/▼ buttons on the PIN LOCK on/off menu to select TURN ON and the PIN BOX will be displayed.</p>  <p>3.1-3 Input a 4 part PIN Code using the ▲, ▼, ◀, ▶, <b>COMPUTER</b> and <b>INPUT</b> buttons. A PIN Code again box will appear. Reenter the same PIN Code. This will complete the PIN Code registration.</p> <ul style="list-style-type: none"> <li>• If there is no key input for about 55 seconds while the PIN BOX or the PIN Code again box are displayed, the menu will close. If necessary, repeat the process from 3.1-1.</li> </ul> <p>Afterwards, anytime the projector is restarted after AC power is turned off the PIN BOX will be displayed. Enter the registered PIN Code. The projector can be used after entering the registered PIN Code. If an incorrect PIN Code is input, the PIN BOX will be displayed again. If an incorrect PIN Code is input 3 times, the projector will turn off. Afterwards the projector will turn off every time an incorrect PIN Code is input. The projector will also turn off if there is no key input for about 5 minutes while the PIN BOX is displayed. This function will activate only when the projector is started after AC power is turned off.</p> <ul style="list-style-type: none"> <li>• Please do not forget your PIN Code.</li> </ul>
	<p><b>3.2 Turning Off the PIN LOCK Function</b></p> <p>3.2-1 Follow the procedure in 3.1-1 to display the PIN LOCK on/off menu. Use the ▲/▼ buttons to select TURN OFF and the PIN BOX will be displayed. Enter the registered PIN Code to turn the PIN LOCK function off. If an incorrect PASSWORD is input 3 times, the menu will close.</p>
	<p><b>3.3 If you have forgotten your PIN Code</b></p> <p>3.3-1 While the PIN BOX is displayed, press and hold the <b>RESET</b> button on the remote control for 3 seconds, or press and hold the <b>INPUT</b> button for 3 seconds while pressing the ▶ button on the projector. The 10-digit Inquiring Code will be displayed.</p>  <ul style="list-style-type: none"> <li>• If 5 minutes pass after the PIN BOX is displayed, the projector will turn off.</li> </ul> <p>3.3-2 Contact your dealer with the 10-digit Inquiring Code. Your PASSWORD will be sent after your user registration information is confirmed.</p>

(continued on next page)

OPTION menu (continued)

Item	Description
<p><b>SECURITY</b> (continued)</p>	<p><b>4. Using the Transition Detector Function</b></p> <p>While the Transition Detector function is ON, when power switch is started to supply to the projector, it might react as below.</p> <ul style="list-style-type: none"> <li>• Transition Detector alarm shown below might appear on screen, if the projector has been moved or re-installed.</li> <li>• Transition Detector alarm might appear on screen, if the MIRROR setting has been changed.</li> <li>• Keystone adjustment feature has been prohibited as long as the Transition Detector function is ON.</li> </ul> <p><b>4.1 Turning On the Transition Detector Function</b></p> <p>4.1-1 Use the ▲/▼ buttons on the SECURITY menu to select TRANSITION DETECTOR and press the ► or the <b>ENTER</b> button to display the TRANSITION DETECTOR on/off menu. Select TURN ON and the current angle and mirror setting will be recorded.</p> <ul style="list-style-type: none"> <li>• This feature may not function properly if the projector is not in a stable position when TURN ON is selected.</li> </ul> <p>4.1-2 If this function is set to TURN ON when the vertical angle of the projector or mirror setting at which the projector is turned on is different than the previously recorded, the Transition Detector alarm will be displayed and the projector will not display the input signal.</p> <div data-bbox="800 531 1030 598" style="border: 1px solid black; padding: 5px; margin: 10px 0;"> <p style="text-align: center;">TRANSITION DETECTOR</p> <p style="text-align: center;">TURN ON</p> <p style="text-align: center;">TURN OFF</p> </div> <p>Set the Transition Detector off in the SECURITY menu to display the input signal.</p> <p>If the Transition Detector alarm is displayed for about 5 minutes, the lamp will turn off. This function will activate only when the projector is started after turning off the AC power.</p> <div data-bbox="800 721 1030 873" style="border: 1px solid black; padding: 5px; margin: 10px 0;"> <p style="text-align: center;">&lt;&lt;TRANSITION DETECTOR ON&gt;&gt;</p> <p style="text-align: center;">The projector has been transferred from previously installed position.</p> <p style="text-align: center;">If you wish to have a square image on screen again, disable Transition Detector on Menu.</p> </div> <p><b>4.2 Setting the Transition Detector PASSWORD</b></p> <p>4.2-1 Use the ▲/▼ buttons on the SECURITY menu to select TRANSITION DETECTOR and press the ► or the <b>ENTER</b> button to display the TRANSITION DETECTOR on/off menu.</p> <p>4.2-2 Use the ▲/▼ buttons on the TRANSITION DETECTOR on/off menu to select TURN ON. The ENTER PASSWORD box (small) will be displayed.</p> <div data-bbox="800 1161 1030 1249" style="border: 1px solid black; padding: 5px; margin: 10px 0;"> <p style="text-align: center;">TRANSITION DETECTOR ENTER PASSWORD</p> <p style="text-align: center;">0 0 0 0</p> <p style="text-align: center;">◀ QUIT      NEXT ▶</p> </div> <p>4.2-3 Use the ▲/▼/◀/▶ buttons to enter a PASSWORD. Move the cursor to the right side of the ENTER PASSWORD box (small) and press the ► button to display the PASSWORD AGAIN box, enter the same PASSWORD again.</p> <div data-bbox="800 1275 1030 1362" style="border: 1px solid black; padding: 5px; margin: 10px 0;"> <p style="text-align: center;">TRANSITION DETECTOR PASSWORD AGAIN</p> <p style="text-align: center;">0 0 0 0</p> <p style="text-align: center;">◀ QUIT      NEXT ▶</p> </div>

(continued on next page)

**OPTION menu (continued)**

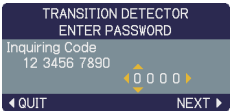
Item	Description
<p><b>SECURITY</b> (continued)</p>	<p>4.2-4 Move the cursor to the right side of the PASSWORD AGAIN box and press the ► button to display the PASSWORD for about 20 seconds, please make note of the PASSWORD during this time.</p> <p>Pressing the <b>ENTER</b> button will return to the TRANSITION DETECTOR on/off menu.</p> <ul style="list-style-type: none"> <li>• Please do not forget your Transition Detector PASSWORD.</li> </ul>
	<p><b>4.3 Setting the Transition Detector off</b></p>
	<p>4.3-1 Follow the procedure in 4.1-1 to display the TRANSITION DETECTOR on/off menu.</p>
	<p>4.3-2 Select TURN OFF to display the ENTER PASSWORD box (large). Enter the registered PASSWORD and the screen will return to the TRANSITION DETECTOR on/off menu. If an incorrect PASSWORD is input, the menu will close. If necessary, repeat the process from 4.3-1.</p>
	<p><b>4.4 If you have forgotten your PASSWORD</b></p>
<p>4.4-1 Follow the procedure in 4.1-1 to display the TRANSITION DETECTOR on/off menu.</p>	
<p>4.4-2 Select TURN OFF to display the ENTER PASSWORD box (large). The 10-digit Inquiring Code will be displayed inside the box.</p>	
<p>4.4-3 Contact your dealer with the 10-digit Inquiring Code. Your PASSWORD will be sent after your user registration information is confirmed.</p>	

(continued on next page)

OPTION menu (continued)

Item	Description
<p><b>SECURITY</b> (continued)</p>	<p><b>5. Using the MY TEXT PASSWORD function</b> This item allows you to display your own message (MY TEXT) on the START UP screen and INPUT-INFORMATION-. It can be protected by a password to prevent it from being overwritten.</p> <p><b>5.1 Writing the MY TEXT</b></p> <p>(1) Use the ▲/▼ buttons on the SECURITY menu to select the MY TEXT WRITING menu and press the ► button. The MY TEXT WRITING dialog will be displayed.</p> <p>(2) The current MY TEXT will be displayed on the first 3 lines. If not yet written, the lines will be blank. Use the ▲/▼/◀/▶ buttons and the ENTER or INPUT button to select and enter characters. The RESET button can be used to erase 1 character at a time. Also if you move the cursor to DELETE or ALL CLEAR on screen and push the ENTER or INPUT button, 1 character or all characters will be erased. The MY TEXT can be input up to 24 characters on each line.</p> <p>(3) To change an already inserted character, press the ▲/▼ button to move the cursor to one of the first 3 lines, and use the ◀/▶ buttons to move the cursor on the character to be changed. After pressing the ENTER or INPUT button, the character is selected. Then, follow the same procedure as described at the item (2) above.</p> <p>(4) To finish entering text, move the cursor to the SAVE on screen and press the ENTER or INPUT button. To revert to the previous MY TEXT without saving changes, move the cursor to the CANCEL on screen and press the ENTER or INPUT button.</p> <ul style="list-style-type: none"> <li>• The MY TEXT WRITING function is available only when the MY TEXT PASSWORD function is set to TURN OFF.</li> </ul> <p><b>5.2 Displaying the MY TEXT</b></p> <p>(1) Use the ▲/▼ buttons on the SECURITY menu to select the MY TEXT DISPLAY menu and press the ► button to display the MY TEXT DISPLAY on/off menu.</p> <p>(2) Use the ▲/▼ buttons on the MY TEXT DISPLAY on/off menu to select on or off.</p> <p><b>TURN ON ⇔ TURN OFF</b> When it is set TURN ON, the MY TEXT will be displayed on the START UP screen and the INPUT-INFORMATION- dialog (45).</p> <ul style="list-style-type: none"> <li>• This function is available only when the MY TEXT PASSWORD function is set to the TURN OFF.</li> </ul>

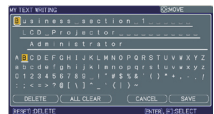
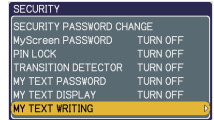



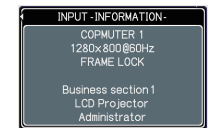

MY TEXT DISPLAY on/off menu



(continued on next page)

OPTION menu (continued)

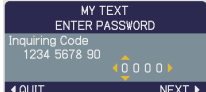
Item	Description
<p><b>SECURITY</b> (continued)</p>	<p><b>5.3 Turning on the MY TEXT PASSWORD</b> The MY TEXT PASSWORD function can prevent the MY TEXT from being overwritten.</p> <p>5.3-1 Turning on the MY TEXT PASSWORD function</p> <p>(1) Use the ▲/▼ buttons on the SECURITY menu to select the MY TEXT PASSWORD menu and press the ► button to display the MY TEXT PASSWORD on/off menu.</p>
	<p>5.3-2 Setting the MY TEXT PASSWORD</p> <p>(1) Display the MY TEXT PASSWORD on/off menu using the procedure in 5.3-1</p>
	<p>(2) Use the ▲/▼ buttons on the MY TEXT PASSWORD menu to select TURN ON. The ENTER PASSWORD BOX (small) will be displayed.</p>
	<p>(3) Use the ▲/▼/◀/▶ buttons to enter the PASSWORD. Move the cursor to the right side of the ENTER PASSWORD BOX (small) and press the ► button to display the PASSWORD AGAIN BOX, and then enter the same PASSWORD again.</p>
	<p>(4) Move the cursor to the right side of the PASSWORD AGAIN BOX and press ► button to display the PASSWORD for about 20 seconds, then please make note of the PASSWORD during this time.</p>
	<p>Pressing the <b>ENTER</b> button on the remote control or <b>INPUT</b> button on the projector will return to the MY TEXT PASSWORD on/off menu. When the PASSWORD is set for the MY TEXT;</p> <ul style="list-style-type: none"> <li>• The MY TEXT DISPLAY menu will be unavailable, which can prohibit changing the DISPLAY setting.</li> <li>• The MY TEXT WRITING menu will be unavailable, which can prevent the MY TEXT from being overwritten.</li> </ul>
	<p>5.3-3 Turning the MY TEXT PASSWORD off</p> <p>(1) Follow the procedure in 5.3-1 to display the MY TEXT PASSWORD on/off menu.</p> <p>(2) Select TURN OFF to display the ENTER PASSWORD BOX (large). Enter the registered PASSWORD and the screen will return to the MY TEXT PASSWORD on/off menu.</p>
	<p>If an incorrect PASSWORD is input, the menu will close. If necessary, repeat the process from 5.3-3(1)</p>
	<p>5.3.4 If you have forgotten your PASSWORD.</p> <p>(1) Follow the procedure in 5.3-1 to display the MY TEXT PASSWORD on/off menu.</p> <p>(2) Select TURN OFF to display the ENTER PASSWORD BOX (large). The 10 digit inquiring code will be displayed inside the box.</p> <p>(3) Contact your dealer with the 10 digit inquiring code. Your PASSWORD will be sent after your user registration information is confirmed.</p>
	 <p>MY TEXT PASSWORD</p>
 <p>ENTER PASSWORD BOX (small)</p>	
 <p>PASSWORD AGAIN BOX</p>	
 <p>NOTE PASSWORD BOX</p>	
 <p>ENTER PASSWORD BOX (large)</p>	

## C.C. (Closed Caption) menu

The closed caption setting can be changed through C.C. menu in the advance menu. Please select the item that you will change using ▲/▼ cursor buttons.

• The C.C. (Closed Caption) is the function that displays a transcript or dialog of the audio portion of a video, files or other presentation or other relevant sounds. It is required to have NTSC format video or 480i@60 format component video source supporting C.C. feature to utilize this function.

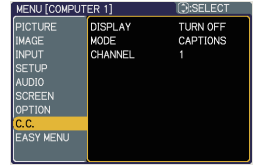

Item	Description
<p><b>DISPLAY</b></p>	<p>Select Closed Caption DISPLAY setting from following options using ▲/▼ buttons.</p> <p>TURN OFF ⇄ TURN ON ⇄ AUTO</p> <p style="text-align: center;">↑—————↑</p> <p>TURN OFF: Closed Caption is OFF                      TURN ON: Closed Caption is ON                      AUTO: Closed Caption automatically displays when the volume is muted.</p> <ul style="list-style-type: none"> <li>• The caption is not displayed when the OSD menu is active.</li> <li>• The Closed Caption is the function to display the dialogue, narration, and / or sound effects of a television program or other video sources. The Closed Caption availability is depending upon broadcaster and/or content.</li> <li>• It may not work properly, depending on equipment or signal source. In this case, please turn off the Closed Caption.</li> </ul>
<p><b>MODE</b></p>	<p>Select Closed Caption MODE setting from following options using ▲/▼ buttons.</p> <p>CAPTIONS ⇄ TEXT</p> <p>CAPTIONS: Display Closed Caption                      TEXT: Display Text data, which is for additional information such as news reports or a TV program guide. The information covers the entire screen. Not all of the C.C. program has Text information.</p>
<p><b>CHANNEL</b></p>	<p>Select Closed Caption CHANNEL from following options using ▲/▼ buttons.</p> <p>1 ⇄ 2 ⇄ 3 ⇄ 4</p> <p style="text-align: center;">↑—————↑</p> <p>1: Channel 1, primary channel / language                      2: Channel 2                      3: Channel 3                      4: Channel 4</p> <p>The channel data may vary, depending on the content. Some channel might be used for secondary language or empty.</p>



## Maintenance

### Replacing the lamp

A lamp has finite product life. Using the lamp for long periods of time could cause the pictures darker or the color tone poor. Note that each lamp has a different lifetime, and some may burst or burn out soon after you start using them. Preparation of a new lamp and early replacement are recommended. To prepare a new lamp, make contact with your dealer and tell the lamp type number.

**Type number : DT00911**

#### Replacing the lamp

1. Turn the projector off, and unplug the power cord.  
Allow the projector to cool for at least 45 minutes.
2. Prepare a new lamp. If the projector is mounted on a ceiling, or if the lamp has broken, also ask the dealer to replace the lamp.

**In case of replacement by yourself, follow the following procedure.**

3. Loosen the screw (marked by arrow) of the lamp cover and then slide and lift the lamp cover to the side to remove it.
4. Loosen the 2 screws (marked by arrow) of the lamp, and slowly pick up the lamp by the handles.
5. Insert the new lamp, and retighten firmly the 2 screws of the lamp that are loosened in the previous process to lock it in place.
6. While putting the interlocking parts of the lamp cover and the projector together, slide the lamp cover back in place. Then firmly fasten the screw of the lamp cover.
7. Turn the projector on and reset the lamp time using the LAMP TIME item in the OPTION menu.
  - (1) Press the **MENU** button to display a menu.
  - (2) Point at the Go to Advanced Menu ... in the menu using the **▼/▲** button, then press the **▶** button.
  - (3) Point at the OPTION in the left column of the menu using the **▼/▲** button, then press the **▶** button.
  - (4) Point at the LAMP TIME using the **▼/▲** button, then press the **▶** button. A dialog will appear.
  - (5) Press the **▲** button to select RESET on the dialog. It performs resetting the lamp time.

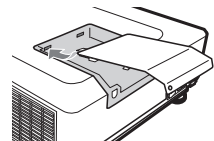
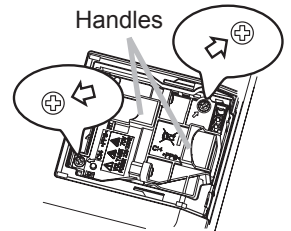
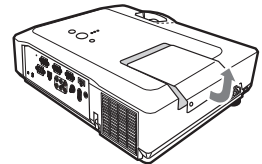
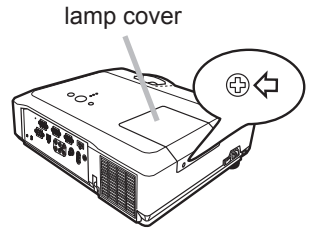

**⚠ CAUTION** ▶ Do not touch any inner space of the projector, while the lamp is taken out.

**NOTE** • Please reset the lamp time only when you have replaced the lamp, for a suitable indication about the lamp.

## Replacing the lamp (continued)

### Lamp warning

 **HIGH VOLTAGE**     **HIGH TEMPERATURE**     **HIGH PRESSURE**

**⚠ WARNING** ▶ The projector uses a high-pressure mercury glass lamp. The lamp can break with a loud bang, or burn out, if jolted or scratched, handled while hot, or worn over time. Note that each lamp has a different lifetime, and some may burst or burn out soon after you start using them. In addition, when the bulb bursts, it is possible for shards of glass to fly into the lamp housing, and for gas containing mercury to escape from the projector's vent holes.

▶ **About disposal of a lamp:** This product contains a mercury lamp; do not put it in a trash. Dispose of it in accordance with environmental laws.

- For lamp recycling, go to [www.lamprecycle.org](http://www.lamprecycle.org) (in the US).
- For product disposal, consult your local government agency or [www.eiae.org](http://www.eiae.org) (in the US) or [www.epsc.ca](http://www.epsc.ca) (in Canada).

For more information, call your dealer.



Disconnect  
the plug  
from the  
power  
outlet

- If the lamp should break (it will make a loud bang when it does), unplug the power cord from the outlet, and make sure to request a replacement lamp from your local dealer. Note that shards of glass could damage the projector's internals, or cause injury during handling, so please do not try to clean the projector or replace the lamp yourself.
- If the lamp should break (it will make a loud bang when it does), ventilate the room well, and make sure not to breathe the gas that comes out of the projector vents, or get it in your eyes or mouth.
- Before replacing the lamp, turn the projector off and unplug the power cord, then wait at least 45 minutes for the lamp to cool sufficiently. Handling the lamp while hot can cause burns, as well as damaging the lamp.



- Never unscrew except the appointed (marked by an arrow) screws.
- Do not open the lamp cover while the projector is suspended from a ceiling. This is dangerous, since if the lamp's bulb has broken, the shards will fall out when the cover is opened. In addition, working in high places is dangerous, so ask your local dealer to have the lamp replaced even if the bulb is not broken.
- Do not use the projector with the lamp cover removed. At the lamp replacing, make sure that the screws are screwed in firmly. Loose screws could result in damage or injury.



- Use only the lamp of the specified type.
- If the lamp breaks soon after the first time it is used, it is possible that there are electrical problems elsewhere besides the lamp. If this happens, consult your local dealer or a service representative.
- Handle with care: jolting or scratching could cause the lamp bulb to burst during use.
- Using the lamp for long periods of time, could cause it dark, not to light up or to burst. When the pictures appear dark, or when the color tone is poor, please replace the lamp as soon as possible. Do not use old (used) lamps; this is a cause of breakage.



## Cleaning and replacing the air filter

The air filter unit of this projector consists of a filter cover, two kinds of filters, and a filter frame. The new double large filters system is expected to function longer. However, please check and clean it periodically to keep ventilation needed for normal operation of the projector.

When the indicators or a message prompts you to clean the air filter, comply with it as soon as possible. Replace the filters when they are damaged or too soiled. To prepare new filters, make contact with your dealer and tell the following type number.

### Type number : MU05611

When you replace the lamp, please replace the air filter. An air filter of specified type will come together with a replacement lamp for this projector.

1. Turn the projector off, and unplug the power cord.  
Allow the projector to sufficiently cool down.
2. Use a vacuum cleaner on and around the filter cover.
3. Pull the filter cover knobs while lifting it, to take the filter unit off.
4. Use a vacuum cleaner for the filter vent of the projector and both sides of the filter unit.

If the filters are damaged or too soiled, replace them according to the following procedure number 5 to 7. Otherwise, please jump to the procedure number 8.

5. Pull the filter frame's knob up while holding the filter cover to remove the filter frame, then take the filters out.
6. Set new filters where former filters were. Put the larger meshed filter into a filter cover first. Then put the finer meshed filter on the larger meshed one.
7. Put the filter frame back where it was.
8. Put the filter unit back into the projector.

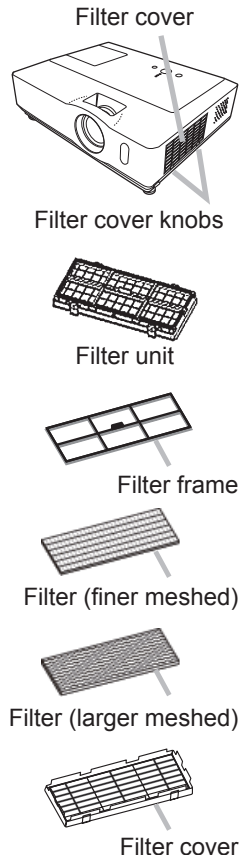

(continued on next page)

### ***Cleaning and replacing the air filter (continued)***

9. Turn the projector on and reset the filter time using the FILTER TIME item in the EASY MENU.
  - (1) Press the **MENU** button to display a menu.
  - (2) Point at the FILTER TIME using the ▼/▲ button, then press the ► button. A dialog will appear.
  - (3) Press the ▲ button to select RESET on the dialog. It performs resetting the filter time.

**⚠ WARNING** ► Before taking care of the air filter, make sure the power switch is off and the power cable is not plugged in, then allow the projector to cool sufficiently. Taking care of the air filter in a high temperature state of the projector could cause an electric shock, a burn or malfunction to the projector.

► Use only the air filter of the specified type. Do not use the projector without the air filter or the filter cover. It could result in a fire or malfunction to the projector.

► Clean the air filter periodically. If the air filter becomes clogged by dust or the like, internal temperatures rise and could cause a fire, a burn or malfunction to the projector.

**NOTE** • Please replace the air filter when it is damaged or too soiled.

- When you replace the projection lamp, please replace the air filter. An air filter of specified type will come together with a replacement lamp for this projector.
- Please reset the filter time only when you have cleaned or replaced the air filter, for a suitable indication about the air filter.
- The projector may display the message such as “CHECK THE AIR FLOW” or turn off the projector, to prevent the internal heat level rising.

## Other care

### Inside of the projector

In order to ensure the safe use of your projector, please have it cleaned and inspected by your dealer about once every year.

### Caring for the lens

If the lens is flawed, soiled or fogged, it could cause deterioration of display quality. Please take care of the lens, being cautious of handling.

1. Turn the projector off, and unplug the power cord. Allow the projector to cool sufficiently.
2. After making sure that the projector is cool adequately, lightly wipe the lens with a commercially available lens-cleaning wipe. Do not touch the lens directly with your hand.

### Caring for the cabinet and remote control

Incorrect care could have adverse influence such as discoloration, peeling paint, etc.

1. Turn the projector off, and unplug the power cord. Allow the projector to cool sufficiently.
2. After making sure that the projector is cool adequately, lightly wipe with gauze or a soft cloth.  
If the projector is extremely dirty, dip soft cloth in water or a neutral cleaner diluted in water, and wipe lightly after wringing well. Then, wipe lightly with a soft, dry cloth.

**⚠ WARNING** ▶ Before caring, make sure the power cord is not plugged in, and then allow the projector to cool sufficiently. The care in a high temperature state of the projector could cause a burn and/or malfunction to the projector.

▶ Never try to care for the inside of the projector personally. Doing is so dangerous.

▶ Avoid wetting the projector or inserting liquids in the projector. It could result in a fire, an electric shock, and/or malfunction to the projector.

- Do not put anything containing water, cleaners or chemicals near the projector.
- Do not use aerosols or sprays.

**⚠ CAUTION** ▶ Please take right care of the projector according to the following. Incorrect care could cause not only an injury but adverse influence such as discoloration, peeling paint, etc.

- ▶ Do not use cleaners or chemicals other than those specified in this manual.
- ▶ Do not polish or wipe with hard objects.

## Troubleshooting

If an abnormal operation should occur, stop using the projector immediately.



**⚠ WARNING** ▶ Never use the projector if abnormal operations such as smoke, strange odor, excessive sound, damaged casing or elements or cables, penetration of liquids or foreign matter, etc. should occur. In such cases, immediately turn off the power switch and then disconnect the power plug from the power outlet. After making sure that the smoke or odor has stopped, contact to your dealer or service company.

Otherwise if a problem occurs with the projector, the following checks and measures are recommended before requesting repair.

If this does not resolve the problem, please contact your dealer or service company. They will tell you what warranty condition is applied.

### Related messages

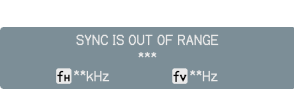
When some message appears, check and cope with it according to the following table. Although these messages will be automatically disappeared around several minutes, it will be reappeared every time the power is turned on.

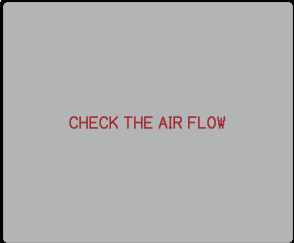
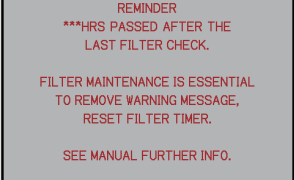
Message	Description
	<p><b>There is no input signal.</b> Please confirm the signal input connection, and the status of the signal source.</p>
	<p><b>The horizontal or vertical frequency of the input signal is not within the specified range.</b> Please confirm the specs for your projector or the signal source specs.</p>
	<p><b>An improper signal is input.</b> Please confirm the specs for your projector or the signal source specs.</p>
	<p><b>The internal temperature is rising.</b> Please turn the power off, and allow the projector to cool down at least 20 minutes. After having confirmed the following items, please turn the power ON again.</p> <ul style="list-style-type: none"> <li>• Is there blockage of the air passage aperture?</li> <li>• Is the air filter dirty?</li> <li>• Does the peripheral temperature exceed 35°C?</li> </ul> <p>If the same indication is displayed after the remedy, please set FAN SPEED of the SERVICE item in the OPTION menu to HIGH.</p>
	<p><b>A note of precaution when cleaning the air filter.</b> Please immediately turn the power off, and clean or change the air filter referring to the “Cleaning and replacing the air filter” section of this manual. After you have cleaned or changed the air filter, please be sure to reset the filter timer (📖57).</p>

## Regarding the indicator lamps

When operation of the **LAMP**, **TEMP** and **POWER** indicators differs from usual, check and cope with it according to the following table.

POWER indicator	LAMP indicator	TEMP indicator	Description
Lighting In <b>Orange</b>	Turned <b>off</b>	Turned <b>off</b>	<b>The projector is in a standby state.</b> Please refer to the section "Power on/off".
<i>Blinking</i> In <b>Green</b>	Turned <b>off</b>	Turned <b>off</b>	<b>The projector is warming up.</b> Please wait.
Lighting In <b>Green</b>	Turned <b>off</b>	Turned <b>off</b>	<b>The projector is in an on state.</b> Ordinary operations may be performed.
<i>Blinking</i> In <b>Orange</b>	Turned <b>off</b>	Turned <b>off</b>	<b>The projector is cooling down.</b> Please wait.
<i>Blinking</i> In <b>Red</b>	(discre- tionary)	(discre- tionary)	<b>The projector is cooling down. A certain error has been detected.</b> Please wait until <b>POWER</b> indicator finishes blinking, and then perform the proper measure using the item descriptions below.
<i>Blinking</i> In <b>Red</b> or Lighting In <b>Red</b>	Lighting In <b>Red</b>	Turned <b>off</b>	<b>The lamp does not light, and there is a possibility that interior portion has become heated.</b> Please turn the power off, and allow the projector to cool down at least 20 minutes. After the projector has sufficiently cooled down, please make confirmation of the following items, and then turn the power on again. <ul style="list-style-type: none"> <li>• Is there blockage of the air passage aperture?</li> <li>• Is the air filter dirty?</li> <li>• Does the peripheral temperature exceed 35°C?</li> </ul> If the same indication is displayed after the remedy, please change the lamp referring to the section "Lamp".
<i>Blinking</i> In <b>Red</b> or Lighting In <b>Red</b>	<i>Blinking</i> In <b>Red</b>	Turned <b>off</b>	<b>The lamp cover has not been properly fixed.</b> Please turn the power off, and allow the projector to cool down at least 45 minutes. After the projector has sufficiently cooled down, please make confirmation of the attachment state of the lamp cover. After performing any needed maintenance, turn the power on again. If the same indication is displayed after the remedy, please contact your dealer or service company.
<i>Blinking</i> In <b>Red</b> or Lighting In <b>Red</b>	Turned <b>off</b>	<i>Blinking</i> In <b>Red</b>	<b>The cooling fan is not operating.</b> Please turn the power off, and allow the projector to cool down at least 20 minutes. After the projector has sufficiently cooled down, please make confirmation that no foreign matter has become caught in the fan, etc., and then turn the power on again. If the same indication is displayed after the remedy, please contact your dealer or service company.

(Continued on next page)

Regarding the indicator lamps (continued)

POWER indicator	LAMP indicator	TEMP indicator	Description
Blinking In Red or Lighting In Red	Turned off	Lighting In Red	<p><b>There is a possibility that the interior portion has become heated.</b></p> <p>Please turn the power off, and allow the projector to cool down at least 20 minutes. After the projector has sufficiently cooled down, please make confirmation of the following items, and then turn the power on again.</p> <ul style="list-style-type: none"> <li>• Is there blockage of the air passage aperture?</li> <li>• Is the air filter dirty?</li> <li>• Does the peripheral temperature exceed 35°C?</li> </ul> <p>If the same indication is displayed after the remedy, please set FAN SPEED of SERVICE item in OPTION menu to HIGH (44).</p>
Lighting In Green	Simultaneous blinking in Red		<p><b>It is time to clean the air filter.</b></p> <p>Please immediately turn the power off, and clean or change the air filter referring to the section “Cleaning and replacing the air filter”. After cleaning or changing the air filter, please be sure to reset the filter timer.</p> <p>After the remedy, reset the power to ON.</p>
Lighting In Green	Alternative blinking in Red		<p><b>There is a possibility that the interior portion has become overcooled.</b></p> <p>Please use the unit within the usage temperature parameters (5°C to 35°C).</p> <p>After the treatment, reset the power to ON.</p>

**NOTE** • When the interior portion has become overheated, for safety purposes, the projector is automatically shut down, and the indicator lamps may also be turned off. In such a case, disconnect the power cord, and wait at least 45 minutes. After the projector has sufficiently cooled down, please make confirmation of the attachment state of the lamp and lamp cover, and then turn the power on again.

**Shutting the projector down**

Only when the projector can not be turned off by usual procedure (14), please push the shutdown switch using a pin or similar, and disconnect the power plug from the power outlet. Before turning it on again, wait at least 10 minutes to make the projector cool down enough.

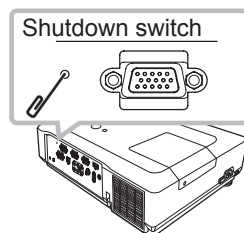

**Resetting all settings**

When it is hard to correct some wrong settings, the FACTORY RESET function of SERVICE item in OPTION menu (45) can reset all settings(except LANGUAGE, FILTER TIME, LAMP TIME, FILTER MESSAGE settings and etc.) to the factory default.

## Phenomena that may be easy to be mistaken for machine defects

About the phenomenon confused with a machine defect, check and cope with it according to the following table.

Phenomenon	Cases not involving a machine defect	Reference page
Power does not come on.	<b>The electrical power cord is not plugged in.</b> Correctly connect the power cord.	11
	<b>The power switch is not set to the on position.</b> Set the power switch to [   ] (On).	14
	<b>The main power source has been interrupted during operation such as by a power outage (blackout), etc.</b> Please disconnect the power plug from the power outlet, and allow the projector to cool down at least 10 minutes, then turn the power on again.	11, 14
	<b>Either there is no lamp and/or lamp cover, or either of these has not been properly fixed.</b> Please turn the power off and disconnect the power plug from the power outlet, and allow the projector to cool down at least 45 minutes. After the projector has sufficiently cooled down, please make confirmation of the attachment state of the lamp and lamp cover, and then turn the power on again.	55, 56
Neither sounds nor pictures are outputted.	<b>The signal cables are not correctly connected.</b> Correctly connect the connection cables.	9
	<b>Signal source does not correctly work.</b> Correctly set up the signal source device by referring to the manual of the source device.	–
	<b>The input changeover settings are mismatched.</b> Select the input signal, and correct the settings.	15, 16
	<b>The BLANK function for pictures and the MUTE function for sounds are working.</b> AV MUTE may be active. Refer to the item “Sound does not come out” and “No pictures are displayed” on the next page to turn off the MUTE and BLANK functions.	43, 15, 21
Sound does not come out.	<b>The signal cables are not correctly connected.</b> Correctly connect the audio cables.	9
	<b>The MUTE function is working.</b> Restore the sound pressing <b>MUTE</b> or <b>VOLUME +/-</b> button on the remote control.	15
	<b>The volume is adjusted to an extremely low level.</b> Adjust the volume to a higher level using the menu function or the remote control.	15

(Continued on next page)

**Phenomena that may be easy to be mistaken for machine defects (continued)**

Phenomenon	Cases not involving a machine defect	Reference page
Sound does not come out. (continued)	<b>The AUDIO/SPEAKER setting is not correct.</b> Correctly set the AUDIO/SPEAKER in AUDIO menu.	36
	<b>The audio on your HDMI equipment is not set to Linear PCM.</b> The HDMI input on this projector supports Linear PCM audio only. Check the audio setting on your HDMI equipment.	10
	<b>The audio on the HDMI input is muted.</b> Change the audio setting in the AUDIO menu.	36
	<b>The digital audio in HDMI signal does not work well.</b> Use the analogue audio, connecting either an RCA audio cable or stereo mini cable.	9
No pictures are displayed.	<b>The lens cover is attached.</b> Remove the lens cover.	4, 14
	<b>The signal cables are not correctly connected.</b> Correctly connect the connection cables.	9
	<b>The brightness is adjusted to an extremely low level.</b> Adjust BRIGHTNESS to a higher level using the menu function.	25, 26
	<b>The computer cannot detect the projector as a plug and play monitor.</b> Make sure that the computer can detect a plug and play monitor using another plug and play monitor.	10
	<b>The BLANK screen is displayed.</b> Press <b>BLANK</b> button on the remote control.	21
No pictures or disturbed pictures are displayed on HDMI input.	<b>The HDMI cable is not correctly connected.</b> Correctly connect the HDMI cable.	9
	<b>Your HDMI equipment is not compatible with the projector.</b> This projector can be connected with another equipment that has HDMI or DVI connector, but with some equipment the projector may not work properly.	10
	<b>Your HDMI equipment and the projector are not harmonized.</b> Turn off the both equipment, and turn on them again.	-
	<b>The signal format on the HDMI is not supported.</b> Check the video setting on your HDMI equipment.	10

(Continued on next page)



**Phenomena that may be easy to be mistaken for machine defects (continued)**

Phenomenon	Cases not involving a machine defect	Reference page
Video screen display freezes.	<b>The FREEZE function is working.</b> Press <b>FREEZE</b> button to restore the screen to normal.	21
Colors have a faded- out appearance, or Color tone is poor.	<b>Color settings are not correctly adjusted.</b> Perform picture adjustments by changing the COLOR TEMP, COLOR, TINT and/or COLOR SPACE settings, using the menu functions.	25, 27, 31
	<b>COLOR SPACE setting is not suitable.</b> Change the COLOR SPACE setting to AUTO, RGB, SMPTE240, REC709 or REC601.	31
Pictures appear dark.	<b>The brightness and/or contrast are adjusted to an extremely low level.</b> Adjust BRIGHTNESS and/or CONTRAST settings to a higher level using the menu function.	25, 26
	<b>The WHISPER function is working.</b> Select NORMAL for WHISPER item in the SETUP menu.	25, 34
	<b>The lamp is approaching the end of its product lifetime.</b> Replace the lamp.	55, 56
Pictures appear blurry.	<b>Either the focus and/or horizontal phase settings are not properly adjusted.</b> Adjust the focus using the focus ring, and/or H PHASE using the menu function.	18, 30
	<b>The lens is dirty or misty.</b> Clean the lens referring to the section "Caring for the lens".	59
RS-232C does not work.	<b>The SAVING function is working.</b> Select NORMAL for STANDBY MODE item in the SETUP menu.	35

**NOTE** • Although bright spots or dark spots may appear on the screen, this is a unique characteristic of liquid crystal displays, and it does not constitute or imply a machine defect.

## Specifications

## Specification

Item	Specification	
Product name	Liquid crystal projector	
Liquid Crystal Panel	Panel size	1.5cm (0.59 type)
	Drive system	TFT active matrix
	Pixels	1,024,000 pixels (1280 horizontal x 800 vertical)
Lens	Zoom lens, F = 1.6 ~ 1.8, f = 18.9~ 22.6 mm (approximately)	
Lamp	230W UHB	
Speaker	10W x 1	
Power supply	AC 100-120V/3.5A, AC220-240V/1.5A	
Power consumption	320 W	
Temperature range	5 ~ 35°C (Operating)	
Size	340 (W) x 100 (H) x 270 (D) mm * Not including protruding parts. Please refer to the following figure.	
Weight (mass)	approx. 3.5 kg	
Ports	<p><b>Computer input port</b>            COMPUTER IN1 .....D-sub 15 pin mini x1            COMPUTER IN2 .....D-sub 15 pin mini x1</p> <p><b>Computer output port</b>            MONITOR OUT .....D-sub 15 pin mini x1</p> <p><b>Video input port</b>            Y, Cb/Pb, Cr/Pr (Component video) ..... RCA x3            S-VIDEO ..... mini DIN 4 pin x1            VIDEO ..... RCA x1</p> <p><b>HDMI input port</b>            HDMI .....HDMI connector x1</p> <p><b>Audio input/output port</b>            AUDIO IN1 .....Stereo mini x1            AUDIO IN2 .....Stereo mini x1            AUDIO IN3 ..... RCA x2            AUDIO OUT .....Stereo mini x1</p> <p><b>Others</b>            USB .....USB-B x1            CONTROL ..... D-sub 9 pin x1</p>	
Optional parts	<p><b>Lamp:</b> DT00911  <b>Air filter:</b> MU05611            * For more information, please consult your dealer.</p>	

## Specifications (continued)

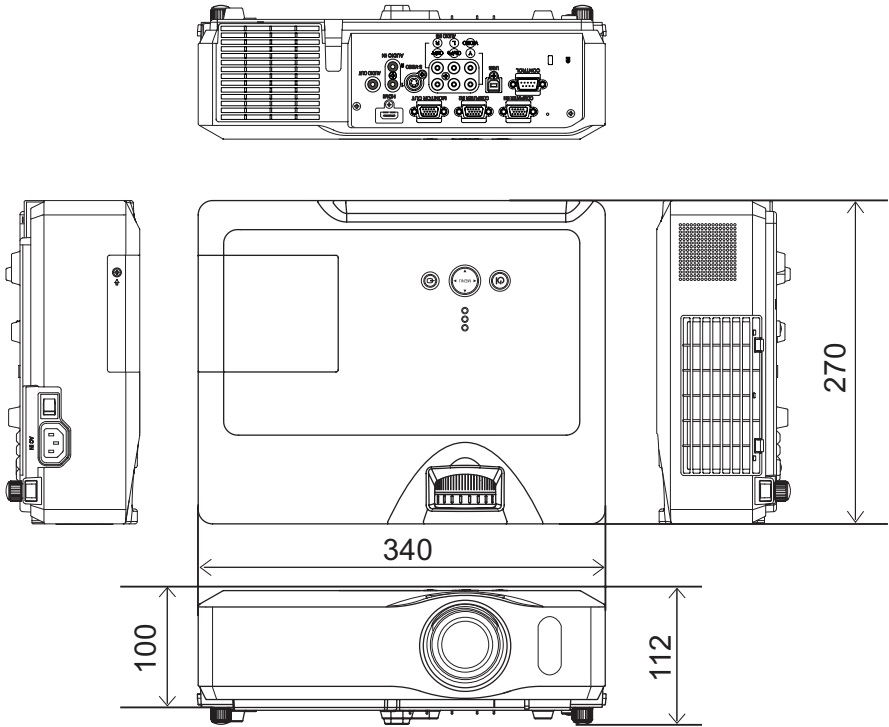

[unit: mm]