

# Projector

## ED-X40/ED-X42

### User's Manual (detailed) Operating Guide

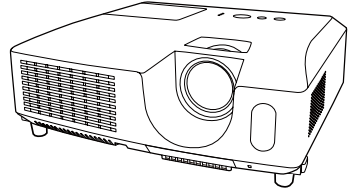

Thank you for purchasing this projector.

**⚠ WARNING** ▶ Before using this product, please read all manuals for this product. Be sure to read “**Safety Guide**” first. After reading them, store them in a safe place for future reference.

#### About this manual

Various symbols are used in this manual. The meanings of these symbols are described below.

**⚠ WARNING** This symbol indicates information that, if ignored, could possibly result in personal injury or even death due to incorrect handling.

**⚠ CAUTION** This symbol indicates information that, if ignored, could possibly result in personal injury or physical damage due to incorrect handling.

**NOTICE** This entry notices of fear of causing trouble.

 Please refer to the pages written following this symbol.

**NOTE** • The information in this manual is subject to change without notice.  
• The manufacturer assumes no responsibility for any errors that may appear in this manual.  
• The reproduction, transfer or copy of all or any part of this document is not permitted without express written consent.

#### Trademark acknowledgment

- Mac® is a registered trademark of Apple Inc.
  - Windows® is a registered trademark of Microsoft Corporation in the U.S. and/or other countries.
  - VESA and DDC are trademarks of the Video Electronics Standard Association.
- All other trademarks are the properties of their respective owners.

Projector

# User's Manual - Safety Guide

---

Thank you for purchasing this projector.



**⚠ WARNING** • Before using, read these user's manuals of this projector to ensure correct usage through understanding. After reading, store them in a safe place for future reference. Incorrect handling of this product could possibly result in personal injury or physical damage. The manufacturer assumes no responsibility for any damage caused by mishandling that is beyond normal usage defined in these manuals of this projector.

**NOTE** • The information in this manual is subject to change without notice.

- The manufacturer assumes no responsibility for any errors that may appear in this manual.
- The reproduction, transmission or use of this document or contents is not permitted without express written authority.

## About The Symbols

Various symbols are used in this manual, the user's manual and on the product itself to ensure correct usage, to prevent danger to the user and others, and to prevent property damage. The meanings of these symbols are described below. It is important that you read these descriptions thoroughly and fully understand the contents.

 <b>WARNING</b>	This symbol indicates information that, if ignored, could possibly result in personal injury or even death due to incorrect handling.
 <b>CAUTION</b>	This symbol indicates information that, if ignored, could result possibly in personal injury or physical damage due to incorrect handling.

## Typical Symbols



This symbol indicates an additional warning (including cautions). An illustration is provided to clarify the contents.



This symbol indicates a prohibited action. The contents will be clearly indicated in an illustration or nearby (the symbol to the left indicates that disassembly is prohibited).



This symbol indicates a compulsory action. The contents will be clearly indicated in an illustration or nearby (the symbol to the left indicates that the power plug should be disconnected from the power outlet).

# Safety Precautions

## WARNING

### **Never use the projector if a problem should occur.**

Abnormal operations such as smoke, strange odor, no image, no sound, excessive sound, damaged casing or elements or cables, penetration of liquids or foreign matter, etc. can cause a fire or electrical shock.

In such case, immediately turn off the power switch and then disconnect the power plug from the power outlet. After making sure that the smoke or odor has stopped, contact your dealer. Never attempt to make repairs yourself because this could be dangerous.

- The power outlet should be close to the projector and easily accessible.

### **Use special caution for children and pets.**

Incorrect handling could result in fire, electrical shock, injury, burn or vision problem.

Use special caution in households where children and pets are present.

### **Do not insert liquids or foreign object.**

Penetration of liquids or foreign objects could result in fire or electrical shock.

Use special caution in households where children are present.

If liquids or foreign object should enter the projector, immediately turn off the power switch, disconnect the power plug from the power outlet and contact your dealer.

- Do not place the projector near water (ex. a bathroom, a beach, etc.).
- Do not expose the projector to rain or moisture. Do not place the projector outdoors.
- Do not place flower vases, pots, cups, cosmetics, liquids such as water, etc on or around the projector.
- Do not place metals, combustibles, etc on or around the projector.
- To avoid penetration of foreign objects, do not put the projector into a case or bag together with any thing except the accessories of the projector, signal cables and connectors.

### **Never disassemble and modify.**

The projector contains high voltage components. Modification and/or disassembly of the projector or accessories could result in fire or electrical shock.

- Never open the cabinet.
- Ask your dealer to repair and clean insides.

### **Do not give the projector any shock or impact.**

If the projector should be shocked and/or broken, it could result in an injury, and continued use could result in fire or electrical shock.

If the projector is shocked, immediately turn off the power switch, disconnect the power plug from the power outlet and contact your dealer.

### **Do not place the projector on an unstable surface.**

If the projector should be dropped and/or broken, it could result in an injury, and continued use could result in fire or electrical shock.

- Do not place the projector on an unstable, slant or vibrant surface such as a wobbly or inclined stand.
- Use the caster brakes placing the projector on a stand with casters.
- Do not place the projector in the side up position, the lens up position or the lens down position.
- In the case of a ceiling installation or the like, contact your dealer before installation.



Disconnect the plug from the power outlet.



Do not disassemble.



# Safety Precautions (continued)

## **WARNING**

### **Be cautious of High temperatures of the projector.**

High temperatures are generated when the lamp is lit. It could result in fire or burn. Use special caution in households where children are present.

Do not touch about the lens, air fans and ventilation openings during use or immediately after use, to prevent a burn. Take care of ventilation.

- Keep a space of 30 cm or more between the sides and other objects such as walls.
- Do not place the projector on a metallic table or anything weak in heat.
- Do not place anything about the lens, air fans and ventilation openings of the projector.
- Never block the air fan and ventilation openings.
- Do not cover the projector with a tablecloth, etc.
- Do not place the projector on a carpet or bedding.



### **Never look through the lens or openings when the lamp is on.**

The powerful light could adversely affect vision.

Use special caution in households where children are present.

### **Use only the correct power cord and the correct power outlet.**

Incorrect power supply could result in fire or electrical shock.

- Use only the correct power outlet depending on the indication on the projector and the safety standard.
- The enclosed power cord must be used depending on the power outlet to be used.



### **Be cautious of the power cord connection.**

Incorrect connection of the power cord could result in fire or electrical shock.

- Do not touch the power cord with a wet hand.
- Check that the connecting portion of the power cord is clean (with no dust), before using. Use a soft and dry cloth to clean the power plug.
- Insert the power plug into a power outlet firmly. Avoid using a loose, unsound outlet or contact failure.



### **Be sure to connect with ground wire.**

Connect the ground terminal of AC inlet of this unit with the ground terminal provided at the building using the correct power cord; otherwise, fire or electric shock can result.

- Don't take the core of power cord away.



Surely connect the ground wire.

# Safety Precautions (continued)

## **WARNING**

### **Be careful in handling the light source lamp.**

The projector uses a high-pressure mercury glass lamp made of glass. The lamp can break with a loud bang, or burn out. When the bulb bursts, it is possible for shards of glass to fly into the lamp housing, and for gas containing mercury to escape from the projector's vent holes.

**Please carefully read the section "Lamp".**

### **Be careful in handling the power cord and external connection cables.**

If you keep using a damaged the power cord or cables, it can cause a fire or electrical shock. Do not apply too much heat, pressure or tension to the power cord and cables.

If the power cord or cables is damaged (exposed or broken core wires, etc.), contact your dealer.

- Do not place the projector or heavy objects on the power cord and cables. Also, do not place a spread, cover, etc. over them because this could result in the inadvertent placing of heavy objects on the concealed power cord or cables.
- Do not pull the power cord and cables. When connecting and disconnecting the power cord or cables, do it with your hand holding the plug or connector.
- Do not place the cord near the heater.
- Avoid bending the power cord sharply.
- Do not attempt to work on the power cord.

### **Be careful in handling the battery of the remote control.**

Incorrect handling of the battery could result in fire or personal injury. The battery may explode if not handled properly.

- Keep the battery away from children and pets. If swallowed consult a physician immediately for emergency treatment.
- Do not allow the battery in a fire or water.
- Avoid fire or high-temperature environment.
- Do not hold the battery with the metallic tweezers.
- Keep the battery in a dark, cool and dry play.
- Do not short circuit the battery.
- Do not recharge, disassemble or solder the battery.
- Do not give the battery a physical impact.
- Use only the battery specified in the other manual of this projector.
- Make sure the plus and minus terminals are correctly aligned when loading the battery.
- If you observe a leakage of the battery, wipe out the flower and then replace the battery. If the flower adheres your body or clothes, rinse well with water.
- Obey the local laws on disposing the battery.



# Safety Precautions (continued)

## CAUTION

### **Be careful in moving the projector.**

Neglect could result in an injury or damage.

- Do not move the projector during use. Before moving, disconnect the power cord and all external connections, and close the slide lens door or attach the lens cap.
- Avoid any impact or shock to the projector.
- Do not drag the projector.
- For moving the projector, use the enclosed case or bag if provided.



### **Do not put anything on top of the projector.**

Placing anything on the projector could result in loss of balance or falling, and cause an injury or damage. Use special caution in households where children are present.



### **Do not attach anything other than specified things to the projector.**

Neglect could result in an injury or damage.

- Some projector has a screw thread in a lens part. Do not attach anything other than specified options (such as conversion lens) to the screw thread.



### **Avoid a smoky, humid or dusty place.**

Placing the projector in a smoke, a highly humid, dusty place, oily soot or corrosive gas could result in fire or electrical shock.

- Do not place the projector near a smoky, humid or dusty place (ex. a smoking space, a kitchen, a beach, etc.). Do not place the projector outdoors.
- Do not use a humidifier near the projector.



### **Take care of the air filter to normal ventilate.**

The air filter should be cleaned periodically. If the air filter becomes clogged by dust or the like, internal temperature rises and could cause malfunction. The projector may display the message such as "CHECK THE AIR FLOW" or turn off the projector, to prevent the internal heat level rising.

- When the indicators or a message prompts you to clean the air filter, clean the air filter as soon as possible.
- If the soiling will not come off the air filter, or it becomes damaged, replace the air filter.
- Use the air filter of the specified type only. Please order the air filter specified in the other manual of this projector to your dealer.
- When you replace the lamp, replace also the air filter. The air filter may be attached when you buy a replacement lamp for this projector.
- Do not turn on the projector without air filter.



### **Avoid a high temperature environment.**

The heat could have adverse influence on the cabinet of the projector and other parts. Do not place the projector, the remote control and other parts in direct sunlight or near a hot object such as heater, etc.



### **Avoid Magnetism.**

Manufacture strongly recommends to avoid any magnetic contact that is not shielded or protected on or near the projector itself. (ie., Magnetic Security Devices, or other projector accessory that contains magnetic material that has not been provided by the manufacture etc.) Magnetic objects may cause interruption of the projector's internal mechanical performance which may interfere with cooling fans speed or stopping, and may cause the projector to completely shut down.



# Safety Precautions (continued)

## CAUTION

### **Remove the power cord for complete separation.**

- For safety purposes, disconnect the power cord if the projector is not to be used for prolonged periods of time.
- Before cleaning, turn off and unplug the projector. Neglect could result in fire or electrical shock.

### **Ask your dealer to cleaning inside of the projector about every year.**

Accumulations of dust inside the projector cause result in fire or malfunction. Cleaning inside is more effective if performed before every humid periods such as rainy season.

- Do not clean inside yourself because it is dangerous.



Disconnect the plug from the power outlet.



## NOTE

### **Do not give the remote control any physical impact.**

A physical impact could cause damage or malfunction of the remote control.

- Take care not to drop the remote control.
- Do not place the projector or heavy objects on the remote control.

### **Take care of the lens.**

- Close the slide lens door or attach the lens cap to prevent the lens surface being scratched when the projector is not used.
- Do not touch the lens to prevent fog or dirt of the lens that cause deterioration of display quality.
- Use commercially available lens tissue to clean the lens (used to clean cameras, eyeglasses, etc.). Be careful not to scratch the lens with hard objects.

### **Take care of the cabinet and the remote control.**

Incorrect care could have adverse influence such as discoloration, peeling paint, etc.

- Use a soft cloth to clean the cabinet and control panel of the projector and the remote control. When excessively soiled dilute a neutral detergent in water, wet and wring out the soft cloth and afterward wipe with a dry soft cloth. Do not use undiluted detergent directly.
- Do not use an aerosol sprays, solvents, volatile substances or abrasive cleaner.
- Before using chemical wipes, be sure to read and observe the instructions.
- Do not allow long-term close contact with rubber or vinyl.

### **About bright spots or dark spots.**

Although bright spots or dark spots may appear on the screen, this is a unique characteristic of liquid crystal displays, and such do not constitute or imply a machine defect.

### **Be careful of printing of the LCD panel.**

If the projector continues projecting a still image, inactive images or 16:9 aspect images in case of 4:3 panel, etc., for long time, the LCD panel might possibly be printed.

# Safety Precautions (continued)

## NOTE

### **About consumables.**

Lamp, LCD panels, polarizers and other optical components, and air filter and cooling fans have a different lifetime in each. These parts may need to be replaced after a long usage time.

- This product isn't designed for continuous use of long time. In the case of continuous use for 6 hours or more, or use for 6 hours or more every day (even if it isn't continuous), or repetitious use, the lifetime may be shortened, and these parts may need to be replaced even if one year has not passed since the beginning of using.
- Any inclining use beyond the adjustment range explained in these user's manuals may shorten the lifetimes of the consumables.

### **Before turning on the power, make the projector cool down adequately.**

After turning the projector off, pushing the restart switch or interrupting of the power supply, make the projector cool down adequately. Operation in a high temperature state of the projector causes a damage of the electrode and un-lighting of the lamp.

### **Avoid strong rays.**

Any strong ray (such as direct rays of the sun or room lighting) onto the remote control sensors could invalidate the remote control.

### **Avoid radio interference.**

Any interfering radiation could cause disordered image or noises.

- Avoid radio generator such as a mobile telephone, transceiver, etc. around the projector.

### **About displaying characteristic.**

The display condition of the projector (such as color, contrast, etc.) depends on characteristic of the screen, because the projector uses a liquid crystal display panel. The display condition can differ from the display of CRT.

- Do not use a polarized screen. It can cause red image.

### **Turn the power on/off in right order.**

To prevent any trouble, turn on/off the projector in right order mentioned below unless specifying.

- Power on the projector before the computer or video tape recorder.
- Power off the projector after the computer or video tape recorder.

### **Take care not to fatigue your eyes.**

Rest the eyes periodically.

### **Set the sound volume at a suitable level to avoid bothering other people.**

- It is better to keep the volume level low and close the windows at night to protect the neighborhood environment.

### **Connecting with notebook computer**

When connecting with notebook computer, set to valid the RGB external image output (setting CRT display or simultaneous display of LCD and CRT).

Please read instruction manual of the notebook for more information.



# Lamp

## **WARNING**



HIGH VOLTAGE



HIGH TEMPERATURE



HIGH PRESSURE

The projector uses a high-pressure mercury glass lamp. The lamp can **break with a loud bang, or burn out**, if jolted or scratched, handled while hot, or worn over time. Note that each lamp has a different lifetime, and some may burst or burn out soon after you start using them. In addition, when the bulb bursts, it is possible for **shards of glass** to fly into the lamp housing, and for **gas containing mercury** to escape from the projector's vent holes.

**About disposal of a lamp** • This product contains a mercury lamp; do not put in trash. Dispose of in accord with environmental laws.

For lamp recycling, go to [www.lamprecycle.org](http://www.lamprecycle.org). (in USA)

For product disposal, contact your local government agency or [www.eiae.org](http://www.eiae.org) (in the US) or [www.epsc.ca](http://www.epsc.ca) (in Canada).

For more information, call your dealer.



Disconnect  
the plug from  
the power  
outlet

- If the lamp should break (it will make a loud bang when it does), unplug the power cord from the outlet, and make sure to request a replacement lamp from your local dealer. Note that shards of glass could damage the projector's internals, or cause injury during handling, so please do not try to clean the projector or replace the lamp yourself.
- If the lamp should break (it will make a loud bang when it does), ventilate the room well, and make sure not to breathe the gas that comes out of the projector vents, or get it in your eyes or mouth.
- Before replacing the lamp, make sure the power switch is off and the power cable is not plugged in, then wait at least 45 minutes for the lamp to cool sufficiently. Handling the lamp while hot can cause burns, as well as damaging the lamp.



- Do not open the lamp cover while the projector is suspended from above. This is dangerous, since if the lamp's bulb has broken, the shards will fall out when the cover is opened. In addition, working in high places is dangerous, so ask your local dealer to have the lamp replaced even if the bulb is not broken.
- Do not use the projector with the lamp cover removed. At the lamp replacing, make sure that the screws are screwed in firmly. Loose screws could result in damage or injury.



- Use the lamp of the specified type only.
- If the lamp breaks soon after the first time it is used, it is possible that there are electrical problems elsewhere besides the lamp. If this happens, contact your local dealer or a service representative.
- Handle with care: jolting or scratching could cause the lamp bulb to burst during use.
- Using the lamp for long periods of time, could cause it dark, not to light up or to burst. When the pictures appear dark, or when the color tone is poor, please replace the lamp as soon as possible. Do not use old (used) lamps; this is a cause of breakage.

# Regulatory Notices

## FCC Statement Warning

This device complies with part 15 of the FCC Rules. Operation is subject to the following two conditions: (1) This device may not cause harmful interference, and (2) this device must accept any interference received, including interference that may cause undesired operation.

**WARNING:** This equipment has been tested and found to comply with the limits for a Class B digital device, pursuant to Part 15 of the FCC Rules. These limits are designed to provide reasonable protection against harmful interference in a residential installation. This equipment generates, uses, and can radiate radio frequency energy and, if not installed and used in accordance with the instructions, may cause harmful interference to radio communications. However, there is no guarantee that interference will not occur in a particular installation. If this equipment does cause harmful interference to radio or television reception, which can be determined by turning the equipment off and on, the user is encouraged to try to correct the interference by one or more of the following measures:

- Reorient or relocate the receiving antenna.
- Increase the separation between the equipment and receiver.
- Connect the equipment into an outlet on a circuit different from that to which the receiver is connected.
- Consult the dealer or an experienced radio/TV technician for help.

**INSTRUCTIONS TO USERS:** This equipment complies with the requirements of FCC (Federal Communication Commission) equipment provided that the following conditions are met. Some cables have to be used with the core set. Use the accessory cable or a designated-type cable for the connection. For cables that have a core only at one end, connect the core to the projector.

**CAUTION:** Changes or modifications not expressly approved by the party responsible for compliance could void the user's authority to operate the equipment.

## For the Customers in CANADA

**NOTICE:** This Class B digital apparatus complies with Canadian ICES-003.

# Warranty And After-Service

Unless seen any abnormal operations (mentioned with the first paragraph of WARNING in this manual), when a problem occurs with the equipment, first refer to the "Troubleshooting" section of the "Operating Guide", and run through the suggested checks. If this does not resolve the problem contact your dealer or service company. They will tell you what warranty condition is applied.

Contents

<b>About this manual</b> . . . . .	<b>1</b>		<b>PICTURE menu</b> . . . . .	<b>26</b>	
<b>Contents</b> . . . . .	<b>2</b>		BRIGHTNESS, CONTRAST, GAMMA, COLOR TEMP, COLOR, TINT, SHARPNESS, MY MEMORY		
<b>Projector features</b> . . . . .	<b>3</b>		<b>IMAGE menu</b> . . . . .	<b>29</b>	
<b>Preparations</b> . . . . .	<b>3</b>		ASPECT, OVER SCAN, V POSITION, H POSITION, H PHASE, H SIZE, AUTO ADJUST EXECUTE		
Checking the contents of package . . . . .	3		<b>INPUT menu</b> . . . . .	<b>31</b>	
<b>Part names</b> . . . . .	<b>4</b>		PROGRESSIVE, VIDEO NR, COLOR SPACE, COMPONENT, VIDEO FORMAT, COMPUTER IN, FRAME LOCK, RESOLUTION		
Projector . . . . .	4		<b>SETUP menu</b> . . . . .	<b>34</b>	
Control panel . . . . .	5		AUTO KEYSTONE EXECUTE, KEYSTONE, ECO MODE, MIRROR, STANDBY MODE, MONITOR OUT		
Rear panel . . . . .	5		<b>AUDIO menu</b> . . . . .	<b>36</b>	
Remote control . . . . .	6		VOLUME, SPEAKER, AUDIO SOURCE		
<b>Setting up</b> . . . . .	<b>7</b>		<b>SCREEN menu</b> . . . . .	<b>37</b>	
Arrangement . . . . .	7		LANGUAGE, MENU POSITION, BLANK, START UP, MyScreen, MyScreen Lock, MESSAGE, SOURCE NAME, TEMPLATE, C.C.		
Connecting your devices . . . . .	9		<b>OPTION menu</b> . . . . .	<b>42</b>	
Connecting power supply . . . . .	11		AUTO SEARCH, AUTO KEYSTONE, DIRECT ON, AUTO OFF, LAMP TIME, FILTER TIME, MY BUTTON, MY SOURCE, SERVICE		
Using the security bar and slot . . . . .	11		<b>SECURITY menu</b> . . . . .	<b>47</b>	
<b>Remote control</b> . . . . .	<b>12</b>		SECURITY PASSWORD CHANGE, MyScreen PASSWORD, PIN LOCK, TRANSITION DETECTOR, MY TEXT PASSWORD, MY TEXT DISPLAY, MY TEXT WRITING		
Installing the batteries . . . . .	12		<b>Maintenance</b> . . . . .	<b>53</b>	
About the remote control signal . . . . .	12		Replacing the lamp . . . . .	53	
Changing the frequency of remote control signal . . . . .	13		Cleaning and replacing the air filter . . . . .	55	
Using as a simple PC mouse & keyboard . . . . .	13		Other care . . . . .	57	
<b>Power on/off</b> . . . . .	<b>14</b>		<b>Troubleshooting</b> . . . . .	<b>58</b>	
Turning on the power . . . . .	14		Related messages . . . . .	58	
Turning off the power . . . . .	14		Regarding the indicator lamps . . . . .	59	
<b>Operating</b> . . . . .	<b>15</b>		Shutting the projector down . . . . .	60	
Adjusting the volume . . . . .	15		Resetting all settings . . . . .	60	
Temporarily muting the sound . . . . .	15		Phenomena that may be easy to be mistaken for machine defects . . . . .	61	
Selecting an input signal . . . . .	15		<b>Specifications</b> . . . . .	<b>64</b>	
Searching an input signal . . . . .	17				
Selecting an aspect ratio . . . . .	17				
Adjusting the projector's elevator . . . . .	18				
Adjusting the zoom and focus . . . . .	18				
Using the automatic adjustment feature . . . . .	19				
Adjusting the position . . . . .	19				
Correcting the keystone distortions . . . . .	20				
Using the magnify feature . . . . .	20				
Temporary freezing the screen . . . . .	21				
Temporarily blanking the screen . . . . .	21				
Using the menu function . . . . .	22				
<b>EASY MENU</b> . . . . .	<b>24</b>				
ASPECT, AUTO KEYSTONE EXECUTE, KEYSTONE, PICTURE MODE, ECO MODE, MIRROR, RESET, FILTER TIME, LANGUAGE, ADVANCED MENU, EXIT					

## Projector features

The projector provides you with the broad use by the following features.

- ✓ This projector has a variety of I/O ports that supposedly cover for any business scene.
- ✓ This projector realizes the large projection image, even if in a small space.
- ✓ The new double layer filter system is expected to function longer and offers you less maintenance frequency.

## Preparations

### Checking the contents of package

Your projector should come with the items shown below. Check that all the items are included. Require of your dealer immediately if any items are missing.

- (1) Remote control with two AA batteries
- (2) Power cord
- (3) Computer cable
- (4) Lens cover
- (5) User's manuals (Book x1, CD x1)
- (6) Security label

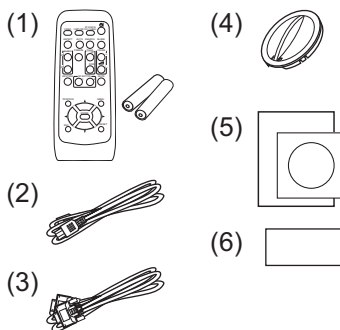

**NOTE** • Keep the original packing materials, for future reshipment. Be sure to use the original packing materials when moving the projector. Use special caution for the lens.

Part names

**Projector**

- (1) Lamp cover (📖53)  
The lamp unit is inside.
- (2) Focus ring (📖18)
- (3) Zoom ring (📖18)
- (4) Control panel (📖5)
- (5) Elevator buttons (x 2) (📖18)
- (6) Elevator feet (x 2) (📖18)
- (7) Remote sensor (📖12)
- (8) Lens (📖57)
- (9) Intake vents
- (10) Filter cover (📖55)  
The air filter and intake vent are inside.
- (11) Speaker (📖36)
- (12) Exhaust vent
- (13) **AC IN** (AC inlet) (📖11)
- (14) Rear panel (📖5)
- (15) Security bar (📖11)
- (16) Security slot (📖11)

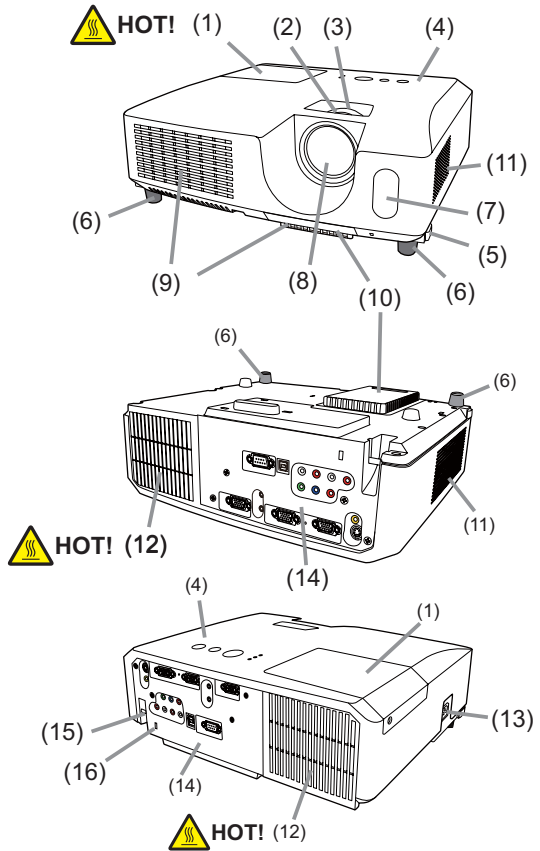

**⚠ WARNING ►HOT!** : Do not touch around the lamp cover and the exhaust vents during use or just after use, since it is too hot.

- Do not look into the lens or vents while the lamp is on, since the strong light is not good for your eyes.
- Do not handle the elevator buttons without holding the projector, since the projector may drop down.

**⚠ CAUTION ►** Maintain normal ventilation to prevent the projector from heating up. Do not cover, block or plug up the vents. Do not place anything that can stick or be sucked to the vents, around the intake vents. Clean the air filter periodically.

- Do not use the security bar and slot to prevent the projector from falling down, since it is not designed for it.

## Control panel

- (1) **STANDBY/ON** button (📖14)
- (2) **INPUT** button (📖15, 22)
- (3) **MENU** button (📖22)  
It consists of four cursor buttons.
- (4) **POWER** indicator (📖11, 14, 59)
- (5) **TEMP** indicator (📖59)
- (6) **LAMP** indicator (📖59)

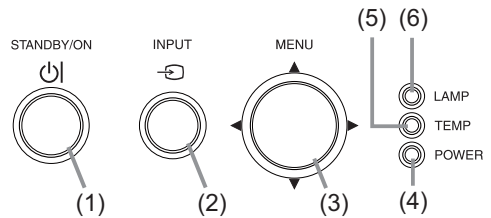

## Rear panel (📖9)

- (1) **AUDIO IN1** port
- (2) **AUDIO IN2** port
- (3) **COMPUTER IN1** port
- (4) **COMPUTER IN2** port
- (5) **MONITOR OUT** port
- (6) Shutdown switch (📖60)
- (7) **CONTROL** port
- (8) **USB** port (📖13)
- (9) **COMPONENT** (Y, Cb/Pb, Cr/Pr) ports
- (10) **VIDEO** port
- (11) **S-VIDEO** port
- (12) **AUDIO IN3 (R, L)** ports
- (13) **AUDIO OUT (R, L)** ports

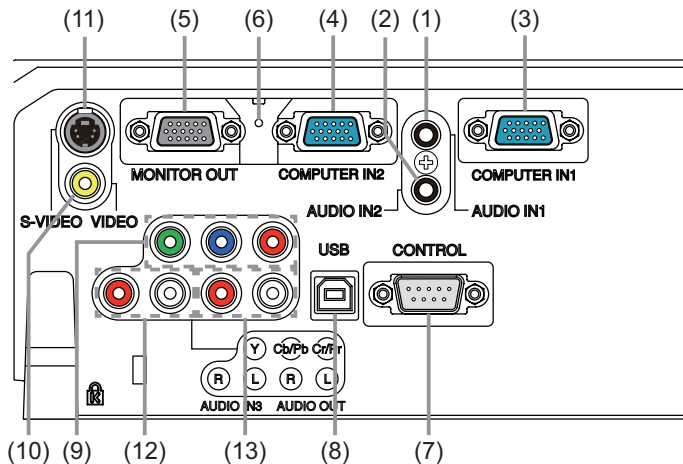

**⚠ CAUTION** ► Use the shutdown switch only when the projector is not turned off by normal procedure, since pushing this switch stops operation of the projector without cooling it down.

## Remote control

- (1) VIDEO button (📖16)
- (2) COMPUTER button (📖16)
- (3) SEARCH button (📖17)
- (4) STANDBY/ON button (📖14)
- (5) ASPECT button (📖17)
- (6) AUTO button (📖19)
- (7) BLANK button (📖21)
- (8) MAGNIFY - ON button (📖20)
- (9) MAGNIFY - OFF button (📖13, 20)
- (10) MY SOURCE/DOC.CAMERA button (📖16, 44)
- (11) VOLUME - button (📖13, 15)
- (12) PAGE UP button (📖13)
- (13) PAGE DOWN button (📖13)
- (14) VOLUME + button (📖15)
- (15) MUTE button (📖15)
- (16) FREEZE button (📖21)
- (17) MY BUTTON - 1 button (📖44)
- (18) MY BUTTON - 2 button (📖44)
- (19) KEYSTONE button (📖20)
- (20) POSITION button (📖19, 20, 23)
- (21) MENU button (📖22)
- (22) ▲/▼/◀/▶ cursor buttons (📖13, 22)
- (23) ENTER button (📖13, 22)
- (24) ESC button (📖13, 22)
- (25) RESET button (📖13, 22)
- (26) Battery cover (📖12)

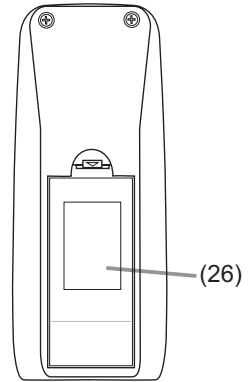
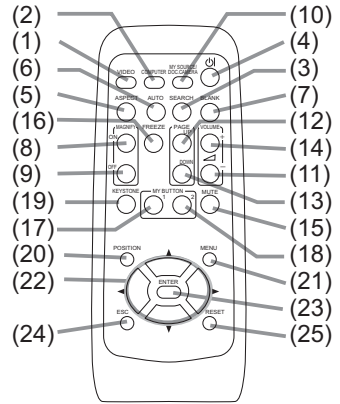

Back of  
the remote control

## Setting up

Install the projector according to the environment and manner the projector will be used in.

### Arrangement

Refer to the illustrations and tables below to determine screen size and projection distance.

The values shown in the table are calculated for a full size screen: 1024 x 768

- (a) Screen size (diagonal)
- (b) Projection distance ( $\pm 10\%$ )
- (c1), (c2) Screen height ( $\pm 10\%$ )

#### On a horizontal surface

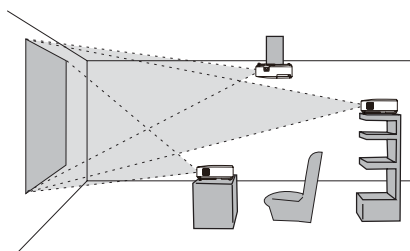
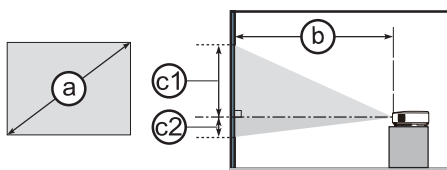

#### Suspended from the ceiling

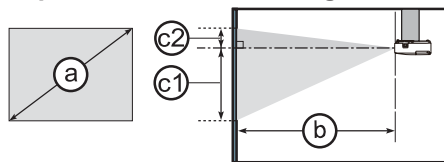

- Keep a space of 30 cm or more between the sides of the projector and other objects such as walls.
- For the case of installation in a special state such as ceiling mount, the specified mounting accessories (64) and service may be required. Before installing the projector, consult your dealer about your installation.

(a) Screen size (diagonal)		4 : 3 screen								16 : 9 screen							
		(b) Projection distance				(c1) Screen height		(c2) Screen height		(b) Projection distance				(c1) Screen height		(c2) Screen height	
		min.		max.		cm		inch		min.		max.		cm		inch	
type (inch)	m	m	inch	m	inch	cm	inch	cm	inch	m	inch	m	inch	cm	inch	cm	inch
30	0.8	0.9	34	1.0	41	41	16	5	2	1.0	38	1.1	45	39	15	-1	0
40	1.0	1.2	46	1.4	55	55	22	6	2	1.3	51	1.5	60	51	20	-2	-1
50	1.3	1.5	58	1.8	69	69	27	8	3	1.6	64	1.9	76	64	25	-2	-1
60	1.5	1.8	70	2.1	83	82	32	9	4	1.9	77	2.3	91	77	30	-2	-1
70	1.8	2.1	82	2.5	97	96	38	11	4	2.3	89	2.7	106	90	35	-3	-1
80	2.0	2.4	94	2.8	112	110	43	12	5	2.6	102	3.1	122	103	41	-3	-1
90	2.3	2.7	106	3.2	126	123	49	14	5	2.9	115	3.5	137	116	46	-4	-1
100	2.5	3.0	118	3.6	140	137	54	15	6	3.3	128	3.9	153	129	51	-4	-2
120	3.0	3.6	142	4.3	168	165	65	18	7	3.9	154	4.7	183	154	61	-5	-2
150	3.8	4.5	177	5.3	211	206	81	23	9	4.9	193	5.8	229	193	76	-6	-2
200	5.1	6.0	237	7.1	281	274	108	30	12	6.6	258	7.8	306	257	101	-8	-3
250	6.4	7.5	297	8.9	352	343	135	38	15	8.2	323	9.7	383	322	127	-10	-4
300	7.6	9.0	356	10.7	422	411	162	46	18	9.9	388	11.7	460	386	152	-12	-5



**Arrangement (continued)**

**⚠ WARNING** ► Place the projector in a stable horizontal position. If the projector falls or is knocked over, it could cause injury and/or damage to the projector. Using a damaged projector could then result in fire and/or electric shock.

- Do not place the projector on an unstable, slanted or vibrational surface such as a wobbly or inclined stand.
- Do not place the projector on its side, front or rear position.
- Consult with your dealer before a special installation such as suspending from a ceiling or somewhere else.
- Place the projector in a cool place, and ensure that there is sufficient ventilation. The high temperature of the projector could cause fire, burns and/or malfunction of the projector.
- Do not stop-up, block or otherwise cover the projector's vents.
- Keep a space of 30 cm or more between the sides of the projector and other objects such as walls.
- Do not place the projector on metallic thing or anything weak in heat.
- Do not place the projector on carpet, cushions or bedding.
- Do not place the projector in direct sunlight or near hot objects such as heaters.
- Do not place anything near the projector lens or vents, or on top of the projector.
- Do not place anything that may be sucked into or stick to the vents on the bottom of the projector. This projector has some intake vents also on the bottom.
- Do not place the projector anywhere where it may get wet. Getting the projector wet or inserting liquid into the projector could cause fire, electric shock and/or malfunction of the projector.
- Do not place the projector in a bathroom or the outdoors.
- Do not place anything containing liquid near the projector.
- Use only the mounting accessories the manufacturer specified, and leave installing and removing the projector with the mounting accessories to the service personnel.
- Read and keep the user's manual of the mounting accessories used.

**⚠ CAUTION** ► Avoid placing the projector in smoky, humid or dusty place. Placing the projector in such places could cause fire, electric shock and/or malfunction of the projector.

- Do not place the projector near humidifiers, smoking spaces or a kitchen.
- Position the projector to prevent light from directly hitting the projector's remote sensor.

## Connecting your devices

Be sure to read the manuals for devices before connecting them to the projector. Make sure that all the devices are suitable to be connected with this product, and prepare the cables required to connect. Please refer to the following illustrations to connect them.

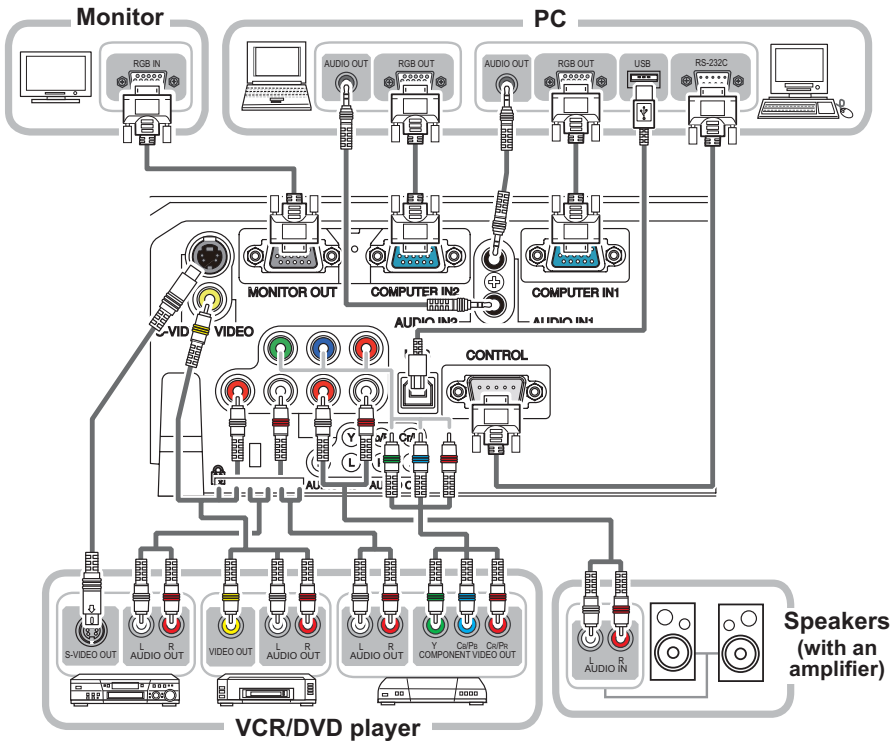

**⚠ WARNING** ▶ Do not disassemble or modify the projector and accessories.

▶ Be careful not to damage the cables, and do not use damaged cables.

**⚠ CAUTION** ▶ Turn off all devices and unplug their power cords prior to connecting them to projector. Connecting a live device to the projector may generate extremely loud noises or other abnormalities that may result in malfunction or damage to the device and the projector.

▶ Use appropriate accessory or designated cables. Ask your dealer about non-accessory cables which may be required a specific length or a ferrite core by the regulations. For cables with a core only at one end, connect the end with the core to the projector.

▶ Make sure that devices are connected to the correct ports. An incorrect connection may result in malfunction or damage to the device and the projector.

**NOTICE** ▶ Use the cables with straight plugs, not L-shaped ones, as the input ports of the projector are recessed.

## Connecting your devices (continued)

**NOTE** • Be sure to read the manuals for devices before connecting them to the projector, and make sure that all the devices are suitable to be connected with this product. Before connecting to a PC, check the signal level, the signal timing, and the resolution.

- Some signal may need an adapter to input this projector.
- Some PCs have multiple screen display modes that may include some signals which are not supported by this projector.
- Although the projector can display signals with resolution up to UXGA (1600X1200), the signal will be converted to the projector's panel resolution before being displayed. The best display performance will be achieved if the resolutions of the input signal and the projector panel are identical.
- While connecting, make sure that the shape of the cable's connector fits the port to connect with. And be sure to tighten the screws on connectors with screws.
- When connecting a laptop PC to the projector, be sure to activate the PC's external RGB output. (Set the laptop PC to CRT display or to simultaneous LCD and CRT display.) For details on how this is done, please refer to the instruction manual of the corresponding laptop PC.
- When the picture resolution is changed on a PC depending on an input, automatic adjustment function may take some time and may not be completed. In this case, you may not be able to see a check box to select "Yes/No" for the new resolution on Windows. Then the resolution will go back to the original. It might be recommended to use other CRT or LCD monitors to change the resolution.
- In some cases, this projector may not display a proper picture or display any picture on screen. For example, automatic adjustment may not function correctly with some input signals. An input signal of composite sync or sync on G may confuse this projector, so the projector may not display a proper picture.

### **About Plug-and-Play capability**

Plug-and-Play is a system composed of a PC, its operating system and peripheral equipment (i.e. display devices). This projector is VESA DDC 2B compatible. Plug-and-Play can be used by connecting this projector to a PC that is VESA DDC (display data channel) compatible.

- Take advantage of this feature by connecting an RGB cable to the **COMPUTER IN1** port (DDC 2B compatible). Plug-and-Play may not work properly if any other type of connection is attempted.
- Please use the standard drivers in your PC as this projector is a Plug-and-Play monitor.

## Connecting power supply

1. Put the connector of the power cord into the **AC IN** (AC inlet) of the projector.
2. Firmly plug the power cord's plug into the outlet. In a couple of seconds after the power supply connection, the **POWER** indicator will light up in steady orange.

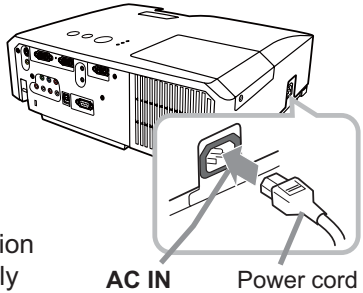

Please remember that when the DIRECT ON function activated (42), the connection of the power supply make the projector turn on.

**⚠ WARNING** ▶ Please use extra caution when connecting the power cord, as incorrect or faulty connections may result in fire and/or electrical shock.

- Only use the power cord that came with the projector. If it is damaged, consult your dealer to get a new one.
- Only plug the power cord into an outlet whose voltage is matched to the power cord. The power outlet should be close to the projector and easily accessible. Remove the power cord for complete separation.
- Never modify the power cord.

## Using the security bar and slot

A commercial anti-theft chain or wire up to 10 mm in diameter can be attached to the security bar on the projector. Also this product has the security slot for the Kensington lock. For details, see the manual of the security tool.

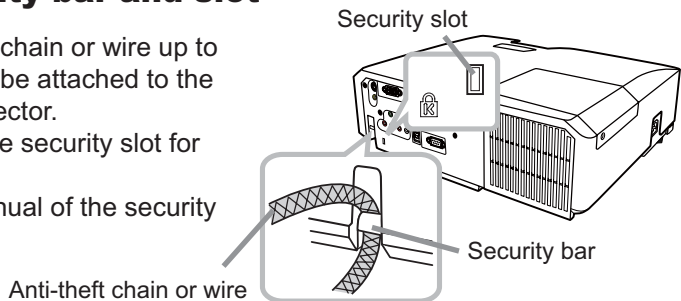

**⚠ WARNING** ▶ Do not use the security bar and slot to prevent the projector from falling down, since it is not designed for it.

**⚠ CAUTION** ▶ Do not place anti-theft chain or wire near the exhaust vents. It may become too hot.

**NOTE** • The security bar and slot is not comprehensive theft prevention measures. It is intended to be used as supplemental theft prevention measure.

## Remote control

**Installing the batteries**

Please insert the batteries into the remote control before using it. If the remote control starts to malfunction, try to replace the batteries. If you will not use the remote control for long period, remove the batteries from the remote control and store them in a safe place.

1. Holding the hook part of the battery cover, remove it.
2. Align and insert the two AA batteries (**HITACHI MAXELL, Part No.LR6 or R6P**) according to their plus and minus terminals as indicated in the remote control.
3. Replace the battery cover in the direction of the arrow and snap it back into place.

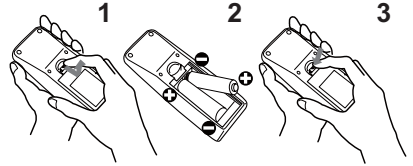

**⚠ WARNING** ▶ Always handle the batteries with care and use them only as directed. Improper use may result in battery explosion, cracking or leakage, which could result in fire, injury and/or pollution of the surrounding environment.

- Be sure to use only the batteries specified. Do not use batteries of different types at the same time. Do not mix a new battery with used one.
- Make sure the plus and minus terminals are correctly aligned when loading a battery.
- Keep a battery away from children and pets.
- Do not recharge, short circuit, solder or disassemble a battery.
- Do not place a battery in a fire or water. Keep batteries in a dark, cool and dry place.
- If you observe battery leakage, wipe out the leakage and then replace a battery. If the leakage adheres to your body or clothes, rinse well with water immediately.
- Obey the local laws on disposing the battery.

**About the remote control signal**

The remote control works with the projector's remote sensor. This projector has a remote sensor on the front. The sensor senses the signal within the following range when the sensor is active:

60 degrees (30 degrees to the left and right of the sensor)  
within 3 meters about.

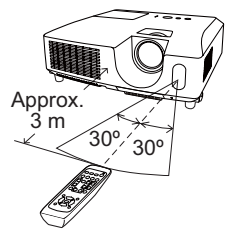

**NOTE** • The remote control signal reflected in the screen or the like may be available. If it is difficult to send the signal to the sensor directly, attempt to make the signal reflect.

- The remote control uses infrared light to send signals to the projector (Class 1 LED), so be sure to use the remote control in an area free from obstacles that could block the remote control's signal to the projector.
- The remote control may not work correctly if strong light (such as direct sun light) or light from an extremely close range (such as from an inverter fluorescent lamp) shines on the remote sensor of the projector. Adjust the position of projector avoiding those lights.

## Changing the frequency of remote control signal

The accessory remote control has the two choices on signal frequency Mode 1:NORMAL and Mode 2:HIGH. If the remote control does not function properly, attempt to change the signal frequency. In order to set the Mode, please keep pressing the combination of two buttons listed below simultaneously for about 3 seconds.

- (1) Set to Mode 1:NORMAL... **VOLUME -** and **RESET** buttons
- (2) Set to Mode 2:HIGH... **MAGNIFY OFF** and **ESC** buttons

Please remember that the REMOTE FREQ. in the SERVICE item of the OPTION menu (46) of the projector to be controlled should be set to the same mode as the remote control.

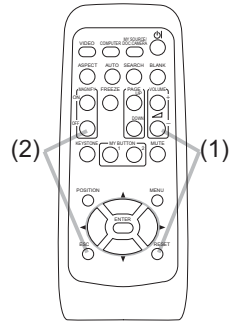

## Using as a simple PC mouse & keyboard

The accessory remote control works as a simple mouse and keyboard of the PC, when the projector's **USB** port (B type) connects with the PC's USB port (A type) port via a mouse cable.

- (1) **PAGE UP key:** Press **PAGE UP** button.
- (2) **PAGE DOWN key:** Press **PAGE DOWN** button.
- (3) **Mouse left button:** Press **ENTER** button.
- (4) **Move pointer:** Use the cursor buttons **▲**, **▼**, **◀** and **▶**.
- (5) **ESC key:** Press **ESC** button.
- (6) **Mouse right button:** Press **RESET** button.

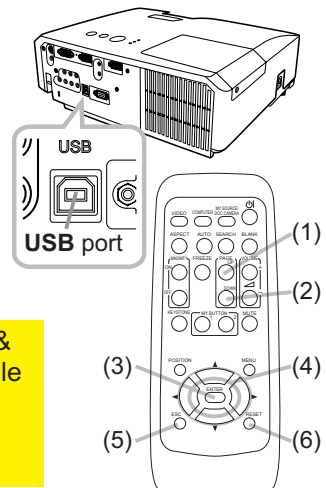

**⚠ WARNING** ▶ Improper use of the simple mouse & keyboard function could damage your equipment. While using this function, please connect this product only to a PC. Be sure to check your PC's manuals before connecting this product to the PC.

**NOTE** • When the simple mouse & keyboard function of this product does not work correctly, please check the following.

- When a USB cable connects this projector with a PC having a built-in pointing device (e.g. track ball) like a notebook PC, open BIOS setup menu, then select the external mouse and disable the built-in pointing device, because the built-in pointing device may have priority to this function.
- Windows 95 OSR 2.1 or higher is required for this function. And also this function may not work depending on the PC's configurations and mouse drivers. This function can work with the PC which can operate general USB mouse or keyboard.
- You cannot do things like press two buttons at once (for instance, pressing two buttons at the same time to move the mouse pointer diagonally).
- This function is activated only when the projector is working properly. This function is not available while the lamp is warming up (the **POWER** indicator blinks green), and while adjusting the volume and display, correcting for keystone, zooming in on the screen, using the BLANK function, or displaying the menu screen.

## Power on/off

**Turning on the power**

1. Make sure that the power cord is firmly and correctly connected to the projector and the outlet.
2. Make sure that the **POWER** indicator is steady orange (☞59). Then remove the lens cover.
3. Press **STANDBY/ON** button on the projector or the remote control.  
The projection lamp will light up and **POWER** indicator will begin blinking in green. When the power is completely on, the indicator will stop blinking and light in steady green (☞59).

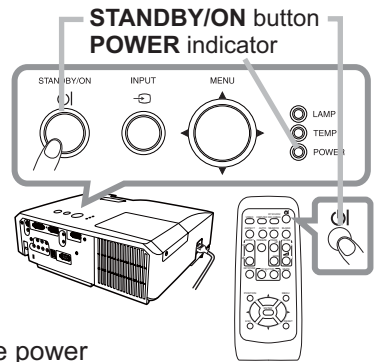

To display the picture, select an input signal according to the section “Selecting an input signal” (☞15).

**Turning off the power**

1. Press the **STANDBY/ON** button on the projector or the remote control. The message “Power off?” will appear on the screen for about 5 seconds.
2. Press the **STANDBY/ON** button again while the message appears.  
The projector lamp will go off, and the **POWER** indicator will begin blinking in orange. Then **POWER** indicator will stop blinking and light in steady orange when the lamp cooling is complete (☞59).
3. Attach the lens cover, after the **POWER** indicator turns in steady orange.

Do not turn the projector on for about 10 minutes or more after turning it off. Turning the projector on again too soon could shorten the lifetime of some consumable parts of the projector.

**⚠ WARNING** ▶ A strong light is emitted when the projector’s power is on. Do not look into the lens of the projector or look inside of the projector through any of the projector’s openings.

▶ Do not touch around the lamp cover and the exhaust vents during use or just after use, since it is too hot.

**NOTE** • Turn the power on/off in right order. Please power on the projector prior to the connected devices.  
• This projector has the function that can make the projector automatically turn on/off. Please refer to the **DIRECT ON** (☞42) and **AUTO OFF** (☞43) items of the **OPTION** menu.  
• Use the shutdown switch (☞60) only when the projector is not turned off by normal procedure.

Operating

### Adjusting the volume

VOLUME +/- button

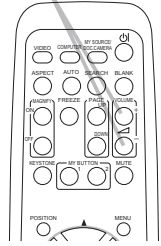

- Use the **VOLUME +/VOLUME -** buttons to adjust the volume.
  - A dialog will appear on the screen to aid you in adjusting the volume. If you do not do anything, the dialog will automatically disappear after a few seconds.
    - When  $\times$  is selected for current picture input port, the volume adjustment is disabled. Please see **AUDIO SOURCE** item of **AUDIO** menu (📖36).
    - When the projector is in the standby mode, the volume can be adjusted if  $\times$  is not selected for the **AUDIO OUT STANDBY** and **NORMAL** is selected to the **STANDBY MODE** in the **SETUP** menu (📖35).

### Temporarily muting the sound

MUTE button

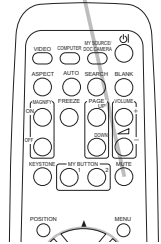

- Press **MUTE** button on the remote control.
  - A dialog will appear on the screen indicating that you have muted the sound.
    - To restore the sound, press the **MUTE**, **VOLUME +** or **VOLUME -** button. Even if you do not do anything, the dialog will automatically disappear after a few seconds.
      - When  $\times$  is selected for current picture input port, the sound is always muted. Please see **AUDIO SOURCE** item of **AUDIO** menu (📖36).
      - C.C. (Closed Caption) is automatically activated when sound is muted and an input signal containing C.C is received. This function is available only when the signal is **NTSC** for **VIDEO** or **S-VIDEO**, or **480i@60** for **COMPONENT**, **COMPUTER IN1** or **COMPUTER IN2**, and when **AUTO** is selected for **DISPLAY** in the **C.C.** menu under the **SCREEN** menu (📖41).

### Selecting an input signal

INPUT button

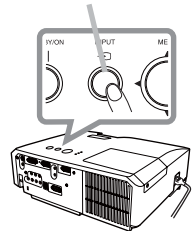

- Press **INPUT** button on the projector.
  - Each time you press the button, the projector switches its input port from the current port as below.
    - **COMPUTER IN 1** → **COMPUTER IN 2** → **VIDEO** ← **S-VIDEO** ← **COMPONENT (Y, Cb/Pb, Cr/Pr)** ←
  - While **ON** is selected for **AUTO SEARCH** item in **OPTION** menu (📖42), the projector will keep checking the ports in above order repeatedly till an input signal is detected.

(continued on next page)



### Selecting an input signal (continued)

1. Press **COMPUTER** button on the remote control.
  - Each time you press the button, the projector switches its input port from the current port as below.

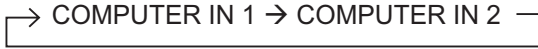

- While ON is selected for AUTO SEARCH item in OPTION menu, the projector will keep checking every port sequentially till an input signal is detected (42). If **COMPUTER** button is pressed when **VIDEO**, **S-VIDEO** or **COMPONENT** port is selected, the projector will check **COMPUTER IN1** port first.

**COMPUTER** button

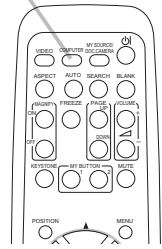

1. Press **VIDEO** button on the remote control.
  - Each time you press the button, the projector switches its input port from the current port as below.

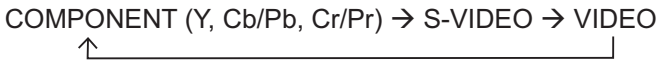

- While ON is selected for AUTO SEARCH item in OPTION menu, the projector will keep checking every port sequentially till an input signal is detected (42). If **VIDEO** button is pressed when **COMPUTER IN1** or **COMPUTER IN2** port is selected, the projector will check **COMPONENT** port first.

**VIDEO** button

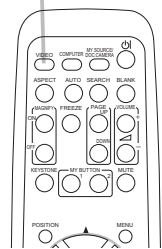

1. Press the **MY SOURCE / DOC. CAMERA** button on the remote control. The input signal will be changed into the signal you set as MY SOURCE (44).

- This function also can use for document camera. Select the input port that connected the document camera.

**MY SOURCE / DOC. CAMERA** button

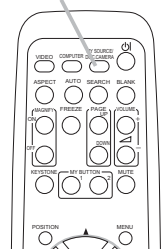

## Searching an input signal

1. Press **SEARCH** button on the remote control.
  - The projector will start to check its input ports as below in order to find any input signals. When an input is found, the projector will stop searching and display the image. If no signal is found, the projector will return to the state selected before the operation.



- While ON is selected for AUTO SEARCH item in OPTION menu (42), the projector will keep checking the ports in above order repeatedly till an input signal is detected.

SEARCH button

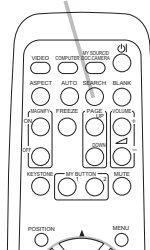

## Selecting an aspect ratio

1. Press **ASPECT** button on the remote control.
  - Each time you press the button, the projector switches the mode for aspect ratio in turn.

For a computer signal

NORMAL → 4:3 → 16:9 → 16:10



For a video signal, s-video signal or component video signal

4:3 → 16:9 → 14:9



For no signal

4:3 (fixed)

- **ASPECT** button does not work when no proper signal is inputted.
- **NORMAL** mode keeps the original aspect ratio setting.

ASPECT button

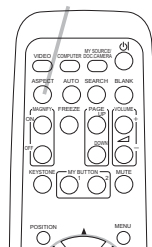

## Adjusting the projector's elevator

When the place to put the projector is slightly uneven to the left or right, use the elevator feet to place the projector horizontally.

Using the feet can also tilt the projector in order to project at a suitable angle to the screen, elevating the front side of the projector within 14 degrees.

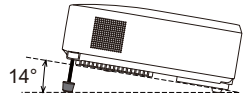

This projector has 2 elevator feet and 2 elevator buttons. An elevator foot is adjustable while pushing the elevator button on the same side as it.

1. Holding the projector, push the elevator buttons to loose the elevator feet.
2. Position the front side of the projector to the desired height.
3. Release the elevator buttons in order to lock the elevator feet.
4. After making sure that the elevator feet are locked, put the projector down gently.
5. If necessary, the elevator feet can be manually twisted to make more precise adjustments. Hold the projector when twisting the feet.

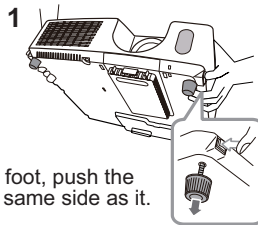

To loose an elevator foot, push the elevator button on the same side as it.

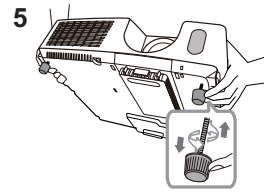

To finely adjust, twist the foot.

**⚠ CAUTION** ► Do not handle the elevator buttons without holding the projector, since the projector may drop down.  
 ► Do not tilt the projector other than elevating its front within 14 degrees using the adjuster feet. A tilt of the projector exceeding the restriction could cause malfunction or shortening the lifetime of consumables, or the projector itself.

## Adjusting the zoom and focus

1. Use the zoom ring to adjust the screen size.
2. Use the focus ring to focus the picture.

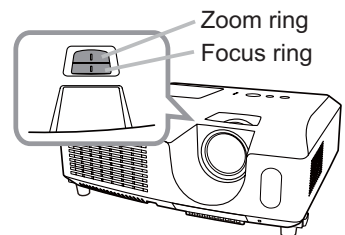

## Using the automatic adjustment feature

1. Press **AUTO** button on the remote control.
  - Pressing this button performs the following.
    - **For a computer signal**  
 The vertical position, the horizontal position and the horizontal phase will be automatically adjusted.  
 Make sure that the application window is set to its maximum size prior to attempting to use this feature. A dark picture may still be incorrectly adjusted. Use a bright picture when adjusting.
    - **For a video signal and s-video signal**  
 The video format best suited for the respective input signal will be selected automatically. This function is available only when the AUTO is selected for the VIDEO FORMAT item in the INPUT menu (432). The vertical position and horizontal position will be automatically set to the default.
    - **For a component video signal**  
 The vertical position, horizontal position and horizontal phase will be automatically set to the default.
      - The automatic adjustment operation requires approx. 10 seconds. Also please note that it may not function correctly with some input.
      - When this function is performed for a video signal, a certain extra such as a line may appear outside a picture.
      - When this function is performed for a computer signal, a black frame may be displayed on the edge of the screen, depending on the PC model.
      - The items adjusted by this function may vary when the FINE or DISABLE is selected for the AUTO ADJUST item of the SERVICE item in the OPTION menu (445).

AUTO button

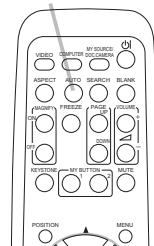

## Adjusting the position

1. Press **POSITION** button on the remote control when no menu is indicated.
    - The “POSITION” indication will appear on the screen.
  2. Use the ▲/▼/◀/▶ cursor buttons to adjust the picture position.
    - When you want to reset the operation, press **RESET** button on the remote control during the operation.  
 To complete this operation, press **POSITION** button again. Even if you do not do anything, the dialog will automatically disappear after a few seconds.
- When this function is performed on a video signal, s-video signal or component video signal, some image such as an extra-line may appear at outside of the picture.
  - When this function is performed on a video signal, s-video signal or component video signal, the range of this adjustment depends on OVER SCAN in IMAGE menu (429) setting. It is not possible to adjust when OVER SCAN is set to 10.
  - If **POSITION** button is pressed when a menu is indicated on screen, the displayed picture does not move its position but the menu does.

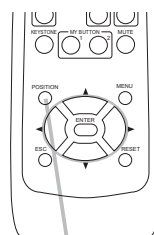

POSITION button

## Correcting the keystone distortions

1. Press **KEYSTONE** button on the remote control. A dialog will appear on the screen to aid you in correcting the distortion.
2. Use the  $\blacktriangle/\blacktriangledown$  cursor buttons to select **AUTO** or **MANUAL** operation, and press the  $\blacktriangleright$  button to perform the following.
  - (1) **AUTO** executes automatic vertical keystone correction.
  - (2) **MANUAL** displays a dialog for keystone correction.
 Use the  $\blacktriangleleft/\blacktriangleright$  buttons for adjustment.

To close the dialog and complete this operation, press **KEYSTONE** button again. Even if you do not do anything, the dialog will automatically disappear after a few seconds.

- The adjustable range of this function will vary among inputs. For some input, this function may not work well.
- When V:INVERT or H&V:INVERT is selected to the MIRROR item in the SETUP menu, if the projector screen is inclined or angled downward, automatic vertical keystone correction may not work correctly.
- When the zoom adjustment is set to the TELE (telephoto focus), this function may be excessive. This function should be used when the zoom adjustment is set to the full WIDE (wide-angle focus) whenever possible.
- When the projector is placed on the level (about  $\pm 3^\circ$ ), the automatic keystone distortion correction may not work.
- When the projector is inclined to near  $\pm 30$  degree or over, this function may not work well.
- This function will be unavailable when Transition Detector is on (50).

KEYSTONE button

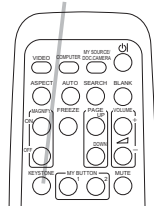
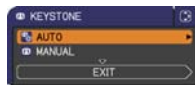

## Using the magnify feature

1. Press the **ON** button of **MAGNIFY** on the remote control.
    - The “MAGNIFY” indication will appear on the screen and the projector will go into the MAGNIFY mode. When the **ON** button of **MAGNIFY** is pressed first after the projector is started, the picture will be zoomed twice. The indication will disappear in several seconds with no operation.
  2. Use the  $\blacktriangle/\blacktriangledown$  cursor buttons to adjust the zoom level.
    - To move the zoom area, press the **POSITION** button in the MAGNIFY mode, then use the  $\blacktriangle/\blacktriangledown/\blacktriangleleft/\blacktriangleright$  cursor buttons to move the area. And to finalize the zoom area, press the **POSITION** button again.
    - To exit from the MAGNIFY mode and restore the screen to normal, press the **OFF** button of **MAGNIFY** on the remote control.
- The projector automatically exits from the MAGNIFY mode when the input signal is changed or when the display condition is changed.
  - In the MAGNIFY mode, the keystone distortion condition may vary, it will be restored when the projector exits from the MAGNIFY mode.

MAGNIFY ON/OFF button

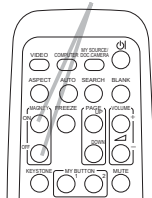

**NOTE** • The zoom level can be finely adjusted. Closely watch the screen to find the level you want.

## Temporary freezing the screen

1. Press the **FREEZE** button on the remote control.
  - The “FREEZE” indication will appear on the screen (however, the indication will not appear when the OFF is selected for the MESSAGE item in the SCREEN menu (📖39)), and the projector will go into the FREEZE mode, which the picture is frozen.

To exit the FREEZE mode and restore the screen to normal, press the **FREEZE** button again.

- The projector automatically exits from the FREEZE mode when some control buttons are pressed.
- If the projector continues projecting a still image for a long time, the LCD panel might possibly be burned in. Do not leave the projector in the FREEZE mode for too long.
- Images might appear degraded when this function is operated, but it is not a malfunction.

FREEZE button

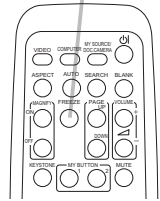

## Temporarily blanking the screen

1. Press **BLANK** button on the remote control.
  - The BLANK screen will be displayed instead of the screen of input signal. Please refer to BLANK item in SCREEN menu (📖37).

To exit from the BLANK screen and return to the input signal screen, press **BLANK** button again.

- The projector automatically exits from the BLANK mode when some control buttons are pressed.

BLANK button

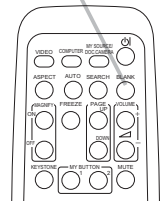

**NOTE** • The sound is not connected with the BLANK screen function. If necessary, set the volume or mute first. To display the BLANK screen and mute the sound at one time, use AV MUTE function (📖44).

## Using the menu function

This projector has the following menus:

PICTURE, IMAGE, INPUT, SETUP, AUDIO, SCREEN, OPTION, SECURITY and EASY MENU.

EASY MENU consists of functions often used, and the other menus are classified into each purpose and brought together as the ADVANCED MENU.

Each of these menus is operated using the same methods. While the projector is displaying any menu, the **MENU** button on the projector works as the cursor buttons. The basic operations of these menus are as follows.

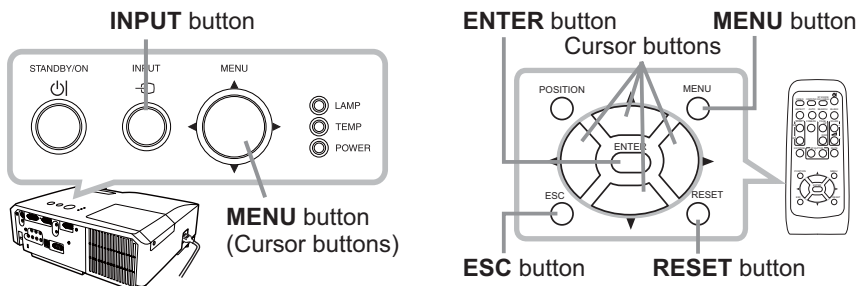

1. To start the MENU, press the **MENU** button. The MENU you last used (EASY or ADVANCED) will appear. EASY MENU has priority to appear just after powered on.

### 2. In the EASY MENU

- (1) Use the ▲/▼ cursor buttons to select an item to operate. If you want to change it to the ADVANCED MENU, select the ADVANCED MENU.
- (2) Use the ◀/▶ cursor buttons to operate the item.



### In the ADVANCED MENU

- (1) Use the ▲/▼ cursor buttons to select a menu. If you want to change it to the EASY MENU, select the EASY MENU. The items in the menu appear on the right side.
- (2) Press the ▶ cursor button or **ENTER** button to move the cursor to the right side. Then use the ▲/▼ cursor buttons to select an item to operate and press the ▶ cursor button or **ENTER** button to progress. The operation menu or dialog of the selected item will appear.
- (3) Use the buttons as instructed in the OSD to operate the item.



(continued on next page)

### Using the menu function (continued)

3. To close the MENU, press the **MENU** button again or select EXIT and press the ◀ cursor button or **ENTER** button. Even if you do not do anything, the dialog will automatically disappear after about 30 seconds.
  - If you want to move the menu position, use the cursor buttons after pressing the **POSITION** button.
  - Some functions cannot be performed when a certain input port is selected, or when a certain input signal is displayed.
  - When you want to reset the operation, press **RESET** button on the remote control during the operation. Note that some items (ex. LANGUAGE, VOLUME) cannot be reset.
  - In the ADVANCED MENU, when you want to return to the previous display, press the ◀ cursor button or **ESC** button on the remote control.

### Indication in OSD (On Screen Display)

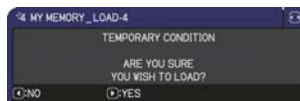
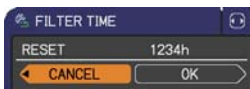

The meanings of the general words on the OSD are as follows.

Indication	Meaning
EXIT	Selecting this word finishes the OSD menu. It's the same as pressing the <b>MENU</b> button.
RETURN	Selecting this word returns the menu to the previous menu.
CANCEL or NO	Selecting this word cancels the operation in the present menu and returns to the previous menu.
OK or YES	Selecting this word executes the prepared function or shifts the menu to the next menu.



EASY MENU

From the EASY MENU, items shown in the table below can be performed.

Select an item using the ▲/▼ cursor buttons. Then perform it according to the following table.



Item	Description																								
<b>ASPECT</b>	Using the ◀/▶ buttons switches the mode for aspect ratio. See the ASPECT item in IMAGE menu ( 29).																								
<b>AUTO KEYSTONE EXECUTE</b>	Using the ▶ button executes the auto keystone function. See the AUTO KEYSTONE EXECUTE item in SETUP menu ( 34).																								
<b>KEYSTONE</b>	Using the ◀/▶ buttons corrects the vertical keystone distortion. See the KEYSTONE item in SETUP menu ( 34).																								
<b>PICTURE MODE</b>	<p>Using the ◀/▶ buttons switches the picture mode. The picture modes are combinations of GAMMA and COLOR TEMP settings. Choose a suitable mode according to the projected source.</p> <p>                     ↻ → NORMAL ⇔ CINEMA ⇔ DYNAMIC ⇔ BOARD(BLACK) ← ↻                      ↻ → DAYTIME ⇔ WHITEBOARD ⇔ BOARD(GREEN) ← ↻                 </p> <table border="1"> <thead> <tr> <th></th> <th>GAMMA</th> <th>COLOR TEMP</th> </tr> </thead> <tbody> <tr> <td>NORMAL</td> <td>1 DEFAULT</td> <td>2 MID</td> </tr> <tr> <td>CINEMA</td> <td>2 DEFAULT</td> <td>3 LOW</td> </tr> <tr> <td>DYNAMIC</td> <td>3 DEFAULT</td> <td>1 HIGH</td> </tr> <tr> <td>BOARD(BLACK)</td> <td>4 DEFAULT</td> <td>4 Hi-BRIGHT-1</td> </tr> <tr> <td>BOARD(GREEN)</td> <td>4 DEFAULT</td> <td>5 Hi-BRIGHT-2</td> </tr> <tr> <td>WHITEBOARD</td> <td>5 DEFAULT</td> <td>2 MID</td> </tr> <tr> <td>DAYTIME</td> <td>6 DEFAULT</td> <td>6 Hi-BRIGHT-3</td> </tr> </tbody> </table> <ul style="list-style-type: none"> <li>• When the combination of GAMMA and COLOR TEMP differs from pre-assigned modes above, the display on the menu for the PICTURE MODE is "CUSTOM". Please refer to the GAMMA and COLOR TEMP ( 26, 27) items in PICTURE menu.</li> <li>• Lines or other noise might appear on the screen when this function is operated, but it is not a malfunction.</li> </ul>		GAMMA	COLOR TEMP	NORMAL	1 DEFAULT	2 MID	CINEMA	2 DEFAULT	3 LOW	DYNAMIC	3 DEFAULT	1 HIGH	BOARD(BLACK)	4 DEFAULT	4 Hi-BRIGHT-1	BOARD(GREEN)	4 DEFAULT	5 Hi-BRIGHT-2	WHITEBOARD	5 DEFAULT	2 MID	DAYTIME	6 DEFAULT	6 Hi-BRIGHT-3
	GAMMA	COLOR TEMP																							
NORMAL	1 DEFAULT	2 MID																							
CINEMA	2 DEFAULT	3 LOW																							
DYNAMIC	3 DEFAULT	1 HIGH																							
BOARD(BLACK)	4 DEFAULT	4 Hi-BRIGHT-1																							
BOARD(GREEN)	4 DEFAULT	5 Hi-BRIGHT-2																							
WHITEBOARD	5 DEFAULT	2 MID																							
DAYTIME	6 DEFAULT	6 Hi-BRIGHT-3																							

(continued on next page)

Item	Description
<b>ECO MODE</b>	Using the ◀/▶ buttons turns off/on the eco mode. See the ECO MODE item in SETUP menu (📖34).
<b>MIRROR</b>	Using the ◀/▶ buttons switches the mode for mirror status. See the MIRROR item in SETUP menu (📖35).
<b>RESET</b>	Performing this item resets all of the EASY MENU items except the FILTER TIME and LANGUAGE. A dialog is displayed for confirmation. Selecting the OK using the ▶ button performs resetting.
<b>FILTER TIME</b>	The usage time of the air filter is shown in the menu. Performing this item resets the filter time which counts usage time of the air filter. A dialog is displayed for confirmation. Selecting the OK using the ▶ button performs resetting. See the FILTER TIME item in OPTION menu (📖43).
<b>LANGUAGE</b>	Using the ◀/▶ buttons changes the display language. See the LANGUAGE item in SCREEN menu (📖37).
<b>ADVANCED MENU</b>	Press the ▶ or <b>ENTER</b> button to use the menu of PICTURE, IMAGE, INPUT, SETUP, AUDIO, SCREEN, OPTION or SECURITY.
<b>EXIT</b>	Press the ◀ or <b>ENTER</b> button to finish the OSD menu.

## PICTURE menu

From the PICTURE menu, items shown in the table below can be performed.



Select an item using the ▲/▼ cursor buttons, and press the ► cursor button or **ENTER** button to execute the item. Then perform it according to the following table.

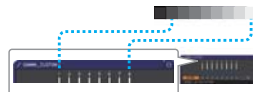

Item	Description
<b>BRIGHTNESS</b>	Using the ◀/▶ buttons adjusts the brightness. Dark ⇄ Light
<b>CONTRAST</b>	Using the ◀/▶ buttons adjusts the contrast. Weak ⇄ Strong
<b>GAMMA</b>	<p>Using the ▲/▼ buttons switches the gamma mode.</p> <p>1 DEFAULT ⇄ 1 CUSTOM ⇄ 2 DEFAULT ⇄ 2 CUSTOM ⇄ 3 DEFAULT                      ⇕                      6 CUSTOM <span style="float: right;">3 CUSTOM</span>                      ⇕                      6 DEFAULT ⇄ 5 CUSTOM ⇄ 5 DEFAULT ⇄ 4 CUSTOM ⇄ 4 DEFAULT</p> <p><b>To adjust CUSTOM</b></p> <p>Selecting a mode whose name includes CUSTOM and then pressing the ► button or the <b>ENTER</b> button displays a dialog to aid you in adjusting the mode.</p> <p>This function is useful when you want to change the brightness of particular tones.</p> <p>Choose an item using the ◀/▶ buttons, and adjust the level using the ▲/▼ buttons.</p> <p>You can display a test pattern for checking the effect of your adjustment by pressing the <b>ENTER</b> button. Each time you press the <b>ENTER</b> button, the pattern changes as below.</p> <p>No pattern ⇄ Gray scale of 9 steps ⇄                      ⇕ Ramp ⇄ Gray scale of 15 steps</p> <p>The eight equalizing bars correspond to eight tone levels of the test pattern (Gray scale of 9 steps) except the darkest in the left end. If you want to adjust the 2nd tone from left end on the test pattern, use the equalizing adjustment bar "1". The darkest tone at the left end of the test pattern cannot be controlled with any of equalizing adjustment bar.</p> <ul style="list-style-type: none"> <li>• Lines or other noise might appear on the screen when this function is operated, but it is not a malfunction.</li> </ul>

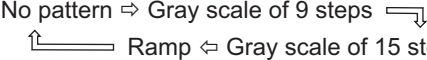

(continued on next page)

Item	Description
<p><b>COLOR TEMP</b></p>	<p>Using the ▲/▼ buttons switches the color temperature mode.</p> <p>1 HIGH ⇄ 1 CUSTOM ⇄ 2 MID ⇄ 2 CUSTOM            ⇕            6 CUSTOM ⇄ 3 LOW            ⇕            6 Hi-BRIGHT-3 ⇄ 3 CUSTOM            ⇕            5 CUSTOM ⇄ 5 Hi-BRIGHT-2 ⇄ 4 CUSTOM ⇄ 4 Hi-BRIGHT-1</p> <p><b>To adjust CUSTOM</b></p> <p>Selecting a mode whose name includes CUSTOM and then pressing the ► button or the <b>ENTER</b> button displays a dialog to aid you in adjusting the OFFSET and GAIN of the selected mode.</p>  <p>OFFSET adjustments change the color intensity on the whole tones of the test pattern.            GAIN adjustments mainly affect color intensity on the brighter tones of the test pattern.</p> <p>Choose an item using the ◀/▶ buttons, and adjust the level using the ▲/▼ buttons.</p> <p>You can display a test pattern for checking the effect of your adjustment by pressing the <b>ENTER</b> button.            Each time you press the <b>ENTER</b> button, the pattern changes as below.</p> <p>No pattern ⇄ Gray scale of 9 steps ⇄ Ramp ⇄ Gray scale of 15 steps</p>  <ul style="list-style-type: none"> <li>• Lines or other noise might appear on the screen when this function is operated, but it is not a malfunction.</li> </ul> 
<p><b>COLOR</b></p>	<p>Using the ◀/▶ buttons adjusts the strength of whole color.            Weak ⇄ Strong</p> <ul style="list-style-type: none"> <li>• This item can be selected only for a video, s-video and component video signal.</li> </ul>
<p><b>TINT</b></p>	<p>Using the ◀/▶ buttons adjusts the tint.            Reddish ⇄ Greenish</p> <ul style="list-style-type: none"> <li>• This item can be selected only for a video, s-video and component video signal.</li> </ul>
<p><b>SHARPNESS</b></p>	<p>Using the ◀/▶ buttons adjusts the sharpness.            Weak ⇄ Strong</p> <ul style="list-style-type: none"> <li>• There may be some noise and/or the screen may flicker for a moment when an adjustment is made. This is not a malfunction.</li> </ul>

(continued on next page)



Item	Description
<p><b>MY MEMORY</b></p>	<p>This projector has 4 memories for adjustment data (for all the items of the PICTURE menu).                      Selecting a function using the ▲/▼ buttons and pressing the ► or <b>ENTER</b> button performs each function.</p> <p style="text-align: center;">  </p> <p><u>SAVE-1, SAVE-2, SAVE-3, SAVE-4</u>                      Performing a SAVE function saves the current adjustment data into the memory linked in the number included in the function's name.</p> <ul style="list-style-type: none"> <li>• Remember that the current data being stored of a memory will be lost by saving new data into the memory.</li> </ul> <p><u>LOAD-1, LOAD-2, LOAD-3, LOAD-4</u>                      Performing a LOAD function loads the data from the memory linked in the number included in the function's name, and adjusts the picture automatically depending on the data.</p> <ul style="list-style-type: none"> <li>• The LOAD functions whose linked memory has no data are skipped.</li> <li>• Remember that the current adjusted condition will be lost by loading data. If you want to keep the current adjustment, please save it before performing a LOAD function.</li> <li>• There may be some noise and the screen may flicker for a moment when loading data. This is not malfunction.</li> <li>• You can perform the LOAD function using <b>MY BUTTONs</b>. Please see MY BUTTON item in OPTION menu (44).</li> </ul>

IMAGE menu

From the IMAGE menu, items shown in the table below can be performed.

Select an item using the ▲/▼ cursor buttons, and press the ► cursor button or **ENTER** button to execute the item. Then perform it according to the following table.

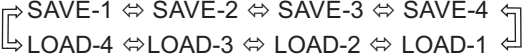

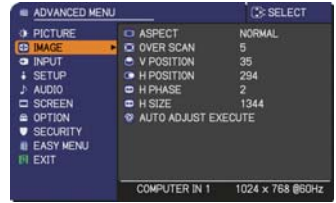
Item	Description
<b>ASPECT</b>	<p>Using the ▲/▼ buttons switches the mode for aspect ratio.</p> <p><b>For a computer signal</b>                      NORMAL ⇔ 4:3 ⇔ 16:9 ⇔ 16:10</p> <p><b>For a video signal, s-video signal or component video signal</b>                      4:3 ⇔ 16:9 ⇔ 14:9</p> <p><b>For no signal</b>                      4:3 (fixed)</p> <ul style="list-style-type: none"> <li>• The NORMAL mode keeps the original aspect ratio of the signal.</li> </ul>
<b>OVER SCAN</b>	<p>Using the ◀/▶ buttons adjusts the over-scan ratio.                      Small (It magnifies picture) ⇔ Large (It reduces picture)</p> <ul style="list-style-type: none"> <li>• This item can be selected only for a video, s-video and component video signal.</li> <li>• When this adjustment is too large, certain degradation may appear at the frame area of the picture. In such a case, please adjust small.</li> </ul>
<b>V POSITION</b>	<p>Using the ◀/▶ buttons adjusts the vertical position.                      Down ⇔ Up</p> <ul style="list-style-type: none"> <li>• Over-adjusting the vertical position may cause noise to appear on the screen. If this occurs, please reset the vertical position to the default setting. Pressing the <b>RESET</b> button when the V POSITION is selected will reset the V POSITION to the default setting.</li> <li>• When this function is performed on a video signal, s-video signal, or component video signal, the range of this adjustment depends on OVER SCAN (<b>above</b>) setting. It is not possible to adjust when OVER SCAN is set to 10.</li> </ul>
<b>H POSITION</b>	<p>Using the ◀/▶ buttons adjusts the horizontal position.                      Left ⇔ Right</p> <ul style="list-style-type: none"> <li>• Over-adjusting the horizontal position may cause noise to appear on the screen. If this occurs, please reset the horizontal position to the default setting. Pressing the <b>RESET</b> button when the H POSITION is selected will reset the H POSITION to the default setting.</li> <li>• When this function is performed on a video signal, s-video signal, or component video signal, the range of this adjustment depends on OVER SCAN (<b>above</b>) setting. It is not possible to adjust when OVER SCAN is set to 10.</li> </ul>

(continued on next page)

Item	Description
<b>H PHASE</b>	<p>Using the ◀/▶ buttons adjusts the horizontal phase to eliminate flicker. Right ⇔ Left</p> <ul style="list-style-type: none"> <li>• This item can be selected only for a computer signal or a component video signal.</li> </ul>
<b>H SIZE</b>	<p>Using the ◀/▶ buttons adjusts the horizontal size. Small ⇔ Large</p> <ul style="list-style-type: none"> <li>• This item can be selected only for a computer signal.</li> <li>• When this adjustment is excessive, the picture may not be displayed correctly. In such a case, please reset the adjustment by pressing the <b>RESET</b> button on the remote control during this operation.</li> <li>• Images might appear degraded when this function is operated, but it is not a malfunction.</li> </ul>
<b>AUTO ADJUST EXECUTE</b>	<p>Selecting this item performs the automatic adjustment feature.</p> <p><b>For a computer signal</b> The vertical position, the horizontal position and the horizontal phase will be automatically adjusted. Make sure that the application window is set to its maximum size prior to attempting to use this feature. A dark picture may still be incorrectly adjusted. Use a bright picture when adjusting.</p> <p><b>For a video signal and s-video signal</b> The video format best suited for the respective input signal will be selected automatically. This function is available only when the AUTO is selected for the VIDEO FORMAT item in the INPUT menu (📖32). The vertical position and horizontal position will be automatically set to the default.</p> <p><b>For a component video signal</b> The vertical position, horizontal position and horizontal phase will be automatically set to the default.</p> <ul style="list-style-type: none"> <li>• The automatic adjustment operation requires approx. 10 seconds. Also please note that it may not function correctly with some input.</li> <li>• When this function is performed for a video signal, a certain extra such as a line may appear outside a picture.</li> <li>• When this function is performed for a computer signal, a black frame may be displayed on the edge of the screen, depending on the PC model.</li> <li>• The items adjusted by this function may vary when the FINE or DISABLE is selected for the AUTO ADJUST item of the SERVICE item in the OPTION menu (📖45).</li> </ul>

## INPUT menu

From the INPUT menu, items shown in the table below can be performed.

Select an item using the ▲/▼ cursor buttons, and press the ► cursor button or **ENTER** button to execute the item. Then perform it according to the following table.





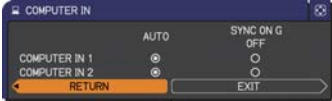
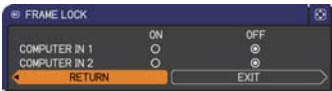

Item	Description
<b>PROGRESSIVE</b>	<p>Using the ▲/▼ buttons switches the progress mode.</p> <p>TV ⇔ FILM ⇔ OFF</p> <p>↑</p> <ul style="list-style-type: none"> <li>• This function is performed only for an interlaced signal at the <b>VIDEO</b> or <b>S-VIDEO</b> input, and for 480i@60 or 576i@50 signal at the <b>COMPONENT</b> input.</li> <li>• When TV or FILM is selected, the screen image will be sharp. FILM adapts to the 2-3 Pull-Down conversion system. But these may cause a certain defect (for example, jagged line) of the picture for a quick moving object. In such a case, please select OFF, even though the screen image may lose sharpness.</li> </ul>
<b>VIDEO NR</b>	<p>Using the ▲/▼ buttons switches the noise reduction mode.</p> <p>HIGH ⇔ MID ⇔ LOW</p> <p>↑</p> <ul style="list-style-type: none"> <li>• This function is performed only for the <b>VIDEO</b> or <b>S-VIDEO</b> input, and for 480i@60 or 576i@50 signal at the <b>COMPONENT</b> input.</li> <li>• When this function is excessive, it may cause a certain degradation of the picture.</li> </ul>
<b>COLOR SPACE</b>	<p>Using the ▲/▼ buttons switches the mode for color space.</p> <p>AUTO ⇔ RGB ⇔ SMPTE240 ⇔ REC709 ⇔ REC601</p> <p>↑</p> <ul style="list-style-type: none"> <li>• This item can be selected only for an RGB signal or a component video signal (except SCART RGB).</li> <li>• The AUTO mode automatically selects the optimum mode.</li> <li>• The AUTO operation may not work well at some signals. In such a case, it might be good to select a suitable mode except AUTO.</li> </ul>
<b>COMPONENT</b>	<p>Using the ▲/▼ buttons switches the function of the <b>COMPONENT (Y, Cb/Pb, Cr/Pr)</b> port.</p> <p>COMPONENT ⇔ SCART RGB</p> <p>When the SCART RGB is selected, the <b>COMPONENT (Y, Cb/Pb, Cr/Pr)</b> and <b>VIDEO</b> ports will function as a SCART RGB port. A SCART adapter or SCART cable is required for a SCART RGB input to the projector. For details, contact your dealer.</p>

(continued on next page)



Item	Description
<p><b>VIDEO FORMAT</b></p>	<p>The video format for <b>S-VIDEO</b> port and <b>VIDEO</b> port can be set.</p> <p>(1) Use the ▲/▼ buttons to select the input port. S-VIDEO ⇄ VIDEO</p> <p>(2) Using the ◀/▶ buttons switches the mode for video format. AUTO ⇄ NTSC ⇄ PAL ⇄ SECAM ⇄ N-PAL ⇄ M-PAL ⇄ NTSC4.43 ⇄</p>  <ul style="list-style-type: none"> <li>• This item is performed only for a video signal from the <b>VIDEO</b> port or the <b>S-VIDEO</b> port.</li> <li>• The AUTO mode automatically selects the optimum mode.</li> <li>• The AUTO operation may not work well for some signals. If the picture becomes unstable (e.g. an irregular picture, lack of color), please select the mode according to the input signal.</li> </ul>
<p><b>COMPUTER IN</b></p>	<p>The computer input signal type for <b>COMPUTER IN1</b> and <b>IN2</b> ports can be set.</p> <p>(1) Use the ▲/▼ buttons to select the <b>COMPUTER IN</b> port to be set. COMPUTER IN1 ⇄ COMPUTER IN2</p> <p>(2) Use the ◀/▶ buttons to select the computer input signal type. AUTO ⇄ SYNC ON G OFF</p>  <ul style="list-style-type: none"> <li>• Selecting the AUTO mode allows you to input a sync on G signal or component signal from the port.</li> <li>• In the AUTO mode, the picture may be distorted with certain input signals. In such a case, remove the signal connector so that no signal is received and select the SYNC ON G OFF, and then reconnect the signal.</li> </ul>
<p><b>FRAME LOCK</b></p>	<p>Set the frame lock function on/off for each port.</p> <p>(1) Use the ▲/▼ buttons to select the input ports. COMPUTER IN1 ⇄ COMPUTER IN2</p> <p>(2) Use the ◀/▶ buttons to turn the frame lock function on/off . ON ⇄ OFF</p>  <ul style="list-style-type: none"> <li>• This item can be performed only on a signal with a vertical frequency of 49Hz to 51Hz, 59 to 61 Hz.</li> <li>• When ON is selected, moving pictures are displayed more smoothly.</li> <li>• This function may cause a certain degradation of the picture. In such a case, please select OFF.</li> </ul>

(continued on next page)

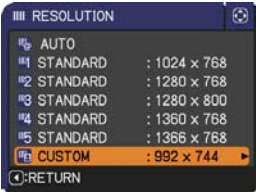
Item	Description
<p><b>RESOLUTION</b></p>	<p>The resolution for the <b>COMPUTER IN1</b> and <b>COMPUTER IN2</b> input signals can be set on this projector.</p> <p>(1) In the INPUT menu select the RESOLUTION using the ▲/▼ buttons and press the ► button. The RESOLUTION menu will be displayed.</p>  <p>(2) In the RESOLUTION menu select the resolution you wish to display using the ▲/▼ buttons. Selecting AUTO will set a resolution appropriate to the input signal.</p> <p>(3) Pressing the ► or ENTER button when selecting a STANDARD resolution will automatically adjust the horizontal and vertical positions, clock phase and horizontal size. The INPUT_INFORMATION dialog (46) will be displayed.</p>  <p>(4) To set a custom resolution use the ▲/▼ buttons to select the CUSTOM and the RESOLUTION_CUSTOM box will be displayed. Set the horizontal (HORZ) and vertical (VERT) resolutions using the ▲/▼/◀/▶ buttons. This function is may not support all resolutions.</p>  <p>(5) Move the cursor to OK on screen and press the ► or ENTER button. The message "ARE YOU SURE YOU WISH TO CHANGE RESOLUTION?" appears. To save the setting, press the ► button. The horizontal and vertical positions, clock phase and horizontal size will be automatically adjusted. After the INPUT_INFORMATION dialog has displayed for about 10 seconds the screen will return to the RESOLUTION menu displaying the changed resolution.</p>   <p>(6) To revert back to the previous resolution without saving changes place the cursor on the left-most digit and press the ◀ button. The screen will then return to the RESOLUTION menu displaying the previous resolution.</p> <ul style="list-style-type: none"> <li>• For some pictures, this function may not work well.</li> </ul>

SETUP menu



From the SETUP menu, items shown in the table below can be performed.

Select an item using the ▲/▼ cursor buttons, and press the ► cursor button or **ENTER** button to execute the item. Then perform it according to the following table.



Item	Description
<p><b>AUTO KEYSTONE EXECUTE</b></p>	<p>Selecting this item performs the Automatic keystone distortion correction. Projector automatically corrects vertical keystone distortion due to the (forward/backward) setup angle by itself. This function will be executed only once when selected in the menu. When the slant of the projector is changed, execute this function again.</p> <ul style="list-style-type: none"> <li>• The adjustable range of this function will vary among inputs. For some input, this function may not work well.</li> <li>• When V:INVERT or H&amp;V:INVERT is selected to the MIRROR item in the SETUP menu, if the projector screen is inclined or angled downward, this function may not work correctly.</li> <li>• When the zoom adjustment is set to the TELE (telephoto focus), this function may be excessive. This function should be used when the zoom adjustment is set to the full WIDE (wide-angle focus) whenever possible.</li> <li>• When the projector is placed on the level (about <math>\pm 3^\circ</math>), this function may not work.</li> <li>• When the projector is inclined to near <math>\pm 30</math> degree or over, this function may not work well.</li> <li>• This function will be unavailable when the Transition Detector is on (50).</li> </ul>
<p><b>KEYSTONE</b></p>	<p>Using the ◀/▶ buttons corrects the vertical keystone distortion.</p> <p>Shrink the bottom of the image ⇔ Shrink the top of the image</p> <ul style="list-style-type: none"> <li>• The adjustable range of this function will vary among inputs. For some input, this function may not work well.</li> <li>• When the zoom adjustment is set to the TELE (telephoto focus), this function may be excessive. This function should be used when the zoom adjustment is set to the full WIDE (wide-angle focus) whenever possible.</li> <li>• This function will be unavailable when the Transition Detector is on (50).</li> </ul>
<p><b>ECO MODE</b></p>	<p>Using the ▲/▼ buttons turns off/on the eco mode.</p> <p>BRIGHT ⇔ NORMAL</p> <ul style="list-style-type: none"> <li>• When the NORMAL is selected, acoustic noise and screen brightness are reduced.</li> </ul>

(continued on next page)

Item	Description
<p><b>MIRROR</b></p>	<p>Using the ▲/▼ buttons switches the mode for mirror status.</p> <div style="text-align: center;">  <p>NORMAL ⇔ H:INVERT ⇔ V:INVERT ⇔ H&amp;V:INVERT</p> </div> <p>If the Transition Detector is on and MIRROR status is changed, TRANSITION DETECTOR ON alarm (🔊50) will be displayed when projector is restarted after the AC power is turned off.</p>
<p><b>STANDBY MODE</b></p>	<p>Using ▲/▼ buttons switches the standby mode setting between NORMAL and SAVING. SAVING ⇔ NORMAL</p> <p>When SAVING is selected, the power consumption in the standby mode is lowered with some functional restriction as below:</p> <ul style="list-style-type: none"> <li>• When SAVING is selected, the RS-232C communication control is disabled except to turn the projector on while the projector is in the standby mode.</li> <li>• When SAVING is selected, AUDIO OUT STANDBY setting of AUDIO SOURCE (🔊36) is invalid, and no signal is output from <b>AUDIO OUT</b> ports in the standby mode.</li> </ul>
<p><b>MONITOR OUT</b></p>	<p>The combination of a picture shown on screen and output from the <b>MONITOR OUT</b> port can be arranged in the menu.</p> <p>The picture coming into the port selected in the (2) is output to the <b>MONITOR OUT</b> port while an image from the port chosen in the (1) is on screen.</p> <p>(1) Choose a picture input port using ▲/▼ buttons.</p> <div style="text-align: center;"> <p>COMPUTER IN1 ⇔ COMPUTER IN2</p> <p>⇕</p> <p>STANDBY</p> <p>⇕</p> <p>VIDEO ⇔ S-VIDEO ⇔ (Y, Cb/Pb, Cr/Pr)</p> <p>⇕</p> <p>COMPONENT</p> </div> <p>(2) Select one of the <b>COMPUTER IN</b> ports using ◀/▶ buttons.</p> <p>Choosing the COMPUTER IN1 allows the following choice. COMPUTER IN1 ⇔ OFF</p> <p>Choosing the COMPUTER IN2 allows the following choice. COMPUTER IN2 ⇔ OFF</p> <p>Choosing other input or STANDBY allows the following choice. COMPUTER IN1 ⇔ COMPUTER IN2 ⇔ OFF</p> <p>• OFF disables the <b>MONITOR OUT</b> port.</p> 

# AUDIO menu

From the AUDIO menu, items shown in the table below can be performed. Select an item using the ▲/▼ cursor buttons, and press the ► cursor button or the **ENTER** button to execute the item. Then perform it according to the following table.



Item	Description
<b>VOLUME</b>	Using the ▲/▼ buttons adjusts the volume. High ⇔ Low
<b>SPEAKER</b>	Using the ▲/▼ buttons turns on/off the built-in speaker. ON ⇔ OFF When OFF is selected, the built-in speaker does not work.
<b>AUDIO SOURCE</b>	<p>The combination of a picture and audio input port can be arranged in the menu. The audio coming into the port selected in the (2) is output while an image from the port chosen in the (1) is on screen.</p> <p>(1) Choose a picture input port using the ▲/▼ buttons.</p> <div style="display: flex; justify-content: space-around; align-items: center;"> <div style="text-align: center;">             COMPUTER IN1 ⇔ COMPUTER IN2              ⇕              AUDIO OUT STANDBY              ⇕              VIDEO ⇔ S-VIDEO ⇔ (Y, Cb/Pb, Cr/Pr)         </div> <div style="text-align: center;">             ⇕              COMPONENT              ⇕         </div> </div> <p>• Choose AUDIO OUT STANDBY, to select the audio output to the <b>AUDIO OUT</b> ports in the standby mode. The built-in speaker does not work in the standby mode.</p> <p>• While QUIT is selected, pressing the ◀ button returns to the previous menu.</p> <p>(2) Select one of the <b>AUDIO IN</b> ports using ◀/▶ buttons.</p> <div style="display: flex; justify-content: center; align-items: center; margin: 10px 0;"> <span>AUDIO IN1 ⇔ AUDIO IN2 ⇔ AUDIO IN3 ⇔</span> <span style="font-size: 2em;">✕</span> </div> <p style="text-align: center; margin: 0 100px;">↑ _____ ↓</p> <p>• ✕ disables the audio output.</p> <p>• C.C. (Closed Caption) is automatically activated when ✕ is selected and an input signal containing C.C. is received. This function is available only when the signal is NTSC for <b>VIDEO</b> or <b>S-VIDEO</b>, or 480i@60 for <b>COMPONENT</b>, <b>COMPUTER IN1</b> or <b>COMPUTER IN2</b>, and when AUTO is selected for DISPLAY in the C.C. menu under the SCREEN menu (41).</p>



## SCREEN menu



From the SCREEN menu, items shown in the table below can be performed.

Select an item using the ▲/▼ cursor buttons, and press the ► cursor button or **ENTER** button to execute the item. Then perform it according to the following table.

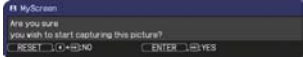

Item	Description
<p><b>LANGUAGE</b></p>	<p>Using the ▲/▼/◀/▶ buttons switches the OSD (On Screen Display) language.</p> <p>ENGLISH ⇄ FRANÇAIS ⇄ DEUTSCH ⇄ ESPAÑOL</p> <p>⤴ ..... (shown in the LANGUAGE dialog) ..... ⤵</p> <p>Press the <b>ENTER</b> or <b>INPUT</b> button to save the language setting.</p>
<p><b>MENU POSITION</b></p>	<p>Using the ▲/▼/◀/▶ buttons adjusts the menu position. To quit the operation, press the <b>MENU</b> button on the remote control or keep no operation for about 10 seconds.</p>
<p><b>BLANK</b></p>	<p>Using the ▲/▼ buttons switches the mode for the blank screen. The blank screen is a screen for the temporarily blanking feature (Ⓛ21). It is displayed by pressing the <b>BLANK</b> button on the remote control.</p> <p>MyScreen ⇄ ORIGINAL ⇄ BLUE ⇄ WHITE ⇄ BLACK</p> <p>⤴—————⤵</p> <p><u>MyScreen</u> : Screen can be registered by the MyScreen item (Ⓛ38).  <u>ORIGINAL</u> : Screen preset as the standard screen.  <u>BLUE, WHITE, BLACK</u> : Plain screens in each color.</p> <ul style="list-style-type: none"> <li>• To avoid remaining as an afterimage, the MyScreen or ORIGINAL screen will change to the plain black screen after several minutes.</li> </ul>
<p><b>START UP</b></p>	<p>Using the ▲/▼ buttons switches the mode for the start-up screen. The start-up screen is a screen displayed when no signal or an unsuitable signal is detected.</p> <p>MyScreen ⇄ ORIGINAL ⇄ OFF</p> <p>⤴—————⤵</p> <p><u>MyScreen</u> : Screen can be registered by the MyScreen item (Ⓛ38).  <u>ORIGINAL</u> : Screen preset as the standard screen.  <u>OFF</u> : Plain black screen.</p> <ul style="list-style-type: none"> <li>• To avoid remaining as an afterimage, the MyScreen or ORIGINAL screen will change to the BLANK screen (Ⓛ21) after several minutes. If also the BLANK screen is the MyScreen or ORIGINAL, the plain black screen is instead used.</li> <li>• When the ON is selected to the MyScreen PASSWORD item in the SECURITY menu (Ⓛ48), the START UP is fixed to MyScreen.</li> </ul>

(continued on next page)

Item	Description
<p><b>MyScreen</b></p>	<p>This item allows you to capture an image for use as a MyScreen image which can be used as the BLANK screen and START UP screen. Display the image you want to capture before executing the following procedure.</p> <ol style="list-style-type: none"> <li> <p>1. Selecting this item displays a dialog titled "MyScreen". It will ask you if you start capturing an image from the current screen.</p>  <p>Please wait for the target image to be displayed, and press the <b>ENTER</b> or <b>INPUT</b> button when the image is displayed. The image will freeze and the frame for capturing will appear.</p> <p>To stop performing, press the <b>RESET</b> button on the remote control.</p> </li> <li> <p>2. Using the ▲/▼/◀/▶ buttons adjusts the frame position.</p>  <p>Please move the frame to the position of the image which you want to use. The frame may not be able to be moved for some input signals.</p>  <p>To start registration, press the <b>ENTER</b> or <b>INPUT</b> button on the remote control.</p> <p>To restore the screen and return to the previous dialog, press the <b>RESET</b> button on the remote control.</p> <p>Registration takes several minutes.</p> <p>When the registration is completed, the registered screen and the following message is displayed for several seconds:</p> <p><b>"MyScreen registration is finished."</b></p> <p>If the registration failed, the following message is displayed:</p> <p><b>"A capturing error has occurred. Please try again."</b></p> <ul style="list-style-type: none"> <li>• This function cannot be selected when the ON is selected to the MyScreen Lock item (🔒39).</li> <li>• This function cannot be selected when the ON is selected to the MyScreen PASSWORD item in SECURITY menu (🔒48).</li> </ul> </li> </ol>

Item	Description
<b>MyScreen Lock</b>	<p>Using the ▲/▼ buttons turns on/off the MyScreen lock function. ON ⇔ OFF</p> <p>When the ON is selected, the item MyScreen is locked. Use this function for protecting the current MyScreen.</p> <ul style="list-style-type: none"> <li>• This function cannot be selected when the ON is selected to the MyScreen PASSWORD item in SECURITY menu (📖48).</li> </ul>
<b>MESSAGE</b>	<p>Using the ▲/▼ buttons turns on/off the message function. ON ⇔ OFF</p> <p>When the ON is selected, the following message function works.</p> <p>“AUTO IN PROGRESS” while automatically adjusting  “NO INPUT IS DETECTED”  “SYNC IS OUT OF RANGE”  “INVALID SCAN FREQ”  “Searching...” while searching for the input  “Detecting...” while an input signal is detected  The indication of the input signal displayed by changing  The indication of the aspect ratio displayed by changing  The indication of the PICTURE MODE displayed by changing  The indication of the MY MEMORY displayed by changing  The indication of “FREEZE” and “II” while freezing the screen by pressing the <b>FREEZE</b> button.  The indication of the TEMPLATE displayed by changing.</p> <ul style="list-style-type: none"> <li>• When the OFF is selected, please remember if the picture is frozen. Do not mistake freezing for a malfunction (📖21).</li> </ul>

(continued on next page)



Item	Description
<p><b>SOURCE NAME</b></p>	<p>Each input port for this projector can have a name applied to it.</p> <p>(1) Use the ▲/▼ buttons on the SCREEN menu to select SOURCE NAME and press the ► or ENTER button. The SOURCE NAME menu will be displayed.</p> <p>(2) Use the ▲/▼ buttons on the SOURCE NAME menu to select the port to be named and press the ► button. Right side of the menu is blank until a name is specified. The SOURCE NAME dialog will be displayed.</p> <p>(3) The current name will be displayed on the first line. Use the ▲/▼/◀/▶ buttons and the ENTER or INPUT button to select and enter characters. The RESET button can be used to erase 1 character at a time. Also if you move the cursor to DELETE or ALL CLEAR on screen and press the ENTER or INPUT button, 1 character or all characters will be erased. The name can be a maximum of 16 characters.</p> <p>(4) To change an already inserted character, press the ▲ button to move the cursor to the first line, and use the ◀/▶ buttons to move the cursor on the character to be changed. After pressing the ENTER or INPUT button, the character is selected. Then, follow the same procedure as described at the item (3) above.</p> <p>(5) To finish entering text, move the cursor to the OK on screen and press the ENTER or INPUT button. To revert to the previous name without saving changes, move the cursor to the CANCEL on screen and press the ENTER or INPUT button.</p>
<p><b>TEMPLATE</b></p>	<p>Using the ▲/▼ buttons switches the mode for the template screen. Press the ► button to display the selected template, and press the ◀ button to close the displayed screen. The last selected template is displayed when the MY BUTTON allocated to the TEMPLATE function is pressed (44).</p> <p> </p>



Item	Description
<b>C.C.</b> <b>(Closed Caption)</b>	<p>The C.C. is the function that displays a transcript or dialog of the audio portion of a video, files or other presentation or other relevant sounds. It is required to have NTSC format video or 480i@60 format component video source supporting C.C. feature to utilize this function.</p> <p>It may not work properly, depending on equipment or signal source. In this case, please turn off the Closed Caption.</p>
	<p><b>DISPLAY</b></p> <p>Select Closed Caption DISPLAY setting from following options using ▲/▼ buttons.</p> <p style="text-align: center;">       AUTO ⇔ ON ⇔ OFF        ↑—————↑     </p> <p><u>AUTO</u> : Closed Caption automatically displays when the volume is muted.</p> <p><u>ON</u> : Closed Caption is on</p> <p><u>OFF</u> : Closed Caption is off</p> <ul style="list-style-type: none"> <li>• The caption is not displayed when the OSD menu is active.</li> <li>• The Closed Caption is the function to display the dialogue, narration, and / or sound effects of a television program or other video sources. The Closed Caption availability is depending upon broadcaster and/or content.</li> </ul>
	<p><b>MODE</b></p> <p>Select Closed Caption MODE setting from following options using ▲/▼ buttons.</p> <p style="text-align: center;">CAPTIONS ⇔ TEXT</p> <p><u>CAPTIONS</u> : Display Closed Caption</p> <p><u>TEXT</u> : Display Text data, which is for additional information such as news reports or a TV program guide. The information covers the entire screen. Not all of the C.C. program has Text information.</p>
	<p><b>CHANNEL</b></p> <p>Select Closed Caption CHANNEL from following options using ▲/▼ buttons.</p> <p style="text-align: center;">       1 ⇔ 2 ⇔ 3 ⇔ 4        ↑—————↑     </p> <p><u>1</u>: Channel 1, primary channel / language</p> <p><u>2</u>: Channel 2</p> <p><u>3</u>: Channel 3</p> <p><u>4</u>: Channel 4</p> <p>The channel data may vary, depending on the content. Some channel might be used for secondary language or empty.</p>



## OPTION menu



From the OPTION menu, items shown in the table below can be performed.

Select an item using the ▲/▼ cursor buttons, and press the ► cursor button or **ENTER** button to execute the item, except for the items LAMP TIME and FILTER TIME. Then perform it according to the following table



Item	Description
<p><b>AUTO SEARCH</b></p>	<p>Using the ▲/▼ buttons turns on/off the automatic signal search function.                      ON ⇔ OFF</p> <p>When the ON is selected, detecting no signal automatically cycles through input ports in the following order. The search is started from the current port. Then when an input is found, the projector will stop searching and display the image.</p> <p> </p>
<p><b>AUTO KEYSTONE</b></p>	<p>Using the ▲/▼ buttons turns on/off the automatic keystone function.                      ON ⇔ OFF</p> <p><u>ON</u> : Automatic keystone distortion correction will be executed whenever changing the slant of the projector.</p> <p><u>OFF</u> : This function is disabled. Please execute the <b>AUTO KEYSTONE EXECUTE</b> in the <b>SETUP</b> menu for automatic keystone distortion correction.</p> <ul style="list-style-type: none"> <li>• When the projector is suspended from the ceiling this feature will not function properly so select the OFF.</li> <li>• This function will be unavailable when the Transition Detector is on (📖50).</li> </ul>
<p><b>DIRECT ON</b></p>	<p>Using the ▲/▼ buttons turns on/off the DIRECT ON function.                      ON ⇔ OFF</p> <p>When set to the ON, the lamp in projector will be automatically turned on without the usual procedure (📖14), only when the projector is supplied with the power after the power was cut while the lamp was on.</p> <ul style="list-style-type: none"> <li>• This function does not work as long as the power has been supplied to the projector while the lamp is off.</li> <li>• After turning the lamp on by the DIRECT ON function, if neither input nor operation is detected for about 30 minutes, the projector is turned off, even though the AUTO OFF function (📖43) is disabled.</li> </ul>

(continued on next page)



Item	Description
<p><b>AUTO OFF</b></p>	<p>Using the ▲/▼ buttons adjusts the time to count down to automatically turn the projector off.            Long (max. 99 minutes) ⇔ Short (min. 0 minute = DISABLE)</p> <div style="display: flex; justify-content: space-around; align-items: center;">   </div> <p>When the time is set to 0, the projector is not turned off automatically. When the time is set to 1 to 99, and when the passed time with no-signal or an unsuitable signal reaches at the set time, the projector lamp will be turned off.</p> <p>If one of the projector's buttons or the remote control buttons is pressed or one of the commands (except get commands) is transmitted to the <b>CONTROL</b> port during the corresponding time, projector will not be turned off.</p> <p>Please refer to the section "Turning off the power" (14).</p>
<p><b>LAMP TIME</b></p>	<p>The lamp time is the usage time of the lamp, counted after the last resetting. It is shown in the OPTION menu.</p> <p>Pressing the <b>RESET</b> button on the remote control or the ► button of the projector displays a dialog.</p> <p>To reset the lamp time, select the OK using the ► button.            CANCEL ⇔ OK</p> <ul style="list-style-type: none"> <li>• Please reset the lamp time only when you have replaced the lamp, for a suitable indication about the lamp.</li> <li>• For the lamp replacement, see the section "Replacing the lamp" (53, 54).</li> </ul>
<p><b>FILTER TIME</b></p>	<p>The filter time is the usage time of the air filter, counted after the last resetting. It is shown in the OPTION menu.</p> <p>Pressing the <b>RESET</b> button on the remote control or the ► button of the projector displays a dialog.</p> <p>To reset the filter time, select the OK using the ► button.            CANCEL ⇔ OK</p> <ul style="list-style-type: none"> <li>• Please reset the filter time only when you have cleaned or replaced the air filter, for a suitable indication about the air filter.</li> <li>• For the air filter cleaning, see the section "Cleaning and replacing the air filter" (55, 56).</li> </ul>



(continued on next page)

Item	Description
<p><b>MY BUTTON</b></p>	<p>This item is to assign one of the following functions to <b>MY BUTTON 1/2</b> on the remote control ( <a href="#">46</a>).</p> <p>(1) Use the ▲/▼ buttons on the MY BUTTON menu to select a MY BUTTON - (1/2) and press the ► button to display the MY BUTTON setup dialog.</p> <p>(2) Then using the ▲/▼/◀/▶ buttons sets one of the following functions to the chosen button. Press the <b>ENTER</b> or <b>INPUT</b> button to save the setting.</p> <ul style="list-style-type: none"> <li>• COMPUTER IN1: Sets port to <b>COMPUTER IN1</b>.</li> <li>• COMPUTER IN2: Sets port to <b>COMPUTER IN2</b>.</li> <li>• COMPONENT: Sets port to <b>COMPONENT (Y, Cb/Pb, Cr/Pr)</b>.</li> <li>• S-VIDEO: Sets port to <b>S-VIDEO</b>.</li> <li>• VIDEO: Sets port to <b>VIDEO</b>.</li> <li>• INFORMATION: Displays the INPUT_INFORMATION ( <a href="#">46</a>) or the SYSTEM_INFORMATION or nothing.</li> <li>• AUTO KEYSTONE : Performs automatic keystone distortion correction ( <a href="#">34</a>).</li> <li>• MY MEMORY: Loads one of adjustment data stored ( <a href="#">28</a>). When more than one data are saved, the adjustment changes every time the <b>MY BUTTON</b> is pressed. When no data is saved in memory, the dialog "No saved data" appears. When the current adjustment is not saved to memory, the dialog as shown in the right appears.</li> </ul> <p>If you want to keep the current adjustment, please press the ► button to exit. Otherwise loading a data will overwrite the current adjusted condition.</p> <ul style="list-style-type: none"> <li>• PICTURE MODE: Changes the PICTURE MODE ( <a href="#">24</a>).</li> <li>• FILTER RESET: Displays the filter time reset confirmation dialogue ( <a href="#">43</a>).</li> <li>• TEMPLATE: Makes the template pattern selected to the TEMPLATE item ( <a href="#">40</a>) appear or disappear.</li> <li>• AV MUTE: Turns the picture and audio on/off.</li> </ul>
<p><b>MY SOURCE</b></p>	<p>Using ▲/▼ buttons selects the picture input port to be selected with pressing the <b>MY SOURCE/DOC.CAMERA</b> button on the remote control.</p> <p>Select the picture input that is connected with a document camera.</p> <p>  </p>

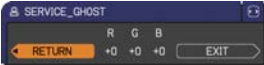

(continued on next page)

Item	Description
<b>SERVICE</b>	<p>Selecting this item displays the SERVICE menu. Select an item using the ▲/▼ buttons, and press the ► button or the <b>ENTER</b> button on the remote control to execute the item.</p> 
	<p><b>FAN SPEED</b> Using the ▲/▼ buttons switches the rotation speed of the cooling fans. The HIGH is the mode for use at highlands etc. Note that the projector is noisier when the HIGH is selected. HIGH ⇔ NORMAL</p>
	<p><b>AUTO ADJUST</b> Using the ▲/▼ buttons to select one of the mode. When the DISABLE is selected, the automatic adjustment feature is disabled. FINE ⇔ FAST ⇔ DISABLE</p>  <p><u>FINE</u>: Finer tuning including H.SIZE adjustment. <u>FAST</u>: Faster tuning, setting H.SIZE to prearranged data for the input signal.</p> <ul style="list-style-type: none"> <li>Depending on conditions, such as input image, signal cable to the projector, environment around the projector, etc., the automatic adjustment may not work correctly. In such a case, please choose DISABLE to disable the automatic adjustment, and make adjustment manually.</li> </ul>
	<p><b>GHOST</b></p> <ol style="list-style-type: none"> <li>Select a color element of ghost using the ◀/▶ buttons.</li> <li>Adjust the selected element using the ▲/▼ buttons to disappear ghost.</li> </ol> 
	<p><b>FILTER MESSAGE</b> Use the ▲/▼ button to set the timer for notifying by the message when to replace the filter unit 100h ⇔ 200h ⇔ 500h ⇔ 1000h ⇔ 2000h ⇔ 5000h ⇔ OFF After choosing an item except OFF, the message “REMINDER *** HRS PASSED AFTER THE LAST FILTER CHANGE” will appear after the timer reaches the interval time set by this feature (58). When the OFF is chosen, the message will not appear. Utilize this feature to keep the air filter clean, setting the suitable time according to your environment of this projector. Refer to the following criterion.</p> <ul style="list-style-type: none"> <li>Please take care of the filter unit periodically, even if there is no message. If the air filter becomes to be blocked by dust or other matter, the internal temperature will rise, which could cause malfunction, or reduce the lifetime of the projector.</li> <li>Please be careful with the operating environment of the projector and the condition of the filter unit.</li> </ul>

Item	Description
<p><b>SERVICE (continued)</b></p>	<p><b>KEY LOCK</b></p> <p>Using the ▲/▼ buttons turns on/off the lens lock feature. When ON is selected, the buttons on the projector except the <b>STANDBY/ON</b> button are locked.</p> <p>ON ⇔ OFF</p> <ul style="list-style-type: none"> <li>• Please use this function to prevent tampering or accidental operation. This function does not have any effect on the remote control.</li> </ul>
	<p><b>REMOTE FREQ.</b></p> <p>(1) Use the ▲/▼ button to change the projector's remote sensor frequency setting (4).</p> <p>1:NORMAL ⇔ 2:HIGH</p> <p>(2) Use the ◀/▶ button to change the projector's remote sensor on or off.</p> <p>ON ⇔ OFF</p> <p>The factory default setting is for both 1:NORMAL and 2:HIGH to be on. If the remote control does not function correctly, set the this to either only 1 or only 2 as described in Remote Control Settings (13).</p> <p>Neither can be turned off at the same time.</p>
	<p><b>INFORMATION</b></p> <p>Selecting this item displays a dialog titled "INPUT_INFORMATION". It shows the information about the current input.</p> <div style="display: flex; justify-content: space-around;">    </div> <ul style="list-style-type: none"> <li>• The "FRAME LOCK" message on the dialog means the frame lock function is working.</li> <li>• The "SCART RGB" message means the <b>COMPONENT</b> port is working as a SCART RGB input port. Please refer to the COMPONENT item in INPUT menu (31).</li> <li>• This item can't be selected for no signal and sync out.</li> <li>• When the MY TEXT DISPLAY is set to ON, the MY TEXT is displayed together with the input information in the INPUT_INFORMATION box (52).</li> </ul>
	<p><b>FACTORY RESET</b></p> <p>Selecting OK using ► the button performs this function. By this function, all the items in all of menus will collectively return to the initial setting. Note that the items LAMP TIME, FILTER TIME, LANGUAGE, FILTER MESSAGE and SECURITY settings are not reset.</p> <p>CANCEL ⇔ OK</p>

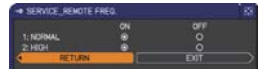

## SECURITY menu

This projector is equipped with security functions.

From the SECURITY menu, items shown in the table below can be performed.

To use SECURITY menu: User registration is required before using the security functions.



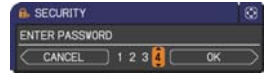

### Enter the SECURITY menu

1. Use the ▲/▼ buttons on the SECURITY menu to select ENTER PASSWORD and press the ► button. The ENTER PASSWORD box will be displayed.
2. Use the ▲/▼/◀/▶ buttons to enter the registered password. The factory default password is **9676**. This password can be changed (🔑 SECURITY PASSWORD CHANGE). Move the cursor to the right side of the ENTER PASSWORD box and press the ► button to display the SECURITY menu.
  - It is strongly recommended the factory default password to be changed as soon as possible.
  - If an incorrect password is input, the ENTER PASSWORD box will be displayed again. If incorrect password is input 3 times, the projector will turn off. Afterwards the projector will turn off every time an incorrect password is input.
3. Items shown in the table below can be performed.







### If you have forgotten your password

- (1). While the ENTER PASSWORD box is displayed, press and hold the **RESET** button on the remote control for about 3 seconds or press and hold the **INPUT** button for 3 seconds while pressing the ► button on the projector.
- (2). The 10 digit Inquiring Code will be displayed. Contact your dealer with the 10 digit Inquiring Code. Your password will be sent after your user registration information is confirmed.
  - If there is no key input for about 55 seconds while the Inquiring Code is displayed, the menu will close. If necessary, repeat the process from (1).



Item	Description
<p><b>SECURITY PASSWORD CHANGE</b></p>	<p>(1) Use the ▲/▼ buttons on the SECURITY menu to select SECURITY PASSWORD CHANGE and press the ► button to display the ENTER NEW PASSWORD box.</p> 
	<p>(2) Use the ▲/▼/◀/▶ buttons to enter the new password.</p>
	<p>(3) Move the cursor to the right side of the ENTER NEW PASSWORD box and press the ► button to display the NEW PASSWORD AGAIN box, enter the same password again.</p> 
	<p>(4) Move the cursor to the right side of the NEW PASSWORD AGAIN box and press the ► button and the NOTE NEW PASSWORD box will be displayed for about 20 seconds, please make note of the password during this time. Pressing the <b>ENTER</b> button on the remote control or ► button on the projector will close the NOTE NEW PASSWORD box.</p>  <p>• Please do not forget your password.</p>

(continued on next page)





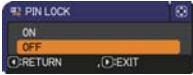

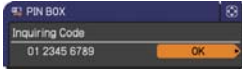



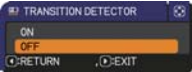

Item	Description
<p><b>MyScreen PASSWORD</b></p>	<p>The MyScreen PASSWORD function can be used to prohibit access to the MyScreen function and prevent the currently registered MyScreen image from being overwritten.</p> <p><b>1 Turning on the MyScreen PASSWORD</b></p> <p>1-1 Use the ▲/▼ buttons on the SECURITY menu to select MyScreen PASSWORD and press the ► button to display the MyScreen PASSWORD on/off menu.</p> <p>1-2 Use the ▲/▼ buttons on the MyScreen PASSWORD on/off menu to select ON. The ENTER NEW PASSWORD box (small) will be displayed.</p> <p>1-3 Use the ▲/▼/◀/▶ buttons to enter the password. Move the cursor to the right side of the ENTER NEW PASSWORD box (small) and press the ► button to display the NEW PASSWORD AGAIN box, enter the same PASSWORD again.</p> <p>1-4 Move the cursor to the right side of the NEW PASSWORD AGAIN box and press the ► button to display the NOTE NEW PASSWORD box for about 20 seconds, please make note of the password during this time.</p> <p>Pressing the <b>ENTER</b> button on the remote control or ► button on the projector will return to MyScreen PASSWORD on/off menu.</p> <p>When a password is set for MyScreen:</p> <ul style="list-style-type: none"> <li>• The MyScreen registration function (and menu) will be unavailable.</li> <li>• The MyScreen Lock menu will be unavailable.</li> <li>• The START UP setting will be locked on MyScreen (and the menu will be unavailable).</li> </ul> <p>Turning the MyScreen PASSWORD off will allow normal operation of these functions.</p> <ul style="list-style-type: none"> <li>• Please do not forget your MyScreen PASSWORD.</li> </ul> <p><b>2 Turning off the MyScreen PASSWORD</b></p> <p>2-1 Follow the procedure in 1-1 to display the MyScreen PASSWORD on/off menu.</p> <p>2-2 Select OFF to display the ENTER PASSWORD box (large). Enter the registered password and the screen will return to the MyScreen PASSWORD on/off menu.</p> <p>If an incorrect PASSWORD is input, the menu will close. If necessary, repeat the process from 2-1.</p> <p><b>3 If you have forgotten your password</b></p> <p>3-1 Follow the procedure in 1-1 to display the MyScreen PASSWORD on/off menu.</p> <p>3-2 Select OFF to display the ENTER PASSWORD box (large). The 10 digit Inquiring Code will be displayed inside the box.</p> <p>3-3 Contact your dealer with the 10 digit Inquiring Code. Your password will be sent after your user registration information is confirmed.</p>
	    

(continued on next page)





Item	Description
<b>PIN LOCK</b>	<p>PIN LOCK is a function which prevents the projector from being used unless a registered Code is input.</p> <p><b>1 Turning on the PIN LOCK</b></p> <p>1-1 Use the ▲/▼ buttons on the SECURITY menu to select PIN LOCK and press the ► button or the <b>ENTER</b> button to display the PIN LOCK on/off menu.</p>  <p>1-2 Use the ▲/▼ buttons on the PIN LOCK on/off menu to select ON and the Enter PIN Code box will be displayed.</p>  <p>1-3 Input a 4 part PIN code using the ▲/▼/◀/▶, <b>COMPUTER</b> or <b>INPUT</b> button. The PIN Code again box will appear. Reenter the same PIN code. This will complete the PIN code registration.</p>  <ul style="list-style-type: none"> <li>• If there is no key input for about 55 seconds while the Enter PIN Code box or the PIN Code again box is displayed, the menu will close. If necessary, repeat the process from 1-1.</li> </ul> <p>Afterwards, anytime the projector is restarted after AC power is turned off the Enter PIN Code box will be displayed. Enter the registered PIN code. The projector can be used after entering the registered PIN code. If an incorrect PIN code is input, the Enter PIN code box will be displayed again. If an incorrect PIN Code is input 3 times, the projector will turn off. Afterwards the projector will turn off every time an incorrect PIN code is input. The projector will also turn off if there is no key input for about 5 minutes while the Enter PIN code box is displayed. This function will activate only when the projector is started after AC power is turned off.</p> <ul style="list-style-type: none"> <li>• Please do not forget your PIN code.</li> </ul> <p><b>2 Turning off the PIN LOCK</b></p> <p>2-1 Follow the procedure in 1-1 to display the PIN LOCK on/off menu.</p> <p>2-2 Use the ▲/▼ buttons to select OFF and the Enter PIN Code box will be displayed. Enter the registered PIN code to turn the PIN LOCK function off. If an incorrect PIN Code is input 3 times, the menu will close.</p> <p><b>3 If you have forgotten your PIN Code</b></p> <p>3-1 While the Enter PIN Code box is displayed, press and hold the <b>RESET</b> button for three seconds or press and hold the <b>INPUT</b> button for 3 seconds while pressing the ► button on the projector. The 10 digit Inquiring Code will be displayed.</p>  <ul style="list-style-type: none"> <li>• If there is no key input for about 5 minutes while the Inquiring Code is displayed, the projector will turn off.</li> </ul> <p>3-2 Contact your dealer with the 10 digit Inquiring Code. Your PIN Code will be sent after your user registration information is confirmed.</p>

(continued on next page)

Item	Description
<p><b>TRANSITION DETECTOR</b></p>	<p>If this function is set to ON when the vertical angle of the projector or MIRROR setting at which the projector is turned on is different than the previously recorded, the TRANSITION DETECTOR ON alarm will be displayed and the projector will not display the input signal.</p> <ul style="list-style-type: none"> <li>• To display the signal again, set this function OFF.</li> <li>• After about 5 minutes of displaying the TRANSITION DETECTOR ON alarm, the lamp will turn off.</li> <li>• Keystone adjustment feature has been prohibited as long as the Transition Detector function is on.</li> </ul> <p><b>1 Turning on the TRANSITION DETECTOR</b></p> <p>1-1 Use the ▲/▼ buttons on the SECURITY menu to select TRANSITION DETECTOR and press the ► or the ENTER button to display the TRANSITION DETECTOR on/off menu.</p> <p>1-2 Use the ▲/▼ buttons on the TRANSITION DETECTOR on/off menu to select ON. Select ON and the current angle and MIRROR setting will be recorded. The ENTER NEW PASSWORD box (small) will be displayed.</p> <p>1-3 Use the ▲/▼/◀/▶ buttons to enter a password. Move the cursor to the right side of the ENTER NEW PASSWORD box (small) and press the ► button to display the NEW PASSWORD AGAIN box, enter the same password again.</p> <p>1-4 Move the cursor to the right side of the NEW PASSWORD AGAIN box and press the ► button to display the NOTE NEW PASSWORD box for about 20 seconds, please make note of the password during this time.</p> <p>Pressing the ENTER button on the remote control or the ► button on the projector will return to the TRANSITION DETECTOR on/off menu.</p> <ul style="list-style-type: none"> <li>• Please do not forget your TRANSITION DETECTOR password.</li> <li>• This function will activate only when the projector is started after turning off the AC power.</li> <li>• This feature may not function properly if the projector is not in a stable position when ON is selected.</li> </ul> <p><b>2 Turning off the TRANSITION DETECTOR</b></p> <p>2-1 Follow the procedure in 1-1 to display the TRANSITION DETECTOR on/off menu.</p> <p>2-2 Select OFF to display the ENTER PASSWORD box (large). Enter the registered password and the screen will return to the TRANSITION DETECTOR on/off menu.</p> <p>If an incorrect password is input, the menu will close. If necessary, repeat the process from 2-1.</p> <p><b>3 If you have forgotten your password</b></p> <p>3-1 Follow the procedure in 1-1 to display the TRANSITION DETECTOR on/off menu.</p> <p>3-2 Select OFF to display the ENTER PASSWORD box (large). The 10 digit Inquiring Code will be displayed inside the box.</p> <p>3-3 Contact your dealer with the 10 digit Inquiring Code. Your password will be sent after your user registration information is confirmed.</p>
	     

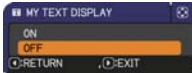
Item	Description
<b>MY TEXT PASSWORD</b>	<p>The MY TEXT PASSWORD function can prevent the MY TEXT from being overwritten. When the password is set for the MY TEXT;</p> <ul style="list-style-type: none"> <li>• The MY TEXT DISPLAY menu will be unavailable, which can prohibit changing the DISPLAY setting.</li> <li>• The MY TEXT WRITING menu will be unavailable, which can prevent the MY TEXT from being overwritten.</li> </ul> <p><b>1 Turning on the MY TEXT PASSWORD</b></p> <p>1-1 Use the ▲/▼ buttons on the SECURITY menu to select the MY TEXT PASSWORD and press the ► button to display the MY TEXT PASSWORD on/off menu.</p>  <p>1-2 Use the ▲/▼ buttons on the MY TEXT PASSWORD on/off menu to select ON. The ENTER NEW PASSWORD box (small) will be displayed.</p>  <p>ENTER NEW PASSWORD box (small)</p> <p>1-3 Use the ▲/▼/◀/▶ buttons to enter the password. Move the cursor to the right side of the ENTER NEW PASSWORD box (small) and press the ► button to display the NEW PASSWORD AGAIN box, and then enter the same password again.</p>  <p>1-4 Move the cursor to the right side of the NEW PASSWORD AGAIN box and press ► button to display the NOTE NEW PASSWORD box for about 20 seconds, then please make note of the password during this time.</p>  <p>Pressing the <b>ENTER</b> button on the remote control or ► button on the projector will return to the MY TEXT PASSWORD on/off menu.</p> <p><b>2 Turning off the MY TEXT PASSWORD</b></p> <p>2-1 Follow the procedure in 1-1 to display the MY TEXT PASSWORD on/off menu.</p> <p>2-2 Select OFF to display the ENTER PASSWORD box (large). Enter the registered password and the screen will return to the MY TEXT PASSWORD on/off menu.</p>  <p>ENTER PASSWORD box (large)</p> <p>If an incorrect password is input, the menu will close. If necessary, repeat the process from 2-1</p> <p><b>3 If you have forgotten your password</b></p> <p>3-1 Follow the procedure in 1-1 to display the MY TEXT PASSWORD on/off menu.</p> <p>3-2 Select OFF to display the ENTER PASSWORD box (large). The 10 digit inquiring code will be displayed inside the box.</p> <p>3-3 Contact your dealer with the 10 digit inquiring code. Your password will be sent after your user registration information is confirmed.</p>

(continued on next page)

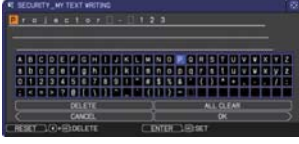
Item	Description
<p><b>MY TEXT DISPLAY</b></p>	<p>(1) Use the ▲/▼ buttons on the SECURITY menu to select the MY TEXT DISPLAY and press the ► button to display the MY TEXT DISPLAY on/off menu.</p>  <p>(2) Use the ▲/▼ buttons on the MY TEXT DISPLAY on/off menu to select on or off.</p> <p>ON ⇔ OFF</p> <p>When it is set ON, the MY TEXT will be displayed on the START UP screen and the INPUT_INFORMATION when the INFORMATION on the SERVICE menu is chosen.</p> <ul style="list-style-type: none"> <li>• This function is available only when the MY TEXT PASSWORD function is set to the OFF.</li> </ul>  
<p><b>MY TEXT WRITING</b></p>	<p>(1) Use the ▲/▼ buttons on the SECURITY menu to select the MY TEXT WRITING and press the ► button. The MY TEXT WRITING dialog will be displayed.</p>  <p>(2) The current MY TEXT will be displayed on the first 3 lines. If not yet written, the lines will be blank.</p> <p>Use the ▲/▼/◀/▶ buttons and the <b>ENTER</b> or <b>INPUT</b> button to select and enter characters. The <b>RESET</b> button can be used to erase 1 character at a time. Also if you move the cursor to <b>DELETE</b> or <b>ALL CLEAR</b> on screen and press the <b>ENTER</b> or <b>INPUT</b> button, 1 character or all characters will be erased. The MY TEXT can be input up to 24 characters on each line.</p>  <p>(3) To change an already inserted character, press the ▲/▼ button to move the cursor to one of the first 3 lines, and use the ◀/▶ buttons to move the cursor on the character to be changed.</p> <p>After pressing the <b>ENTER</b> or <b>INPUT</b> button, the character is selected. Then, follow the same procedure as described at the item (2) above.</p> <p>(4) To finish entering text, move the cursor to the OK on screen and press the <b>ENTER</b> or <b>INPUT</b> button. To revert to the previous MY TEXT without saving changes, move the cursor to the CANCEL on screen and press the <b>ENTER</b> or <b>INPUT</b> button.</p> <ul style="list-style-type: none"> <li>• The MY TEXT WRITING function is available only when the MY TEXT PASSWORD function is set to OFF.</li> </ul> 

## Maintenance

## Replacing the lamp

A lamp has finite product life. Using the lamp for long periods of time could cause the pictures darker or the color tone poor. Note that each lamp has a different lifetime, and some may burst or burn out soon after you start using them.

Preparation of a new lamp and early replacement are recommended. To prepare a new lamp, make contact with your dealer and tell the lamp type number.

Type number : DT01021

## Replacing the lamp

1. Turn the projector off, and unplug the power cord.  
Allow the projector to cool for at least 45 minutes.
2. Prepare a new lamp. If the projector is mounted on a ceiling, or if the lamp has broken, also ask the dealer to replace the lamp.

In case of replacement by yourself, follow the following procedure.

3. Loosen the screw (marked by arrow) of the lamp cover and then slide and lift the lamp cover to the side to remove it.
4. Loosen the 3 screws (marked by arrow) of the lamp, and slowly pick up the lamp by the handles. **Never** loosen any other screws.
5. Insert the new lamp, and retighten firmly the 3 screws of the lamp that are loosened in the previous process to lock it in place.
6. While putting the interlocking parts of the lamp cover and the projector together, slide the lamp cover back in place. Then firmly fasten the screw of the lamp cover.
7. Turn the projector on and reset the lamp time using the LAMP TIME item in the OPTION menu.
  - (1) Press the **MENU** button to display a menu.
  - (2) Point at the **ADVANCED MENU** in the menu using the **▼/▲** button, then press the **▶** button.
  - (3) Point at the **OPTION** in the left column of the menu using the **▼/▲** button, then press the **▶** button.
  - (4) Point at the **LAMP TIME** using the **▼/▲** button, then press the **▶** button. A dialog will appear.
  - (5) Press the **▶** button to select "OK" on the dialog. It performs resetting the lamp time.

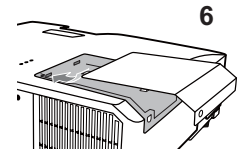
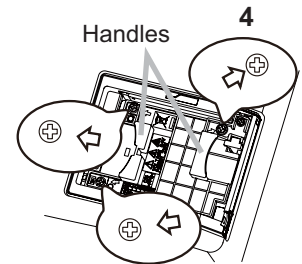
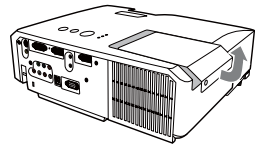
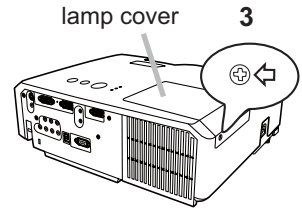

**⚠ CAUTION** ▶ Do not touch any inner space of the projector, while the lamp is taken out.

**NOTE** • Please reset the lamp time only when you have replaced the lamp, for a suitable indication about the lamp.

## Replacing the lamp (continued)

### Lamp warning

 **HIGH VOLTAGE**     **HIGH TEMPERATURE**     **HIGH PRESSURE**

**⚠ WARNING** ▶ The projector uses a high-pressure mercury glass lamp. The lamp can break with a loud bang, or burn out, if jolted or scratched, handled while hot, or worn over time. Note that each lamp has a different lifetime, and some may burst or burn out soon after you start using them. In addition, when the bulb bursts, it is possible for shards of glass to fly into the lamp housing, and for gas containing mercury to escape from the projector's vent holes.

▶ **About disposal of a lamp:** This product contains a mercury lamp; do not put it in a trash. Dispose of it in accordance with environmental laws.

- For lamp recycling, go to [www.lamprecycle.org](http://www.lamprecycle.org) (in the US).
- For product disposal, consult your local government agency or [www.eiae.org](http://www.eiae.org) (in the US) or [www.epsc.ca](http://www.epsc.ca) (in Canada).

For more information, call your dealer.



Disconnect  
the plug  
from the  
power  
outlet

- If the lamp should break (it will make a loud bang when it does), unplug the power cord from the outlet, and make sure to request a replacement lamp from your local dealer. Note that shards of glass could damage the projector's internals, or cause injury during handling, so please do not try to clean the projector or replace the lamp yourself.
- If the lamp should break (it will make a loud bang when it does), ventilate the room well, and make sure not to breathe the gas that comes out of the projector vents, or get it in your eyes or mouth.
- Before replacing the lamp, turn the projector off and unplug the power cord, then wait at least 45 minutes for the lamp to cool sufficiently. Handling the lamp while hot can cause burns, as well as damaging the lamp.



- Never unscrew except the appointed (marked by an arrow) screws.
- Do not open the lamp cover while the projector is suspended from a ceiling. This is dangerous, since if the lamp's bulb has broken, the shards will fall out when the cover is opened. In addition, working in high places is dangerous, so ask your local dealer to have the lamp replaced even if the bulb is not broken.
- Do not use the projector with the lamp cover removed. At the lamp replacing, make sure that the screws are screwed in firmly. Loose screws could result in damage or injury.



- Use only the lamp of the specified type.
- If the lamp breaks soon after the first time it is used, it is possible that there are electrical problems elsewhere besides the lamp. If this happens, consult your local dealer or a service representative.
- Handle with care: jolting or scratching could cause the lamp bulb to burst during use.
- Using the lamp for long periods of time, could cause it dark, not to light up or to burst. When the pictures appear dark, or when the color tone is poor, please replace the lamp as soon as possible. Do not use old (used) lamps; this is a cause of breakage.

## Cleaning and replacing the air filter

The air filter unit of this projector consists of a filter cover, two kinds of filters, and a filter frame. The new double large filters system is expected to function longer. However, please check and clean it periodically to keep ventilation needed for normal operation of the projector.

When the indicators or a message prompts you to clean the air filter, comply with it as soon as possible. Replace the filters when they are damaged or too soiled. To prepare new filters, make contact with your dealer and tell the following type number.

**Type number : MU06481** (Filter set)

When you replace the lamp, please replace the air filter. An air filter of specified type will come together with a replacement lamp for this projector.

1. Turn the projector off, and unplug the power cord.  
Allow the projector to sufficiently cool down.
2. Use a vacuum cleaner on and around the filter cover.
3. While supporting the projector with one hand, use your other hand to pull the filter cover forward in the direction of the arrow.
4. Use a vacuum cleaner for the filter vent of the projector and the outer side of the filter unit.
5. Take the filters out while holding the filter cover.
6. Use a vacuum cleaner onto the both sides of the filters. When vacuuming up the fine meshed filter, hold it so it will not be sucked in. If the filters are damaged or heavily soiled, replace them with the new ones.
7. Put the filters back into the filter cover.  
Put the coarse meshed filter into a filter cover first. Then put the fine meshed filter on the coarse meshed one, turning its stitched side up.
8. Put the filter unit back into the projector.

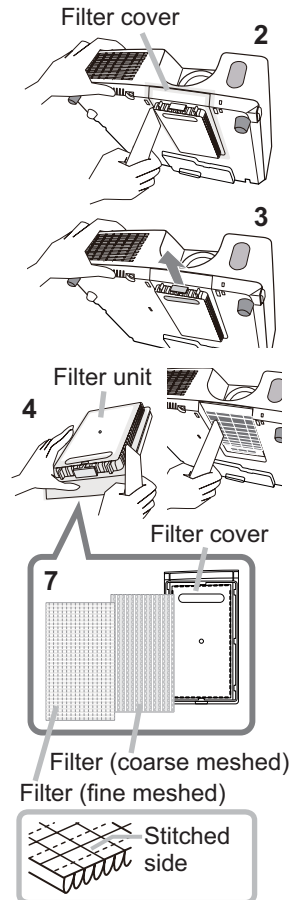

(continued on next page)



### ***Cleaning and replacing the air filter (continued)***

9. Turn the projector on and reset the filter time using the FILTER TIME item in the EASY MENU.
  - (1) Press the **MENU** button to display a menu.
  - (2) Point at the FILTER TIME using the ▼/▲ button, then press the ► button. A dialog will appear.
  - (3) Press the ► button to select “OK” on the dialog. It performs resetting the filter time.

**⚠ WARNING** ► Before taking care of the air filter, make sure the power cable is not plugged in, then allow the projector to cool sufficiently. Taking care of the air filter in a high temperature state of the projector could cause an electric shock, a burn or malfunction to the projector.

► Use only the air filter of the specified type. Do not use the projector without the air filter or the filter cover. It could result in a fire or malfunction to the projector.

► Clean the air filter periodically. If the air filter becomes clogged by dust or the like, internal temperatures rise and could cause a fire, a burn or malfunction to the projector.

**NOTE** • Please replace the air filter when it is damaged or too soiled.

- When you replace the projection lamp, please replace the air filter. An air filter of specified type will come together with a replacement lamp for this projector.
- Please reset the filter time only when you have cleaned or replaced the air filter, for a suitable indication about the air filter.
- The projector may display the message such as “CHECK THE AIR FLOW” or turn off the projector, to prevent the internal heat level rising.

## Other care

### Inside of the projector

In order to ensure the safe use of your projector, please have it cleaned and inspected by your dealer about once every year.

### Caring for the lens

If the lens is flawed, soiled or fogged, it could cause deterioration of display quality. Please take care of the lens, being cautious of handling.

1. Turn the projector off, and unplug the power cord. Allow the projector to cool sufficiently.
2. After making sure that the projector is cool adequately, lightly wipe the lens with a commercially available lens-cleaning wipe. Do not touch the lens directly with your hand.

### Caring for the cabinet and remote control

Incorrect care could have adverse influence such as discoloration, peeling paint, etc.

1. Turn the projector off, and unplug the power cord. Allow the projector to cool sufficiently.
2. After making sure that the projector is cool adequately, lightly wipe with gauze or a soft cloth.  
If the projector is extremely dirty, dip soft cloth in water or a neutral cleaner diluted in water, and wipe lightly after wringing well. Then, wipe lightly with a soft, dry cloth.

**⚠ WARNING** ▶ Before caring, make sure the power cord is not plugged in, and then allow the projector to cool sufficiently. The care in a high temperature state of the projector could cause a burn and/or malfunction to the projector.

▶ Never try to care for the inside of the projector personally. Doing is so dangerous.

▶ Avoid wetting the projector or inserting liquids in the projector. It could result in a fire, an electric shock, and/or malfunction to the projector.

- Do not put anything containing water, cleaners or chemicals near the projector.
- Do not use aerosols or sprays.

**⚠ CAUTION** ▶ Please take right care of the projector according to the following. Incorrect care could cause not only an injury but adverse influence such as discoloration, peeling paint, etc.

- ▶ Do not use cleaners or chemicals other than those specified in this manual.
- ▶ Do not polish or wipe with hard objects.

## Troubleshooting

If an abnormal operation should occur, stop using the projector immediately.





**⚠ WARNING** ▶ Never use the projector if abnormal operations such as smoke, strange odor, excessive sound, damaged casing or elements or cables, penetration of liquids or foreign matter, etc. should occur. In such cases, immediately disconnect the power plug from the power outlet. After making sure that the smoke or odor has stopped, contact to your dealer or service company.

Otherwise if a problem occurs with the projector, the following checks and measures are recommended before requesting repair.

If this does not resolve the problem, please contact your dealer or service company. They will tell you what warranty condition is applied.

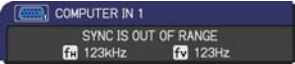
### Related messages

When some message appears, check and cope with it according to the following table. Although these messages will be automatically disappeared around several minutes, it will be reappeared every time the power is turned on.

Message	Description
	<p><b>There is no input signal.</b> Please confirm the signal input connection, and the status of the signal source.</p>
	<p><b>The horizontal or vertical frequency of the input signal is not within the specified range.</b> Please confirm the specs for your projector or the signal source specs.</p>
	<p><b>An improper signal is input.</b> Please confirm the specs for your projector or the signal source specs.</p>
	<p><b>The internal temperature is rising.</b> Please turn the power off, and allow the projector to cool down at least 20 minutes. After having confirmed the following items, please turn the power ON again.</p> <ul style="list-style-type: none"> <li>• Is there blockage of the air passage aperture?</li> <li>• Is the air filter dirty?</li> <li>• Does the peripheral temperature exceed 35°C?</li> </ul> <p>If the same indication is displayed after the remedy, please set FAN SPEED of the SERVICE item in the OPTION menu to HIGH.</p>
	<p><b>A note of precaution when cleaning the air filter.</b> Please immediately turn the power off, and clean or change the air filter referring to the “Cleaning and replacing the air filter” section of this manual. After you have cleaned or changed the air filter, please be sure to reset the filter timer (43).</p>

## Regarding the indicator lamps

When operation of the **LAMP**, **TEMP** and **POWER** indicators differs from usual, check and cope with it according to the following table.

POWER indicator	LAMP indicator	TEMP indicator	Description
Lighting In <b>Orange</b>	Turned <b>off</b>	Turned <b>off</b>	<b>The projector is in a standby state.</b> Please refer to the section "Power on/off".
<i>Blinking</i> In <b>Green</b>	Turned <b>off</b>	Turned <b>off</b>	<b>The projector is warming up.</b> Please wait.
Lighting In <b>Green</b>	Turned <b>off</b>	Turned <b>off</b>	<b>The projector is in an on state.</b> Ordinary operations may be performed.
<i>Blinking</i> In <b>Orange</b>	Turned <b>off</b>	Turned <b>off</b>	<b>The projector is cooling down.</b> Please wait.
<i>Blinking</i> In <b>Red</b>	(discretionary)	(discretionary)	<b>The projector is cooling down. A certain error has been detected.</b> Please wait until <b>POWER</b> indicator finishes blinking, and then perform the proper measure using the item descriptions below.
<i>Blinking</i> In <b>Red</b> or Lighting In <b>Red</b>	Lighting In <b>Red</b>	Turned <b>off</b>	<b>The lamp does not light, and there is a possibility that interior portion has become heated.</b> Please turn the power off, and allow the projector to cool down at least 20 minutes. After the projector has sufficiently cooled down, please make confirmation of the following items, and then turn the power on again. <ul style="list-style-type: none"> <li>• Is there blockage of the air passage aperture?</li> <li>• Is the air filter dirty?</li> <li>• Does the peripheral temperature exceed 35°C?</li> </ul> If the same indication is displayed after the remedy, please change the lamp referring to the section "Replacing the lamp".
<i>Blinking</i> In <b>Red</b> or Lighting In <b>Red</b>	<i>Blinking</i> In <b>Red</b>	Turned <b>off</b>	<b>The lamp cover has not been properly fixed.</b> Please turn the power off, and allow the projector to cool down at least 45 minutes. After the projector has sufficiently cooled down, please make confirmation of the attachment state of the lamp cover. After performing any needed maintenance, turn the power on again. If the same indication is displayed after the remedy, please contact your dealer or service company.
<i>Blinking</i> In <b>Red</b> or Lighting In <b>Red</b>	Turned <b>off</b>	<i>Blinking</i> In <b>Red</b>	<b>The cooling fan is not operating.</b> Please turn the power off, and allow the projector to cool down at least 20 minutes. After the projector has sufficiently cooled down, please make confirmation that no foreign matter has become caught in the fan, etc., and then turn the power on again. If the same indication is displayed after the remedy, please contact your dealer or service company.

(Continued on next page)

**Regarding the indicator lamps (continued)**

POWER indicator	LAMP indicator	TEMP indicator	Description
Blinking In <b>Red</b> or Lighting In <b>Red</b>	Turned off	Lighting In <b>Red</b>	<p><b>There is a possibility that the interior portion has become heated.</b></p> <p>Please turn the power off, and allow the projector to cool down at least 20 minutes. After the projector has sufficiently cooled down, please make confirmation of the following items, and then turn the power on again.</p> <ul style="list-style-type: none"> <li>• Is there blockage of the air passage aperture?</li> <li>• Is the air filter dirty?</li> <li>• Does the peripheral temperature exceed 35°C?</li> </ul> <p>If the same indication is displayed after the remedy, please set FAN SPEED of SERVICE item in OPTION menu to HIGH (  45).</p>
Lighting In <b>Green</b>	Simultaneous blinking in <b>Red</b>		<p><b>It is time to clean the air filter.</b></p> <p>Please immediately turn the power off, and clean or change the air filter referring to the section “Cleaning and replacing the air filter”. After cleaning or changing the air filter, please be sure to reset the filter timer. After the remedy, reset the power to ON.</p>
Lighting In <b>Green</b>	Alternative blinking in <b>Red</b>		<p><b>There is a possibility that the interior portion has become overcooled.</b></p> <p>Please use the unit within the usage temperature parameters (5°C to 35°C). After the treatment, reset the power to ON.</p>

**NOTE** • When the interior portion has become overheated, for safety purposes, the projector is automatically shut down, and the indicator lamps may also be turned off. In such a case, disconnect the power cord, and wait at least 45 minutes. After the projector has sufficiently cooled down, please make confirmation of the attachment state of the lamp and lamp cover, and then turn the power on again.

**Shutting the projector down**

Only when the projector can not be turned off by usual procedure (  14), please push the shutdown switch using a pin or similar, and disconnect the power plug from the power outlet. Before turning it on again, wait at least 10 minutes to make the projector cool down enough.

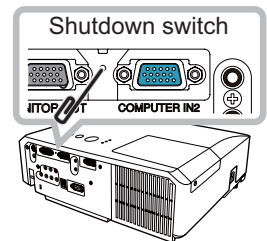

**Resetting all settings**

When it is hard to correct some wrong settings, the FACTORY RESET function of SERVICE item in OPTION menu (  46) can reset all settings(except LANGUAGE, FILTER TIME, LAMP TIME, FILTER MESSAGE and SECURITY settings and etc.) to the factory default.

## Phenomena that may be easy to be mistaken for machine defects

About the phenomenon confused with a machine defect, check and cope with it according to the following table.

Phenomenon	Cases not involving a machine defect	Reference page
Power does not come on.	<b>The electrical power cord is not plugged in.</b> Correctly connect the power cord.	11
	<b>The main power source has been interrupted during operation such as by a power outage (blackout), etc.</b> Please disconnect the power plug from the power outlet, and allow the projector to cool down at least 10 minutes, then turn the power on again.	11, 14
	<b>Either there is no lamp and/or lamp cover, or either of these has not been properly fixed.</b> Please turn the power off and disconnect the power plug from the power outlet, and allow the projector to cool down at least 45 minutes. After the projector has sufficiently cooled down, please make confirmation of the attachment state of the lamp and lamp cover, and then turn the power on again.	53, 54
Neither sounds nor pictures are outputted.	<b>The signal cables are not correctly connected.</b> Correctly connect the connection cables.	9
	<b>Signal source does not correctly work.</b> Correctly set up the signal source device by referring to the manual of the source device.	—
	<b>The input changeover settings are mismatched.</b> Select the input signal, and correct the settings.	15, 16
	<b>The BLANK function for pictures and the MUTE function for sounds are working.</b> AV MUTE may be active. Refer to the item “Sound does not come out” and “No pictures are displayed” on the next page to turn off the MUTE and BLANK functions.	15, 21, 44

(Continued on next page)

*Phenomena that may be easy to be mistaken for machine defects (continued)*

Phenomenon	Cases not involving a machine defect	Reference page
Sound does not come out.	<b>The signal cables are not correctly connected.</b> Correctly connect the audio cables.	9
	<b>The MUTE function is working.</b> Restore the sound pressing <b>MUTE</b> or <b>VOLUME +/-</b> button on the remote control.	15
	<b>The volume is adjusted to an extremely low level.</b> Adjust the volume to a higher level using the menu function or the remote control.	15
	<b>The AUDIO SOURCE/SPEAKER setting is not correct.</b> Correctly set the AUDIO SOURCE/SPEAKER in AUDIO menu.	36
No pictures are displayed.	<b>The lens cover is attached.</b> Remove the lens cover.	3
	<b>The signal cables are not correctly connected.</b> Correctly connect the connection cables.	9
	<b>The brightness is adjusted to an extremely low level.</b> Adjust BRIGHTNESS to a higher level using the menu function.	26
	<b>The computer cannot detect the projector as a plug and play monitor.</b> Make sure that the computer can detect a plug and play monitor using another plug and play monitor.	10
	<b>The BLANK screen is displayed.</b> Press <b>BLANK</b> button on the remote control.	21
Video screen display freezes.	<b>The FREEZE function is working.</b> Press <b>FREEZE</b> button to restore the screen to normal.	21
Colors have a faded- out appearance, or Color tone is poor.	<b>Color settings are not correctly adjusted.</b> Perform picture adjustments by changing the COLOR TEMP, COLOR, TINT and/or COLOR SPACE settings, using the menu functions.	27, 31
	<b>COLOR SPACE setting is not suitable.</b> Change the COLOR SPACE setting to AUTO, RGB, SMPTE240, REC709 or REC601.	31

(Continued on next page)

**Phenomena that may be easy to be mistaken for machine defects (continued)**

Phenomenon	Cases not involving a machine defect	Reference page
Pictures appear dark.	<p><b>The brightness and/or contrast are adjusted to an extremely low level.</b> Adjust BRIGHTNESS and/or CONTRAST settings to a higher level using the menu function.</p>	26
	<p><b>The lamp is approaching the end of its product lifetime.</b> Replace the lamp.</p>	53, 54
Pictures appear blurry.	<p><b>Either the focus and/or horizontal phase settings are not properly adjusted.</b> Adjust the focus using the focus ring, and/or H PHASE using the menu function.</p>	18, 30
	<p><b>The lens is dirty or misty.</b> Clean the lens referring to the section "Caring for the lens".</p>	57
RS-232C does not work.	<p><b>The SAVING function is working.</b> Select NORMAL for STANDBY MODE item in the SETUP menu.</p>	35

**NOTE** • Although bright spots or dark spots may appear on the screen, this is a unique characteristic of liquid crystal displays, and it does not constitute or imply a machine defect.



Specifications

**Specification**

Item	Specification
Product name	Liquid crystal projector
Liquid Crystal Panel	786,432 pixels (1024 horizontal x 768 vertical)
Lens	Zoom lens, f = 19 ~ 23 mm (approximately)
Lamp	210W UHP
Speaker	1W
Power supply	AC 100-120V/3.7A, AC220-240V/1.8A
Power consumption	330 W
Temperature range	5 ~ 35°C (Operating)
Size	317 (W) x 98 (H) x 288 (D) mm * Not including protruding parts. Please refer to the following figure.
Weight (mass)	approx. 3.5kg
Ports	<p><b>Computer input port</b>            COMPUTER IN1 .....D-sub 15 pin mini x1            COMPUTER IN2 .....D-sub 15 pin mini x1</p> <p><b>Computer output port</b>            MONITOR OUT .....D-sub 15 pin mini x1</p> <p><b>Video input port</b>            Y, Cb/Pb, Cr/Pr (Component video) ..... RCA x3            S-VIDEO..... mini DIN 4 pin x1            VIDEO ..... RCA x1</p> <p><b>Audio input/output port</b>            AUDIO IN1 .....Stereo mini x1            AUDIO IN2.....Stereo mini x1            AUDIO IN3 (R, L)..... RCA x2            AUDIO OUT (R, L)..... RCA x2</p> <p><b>Others</b>            USB .....USB-B x1            CONTROL ..... D-sub 9 pin x1</p>
Optional parts	<p><b>Lamp:</b> DT01021  <b>Filter set:</b> MU06481  <b>Mounting accessory:</b> HAS-3010 (Bracket for ceiling mount)                                              HAS-204L (Fixing adaptor for low ceilings)                                              HAS-304H (Fixing adaptor for high ceilings)</p> <p><b>Soft case:</b> CA3010</p> <p>* For more information, please consult your dealer.</p>

## Specifications (continued)

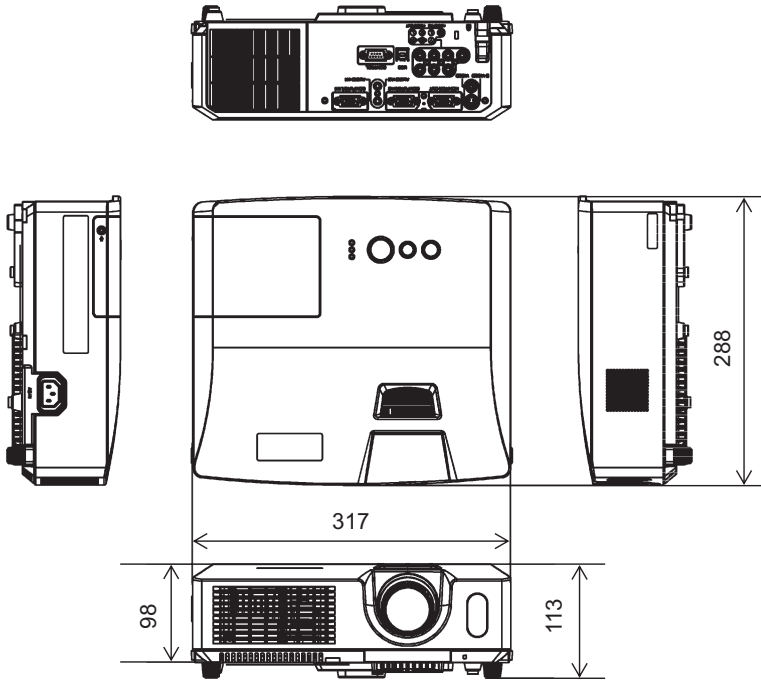

[unit: mm]

# Projector

# ED-X40/ED-X42 User's Manual (concise)

Thank you for purchasing this projector.

Please read through this manual before using this product, in order to use safely and utilize well the product.

**⚠ WARNING** ▶ Before using this product, be sure to read all manuals for this product. See “Using the CD manual” (📖15) to read the manuals in the CD. After reading them, store them in a safe place for future reference.  
▶ Heed all the warnings and cautions in the manuals or on the product.  
▶ Follow all the instructions in the manuals or on the product.

**NOTE** • In this manual, unless any comments are accompanied, “the manuals” means all the documents provided with this product, and “the product” means this projector and all the accessories came with the projector.

## Contents

First of all..... 2	Connecting power supply ..... 8
Entries and graphical symbols explanation .....2	Turning on the power..... 8
Important safety instruction .....2	Adjusting the projector's elevator ..... 9
Regulatory notices..... 3	Displaying the picture ..... 10
About Electro-Magnetic Interference .....3	Turning off the power..... 11
About Waste Electrical and Electronic Equipment...4	Replacing the lamp..... 12
Contents of package..... 4	Cleaning and replacing the air filter .. 14
Preparations ..... 5	Using the CD manual ..... 15
Loading batteries into the remote control .....5	Specifications ..... 16
Arrangement..... 6	Troubleshooting
Connecting your devices ..... 7	- Warranty and after-service ..... 17

# First of all

## Entries and graphical symbols explanation

The following entries and graphical symbols are used for the manuals and the product as follows, for safety purpose. Please know their meanings beforehand, and heed them.

- ⚠WARNING** This entry warns of a risk of serious personal injury or even death.
- ⚠CAUTION** This entry warns of a risk of personal injury or physical damage.
- NOTICE** This entry notices of fear of causing trouble.

## Important safety instruction

The followings are important instructions for safely using the product. Be sure to follow them always when handling the product.

- ⚠WARNING** ▶ Never use the product in or after an abnormality (ex. giving off smoke, smelling strange, took a liquid or an object inside, broken, etc.) If an abnormality should occur, unplug the projector urgently.
- ▶ Situate the product away from children and pets.
- ▶ Do not use the product when there is fear of a thunderbolt.
- ▶ Unplug the projector from the power outlet if the projector is not used for the time being.
- ▶ Do not open or remove any portion of the product, unless the manuals direct it. For internal maintenance, leave it to your dealer or their service personnel.
- ▶ Use only the accessories specified or recommended by the manufacturer.
- ▶ Modify neither the projector nor accessories.
- ▶ Let neither any things nor any liquids enter to the inside of the product.
- ▶ Do not wet the product.
- ▶ Apply neither a shock nor pressure to this product.
- Do not place the product on an unstable place such as the uneven surface or the leaned table.
- Do not place the product unstably. Place the projector so that it (even the lens part installed) does not protrude from the surface where the projector is placed on.
- Remove all the attachments including the power cord and cables, from the projector when carrying the projector.
- ▶ Do not look into the lens and the openings on the projector, while the lamp is on.
- ▶ Do not approach the lamp cover and the exhaust vents, while the projection lamp is on. Also after the lamp goes out, do not approach them for a while, since too hot.

## Regulatory notices

### About Electro-Magnetic Interference

#### In CANADA

This Class B digital apparatus complies with Canadian ICES-003.

#### In the US, and other places where the FCC regulations are applicable

#### Declaration of Conformity

Trade name	HITACHI
Model Number	ED-X40, ED-X42
Responsible Party	Hitachi Home Electronics (America), Inc.
Address	900 Hitachi way, Chula Vista, CA 91914-3556 U.S.A.
Telephone Number	+1 -800-225-1741

This device complies with part 15 of the FCC Rules. Operation is subject to the following two conditions: (1) This device may not cause harmful interference, and (2) this device must accept any interference received, including interference that may cause undesired operation. This equipment has been tested and found to comply with the limits for a Class B digital device, pursuant to Part 15 of the FCC Rules.

These limits are designed to provide reasonable protection against harmful interference in a residential installation. This equipment generates, uses, and can radiate radio frequency energy and, if not installed and used in accordance with the instructions, may cause harmful interference to radio communications. However, there is no guarantee that interference will not occur in a particular installation. If this equipment does cause harmful interference to radio or television reception, which can be determined by turning the equipment off and on, the user is encouraged to try to correct the interference by one or more of the following measures:

- Reorient or relocate the receiving antenna.
- Increase the separation between the equipment and receiver.
- Connect the equipment into an outlet on a circuit different from that to which the receiver is connected.
- Consult the dealer or an experienced radio/TV technician for help.

**INSTRUCTIONS TO USERS:** This equipment complies with the requirements of FCC (Federal Communication Commission) equipment provided that the following conditions are met. Some cables have to be used with the core set. Use the accessory cable or a designated-type cable for the connection. For cables that have a core only at one end, connect the core to the projector.

**CAUTION:** Changes or modifications not expressly approved by the party responsible for compliance could void the user's authority to operate the equipment.

## Regulatory notices (continued)

### About Waste Electrical and Electronic Equipment



The mark is in compliance with the Waste Electrical and Electronic Equipment Directive 2002/96/EC (WEEE).

The mark indicates the requirement NOT to dispose the equipment including any spent or discarded batteries or accumulators as unsorted municipal waste, but use the return and collection systems available. If the batteries or accumulators included with this equipment, display the chemical symbol Hg, Cd, or Pb, then it means that the battery has a heavy metal content of more than 0.0005% Mercury or more than, 0.002% Cadmium, or more than 0.004% Lead.

### Contents of package

Your projector should come with the items shown below. Check that all the items are included. Require of your dealer immediately if any items are missing.

- (1) Remote control with two AA batteries
- (2) Power cord
- (3) Computer cable
- (4) Lens cover
- (5) User's manuals (Book x1, CD x1)
- (6) Security label

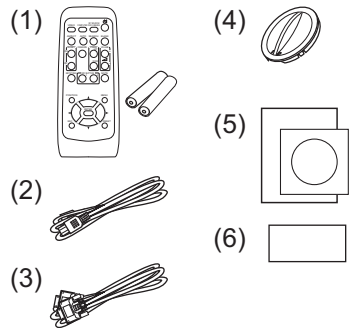

**NOTE** • Keep the original packing materials for future reshipment. Be sure to use the original packing materials when moving the projector. Use special caution for the lens.

# Preparations

## Loading batteries into the remote control

Please insert the batteries into the remote control before using it. If the remote control starts to malfunction, try to replace the batteries. If you will not use the remote control for long period, remove the batteries from the remote control and store them in a safe place.

1. Holding the hook part of the battery cover, remove it.
2. Align and insert the two AA batteries (HITACHI MAXELL, Part No.LR6 or R6P) according to their plus and minus terminals as indicated in the remote control.
3. Replace the battery cover in the direction of the arrow and snap it back into place.

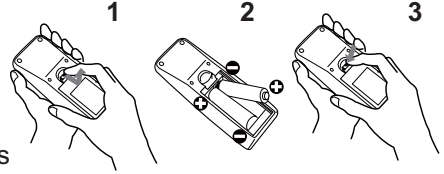

**⚠WARNING** ► Always handle the batteries with care and use them only as directed. Improper use may result in battery explosion, cracking or leakage, which could result in fire, injury and/or pollution of the surrounding environment.

- Be sure to use only the batteries specified. Do not use batteries of different types at the same time. Do not mix a new battery with used one.
- Make sure the plus and minus terminals are correctly aligned when loading a battery.
- Keep a battery away from children and pets.
- Do not recharge, short circuit, solder or disassemble a battery.
- Do not place a battery in a fire or water. Keep batteries in a dark, cool and dry place.
- If you observe battery leakage, wipe out the leakage and then replace a battery. If the leakage adheres to your body or clothes, rinse well with water immediately.
- Obey the local laws on disposing the battery.

# Arrangement

Refer to the illustrations and tables below to determine screen size and projection distance.

The values shown in the table are calculated for a full size screen: 1024 x 768

Ⓐ Screen size (diagonal)      Ⓑ Projection distance (±10%)

Ⓒ1, Ⓒ2 Screen height (±10%)

## On a horizontal surface

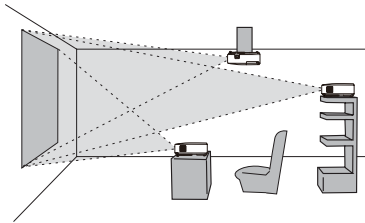
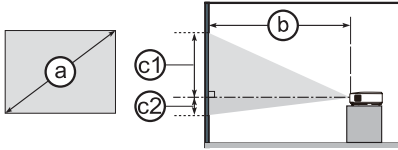

## Suspended from the ceiling

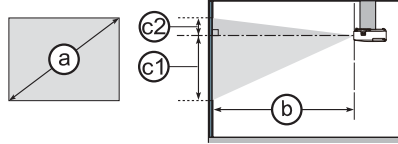

- Keep a space of 30 cm or more between the sides of the projector and other objects such as walls.
- For the case of installation in a special state such as ceiling mount, the specified mounting accessories (16) and service may be required. Before installing the projector, consult your dealer about your installation.

Ⓐ Screen size (diagonal)		4 : 3 screen								16 : 9 screen							
		Ⓑ Projection distance				Ⓒ1 Screen height		Ⓒ2 Screen height		Ⓑ Projection distance				Ⓒ1 Screen height		Ⓒ2 Screen height	
		min.		max.						min.		max.					
type (inch)	m	m	inch	m	inch	cm	inch	cm	inch	m	inch	m	inch	cm	inch	cm	inch
30	0.8	0.9	34	1.0	41	41	16	5	2	1.0	38	1.1	45	39	15	-1	0
40	1.0	1.2	46	1.4	55	55	22	6	2	1.3	51	1.5	60	51	20	-2	-1
50	1.3	1.5	58	1.8	69	69	27	8	3	1.6	64	1.9	76	64	25	-2	-1
60	1.5	1.8	70	2.1	83	82	32	9	4	1.9	77	2.3	91	77	30	-2	-1
70	1.8	2.1	82	2.5	97	96	38	11	4	2.3	89	2.7	106	90	35	-3	-1
80	2.0	2.4	94	2.8	112	110	43	12	5	2.6	102	3.1	122	103	41	-3	-1
90	2.3	2.7	106	3.2	126	123	49	14	5	2.9	115	3.5	137	116	46	-4	-1
100	2.5	3.0	118	3.6	140	137	54	15	6	3.3	128	3.9	153	129	51	-4	-2
120	3.0	3.6	142	4.3	168	165	65	18	7	3.9	154	4.7	183	154	61	-5	-2
150	3.8	4.5	177	5.3	211	206	81	23	9	4.9	193	5.8	229	193	76	-6	-2
200	5.1	6.0	237	7.1	281	274	108	30	12	6.6	258	7.8	306	257	101	-8	-3
250	6.4	7.5	297	8.9	352	343	135	38	15	8.2	323	9.7	383	322	127	-10	-4
300	7.6	9.0	356	10.7	422	411	162	46	18	9.9	388	11.7	460	386	152	-12	-5

- ⚠ WARNING** ▶ Install the projector in a stable horizontal position.
- ▶ Place the projector in a cool place, and ensure that there is sufficient ventilation.
  - ▶ Do not place the projector anywhere where it may get wet.
  - ▶ Use only the mounting accessories the manufacturer specified, and leave installing and removing the projector with the mounting accessories to the service personnel.
  - ▶ Read and keep the user's manual of the mounting accessories used.
- ⚠ CAUTION** ▶ Avoid placing the projector in smoky, humid or dusty place.
- ▶ Position the projector to prevent light from directly hitting the projector's remote sensor.



## Connecting your devices

Be sure to read the manuals for devices before connecting them to the projector. Make sure that all the devices are suitable to be connected with this product, and prepare the cables required to connect. Please refer to the following illustrations to connect them.

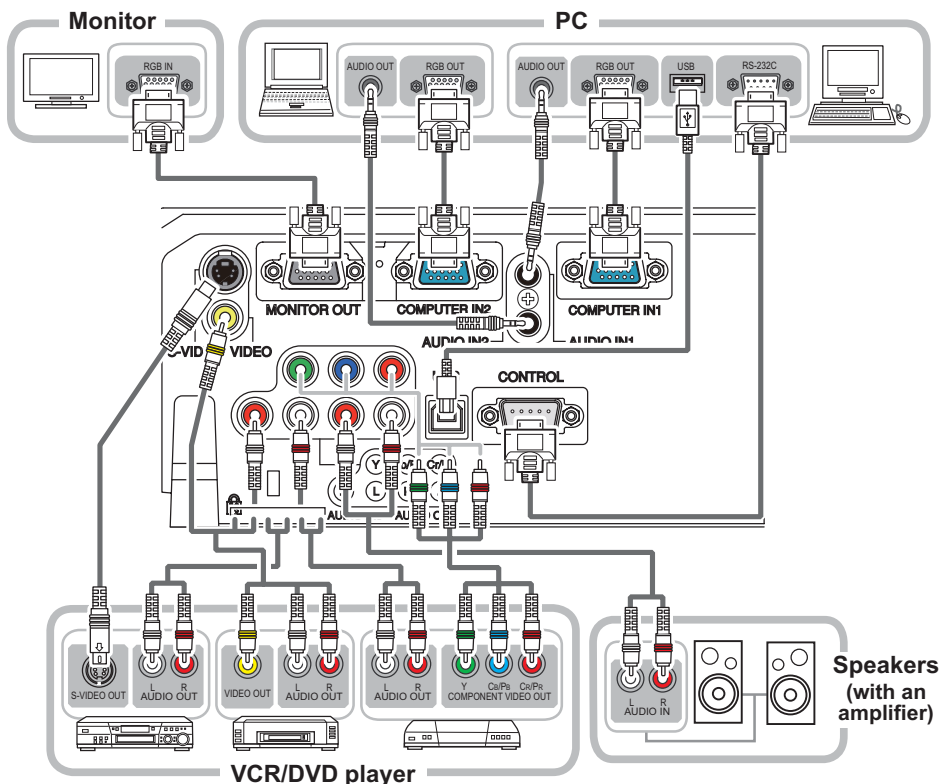

**⚠ WARNING** ► Do not disassemble or modify the projector and accessories.

► Be careful not to damage the cables, and do not use damaged cables.

**⚠ CAUTION** ► Turn off all devices and unplug their power cords prior to connecting them to projector. Connecting a live device to the projector may generate extremely loud noises or other abnormalities that may result in malfunction or damage to the device and the projector.

► Use appropriate accessory or designated cables. Ask your dealer about non-accessory cables which may be required a specific length or a ferrite core by the regulations. For cables with a core only at one end, connect the end with the core to the projector.

► Make sure that devices are connected to the correct ports. An incorrect connection may result in malfunction or damage to the device and the projector.

**NOTICE** ► Use the cables with straight plugs, not L-shaped ones, as the input ports of the projector are recessed.

## Connecting power supply

1. Put the connector of the power cord into the **AC IN** (AC inlet) of the projector.
2. Firmly plug the power cord's plug into the outlet. In a couple of seconds after the power supply connection, the **POWER** indicator will light up in steady orange.

Please remember that when the DIRECT ON function activated, the connection of the power supply make the projector turn on.

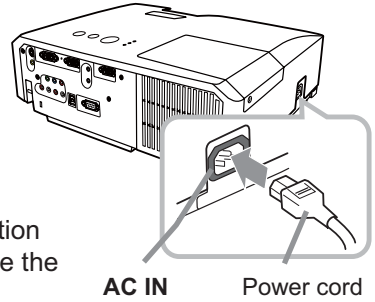

**⚠ WARNING** ► Please use extra caution when connecting the power cord, as incorrect or faulty connections may result in fire and/or electrical shock.

- Only use the power cord that came with the projector. If it is damaged, consult your dealer to get a new one.
- Only plug the power cord into an outlet whose voltage is matched to the power cord. The power outlet should be close to the projector and easily accessible. Remove the power cord for complete separation.
- Never modify the power cord.

## Turning on the power

1. Make sure that the power cord is firmly and correctly connected to the projector and the outlet.
2. Make sure that the **POWER** indicator is steady orange. Then remove the lens cover.
3. Press the **STANDBY/ON** button on the projector or the remote control.

The projection lamp will light up and the **POWER** indicator will begin blinking in green. When the power is completely on, the indicator will stop blinking and light in steady green.

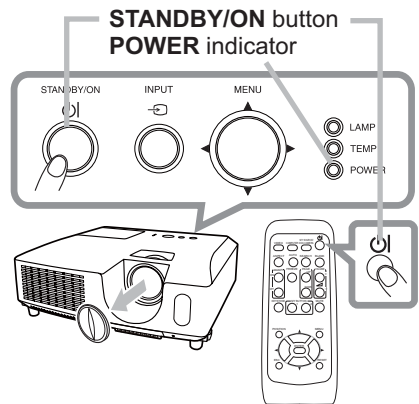

**⚠ WARNING** ► A strong light is emitted when the projector's power is on. Do not look into the lens of the projector or look inside of the projector through any of the projector's openings.

**NOTE** • Please power on the projector prior to the connected devices.  
• The projector has the DIRECT ON function, which can make the projector automatically turn on. For more information, please see the "Operating Guide" in the CD.

## Adjusting the projector's elevator

When the place to put the projector is slightly uneven to the left or right, use the elevator feet to place the projector horizontally.

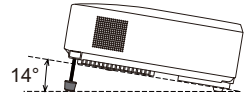

Using the feet can also tilt the projector in order to project at a suitable angle to the screen, elevating the front side of the projector within 14 degrees.

This projector has 2 elevator feet and 2 elevator buttons. An elevator foot is adjustable while pushing the elevator button on the same side as it.

1. Holding the projector, push the elevator buttons to loose the elevator feet.
2. Position the front side of the projector to the desired height.
3. Release the elevator buttons in order to lock the elevator feet.
4. After making sure that the elevator feet are locked, put the projector down gently.
5. If necessary, the elevator feet can be manually twisted to make more precise adjustments. Hold the projector when twisting the feet.

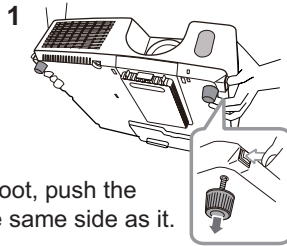

To loose an elevator foot, push the elevator button on the same side as it.

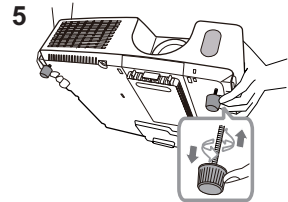

To finely adjust, twist the foot.

**⚠ CAUTION** ► Do not handle the elevator buttons without holding the projector, since the projector may drop down.

► Do not tilt the projector other than elevating its front within 14 degrees using the adjuster feet. A tilt of the projector exceeding the restriction could cause malfunction or shortening the lifetime of consumables, or the projector itself.

## Displaying the picture

1. Activate your signal source. Turn the signal source on, and make it send the signal to the projector.
2. Use the **VOLUME + / VOLUME -** buttons to adjust the volume.  
To have the projector silent, press the **MUTE** button on the remote control.
3. Press the **INPUT** button on the projector. Each time you press the button, the projector switches its input port in turn. You can also use the remote control to select an input signal. Press the **VIDEO** button for selecting an input signal from the **COMPONENT (Y, Cb/Pb, Cr/Pr)**, **S-VIDEO** or **VIDEO** port, or the **COMPUTER** button for selecting an input signal from the **COMPUTER IN1** or **COMPUTER IN2** port.
4. Press the **ASPECT** button on the remote control. Each time you press the button, the projector switches the mode for aspect ratio in turn.
5. Use the zoom ring to adjust the screen size.
6. Use the focus ring to focus the picture.

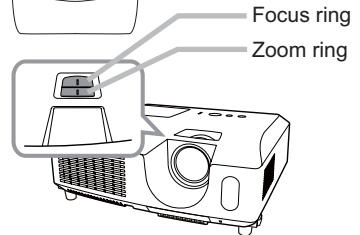
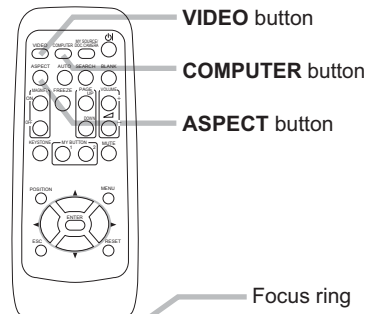
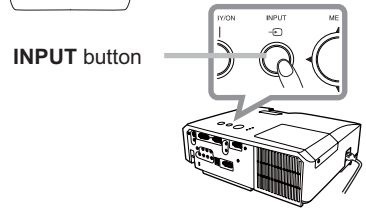
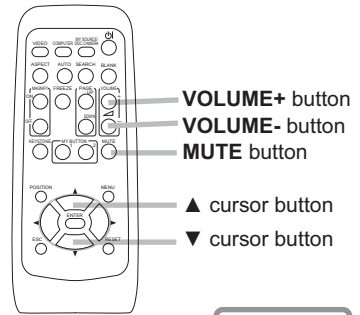

**NOTE** • The **ASPECT** button does not work when no proper signal is inputted.  
• For the details of how to adjust the picture, please see the “Operating Guide” in the CD.

## Turning off the power

1. Press the **STANDBY/ON** button on the projector or the remote control.  
The message “Power off?” will appear on the screen for about 5 seconds.
2. Press the **STANDBY/ON** button again while the message appears.  
The projector lamp will go off, and the **POWER** indicator will begin blinking in orange. Then the **POWER** indicator will stop blinking and light in steady orange when the lamp cooling is complete.
3. Attach the lens cover, after the **POWER** indicator turns in steady orange.

Do not turn the projector on for about 10 minutes or more after turning it off. Turning the projector on again too soon could shorten the lifetime of some consumable parts of the projector.

**⚠ WARNING** ▶ Do not touch around the lamp cover and the exhaust vents during use or just after use, since it is too hot.  
▶ Remove the power cord for complete separation. The power outlet should be close to the projector and easily accessible.

**NOTE** • Please power off the projector after any connected devices are powered off.  
• This projector has the AUTO OFF function that can make the projector turn off automatically. For more information, please see the “Operating Guide” in the CD.

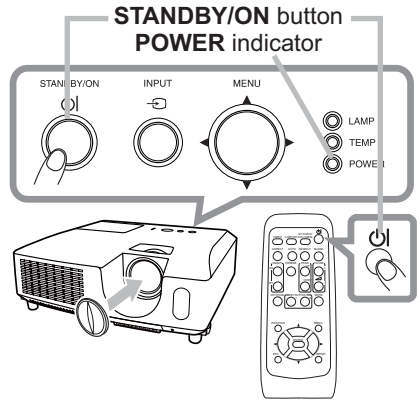

## Replacing the lamp

A lamp has finite product life. Using the lamp for long periods of time could cause the pictures darker or the color tone poor. Note that each lamp has a different lifetime, and some may burst or burn out soon after you start using them. Preparation of a new lamp and early replacement are recommended. To prepare a new lamp, make contact with your dealer and tell the lamp type number.

**Type number : DT01021**

1. Turn the projector off, and unplug the power cord.  
Allow the projector to cool for at least 45 minutes.
2. Prepare a new lamp. If the projector is mounted on a ceiling, or if the lamp has broken, also ask the dealer to replace the lamp.

In case of replacement by yourself, follow the following procedure.

3. Loosen the screw (marked by arrow) of the lamp cover and then slide and lift the lamp cover to the side to remove it.
4. Loosen the 3 screws (marked by arrow) of the lamp, and slowly pick up the lamp by the handles.

**Never loosen any other screws.**

5. Insert the new lamp, and retighten firmly the 3 screws of the lamp that are loosened in the previous process to lock it in place.
6. While putting the interlocking parts of the lamp cover and the projector together, slide the lamp cover back in place. Then firmly fasten the screw of the lamp cover.
7. Turn the projector on and reset the lamp time using the LAMP TIME item in the OPTION menu.

- (1) Press the **MENU** button to display a menu.
- (2) Point at the **ADVANCED MENU** in the menu using the **▼/▲** button, then press the **▶** button.
- (3) Point at the **OPTION** in the left column of the menu using the **▼/▲** button, then press the **▶** button.
- (4) Point at the **LAMP TIME** using the **▼/▲** button, then press the **▶** button. A dialog will appear.
- (5) Press the **▶** button to select "OK" on the dialog. It performs resetting the lamp time.

**⚠ CAUTION ▶** Do not touch any inner space of the projector, while the lamp is taken out.

**NOTE** • Please reset the lamp time only when you have replaced the lamp, for a suitable indication about the lamp.

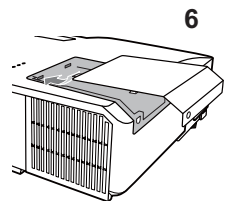
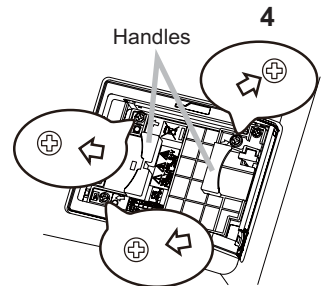
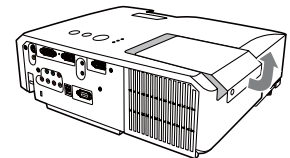
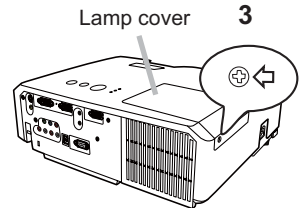

## Replacing the lamp (continued)

 **HIGH VOLTAGE**    **HIGH TEMPERATURE**    **HIGH PRESSURE**

**⚠ WARNING** ► The projector uses a high-pressure mercury glass lamp. The lamp can break with a loud bang, or burn out, if jolted or scratched, handled while hot, or worn over time. Note that each lamp has a different lifetime, and some may burst or burn out soon after you start using them. In addition, when the bulb bursts, it is possible for shards of glass to fly into the lamp housing, and for gas containing mercury to escape from the projector's vent holes.

► **About disposal of a lamp:** This product contains a mercury lamp; do not put it in a trash. Dispose of it in accordance with environmental laws.

- For lamp recycling, go to [www.lamprecycle.org](http://www.lamprecycle.org) (in the US).
- For product disposal, consult your local government agency or [www.eiae.org](http://www.eiae.org) (in the US) or [www.epsc.ca](http://www.epsc.ca) (in Canada).

For more information, ask your dealer.



- If the lamp should break (it will make a loud bang when it does), unplug the power cord from the outlet, and make sure to request a replacement lamp from your local dealer. Note that shards of glass could damage the projector's internals, or cause injury during handling, so please do not try to clean the projector or replace the lamp yourself.
- If the lamp should break (it will make a loud bang when it does), ventilate the room well, and make sure not to breathe the gas that comes out of the projector vents, or get it in your eyes or mouth.
- Before replacing the lamp, turn the projector off and unplug the power cord, then wait at least 45 minutes for the lamp to cool sufficiently. Handling the lamp while hot can cause burns, as well as damaging the lamp.



- Never unscrew except the appointed (marked by an arrow) screws.
- Do not open the lamp cover while the projector is suspended from a ceiling. This is dangerous, since if the lamp's bulb has broken, the shards will fall out when the cover is opened. In addition, working in high places is dangerous, so ask your local dealer to have the lamp replaced even if the bulb is not broken.
- Do not use the projector with the lamp cover removed. At the lamp replacing, make sure that the screws are screwed in firmly. Loose screws could result in damage or injury.



- Use only the lamp of the specified type.
- If the lamp breaks soon after the first time it is used, it is possible that there are electrical problems elsewhere besides the lamp. If this happens, consult your local dealer or a service representative.
- Handle with care: jolting or scratching could cause the lamp bulb to burst during use.
- Using the lamp for long periods of time, could cause it dark, not to light up or to burst. When the pictures appear dark, or when the color tone is poor, please replace the lamp as soon as possible. Do not use old (used) lamps; this is a cause of breakage.

## Cleaning and replacing the air filter

Please check and clean the air filter periodically. When the indicators or a message prompts you to clean the air filter, comply with it as soon as possible. The air filter has two kinds of filters inside. Replace the filters when they are damaged or too soiled. To prepare the new filters, make contact with your dealer and tell the following type number.

### Type number : MU06481 (Filter set)

When you replace the lamp, please replace the air filter. An air filter of specified type will come together with a replacement lamp for this projector.

1. Turn the projector off, and unplug the power cord. Allow the projector to sufficiently cool down.
2. Use a vacuum cleaner on and around the filter cover.
3. While supporting the projector with one hand, use your other hand to pull the filter cover forward in the direction of the arrow.
4. Use a vacuum cleaner for the filter vent of the projector and the outer side of the filter unit.
5. Take the filters out while holding the filter cover.
6. Use a vacuum cleaner onto the both sides of the filters. When vacuuming up the fine meshed filter, hold it so it will not be sucked in. If the filters are damaged or heavily soiled, replace them with the new ones.
7. Put the filters back into the filter cover. Put the coarse meshed filter into a filter cover first. Then put the fine meshed filter on the coarse meshed one, turning its stitched side up.
8. Put the filter unit back into the projector.
9. Turn the projector on and reset the filter time using the FILTER TIME item in the EASY MENU.
  - (1) Press the **MENU** button to display a menu.
  - (2) Point at the FILTER TIME using the **▼/▲** button, then press the **▶** button. A dialog will appear.
  - (3) Press the **▶** button to select "OK" on the dialog. It performs resetting the filter time.

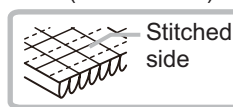
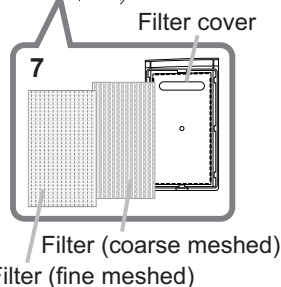
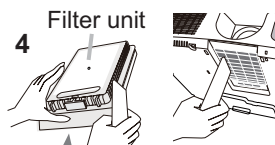
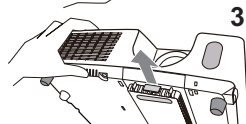
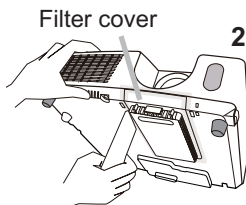

**⚠WARNING** ▶ Before taking care of the air filter, make sure the power cable is not plugged in, then allow the projector to cool sufficiently.  
▶ Use only the air filter of the specified type. Do not use the projector without the air filter or the filter cover. It could result in a fire or malfunction to the projector.  
▶ Clean the air filter periodically. If the air filter becomes clogged by dust or the like, internal temperatures rise and could cause a fire, a burn or malfunction to the projector.

**NOTE** • Please reset the filter time only when you have cleaned or replaced the air filter, for a suitable indication about the air filter.  
• The projector may display the message such as "CHECK THE AIR FLOW" or turn off the projector, to prevent the internal heat level rising.



## Using the CD manual

The other manuals for this product are written into the included CD-ROM titled "User's Manual (detailed)". Before using the CD-ROM, please read the following to ensure the proper use.

### ■ System requirements

The system for using the CD-ROM requires the following.

<b>Windows®:</b>	OS:Microsoft® Windows® 98, Windows® 98SE, Windows NT®4.0, Windows® Me, Windows® 2000/Windows® XP or later CPU:Pentium® processor 133MHz / Memory:32MB or more
<b>Macintosh®:</b>	OS:Mac OS® 10.2 or later CPU:PowerPC® / Memory:32MB or more
<b>CD-ROM drive:</b>	4x CD-ROM drive
<b>Display:</b>	256 color / 640x480 dots resolution
<b>Applications:</b>	Microsoft® Internet Explorer®4.0 and Adobe® Acrobat® Reader® 4.0 or later

### ■ How to use the CD

1. Insert CD into PC's CD-ROM drive.

**Windows®:** In a while, Web browser automatically starts. Start up window comes up.

**Macintosh®:** (1) Double-click on the "Projectors" icon appeared on the desktop screen.  
(2) When "main.html" file is clicked, Web browser will start and Initial window will appear.

2. Click the model name of your projector first, and then click language you want from the displayed list. The User's manual (detailed) will open.

**⚠ CAUTION** ▶ Only use the CD-ROM in a computer CD drive. The CD-ROM is designed for PC use only. NEVER INSERT THE CD-ROM INTO A NON-COMPUTER CD PLAYER! Inserting the CD-ROM into an incompatible CD drive may produce a loud noise, which in turn MAY RESULT IN EAR AND SPEAKER DAMAGE!

- After using CD-ROM, please put it into CD case and keep it. Please keep the CD neither in direct sunlight nor in a high temperature and high humidity environment.

**NOTE** • The information in the CD-ROM is subject to change without notice.

- No responsibility is taken for any obstacle and defect to hardware and software of your PC as a result of the use of the CD-ROM.
- All or Any part of the information in the CD-ROM must not be copied, reproduced or republished without notice to our company.

# Specifications

Item	Specification
Product name	Liquid crystal projector
Liquid Crystal Panel	786,432 pixels (1024 horizontal x 768 vertical)
Lens	Zoom lens, f = 19 ~ 23 mm (approximately)
Lamp	210W UHP
Speaker	1W
Power supply	AC 100-120V/3.7A, AC220-240V/1.8A
Power consumption	330W
Temperature range	5 ~ 35°C (Operating)
Size	317 (W) x 98 (H) x 288 (D) mm * Not including protruding parts. Please refer to the following figure.
Weight (mass)	approx. 3.5kg
Ports	<p><b>Computer input port</b>            COMPUTER IN1 ..... D-sub 15 pin mini x1            COMPUTER IN2 ..... D-sub 15 pin mini x1</p> <p><b>Computer output port</b>            MONITOR OUT ..... D-sub 15 pin mini x1</p> <p><b>Video input port</b>            Y, Cb/Pb, Cr/Pr (Component video) ..... RCA x3            S-VIDEO ..... mini DIN 4 pin x1            VIDEO ..... RCA x1</p> <p><b>Audio input/output port</b>            AUDIO IN1 ..... Stereo mini x1            AUDIO IN2 ..... Stereo mini x1            AUDIO IN3 (R, L) ..... RCA x2            AUDIO OUT (R, L) ..... RCA x2</p> <p><b>Others</b>            USB ..... USB-B x1            CONTROL ..... D-sub 9 pin x1</p>
Optional parts	<p><b>Lamp:</b> DT01021  <b>Filter set:</b> MU06481  <b>Mounting accessory:</b> HAS-3010 (Bracket for ceiling mount)                                      HAS-204L (Fixing adaptor for low ceilings)                                      HAS-304H (Fixing adaptor for high ceilings)  <b>Soft case:</b> CA3010            * For more information, please consult your dealer.</p>

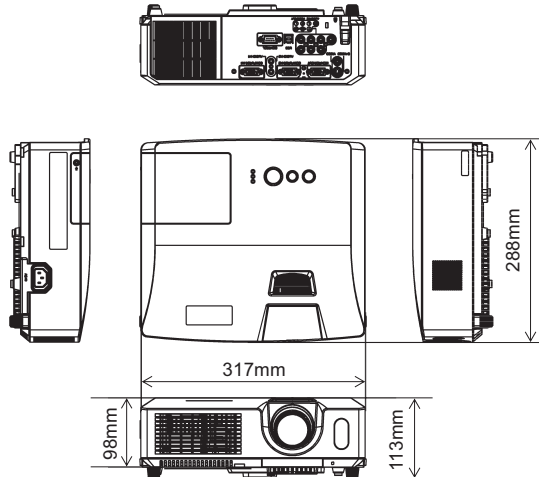

## Troubleshooting - Warranty and after-service

If an abnormal operation (such as smoke, strange odor or excessive sound) should occur, stop using the projector immediately. Otherwise if a problem occurs with the projector, first refer to the "Troubleshooting" of the "Operating Guide" in the CD and run through the suggested checks.

If this does not resolve the problem, please consult your dealer or service company. They will tell you what warranty condition is applied.

Please check the following web address where you may find the latest information for this projector.

<http://www.hitachi.us/digitalmedia>

or

<http://www.hitachidigitalmedia.com>

**NOTE** • The information in this manual is subject to change without notice.

- The manufacturer assumes no responsibility for any errors that may appear in this manual.
- The reproduction, transfer or copy of all or any part of this document is not permitted without express written consent.

### **Trademark acknowledgment**

- Mac<sup>®</sup>, Macintosh<sup>®</sup> and Mac OS<sup>®</sup> are registered trademarks of Apple Inc.
- Pentium<sup>®</sup> is a registered trademark of Intel Corp.
- Adobe<sup>®</sup> and Acrobat<sup>®</sup>, Reader<sup>®</sup> are registered trademarks of Adobe Systems Incorporated.
- Microsoft<sup>®</sup> and Internet explorer<sup>®</sup>, Windows<sup>®</sup>, Windows NT<sup>®</sup>, Windows Vista<sup>®</sup> are registered trademarks of Microsoft Corporation.
- PowerPC<sup>®</sup> is a registered trademark of International Business Machines Corporation.

All other trademarks are the properties of their respective owners.

## Projector

# ED-X40/ED-X42

## User's Manual (detailed) Operating Guide – Technical

### Example of PC signal

Resolution (H x V)	H. frequency (kHz)	V. frequency (Hz)	Rating	Signal mode
720 x 400	37.9	85.0	VESA	TEXT
640 x 480	31.5	59.9	VESA	VGA (60Hz)
640 x 480	37.9	72.8	VESA	VGA (72Hz)
640 x 480	37.5	75.0	VESA	VGA (75Hz)
640 x 480	43.3	85.0	VESA	VGA (85Hz)
800 x 600	35.2	56.3	VESA	SVGA (56Hz)
800 x 600	37.9	60.3	VESA	SVGA (60Hz)
800 x 600	48.1	72.2	VESA	SVGA (72Hz)
800 x 600	46.9	75.0	VESA	SVGA (75Hz)
800 x 600	53.7	85.1	VESA	SVGA (85Hz)
832 x 624	49.7	74.5		Mac 16" mode
1024 x 768	48.4	60.0	VESA	XGA (60Hz)
1024 x 768	56.5	70.1	VESA	XGA (70Hz)
1024 x 768	60.0	75.0	VESA	XGA (75Hz)
1024 x 768	68.7	85.0	VESA	XGA (85Hz)
1152 x 864	67.5	75.0	VESA	1152 x 864 (75Hz)
1280 x 768	47.7	60.0	VESA	W-XGA (60Hz)
1280 x 800	49.7	60.0	VESA	1280 x 800 (60Hz)
1280 x 960	60.0	60.0	VESA	1280 x 960 (60Hz)
1280 x 1024	64.0	60.0	VESA	SXGA (60Hz)
1280 x 1024	80.0	75.0	VESA	SXGA (75Hz)
1280 x 1024	91.1	85.0	VESA	SXGA (85Hz)
1400 x 1050	65.2	60.0	VESA	SXGA+ (60Hz)
1600 x 1200	75.0	60.0	VESA	UXGA (60Hz)

- NOTE** • Be sure to check jack type, signal level, timing and resolution before connecting this projector to a PC.
- Some PCs may have multiple display screen modes. Use of some of these modes will not be possible with this projector.
  - Depending on the input signal, full-size display may not be possible in some cases. Refer to the number of display pixels above.
  - Although the projector can display signals with resolution up to UXGA (1600x1200), the signal will be converted to the projector's panel resolution before being displayed. The best display performance will be achieved if the resolutions of the input signal and projector panel are identical.
  - Automatic adjustment may not function correctly with some input signals.
  - The image may not be displayed correctly when the input sync signal is a composite sync or a sync on G.

## Initial set signals

The following signals are used for the initial settings. The signal timing of some PC models may be different. In such case, adjust the items V POSITION and H POSITION in IMAGE menu.

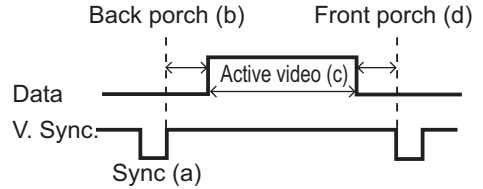
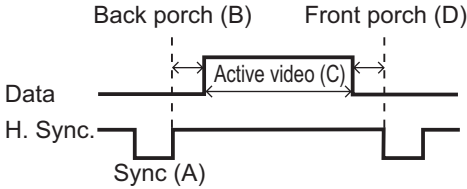

computer Signal	Horizontal signal timing (μs)			
	(A)	(B)	(C)	(D)
TEXT	2.0	3.0	20.3	1.0
VGA (60Hz)	3.8	1.9	25.4	0.6
VGA (72Hz)	1.3	4.1	20.3	0.8
VGA (75Hz)	2.0	3.8	20.3	0.5
VGA (85Hz)	1.6	2.2	17.8	1.6
SVGA (56Hz)	2.0	3.6	22.2	0.7
SVGA (60Hz)	3.2	2.2	20.0	1.0
SVGA (72Hz)	2.4	1.3	16.0	1.1
SVGA (75Hz)	1.6	3.2	16.2	0.3
SVGA (85Hz)	1.1	2.7	14.2	0.6
Mac 16" mode	1.1	3.9	14.5	0.6
XGA (60Hz)	2.1	2.5	15.8	0.4
XGA (70Hz)	1.8	1.9	13.7	0.3
XGA (75Hz)	1.2	2.2	13.0	0.2
XGA (85Hz)	1.0	2.2	10.8	0.5
1152 x 864 (75Hz)	1.2	2.4	10.7	0.6
W-XGA (60Hz)	1.7	2.5	16.0	0.8
1280 x 800 (60Hz)	1.6	2.4	15.3	0.8
1280 x 960 (60Hz)	1.0	2.9	11.9	0.9
SXGA (60Hz)	1.0	2.3	11.9	0.4
SXGA (75Hz)	1.1	1.8	9.5	0.1
SXGA (85Hz)	1.0	1.4	8.1	0.4
SXGA+ (60Hz)	1.2	2.0	11.4	0.7
UXGA (60Hz)	1.2	1.9	9.9	0.4

computer Signal	Vertical signal timing (lines)			
	(a)	(b)	(c)	(d)
TEXT	3	42	400	1
VGA (60Hz)	2	33	480	10
VGA (72Hz)	3	28	480	9
VGA (75Hz)	3	16	480	1
VGA (85Hz)	3	25	480	1
SVGA (56Hz)	2	22	600	1
SVGA (60Hz)	4	23	600	1
SVGA (72Hz)	6	23	600	37
SVGA (75Hz)	3	21	600	1
SVGA (85Hz)	3	27	600	1
Mac 16" mode	3	39	624	1
XGA (60Hz)	6	29	768	3
XGA (70Hz)	6	29	768	3
XGA (75Hz)	3	28	768	1
XGA (85Hz)	3	36	768	1
1152 x 864 (75Hz)	3	32	864	1
W-XGA (60Hz)	3	23	768	1
1280 x 800 (60Hz)	3	24	800	1
1280 x 960 (60Hz)	3	36	960	1
SXGA(60Hz)	3	38	1024	1
SXGA (75Hz)	3	38	1024	1
SXGA (85Hz)	3	44	1024	1
SXGA+ (60Hz)	3	33	1050	1
UXGA (60Hz)	3	46	1200	1

Connection to the ports

**NOTICE** ▶ Use the cables with straight plugs, not L-shaped ones, as the input ports of the projector are recessed.

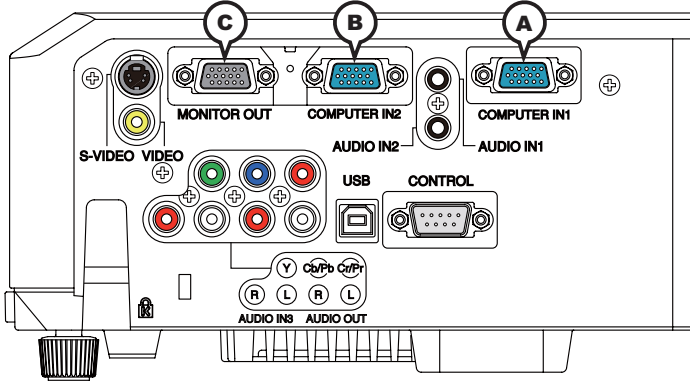

**Ⓐ**COMPUTER IN1, **Ⓑ**COMPUTER IN2, **Ⓒ**MONITOR OUT

D-sub 15pin mini shrink jack

- Video signal: RGB separate, Analog, 0.7Vp-p, 75Ω terminated (positive)
- H/V. sync. signal: TTL level (positive/negative)
- Composite sync. signal: TTL level

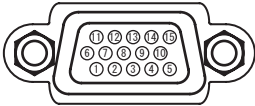

Pin	Signal	Pin	Signal
1	Video Red	9	(No connection)
2	Video Green	10	Ground
3	Video Blue	11	(No connection)
4	(No connection)	12	<b>Ⓐ</b> : SDA (DDC data) / <b>Ⓑ</b> , <b>Ⓒ</b> : (No connection)
5	Ground	13	H. sync / Composite sync.
6	Ground Red	14	V. sync.
7	Ground Green	15	<b>Ⓐ</b> : SCL (DDC clock) / <b>Ⓑ</b> , <b>Ⓒ</b> : (No connection)
8	Ground Blue		

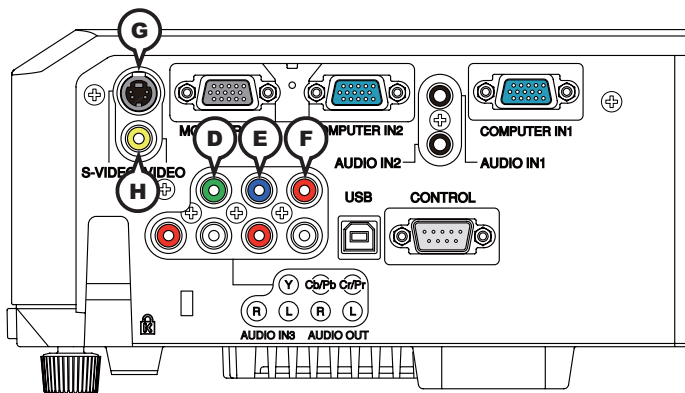

**COMPONENT (D)Y, (E)Cb/Pb (F)Cr/Pr**

RCA jack x3

- System: 480i@60, 480p@60, 576i@50, 720p@50/60, 1080i@50/60

Port	Signal
Y	Component video Y, $1.0 \pm 0.1V_{p-p}$ , $75\Omega$ terminator with composite sync
Cb/Pb	Component video Cb/Pb, $0.7 \pm 0.1V_{p-p}$ , $75\Omega$ terminator
Cr/Pr	Component video Cr/Pr, $0.7 \pm 0.1V_{p-p}$ , $75\Omega$ terminator

**(G)S-VIDEO**

Mini DIN 4pin jack



Pin	Signal
1	Color signal $0.286V_{p-p}$ (NTSC, burst), $75\Omega$ terminator Color signal $0.300V_{p-p}$ (PAL/SECAM, burst) $75\Omega$ terminator
2	Brightness signal, $1.0V_{p-p}$ , $75\Omega$ terminator
3	Ground
4	Ground

**(H)VIDEO**

RCA jack

- System: NTSC, PAL, SECAM, PAL-M, PAL-N, NTSC4.43, PAL60
- $1.0 \pm 0.1V_{p-p}$ ,  $75\Omega$  terminator

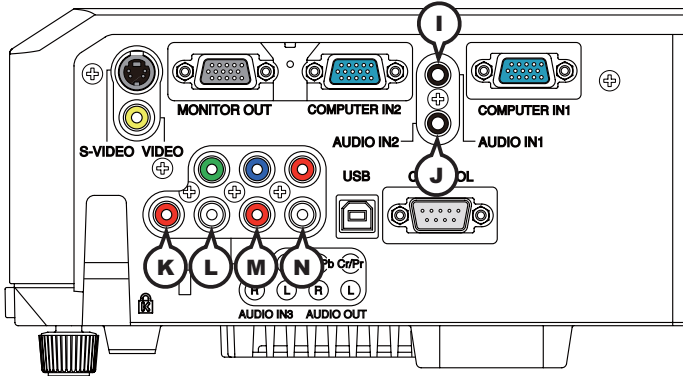

**ⓐAUDIO IN1, ⓑAUDIO IN2**

Ø3.5 stereo mini jack

- 200 mVrms 47kΩ terminator

**AUDIO IN3 ⓓR, ⓔL**

RCA jack x2

- 200 mVrms 47kΩ terminator

**AUDIO OUT ⓓR, ⓔL**

RCA jack x2

- 200 mVrms 1kΩ output impedance

**To input SCART RGB signal;**

ex.:

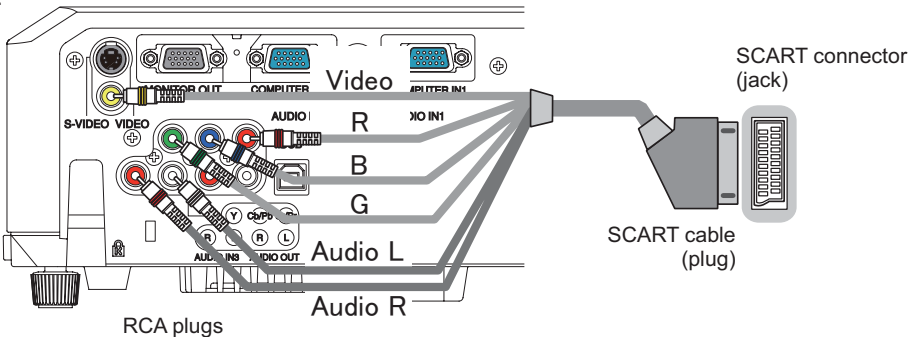

To input SCART RGB signal to the projector, use a SCART to RCA cable. Connect the plugs refer to above ex.. For more reference, please consult your dealer.



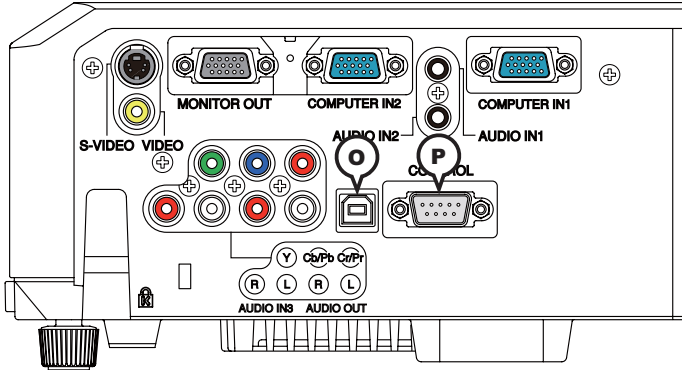

**USB**

USB B type jack

Pin	Signal
1	+5V
2	- Data
3	+ Data
4	Ground



**CONTROL**

D-sub 9pin plug

• About the details of RS-232C communication, please refer to the following page.

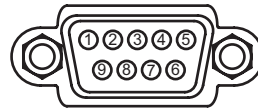

Pin	Signal	Pin	Signal	Pin	Signal
1	(No connection)	4	(No connection)	7	RTS
2	RD	5	Ground	8	CTS
3	TD	6	(No connection)	9	(No connection)

## RS-232C Communication

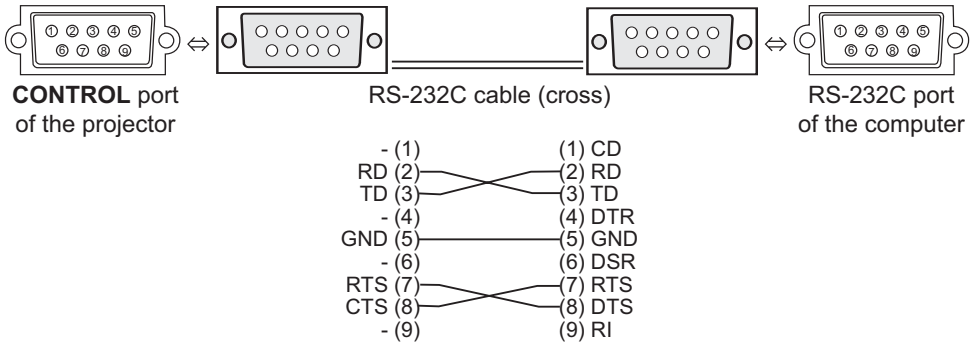

## Connecting the cable

1. Turn off the projector and the computer.
2. Connect the **CONTROL** port of the projector with a RS-232C port of the computer by a RS-232C cable (cross). Use the cable that fulfills the specification shown in the previous page.
3. Turn the computer on, and after the computer has started up turn the projector on.

## Communications setting

19200bps, 8N1

### 1. Protocol

Consist of header (7 bytes) + command data (6 bytes)

### 2. Header

BE + EF + 03 + 06 + 00 + CRC\_low + CRC\_high

CRC\_low: Lower byte of CRC flag for command data

CRC\_high: Upper byte of CRC flag for command data

### 3. Command data

Command data chart

byte_0	byte_1	byte_2	byte_3	byte_4	byte_5
Action		Type		Setting code	
low	high	low	high	low	high

Action (byte\_0 - 1)

Action	Classification	Content
1	Set	Change setting to desired value.
2	Get	Read projector internal setup value.
4	Increment	Increment setup value by 1.
5	Decrement	Decrement setup value by 1.
6	Execute	Run a command.

**Requesting projector status (Get command)**

- (1) Send the following request code from the PC to the projector.  
*Header + Command data ('02H' + '00H' + type (2 bytes) + '00H' + '00H')*
- (2) The projector returns the response code '1DH' + data (2 bytes) to the PC.

**Changing the projector settings (Set command)**

- (1) Send the following setting code from the PC to the projector.  
*Header + Command data ('01H' + '00H' + type (2 bytes) + setting code (2 bytes))*
- (2) The projector changes the setting based on the above setting code.
- (3) The projector returns the response code '06H' to the PC.

**Using the projector default settings (Reset Command)**

- (1) The PC sends the following default setting code to the projector.  
*Header + Command data ('06H' + '00H' + type (2 bytes) + '00H' + '00H')*
- (2) The projector changes the specified setting to the default value.
- (3) The projector returns the response code '06H' to the PC.

**Increasing the projector setting value (Increment command)**

- (1) The PC sends the following increment code to the projector.  
*Header + Command data ('04H' + '00H' + type (2 bytes) + '00H' + '00H')*
- (2) The projector increases the setting value on the above setting code.
- (3) The projector returns the response code '06H' to the PC.

**Decreasing the projector setting value (Decrement command)**

- (1) The PC sends the following decrement code to the projector.  
*Header + Command data ('05H' + '00H' + type (2 bytes) + '00H' + '00H')*
- (2) The projector decreases the setting value on the above setting code.
- (3) The projector returns the response code '06H' to the PC.

**When the projector cannot understand the received command**

When the projector cannot understand the received command, the error code '15H' is sent back to the PC.

Sometimes the projector cannot properly receive the command. In such a case, the command is not executed and the error code '15H' is sent back to the PC. If this error code is returned, send the same command again.

**When the projector cannot execute the received command.**

When the projector cannot execute the received command, the error code '1CH' + 'xxxxH' is sent back to the PC.

When the data length is greater than indicated by the data length code, the projector ignore the excess data code. Conversely when the data length is shorter than indicated by the data length code, an error code will be returned to the PC.

- NOTE** • Operation cannot be guaranteed when the projector receives an undefined command or data.
- Provide an interval of at least 40ms between the response code and any other code.
  - The projector outputs test data when the power supply is switched ON, and when the lamp is lit. Ignore this data.
  - Commands are not accepted during warm-up.

## RS-232C Communication command table

Names	Operation Type	Header				Command Data			
						CRC	Action	Type	Setting Code
Power	Set	Turn off	BE EF	03	06 00	2A D3	01 00	00 60	00 00
		Turn on	BE EF	03	06 00	BA D2	01 00	00 60	01 00
	Get		BE EF	03	06 00	19 D3	02 00	00 60	00 00
		[Example return]	00 00 [Off]	01 00 [On]	02 00 [Cool down]				
Input Source	Set	COMPUTER1	BE EF	03	06 00	FE D2	01 00	00 20	00 00
		COMPUTER2	BE EF	03	06 00	3E D0	01 00	00 20	04 00
		COMPONENT	BE EF	03	06 00	AE D1	01 00	00 20	05 00
		S-VIDEO	BE EF	03	06 00	9E D3	01 00	00 20	02 00
	VIDEO	BE EF	03	06 00	6E D3	01 00	00 20	01 00	
	Get	BE EF	03	06 00	CD D2	02 00	00 20	00 00	
Error Status	Get		BE EF	03	06 00	D9 D8	02 00	20 60	00 00
		[Example return]	00 00 [Normal]	01 00 [Cover error]	02 00 [Fan error]	03 00 [Lamp error]	04 00 [Temp error]	05 00 [Air flow error]	07 00 [Cold error]
MAGNIFY	Get	BE EF	03	06 00	7C D2	02 00	07 30	00 00	
	Increment	BE EF	03	06 00	1A D2	04 00	07 30	00 00	
	Decrement	BE EF	03	06 00	CB D3	05 00	07 30	00 00	
FREEZE	Set	NORMAL	BE EF	03	06 00	83 D2	01 00	02 30	00 00
		FREEZE	BE EF	03	06 00	13 D3	01 00	02 30	01 00
	Get	BE EF	03	06 00	B0 D2	02 00	02 30	00 00	
PICTURE MODE	Set	NORMAL	BE EF	03	06 00	23 F6	01 00	BA 30	00 00
		CINEMA	BE EF	03	06 00	B3 F7	01 00	BA 30	01 00
		DYNAMIC	BE EF	03	06 00	E3 F4	01 00	BA 30	04 00
		BOARD(BLACK)	BE EF	03	06 00	E3 EF	01 00	BA 30	20 00
		BOARD(GREEN)	BE EF	03	06 00	73 EE	01 00	BA 30	21 00
		WHITEBOARD	BE EF	03	06 00	83 EE	01 00	BA 30	22 00
	DAYTIME	BE EF	03	06 00	E3 C7	01 00	BA 30	40 00	
	Get	BE EF	03	06 00	10 F6	02 00	BA 30	00 00	
	[Example return]	00 00 [Normal]	01 00 [Cinema]	04 00 [Dynamic]	10 00 [Custom]	20 00 [BOARD(BLACK)]	21 00 [BOARD(GREEN)]	22 00 [WHITEBOARD]	40 00 [DAY TIME]
BRIGHTNESS	Get	BE EF	03	06 00	89 D2	02 00	03 20	00 00	
	Increment	BE EF	03	06 00	EF D2	04 00	03 20	00 00	
	Decrement	BE EF	03	06 00	3E D3	05 00	03 20	00 00	
BRIGHTNESS Reset	Execute	BE EF	03	06 00	58 D3	06 00	00 70	00 00	
CONTRAST	Get	BE EF	03	06 00	FD D3	02 00	04 20	00 00	
	Increment	BE EF	03	06 00	9B D3	04 00	04 20	00 00	
	Decrement	BE EF	03	06 00	4A D2	05 00	04 20	00 00	
CONTRAST Reset	Execute	BE EF	03	06 00	A4 D2	06 00	01 70	00 00	

(continued on next page)

**RS-232C Communication command table (continued)**

Names	Operation Type	Header					Command Data			
							CRC	Action	Type	Setting Code
GAMMA	Set	1 DEFAULT	BE EF	03	06 00	07 E9	01 00	A1 30	20 00	
		1 CUSTOM	BE EF	03	06 00	07 FD	01 00	A1 30	10 00	
		2 DEFAULT	BE EF	03	06 00	97 E8	01 00	A1 30	21 00	
		2 CUSTOM	BE EF	03	06 00	97 FC	01 00	A1 30	11 00	
		3 DEFAULT	BE EF	03	06 00	67 E8	01 00	A1 30	22 00	
		3 CUSTOM	BE EF	03	06 00	67 FC	01 00	A1 30	12 00	
		4 DEFAULT	BE EF	03	06 00	F7 E9	01 00	A1 30	23 00	
		4 CUSTOM	BE EF	03	06 00	F7 FD	01 00	A1 30	13 00	
		5 DEFAULT	BE EF	03	06 00	C7 EB	01 00	A1 30	24 00	
		5 CUSTOM	BE EF	03	06 00	C7 FF	01 00	A1 30	14 00	
		6 DEFAULT	BE EF	03	06 00	57 EA	01 00	A1 30	25 00	
		6 CUSTOM	BE EF	03	06 00	57 FE	01 00	A1 30	15 00	
	Get		BE EF	03	06 00	F4 F0	02 00	A1 30	00 00	
User Gamma Pattern	Set	Off	BE EF	03	06 00	FB FA	01 00	80 30	00 00	
		9 steps gray scale	BE EF	03	06 00	6B FB	01 00	80 30	01 00	
		15 steps gray scale	BE EF	03	06 00	9B FB	01 00	80 30	02 00	
		Ramp	BE EF	03	06 00	0B FA	01 00	80 30	03 00	
	Get		BE EF	03	06 00	C8 FA	02 00	80 30	00 00	
User Gamma Point 1	Get	BE EF	03	06 00	08 FE	02 00	90 30	00 00		
	Increment	BE EF	03	06 00	6E FE	04 00	90 30	00 00		
	Decrement	BE EF	03	06 00	BF FF	05 00	90 30	00 00		
User Gamma Point 1 Reset	Execute	BE EF	03	06 00	58 C2	06 00	50 70	00 00		
User Gamma Point 2	Get	BE EF	03	06 00	F4 FF	02 00	91 30	00 00		
	Increment	BE EF	03	06 00	92 FF	04 00	91 30	00 00		
	Decrement	BE EF	03	06 00	43 FE	05 00	91 30	00 00		
User Gamma Point 2 Reset	Execute	BE EF	03	06 00	A4 C3	06 00	51 70	00 00		
User Gamma Point 3	Get	BE EF	03	06 00	B0 FF	02 00	92 30	00 00		
	Increment	BE EF	03	06 00	D6 FF	04 00	92 30	00 00		
	Decrement	BE EF	03	06 00	07 FE	05 00	92 30	00 00		
User Gamma Point 3 Reset	Execute	BE EF	03	06 00	E0 C3	06 00	52 70	00 00		
User Gamma Point 4	Get	BE EF	03	06 00	4C FE	02 00	93 30	00 00		
	Increment	BE EF	03	06 00	2A FE	04 00	93 30	00 00		
	Decrement	BE EF	03	06 00	FB FF	05 00	93 30	00 00		
User Gamma Point 4 Reset	Execute	BE EF	03	06 00	1C C2	06 00	53 70	00 00		
User Gamma Point 5	Get	BE EF	03	06 00	38 FF	02 00	94 30	00 00		
	Increment	BE EF	03	06 00	5E FF	04 00	94 30	00 00		
	Decrement	BE EF	03	06 00	8F FE	05 00	94 30	00 00		
User Gamma Point 5 Reset	Execute	BE EF	03	06 00	68 C3	06 00	54 70	00 00		
User Gamma Point 6	Get	BE EF	03	06 00	C4 FE	02 00	95 30	00 00		
	Increment	BE EF	03	06 00	A2 FE	04 00	95 30	00 00		
	Decrement	BE EF	03	06 00	73 FF	05 00	95 30	00 00		
User Gamma Point 6 Reset	Execute	BE EF	03	06 00	94 C2	06 00	55 70	00 00		
User Gamma Point 7	Get	BE EF	03	06 00	80 FE	02 00	96 30	00 00		
	Increment	BE EF	03	06 00	E6 FE	04 00	96 30	00 00		
	Decrement	BE EF	03	06 00	37 FF	05 00	96 30	00 00		
User Gamma Point 7 Reset	Execute	BE EF	03	06 00	D0 C2	06 00	56 70	00 00		

(continued on next page)

**RS-232C Communication command table (continued)**

Names	Operation Type	Header			Command Data				
					CRC	Action	Type	Setting Code	
User Gamma Point 8	Get	BE EF	03	06 00	7C FF	02 00	97 30	00 00	
	Increment	BE EF	03	06 00	1A FF	04 00	97 30	00 00	
	Decrement	BE EF	03	06 00	CB FE	05 00	97 30	00 00	
User Gamma Point 8 Reset	Execute	BE EF	03	06 00	2C C3	06 00	57 70	00 00	
COLOR TEMP	Set	1 HIGH	BE EF	03	06 00	0B F5	01 00	B0 30	03 00
		1 CUSTOM	BE EF	03	06 00	CB F8	01 00	B0 30	13 00
		2 MID	BE EF	03	06 00	9B F4	01 00	B0 30	02 00
		2 CUSTOM	BE EF	03	06 00	5B F9	01 00	B0 30	12 00
		3 LOW	BE EF	03	06 00	6B F4	01 00	B0 30	01 00
		3 CUSTOM	BE EF	03	06 00	AB F9	01 00	B0 30	11 00
		4 HI-BRIGHT-1	BE EF	03	06 00	3B F2	01 00	B0 30	08 00
		4 CUSTOM	BE EF	03	06 00	FB FF	01 00	B0 30	18 00
		5 HI-BRIGHT-2	BE EF	03	06 00	AB F3	01 00	B0 30	09 00
		5 CUSTOM	BE EF	03	06 00	6B FE	01 00	B0 30	19 00
		6 HI-BRIGHT-3	BE EF	03	06 00	5B F3	01 00	B0 30	0A 00
6 CUSTOM	BE EF	03	06 00	9B FE	01 00	B0 30	1A 00		
COLOR TEMP GAIN R	Get	BE EF	03	06 00	34 F4	02 00	B1 30	00 00	
	Increment	BE EF	03	06 00	52 F4	04 00	B1 30	00 00	
	Decrement	BE EF	03	06 00	83 F5	05 00	B1 30	00 00	
COLOR TEMP GAIN R Reset	Execute	BE EF	03	06 00	10 C6	06 00	46 70	00 00	
COLOR TEMP GAIN G	Get	BE EF	03	06 00	70 F4	02 00	B2 30	00 00	
	Increment	BE EF	03	06 00	16 F4	04 00	B2 30	00 00	
	Decrement	BE EF	03	06 00	C7 F5	05 00	B2 30	00 00	
COLOR TEMP GAIN G Reset	Execute	BE EF	03	06 00	EC C7	06 00	47 70	00 00	
COLOR TEMP GAIN B	Get	BE EF	03	06 00	8C F5	02 00	B3 30	00 00	
	Increment	BE EF	03	06 00	EA F5	04 00	B3 30	00 00	
	Decrement	BE EF	03	06 00	3B F4	05 00	B3 30	00 00	
COLOR TEMP GAIN B Reset	Execute	BE EF	03	06 00	F8 C4	06 00	48 70	00 00	
COLOR TEMP OFFSET R	Get	BE EF	03	06 00	04 F5	02 00	B5 30	00 00	
	Increment	BE EF	03	06 00	62 F5	04 00	B5 30	00 00	
	Decrement	BE EF	03	06 00	B3 F4	05 00	B5 30	00 00	
COLOR TEMP OFFSET R Reset	Execute	BE EF	03	06 00	40 C5	06 00	4A 70	00 00	
COLOR TEMP OFFSET G	Get	BE EF	03	06 00	40 F5	02 00	B6 30	00 00	
	Increment	BE EF	03	06 00	26 F5	04 00	B6 30	00 00	
	Decrement	BE EF	03	06 00	F7 F4	05 00	B6 30	00 00	
COLOR TEMP OFFSET G Reset	Execute	BE EF	03	06 00	BC C4	06 00	4B 70	00 00	
COLOR TEMP OFFSET B	Get	BE EF	03	06 00	BC F4	02 00	B7 30	00 00	
	Increment	BE EF	03	06 00	DA F4	04 00	B7 30	00 00	
	Decrement	BE EF	03	06 00	0B F5	05 00	B7 30	00 00	
COLOR TEMP OFFSET B Reset	Execute	BE EF	03	06 00	C8 C5	06 00	4C 70	00 00	

(continued on next page)

**RS-232C Communication command table (continued)**

Names	Operation Type	Header				Command Data			
					CRC	Action	Type	Setting Code	
COLOR	Get	BE EF	03	06 00	B5 72	02 00	02 22	00 00	
	Increment	BE EF	03	06 00	D3 72	04 00	02 22	00 00	
	Decrement	BE EF	03	06 00	02 73	05 00	02 22	00 00	
COLOR Reset	Execute	BE EF	03	06 00	80 D0	06 00	0A 70	00 00	
TINT	Get	BE EF	03	06 00	49 73	02 00	03 22	00 00	
	Increment	BE EF	03	06 00	2F 73	04 00	03 22	00 00	
	Decrement	BE EF	03	06 00	FE 72	05 00	03 22	00 00	
TINT Reset	Execute	BE EF	03	06 00	7C D1	06 00	0B 70	00 00	
SHARPNESS	Get	BE EF	03	06 00	F1 72	02 00	01 22	00 00	
	Increment	BE EF	03	06 00	97 72	04 00	01 22	00 00	
	Decrement	BE EF	03	06 00	46 73	05 00	01 22	00 00	
SHARPNESS Reset	Execute	BE EF	03	06 00	C4 D0	06 00	09 70	00 00	
MY MEMORY Load	Set	1	BE EF	03	06 00	0E D7	01 00	14 20	00 00
		2	BE EF	03	06 00	9E D6	01 00	14 20	01 00
		3	BE EF	03	06 00	6E D6	01 00	14 20	02 00
		4	BE EF	03	06 00	FE D7	01 00	14 20	03 00
MY MEMORY Save	Set	1	BE EF	03	06 00	F2 D6	01 00	15 20	00 00
		2	BE EF	03	06 00	62 D7	01 00	15 20	01 00
		3	BE EF	03	06 00	92 D7	01 00	15 20	02 00
		4	BE EF	03	06 00	02 D6	01 00	15 20	03 00
ASPECT	Set	4:3	BE EF	03	06 00	9E D0	01 00	08 20	00 00
		16:9	BE EF	03	06 00	0E D1	01 00	08 20	01 00
		14:9	BE EF	03	06 00	CE D6	01 00	08 20	09 00
		16:10	BE EF	03	06 00	3E D6	01 00	08 20	0A 00
		NORMAL	BE EF	03	06 00	5E DD	01 00	08 20	10 00
	Get	BE EF	03	06 00	AD D0	02 00	08 20	00 00	
OVER SCAN	Get	BE EF	03	06 00	91 70	02 00	09 22	00 00	
	Increment	BE EF	03	06 00	F7 70	04 00	09 22	00 00	
	Decrement	BE EF	03	06 00	26 71	05 00	09 22	00 00	
OVER SCAN Reset	Execute	BE EF	03	06 00	EC D9	06 00	27 70	00 00	
V POSITION	Get	BE EF	03	06 00	0D 83	02 00	00 21	00 00	
	Increment	BE EF	03	06 00	6B 83	04 00	00 21	00 00	
	Decrement	BE EF	03	06 00	BA 82	05 00	00 21	00 00	
V POSITION Reset	Execute	BE EF	03	06 00	E0 D2	06 00	02 70	00 00	
H POSITION	Get	BE EF	03	06 00	F1 82	02 00	01 21	00 00	
	Increment	BE EF	03	06 00	97 82	04 00	01 21	00 00	
	Decrement	BE EF	03	06 00	46 83	05 00	01 21	00 00	
H POSITION Reset	Execute	BE EF	03	06 00	1C D3	06 00	03 70	00 00	
H PHASE	Get	BE EF	03	06 00	49 83	02 00	03 21	00 00	
	Increment	BE EF	03	06 00	2F 83	04 00	03 21	00 00	
	Decrement	BE EF	03	06 00	FE 82	05 00	03 21	00 00	

(continued on next page)

## RS-232C Communication command table (continued)

Names	Operation Type	Header				Command Data			
						CRC	Action	Type	Setting Code
H SIZE	Get	BE EF	03	06 00	B5 82	02 00	02 21	00 00	
	Increment	BE EF	03	06 00	D3 82	04 00	02 21	00 00	
	Decrement	BE EF	03	06 00	02 83	05 00	02 21	00 00	
H SIZE Reset	Execute	BE EF	03	06 00	68 D2	06 00	04 70	00 00	
AUTO ADJUST EXECUTE	Execute	BE EF	03	06 00	91 D0	06 00	0A 20	00 00	
PROGRESSIVE	Set	OFF	BE EF	03	06 00	4A 72	01 00	07 22	00 00
		TV	BE EF	03	06 00	DA 73	01 00	07 22	01 00
		FILM	BE EF	03	06 00	2A 73	01 00	07 22	02 00
	Get	BE EF	03	06 00	79 72	02 00	07 22	00 00	
VIDEO NR	Set	LOW	BE EF	03	06 00	26 72	01 00	06 22	01 00
		MID	BE EF	03	06 00	D6 72	01 00	06 22	02 00
		HIGH	BE EF	03	06 00	46 73	01 00	06 22	03 00
	Get	BE EF	03	06 00	85 73	02 00	06 22	00 00	
COLOR SPACE	Set	AUTO	BE EF	03	06 00	0E 72	01 00	04 22	00 00
		RGB	BE EF	03	06 00	9E 73	01 00	04 22	01 00
		SMPT240	BE EF	03	06 00	6E 73	01 00	04 22	02 00
		REC709	BE EF	03	06 00	FE 72	01 00	04 22	03 00
		REC601	BE EF	03	06 00	CE 70	01 00	04 22	04 00
	Get	BE EF	03	06 00	3D 72	02 00	04 22	00 00	
COMPONENT	Set	COMPONENT	BE EF	03	06 00	4A D7	01 00	17 20	00 00
		SCART RGB	BE EF	03	06 00	DA D6	01 00	17 20	01 00
	Get	BE EF	03	06 00	79 D7	02 00	17 20	00 00	
S-VIDEO FORMAT	Set	AUTO	BE EF	03	06 00	E6 70	01 00	12 22	0A 00
		NTSC	BE EF	03	06 00	86 74	01 00	12 22	04 00
		PAL	BE EF	03	06 00	16 75	01 00	12 22	05 00
		SECAM	BE EF	03	06 00	16 70	01 00	12 22	09 00
		NTSC4.43	BE EF	03	06 00	26 77	01 00	12 22	02 00
		M-PAL	BE EF	03	06 00	86 71	01 00	12 22	08 00
		N-PAL	BE EF	03	06 00	76 74	01 00	12 22	07 00
	Get	BE EF	03	06 00	75 76	02 00	12 22	00 00	
C-VIDEO FORMAT	Set	AUTO	BE EF	03	06 00	A2 70	01 00	11 22	0A 00
		NTSC	BE EF	03	06 00	C2 74	01 00	11 22	04 00
		PAL	BE EF	03	06 00	52 75	01 00	11 22	05 00
		SECAM	BE EF	03	06 00	52 70	01 00	11 22	09 00
		NTSC4.43	BE EF	03	06 00	62 77	01 00	11 22	02 00
		M-PAL	BE EF	03	06 00	C2 71	01 00	11 22	08 00
		N-PAL	BE EF	03	06 00	32 74	01 00	11 22	07 00
	Get	BE EF	03	06 00	31 76	02 00	11 22	00 00	
COMPUTER IN1	Set	AUTO	BE EF	03	06 00	CE D6	01 00	10 20	03 00
		SYNC ON G OFF	BE EF	03	06 00	5E D7	01 00	10 20	02 00
	Get	BE EF	03	06 00	0D D6	02 00	10 20	00 00	
COMPUTER IN2	Set	AUTO	BE EF	03	06 00	32 D7	01 00	11 20	03 00
		SYNC ON G OFF	BE EF	03	06 00	A2 D6	01 00	11 20	02 00
	Get	BE EF	03	06 00	F1 D7	02 00	11 20	00 00	

(continued on next page)



**RS-232C Communication command table (continued)**

Names	Operation Type	Header				Command Data			
					CRC	Action	Type	Setting Code	
FRAME LOCK – COMPUTER1	Set	OFF	BE EF	03	06 00	3B C2	01 00	50 30	00 00
		ON	BE EF	03	06 00	AB C3	01 00	50 30	01 00
	Get	BE EF	03	06 00	08 C2	02 00	50 30	00 00	
FRAME LOCK – COMPUTER2	Set	OFF	BE EF	03	06 00	0B C3	01 00	54 30	00 00
		ON	BE EF	03	06 00	9B C2	01 00	54 30	01 00
	Get	BE EF	03	06 00	38 C3	02 00	54 30	00 00	
AUTO KEYSTONE V EXECUTE	Execute	BE EF	03	06 00	E5 D1	06 00	0D 20	00 00	
KEYSTONE V	Get	BE EF	03	06 00	B9 D3	02 00	07 20	00 00	
	Increment	BE EF	03	06 00	DF D3	04 00	07 20	00 00	
	Decrement	BE EF	03	06 00	0E D2	05 00	07 20	00 00	
KEYSTONE V Reset	Execute	BE EF	03	06 00	08 D0	06 00	0C 70	00 00	
ECO MODE	Set	BRIGHT	BE EF	03	06 00	3B 23	01 00	00 33	00 00
		NORMAL	BE EF	03	06 00	AB 22	01 00	00 33	01 00
	Get	BE EF	03	06 00	08 23	02 00	00 33	00 00	
MIRROR	Set	NORMAL	BE EF	03	06 00	C7 D2	01 00	01 30	00 00
		H:INVERT	BE EF	03	06 00	57 D3	01 00	01 30	01 00
		V:INVERT	BE EF	03	06 00	A7 D3	01 00	01 30	02 00
		H&V:INVERT	BE EF	03	06 00	37 D2	01 00	01 30	03 00
	Get	BE EF	03	06 00	F4 D2	02 00	01 30	00 00	
STANDBY MODE	Set	NORMAL	BE EF	03	06 00	D6 D2	01 00	01 60	00 00
		SAVING	BE EF	03	06 00	46 D3	01 00	01 60	01 00
	Get	BE EF	03	06 00	E5 D2	02 00	01 60	00 00	
MONITOR OUT - COMPUTER1	Set	COMPUTER1	BE EF	03	06 00	3E F4	01 00	B0 20	00 00
		OFF	BE EF	03	06 00	CE B5	01 00	B0 20	FF 00
	Get	BE EF	03	06 00	0D F4	02 00	B0 20	00 00	
MONITOR OUT - COMPUTER2	Set	COMPUTER2	BE EF	03	06 00	CE F7	01 00	B4 20	04 00
		OFF	BE EF	03	06 00	FE B4	01 00	B4 20	FF 00
	Get	BE EF	03	06 00	3D F5	02 00	B4 20	00 00	
MONITOR OUT - COMPONENT	Set	COMPUTER1	BE EF	03	06 00	F2 F4	01 00	B5 20	00 00
		COMPUTER2	BE EF	03	06 00	32 F6	01 00	B5 20	04 00
		OFF	BE EF	03	06 00	02 B5	01 00	B5 20	FF 00
	Get	BE EF	03	06 00	C1 F4	02 00	B5 20	00 00	
MONITOR OUT - S-VIDEO	Set	COMPUTER1	BE EF	03	06 00	86 F5	01 00	B2 20	00 00
		COMPUTER2	BE EF	03	06 00	46 F7	01 00	B2 20	04 00
		OFF	BE EF	03	06 00	76 B4	01 00	B2 20	FF 00
	Get	BE EF	03	06 00	B5 F5	02 00	B2 20	00 00	
MONITOR OUT - VIDEO	Set	COMPUTER1	BE EF	03	06 00	C2 F5	01 00	B1 20	00 00
		COMPUTER2	BE EF	03	06 00	02 F7	01 00	B1 20	04 00
		OFF	BE EF	03	06 00	32 B4	01 00	B1 20	FF 00
	Get	BE EF	03	06 00	F1 F5	02 00	B1 20	00 00	
MONITOR OUT - STANDBY	Set	COMPUTER1	BE EF	03	06 00	2A F7	01 00	BF 20	00 00
		COMPUTER2	BE EF	03	06 00	EA F5	01 00	BF 20	04 00
		OFF	BE EF	03	06 00	DA B6	01 00	BF 20	FF 00
	Get	BE EF	03	06 00	19 F7	02 00	BF 20	00 00	
VOLUME - COMPUTER1	Get	BE EF	03	06 00	CD CC	02 00	60 20	00 00	
	Increment	BE EF	03	06 00	AB CC	04 00	60 20	00 00	
	Decrement	BE EF	03	06 00	7A CD	05 00	60 20	00 00	

(continued on next page)

**RS-232C Communication command table (continued)**

Names	Operation Type	Header				Command Data			
						CRC	Action	Type	Setting Code
VOLUME - COMPUTER2	Get	BE EF	03	06 00	FD CD	02 00	64 20	00 00	
	Increment	BE EF	03	06 00	9B CD	04 00	64 20	00 00	
	Decrement	BE EF	03	06 00	4A CC	05 00	64 20	00 00	
VOLUME - COMPONENT	Get	BE EF	03	06 00	01 CC	02 00	65 20	00 00	
	Increment	BE EF	03	06 00	67 CC	04 00	65 20	00 00	
	Decrement	BE EF	03	06 00	B6 CD	05 00	65 20	00 00	
VOLUME - S-VIDEO	Get	BE EF	03	06 00	75 CD	02 00	62 20	00 00	
	Increment	BE EF	03	06 00	13 CD	04 00	62 20	00 00	
	Decrement	BE EF	03	06 00	C2 CC	05 00	62 20	00 00	
VOLUME - VIDEO	Get	BE EF	03	06 00	31 CD	02 00	61 20	00 00	
	Increment	BE EF	03	06 00	57 CD	04 00	61 20	00 00	
	Decrement	BE EF	03	06 00	86 CC	05 00	61 20	00 00	
VOLUME - AUDIO OUT STANDBY	Get	BE EF	03	06 00	D9 CF	02 00	6F 20	00 00	
	Increment	BE EF	03	06 00	BF CF	04 00	6F 20	00 00	
	Decrement	BE EF	03	06 00	6E CE	05 00	6F 20	00 00	
MUTE	Set	OFF	BE EF	03	06 00	46 D3	01 00	02 20	00 00
		ON	BE EF	03	06 00	D6 D2	01 00	02 20	01 00
	Get	BE EF	03	06 00	75 D3	02 00	02 20	00 00	
SPEAKER	Set	ON	BE EF	03	06 00	FE D4	01 00	1C 20	01 00
		OFF	BE EF	03	06 00	6E D5	01 00	1C 20	00 00
	Get	BE EF	03	06 00	5D D5	02 00	1C 20	00 00	
AUDIO SOURCE - COMPUTER1	Set	AUDIO IN1	BE EF	03	06 00	6D DC	01 00	30 20	01 00
		AUDIO IN2	BE EF	03	06 00	9E DC	01 00	30 20	02 00
		AUDIO IN3	BE EF	03	06 00	0E DD	01 00	30 20	03 00
		OFF	BE EF	03	06 00	FE DD	01 00	30 20	00 00
	Get	BE EF	03	06 00	CD DD	02 00	30 20	00 00	
AUDIO SOURCE - COMPUTER2	Set	AUDIO IN1	BE EF	03	06 00	5E DD	01 00	34 20	01 00
		AUDIO IN2	BE EF	03	06 00	AE DD	01 00	34 20	02 00
		AUDIO IN3	BE EF	03	06 00	3E DC	01 00	34 20	03 00
		OFF	BE EF	03	06 00	CE DC	01 00	34 20	00 00
	Get	BE EF	03	06 00	FD DC	02 00	34 20	00 00	
AUDIO SOURCE - COMPONENT	Set	AUDIO IN1	BE EF	03	06 00	A2 DC	01 00	35 20	01 00
		AUDIO IN2	BE EF	03	06 00	52 DC	01 00	35 20	02 00
		AUDIO IN3	BE EF	03	06 00	C2 DD	01 00	35 20	03 00
		OFF	BE EF	03	06 00	32 DD	01 00	35 20	00 00
	Get	BE EF	03	06 00	01 DD	02 00	35 20	00 00	
AUDIO SOURCE - S-VIDEO	Set	AUDIO IN1	BE EF	03	06 00	D6 DD	01 00	32 20	01 00
		AUDIO IN2	BE EF	03	06 00	26 DD	01 00	32 20	02 00
		AUDIO IN3	BE EF	03	06 00	B6 DC	01 00	32 20	03 00
		OFF	BE EF	03	06 00	46 DC	01 00	32 20	00 00
	Get	BE EF	03	06 00	75 DC	02 00	32 20	00 00	
AUDIO SOURCE - VIDEO	Set	AUDIO IN1	BE EF	03	06 00	92 DD	01 00	31 20	01 00
		AUDIO IN2	BE EF	03	06 00	62 DD	01 00	31 20	02 00
		AUDIO IN3	BE EF	03	06 00	F2 DC	01 00	31 20	03 00
		OFF	BE EF	03	06 00	02 DC	01 00	31 20	00 00
	Get	BE EF	03	06 00	31 DC	02 00	31 20	00 00	

(continued on next page)

RS-232C Communication command table (continued)

Names	Operation Type	Header				Command Data			
						CRC	Action	Type	Setting Code
AUDIO OUT STANDBY	Set	AUDIO IN1	BE EF	03	06 00	7A DF	01 00	3F 20	01 00
		AUDIO IN2	BE EF	03	06 00	8A DF	01 00	3F 20	02 00
		AUDIO IN3	BE EF	03	06 00	1A DE	01 00	3F 20	03 00
		OFF	BE EF	03	06 00	EA DE	01 00	3F 20	00 00
	Get	BE EF	03	06 00	D9 DE	02 00	3F 20	00 00	
LANGUAGE *	Set	ENGLISH	BE EF	03	06 00	F7 D3	01 00	05 30	00 00
		FRANÇAIS	BE EF	03	06 00	67 D2	01 00	05 30	01 00
		DEUTSCH	BE EF	03	06 00	97 D2	01 00	05 30	02 00
		ESPAÑOL	BE EF	03	06 00	07 D3	01 00	05 30	03 00
		ITALIANO	BE EF	03	06 00	37 D1	01 00	05 30	04 00
		NORSK	BE EF	03	06 00	A7 D0	01 00	05 30	05 00
		NEDERLANDS	BE EF	03	06 00	57 D0	01 00	05 30	06 00
		PORTUGUÊS	BE EF	03	06 00	C7 D1	01 00	05 30	07 00
		日本語	BE EF	03	06 00	37 D4	01 00	05 30	08 00
		简体中文	BE EF	03	06 00	A7 D5	01 00	05 30	09 00
		繁體中文	BE EF	03	06 00	37 DE	01 00	05 30	10 00
		한글	BE EF	03	06 00	57 D5	01 00	05 30	0A 00
		SVENSKA	BE EF	03	06 00	C7 D4	01 00	05 30	0B 00
		РУССКИЙ	BE EF	03	06 00	F7 D6	01 00	05 30	0C 00
		SUOMI	BE EF	03	06 00	67 D7	01 00	05 30	0D 00
		POLSKI	BE EF	03	06 00	97 D7	01 00	05 30	0E 00
		TÜRKÇE	BE EF	03	06 00	07 D6	01 00	05 30	0F 00
		DANSK	BE EF	03	06 00	A7 DF	01 00	05 30	11 00
		ČESKY	BE EF	03	06 00	57 DF	01 00	05 30	12 00
		MAGYAR	BE EF	03	06 00	C7 DE	01 00	05 30	13 00
		ROMÂNĂ	BE EF	03	06 00	F7 DC	01 00	05 30	14 00
		SLOVENSKI	BE EF	03	06 00	67 DD	01 00	05 30	15 00
		HRVATSKI	BE EF	03	06 00	97 DD	01 00	05 30	16 00
		ΕΛΛΗΝΙΚΑ	BE EF	03	06 00	07 DC	01 00	05 30	17 00
		LIETUVIŲ	BE EF	03	06 00	F7 D9	01 00	05 30	18 00
		EESTI	BE EF	03	06 00	67 D8	01 00	05 30	19 00
		LATVIEŠU	BE EF	03	06 00	97 D8	01 00	05 30	1A 00
		ไทย	BE EF	03	06 00	07 D9	01 00	05 30	1B 00
		كبرعلا ةغلللا	BE EF	03	06 00	37 DB	01 00	05 30	1C 00
کسراف	BE EF	03	06 00	A7 DA	01 00	05 30	1D 00		
PORTUGUÊS BRA	BE EF	03	06 00	57 DA	01 00	05 30	1E 00		
	Get	BE EF	03	06 00	C4 D3	02 00	05 30	00 00	
MENU POSITION H	Get	BE EF	03	06 00	04 D7	02 00	15 30	00 00	
	Increment	BE EF	03	06 00	62 D7	04 00	15 30	00 00	
	Decrement	BE EF	03	06 00	B3 D6	05 00	15 30	00 00	
MENU POSITION H Reset	Execute	BE EF	03	06 00	DC C6	06 00	43 70	00 00	
MENU POSITION V	Get	BE EF	03	06 00	40 D7	02 00	16 30	00 00	
	Increment	BE EF	03	06 00	26 D7	04 00	16 30	00 00	
	Decrement	BE EF	03	06 00	F7 D6	05 00	16 30	00 00	
MENU POSITION V Reset	Execute	BE EF	03	06 00	A8 C7	06 00	44 70	00 00	

\* Not all of the languages in the table are supported.

(continued on next page)

## RS-232C Communication command table (continued)

Names	Operation Type	Header				Command Data			
						CRC	Action	Type	Setting Code
BLANK	Set	MyScreen	BE EF	03	06 00	FB CA	01 00	00 30	20 00
		ORIGINAL	BE EF	03	06 00	FB E2	01 00	00 30	40 00
		BLUE	BE EF	03	06 00	CB D3	01 00	00 30	03 00
		WHITE	BE EF	03	06 00	6B D0	01 00	00 30	05 00
	BLACK	BE EF	03	06 00	9B D0	01 00	00 30	06 00	
	Get		BE EF	03	06 00	08 D3	02 00	00 30	00 00
BLANK On/Off	Set	OFF	BE EF	03	06 00	FB D8	01 00	20 30	00 00
		ON	BE EF	03	06 00	6B D9	01 00	20 30	01 00
	Get		BE EF	03	06 00	C8 D8	02 00	20 30	00 00
START UP	Set	MyScreen	BE EF	03	06 00	CB CB	01 00	04 30	20 00
		ORIGINAL	BE EF	03	06 00	0B D2	01 00	04 30	00 00
		OFF	BE EF	03	06 00	9B D3	01 00	04 30	01 00
	Get		BE EF	03	06 00	38 D2	02 00	04 30	00 00
MyScreen Lock	Set	OFF	BE EF	03	06 00	3B EF	01 00	C0 30	00 00
		ON	BE EF	03	06 00	AB EE	01 00	C0 30	01 00
	Get		BE EF	03	06 00	08 EF	02 00	C0 30	00 00
MESSAGE	Set	OFF	BE EF	03	06 00	8F D6	01 00	17 30	00 00
		ON	BE EF	03	06 00	1F D7	01 00	17 30	01 00
	Get		BE EF	03	06 00	BC D6	02 00	17 30	00 00
TEMPLATE	Set	TEST PATTERN	BE EF	03	06 00	43 D9	01 00	22 30	00 00
		DOT-LINE1	BE EF	03	06 00	D3 D8	01 00	22 30	01 00
		DOT-LINE2	BE EF	03	06 00	23 D8	01 00	22 30	02 00
		DOT-LINE3	BE EF	03	06 00	B3 D9	01 00	22 30	03 00
	DOT-LINE4	BE EF	03	06 00	83 DB	01 00	22 30	04 00	
Get		BE EF	03	06 00	70 D9	02 00	22 30	00 00	
TEMPLATE On/Off	Set	OFF	BE EF	03	06 00	BF D8	01 00	23 30	00 00
		ON	BE EF	03	06 00	2F D9	01 00	23 30	01 00
	Get		BE EF	03	06 00	8C D8	02 00	23 30	00 00
C. C. - DISPLAY	Set	OFF	BE EF	03	06 00	FA 62	01 00	00 37	00 00
		ON	BE EF	03	06 00	6A 63	01 00	00 37	01 00
		AUTO	BE EF	03	06 00	9A 63	01 00	00 37	02 00
	Get		BE EF	03	06 00	C9 62	02 00	00 37	00 00
C. C. - MODE	Set	CAPTIONS	BE EF	03	06 00	06 63	01 00	01 37	00 00
		TEXT	BE EF	03	06 00	96 62	01 00	01 37	01 00
	Get		BE EF	03	06 00	35 63	02 00	01 37	00 00
C. C. - CHANNEL	Set	1	BE EF	03	06 00	D2 62	01 00	02 37	01 00
		2	BE EF	03	06 00	22 62	01 00	02 37	02 00
		3	BE EF	03	06 00	B2 63	01 00	02 37	03 00
		4	BE EF	03	06 00	82 61	01 00	02 37	04 00
	Get		BE EF	03	06 00	71 63	02 00	02 37	00 00
AUTO SEARCH	Set	OFF	BE EF	03	06 00	B6 D6	01 00	16 20	00 00
		ON	BE EF	03	06 00	26 D7	01 00	16 20	01 00
	Get		BE EF	03	06 00	85 D6	02 00	16 20	00 00
AUTO KEYSTONE	Set	OFF	BE EF	03	06 00	EA D1	01 00	0F 20	00 00
		ON	BE EF	03	06 00	7A D0	01 00	0F 20	01 00
	Get		BE EF	03	06 00	D9 D1	02 00	0F 20	00 00
DIRECT ON	Set	OFF	BE EF	03	06 00	3B 89	01 00	20 31	00 00
		ON	BE EF	03	06 00	AB 88	01 00	20 31	01 00
	Get		BE EF	03	06 00	08 89	02 00	20 31	00 00

(continued on next page)

**RS-232C Communication command table (continued)**

Names	Operation Type	Header				Command Data			
					CRC	Action	Type	Setting Code	
AUTO OFF	Get	BE EF	03	06 00	08 86	02 00	10 31	00 00	
	Increment	BE EF	03	06 00	6E 86	04 00	10 31	00 00	
	Decrement	BE EF	03	06 00	BF 87	05 00	10 31	00 00	
LAMP TIME	Get	BE EF	03	06 00	C2 FF	02 00	90 10	00 00	
LAMP TIME Reset	Execute	BE EF	03	06 00	58 DC	06 00	30 70	00 00	
FILTER TIME	Get	BE EF	03	06 00	C2 F0	02 00	A0 10	00 00	
FILTER TIME Reset	Execute	BE EF	03	06 00	98 C6	06 00	40 70	00 00	
MY BUTTON-1	Set	COMPUTER IN1	BE EF	03	06 00	3A 33	01 00	00 36	00 00
		COMPUTER IN2	BE EF	03	06 00	FA 31	01 00	00 36	04 00
		COMPONENT	BE EF	03	06 00	6A 30	01 00	00 36	05 00
		S-VIDEO	BE EF	03	06 00	5A 32	01 00	00 36	02 00
		VIDEO	BE EF	03	06 00	AA 32	01 00	00 36	01 00
		INFORMATION	BE EF	03	06 00	FA 3E	01 00	00 36	10 00
		AUTO KEYSTONE V	BE EF	03	06 00	6A 3F	01 00	00 36	11 00
		MY MEMORY	BE EF	03	06 00	9A 3F	01 00	00 36	12 00
		PICTURE MODE	BE EF	03	06 00	0A 3E	01 00	00 36	13 00
		FILTER RESET	BE EF	03	06 00	3A 3C	01 00	00 36	14 00
		AV MUTE	BE EF	03	06 00	AA 38	01 00	00 36	19 00
	TEMPLATE	BE EF	03	06 00	CA 39	01 00	00 36	1B 00	
	Get	BE EF	03	06 00	09 33	02 00	00 36	00 00	
MY BUTTON-2	Set	COMPUTER IN1	BE EF	03	06 00	C6 32	01 00	01 36	00 00
		COMPUTER IN2	BE EF	03	06 00	06 30	01 00	01 36	04 00
		COMPONENT	BE EF	03	06 00	96 31	01 00	01 36	05 00
		S-VIDEO	BE EF	03	06 00	A6 33	01 00	01 36	02 00
		VIDEO	BE EF	03	06 00	56 33	01 00	01 36	01 00
		INFORMATION	BE EF	03	06 00	06 3F	01 00	01 36	10 00
		AUTO KEYSTONE V	BE EF	03	06 00	96 3E	01 00	01 36	11 00
		MY MEMORY	BE EF	03	06 00	66 3E	01 00	01 36	12 00
		PICTURE MODE	BE EF	03	06 00	F6 3F	01 00	01 36	13 00
		FILTER RESET	BE EF	03	06 00	C6 3D	01 00	01 36	14 00
		AV MUTE	BE EF	03	06 00	56 39	01 00	01 36	19 00
	TEMPLATE	BE EF	03	06 00	36 38	01 00	01 36	1B 00	
	Get	BE EF	03	06 00	F5 32	02 00	01 36	00 00	
MY SOURCE	Set	COMPUTER1	BE EF	03	06 00	FA 38	01 00	20 36	00 00
		COMPUTER2	BE EF	03	06 00	3A 3A	01 00	20 36	04 00
		COMPONENT	BE EF	03	06 00	AA 3B	01 00	20 36	05 00
		S-VIDEO	BE EF	03	06 00	9A 39	01 00	20 36	02 00
	VIDEO	BE EF	03	06 00	6A 39	01 00	20 36	01 00	
	Get	BE EF	03	06 00	C9 38	02 00	20 36	00 00	
REMOTE FREQ. NORMAL	Set	OFF	BE EF	03	06 00	FF 3D	01 00	30 26	00 00
		ON	BE EF	03	06 00	6F 3C	01 00	30 26	01 00
	Get	BE EF	03	06 00	CC 3D	02 00	30 26	00 00	
REMOTE FREQ. HIGH	Set	OFF	BE EF	03	06 00	03 3C	01 00	31 26	00 00
		ON	BE EF	03	06 00	93 3D	01 00	31 26	01 00
	Get	BE EF	03	06 00	30 3C	02 00	31 26	00 00	

# HITACHI

## Inspire the Next

### Hitachi Home Electronics (America), Inc.,

Business Group  
900 Hitachi way, Chula Vista  
CA 91914-3556 **USA**  
Tel: +1 -800-225-1741  
Fax: +1 -619-591-5418

► <http://www.hitachi.us/digitalmedia>

### Hitachi Home Electronics (Canada), Inc.,

2495 Meadowspine Blvd. Mississauga,  
Ontario L5N6C3 **CANADA**  
Tel: +1 -905-821-4545  
Fax: +1 -905-821-1101

► <http://www.hitachi.ca>

### Hitachi Europe

Bergensesteenweg 421  
1600 Sint-Pieters-Leeuw **BELGIUM**  
Tel: +32 -236-39901  
Fax: +32-236-39900

### Hitachi Europe Ltd. Digital Media Group

Kodanska 46  
101 00 Praha 10 **CZECH REPUBLIC**  
Tel: 00420 234 064 514  
Fax: 00420 234 064 513

### Hitachi Europe AB

Egebaekgaard, Egebaekvej 98  
2850 Naerum **DENMARK**  
Tel: 00420 234 064 514  
Fax: 00420 234 064 513

### Hitachi Europe AB.

Lars Sonckin kaari 16  
FIN-026000 ESPOO **FINLAND**  
Tel: +358 10 8503085  
Fax: +358 10 8503086

### Hitachi Europe S.A.S. Digital Media Group

Cité Internationale  
94 Quai Charles de Gaulles  
69006 Lyon **FRANCE**  
Tel: +33 4 72 14 29 70  
Fax: +33 4 72 14 29 99

### Hitachi Europe GmbH (Munich Office)

Dornacher Strasser 3.  
85622 Feldkirchen bei Muenchen **GERMANY**  
Tel: +49 -89-991-80-0 **SWITZERLAND**  
Fax: +49 -89-991-80-224

### Hitachi Europe S.A.

364 Kifissias & 1 Delfon Str.  
152 33 Chalandri **GREECE**  
Tel: +30 -1-6837200  
Fax: +30 -1-6835694

### Hitachi Europe S.r.l.

Via T. Gulli, 39  
20147 Milano **ITALY**  
Tel: +39 -02-487861  
Fax: +39 -02-48786381

### Hitachi Europe AB.

Atlas Spedisjon C/O Hitachi Europe AB  
Smalvollveien 52 N-0667 Oslo **NORWAY**  
Tel: +44 1628 585000  
Fax: +47 3 339 390 0

### Hitachi Europe Ltd. Digital Media Group

Al.Jana Pawla II 12  
00-124 Warsaw **POLAND**  
Tel: +44 1628 585000  
Fax: +48 22 850 9909

### Hitachi Home Electronics Russia

23/2 Trubnaya ul.  
4th Floor Moscow  
Russian Federation  
127051 **RUSSIA**  
Tel: +7 -495-787-40-20  
Fax: +7 -495-787-40-21

### Hitachi Europe S.A.

Gran Via Carlos III, 86 planta 5ª  
Edificios Trade - Torre Este  
08028 Barcelona **SPAIN**  
Tel: +34 -93-409-2550  
Fax: +34 -93-491-3513

### Hitachi Europe AB.

Haukadalsgatan 10  
S-164 94 Kista **SWEDEN**  
Tel: +46 -8-562-711-00  
Fax: +46 -8-562-711-11

### Hitachi Home & Life Solutions, Inc.

#### Middle East Office

LOB 14-136,  
PO BOX 18008  
Jebel Ali Free Zone,  
Dubai - **U.A.E.**  
Tel: +30 -1-6837200  
Fax: +30 -1-6835694

### Hitachi Europe Ltd.

Whitebrook Park, Lower Cookham Road  
Maidenhead Berkshire, SL6 8YA **UK**  
Tel: 0844 4810297

► <http://www.hitachidigitalmedia.com>