

Dell™ M409WX Projector

# User's Guide

# Notes, Notices, and Cautions



**NOTE:** A NOTE indicates important information that helps you make better use of your projector.



**NOTICE:** A NOTICE indicates either potential damage to hardware or loss of data and tells you how to avoid the problem.



**CAUTION:** A CAUTION indicates a potential for property damage, personal injury, or death.

---

**Information in this document is subject to change without notice.**

**© 2008 Dell Inc. All rights reserved.**

Reproduction in any manner whatsoever without the written permission of Dell Inc. is strictly forbidden.

Trademarks used in this text: *Dell* and the *DELL* logo are trademarks of Dell Inc.; *DLP* and *DLP*<sup>®</sup> logo are trademarks of Texas Instruments; *Microsoft* and *Windows* are either registered trademarks or trademarks of Microsoft Corporation in the United States and/or other countries.

Other trademarks and trade names may be used in this document to refer to either the entities claiming the marks and names or their products. Dell Inc. disclaims any proprietary interest in trademarks and trade names other than its own.

Model M409WX

May 2008 Rev. A01

# Contents

1	About Your Projector . . . . .	5
	About Your Projector . . . . .	6
2	Connecting Your Projector . . . . .	7
	<b>Connecting a Computer</b> . . . . .	8
	<b>Connecting a DVD Player</b> . . . . .	9
	Connecting a DVD Player using an S-video Cable . . . . .	9
	Connecting a DVD Player using a Composite Cable . . . . .	10
	Connecting a DVD Player using a Component Cable . . . . .	11
	Connecting a DVD Player using an HDMI Cable . . . . .	12
3	Using Your Projector . . . . .	13
	<b>Turning Your Projector On</b> . . . . .	13
	<b>Turning Your Projector Off</b> . . . . .	13
	<b>Adjusting the Projected Image</b> . . . . .	14
	Raising the Projector Height . . . . .	14
	Lowering the Projector Height . . . . .	14
	<b>Adjusting the Projector Zoom and Focus</b> . . . . .	15
	<b>Adjusting Projection Image Size</b> . . . . .	16

	<b>Using the Control Panel</b> . . . . .	<b>17</b>
	<b>Using the Remote Control</b> . . . . .	<b>19</b>
	<b>Using the On-Screen Display</b> . . . . .	<b>21</b>
	Main Menu . . . . .	21
	Input Select . . . . .	21
	Auto-Adjust . . . . .	22
	Set Up . . . . .	22
	PICTURE (in PC Mode) . . . . .	23
	PICTURE (in Video Mode) . . . . .	23
	DISPLAY (in PC Mode) . . . . .	24
	DISPLAY (in Video Mode) . . . . .	25
	LAMP . . . . .	26
	OTHERS . . . . .	27
<b>4</b>	<b>Troubleshooting Your Projector</b> . . . . .	<b>31</b>
	<b>Guiding Signals</b> . . . . .	<b>34</b>
	<b>Changing the Lamp</b> . . . . .	<b>35</b>
<b>5</b>	<b>Specifications</b> . . . . .	<b>37</b>
	<b>Contacting Dell</b> . . . . .	<b>40</b>
<b>6</b>	<b>Appendix: Glossary</b> . . . . .	<b>41</b>

# About Your Projector

Before connecting your projector ensure that all the necessary components are available. Your projector ships with the components shown below. Contact Dell (see Contacting Dell on page 40) if any of the components are missing.

Your Dell™ M409WX projector ships with the following components:

---

## Package Contents

---

Power cable

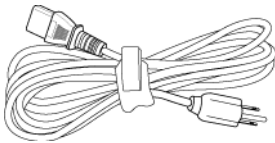

1.8m VGA cable (VGA to VGA)

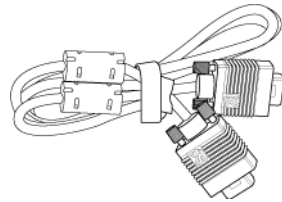

AAA Batteries (2)

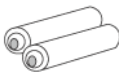

Remote control



CD User's Guide & Documentation

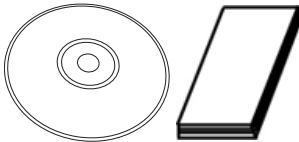

Carrying case



## About Your Projector

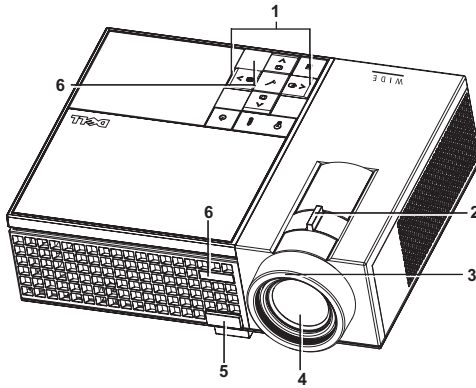

1	Control panel
2	Zoom tab
3	Focus ring
4	Lens
5	Elevator button
6	IR receiver

### **CAUTION: Safety Instructions**

- 1 Do not use the projector near appliances that generate a lot of heat.
- 2 Do not use the projector in areas where there is an excessive amount of dust. The dust may cause the system to fail and projector will automatically shutdown.
- 3 Ensure that the projector is mounted in a well-ventilated area.
- 4 Do not block the ventilation slots and openings on the projector.
- 5 Ensure the projector operates between ambient temperatures (5°C to 35°C).

 **NOTE:** For more information, see the safety information that shipped with your projector.

# 2

## Connecting Your Projector

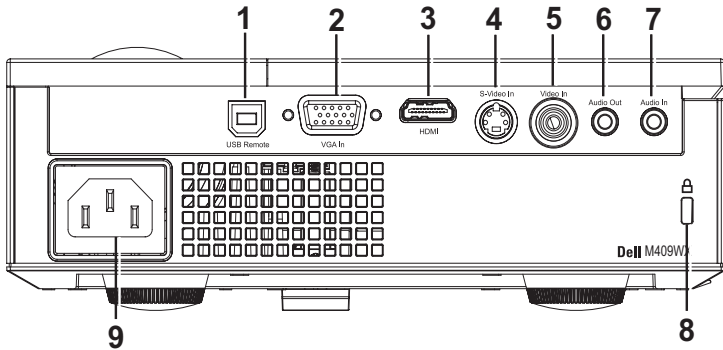

1	USB remote connector
2	VGA input connector
3	HDMI input connector
4	S-video input connector
5	Video input connector
6	Audio output connector
7	Audio input connector
8	Security cable slot
9	Power cable connector

**!** **CAUTION:** Before you begin any of the procedures in this section, follow the Safety Instructions as described on page 6.

# Connecting a Computer

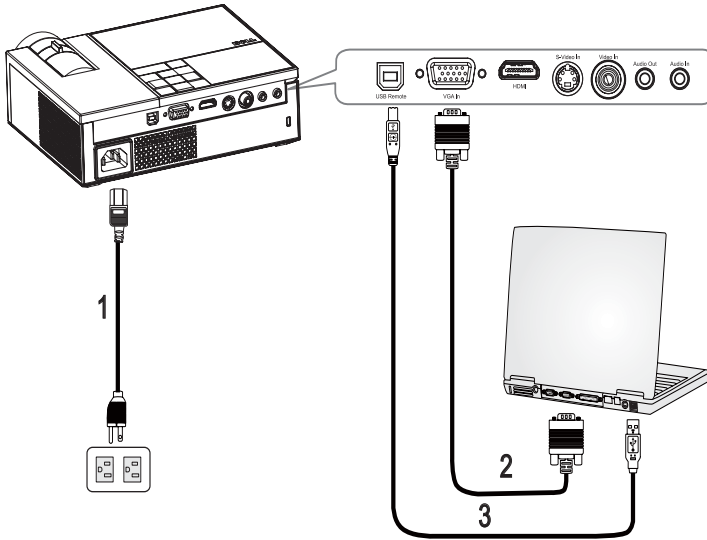

1	Power cable
2	VGA to VGA cable
3	USB to USB cable

**NOTE:** The USB cable is not provided by Dell.



# Connecting a DVD Player

## Connecting a DVD Player using an S-video Cable

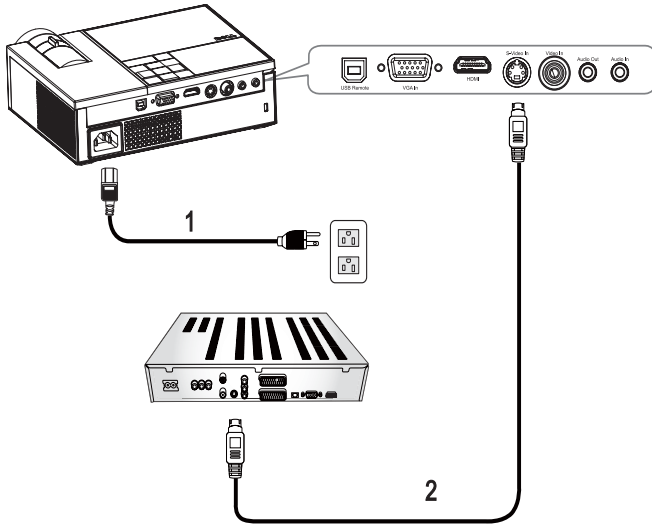

1	Power cable
2	S-video cable

 **NOTE:** The S-Video cable is not provided by Dell.

## Connecting a DVD Player using a Composite Cable

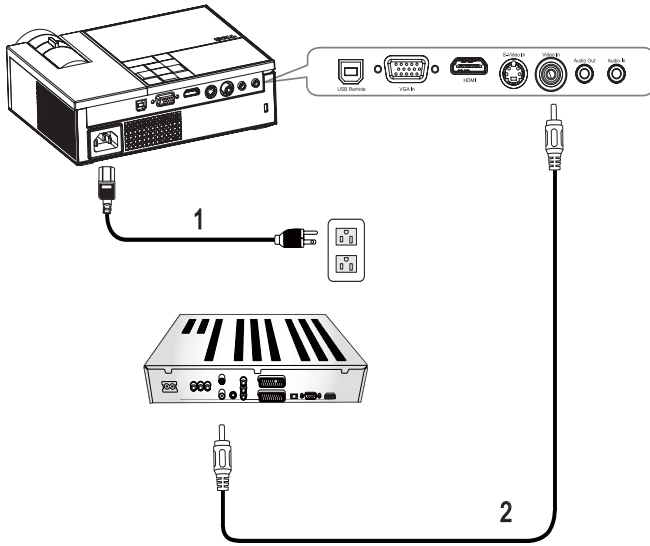

1	Power cable
2	Composite video cable

**NOTE:** The Composite video cable is not provided by Dell.

## Connecting a DVD Player using a Component Cable

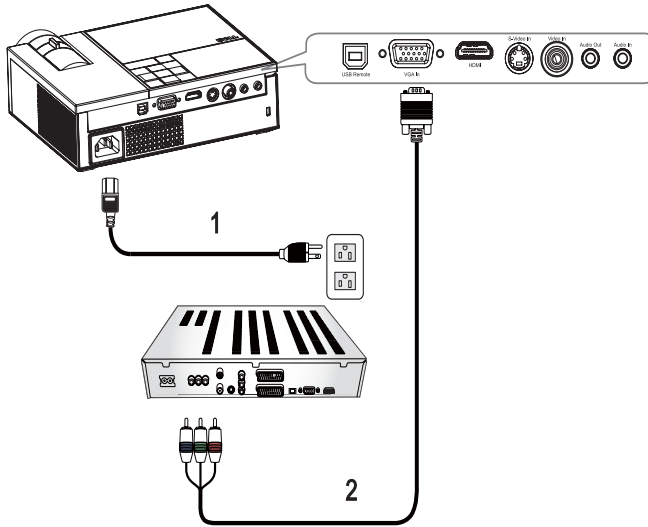

1	Power cable
2	D-sub to YPbPr cable



**NOTE:** The D-sub to YPbPr cable is not provided by Dell.

## Connecting a DVD Player using an HDMI Cable

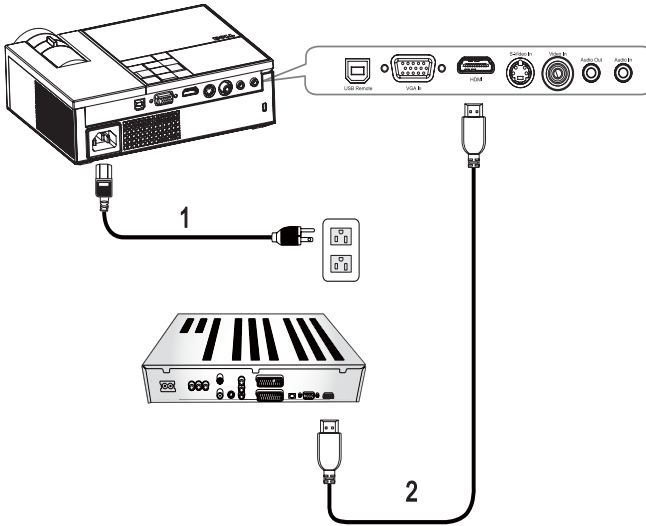



1	Power cable
2	HDMI cable

 **NOTE:** The HDMI cable is not provided by Dell.

# Using Your Projector

## Turning Your Projector On

 **NOTE:** Turn on the projector before you turn on the source. The Power light blinks blue until the **Power** button  is pressed.



- 1 Remove the lens cap.
- 2 Connect the power cable and appropriate signal cables. For information about connecting the projector, see *Connecting Your Projector* on page 7.
- 3 Press the projector **Power** button  (see *Using the Control Panel* on page 17).
- 4 Turn on your source (computer, DVD player, etc.). The projector automatically detects your source. If you have multiple sources connected to the projector, press the **Source** button on the remote control or control panel to select the desired source.
- 5 The projector displays the Dell logo, if it does not detect a signal.

If the "**Searching for signal...**" message appears on the screen, ensure that the appropriate cables are securely connected.

## Turning Your Projector Off

 **NOTICE:** You must turn off the projector before you disconnect the power cable from the projector.

To turn the projector off:

- 1 Press the **Power** button .
- 2 Press the **Power** button  again to turn off the projector.  
The projectors cooling fans are on for 90 seconds before the projector switches off completely.
- 3 To quickly turn off the projector, press the **Power** button  while the projectors cooling fans are still running.

 **NOTE:** Wait for 60 seconds before you turn the projector on again.

- 4 Disconnect the power cable from the electrical outlet and the projector.

**NOTE:** If you press the **Power** button  while the projector is running, the "Press Power Button To Turn Off Projector" message appears on the screen. To clear the message, press a button on the control panel. The message disappears after 5 seconds.

## Adjusting the Projected Image

### Raising the Projector Height

- 1 Press the **Elevator** button.
- 2 Raise the projector to the desired display angle, and then release the button to lock the elevator foot into position.
- 3 Use the tilt adjustment wheel to fine-tune the display angle.

### Lowering the Projector Height

- 1 Press the **Elevator** button.
- 2 Lower the projector, and then release the button to lock the elevator foot into position.

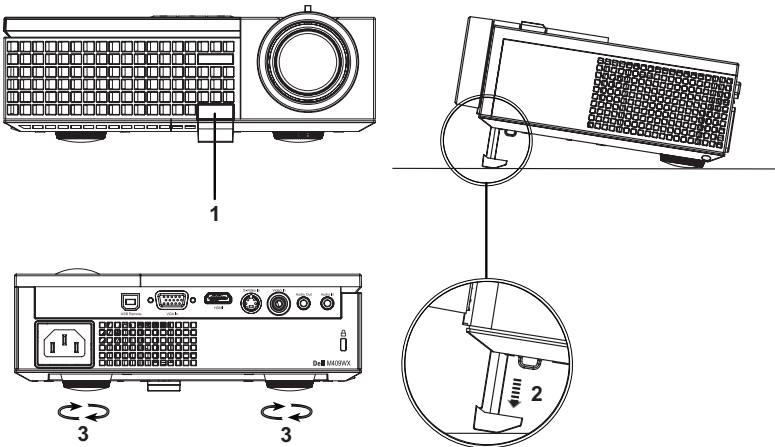

1	Elevator button
2	Elevator foot
3	Tilt adjustment wheel

# Adjusting the Projector Zoom and Focus



**CAUTION:** To avoid damaging the projector, ensure that the zoom lens and elevator foot are fully retracted before moving the projector or placing the projector in its carrying case.

- 1 Rotate the zoom tab to zoom in and out.
- 2 Rotate the focus ring until the image is clear. The projector focuses at distances ranging between 3.3 ft to 39.4 ft (1.0 m to 12 m).

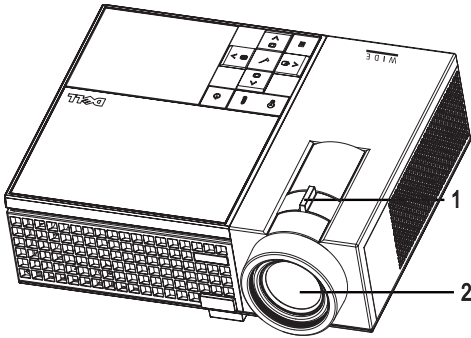

1	Zoom tab
2	Focus ring

# Adjusting Projection Image Size

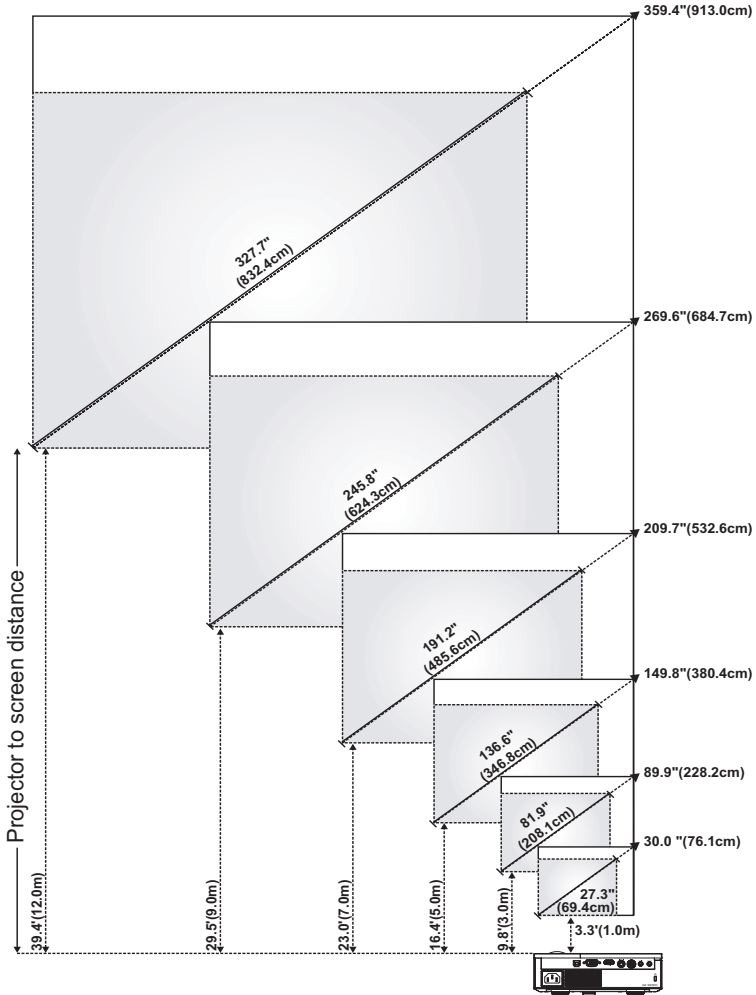







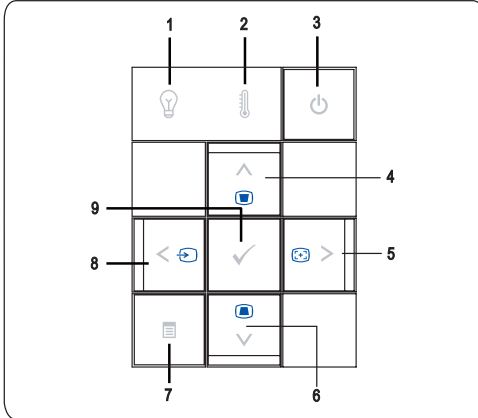











Screen (Diagonal)	Max.	30.0" (76.1cm)	89.9" (228.2cm)	149.8" (380.4cm)	209.7" (532.6cm)	269.6" (684.7cm)	359.4" (913.0cm)
	Min.	27.3" (69.4cm)	81.9" (208.1cm)	136.6" (346.8cm)	191.2" (485.6cm)	245.8" (624.3cm)	327.7" (832.4cm)
Screen Size	Max. (WxH)	25.4" X 15.9" (64.5cm X 40.3cm)	76.2" X 47.6" (193.5cm X 121.0cm)	127" X 79.4" (322.6cm X 201.6cm)	177.8" X 111.1" (451.6cm X 282.3cm)	228.8" X 142.9" (580.6cm X 362.9cm)	304.8" X 190.5" (774.2cm X 483.9cm)
	Min. (WxH)	23.2" X 14.5" (58.8cm X 36.8cm)	69.5" X 43.4" (176.5cm X 110.3cm)	115.8" X 72.4" (294.1cm X 183.8cm)	162.1" X 101.3" (411.8cm X 257.4cm)	208.4" X 130.3" (529.4cm X 330.9cm)	277.9" X 173.7" (705.9cm X 441.2cm)
Hd	Max.	1.97" (5.0cm)	5.91" (15.0cm)	9.84" (25.0cm)	13.78" (35.0cm)	17.72" (45.0cm)	23.62" (60.0cm)
	Min.	1.79" (4.56cm)	5.38" (13.68cm)	8.97" (22.79cm)	12.56" (31.91cm)	16.15" (41.03cm)	21.54" (54.71cm)
Distance		3.3' (1.0m)	9.8' (3.0m)	16.4' (5.0m)	23.0' (7.0m)	29.5' (9.0m)	39.4' (12.0m)
* This graph is for user reference only.							

## Using the Control Panel









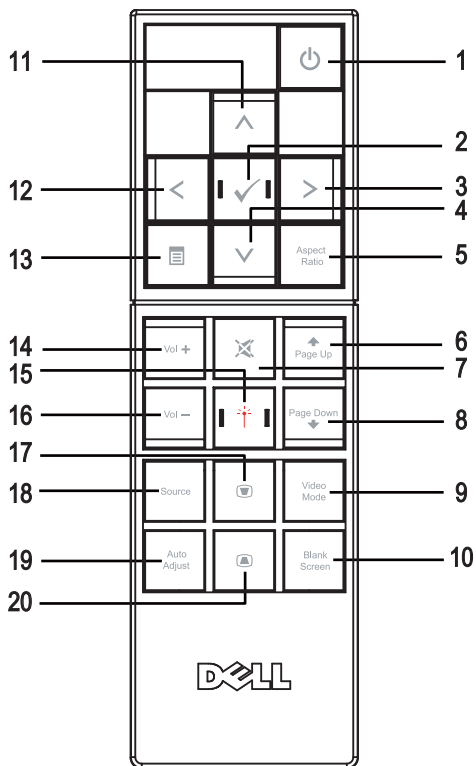







1	LAMP  warning light	<ul style="list-style-type: none"> <li>• If the LAMP light is solid amber, replace the lamp (see Changing the Lamp on page 35). If this problem persists, contact Dell (see Contacting Dell on page 40).</li> <li>• If the LAMP light is blinking amber, the projector automatically shuts down indicating a system failure. If this problem persists, contact Dell (see Contacting Dell on page 40).</li> </ul>
2	TEMP  warning light	<ul style="list-style-type: none"> <li>• A solid amber TEMP light indicates that the projector is overheated. The display automatically shuts down. Turn the display on again after the projector cools down. If the problem persists, contact Dell (see Contacting Dell on page 40).</li> <li>• A blinking amber TEMP light indicates that the projector fan has failed and the projector automatically shuts down. If the problem persists, contact Dell (see Contacting Dell on page 40).</li> </ul>
3	Power 	Allows you to turn the projector on and off. For more information, see Turning Your Projector On on page 13 and Turning Your Projector Off on page 13.
4	Up  / Keystone adjustment	Allows you to select options from the On Screen Display (OSD) menu. You can also use the Up  button to adjust the image distortion caused by tilting the projector.
5	 / Auto adjust	<p>Allows you to adjust the OSD setting.</p> <p>You can also use the Right  button to synchronize the projector to the input source.</p> <p><b>Auto adjust</b> does not operate if the OSD is displayed.</p>
6	Down  / Keystone adjustment	<p>Allows you to select options from the On Screen Display (OSD) menu.</p> <p>You can also use the Down  button to adjust the image distortion caused by tilting the projector.</p>

7	Menu 	Allows you to activate the OSD. Use     and the <b>Menu</b> button to navigate through the OSD.
8	 / Source	Allows you to adjust the OSD setting. You can also use the Left  button to toggle through Analog RGB, Composite, Component (YPbPr, via VGA), S-video, and HDMI sources when multiple sources are connected to the projector.
9	Enter 	Allows you to confirm a selected OSD option.

## Using the Remote Control









1	Power 	Turns the projector on and off. For more information, see Turning Your Projector On on page 13 and Turning Your Projector Off on page 13.
2	Enter 	Press to confirm the selection.
3	Right 	Press to adjust the OSD setting.
4	Down 	Press to select OSD items.
5	Aspect Ratio	Press to change aspect ratio of a displayed image.
6	Page up 	Press to move to previous page.
7	Mute 	Press to mute or un-mute the projector speaker.
8	Page down 	Press to move to next page.
9	Video mode	The Dell M409WX Micro-projector has preset configurations that are optimized for displaying data (PC Graphics) or video (movies, games, etc.). Press the <b>Video Mode</b> button to toggle between <b>PC mode</b> , <b>Movie mode</b> , <b>Game Mode</b> , <b>sRGB</b> , or <b>CUSTOM mode</b> (for user to setup and save preferred settings). Pressing the <b>Video Mode</b> button once will show the current display mode. Pressing the <b>Video Mode</b> button again will switch between modes.
10	Blank screen	Press to hide/unhide the image.
11	Up 	Press to select OSD items.
12	Left 	Press to adjust the OSD setting.
13	Menu 	Press to activate the OSD.
14	Volume up 	Press to increase the volume.
15	Laser 	Point the remote control at the screen, press and hold the laser button to activate the laser light.
16	Volume down 	Press to decrease the volume.
17	Keystone adjustment 	Press to adjust image distortion caused by tilting the projector. (+40/-35 degrees)
18	Source	Press to switch between Analog RGB, Composite, Component (YPbPr, via VGA), HDMI, and S-video sources.

19	Auto adjust	Press to synchronize the projector with the input source. Auto adjust does not operate if the OSD is displayed.
20	Keystone adjustment 	Press to adjust image distortion caused by tilting the projector. (+40/-35 degrees)



## Using the On-Screen Display

The projector has a multi-language On-Screen Display (OSD) that can be displayed with or without an input source present.

In the **Main** menu, press  or  to navigate through the tabs. Press the **Enter** button  on the control panel or the remote control to select a submenu.

In the submenu, press  or  to make a selection. When an item is selected, the color changes to dark gray. Use  or  on the control panel or the remote control to make adjustments to a setting.

To go back to **Main** menu, go to **Back** tab and press the **Enter** button  on the control panel or the remote control.

To exit the OSD, go to **Exit** tab and press **Enter** button  or press **Menu** button  on the control panel or the remote control.

## Main Menu



## Input Select

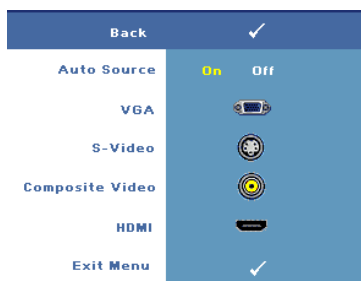

**AUTO SOURCE**—Select **On** (Default) to automatically detect the available input signals. When **On** is selected and you press **Source** on the control panel/remote, it automatically finds the next available input signal.

Select **Off** to lock the current input signal or to manually select the input signal you want to use. When **Off** is selected and you press **Source**, you select which input signal you want.

**VGA**—Press **Enter** to detect VGA signal.

**S-VIDEO**—Press **Enter** to detect S-Video signal.

**COMPOSITE VIDEO**—Press **Enter** to detect Composite Video signal.

**HDMI**—Press **Enter** to detect HDMI signal.

## Auto-Adjust

Auto Adjustment in Progress...

Auto Adjust automatically adjusts the projector's display settings. While auto adjustment is in progress, the following message appears on the screen: **Auto Adjustment in Progress...**

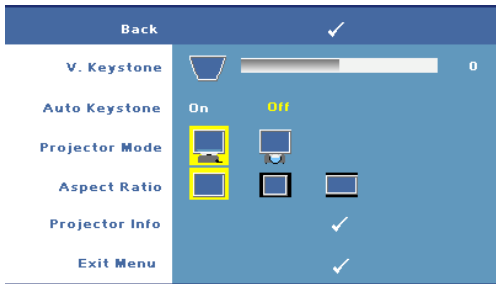

## Set Up





**V. KEYSTONE**—Allows you to adjust image distortion caused by tilting the projector.

**AUTO KEYSTONE**—Auto adjusts the image distortion by tilting the projector.

**PROJECTOR MODE**—Select how the image appears:

-  Front Projection-Desktop (the default).
-  Rear Projection-Desktop — The projector reverses the image so that you can project the image from behind a translucent screen.



**ASPECT RATIO**—Allows you to select an aspect ratio to adjust how the image appears.

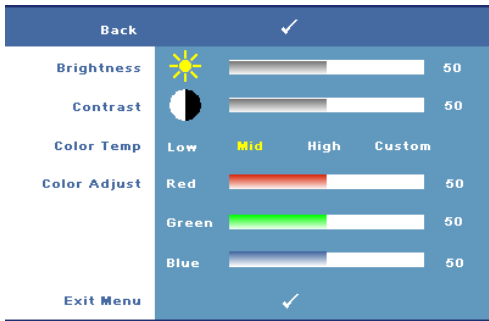

-  Original — The input source scales to fit the screen while keeping the aspect ratio of the input source.
-  4:3 — The input source scales to fit the height of the screen.
-  Wide — The input source scales to fit the screen.

**PROJECTOR INFO**—Press to show the projector model name, the present input source and projector series number (PPID#).

## PICTURE (in PC Mode)



**BRIGHTNESS**—Use  or  to adjust the brightness of the image.



**CONTRAST**—Use  or  to control the degree of difference between the brightest and darkest parts of the picture. Adjusting the contrast changes the amount of black and white in the image.



**COLOR TEMP**—Allows you to adjust the color temperature. The screen appears cooler at higher color temperatures and warmer at lower color temperatures.

**COLOR ADJUST**—Allows you to manually adjust red, green, and blue color. When you adjust the color value in the **Color Adjust** menu, the Custom mode is activated, and the color values are saved in the Custom mode.

## PICTURE (in Video Mode)



**BRIGHTNESS**—Use  or  to adjust the brightness of the image.

**CONTRAST**—Use  or  to control the degree of difference between the brightest and darkest parts of the picture. Adjusting the contrast changes the amount of black and white in the image.

**COLOR TEMP**—Allows you to adjust the color temperature. The screen appears cooler at higher color temperatures and warmer at lower

temperatures.

**COLOR ADJUST**—Allows you to manually adjust red, green, and blue color. When you adjust the color value in the **Color Adjust** menu, the Custom mode is activated, and the color values are saved in the Custom mode.

**SATURATION**—Allows you to adjust a video source from black and white to fully saturated color. Press to decrease the amount of color in the image and to increase the amount of color in the image.

**SHARPNESS**—Allows you to adjust the image sharpness. Press to decrease the sharpness and to increase the sharpness.

**TINT**—Press to increase the amount of green in the image and to increase the amount of red in the image (selectable for NTSC signal only).

## DISPLAY (in PC Mode)

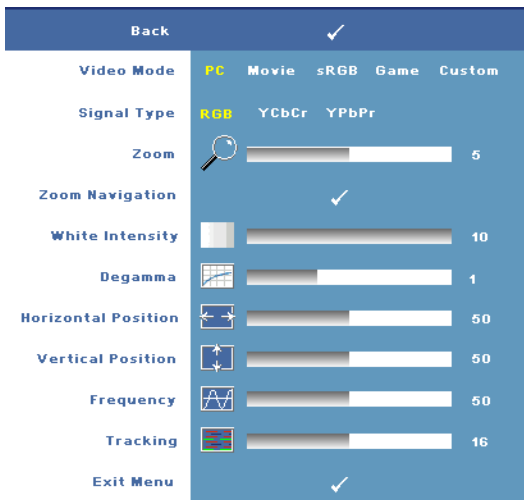

**VIDEO MODE**—Allows you to optimize the projector's display mode.

- **PC, Movie, sRGB** - provides accurate color representation
- **Game, and Custom** - set your preferred settings

**NOTE:** If you adjust the settings for White Intensity or Degamma, the projector automatically switches to Custom.

**SIGNAL TYPE**—Allows you to manually select the signal type. You set the signal

type to RGB, YCbCr, or YPbPr.

**ZOOM**—Press to digitally magnify a default area of image in the center of the screen and press to reduce the zoomed image.



**ZOOM NAVIGATION**—Press to navigate projection screen.

**WHITE INTENSITY**—Set 0 to maximize the color reproduction and 10 to maximize the brightness.

**DEGAMMA**—Allows you to adjust the color performance of the display. You can set the Degamma value to: 1, 2, 3, and 4. Adjust among the 4 preset values to change the color performance of the display.

**HORIZONTAL POSITION**—Press to move the image to the left and to move the image to the right.



**VERTICAL POSITION**—Press  to move the image down and  to move the image up.

**FREQUENCY**—Allows you to change the display data clock frequency to match the frequency of your computer graphics card. If you see a vertical flickering bar, use **Frequency** control to minimize the bars. This is a coarse adjustment.

**TRACKING**—Allows you to synchronize the phase of the display signal with the graphic card. If you experience an unstable or flickering image, use **Tracking** to correct it. This is a fine adjustment.

## DISPLAY (in Video Mode)

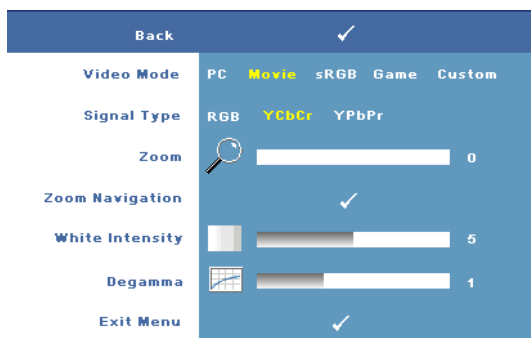



**VIDEO MODE**—Allows you to optimize the projector's display mode.

- **PC, Movie, sRGB** - provides accurate color representation
- **Game, and Custom** - set your preferred settings

 **NOTE:** If you adjust the settings for **White Intensity** or **Degamma**, the

projector automatically switches to **Custom**.

**SIGNAL TYPE**—Allows you to manually select the signal type. You set the signal type to **RGB**, **YCbCr**, or **YPbPr**.

**ZOOM**—Press  to digitally magnify a default area of image in the center of the screen and press  to reduce the zoomed image.

**ZOOM NAVIGATION**—Press     to navigate projection screen.

**WHITE INTENSITY**—Set **0** to maximize the color reproduction and **10** to maximize the brightness.

**DEGAMMA**—Allows you to adjust the color performance of the display. You can set the **Degamma** value to: **1, 2, 3, and 4**. Adjust among the **4** preset values to change the color performance of the display.

## LAMP

Using the **Lamp** menu, you can adjust the display settings of your projectors. The Picture menu, provides the following options:

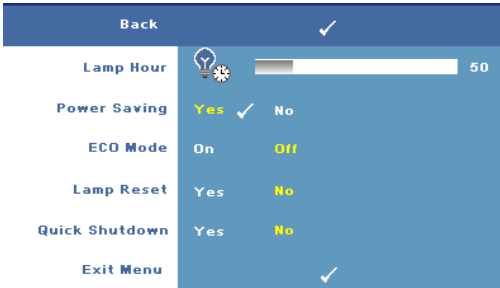

**LAMP HOUR**—Displays the operating hours since the last lamp timer reset.

**POWER SAVING**—Select **Yes** to set the Power Saving delay period. The delay period is the time you want the projector to wait without an input signal. By default, the delay period is set to 120

minutes. However, you can set this to 5 minutes, 15 minutes, 30 minutes, 45 minutes, 60 minutes, or 120 minutes.

If an input signal is not detected during the delay period, the projector turns off the lamp and goes into power saving mode. If an input signal is detected when projector is in power saving mode, the projector automatically turns on. If an input signal is not detected within two hours, the projector switches from Power Saving mode to Power Off mode. To turn on the projector press the Power button.

**ECO MODE**—Select **On** to use the projector at a lower power level (168 Watts). Operating at lower power levels may provide longer lamp life, quieter operation, and dimmer luminance output on the screen. Select **Off** to operate at normal power level (212 Watts).

**LAMP RESET**—After you install a new lamp, select **Yes** to reset the lamp timer.

**QUICK SHUTDOWN**—Select **Yes** to turn off the projector with a single press of the Power button. This function allows the projector to cool down within a short period of time by accelerating the fan speed.



**NOTE:** If Quick Shutdown is enabled, expect a slightly higher acoustic noise during power off.

## LANGUAGE



## OTHERS



**VOLUME**—Press to decrease the volume and to increase the volume.

**MUTE**—Allows you to enable/disable sound.

**AUDIO SOURCE**—Allows you to select the audio source to either **HDMI** or **Analog** (Audio In).

**CUSTOMIZED SCREEN**—Press Enter the Customized Screen menu appears. Select **YES** to capture the screen image as a **My Customized** logo. This

screen replaces all the original screens with the Dell logo. You can recover the default screen by selecting **Dell Logo** on the pop-up screen.

 **NOTE:** To capture a full image, ensure the input signal that is connected to projector is 1280x800 resolution.

**MENU LOCK**—Select **On** to enable Menu Lock and hide the OSD menu. Select **Off** to disable the Menu Lock.

 **NOTE:** You can also disable **Menu Lock** by pressing the **Menu** button on the control pane or remote control for 15 seconds.

**MENU TIMEOUT**—Allows you to adjust the time delay of the **OSD Timeout**. The default setting is 30 seconds.

**MENU POSITION**—Allows you to select the location of the OSD on the screen.

**MENU TRANSPARENCY**—Allows you to select the transparency level of the OSD background.

**PASSWORD**—Allows you to password protect the projector. This security utility enables you to impose a variety of access restrictions to protect your privacy and stop others from tampering with your projector. This means that the projector cannot be used if it is taken without authorization, and thus serves as a theft-prevention feature.

Select **On** to enable password protection. A **Please Key In the Password** screen appears requesting you to enter a password when the projector is powered on the next time. Select **Off** to disable password protection.

 **NOTE:** Password protection is disabled by default.

If you enable this feature, you will be asked to enter the projector's password after you turn on the projector:

- 1 1st time password input request:
  - a Go to **Others** menu, press **Enter** and then select **Password** to **Enable** the password setting.



- b Enable the Password function will pop-up a character screen, key in a 4-digit number from the screen and press the **Enter** button.

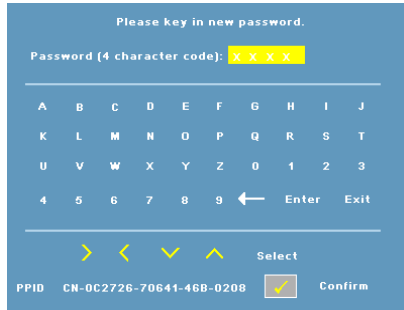

- c To confirm, enter the password again.
- d If the password verification is successful, you may resume with accessing the projector's functions and its utilities.
- 2 If you have entered incorrect password, you will be given another 2 chances. After the three invalid attempts, the projector will automatically turn off.



**NOTE:** If you forget your password, contact Dell.

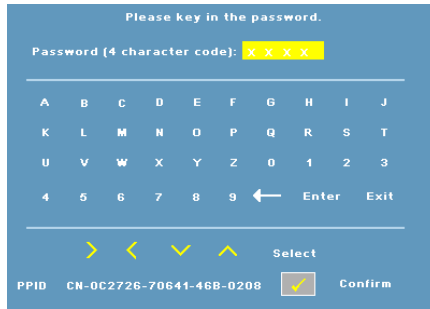

- 3 To cancel the password function, select **OFF** and enter the password to disable the function.



**CHANGE PASSWORD**—Allows you to change the password. Key in the original password and then enter the new password. Enter the new password again to confirm.



**TEST PATTERN**—Select 1 or 2 to activate the built-in **Test Pattern** to test the focus and resolution. Select **Off** to disable the function.

- 1 To run the diagnostics test pattern 1, press and hold the **Menu** button and  button on the projectors control panel simultaneously for two seconds.
- 2 To run the diagnostics test pattern 2, press and hold the **Menu** button and  button on the projectors control panel simultaneously for two seconds.





**NOTE:** To enable test pattern 2, it is required to connect an input signal to projector.

**FACTORY RESET**—Select **On** to reset the projector to its factory default settings.





# Troubleshooting Your Projector

If you experience problems with your projector, see the following troubleshooting tips. If the problem persists, contact Dell (See Contacting Dell on page 40).

---

<b>Problem</b>	<b>Possible Solution</b>
No image appears on the screen	<ul style="list-style-type: none"><li>• Ensure that the lens cap is removed and the projector is turned on.</li><li>• Ensure the external graphics port is enabled. If you are using a Dell portable computer, press   (Fn+F8). For other computers, see your respective documentation.</li><li>• Ensure that all the cables are securely connected. See <a href="#">Connecting Your Projector</a> on page 7.</li><li>• Ensure that the pins of the connectors are not bent or broken.</li><li>• Ensure that the lamp is securely installed. See <a href="#">Guiding Signals</a> on page 34 .</li><li>• Use <b>Test Pattern</b> in the <b>Others</b> menu (see <a href="#">Others</a> on page 27). Ensure that the colors of the test pattern are correct.</li></ul>

---

<b>Problem (continued)</b>	<b>Possible Solution (continued)</b>
Partial, scrolling, or incorrectly displayed image	<ol style="list-style-type: none"> <li><b>1</b> Press the <b>Auto adjust</b> button on the remote control or the control panel.</li> <li><b>2</b> If you are using a Dell™ portable computer, set the resolution of the computer to WXGA (1280 x 800) or XGA (1024 x 768): <ol style="list-style-type: none"> <li><b>a</b> Right-click the unused portion of your Windows desktop, click <b>Properties</b> and then select <b>Settings</b> tab.</li> <li><b>b</b> Verify the setting is 1280 x 800 or 1024 x 768 pixels for the external monitor port.</li> <li><b>c</b> Press   (Fn+F8).</li> </ol> </li> </ol> <p>If you experience difficulty in changing resolutions or your monitor freezes, restart all the equipments and the projector.</p> <p>If you are not using a Dell portable computer, see your documentation for more information.</p>
The screen does not display your presentation	If you are using a Dell portable computer, press   (Fn+F8).
Image is unstable or flickering	Adjust the tracking (see Tracking on page 25) in the OSD <b>Display</b> sub-menu (in PC Mode only).
Image has vertical flickering bar	Adjust the frequency (see Frequency on page 25) in the OSD <b>Display</b> sub-menu (in PC Mode only).
Image color is not correct	<ul style="list-style-type: none"> <li>• If your graphic card output signal is sync on Green, and you would like to display VGA at 60Hz signal, please go into OSD select <b>Display</b>, select <b>Signal Type</b> and then select <b>RGB</b>.</li> <li>• Use <b>Test Pattern</b> in the <b>Others</b> menu. Ensure that the colors of the test pattern are correct.</li> </ul>
Image is out of focus	<ol style="list-style-type: none"> <li><b>1</b> Adjust the focus ring on the projector lens.</li> <li><b>2</b> Ensure that the projection screen is within the required distance from the projector (3.3 ft [1.0 m] to 39.4 ft [12 m]).</li> </ol>



<b>Problem (continued)</b>	<b>Possible Solution (continued)</b>
The image is stretched when displaying a 16:9 DVD	<p>The projector automatically detects the input signal format and maintains the aspect ratio of the projected image according to input signal format with a default setting.</p> <p>If the image is still stretched, adjust the aspect ratio as follows:</p> <ul style="list-style-type: none"> <li>• If you are playing a 16:9 DVD, select 4:3 aspect ratio type on your DVD player.</li> <li>• If you cannot select 4:3 aspect ratio type on your DVD player, select 4:3 aspect ratio in the <b>Set Up</b> menu in the OSD.</li> </ul>
Image is reversed	Select <b>Set Up</b> from the OSD and adjust the projector mode.
Lamp is burned out or makes a popping sound	When the lamp reaches its end of life, it may burn out and may make a loud popping sound. If this occurs, the projector does not turn back on. To replace the lamp, see on page 35.
The OSD does not appear on the screen	Try to press the <b>Menu</b> button on the control panel or remote control for 15 seconds to unlock the OSD. Check the <b>Menu Lock</b> on page 28.
The remote control is not operating smoothly or works only within a limited range	The battery may be low. Check if the laser beam transmitted from the remote is too dim. If so, replace with 2 new AAA batteries.

# Guiding Signals

Projector Status	Description	Control Buttons			Indicator	
		Power	Menu	Others	TEMP (Amber)	LAMP (Amber)
Standby mode	Projector in Standby mode. Ready to power on.	BLUE Flashing	OFF	OFF	OFF	OFF
Warming up mode	Projector takes some time to warm up and power on.	BLUE	BLUE	BLUE	OFF	OFF
Lamp on	Projector in Normal mode, ready to display an image.  <b>Note:</b> The OSD menu is not accessed.	BLUE	BLUE	OFF	OFF	OFF
Cooling mode	Projector is cooling to shutdown.	BLUE	OFF	OFF	OFF	OFF
Power Saving mode	Power Saving mode has been activated. The projector will automatically enter standby mode, if an input signal is not detected in two hours.	AMBER Flashing	OFF	OFF	OFF	OFF
Cooling before Power Saving mode.	The projector takes 60 seconds to cool down before entering Power Saving mode.	AMBER	OFF	OFF	OFF	OFF
Projector over-heated	Air vents might be blocked or ambient temperature may be above 35°C. The projector automatically shuts down. Ensure that the air vents are not blocked and that the ambient temperature is within operational range. If the problem persists, contact Dell.	OFF	OFF	OFF	AMBER	OFF
Lamp over-heated	The lamp is over heated. The air vents may be blocked. The projector automatically shuts down. Turn the display on again after the projector cools down. If problem persists, contact Dell.	BLUE	OFF	OFF	AMBER	OFF
Lamp driver over-heated	The lamp driver is over heated. The air vents may be blocked. The projector automatically shuts down. Turn the display on again after the projector cools down. If the problem persists, contact Dell.	AMBER	OFF	OFF	AMBER	OFF
Fan breakdown	One of the fans has failed. The projector automatically shuts down. If the problem persists, contact Dell.	OFF	OFF	OFF	AMBER Flashing	OFF
Lamp driver breakdown	The lamp driver has failed. The projector automatically shuts down. Unplug the power cable after three minutes then turn the display on again. If this problem persists, contact Dell.	AMBER Flashing	OFF	OFF	OFF	AMBER Flashing
Color Wheel breakdown	Color wheel cannot start. The projector has failed and the projector automatically shuts down. Unplug the power cable after three minutes and turn on the projector. If this problem persists, contact Dell.	BLUE	OFF	OFF	AMBER Flashing	AMBER Flashing
Lamp failure	Lamp is defective. Replace the lamp.	OFF	OFF	OFF	OFF	AMBER
Fault - DC supply (+12V)	Power supply has been interrupted. The projector automatically shuts down. Unplug the power cable after three minutes and then turn on the projector. If this problem persists, contact Dell.	AMBER Flashing	OFF	OFF	AMBER	AMBER
Fault - DC supplies (secondary)	Power supply has been interrupted. The projector automatically shuts down. Unplug the power cable after three minutes and then turn on the projector. If this problem persists, contact Dell.	AMBER Flashing	OFF	OFF	AMBER	OFF

\*Others: control buttons on the control panel except Power and Menu

# Changing the Lamp

The following message appears on the screen when your projector lamp is approaching end of life and requires to be changed: Lamp is approaching the end of its useful life in full power operation. Replacement suggested.  
[www.dell.com/lamps](http://www.dell.com/lamps)



**CAUTION: Before you begin any of the procedures in this section, follow the Safety Instructions as described on page 6.**

To replace the lamp:

- 1 Turn off the projector and disconnect the power cable.



**CAUTION: The lamp becomes very hot when in use. Do not attempt to replace the lamp until the projector has been allowed to cool down for at least 30 minutes.**

- 2 Let the projector cool for at least 30 minutes.
- 3 Loosen the two screws that secure the lamp cover, and remove the cover.

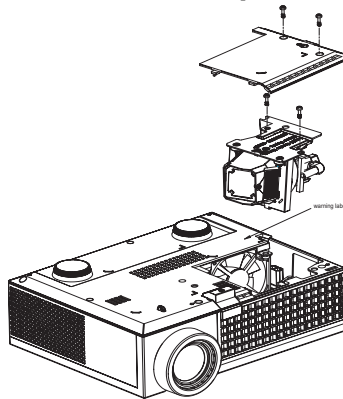

**CAUTION: Do not touch the lamp or the lamp glass at any time. Projector lamps are very fragile and may shatter if touched.**



**CAUTION: If the lamp shatters, remove all broken pieces from the projector and dispose or recycle according to state, local, or federal law. For more information, see [www.dell.com/hg](http://www.dell.com/hg).**

- 4 Loosen the two screws that secure the lamp.
- 5 Pull the lamp up by its metal handle.
- 6 Replace with the new lamp.



**NOTE:** Dell may require lamps replaced under warranty to be returned. Otherwise, dispose or recycle the lamp. For more information, see Lamp Disposal on page 36.

7 Tighten the two screws that secure the lamp.

8 Replace the lamp cover and tighten the two screws.

9 Reset the lamp usage time by selecting **Yes** for **Lamp Reset** in the OSD Lamp menu. (See Lamp menu on page 26)



**CAUTION: Lamp Disposal (for the US only)**



**LAMP(S) INSIDE THIS PRODUCT CONTAIN MERCURY AND MUST BE RECYCLED OR DISPOSED OF ACCORDING TO LOCAL, STATE OR FEDERAL LAWS. FOR MORE INFORMATION, GO TO [WWW.DELL.COM/HG](http://WWW.DELL.COM/HG) OR CONTACT THE ELECTRONIC INDUSTRIES ALLIANCE AT [WWW.EIAE.ORG](http://WWW.EIAE.ORG). FOR LAMP SPECIFIC DISPOSAL INFORMATION CHECK [WWW.LAMPRECYCLE.ORG](http://WWW.LAMPRECYCLE.ORG).**

# Specifications

Light Valve	Single-chip 0.65" WXGA DMD Type A, DarkChip™2
Brightness	2000 ANSI Lumens (Max.)
Contrast Ratio	2000:1 Typical (Full On/Full Off)
Uniformity	80% Typical (Japan Standard - JBMA)
Number of Pixels	1280 x 800 (WXGA)
Displayable Color	16.7M colors
Color Wheel Speed	100~127.5Hz (2X) 150Hz (3X) in Movie mode
Projection Lens	F/2.44~2.58, f=21.8~23.8 mm with 1.1x manual zoom lens
Projection Screen Size	27.3-359.4 inches (diagonal)
Projection Distance	3.3~39.4 ft (1.0 m~12 m)
Video Compatibility	Composite Video / S-Video: NTSC (J, M, 4.43), PAL (B, D, G, H, I, M, N, Nc, 60), SECAM (B, D, G, K, K1, L) Component Video via VGA & HDMI: 1080i/p, 720p, 576i/p, 480i/p
Power Supply	Universal 90-264V AC 50-60Hz with PFC input
Power Consumption	212 watts in full mode, 168 watts in eco mode < 3 watts in power off mode.
Audio	1 watt speaker
Noise Level	39 dB(A) Full-on mode, 32 dB(A) Eco-mode
Weight	2.6 lbs (1.18 kg)

Dimensions (W x D x H)	External 8.07 x 6.10 x 2.85 ± 0.04 inches (205 x 155 x 72.5 ± 1 mm)
Environmental	Operating temperature: 5°C - 35°C (41°F- 95°F) Humidity: 80% maximum Storage temperature: 0°C to 60°C (32°F to 140°F) Humidity: 90% maximum
Regulatory	FCC, CE, VCCI, UL, cUL, Nemko-GS, ICES-003, MIC, C-Tick, CCC, PSB, NOM, SABS, eK
I/O Connectors	Power: AC power input socket Computer input: one D-sub for analog/component, HDTV input signals Video input: one composite video RCA and one S-video Audio input: one phone jack (diameter 3.5 mm) Audio output: one phone jack (diameter 3.5 mm) USB port: One USB slave for remote support. HDMI input: Support HDMI 1.1. HDCP compliant.
Lamp	165-watt user-replaceable 3000-hour lamp (up to 5000 hours in eco mode)



**NOTE:** The actual operating life span of a projector lamp will vary according to operating conditions and usage patterns. Usage of a projector in stressful conditions which may include dusty environments, under high temperatures and abrupt powering-off may result in a lamp's shortened operating life span or possibly lamp failure. The lamp life specified for Dell's projectors refers to the typical time under non-stressful operating conditions for more than 50% of a sampling population to reduce to approximately 50% of the lamp's rated brightness level. It is not the measure of time a lamp will cease light output.

## Compatibility Modes (Analog/Digital)

Resolution	V. Frequency (Hz)	H. Frequency (KHz)
640X480	59.9	31.5
640X480	75	37.5
640X480	85	43.3
720X400	70.1	31.5
720X400	85	37.9
800X600	60.3	37.9
800X600	75	46.9
800X600	85.1	53.7
848X480	60	31
1024X768	60	48.4
1024X768	75	60
1024X768	85	68.7
1152X864	75	67.5
1280X720	59.9	44.8
1280X768	59.9	47.8
1280X800	59.8	49.7
1280X1024	60	64
1280X1024	75	80
1280X1024	85	91.1
1360X768	60	47.7
1400X1050	60	65.3
1440X900	59.9	55.9
1680X1050	60	65.3
1600X1200	60	75

# Contacting Dell

For customers in the United States, call 800-WWW-DELL (800-999-3355).



**NOTE:** If you do not have an active Internet connection, you can find contact information on your purchase invoice, packing slip, bill, or Dell product catalog.

Dell provides several online and telephone-based support and service options. Availability varies by country and product, and some services may not be available in your area. To contact Dell for sales, technical support, or customer service issues:

- 1 Visit [support.dell.com](http://support.dell.com).
- 2 Verify your country or region in the **Choose A Country/Region** drop-down menu at the bottom of the page.
- 3 Click **Contact Us** on the left side of the page.
- 4 Select the appropriate service or support link based on your need.
- 5 Choose the method of contacting Dell that is convenient for you.



# Appendix: Glossary

**ANSI Lumens** —A standard for measuring light output, used for comparing projectors. A standard for measuring the brightness. It is calculated by dividing a square meter image into nine equal rectangles, measuring the lux (or brightness) reading at the center of each rectangle, and averaging these nine points.

**Aspect Ratio** —The most popular aspect ratio is 4:3 (4 by 3). Early television and computer video formats are in a 4:3 aspect ratio, which means that the width of the image is  $\frac{4}{3}$  times the height.

**Brightness**— The amount of light emitting from a display or projection display or projection device. The brightness of projector is measured by ANSI lumens.

**Color Temperature**— The color appearance of white light. Low color temperature implies warmer (more yellow/red) light while high color temperature implies a colder (more blue) light. The standard unit for color temperature is Kelvin (K).

**Component Video**—A method of delivering quality video in a format that contains all the components of the original image. Consists of the luminance signal and two separate chrominance signals and are defined as Y'Pb'Pr' for analog component and Y'Cb'Cr' for digital component. Component video is available on DVD players and projectors.

**Composite Video** — A video signal that combines the luma (brightness), chroma (color), burst (color reference), and sync (horizontal and vertical synchronizing signals) into a signal waveform carried on a single wire pair. There are three kind of formats, namely, NTSC, PAL and SECAM.

**Compressed Resolution**— If the input images are of greater resolution than the native resolution of the projector, the resulting image will be scaled to fit the native resolution of the projector. The nature of compression in a digital device means that some image content is lost.

**Contrast Ratio**— Range of light and dark values in a picture, or the ratio between their maximum and minimum values. There are two methods used by the projection industry to measure the ratio:

**1 Full On/Off** — measures the ratio of the light output of an all white image (full on) and the light output of an all black (full off) image.

**2 ANSI** — measures a pattern of 16 alternating black and white rectangles. The average light output from the white rectangles is divided by the average light output of the black rectangles to determine the ANSI contrast ratio.

*Full On/Off* contrast is always a larger number than ANSI contrast for the same projector.

**dB**— decibel—A unit used to express relative difference in power or intensity, usually between two acoustic or electric signals, equal to ten times the common logarithm of the ratio of the two levels.

**Diagonal Screen**— A method of measuring the size of a screen or a projected image. It measures from one corner to the opposite corner. A 9FT high, 12FT wide, screen has a diagonal of 15FT. This document assumes that the diagonal dimensions are for the traditional 4:3 ratio of a computer image as per the example above.

**DLP®**— Digital Light Processing™—Reflective display technology developed by Texas Instruments, using small manipulated mirrors. Light passes through a color filter is sent to the DLP mirrors which arrange the RGB colors into a picture projected onto screen, also known as DMD.

**DMD**— digital Micro- Mirror Device— Each DMD consists of thousands of tilting, microscopic aluminum alloy mirrors mounted on a hidden yoke.

**Focal Length**— The distance from the surface of a lens to its focal point.

**Frequency**— It is the rate of repetition in cycles per seconds of electrical signals. Measured in Hz.

**HDMI**— High Definition Multimedia Interface, carry both uncompressed high definition video along with digital audio and device control data in a single connector.

**Hz** — Hertz, unit of frequency.

**Keystone Correction**— Device that will correct an image of the distortion (usually a wide-top narrow-bottom effect) of a projected image caused by improper projector to screen angle.

**Laser pointer**— A small pen or cigar sized pointer that contains small battery powered laser, which can project small, red (typically), highly intensity beam of light that is immediately very visible on the screen

**Maximum Distance**— The distance from a screen the projector can be to cast an image that is useable (bright enough) in a fully darkened room.

**Maximum Image Size**— The largest image a projector can throw in a darkened room. This is usually limited by focal range of the optics.

**Minimum Distance**— The closest position that a projector can focus an image onto a screen.

**NTSC**— National Television Standards Committee. North American standard for video and broadcasting, with a video format of 525 lines at 30 frames per second.

**PAL**— Phase Alternating Line. A European broadcast standard for video and broadcasting, with a video format of 625 lines at 25 frames per second.

**Reverse Image**— Feature that allows you to flip the image horizontally. When used in a normal forward projection environment text, graphics, etc, are backwards. Reverse image is used for rear projection.

**RGB**— Red, Green, Blue— typically used to describe a monitor that requires separate signals for each of the three colors.

**S-Video**—A video transmission standard that uses a 4-pin mini-DIN connector to send video information on two signal wires called luminance (brightness, Y) and chrominance (color, C). S-Video is also referred to as Y/C.

**SECAM**— A French and international broadcast standard for video and broadcasting, closely related to PAL but with a different method of sending color information.

**SVGA**— Super Video Graphics Array— 800 x 600 pixels count.

**SXGA**— Super Extended Graphics Array—1280 x 1024 pixels count.

**UXGA**— Ultra Extended Graphics Array—1600 x 1200 pixels count.

**VGA**— Video Graphics Array—640 x 480 pixels count.

**WXGA**— Wide Extended Graphics Array—1280x800 pixels count.

**XGA**— Extended Graphics Array— 1024 x 768 pixels count.

**Zoom Lens**— Lens with a variable focal length that allows operator to move the view in or out making the image smaller or larger.

**Zoom Lens Ratio**— Is the ratio between the smallest and largest image a lens can project from a fixed distance. For example, a 1.4:1 zoom lens ratio means that a 10 foot image without zoom would be a 14 foot image with full zoom.

# Index

## A

- Adjusting Projection Image Size 16
- Adjusting the Projected Image 14
  - Adjusting the Projector Height 14
    - Elevator button 14
    - Elevator foot 14
    - Tilt adjustment wheel 14
- Adjusting the Projector Zoom and Focus 15
  - Focus ring 15
  - Zoom tab 15

## C

- Changing the Lamp 35
- Connecting a Computer
  - Power cable 8
  - USB to USB cable 8
  - VGA to VGA cable 8
- Connecting a DVD Player
  - Using a Component Cable 11
    - D-sub to YPbPr cable 11
    - Power cable 11
  - Using a Composite Cable 10
    - Composite video cable 10
    - Power cable 10
  - Using an HDMI Cable 12
    - HDMI cable 12
    - Power cable 12
  - Using an S-video Cable 9

- Power cable 9
- S-video cable 9

## Connection Ports

- Audio input connector 7
- Audio output connector 7
- HDMI input connector 7
- Power cable connector 7
- Security cable slot 7
- S-video input connector 7
- USB remote connector 7
- VGA input connector 7
- Video input connector 7

## Contact Dell 5, 18

## Contacting Dell 40

- Control Panel 17
  - Enter button 19
  - Left/ Source 19
  - MENU 19

## D

- Dell
  - Contacting 40

## G

- Guiding Signals 34

## M

- Main Unit 6

- Control panel 6
- Elevator button 6
- Focus ring 6
- IR receiver 6
- Lens 6
- Zoom tab 6

## **O**

- On-Screen Display 21
  - Auto-Adjust 22
  - DISPLAY (in PC Mode) 24
  - DISPLAY (in Video Mode) 25
  - Input Select 21
  - LAMP 26
  - LANGUAGE 27
  - Main Menu 21
  - Other 27
  - PICTURE (in PC Mode) 23
  - PICTURE (in Video Mode) 23
  - Set Up 22

## **P**

- Phone numbers 40
- Powering On/Off the Projector
  - Turning Your Projector Off 13
  - Turning Your Projector On 13

## **R**

- Remote Control 19

## **S**

- Specifications

- Audio 38
- Brightness 37
- Color Wheel Speed 37
- Compatibility Modes 39
- Contrast Ratio 37
- Dimensions 38
- Displayable Color 37
- Environmental 38
- I/O Connectors 38
- Lamp 37
- Light Valve 37
- Noise Level 38
- Number of Pixels 37
- Power Consumption 37
- Power Supply 37
- Projection Distance 37
- Projection Lens 37
- Projection Screen Size 37
- Regulatory 38
- Uniformity 37
- Video Compatibility 37
- Weight 38

## Support

- Contacting Dell 40

## **T**

- Telephone numbers 40
- Troubleshooting 31
  - Contact Dell 31