

PHILIPS

PicoPix Micro 2

Portable projector

PPX340

User Manual



Table of contents

Introduction	3	7 Service	14
Dear customer	3	Built-in battery care	14
About this user manual.....	3	Cleaning.....	14
What's in the box.....	3	Update software	14
Customer service centre	3	Troubleshooting.....	15
1 General safety information	4	8 Appendix	17
Setting up the product	4	Technical data	17
Repairs	4	CE statement	18
Power supply	5	FCC statement.....	18
2 Overview	5	Canada regulatory compliance.....	18
Rear view	5	Other notice.....	18
Front view.....	6		
Side view.....	6		
Remote control.....	6		
3 Connect	7		
HDMI connection for image projection.....	7		
USB-C connection for image projection.....	7		
4 Operation	8		
Place the projector.....	8		
Connect power supply	8		
Prepare the remote control	9		
Power on and set up.....	9		
Using tripod	10		
Placement options.....	10		
5 Other features	11		
Listen through external speakers or headphones.....	11		
Charge a USB device.....	12		
Use HDMI ARC function.....	12		
Use easy link	12		
6 Change settings	12		
Language settings.....	12		
Input source selection	12		
Picture settings.....	13		
Sound settings.....	13		
Power control settings.....	13		
Restore default settings.....	13		
Other settings	13		

Introduction

Dear customer

Thank you for purchasing this projector.

We hope you enjoy this product and the many functions it offers!

About this user manual

The quick start guide supplied with this product allows you to start using this product quickly and easily. Detailed descriptions can be found in the following sections of this user manual.

Read the entire user manual carefully. Follow all safety instructions in order to ensure proper operation of this product (see **General safety information, page 4**). The manufacturer accepts no liability if these instructions are not followed.

Symbols used

Notice



Troubleshooting

This symbol indicates tips that will help you in using this product more effectively and easily.

DANGER!



Danger of personal injury!

This symbol gives warning of danger of personal injury. Physical injury or damage can result from improper handling.

CAUTION!



Damage to the product or loss of data!

This symbol gives warning of damage to the product and possible loss of data. Damage can result from improper handling.

What's in the box

- ① Quick Start Guide
- ② PicoPix Micro 2 projector (PPX340)
- ③ Tripod
- ④ Transport bag
- ⑤ 3x power plug adapter (EU, UK, US)
- ⑥ 2x AAA batteries
- ⑦ 1x power adapter
- ⑧ Remote control

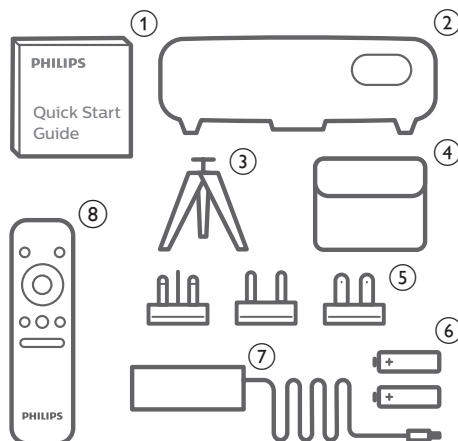

Customer service centre

You can find the support hotline in the warranty card or online:

Web: www.philips.com/support

Mail: philips.projector.eu@screeneo.com

International Phone: +41 215 391 665

Please ask your provider for international call costs!

Access the electronic user manual at <https://support.philipsprojection.com>

Access the community forum at <https://community.philipsprojection.com>

1 General safety information

Take note of all warning and safety notes indicated. Do not make any changes or settings that are not described in this user manual. Incorrect operation, and improper handling can lead to physical injury, damage to the product or loss of data.

Setting up the product

This product is for indoor use only. Place the product securely on a stable, flat surface. To help avoid possible injuries to persons or damage to the product itself, position all cables in such a way that no one will trip over them.

Do not operate the product in damp rooms. Never touch the mains cable or the mains connection with wet hands.

The product must have sufficient ventilation and must not be covered. Do not put the product in closed cabinets, boxes, or other enclosures when in use. Do not cover the lens during operation.

Protect the product from direct sunlight, heat, intense temperature fluctuations and moisture. Do not place the product in the vicinity of heaters or air conditioners. Observe the information on temperature listed in the technical data (see **Technical data**, page 17).

Prolonged operation of the product causes the surface to become warm hot. In case of overheating, the product automatically switches to standby mode.

Do not allow liquids to leak into the product. Turn off the product and disconnect it from the mains supply if liquids or foreign substances leaked into the product. Have the product inspected by an authorised service centre.

Always handle the product with care. Avoid touching the lens. Never place heavy or sharp objects on the product or on the power cable.

If the product gets too hot or emits smoke, shut it down immediately and unplug the power cable. Have your product checked by an authorised service centre. Keep the product away from open flames (e.g. candles).

The product has built-in battery. Do not disassemble and modify. The built-in battery should be replaced by qualified service staff only.

Do not try to replace the built-in battery yourself. Incorrect handling of the battery or using the wrong type of battery can cause damage to the product or cause injury.

! DANGER!



Risk of explosion with incorrect type of batteries!

There is a risk of explosion if the wrong battery type is used.

Do not expose the batteries (battery pack or embedded batteries) to excessive heat such as sunshine, or open fire.

Under the following conditions, a layer of moisture can appear inside the product which can lead to malfunctions:

- if the product is moved from a cold to a warm area;
- after a cold room is heated;
- when the product is placed in a damp room.

Proceed as follows to avoid any moisture buildup:

- 1 Seal the product in a plastic bag before moving it to another room, in order for it to adapt to room conditions.
- 2 Wait one to two hours before you take the product out of the plastic bag.

The product should not be used in a very dusty environment. Dust particles and other foreign objects may damage the product.

Do not expose the product to extreme vibrations. This may damage the internal components.

Do not allow children to handle the product without supervision. The packing materials should be kept out of the hands of children.

For your own safety, do not use the product during thunderstorms with lightning.

Repairs

Do not repair the product yourself. Improper maintenance can result in injuries or damage to the product. The product must be repaired by an authorised service centre.

Please find the details of authorised service centres on the warranty card supplied with this product.

Do not remove the type label from this product, as this will void the warranty.

Power supply

Use only a power adapter which is certified for this product (see **Technical data, page 17**).

Check whether the mains voltage of the power supply matches the mains voltage available at the setup location. This product complies with the voltage type specified on the product.

The power outlet shall be installed near the product and shall be easily accessible.

The capacity of the built-in battery diminishes with time. If the product functions only with AC power supply, the built-in battery is defective. Contact an authorised service centre to replace the built-in battery.

CAUTION!



Always use the  button to turn the projector off.

Turn off the product and unplug from the power outlet before cleaning the surface (see **Cleaning, page 14**). Use a soft, lint-free cloth. Never use liquid, gaseous or easily flammable cleaners (sprays, abrasives, polishes, alcohol). Do not allow any moisture to reach the interior of the product.

DANGER!







Risk of eye irritation!

This product is equipped with a high power LED (Light Emitting Diode), which emits very bright light. Do not look directly into the projector lens during operation. This could cause eye irritation or damage.

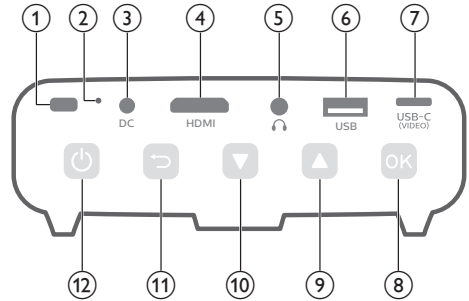
2 Overview

Rear view



- ① **IR sensor**
- ② **Reset key**
Reset the projector to the factory default settings (use a small pin to press the reset key).
- ③ **DC socket**
Connect to the power supply.
- ④ **HDMI port**
Connect to the HDMI output on a playback device.
- ⑤ 
3.5 mm audio output; connect to external speakers or headphones.
- ⑥ **USB port**
Connect to power USB devices like Amazon Fire TV stick®, Roku® streaming stick (not for mass storage or media player).
- ⑦ **USB-C (VIDEO) port**
Connect to the USB-C video output on a playback device.
- ⑧ **OK**
 - Access the settings menu.
 - Confirm a selection or entry.
- ⑨ 
 - Navigate menu options.
 - Increase volume.
- ⑩ 
 - Navigate menu options.
 - Decrease volume.
- ⑪ 
Return to a previous menu screen.

⑫ OK

- Press and hold for one second to switch the projector on.
- Press twice to switch the projector off.
- When the projector is switched on, the LED turns white. When the projector is switched off, the LED turns off.
- When charging the projector, the LED turns red regardless of the projector switching on or off.

Front view

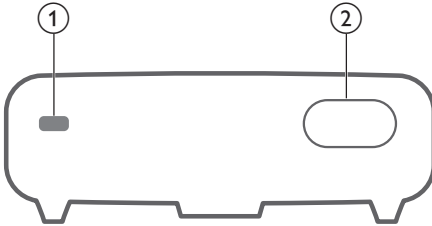

① IR sensor

② Projection lens

Side view

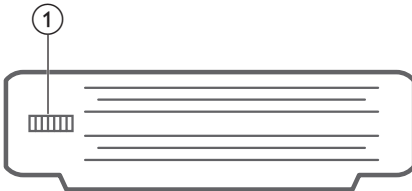

① Focus adjustment knob

Adjust image sharpness.

Remote control

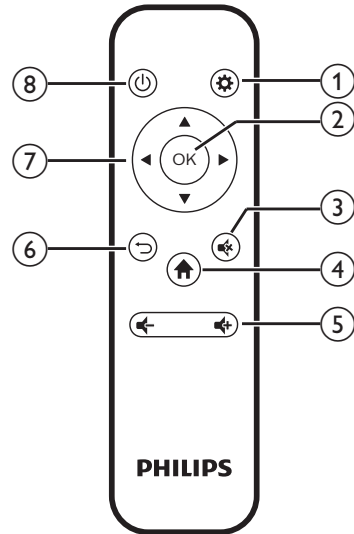

① ⚙️

Access the settings menu.

② OK

Confirm a selection or entry.

③ 🔇

Mute or restore volume.

④ 🏠

Access the home menu.

⑤ **Volume control**

Increase or decrease volume.

⑥ ↶

Return to a previous menu screen.

⑦ **Navigation buttons**

Navigate menu options.

⑧ ⏻

- Press and hold for one second to switch the projector on.
- Press twice to switch the projector off.

3 Connect

Notice

- i** You need to connect the projector to an HDMI or USB-C device, so that the projection screen can show images. Make sure all devices are disconnected from the power outlet before establishing or changing any connections.

HDMI connection for image projection

Connect a playback device (e.g. a Blu-ray player, gaming console, camcorder, digital camera or PC) to the projector through HDMI connection. With this connection, images are shown on the projection screen, and audio is played on the projector.

- Using an HDMI cable, connect the **HDMI** connector on the projector to the HDMI output on the playback device. This product supports HDMI ARC function.

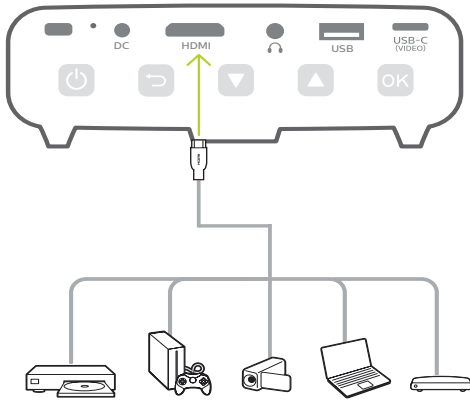

- If the projection screen does not show images, select HDMI input. Press **⚙️** on the remote control to access the settings menu, then navigate to select **HDMI**.

USB-C connection for image projection

Connect a USB-C device (e.g. a mobile phone, tablet or laptop) to the projector through USB-C connection. With this connection, images are shown on the projection screen, and audio is played on the projector.

- Using a USB-C cable, connect the **USB-C** connector on the projector to the USB-C port on the playback device.

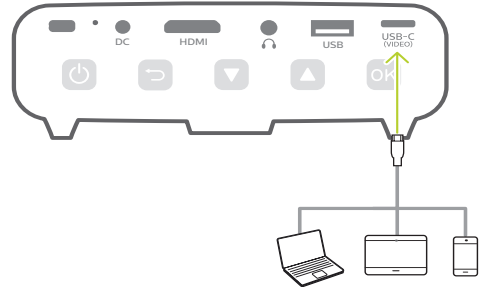

- If the projection screen does not show images, select USB-C input. Press **⚙️** on the remote control to access the settings menu, then navigate to select **USB-C**.

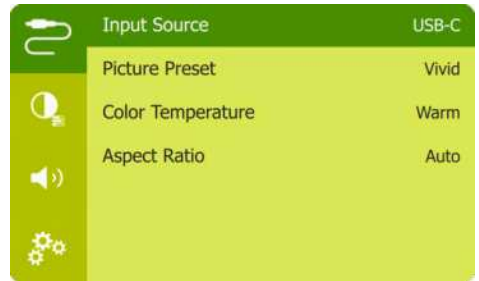

Notice

- i** The projector supports stereo audio format only. If no audio from the playback device is heard on the projector, check that the audio output format is set to stereo on the playback device.

4 Operation

Notice



You need to connect the projector to an HDMI or USB-C device, so that the projection screen can show images (see **Connect, page 7**).

Place the projector

Place the projector on a flat surface in front of the projection surface.

You can also install the projector in different configurations (see **Placement options, page 10**).

Connect power supply

The projector can be operated by either external power or built-in battery.

CAUTION!



Always use the  button to turn the projector on and off.

Operation by external power

- 1 Fix an appropriate plug (EU, UK, US) onto the round base of the power adapter by aligning the pins and holes.
 - To detach the plug from the power adapter, hold down the tab at the edge of the round base, and simultaneously turn and unlock the plug from the round base of the power adapter.

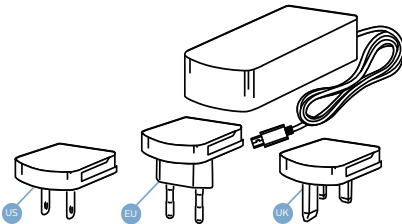

- 2 Connect the power adapter to the **DC** socket on the projector, and then to the wall outlet.



Operation by built-in battery

The projector can be also operated on built-in battery for portability.

Charge the projector

Charge the projector for 1.5 hours before first use.

Charge the projector when the low battery icon appears in the projection screen.

- To charge the projector, connect the projector to an external power supply as described in the section of "Operation by external power".
- When charging, the LED on the projector turns red. When fully charged, the red LED turns off.
- When powered on, the external power will be used first to run the projector and unused power will charge the battery.
- For faster charging, charge while the projector is powered off.

Notice



The capacity of the built-in battery diminishes with time. If the projector functions only with external power supply, the built-in battery is defective. Contact an authorised service centre to replace the built-in battery.

Prepare the remote control

CAUTION!



The improper use of batteries can lead to overheating, explosion, risk of fire and injury. Leaking batteries can possibly damage the remote control.

Never expose the remote control to direct sunlight.

Avoid deforming, dismantling or charging the batteries.

Avoid exposure to open fire and water.

Replace empty batteries immediately.

Remove the batteries from the remote control if not in use for long periods of time.

- 1 Press and hold the battery compartment cover, and simultaneously slide it open to access the battery compartment.
- 2 Insert the supplied batteries (type AAA) with correct polarity (+/-) indicated.
- 3 Close the battery compartment.

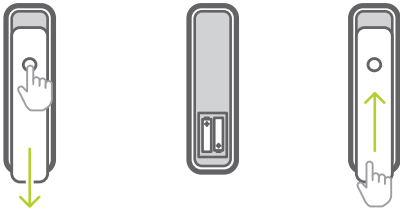



Notice



When using the remote control, point the remote control at the IR sensor located on the back of the projector, and make sure there is no obstacle between the remote control and the IR sensor.

Power on and set up

- 1 Press and hold  on the projector (or  on the remote control) for 1 second to switch the projector on.
 - When the projector is switched on, the LED on the projector turns white if the projector is not being charged.
 - When charging, the LED on the projector turns red regardless of the projector switching on or off.

Set up the language

- 1 Press  on the remote control to access the settings menu, then navigate to select *OSD Language*, and press **OK**.
- 2 Press the **Navigation button** to select a language.

Change screen size

The projection screen size (or size of images) is determined by the distance between the lens of the projector and the projection surface.

- The projection distance needs to be 1.2 times the width of your desired screen size.
- The projection image size is up to 80".
- The projection distance is 80 cm to 200 cm.

Image sharpness adjustment

To adjust image focus, turn the focus adjustment knob on the side of the projector.

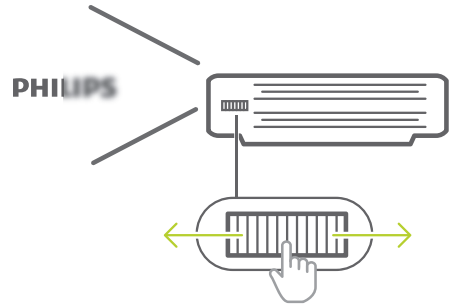



Image shape correction

Auto correction (vertical keystone)

The projector can automatically correct the image to be rectangular when you tilt the projector upwards or downwards.

To enable auto vertical keystone correction, press  on remote control to access the settings menu, then navigate to select *Auto Keystone - On*.

	Brightness	Eco
	Projection Mode	Rotate Ceiling
	Auto Rotate	On
	Auto Keystone	On
	Manual Keystone	50
	Display Duration	15

Manual vertical correction

You can manually correct keystone or distorted images in the vertical orientation.

- 1 Make sure you have selected *Auto Keystone - Off* to enable this function. Press  on the remote control to access the settings menu, then navigate to select *Manual Keystone*.

	Brightness	Eco
	Projection Mode	Rotate Ceiling
	Auto Rotate	On
	Auto Keystone	On
	Manual Keystone	50
	Display Duration	15

- 2 Press the **Navigation button** to adjust the image shape.

Using tripod

The projector comes with a tripod which allows more choices for placing the projector.

Locate the tripod socket on the bottom of the projector, then mount and secure the projector on the tripod.

Placement options

You can install the projector in the following configurations. Follow the guidelines below for different projector placement.

Notice



For overhead mounting on ceiling, purchase a projector mount recommended by an installation professional and follow the instructions that come with the mount.

Before mounting on the ceiling, make sure the ceiling can support the weight of the projector and mounting kit.

For ceiling installation, this product must be securely attached to the ceiling in accordance with the installation instructions. An improper ceiling installation may result in accident, injury or damage.

Front table

- 1 Place the projector on a table in front of the projection screen. This is the most common way to position the projector for quick setup and portability.

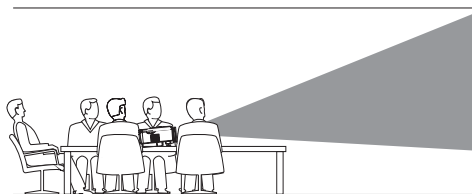

- 2 To adjust projection to the correct position, press  on remote control to access the settings menu, then navigate to select *Projection Mode - Rotate Front*, then press **OK**.

Front ceiling

- 1 Mount the projector on the ceiling with upside up in front of the projection screen. A projector mount is required to mount the projector on ceiling.

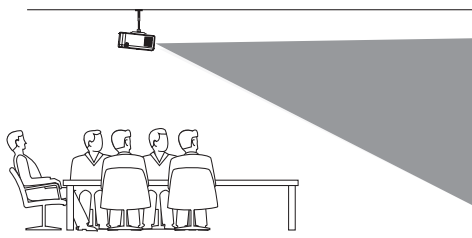

- 2 To adjust projection to the correct position, press  on remote control to access the settings menu, then navigate to select *Projection Mode - Rotate Ceiling*, then press **OK**.

Rear table

- 1 Place the projector on a table behind the projection screen. A special rear projection screen is required.

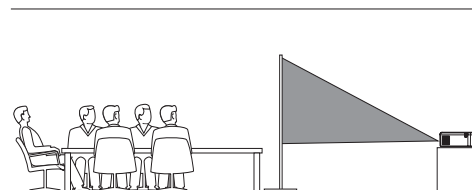



- 2 To adjust projection to the correct position,

press  on remote control to access the settings menu, then navigate to select *Projection Mode - Rotate Rear*, then press **OK**.

Rear ceiling

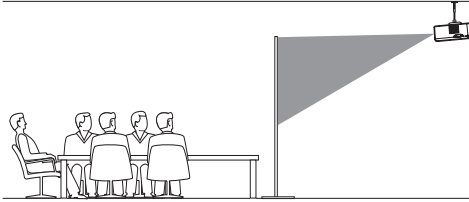
- 1 Mount the projector on ceiling with upside up behind the projection screen. To mount the projector on ceiling behind the screen, a projector mount and a special rear projection screen is required.



- 2 To adjust projection to the correct position, press  on remote control to access the settings menu, then navigate to select *Projection Mode - Rotate Rear Ceiling*, then press **OK**.



5 Other features

Listen through external speakers or headphones

Connect external speakers or headphones to the projector. With this connection, audio from the projector is played through the external speakers or headphones.

DANGER!



Danger of hearing damage!

Before connecting the headphones, turn down the volume on the projector.

Do not use the projector over a longer time at high volume – especially when using headphones. This could lead to hearing damage.

- 1 Use a 3.5 mm audio cable, connect the  connector on the projector to the analogue audio input (3.5 mm jack, or red and white jacks) on the external speakers.

Or connect the  connector on the projector to your headphones.

- The speakers of the projector are deactivated automatically when the external speakers or headphones are connected to the projector.

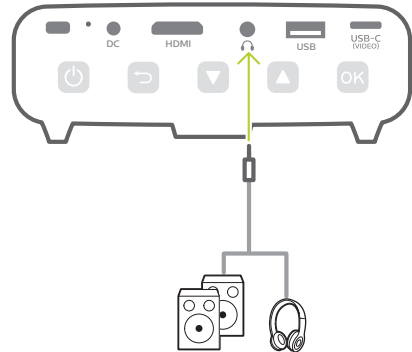

When connecting to the headphones, use the volume control on the remote control (or on the projector) to adjust the volume to a comfortable level.

Charge a USB device

You can charge a USB device (e.g. smartphone, MP3 player or other mobile device).

- 1 Using a USB-A cable, connect your USB device to the **USB** port on the projector.
- 2 Turn on the projector. The USB device starts to charge automatically.

Use HDMI ARC function

This projector supports HDMI with Audio Return Channel (ARC). With ARC feature, you can hear the audio from the connected HDMI ARC device on this projector.

- 1 Make sure the projector is connected to an HDMI device through HDMI ARC connection (**see HDMI connection for image projection, page 7**).
- 2 To activate HDMI ARC function on this projector, press **⚙️** on remote control to access the settings menu, then navigate to select *HDMI ARC - On*.

Use easy link

This projector supports easy link which uses the HDMI CEC (Consumer Electronics Control) protocol. You can use a single remote control to turn on or off the easy link compliant devices that are connected through HDMI. The manufacturer does not guarantee 100% interoperability with all HDMI CEC devices.

- 1 Make sure the projector is connected to an HDMI device which supports HDMI CEC function (**see HDMI connection for image projection, page 7**).
- 2 To activate easy link function on this projector, press **⚙️** on remote control to access the settings menu, then navigate to select *HDMI CEC - On*.



6 Change settings

This section helps you change the settings of the projector.

- 1 When the projector is turned on, press **⚙️** on the remote control (or **OK** on the projector) to access the settings menu.
- 2 Use the **Navigation buttons** and **OK** to select and change settings.



Language settings

Select your desired language for on-screen menu.

- Navigate to *Language*, and press **OK**, then press the **Navigation button** to select a language.

Input source selection

Navigate to *Input Source* to access the following settings.

- *HDMI*: Select it when an HDMI device is connected.
- *USB-C*: Select it when a USB-C device is connected.

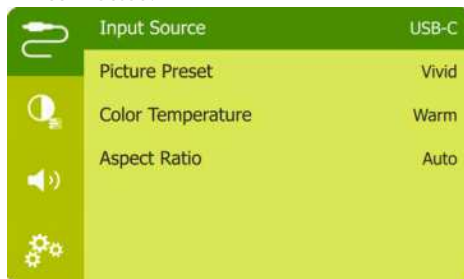

i You need to select a correct input source, so that the projection screen can show images.

Picture settings

You can access the following picture settings.

- **Keystone Correction:** Select an option to correct keystone or distorted images to be rectangular or square.
 - **Auto Keystone:** Enable or disable auto correction of the image shape when tilting the projector upwards or downwards. When *Auto Keystone* is activated, manual keystone correction options will be deactivated.
 - **Manual Keystone:** Manually correct keystone or distorted images in the horizontal orientation.
- **Projection Mode:** Adjust the projection to the correct position based on different installation of the projector.
- **Picture Preset:** Select a predefined color brightness setting for picture and video display, or select *User* to customize color brightness and image clearness.

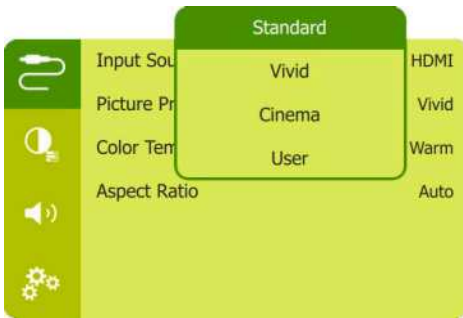

- **Color Temperature:** Set to *Warm* to enhance hotter colors such as red; set to *Cool* to make picture bluish; set to *User* to customize color values in RGB mode.
- **Auto Rotate:** Automatically rotate the projection screen when the projector is detected being rotated.
- **Aspect Ratio:** Select a picture format to fit the projection screen.

Sound settings

Select a preset sound mode or customize sound to suit your video or music.

- Navigate to select *Sound Presets*, and press the **Navigation button** to select a sound mode then press **OK**.

Power control settings

Go to the following menu options to control

power consumption.

- **Brightness:** Select a screen brightness mode.
- **Display Duration:** Select a timer to automatically turn the screen off when the projector is idle.

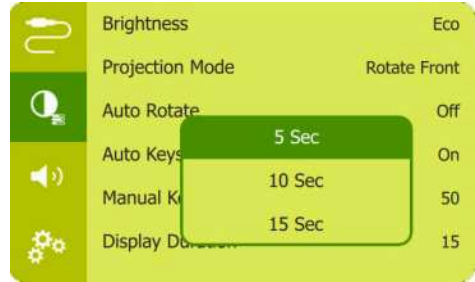

Restore default settings

If the projector does not function normally, reset the projector to the default settings. It will delete all the current settings.

- Navigate to *Factor Restore*, and press **OK**, then follow on-screen instructions to complete resetting.

Other settings

You can also access the following options.

- **Volume:** Adjust volume of the projector.
- **HDMI ARC:** Activate or deactivate HDMI ARC function (see **Use HDMI ARC function, page 12**).
- **HDMI CEC:** Activate or deactivate easy link between the devices through HDMI connection (see **Use easy link, page 12**).



- **Position:** Re-position the settings menu on the projection screen when it appears.
- **Software Version:** Display the current software version of the projector.
- **Firmware Upgrade:** Upgrade system software via a USB device (see **Update software, page 14**).

7 Service

Built-in battery care

The capacity of the built-in battery diminishes with time. You can prolong the life of the battery if you observe the following points:

- Without a power supply, the projector operates on the built-in battery. When the battery does not have sufficient power, the projector turns off. In this case connect the projector to the power supply.
- Charge the battery regularly. Don't store the projector with a completely discharged battery.
- If the projector is not used for several weeks, discharge the battery a little by using the projector before storing it.
- Keep the projector and the battery away from sources of heat.
- If the projector cannot be charged after connecting to the power supply, use a small pin to press the reset key (a small hole) next to the **DC** socket on the projector.

Note about deep discharge of battery

When the built-in battery is in deep discharge, it may take longer for the actual charging process to start. In this case, charge the projector for at least five hours before using it.

DANGER!



Risk of explosion with incorrect type of batteries!

Do not try to replace the built-in battery yourself.

Cleaning

DANGER!



Instructions for cleaning!

Use a soft, lint-free cloth. Never use liquid or easily flammable cleansers (sprays, abrasives, polishes, alcohol, etc.). Do not allow any moisture to reach the interior of the projector. Do not spray the projector with any cleaning fluids.

Wipe over the surfaces gently. Be careful that you do not scratch the surfaces.

Cleaning the lens

Use a soft brush or lens cleaning paper for cleaning the lens of the projector.

DANGER!



Do not use any liquid cleaning agents!

Do not use any liquid cleaning agents for cleaning the lens, to avoid damaging the coating film on the lens.

Update software

The latest software of the projector can be found on www.philips.com/support for you to get the best features and support from the projector.

Before you update the software of the projector, check the current software version:

- Press  on the remote control to access the settings menu then navigate to *SW Version*.

CAUTION!



Do not turn off the projector or remove the USB flash drive during the update.

Update software through USB

- 1 Check the latest software version on www.philips.com/support. Find your product (model number: PPX340, and locate 'Software and drivers'.
- 2 Download the zipped software file, then unzip and save it in the root directory of the USB flash drive.
- 3 Connect the USB flash drive to the USB port on the projector.
 - Recommend to use an external power for software update to ensure enough power supply.

- 4 Press  on the remote control to access the settings menu and navigate to *Firmware Upgrade*, then press **OK**.



- 5 Follow the on-screen instructions to



complete the update.

Troubleshooting

Power cycling

If a problem occurs that cannot be corrected with the instructions in this user manual, follow the steps given here.

- 1 Turn the projector off.
- 2 Wait at least ten seconds.
- 3 Turn the projector on again by holding down  for 1 second.
- 4 If the problem persists, please contact our technical service centre or your dealer.

Problems	Solutions
The projector cannot be turned on or powered.	<ul style="list-style-type: none"> • Disconnect and reconnect the power cable, and try to turn the projector on again. • Low battery power. Connect the projector to an external power supply. • Use the original power adapter.
The projection screen does not show images.	<ul style="list-style-type: none"> • You need to connect the projector to an HDMI device or USB-C device, so that the projection screen can show images (see Connect, page 7). • Select the correct input source. Press  on the remote control to select an input source. • Check if the video output of the external device is turned on.
The projector is charged slowly.	<ul style="list-style-type: none"> • When powered on, the external power will be used first to run the projector and unused power will charge the battery. • For faster charging, charge while the projector is powered off.
The projector turns itself off.	<ul style="list-style-type: none"> • Low battery power. • When the projector is running for a long period of time, the surface becomes hot. Ventilate the projector properly, with at least 30 cm clearness around all the sides of the projector. • Check that the power cable is connected correctly.
The projector cannot be turned off.	<ul style="list-style-type: none"> • Press and hold  longer than 30 seconds.
No image from the external HDMI device.	<ul style="list-style-type: none"> • Disconnect the HDMI cable or switch off the HDMI device. • Wait three seconds. • Reconnect the HDMI cable or switch on the HDMI device again.

Problems	Solutions
No sound from the external connected device.	<ul style="list-style-type: none"> • Check the cables to the external device. • Check that the sound is activated on the external device. • Only the original cables from the device manufacturer may function.
No sound from external HDMI output device.	<ul style="list-style-type: none"> • On the HDMI output device, set the audio setting to Stereo (PCM).
No sound when you connect your computer via HDMI cable.	<ul style="list-style-type: none"> • Check that the sound is activated on the computer and set to output to the projector.
The projector does not react to remote control commands.	<ul style="list-style-type: none"> • Check the batteries of the remote control.
The temperature of the projector's surface is warm.	<ul style="list-style-type: none"> • For this projector it is normal to generate moderate heat during operation.
What to do if the projector does not work when connecting to a notebook PC?	<ul style="list-style-type: none"> • Check that the HDMI cable is plugged in correctly. • Make sure that the notebook PC has been switched to projector display.

8 Appendix

Package content

PicoPix Micro 2 projector, remote control with 2 AAA batteries, AC adapter, power plugs (EU, UK, US), travel pouch, tripod, Quick Start Guide

Technical data

Technology/optical

Display technology	DLP
Light source	OSRAM LED
Resolution	854 x 480 pixel
Resolution supported	1920 x 1080 pixel
LED lifetime	last over 20,000 hours
Contrast ratio	600:1
Aspect ratio	16:9
Throw ratio	1.2:1
Screen size (diagonal).....	10"-80"
Screen distance.....	80cm-200cm / 24"-60"
Projection modes.....	front, back, ceiling, back ceiling
Keystone correction	vertical; auto / manual
Focus adjustment.....	manual
Auto rotate.....	yes

Sound

Internal stereo speaker.....	2 x 3 W
------------------------------	---------

Connection

HDMI.....	x1 with ARC and CEC
USB-C.....	x1 (video)
USB-A 2.0.....	x1 (charging, DC 5V, 1A)
Analog audio output (3.5mm).....	x1
DC jack	x1 (power supply and charging)

Power source

Power supply	power adapter
..... Input:	100-240V~, 50-60Hz, 1.5 A (max)
..... Output:	DC 20 V, 3.25 A, 65 W
Built-in battery	12,000 mAh
.....	last up to 3 hours

Product details

Dimensions (W x D x H).....	138 x 110.5 x 51 mm
.....	5.43 x 4.35 x 2 inches
Weight	600 kg / 1.32 lbs
Operating temperature.....	5 °C - 35 °C
Storage temperature	< 60 °C

CE statement

- The product shall only be connected to a USB interface of version USB 2.0 or higher.
- Adapter shall be installed near the equipment and shall be easily accessible.
- The operating temperature of the EUT can't exceed 35°C and shouldn't be lower than 5°C.
- The plug is considered as disconnect device of adapter.



The Declaration of Compliance can be consulted on the site www.philips.com.

FCC statement

15.19 Labeling requirements.

This device complies with part 15 of the FCC Rules. Operation is subject to the following two conditions: (1) This device may not cause harmful interference, and (2) this device must accept any interference received, including interference that may cause undesired operation.

15.21 Information to the user.

Any changes or modifications not expressly approved by the party responsible for compliance could void the user's authority to operate the equipment.

15.105 Information to user.

This equipment has been tested and found to comply with the limits for a Class B digital device, pursuant to Part 15 of the FCC Rules. These limits are designed to provide reasonable protection against harmful interference in a residential installation. This equipment generates, uses and can radiate radio frequency energy and, if not installed and used in accordance with the instructions, may cause harmful interference to radio communications. However, there is no guarantee that interference will not occur in a particular installation. If this equipment does cause harmful interference to radio or television reception, which can be determined by turning the equipment off and on, the user is encouraged to try to correct the interference by one or more of the following measures:

- Reorient or relocate the receiving antenna.
- Increase the separation between the equipment and receiver.
- Connect the equipment into an outlet on a circuit different from that to which the receiver is connected.
- Consult the dealer or an experienced radio/TV technician for help.

FCC ID: 2ASRT-PPX340

Canada regulatory compliance

This device complies with Industry Canada CAN ICES-3 (B)/NMB-3(B)

RSS-Gen & RSS-247 statement: This device complies with Industry Canada RSS standard(s).

Operation is subject to the following two conditions:

- 1 This device may not cause interference, and
- 2 This device must accept any interference, including interference that may cause undesired operation of the device.

Other notice

Preservation of the environment as part of a sustainable development plan is an essential concern of Screeneo Innovation SA. The desire of Screeneo Innovation SA is to operate systems respecting the environment and consequently it has decided to integrate environmental performances in the life cycle of these products, from manufacturing to commissioning use and elimination.



Packaging: The presence of the logo (green dot) means that a contribution is paid to an approved national organisation to improve package recovery and recycling infrastructures. Please respect the sorting rules set up locally for this kind of waste.

Batteries: If your product contains batteries, they must be disposed of at an appropriate collection point.



Product: The crossed-out waste bin symbol on the product means that the product belongs to the family of electrical and electronic equipment. In this respect, the European regulations ask you to dispose of it selectively:

- At sales points in the event of the purchase of similar equipment.
- At the collection points made available to you locally (drop-off centre, selective collection, etc.).

In this way you can participate in the reuse and upgrading of Electrical and Electronic Equipment Waste, which can have an effect on the environment and human health.

The paper and cardboard packaging used can be disposed of as recyclable paper. Have the plastic wrapping recycled or dispose of it in the non-recyclable waste, depending on the requirements in your country.

Trademarks: The mentioned references in this manual are trademarks of the respective companies. The lack of the trademarks ® and ™ does not justify the assumption that these dedicated terminologies are free trademarks. Other product names used herein are for identification purposes only and may be trademarks of their respective owners. Scree neo Innovation SA disclaims any and all rights in those marks.

Neither Scree neo Innovation SA nor its affiliates shall be liable to the purchaser of this product or third parties for damages, losses, costs, or expenses incurred by the purchaser or third parties as a result of accident, misuse, or abuse of this product or unauthorised modifications, repairs, or alterations to this product, or failure to strictly comply with Scree neo Innovation SA operating and maintenance instructions.

Scree neo Innovation SA shall not be liable for any damages or problems arising from the use of any options or any consumable materials other than those designated as original Scree neo Innovation SA/PHILIPS products or Scree neo Innovation SA/PHILIPS approved products.

Scree neo Innovation SA shall not be held liable for any damage resulting from electromagnetic interference that occurs from the use of any interface cables other than those designated as

Scree neo Innovation SA/PHILIPS products.

All rights reserved. No part of this publication may be reproduced, stored in a retrieval system or transmitted in any form or by any means, electronic, mechanical, photocopying, recording, or otherwise, without the prior written permission of Scree neo Innovation SA. The information contained herein is designed only for use with this product. Scree neo Innovation SA is not responsible for any use of this information as applied to other devices.

This user manual is a document that does not represent a contract.

Errors, printing errors and changes are reserved. Copyright © 2020 Scree neo Innovation SA.



Screeneo Innovation SA

Route de Lully 5c - 1131 Tolochenaz - Switzerland

Philips and the Philips Shield Emblem are registered trademarks of Koninklijke Philips N.V. used under license. Screeneo Innovation SA is the warrantor in relation to the product with which this booklet was packaged.