

## F80



User Manual

## **Product revision**

Software Revision: 2.1

### **Barco Fredrikstad AS**

Haborneveien 53, N-1630 Gamle Fredrikstad, Norway  
Support.fre@barco.com  
www.barco.com

### **Registered office: Barco NV**

President Kennedypark 35, 8500 Kortrijk, Belgium  
www.barco.com/en/support  
www.barco.com

## Copyright ©

All rights reserved. No part of this document may be copied, reproduced or translated. It shall not otherwise be recorded, transmitted or stored in a retrieval system without the prior written consent of Barco.

## Changes

Barco provides this manual 'as is' without warranty of any kind, either expressed or implied, including but not limited to the implied warranties or merchantability and fitness for a particular purpose. Barco may make improvements and/or changes to the product(s) and/or the program(s) described in this publication at any time without notice.

This publication could contain technical inaccuracies or typographical errors. Changes are periodically made to the information in this publication; these changes are incorporated in new editions of this publication.

The latest edition of Barco manuals can be downloaded from the Barco web site [www.barco.com](http://www.barco.com) or from the secured Barco web site <https://www.barco.com/en/signin>.

## Trademarks

Brand and product names mentioned in this manual may be trademarks, registered trademarks or copyrights of their respective holders. All brand and product names mentioned in this manual serve as comments or examples and are not to be understood as advertising for the products or their manufacturers.

## Guarantee and Compensation

Barco provides a guarantee relating to perfect manufacturing as part of the legally stipulated terms of guarantee. On receipt, the purchaser must immediately inspect all delivered goods for damage incurred during transport, as well as for material and manufacturing faults Barco must be informed immediately in writing of any complaints.

The period of guarantee begins on the date of transfer of risks, in the case of special systems and software on the date of commissioning, at latest 30 days after the transfer of risks. In the event of justified notice of complaint, Barco can repair the fault or provide a replacement at its own discretion within an appropriate period. If this measure proves to be impossible or unsuccessful, the purchaser can demand a reduction in the purchase price or cancellation of the contract. All other claims, in particular those relating to compensation for direct or indirect damage, and also damage attributed to the operation of software as well as to other services provided by Barco, being a component of the system or independent service, will be deemed invalid provided the damage is not proven to be attributed to the absence of properties guaranteed in writing or due to the intent or gross negligence or part of Barco.

If the purchaser or a third party carries out modifications or repairs on goods delivered by Barco, or if the goods are handled incorrectly, in particular if the systems are operated incorrectly or if, after the transfer of risks, the goods are subject to influences not agreed upon in the contract, all guarantee claims of the purchaser will be rendered invalid. Not included in the guarantee coverage are system failures which are attributed to programs or special electronic circuitry provided by the purchaser, e.g. interfaces. Normal wear as well as normal maintenance are not subject to the guarantee provided by Barco either.

The environmental conditions as well as the servicing and maintenance regulations specified in this manual must be complied with by the customer.

## Federal Communications Commission (FCC Statement)

This equipment has been tested and found to comply with the limits for a class A digital device, pursuant to Part 15 of the FCC rules. These limits are designed to provide reasonable protection against harmful interference when the equipment is operated in a commercial environment. This equipment generates, uses, and can radiate radio frequency energy and, if not installed and used in accordance with the instruction manual, may cause harmful interference to radio communications. Operation of this equipment in a residential area may cause harmful interference, in which case the user will be responsible for correcting any interference at his own expense

Changes or modifications not expressly approved by the party responsible for compliance could void the user's authority to operate the equipment

FCC responsible: Barco Inc.  
3059 Premiere Parkway Suite 400  
30097 Duluth GA, United States  
Tel: +1 678 475 8000

## Patent protection

Please refer to [www.barco.com/about-barco/legal/patents](http://www.barco.com/about-barco/legal/patents)

## EMC statements

### EN55032/CISPR32 Class A MME (MultiMedia Equipment)

**Warning** : This equipment is compliant with Class A of CISPR 32. In a residential environment this equipment may cause radio interference.

### Class A ITE (Information Technology Equipment)

**Warning** : This is a class A product. In a domestic environment this product may cause radio interference in which case the user may be required to take adequate measures.

警告使用者: 此為甲類資訊技術設備，於居住環境中使用時，可能會造成射頻擾動，在此種情況下，使用者會被要求採取某些適當的對策。

## Disclaimer for camera usage

Barco provides a kit with a laser range finder and USB camera to help measure the distance from the front of the projector to the projected surface and to help monitor the performance of the projector. Barco disclaims any liability for any use of the USB camera outside this intended use.

## Disclaimer for network usage

Barco highly recommends to install the projector in a **closed network** environment to minimize the risk of leaking, hacking or corrupting of company confidential information; commercial sensitive information and/or personal data. Furthermore, strengthen your network security to protect the projector against unauthorized access by third parties. To the maximum extent permitted by law, Barco disclaims any liability for the use of the projector in an open network environment.

# Table of contents

<b>1</b>	<b>Safety</b>	<b>9</b>
1.1	General considerations	10
1.2	Important safety instructions	11
1.3	Product safety labels	14
1.4	Risk Group 3 Safety	16
1.4.1	General considerations	16
1.4.2	High Brightness precautions: Hazard Distance (HD)	17
1.4.3	HD for fully enclosed projection systems	19
1.4.4	HD in function of the lens Throw Ratio (TR)	20
<b>2</b>	<b>Remote Control Unit</b>	<b>21</b>
2.1	Remote control, battery installation	22
2.2	Using the mini-jack connector of the RCU	23
2.3	Remote control, on/off button	23
<b>3</b>	<b>Input &amp; Communication</b>	<b>25</b>
3.1	Introduction	26
3.2	Connection Panel	26
3.3	Making connections	27
3.4	Connector specifications	27
3.4.1	DVI-I	27
3.4.2	Display Port 1.2	28
3.4.3	HDMI 2.0	28
3.4.4	SDI	29
3.4.5	HDBase T	29
3.4.6	High-bandwidth Digital Content Protection (HDCP)	30
3.5	Control interfaces	30
3.5.1	RS-232	30
3.5.2	LAN/Ethernet	31
3.5.3	USB-A port	31
3.5.4	DMX	31
3.6	LED and Button indication chart	31
<b>4</b>	<b>Getting Started</b>	<b>33</b>
4.1	Local Keypad and LCD panel	34
4.2	Power modes	34
4.3	Power mode transitions	35

4.3.1	General .....	35
4.3.2	Power on projector .....	35
4.3.3	Going from READY to ON.....	36
4.3.4	Going from ON to READY .....	36
4.3.5	Going from READY to ECO standby.....	36
4.3.6	Going from ECO to ON .....	36
4.3.7	Wake on LAN (WOL) .....	36
4.4	Status overview.....	37
4.5	Power off projector .....	37
4.6	Increasing the projector life time .....	38
4.7	Operation in 24/7 Mode .....	38
4.8	Using the RCU.....	38
4.9	Projector Address .....	40
4.9.1	Controlling the projector .....	40
4.10	Quick setup via Direct access.....	41
<b>5</b>	<b>GUI – Introduction .....</b>	<b>43</b>
5.1	Overview .....	44
5.2	Navigation .....	45
5.3	Test Patterns.....	47
<b>6</b>	<b>GUI – Source .....</b>	<b>49</b>
6.1	Displaying a single source .....	50
6.2	Displaying multiple sources: Stitched layouts.....	50
6.3	Connector Settings .....	51
<b>7</b>	<b>GUI – Image.....</b>	<b>55</b>
7.1	Setting image levels manually .....	56
7.2	Adjusting the sharpness.....	57
7.3	Adjusting the gamma correction .....	58
7.4	Setting the desired Gamma type.....	59
7.5	Digital Shift & Zoom .....	61
7.6	RealColor P7 .....	65
7.7	Setting the output resolution .....	67
7.8	BrilliantColor™ .....	68
7.9	Displaying HDR content .....	69
<b>8</b>	<b>GUI – Installation.....</b>	<b>71</b>
8.1	Configuring the lens, optical zoom-focus .....	72
8.2	Configuring the lens, shift.....	72
8.3	Configuring the lens, Shift to center .....	73
8.4	Configuring the lens, tilt sensor.....	74
8.5	Manipulating the rigging frame .....	74
8.6	Manipulating the rigging frame, center position .....	76
8.7	Orientation .....	77
8.8	Scaling modes .....	77
8.9	Warping .....	79
8.9.1	Warping – On/Off.....	79
8.9.2	Warping – Screen Size.....	80
8.9.3	Warping – 4 corners adjustment.....	82
8.9.4	Warping – Bow.....	83
8.9.5	Warping – Warp files .....	88
8.9.6	Warping – Latency control in a multi projector setup .....	89
8.10	Blending & masking.....	91

8.10.1	Basic blend .....	91
8.10.2	Blend & Blend mask .....	93
8.10.3	Blend Files .....	95
8.10.4	Basic black level adjustment .....	96
8.10.5	RGB gain adjustment.....	98
8.10.6	Black Level Files.....	99
8.11	Illumination .....	100
8.12	3D projection .....	101
8.12.1	Active Stereo & Passive Stereo .....	101
8.12.2	Setup process 3D projection .....	102
8.12.3	Connection possibilities.....	102
8.12.4	3D Setup .....	103
<b>9</b>	<b>GUI – Macro’s and projector profiles .....</b>	<b>105</b>
9.1	Saving the current projector settings in a profile .....	106
9.2	Assigning a created projector profile to a preset .....	108
9.3	Deleting a projector profile .....	109
<b>10</b>	<b>GUI – System Settings .....</b>	<b>111</b>
10.1	Communication .....	112
10.1.1	Introduction to a Network connection .....	112
10.1.2	Wired IP address set up .....	112
10.2	IR control.....	114
10.2.1	Broadcast address .....	114
10.2.2	Projector address.....	115
10.2.3	IR sensors .....	116
10.3	Setting a custom projector name .....	117
10.4	DMX.....	118
10.5	Changing the User Interface language .....	119
10.6	Themes.....	120
10.7	Setting the measurement system .....	120
10.8	ECO mode .....	121
10.9	Power settings .....	121
10.10	Lens features.....	122
10.11	Controlling the backlight of the LCD Display .....	123
10.12	Factory reset.....	124
10.13	Lens Calibration.....	126
10.14	Operational mode .....	128
10.15	Advanced Settings .....	129
10.15.1	Remote access – Enable source preview .....	129
10.15.2	Remote access – Enable camera preview.....	130
10.15.3	Service – Color Wheel.....	131
10.15.4	Advanced Settings – Color .....	132
10.15.5	Advanced Settings – Statistics .....	133
10.15.6	Advanced Settings – Pixel Shift .....	134
10.15.7	Checking the status of the Laser Banks.....	135
10.15.8	Advanced settings – Tilt sensor calibration .....	137
<b>11</b>	<b>GUI – Status menu .....</b>	<b>139</b>
11.1	Status menu overview .....	140
<b>12</b>	<b>Maintenance .....</b>	<b>143</b>
12.1	Cleaning the lens .....	144
12.2	Cleaning the exterior of the projector.....	144

12.3	Filters .....	144
<b>A</b>	<b>Specifications .....</b>	<b>145</b>
A.1	Specifications of the F80-Q7 .....	146
A.2	Specifications of the F80-Q9 .....	147
A.3	Specifications of the F80-Q12 .....	149
A.4	Specifications of the F80-4K7 .....	150
A.5	Specifications of the F80-4K9 .....	152
A.6	Specifications of the F80-4K12 .....	153
A.7	Dimensions of a F80 .....	155
A.8	Technical Regulations .....	156
<b>B</b>	<b>Environmental information.....</b>	<b>157</b>
B.1	Disposal information.....	158
B.2	China RoHS compliance.....	158
B.3	Taiwan RoHS compliance.....	160
B.4	Turkey RoHS compliance.....	161
B.5	Production address.....	161
B.6	Contact information.....	161
B.7	Product Info (Taiwan).....	162
B.8	Download Product Manual .....	162
<b>C</b>	<b>Overview video timings for video interfaces .....</b>	<b>163</b>
C.1	Overview video timings.....	164
C.2	Overview video timings SDI Inputs .....	165
C.3	Overview video timings HDMI 2.0 inputs .....	166
C.4	Overview video timings DisplayPort 1.2 inputs .....	167
C.5	Overview video timings HDBaseT input.....	169
C.6	Overview video timings DVI Inputs .....	170
<b>D</b>	<b>DMX chart.....</b>	<b>173</b>
D.1	DMX chart, Basic .....	174
D.2	DMX chart, Extended.....	174



# Safety

# 1

1.1	General considerations .....	10
1.2	Important safety instructions .....	11
1.3	Product safety labels.....	14
1.4	Risk Group 3 Safety.....	16

## About this document

Read this document attentively. It contains important information to prevent personal injury while installing and using the F80 projector. Furthermore, it includes several cautions to prevent damage to the F80 projector. Ensure that you understand and follow all safety guidelines, safety instructions and warnings mentioned in this chapter before installing the F80 projector.

## Clarification of the term “F80” used in this document

When referring in this document to the term “F80” means that the content is applicable for following Barco products:

- F80-Q7, F80-Q9, F80-Q12, F80-4K7, F80-4K9, F80-4K12

## Model certification name

- GPC

## 1.1 General considerations

### General safety instructions

- Before operating this equipment please read this manual thoroughly and retain it for future reference.
- Installation and preliminary adjustments should be performed by qualified Barco personnel or by authorized Barco service dealers.
- All warnings on the projector and in the documentation manuals should be adhered to.
- All instructions for operating and use of this equipment must be followed precisely.
- All local installation codes should be adhered to.

### Notice on safety

This equipment is built in accordance with the requirements of the international safety standards IEC60950-1, as basis for National safety regulation world wide. The safety standard covers information technology equipment including electrical business equipment intended to operate in “normal” environments (offices and homes). This safety standard imposes important requirements on the use of safety critical components, materials and insulation, in order to protect the user or operator against risk of electric shock and energy hazard and having access to live parts. Safety standards also impose limits to the internal and external temperature rises, radiation levels, mechanical stability and strength, enclosure construction and protection against the risk of fire. Simulated single fault condition testing reduce the risk of hazards and contribute to ensure the safety of the equipment to the user even when the equipment’s normal operation fails.

### Notice on optical radiation

This projector embeds extremely high brightness (radiance) lasers; this laser light is processed through the projectors optical path. Native laser light is not accessible by the end user in any use case. The light exiting the projection lens has been diffused within the optical path, representing a larger source and lower radiance value than native laser light. Nevertheless the projected light represents a significant risk for the human eye when exposed directly within the beam. This risk is not specific related to the characteristics of laser light but solely to the high thermal induced energy of the light source; which is equivalent with lamp based systems.

Thermal retinal eye injury is possible when exposed within the Hazard Distance (HD). The HD is defined from the projection lens surface towards the position of the projected beam where the irradiance equals the maximum permissible exposure as described in the chapter “Hazard Distance”.

### Notice on optical radiation (addendum)

- F80-Q12, F80-4K12:
  - The projector is Class 1 laser product that conforms with IEC EN 60825-1:2014. The projector conforms with IEC 60825–1:2007, and with performance standards for laser products under 21 CFR 1040, except with respect to those characteristics authorized by Variance Number 2017-V-4837 effective September 13, 2017 Do not stare into Beam.
  - This projector is Risk Group 2 (RG2) according to IEC EN 62471-5. This projector may become Risk Group 3 (RG3) when an interchangeable lens with throw ratio greater than 2.2 is installed. Refer to the manual for the lens list and throw ratio before operation. Such combination of projector and lens are intended for professional use only, and are not intended for consumer use. Safety considerations for RG3 projectors are discussed in section “[Risk Group 3 Safety](#)”, [page 16](#).
  - This projector has one or several built-in Class 4 laser clusters. Disassembly or modification is very dangerous and should never be attempted.
- F80-Q9, F80-4K9:
  - The projector is Class 1 laser product that conforms with IEC EN 60825-1:2014. The projector conforms with IEC 60825–1:2007, and with performance standards for laser products under 21 CFR 1040, except with respect to those characteristics authorized by Variance Number 2017-V-4837 effective September 13, 2017 Do not stare into Beam.
  - This projector is Risk Group 2 (RG2) according to IEC EN 62471-5. This projector may become Risk Group 3 (RG3) when an interchangeable lens with throw ratio greater than 2.8 is installed. Refer to the manual for the lens list and throw ratio before operation. Such combination of projector and lens are intended for professional use only, and are not intended for consumer use. Safety considerations for RG3 projectors are discussed in section “[Risk Group 3 Safety](#)”, [page 16](#).
  - This projector has one or several built-in Class 4 laser clusters. Disassembly or modification is very dangerous and should never be attempted.

- F80-Q7, F80-4K7:
  - The projector is Class 1 laser product that conforms with IEC EN 60825-1:2014. The projector conforms with IEC 60825-1:2007, and with performance standards for laser products under 21 CFR 1040, except with respect to those characteristics authorized by Variance Number 2017-V-4837 effective September 13, 2017 Do not stare into Beam.
  - This projector is Risk Group 2 (RG2) according to IEC EN 62471-5. This projector may become Risk Group 3 (RG3) when an interchangeable lens with throw ratio greater than 3.5 is installed. Refer to the manual for the lens list and throw ratio before operation. Such combination of projector and lens are intended for professional use only, and are not intended for consumer use. Safety considerations for RG3 projectors are discussed in section [“Risk Group 3 Safety”, page 16](#).
  - This projector has one or several built-in Class 4 laser clusters. Disassembly or modification is very dangerous and should never be attempted.

## Users definition

Throughout this manual, the term SERVICE PERSONNEL refers to Barco authorized persons having appropriate technical training and experience necessary to be knowledgeable of potential hazards to which they are exposed (including, but not limited to HIGH VOLTAGE ELECTRIC and ELECTRONIC CIRCUITRY and HIGH BRIGHTNESS PROJECTORS) in performing a task, and of measures to minimize the potential risk to themselves or other persons. Only Barco authorized SERVICE PERSONNEL, knowledgeable of such risks, are allowed to perform service functions inside the product enclosure. The term USER and OPERATOR refers to any person other than SERVICE PERSONNEL. When installing an interchangeable lens with a throw ratio that make the projector become RG3, refer to chapter [“Risk Group 3 Safety”, page 16](#). Such combination of projector and lens are intended for professional use only, and are not intended for consumer use.

FOR PROFESSIONAL USE ONLY means installation can only be carried out by Barco AUTHORIZED PERSONNEL familiar with potential hazards associated with high intensity light beams.

## 1.2 Important safety instructions

### To prevent the risk of electrical shock

- This product should be operated from a mono phase AC power source.
- This apparatus must be grounded (earthed) via the supplied 3 conductor AC power cable. If none of the supplied power cables are the correct one, consult your dealer. If you are unable to insert the plug into the outlet, contact your electrician to replace your obsolete outlet. Do not defeat the purpose of the grounding-type plug. Never use 2-prong power cords, as this is dangerous and could lead to electrical shock.
- Do not allow anything to rest on the power cord. Do not locate this product where persons will walk on the cord. To disconnect the cord, pull it out by the plug. Never pull the cord itself.
- Use only the power cord supplied with your device. While appearing to be similar, other power cords have not been safety tested at the factory and may not be used to power the device. For a replacement power cord, contact your dealer.
- Do not operate the projector with a damaged cord. Replace the cord.
- Do not operate the projector if the projector has been dropped or damaged - until it has been examined and approved for operation by qualified service personnel.
- Position the cord so that it will not be tripped over, pulled, or contact hot surfaces.
- If an extension cord is necessary, a cord with a current rating at least equal to that of the projector should be used. A cord rated for less amperage than the projector may overheat.
- Never push objects of any kind into this product through cabinet slots as they may touch dangerous voltage points or short out parts that could result in a risk of fire or electrical shock.
- Make sure that no objects enter into the vents and openings of the set.
- Do not expose this projector to rain or moisture.
- The projector is designed for indoor use only. Never operate the unit outdoors.
- Do not immerse or expose this projector in water or other liquids.
- Do not spill liquid of any kind on this projector.
- Should any liquid or solid object fall into the cabinet, unplug the set and have it checked by qualified service personnel before resuming operations.
- Do not disassemble this projector, always take it to qualified service personnel when service or repair work is required.
- Do not use an accessory attachment which is not recommended by the manufacturer.

- Lightning - For added protection for this video product during a lightning storm, or when it is left unattended and unused for long periods of time, unplug it from the wall outlet. This will prevent damage to the device due to lightning and AC power-line surges.

## To prevent personal injury

- To prevent injury and physical damage, always read this manual and all labels on the system before powering the projector or adjusting the projector.
- To prevent injury, take note of the weight of the projector. Minimum 2 persons are needed to carry the projector. The projector weights about  $\pm 26$  kg ( $\pm 57$  lbs) without lens and rigging frame.
- To prevent injury, ensure that the lens and all covers are correctly installed. See installation procedures.
- Warning: high intensity light beam. NEVER look into the lens ! High luminance could result in damage to the eye.
- **Warning: extremely high brightness projector:** This projector embeds extremely high brightness (radiance) lasers; this laser light is processed through the projectors optical path. Native laser light is not accessible by the end user in any use case. The light exiting the projection lens has been diffused within the optical path, representing a larger source and lower radiance value than native laser light. Nevertheless the projected light represents a significant risk for the human eye when exposed directly within the beam. This risk is not specific related to the characteristics of laser light but solely to the high thermal induced energy of the light source; which is comparable with lamp based systems. Thermal retinal eye injury is possible when exposed within the Hazard Distance. The Hazard Distance (HD) is defined from the projection lens surface towards the position of the projected beam where the irradiance equals the maximum permissible exposure as described in the chapter "[High Brightness precautions: Hazard Distance \(HD\)](#)", page 17.
- Based on international requirements, no person is allowed to enter the projected beam within the zone between the projection lens and the related Hazard Distance (HD). This shall be physically impossible by creating sufficient separation height or by placing optional barriers. Within the restricted area operator training is considered sufficient. The applicable separation heights are discussed in "[High Brightness precautions: Hazard Distance \(HD\)](#)", page 17.
- Don't put your hand in front of the beam.
- This product contains no user serviceable parts. Attempts to modify/replace mechanics or electronics inside the housing or compartments will violate any warranties and may be hazardous.
- A special device ("rigged frame") based on an external frame must be used when the projector is deployed in a hanging configuration, or when several projector must be stacked. See installation manuals for the correct use of these devices.
- Do not place this equipment on an unstable cart, stand, or table. The product may fall, causing serious damage to it and possible injury to the user.
- It is hazardous to operate without lens or shield. Lenses, shields or ultra violet screens shall be changed if they have become visibly damaged to such an extent that their effectiveness is impaired. For example by cracks or deep scratches.
- **Cooling liquid circuit.** The projector contains a cooling circuit filled with Green Ethylene glycol diluted (53% Glycol – 47% Demi water). When the cooling circuit leaks, switch off the device and contact qualified service personnel. The liquid is not for household use. Keep out of reach of children. Harmful by oral intake. Avoid exposure to pregnant women. Avoid contact with eyes, skin and clothing. Avoid inhale of the noxious fumes.
- Never point or allow light to be directed on people or reflective objects within the HD zone.
- All operators shall have received adequate training and be aware of the potential hazards.
- In case of using an external cooling system position the hoses of the cooling system so that they will not be tripped over, pulled, or contact hot surfaces.

## To prevent fire hazard

- Do not place flammable or combustible materials near the projector!
- Barco projection products are designed and manufactured to meet the most stringent safety regulations. This projector radiates heat on its external surfaces and from ventilation ducts during normal operation, which is both normal and safe. Exposing flammable or combustible materials into close proximity of this projector could result in the spontaneous ignition of that material, resulting in a fire. For this reason, it is absolutely necessary to leave an "exclusion zone" around all external surfaces of the projector whereby no flammable or combustible materials are present. The exclusion zone in the exhaust area must be not less than 100 cm (40"). The exclusion zone on the intake area must be not less than 50 cm (20").
- Do not place any object in the projection light path at close distance to the projection lens output. The concentrated light at the projection lens output may result in damage, fire or burn injuries.

- Do not cover the projector or the lens with any material while the projector is in operation. Keep flammable and combustible materials away from the projector at all times. Mount the projector in a well ventilated area away from sources of ignition and out of direct sun light. Never expose the projector to rain or moisture. In the event of fire, use sand, CO<sub>2</sub> or dry powder fire extinguishers. Never use water on an electrical fire. Always have service performed on this projector by authorized Barco service personnel. Always insist on genuine Barco replacement parts. Never use non-Barco replacement parts as they may degrade the safety of this projector.
- Ensure no misalignment can occur. Prolonged exposure of wooden walls at close distance (< 20 cm) can represent a fire risk. After alignment the projector shall be securely mounted to the pedestal.
- Slots and openings in this equipment are provided for ventilation. To ensure reliable operation of the projector and to protect it from overheating, these openings must not be blocked or covered. The openings should never be blocked by placing the projector too close to walls, or other similar surface. This projector should never be placed near or over a radiator or heat register. This projector should not be placed in a built-in installation or enclosure unless proper ventilation is provided.
- Projection rooms must be well ventilated or cooled in order to avoid build up of heat. It is necessary to vent hot exhaust air from projector and cooling system to the outside of the building.
- Let the projector cool completely before storing. Remove cord from the projector when storing.

### To prevent projector damage

- Always remove lens cap before switching on the projector. If the lens cap is not removed, it may melt due to the high energy light emitted through the lens. Melting the lens cap may permanently damage the surface of the projection lens.
- The air inlets of the projector must be cleaned on a regular basis. Cleaning the booth area would be monthly-minimum. Neglecting this could result in disrupting the air flow inside the projector, causing overheating. Overheating may lead to the projector shutting down during operation.
- The projector must always be installed in a manner which ensures free flow of air into its air inlets.
- If more than one projector is installed in a common projection booth, the exhaust air flow requirements are valid for EACH individual projector system. Note that inadequate air extraction or cooling will result in decreased life expectancy of the projector as a whole as well as causing premature failure of the lasers.
- In order to ensure that correct airflow is maintained, and that the projector complies with Electromagnetic Compatibility (EMC) and safety requirements, it should always be operated with all of its covers in place.
- Slots and openings in the cabinet are provided for ventilation. To ensure reliable operation of the product and to protect it from overheating, these openings must not be blocked or covered. The openings should never be blocked by placing the product on a bed, sofa, rug, or other similar surface. This product should never be placed near or over a radiator or heat register. The device should not be placed in a built-in installation or enclosure unless proper ventilation is provided.
- Ensure that nothing can be spilled on, or dropped inside the projector. If this does happen, switch off and remove all power from the projector. Do not operate the projector again until it has been checked by qualified service personnel.
- Do not block the projector cooling fans or free air movement around the projector.
- Do not use this equipment near water.
- **Special care for Laser Beams:** Special care should be used when DLP projectors are used in the same room as high power laser equipment. Direct or indirect hitting of a laser beam on to the lens can severely damage the Digital Mirror Devices™ in which case there is a loss of warranty.
- Never place the projector in direct sunlight. Sunlight on the lens can severely damage the Digital Mirror Devices™ in which case there is a loss of warranty.
- Save the original shipping carton and packing material. They will come in handy if you ever have to ship your equipment. For maximum protection, repack your set as it was originally packed at the factory.
- Unplug this product from the wall outlet before cleaning. Do not use liquid cleaners or aerosol cleaners. Use a damp cloth for cleaning. Never use strong solvents, such as thinner or benzine, or abrasive cleaners, since these will damage the cabinet. Stubborn stains may be removed with a cloth lightly dampened with mild detergent solution.
- To ensure the highest optical performance and resolution, the projection lenses are specially treated with an anti-reflective coating, therefore, avoid touching the lens. To remove dust on the lens, use a soft dry cloth. For lens cleaning follow the instructions precisely as stipulated in the projector manual.
- Only connect the projector to signal sources and voltages as described in the technical specification. Connecting to unspecified signal sources or voltages may lead to malfunction and permanent damage of the unit.
- Allowed ambient temperature range:  $t_a = 10^{\circ}\text{C}$  (50°F) to  $40^{\circ}\text{C}$  (104°F)
- Rated humidity = 20% RH to 80% RH Non-condensed.

- Do not operate the projector outside its temperature and humidity specifications as this may result in overheating and malfunction.

### On servicing





- Do not attempt to service this product yourself. This product contains no user serviceable parts except parts describe in the User manual. Attempts to modify/replace mechanics or electronics inside the housing or compartments will violate any warranties and may expose you to dangerous voltage potentials, risk of electric shock and retinal eye injury.
- Refer all servicing to Barco authorized repair centers.
- Attempts to alter the factory-set internal controls or to change other control settings not specially discussed in this manual can lead to permanent damage to the projector and cancellation of the warranty.
- Remove all power from the projector and refer servicing to Barco authorized repair center under the following conditions:
  - When the power cord or plug is damaged or frayed.
  - If liquid has been spilled into the equipment.
  - If the product has been exposed to rain or water.
  - If the product does not operate normally when the operating instructions are followed. Adjust only those controls that are covered by the operating instructions since improper adjustment of the other controls may result in damage and will often require extensive work by a qualified technician to restore the product to normal operation.
  - If the product has been dropped or the cabinet has been damaged.
  - If the product exhibits a distinct change in performance, indicating a need for service.
- Replacement parts: When replacement parts are required, be sure the service technician has used original Barco replacement parts or authorized replacement parts which have the same characteristics as the Barco original part. Unauthorized substitutions may result in degraded performance and reliability, fire, electric shock or other hazards. Unauthorized substitutions may void warranty.
- Safety check: Upon completion of any service or repairs to this projector, ask the service technician to perform safety checks to determine that the product is in proper operating condition.

### Safety Data Sheets for Hazardous Chemicals

For safe handling information on chemical products, consult the Safety Data Sheet (SDS). SDSs are available upon request via [safetydatasheets@barco.com](mailto:safetydatasheets@barco.com).

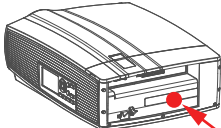
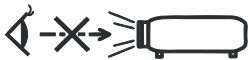
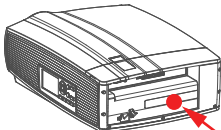
## 1.3 Product safety labels

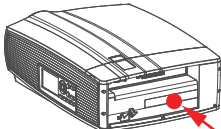
### Light beam related safety labels

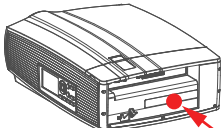
Label image	Label description	Label location
	Refer to user manual for further information!	
	Caution! Do not stare into beam, RG2 product.	
	Hazard RG3: not for household use symbol.	
	Hazard RG3: optical radiation warning symbol.	

**Label image**                      **Label description**                      **Label location**

**For F80-Q7, F80-4K7:**

<p>For North America: THIS PRODUCT IS IN CONFORMITY WITH PERFORMANCE STANDARDS FOR LASER PRODUCTS UNDER 21 CFR 1040, EXCEPT WITH RESPECT TO THOSE CHARACTERISTICS AUTHORIZED BY VARIANCE NUMBER 2017-V-4837 EFFECTIVE SEPTEMBER 13, 2017.</p> 	<p>This projector may become RG3 when an interchangeable lens with throw ratio greater than 3.5 is installed. Refer to the manual for the lens list and hazard distance before operation. Such combinations of projector and lens are intended for professional use only, and are not intended for consumer use.</p> <p>Ce projecteur peut devenir un projecteur RG3 en cas d'installation d'un objectif interchangeable dont le rapport de projection est supérieur à 3.5. Veuillez vous reporter au manuel pour en savoir plus sur la liste des objectifs et la distance de sécurité avant toute utilisation. De telles combinaisons entre projecteur et objectif sont conçues pour des applications professionnelles uniquement et pas pour des applications grand public.</p> <p>本投影机安装透射比大于3.5的可换镜头后，可成为RG3，操作前，请参考手册中镜头清单和危险距离。本投影机与镜头组合仅供专业使用，非普通消费者使用。</p>
---	--

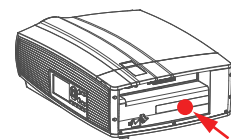

For North America: THIS PRODUCT IS IN CONFORMITY WITH PERFORMANCE STANDARDS FOR LASER PRODUCTS UNDER 21 CFR 1040, EXCEPT WITH RESPECT TO THOSE CHARACTERISTICS AUTHORIZED BY VARIANCE NUMBER 2017-V-4837 EFFECTIVE SEPTEMBER 13, 2017.

This projector may become RG3 when an interchangeable lens with throw ratio greater than 3.5 is installed. Refer to the manual for the lens list and hazard distance before operation. Such combinations of projector and lens are intended for professional use only, and are not intended for consumer use.

Ce projecteur peut devenir un projecteur RG3 en cas d'installation d'un objectif interchangeable dont le rapport de projection est supérieur à 3.5. Veuillez vous reporter au manuel pour en savoir plus sur la liste des objectifs et la distance de sécurité avant toute utilisation. De telles combinaisons entre projecteur et objectif sont conçues pour des applications professionnelles uniquement et pas pour des applications grand public.

本投影机安装透射比大于3.5的可换镜头后，可成为RG3，操作前，请参考手册中镜头清单和危险距离。本投影机与镜头组合仅供专业使用，非普通消费者使用。

**For F80-Q9, F80-4K9 :**

<p>For North America: THIS PRODUCT IS IN CONFORMITY WITH PERFORMANCE STANDARDS FOR LASER PRODUCTS UNDER 21 CFR 1040, EXCEPT WITH RESPECT TO THOSE CHARACTERISTICS AUTHORIZED BY VARIANCE NUMBER 2017-V-4837 EFFECTIVE SEPTEMBER 13, 2017.</p> 	<p>This projector may become RG3 when an interchangeable lens with throw ratio greater than 2.8 is installed. Refer to the manual for the lens list and hazard distance before operation. Such combinations of projector and lens are intended for professional use only, and are not intended for consumer use.</p> <p>Ce projecteur peut devenir un projecteur RG3 en cas d'installation d'un objectif interchangeable dont le rapport de projection est supérieur à 2.8. Veuillez vous reporter au manuel pour en savoir plus sur la liste des objectifs et la distance de sécurité avant toute utilisation. De telles combinaisons entre projecteur et objectif sont conçues pour des applications professionnelles uniquement et pas pour des applications grand public.</p> <p>本投影机安装透射比大于2.8的可换镜头后，可成为RG3，操作前，请参考手册中镜头清单和危险距离。本投影机与镜头组合仅供专业使用，非普通消费者使用。</p>
---	--

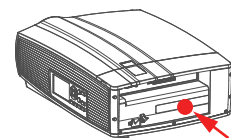

For North America: THIS PRODUCT IS IN CONFORMITY WITH PERFORMANCE STANDARDS FOR LASER PRODUCTS UNDER 21 CFR 1040, EXCEPT WITH RESPECT TO THOSE CHARACTERISTICS AUTHORIZED BY VARIANCE NUMBER 2017-V-4837 EFFECTIVE SEPTEMBER 13, 2017.

This projector may become RG3 when an interchangeable lens with throw ratio greater than 2.8 is installed. Refer to the manual for the lens list and hazard distance before operation. Such combinations of projector and lens are intended for professional use only, and are not intended for consumer use.

Ce projecteur peut devenir un projecteur RG3 en cas d'installation d'un objectif interchangeable dont le rapport de projection est supérieur à 2.8. Veuillez vous reporter au manuel pour en savoir plus sur la liste des objectifs et la distance de sécurité avant toute utilisation. De telles combinaisons entre projecteur et objectif sont conçues pour des applications professionnelles uniquement et pas pour des applications grand public.

本投影机安装透射比大于2.8的可换镜头后，可成为RG3，操作前，请参考手册中镜头清单和危险距离。本投影机与镜头组合仅供专业使用，非普通消费者使用。

**For F80-Q12, F80-4K12 :**

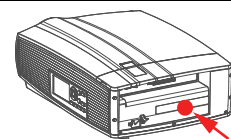

Label image	Label description	Label location
-------------	-------------------	----------------

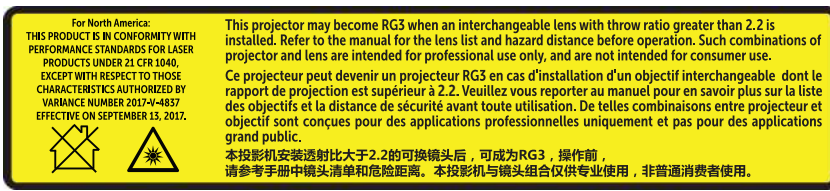

For North America: THIS PRODUCT IS IN CONFORMITY WITH PERFORMANCE STANDARDS FOR LASER PRODUCTS UNDER 21 CFR 1040, EXCEPT WITH RESPECT TO THOSE CHARACTERISTICS AUTHORIZED BY VARIANCE NUMBER 2017-V-4837 EFFECTIVE September 13, 2017.

This projector may become RG3 when an interchangeable lens with throw ratio greater than 2.2 is installed. Refer to the manual for the lens list and hazard distance before operation. Such combinations of projector and lens are intended for professional use only, and are not intended for consumer use.

Ce projecteur peut devenir un projecteur RG3 en cas d'installation d'un objectif interchangeable dont le rapport de projection est supérieur à 2.2. Veuillez vous reporter au manuel pour en savoir plus sur la liste des objectifs et la distance de sécurité avant toute utilisation. De telles combinaisons entre projecteur et objectif sont conçues pour des applications professionnelles uniquement et pas pour des applications grand public.

本投影机安装透射比大于2.2的可换镜头后，可成为RG3，操作前，请参考手册中镜头清单和危险距离。本投影机与镜头组合仅供专业使用，非普通消费者使用。

## 1.4 Risk Group 3 Safety

### 1.4.1 General considerations

#### Notice on optical radiation from F80 Projector when it becomes Risk Group 3.

- For RG3, no direct exposure to the beam shall be permitted.  
For RG3, operators shall control access to the beam within the hazard distance or install the product at a height that will prevent eye exposure within the hazard distance.
- This projector has one or several built-in Class 4 laser clusters. Disassembly or modification is very dangerous and should never be attempted.
- Any operation or adjustment not specifically instructed by the user's guide creates the risk of hazardous laser radiation exposure.
- Do not open or disassemble the projector as this may cause damage by the exposure of laser radiation.

FOR PROFESSIONAL USE ONLY means installation can only be carried out by Barco AUTHORIZED PERSONNEL familiar with potential hazards associated with high intensity light beams.



**WARNING:** No direct exposure to the beam within the hazard distance shall be permitted, RG3 (Risk Group 3) IEC EN 62471-5:2015



**CAUTION:** Use of controls or adjustments or performance of procedures other than those specified herein may result in hazardous radiation exposure.

#### PPE (Personal Protective Equipment) description.

A skilled person or service person shall be worn protective clothes and goggles when access to restricted area.

Possible skin or eye damage.

Disconnect power before servicing.



## 1.4.2 High Brightness precautions: Hazard Distance (HD)



### HD

Hazard Distance (HD) is the distance measured from the projection lens at which the intensity or the energy per surface unit becomes lower than the applicable exposure limit on the cornea or on the skin. The light beam is considered (to be) unsafe for exposure if the distance from a person to the light source is less than the HD.

### Restriction Zone (RZ) based on the HD

The HD depends on the amount of lumens produced by the projector and the type of lens installed. See next chapter “HD in function of the lens Throw Ratio (TR)”, page 20.

To protect untrained end users (as cinema visitors) the installation shall comply with the following installation requirements: Operators shall control access to the beam within the hazard distance or install the product at the height that will prevent spectators' eyes from being in the hazard distance. Radiation levels in excess of the limits will not be permitted at any point less than 2.0 meter (SH) above any surface upon which persons other than operators, performers, or employees are permitted to stand or less than 1.0 meter (SH) lateral separation from any place where such persons are permitted to be. In non-cinema environments where unrestrained behavior is reasonably foreseeable, the minimum separation height should be greater than or equal to 3.0 meter to prevent potential exposure, for example by an individual sitting on another individual's shoulders, within the HD.

These values are minimum values and are based on the guidance provided in IEC 62471-5:2015 section 6.6.5.

The end user must understand the risk and apply protective measures based upon the hazard distance as indicated on the label and in the user information. Installation method, barriers, detection system or other applicable control measure shall prevent hazardous eye access to the radiation within the hazard distance.

For example, projectors that have a HD greater than 1 m and emit light into an uncontrolled area where persons may be present should be positioned in accordance with “the fixed projector installation” parameters, resulting in a HD that does not extend into the audience area unless the beam is at least 2.0 meter above the floor level. In non-cinema environments where unrestrained behavior is reasonably foreseeable, the minimum separation height should be greater than or equal to 3.0 meter to prevent potential exposure, for example by an individual sitting on another individual's shoulders, within the HD. For example, a sufficiently large separation height may be achieved by mounting the image projector on the ceiling or through the use of physical barriers.

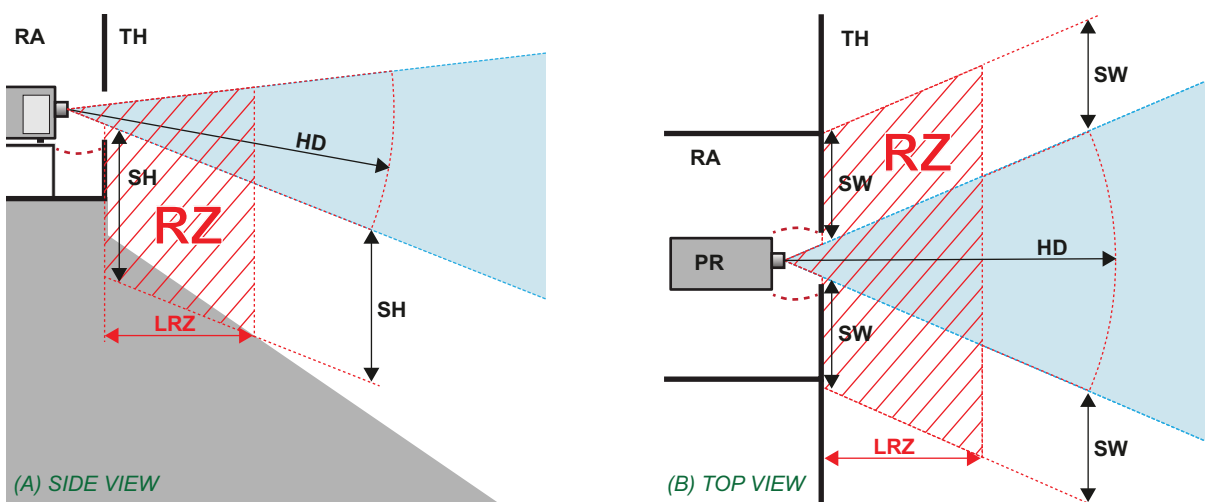

Image 1-1

- A** Side view.
- B** Top view.
- RA** Restricted Access location (boot area of projector).
- PR** Projector.

- TH** Theater.
- RZ** Restriction Zone in the theater.
- SH** Separation Height.
- SW** Separation Width.

Based on national requirements, no person is allowed to enter the projected beam within the zone between the projection lens and the related hazard distance (HD). This shall be physically impossible by creating sufficient separation height or by placing barriers. The minimum separation height takes into account the surface upon which persons other than operator, performers or employees are permitted to stand.

On [Image 1-2](#) a typical setup is displayed. It must be verified if these minimum requirements are met. If required a restricted zone (RZ) in the theater must be established. This can be done by using physical barrier, like a red rope as illustrated in [Image 1-2](#).

The restricted area sticker can be replaced by a sticker with only the symbol.

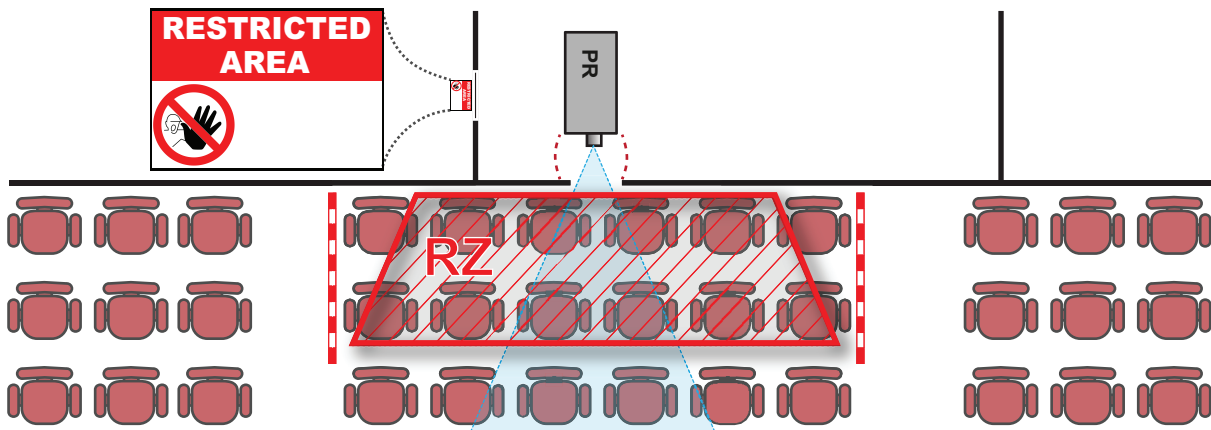

Image 1-2

## USA market

For LIPs (Laser Illuminated Projectors) installed in the USA market other restriction zone conditions apply.

LIPs for installation in restrained environment (cinema theaters, business rooms, class rooms, museums ...) shall be installed at height vertically above the floor such that the bottom plane of the hazard distance zone shall be no lower than 2.5 meters above the floor. Horizontal clearance to the hazard distance zone shall be not less than 1 meter. Alternatively, in case the height of the separation barrier for the horizontal clearance is at least 1 meter high then the horizontal clearance (SW) can be reduced to:

- 0 meter if the height of the hazard zone is minimum 2.5 meter.
- 0.1 meter if the height of the hazard zone is minimum 2.4 meter.
- 0.6 meter if the height of the hazard zone is minimum 2.2 meter.

LIPs for installations in unrestrained environment (concerts, ...) shall be installed at a height vertically above the floor such that the bottom plane of the Hazard distance Zone shall be no lower than 3 meters above the floor. Horizontal clearance to the hazard distance zone shall be not less than 2.5 meters. Any human access horizontally to the Hazard Zone, if applicable, shall be restricted by barriers. If human access is possible in an unsupervised environment, the horizontal or vertical clearances shall be increased to prevent exposure to the hazard distance zone.

The LIP shall be installed by Barco or by a trained and Barco-authorized installer or shall only be transferred to laser light show variance holders. This is applicable for dealers and distributors since they may need to install the LIP (demo install) and/or they transfer (sell, rent, lease) the LIP. Variance holders may currently hold a variance for production of Class IIIB and IV laser light shows and/or for incorporating RG3 LIPs. Laser light show variance can be requested via the FDA online eSubmitter portal or via FDA Form 3147 referencing to Barco's variance approval 2017-V-4837.

The installation checklist for laser illuminated RG3 projectors must be fully completed after the installation. The installation checklist can be downloaded from the Barco website. The last variance holder in the distribution chain is responsible to maintain the installation checklist and to make it available on request of the FDA. In case Barco is the last variance holder the checklist must be sent to [pvg@barco.com](mailto:pvg@barco.com).

In addition to temporary installations (e.g.: rental and staging, lease, events ...) the following requirements apply:

- Rental companies shall have a laser light show variance because they have direct relationship with the installers of the rented equipment.
- This product shall be located in such a way that all propagating beam paths within the Restriction Zone, and the audience can be directly observed at all times.
- Communication shall be maintained with other personnel assisting in surveillance of the LIP projection.
- In the event of any unsafe condition, immediately terminates (or designate the termination) of LIP projection light.

Install one or more readily accessible controls to immediately terminate LIP projection light. The power input at the projector side is considered as a reliable disconnect device. When required to switch off the projector, disconnect the power cord at the projector side. In case the power input at the projector side is not accessible (e.g. truss mount), the socket outlet supplying the projector shall be installed nearby the projector and be easily accessible, or a readily accessible general disconnect device shall be incorporated in the fixed wiring.

### 1.4.3 HD for fully enclosed projection systems

**HD**  
**i** Hazard Distance (HD) is the distance measured from the projection lens at which the intensity or the energy per surface unit becomes lower than the applicable exposure limit on the cornea or on the skin. The light beam is considered (to be) unsafe for exposure if the distance from a person to the light source is less than the HD.

#### Restriction Zone (RZ) based on the HD

The projector is also suitable for rear projection applications; projecting a beam onto a diffuse coated projection screen. As displayed in [Image 1–3](#) two areas should be considered: the restricted enclosed projection area (RA) and the observation area (TH).

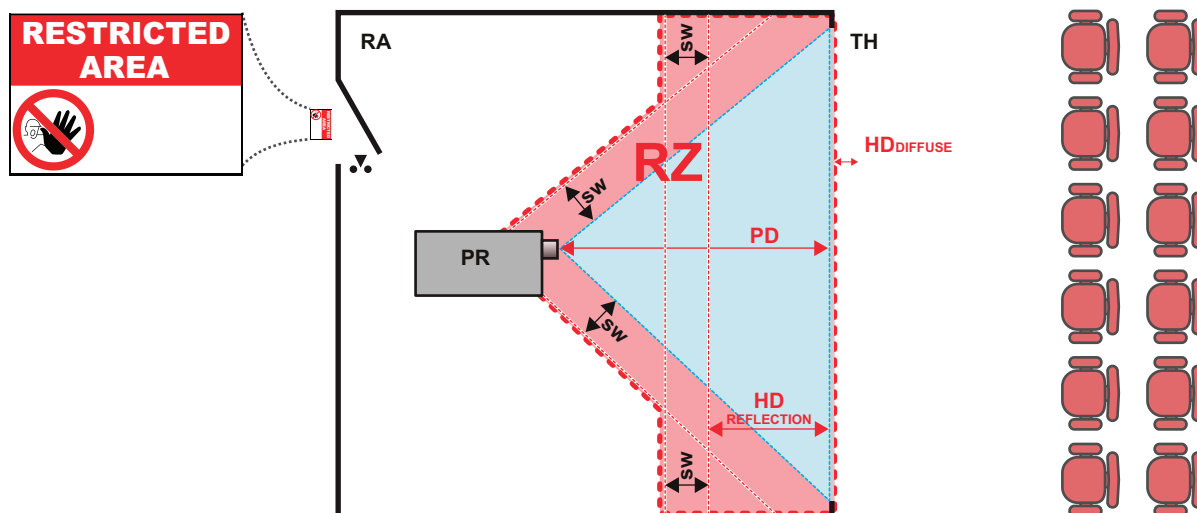

Image 1–3

- RA** Restricted Access location (enclosed projection area).
- PR** Projector.
- TH** Theater (observation area).
- RZ** Restriction Zone.
- PD** Projection Distance.
- SW** Separation Width. Must be minimum 1 meter.

For this type of setup 3 different HD shall be considered:

- HD as discussed in “High Brightness precautions: Hazard Distance (HD)”, page 17, relevant for intrabeam exposure.
- $HD_{\text{reflection}}$  : the distance that has to be kept restrictive related to the reflected light from the rear projection screen.
- $HD_{\text{diffuse}}$  : the relevant distance to be considered while observing the diffuse surface of the rear projection screen.

As described in “High Brightness precautions: Hazard Distance (HD)”, page 17, it is mandatory to create a restricted zone within the beam areas closer than any HD. In the enclosed projection area the combination of two restricted zones are relevant: The restricted zone of the projected beam toward the screen; taking into account 1 meter Separation Width (SW) from the beam onward. Combined with the restricted zone related to the rear reflection from the screen ( $HD_{\text{reflection}}$ ); also taking into account a 1 meter lateral separation.

The  $HD_{\text{reflection}}$  distance equals 25% of the difference between the determined HD distance and the projection distance to the rear projection screen. To determine the HD distance for the used lens and projector model see chapter “HD in function of the lens Throw Ratio (TR)”, page 20.

$$HD_{\text{reflection}} = 25\% (HD - PD)$$

The light emitted from the screen within the observation shall never exceed the RG2 exposure limit, determined at 10 cm. The  $HD_{diffuse}$  can be neglected if the measured light at the screen surface is below 5000 cd/m<sup>2</sup> or 15000 LUX.

### 1.4.4 HD in function of the lens Throw Ratio (TR)



#### TR (Throw Ratio)

The ratio of the distance to the screen (throw) to the screen width.

#### HD versus Throw Ratio

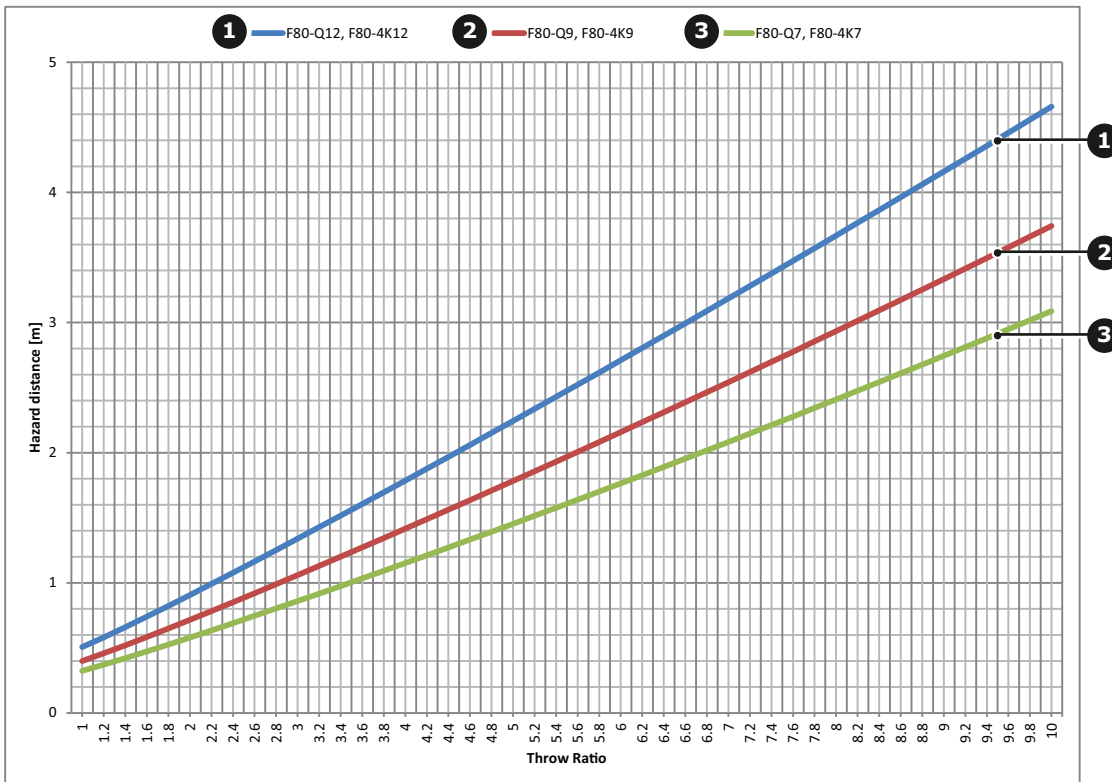

Image 1-4

Graph shows Hazard Distance in meters versus Throw ratio of the lens

# Remote Control Unit

# 2

## 2.1 Remote control, battery installation

### Where to find the batteries for the remote control ?

The batteries are not placed in the remote control unit to avoid control operation in its package, resulting in a shorter battery life time. At delivery the batteries can be found in a separated bag attached to the remote control unit. Before using your remote control, install the batteries first.

### How to install

1. Push the battery cover tab with the fingernail a little backwards (1) and pull, at the same time, the cover upwards (2).

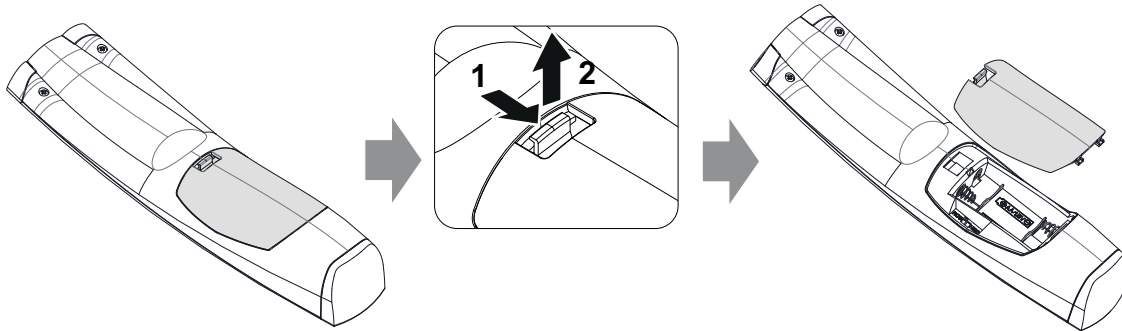

Image 2-1

2. Insert the two AA size batteries, making sure the polarities match the + and - marks inside the battery compartment.



*Tip:* Use alkaline batteries for optimum range and life time.

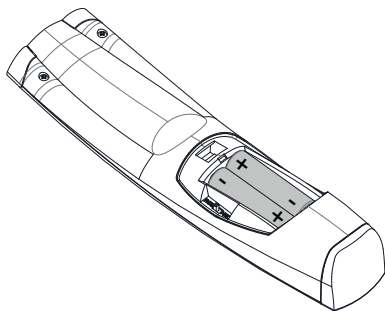

Image 2-2

3. Insert (1) both lower tabs of the battery cover in the gaps at the bottom of the remote control, and press (2) the cover until it clicks in place.

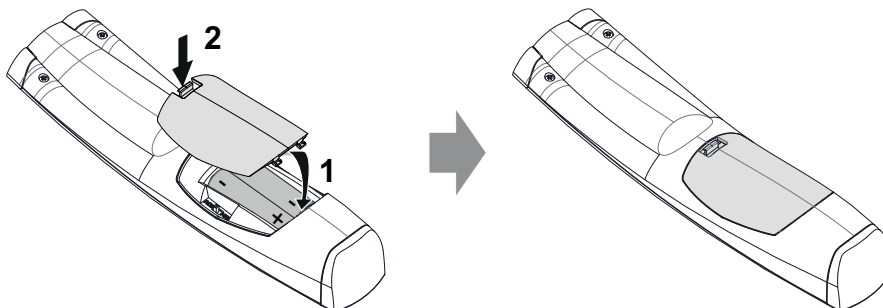

Image 2-3



When replacing batteries, the broadcast address of the RCU will be reset to its default value '0'.



**CAUTION:** Replace with the correct battery type. Use two AA size batteries. There is a risk of explosion if the battery is replaced with an incorrect type.



**CAUTION:** Replace the battery as explained above. There is a risk of explosion if the battery is incorrectly installed.

## 2.2 Using the mini-jack connector of the RCU



Connecting a cable with the mini-jack connector will reset the broadcast address of the RCU to its default value '0'.

### How to use the mini-jack connector

1. Connect a cable with the mini-jack connector (reference 2 [Image 2-4](#)) of the RCU.
2. Connect the other end of the cable with the mini-jack input of the projector.

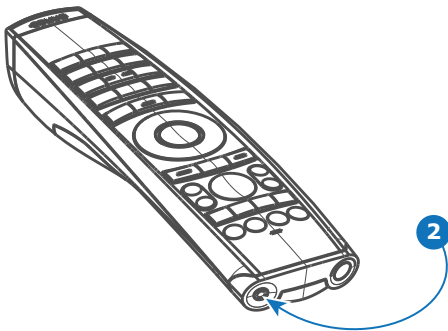

Image 2-4

## 2.3 Remote control, on/off button

### Purpose of the remote control on/off button

The Pulse remote control unit has at the front side an on/off switch (reference 1 [Image 2-5](#)). Switching off the remote control prevents that unwanted commands are sent due to an accidental key press. Furthermore, switching the RCU off will extend the battery life time of the remote control.

To activate the remote control press the on/off button.

To deactivate the remote control press the on/off button again.

Default when (re)placing batteries, is "ON".

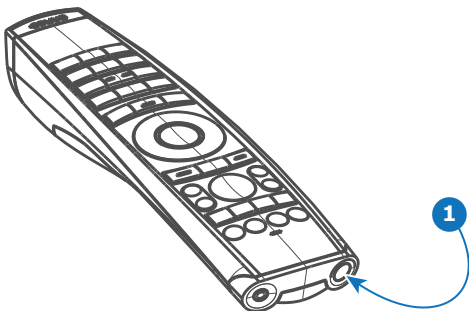

Image 2-5





# Input & Communication

# 3

3.1	Introduction .....	26
3.2	Connection Panel .....	26
3.3	Making connections .....	27
3.4	Connector specifications .....	27
3.5	Control interfaces .....	30
3.6	LED and Button indication chart.....	31

## 3.1 Introduction

### General

The Input & Communication features of the projector consists of a local keypad and a communication panel situated at the left side, and a connection panel (sources and control connections) located at the back side.

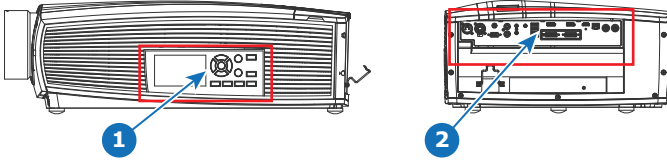

Image 3-1

- 1 local keypad and a communication panel
- 2 connection panel

## 3.2 Connection Panel

### General

Projector sources and control connections are located at the back of the projector.

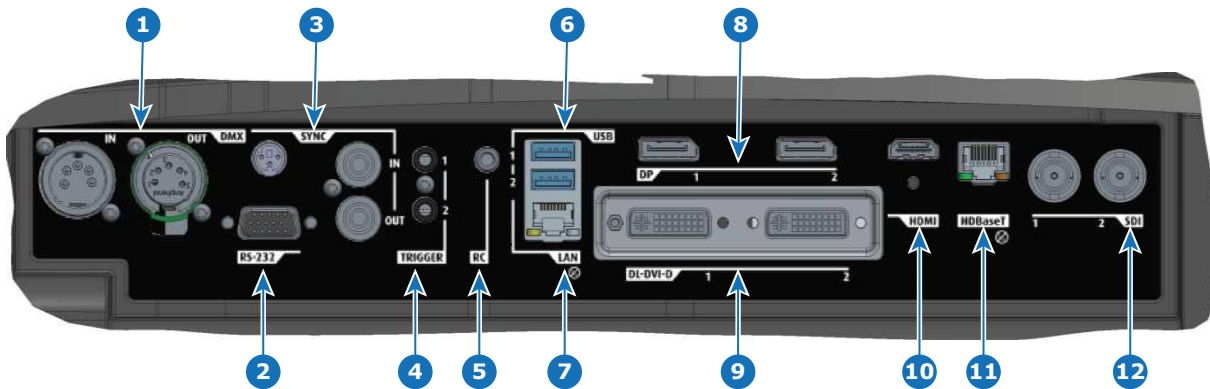

Image 3-2

Nb.	Name	Pcs	Description	Purpose
1	DMX IN/OUT	2	DMX 512 input / DMX 512 output	For Projector Control. DMX connectors allow to create communication bus between different devices in order to control them from a console.
2	RS-232	1	9-pin DB9 connector	For Projector Control. Allows for wired remote control and monitoring of many projector functions used in installation environments
3	Sync	3	BNC Sync Port IN/OUT; Bidirectional mini-DIN (1x 3D sync Out, and 2x Sync In/Out)	For Projector Control. This is mainly used in multiple projector installations with requirement of synchronization between the units
4	Trigger	2	12VDC - 0,5A (6W)	For Controlling Peripherals, like motorized screens, curtains etc. Give 12V output when projector are switched on <b>See also the note below.</b>
5	RC	1	Mini jack 3,5mm connector for wired remote	For Projector Control
6	USB	2	USB 2.0 type A, 4 pin( 2x Rear and 1x Front)	For Software upgrade
7	LAN	1	Standard RJ45 connector	For Projector Control

Nb.	Name	Pcs	Description	Purpose
8	DP	2	Standard display port	For Projector Input
9	DL-DVI-D	2	Dual DVI-I 1.0 (DVI_D Functionality).	For Projector Input. These connectors can also be used to form one uniform image by feeding half of the image into each connector. HDCP compliant for sources up 165 Mhz
10	HDMI	1	Standard HDMI 2.0	For Projector Input
11	HDBaseT	1	Standard RJ45 8P8C Connector	For Projector Input
12	SDI	2	SDI1 is Input, SDI 2 is pass through. (out)	For Projector Input



Regarding the Trigger Output: If these outputs are loaded too heavy, there is a risk that the projector will go in reset mode, and restart. This causes no damage to the projector, but is an undesirable response. This will also happen if the startup current for the external equipment is too high, even though the nominal power consumption is less than 0,5A.

## 3.3 Making connections



The source switching time is variable and could take few seconds..

### Source signal connectivity

The connector panel at the back of the projector is used for all source connections.

Source signal connectivity on the projector is:

- 2x Dual Link DVI-I (DVI-D functionality)
- 2x DisplayPort 1.2
- 1x HDMI 2.0
- 1x HDBaseT
- 1x SDI input (initially designed for 3G-SDI input signals, 12G-SDI signals are now supported)

## 3.4 Connector specifications

### 3.4.1 DVI-I

#### Specifications

Parameter	Value
Connector	DVI-I female digital RGB
Signal characteristics	DVI 1.0, Digital, TMDS
Max. cable length	25 m (24 AWG)
Max. pixel rate	330 MHz (dual link), 165 Mhz (single link)
Scan format	Progressive
Max. input data resolution	1920x1200 60Hz (Single link), 2560x1600 60Hz (Dual Link), 1920x1200 120 Hz (Dual Link), 1920x2400 @60Hz
Bit depth	8 bit

Parameter	Value
EDID	Supported
HDCP	Supported

### 3.4.2 Display Port 1.2

#### Specifications

Parameter	Value
Connector	Standard Display port
Signal characteristics	DP 1.2
Functionality	Mandatory
Max. cable length	2 m (24 AWG) - RBR; 2 m (24 AWG) – HBR1, HBR2
Supported Link Rate	RBR, HBR1, HBR2
Scan format	Progressive
Max. input data resolution	2716x1600@120Hz WQXGA+ / 3840x2400 @60Hz (4K ) Max
Bit depth	8, 10, 12 bit
EDID	Supported
HDCP	Supported

### 3.4.3 HDMI 2.0

#### Specifications



Regarding HDMI 2.0: The decryption protocol HDCP 2.2 are enabled and valid in this unit.

Parameter	Value
Connector	Standard HDMI
Signal characteristics	Digital, TMDS
Max. cable length	2 m (24 AWG)
Max. pixel rate	594MHz
Max. input data resolution	3840x2160 @60Hz
Bit depth	8, 10, 12 bits
EDID	Supported
HDCP	Supported
Ethernet	No
Audio return	No
HDCP	Supported

### 3.4.4 SDI

#### Specifications

Parameter	12G-SDI	3G-SDI
Standard	SMPTE ST-2082-1 and ST-2082-10 standards	SMPTE 424M-2006 10bit level A
Connector	Samtec BNC7T-J-P-HN-RA-BH1	1x) BNC 75 ohm type IEC 60169-8, Amendment 2 1997, A
Bandwidth	12GHz	>3 GHz
Return loss	-6dB @ 12GHz	>10dB at 3GHz
Impedance	75 ohm resistive	75 ohm resistive

### 3.4.5 HDBase T



The HDBaseT standard allows the link to also be used as a regular network port. In addition to carrying video data, it can also be connected to regular ethernet network without carry out any video data.

Due to limitations in the projector and network standards, only the LAN and the HDBaseT should be used for network traffic, but not both simultaneously. If both are connected simultaneously it might lead to undefined behavior where traffic is not being sent on the link indicated by the IP address. This is only valid when the projector has a firmware version 2.1 or higher installed.

#### Specifications

Parameter	Value
Reference specification	HDBaseT 1.0 Specification, June 2010
Connector	Standard RJ-45, 8P8C
Signal characteristics	HDBaseT
Max. cable length (1080p/48b/60Hz)	100 m (Cat5e/6), Pixel Clock <=225MHz, Video Datarate <=5.3Gbps 70 m (Cat5e/6), Pixel Clock >225MHz, Video Datarate >5.3Gbps 100 m (Cat6a/7), Pixel Clock >225MHz, Video Datarate >5.3Gbps
Max TMDS Clock Frequency	270 MHz
Max video resolution supported	4096x2160 @30Hz
HDCP Pass-Through	Yes, from Source to Projector
IR Extension	Not Supported
RS-232 Extension	Not Supported
10/100Mbps Ethernet Pass-Through	Not Supported
Fallback to 100BaseTx, IEEE 802.3u	Not Supported
USB Over Centre Tap	Not Supported
Power Over Ethernet	Not Supported
Audio	Not Supported
LEDs - HD Base Status	Operation: Green, Left Link/Mode: Yellow, Right

### 3.4.6 High-bandwidth Digital Content Protection (HDCP)

#### About HDCP

HDCP protocol is a form of digital copy protection to prevent copying of digital audio & video content as it travels across connections.

Capability of a connector to accept HDCP content (revision v1.X or v2.X) can vary and depends of the FPGA resource mapping that manage connectors. Please refer to the *Home/Source* menu to obtain this information.

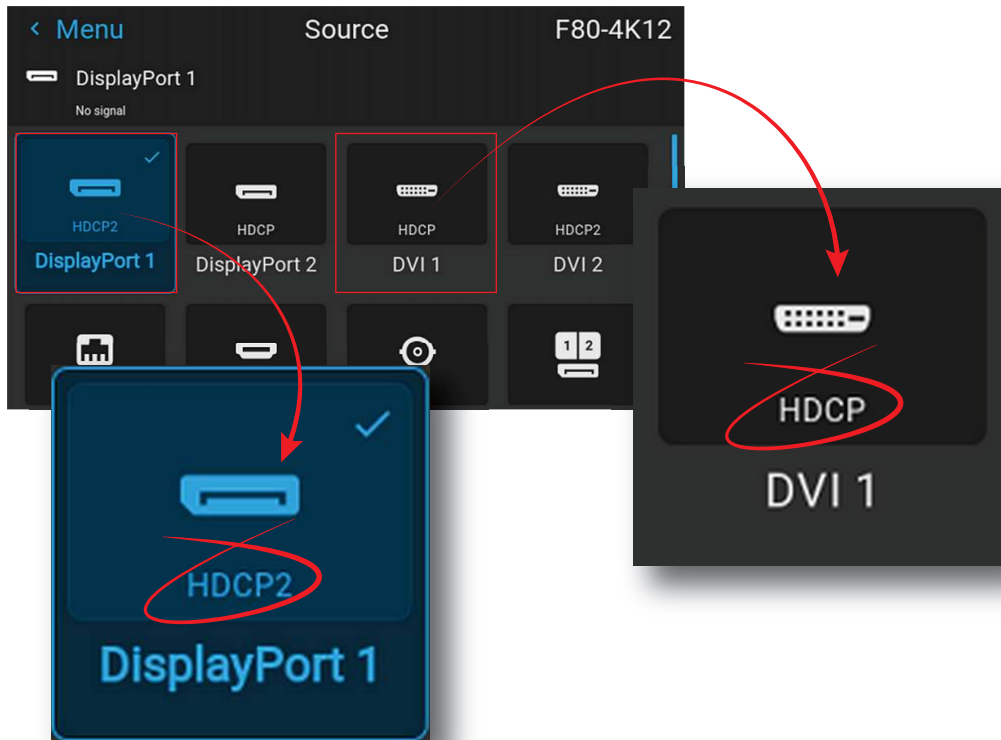

Image 3-3 HDCP revision information

## 3.5 Control interfaces

#### About

This section gives information about interfaces used to control the projector.

#### 3.5.1 RS-232

##### Specifications

Parameter	Value
RS-232 connector	1 female DB9 connector (RS232-in) for projector control and debug

## 3.5.2 LAN/Ethernet

### Specifications

Parameter	Value
Ethernet connector	1 RJ45 Connector for projector control (not content)
Protocols	DHCP, TCP/IP, UDP/P
Speed	10/100 Mbit/1000Mbit

## 3.5.3 USB-A port

### Specifications

Parameter	Value
USB connector	Type A
Function	Firmware upgrade using USB sticks
Power	Power 5V, max 1,5A (out)
Standard	USB 2.0

## 3.5.4 DMX

### DMX interface

DMX is used as communication bus between different devices in the light technic. Each device has an input and an output, so that the bus can be looped between the different devices. According the standard a five wire cable with XLR connector is used.

You can use the DMX input port to connect a DMX device (DMX console) to the projector. This way you can control the projector from that DMX device (console). The DMX output port can be connected with the next device in the loop.

Pin	Description
1	Earth
2	Cold
3	Hot
4	Return - (or not used)
5	Return + (or not used)



#### DMX

DMX-512 Lighting protocol over RS-485 interface. Carries information of 512 channels from a lighting controller to lighting devices. Standardized by USITT.

## 3.6 LED and Button indication chart

### Button Backlight Status

#### Button

Standby button



#### Color status

Blinking WHITE (slow)

Blinking WHITE (fast)

Solid WHITE

#### Description

Projector starts up (booting)

Firmware upgrade

Projector is in Standby mode

**Button**

Shutter button



**Color status**

Blinking BLUE

Solid BLUE

Blinking RED

Off (no color)

Solid WHITE

Solid RED

**Description**

Projector goes to ON mode

Projector is ON

Error condition

Projector is OFF, starts up, or is in Standby mode.

Projector is ON, shutter is open

Projector is ON, shutter is closed

**LED Status**

The LED status is located on the top side of the projector, near the IR receiver.

During normal operation the LED is unlit. In the event of a critical error or high temperature, the LED will display red.

By critical error, the projector cannot be restarted until the projector is disconnected from the power supply and then reconnected again. If the reason for the error persist, the projector will again go to critical error status.

By high temperature, the projector will restart when it has cooled down, and temperatures are back within the normal operating limitations.



# Getting Started

# 4

4.1	Local Keypad and LCD panel .....	34
4.2	Power modes .....	34
4.3	Power mode transitions .....	35
4.4	Status overview .....	37
4.5	Power off projector .....	37
4.6	Increasing the projector life time .....	38
4.7	Operation in 24/7 Mode .....	38
4.8	Using the RCU .....	38
4.9	Projector Address .....	40
4.10	Quick setup via Direct access .....	41

## About this chapter

This chapter describes how to power up, control and set up your projector setup when the physical installation process is complete.

## How controlling the projector ?

The projector can be controlled by the local keypad, by the remote control unit or by browser application.

## Location of the local keypad ?

The local keypad is located on the right side of the projector.

## Remote control functions.

This remote control includes a battery powered infrared (IR) transmitter that allows the user to control the projector remotely. This remote control is used for source selection, control, adaptation and set up.

Other functions of the remote control are :

- switching between operating modes ( ECO, READY, ON).
- switching to "pause" (blanked picture, full power for immediate restarting)
- direct access to all connected sources.

## 4.1 Local Keypad and LCD panel

### Overview

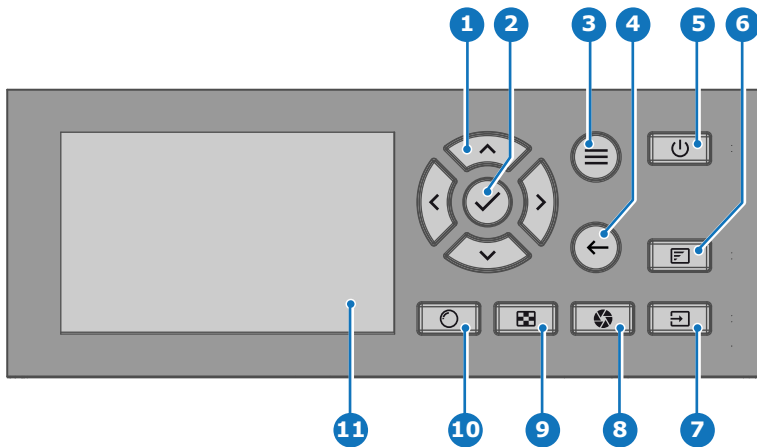

Image 4-1

- |   |                              |    |                      |
|---|------------------------------|----|----------------------|
| 1 | Menu navigation              | 7  | Input selection      |
| 2 | Menu confirmation, OK button | 8  | Shutter open / close |
| 3 | Menu open / close            | 9  | Test patterns        |
| 4 | Menu back                    | 10 | Lens adjustment      |
| 5 | Power on / off               | 11 | LCD panel            |
| 6 | Project OSD on / off         |    |                      |

### Local Keypad

The Keypad gives direct access to several functions, in addition to access to the menu system.

The keypad has a backlight that can be switched on and off manually. By default the light turns off after 5 minutes.

The Power button and Shutter buttons are equipped with white, blue and red backlit LEDs. The other keys are only equipped with white and blue backlit LEDs. The LEDs are controlled according to the features available.

### LCD panel

The LCD panel has two main functions:

1. Showing the menus, the adjustment information and also a mirror of the OSD, (On Screen Display) described in *User Interface* when this is enabled.
2. Information regarding the status of the projector showing this data:
  - Projector status
  - Network address
  - Active source
  - Current firmware version
  - Operation Data
  - Active functions (Enabled Functions).

Toggle between the two indications by using the **Menu** button on the keypad, or on the remote control.

The LCD Display will fade out 30 seconds after the last key operation.

## 4.2 Power modes

### General

The table below details the F80 power modes.

**Mode**

ON (normal)  
 READY  
 ECO (Standby)

**Description**

Projector is booted up and the light source is on  
 Projector is booted up but the light source is off  
 Light source is switched off and projector electronics are powered down

 Energy consumption is significantly lower in ECO (Standby) mode: only <0.5W if network is not plugged in and 2W with network (Wake-on-LAN).

 In ECO (Standby) mode, remote power up (Wake-on-LAN) and local power up (button) are supported.

## 4.3 Power mode transitions

### 4.3.1 General

#### Transition Diagram

This diagram shows all modes available on the projector (unplug, ON, READY, ECO), and the actions necessary to change mode.

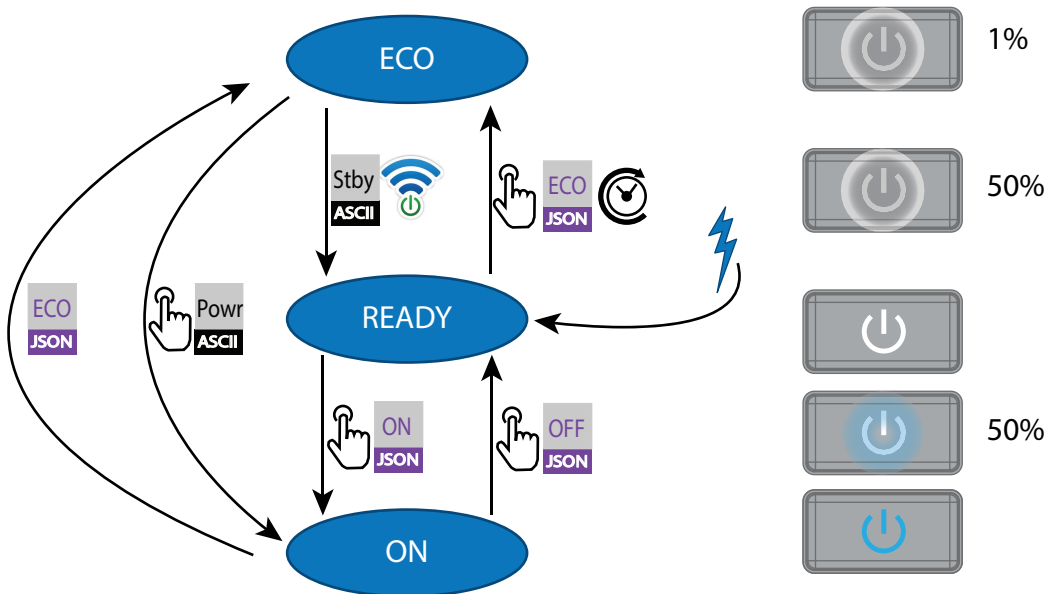







Image 4-2

-  Projector mains powered
-  Auto transition after x minutes if ECO mode enables
-  Press power On/Off button, remote On/Off button
-  Wake on LAN (WOL)
-  OFF JSON command (Power on, Power off, Go to Eco)
-  Stby ASCII command (power, stby) received via RS-232

### 4.3.2 Power on projector

 If not already connected, connect the female side of the power cord with the power input socket of the projector. For more details see section dedicated to the power cord installation.



The background image of the startup screen and info screens can be changed with Projector Toolset with an installed F80 plug-in.

## Description

Plug the 3-prong plug of power cord into a grounded AC outlet. The projector will go to **READY** mode. During this stage the system boots and performs the internal check of the boards. The *Power On/Off button* will BLINKING WHITE until **READY** mode is achieved. Once in **READY** mode, the *Power On/Off button* will be lit WHITE.

### 4.3.3 Going from READY to ON

#### Description

Press the *Power On/Off button* (short press) on the projector, or the *Power On button* on the remote control. The projector will power **ON**. The *Power On/Off button* will BLINK BLUE during the transition from **READY** to **ON**. Once the projector is on, the *Power On/Off button* will be lit BLUE.

A JSON command (power on) could also be send to make the projector turn in to **ON** mode.

### 4.3.4 Going from ON to READY

#### Description

Press and hold the *Power on/off button* on the projector for 3 seconds, or press the *Power Off button* on the remote control. The projector will power down through a cool down phase. The *Power on/off button* will BLINK WHITE during the transition from **ON** to **READY**. Once the projector is in **READY**, the *Power on/off button* will be lit WHITE.

A JSON command (power off ) could also be send to make the projector turn in to **READY** mode.

### 4.3.5 Going from READY to ECO standby

#### Description

If ECO Standby mode is enabled in the service menu (refer to the section "GUI - system settings/Standby ECO", in User Guide) the projector will automatically go to **ECO** standby mode after a time-out (default 15 minutes). All electronics (including fans, pumps,...) go down except for a very small wake up controller. The *Power on/off button* will FLASH WHITE every second.

Another way to switch in **ECO** mode (when you are in **READY** mode) is press and hold the *Power on/off button* on the projector for 3 seconds, or press the *Power Off button* on the remote control.

And finally, a JSON command (Go to ECO) could also be send to make the projector turn in to **ECO** mode.

### 4.3.6 Going from ECO to ON

#### Description

Press the *Power on/off button* on the projector or the *Power On button* on the remote control. The projector goes from **ECO** directly to **ON**. The projector will go through the same booting phase as on power plugging, then do the transition from **READY** to **ON**. Of course startup-time will be longer then from **READY** to **ON**.

An ASCII command (Powr1) could also be send via RS232 to make the projector turn in to **ON** mode.

### 4.3.7 Wake on LAN (WOL)

#### Description

Wake-on-LAN (WOL), the standard ethernet network command, can be used to awakened or to turn on the projector by network message.

Used alone, the WOL command allows to switch in **READY** mode. A JSON command must be performed in addition to make the projector turn in to **ON** mode:

1. Send WOL.

2. Wait for connection to façade/prospector (the unit does provide feedback when it's ready).
3. Wait for ready state.
4. Sleep 5 seconds.
5. Send JSON "power on" command (to switch in **ON** mode).

## 4.4 Status overview

### Description

Once the projector is started, go to **Status** menu to get an overview of parameters such as :

- Chosen source
- Current resolution and refresh rate
- Device serial number and article number
- Current firmware version and model name
- Current illumination (in percentage)
- Lamp runtime in hours
- Chosen communication method and IP address (if connected)
- Warp status
- Environmental temperature



Image 4-3 Example of a status menu

## 4.5 Power off projector

### How to Switch off the projector

1. Use the *standby button*, or the *Power On* button on the remote control, to switch off the projector.  
The projector will switch to **READY** mode first in order to run through a cool down phase (see "[Power mode transitions](#)", page 35).
2. If **ECO** Standby mode is enabled in the service menu (refer to the section "GUI - system settings/Standby ECO", in User Guide) the projector will automatically go to **ECO** standby mode after a time-out (default 15 minutes).



Some actions like apply a grey test pattern are done during the two minutes of the cool down phase in order to minimize the potential effect of burn-in and increase the projector lifetime.



**CAUTION:** Never switch off the projector by means of unplugging mains cord or by cut down of mains power.



Barco advises to keep the projector always powered and use the **ECO** mode for low power consumption.

## How to unplug the projector

1. Follow the procedure above to Switch Off the projector.
2. Wait at least 2 minutes prior to unplug the projector by removing the power cord from the AC outlet.



**CAUTION:** It is very important to wait few minutes before unplug the power cord. If the cool down phase is not adhered, projector lifetime could be degraded.

## 4.6 Increasing the projector life time

### General

Barco propose the following recommendations to increase the projector life time:

- Dimming out the laser output intensity (70%).
- Use the device in regulated temperature area.
- Apply the recommendations describe in the “Operating in 24/7 Mode” chapter if the projector is destined to be operated continuously 24 hours a day / 7 days a week.



Typical life time of the projector could be up to double if the laser output is dimmed to 75% and if the projector operate in 25°C temp condition.

## 4.7 Operation in 24/7 Mode

### General

When the projector is destined to be operated continuously 24 hours a day / 7 days a week, Barco has a number of recommendations to increase the projector life time:

- Regularly, preferably twice a day if possible, switch off the projector during two minutes by using the standby button. The power down action will automatically and invisibly trigger a grey test pattern running within the projector.  
Note: if you really don't want to shut down the projector, an alternative method is select the grey test pattern yourself within the normal “on” mode. This method is not as effective as completely shut down the projector, but may be a more workable alternative.
- Apply moving video content as much as possible, with on average a level of 50% white (long-term use of extreme black or white content could potentially cause accelerated aging).

## 4.8 Using the RCU

### Pointing to the reflective screen

1. Point the front of the RCU to the reflective screen surface.

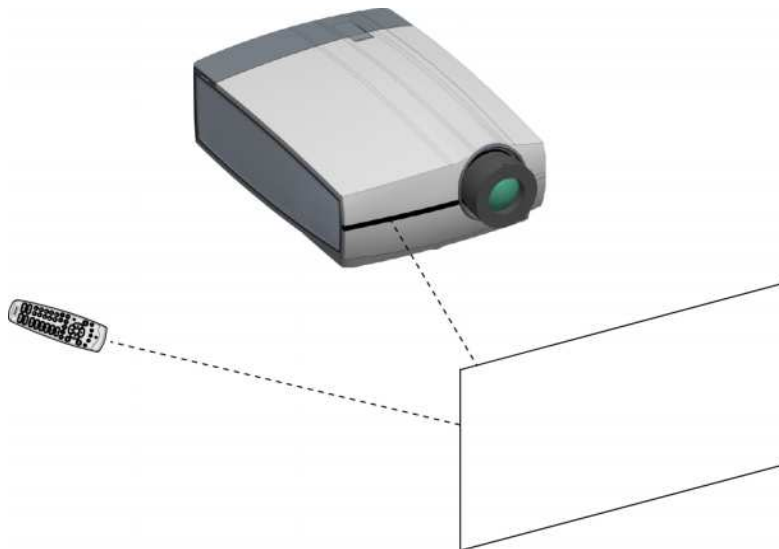

Image 4-4 IR control via reflective screen

### Hardwired to the mini jack input

1. Plug one end of the remote cable in the connector on the front side (3,5mm mini jack) of the RCU.
2. Plug the other end in the connector on the communication interface of the projector, labelled 'Remote CTRL'(reference 1, [Image 4-5](#)).

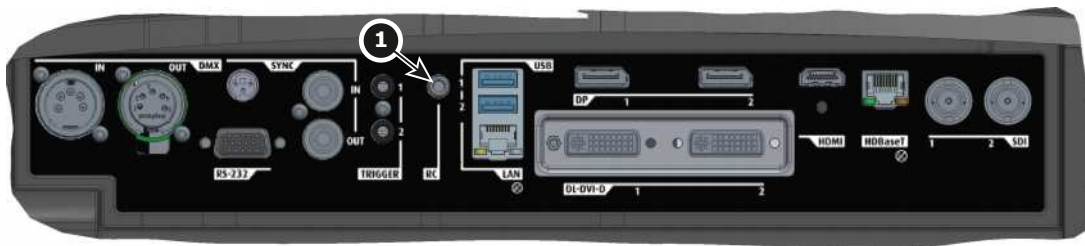



Image 4-5

 **Note:** Plugging the remote control will switch the broadcast address of the remote control to the default value '0'. This is the only broadcast address that will work when hardwired. If you want to change the broadcast address after disconnecting the remote control, see [“Projector Address”](#), [page 40](#).

### Pointing directly to the IR sensor

When using the wireless remote control, make sure you are within the effective operating distance (30m, 100ft in a straight line). The remote control unit will not function properly if strong light strikes the sensor window or if there are obstacles between the remote control unit and the projector IR sensor.

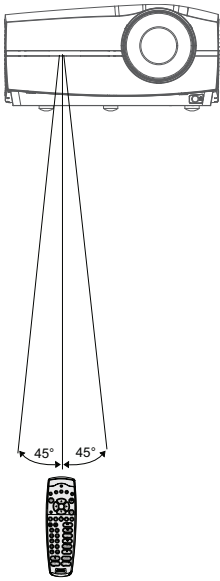

Image 4-6 RCU to one of the IR sensors

## 4.9 Projector Address



### Projector address

Address installed in the projector to be individually controlled.



### Broadcast address

Projector will always execute the command coming from a RCU programmed with that broadcast address.

### 4.9.1 Controlling the projector

#### Why a projector address?

As more than one projector can be installed in a room, each projector should be separately addressable with an RCU or computer. Therefore each projector has its own address.

#### Set up an individual Projector Address

The set up of a projector address can be done via the software.

#### Projector controlling

When the address is set, the projector can be controlled now:

- with the RCU: only for addresses between 1 and 31.

#### Broadcast Address

Every projector has a broadcast (common) address '0' or '1'. The default address is '0'.

The choice between '0' and '1' can be selected in the GUI: “*System Settings*” → “*Communication*” → “*IR Control*”



Placing new batteries in the remote control or plugging the remote to a projector via a cable will automatically reset the address back to its default value '0'.



## 4.10 Quick setup via Direct access

### Quick source selection

1. Press the **Input** button on the remote control or local keypad.

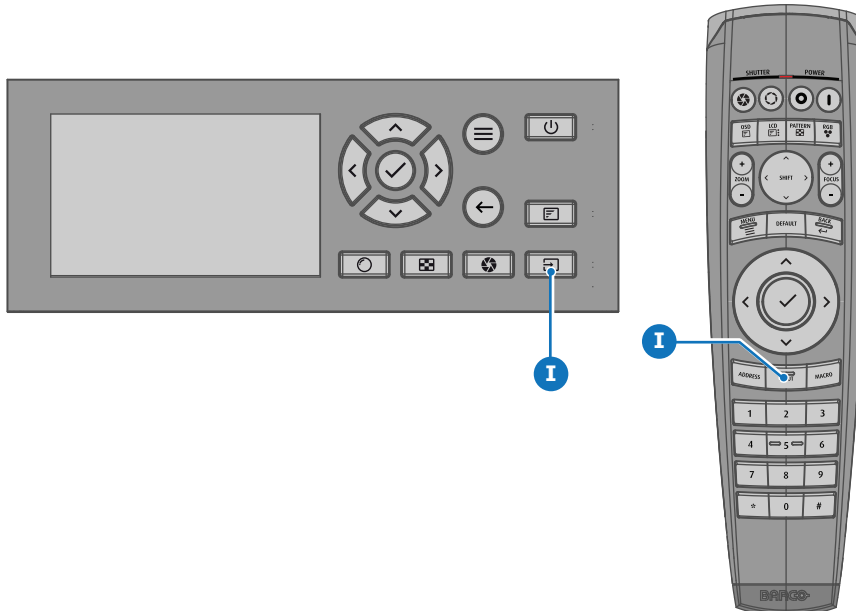

Image 4-7

The *Source selection* menu opens on the LCD display.

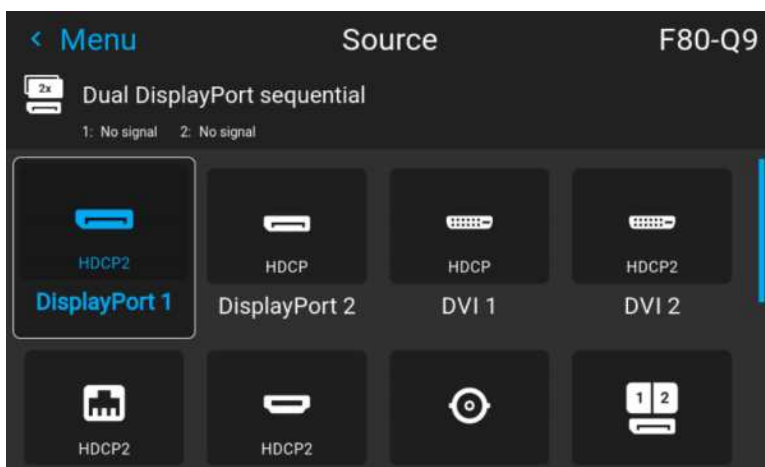

Image 4-8 Example of the input selection menu

2. Use the arrow keys to select the desired source.

### Quick test pattern selection

1. Press the Test pattern button on the remote control or local keypad.

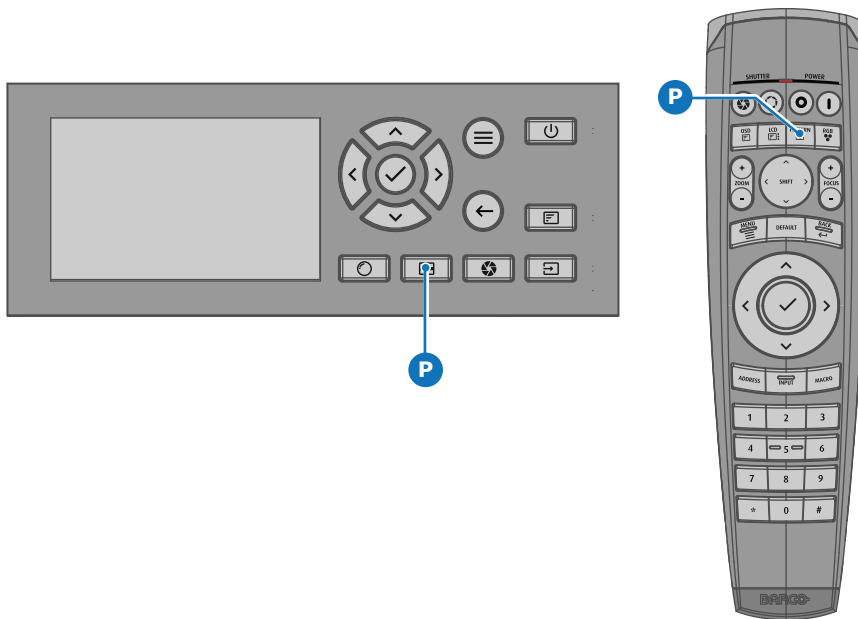

Image 4–9

The *Test pattern* menu opens on the LCD display.

2. Use the arrow keys to select the desired test pattern.

# GUI – Introduction

# 5

5.1	Overview .....	44
5.2	Navigation.....	45
5.3	Test Patterns .....	47

## About this chapter

This chapter gives an general overview of the Graphic User Interface.

## 5.1 Overview

### Disclaimer on GUI images used in this manual

The GUI images in this manual are example illustrations and should be treated as such. While the name of the projector displayed in the illustrations may be different from the projector model you are currently using, the menu lay-out and functionality is identical.

### GUI – First start of the software

When you start the projector for the first time, you will be requested to choose the system language. You can choose between the following languages:

- German (DE)
- English (EN-US)
- Spanish (ES)
- French (FR)
- Japanese (JA)
- Korean (KO)
- Portuguese (PT-BR)
- Russian (RU)
- Chinese (ZH)



Image 5-1 Example of the welcome screen

Once you confirmed your choice, you will be prompted with the **Pulse product-specific End User License Agreement (EULA)**. You will only be able to access the projector software once you have fully read and approved the EULA.

### GUI – Status Screens

While the projector menu is not active, or the projector is Ready or Standby mode, the Status screens remain visible. These screens give an overview of the state of the projector and can be navigated through using the left and right arrow keys, or by swiping the screen left or right. The status screens are the following:

- **Dashboard:** The main overview. This screen displays all the chosen options on the projector (chosen source, blending/masking, display mode, etc).
- **About:** General info about the projector. This includes serial number, software version, mounted lens and light source runtime.
- **Notifications:** The error and/or warning messages that are currently active. If no messages are active, this list will be empty.
- **Preview:** A preview pane of the projected image. If no image is being projected, a test image is displayed instead.

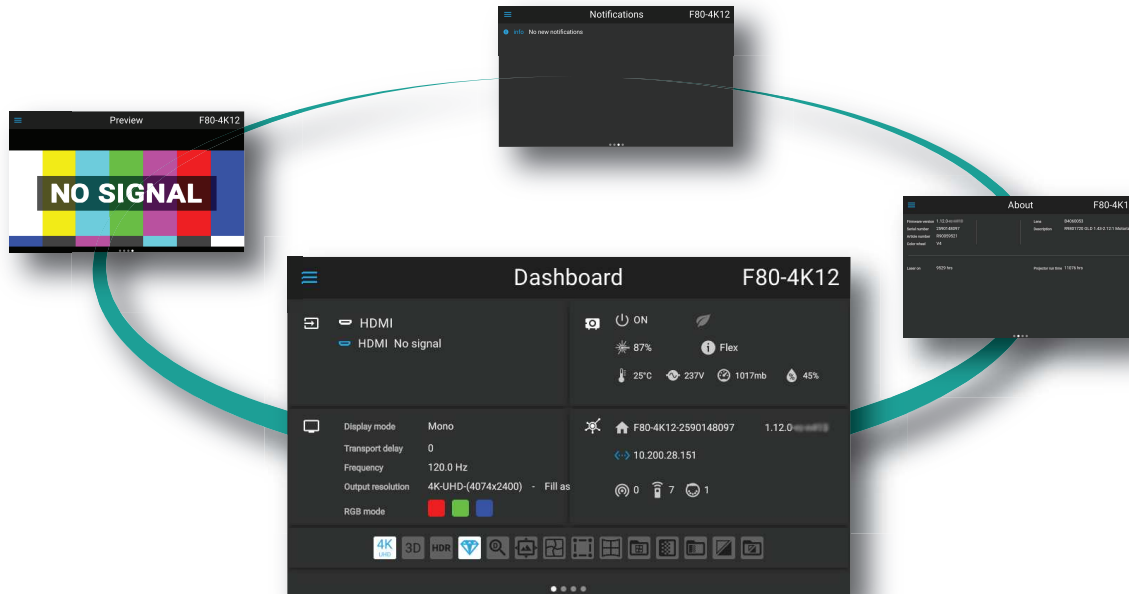

Image 5–2 Example of a Dashboard status screen

### GUI – Main Menu overview

The projector on-screen display (OSD) is the primary user interface (UI). From here, you can review and adjust all projector and display settings.

The OSD interface uses buttons to display the main menu. Each main menu contains submenus.

The OSD can be disabled by pressing the OSD on/off button.

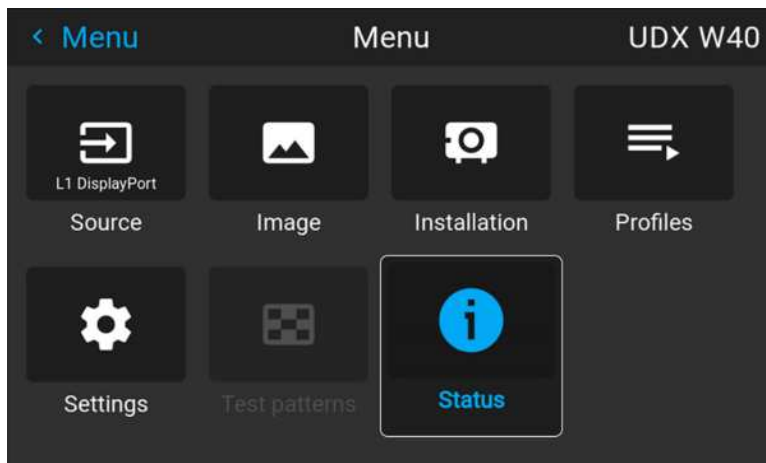

Image 5–3 Example of the home menu

The projector software platform uses access levels what each user can do. A standard user has access to the standard projector functionality. A certified service technician has also access to the advanced settings menu. This menu is password protected. This password can only be obtained by following the service partner training.

## 5.2 Navigation

### Navigation via the RCU or local keypad

Navigating the OSD can be done using the remote control or the local keypad.

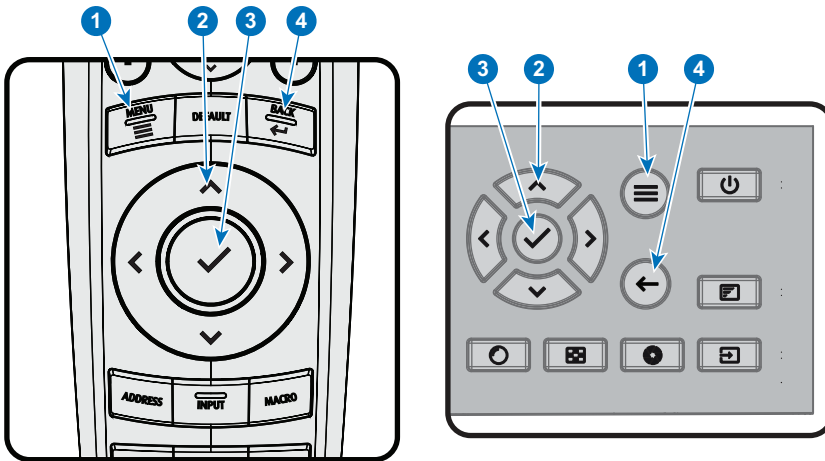

Image 5-4

To start up the menu structure, press **MENU** (1).

Use the arrow keys (**Menu Navigation** buttons) to navigate to the desired menu item (2). The background color changes to light blue.

Press the **Menu Selection** button (center key of the arrow keys), also called **OK** button, to activate that item and to jump one level deeper (3).

Use the numeral keys to enter values, or use the arrow keys to move the bar scale up or down.

Press the **Back** button to go up one level (4).

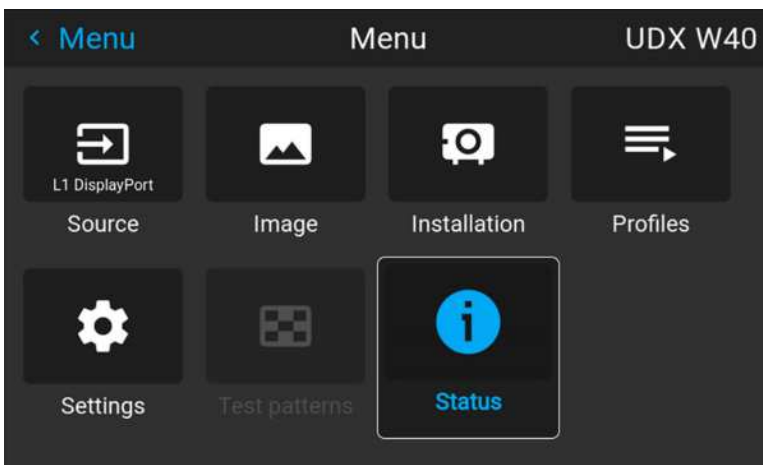

Image 5-5 Example of the home menu

Remark: a blue slider bar on the right side of the window means that there are more items to show than those currently displayed.

## Define values

Menu settings are displayed using check boxes, bar scale sliders, and drop-down lists.

To set a value:

- Press **OK** to select or deselect a checkbox (turn a function ON or OFF).
- Use the arrow keys to move the bar scale slider up or down on the value line. For a bar scale 0-9, each step will equal 10% of the total value.
- To enter the value as a direct number, press **OK**, input the digit(s), and then press **OK** again to execute and exit cursor mode e.g. OK 79 OK.

Within an input field, use the \* button as backspace button to remove an entered digit. Use the # button to enter a dot (.).

Changes to values are implemented dynamically.

To enter values with the local keyboard, use the arrow keys to select the first digit, press **OK**. Select the second digit and press **OK**. Continue until all digits are entered. Close the action by selecting the **enter** (↵) button and press **OK**. Select the **backspace** button and press **OK** to remove the last entered digit.

## Using the LCD touch display

From Pulse software 2.0 onward, the touch display functionality of the LCD panel has been activated and can be used.

Instead of using the remote control buttons or keypad keys or button, you can now:

- Touch menu icons to enter the respective menu.
- Swipe a menu up and down if not all information is not immediately visible (e.g. more than 8 (sub)menu icons being visible)
- Return to a higher menu level, by touching the blue name in the top left corner of the display.
- Use touch functionality to use menu items (check boxes, sliders, digital keyboard or keypads, etc).
- Swipe menu panes left or right when multiple panes are available (e.g. the Status menu)

## Menu memory

The OSD menu remembers the last selected sub-item as long as the projector is running. The menu memory is reset when restarting the projector from standby.

# 5.3 Test Patterns

## How to use test patterns

1. In the main menu, select *Test Patterns*.

or

Push the *Test Patterns* button on the RC.

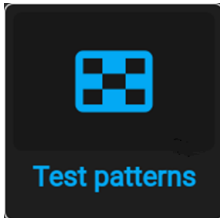

Image 5-6 Main menu, Test patterns

2. In the Test pattern menu, select the desired test pattern from the list.

You can select one of the following test patterns:

- Aspect
- Focus-Green
- Focus-bursts
- Blue / Green / Red / White
- Cyan / Magenta / Yellow
- Color bars
- Color-gradients
- Checker board
- Cross hatch
- Geometry
- Horizontal gray bars
- Vertical gray bars
- 3D Stereo

3. To turn the test pattern off, select *off* instead.

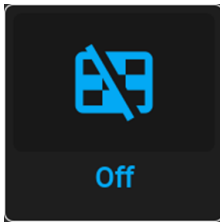

Image 5-7 Test patterns menu, test pattern off



# GUI – Source

# 6

6.1	Displaying a single source .....	50
6.2	Displaying multiple sources: Stitched layouts .....	50
6.3	Connector Settings .....	51

## About the Source menu

This menu is used to select, review and configure sources into the projector.

## 6.1 Displaying a single source

### About selecting a source

Before a source can be projected, the source signal must be connected to the source input(s) of the device and a valid synchronization signal must be available along with the source signal on at least one of the input connectors.

### How to select?

1. Press **Menu** to activate the menus and select *Source*.



Image 6-1 Main menu, Source

2. Press **OK**.

The *Select Source* menu is displayed with the actual available sources filled out.

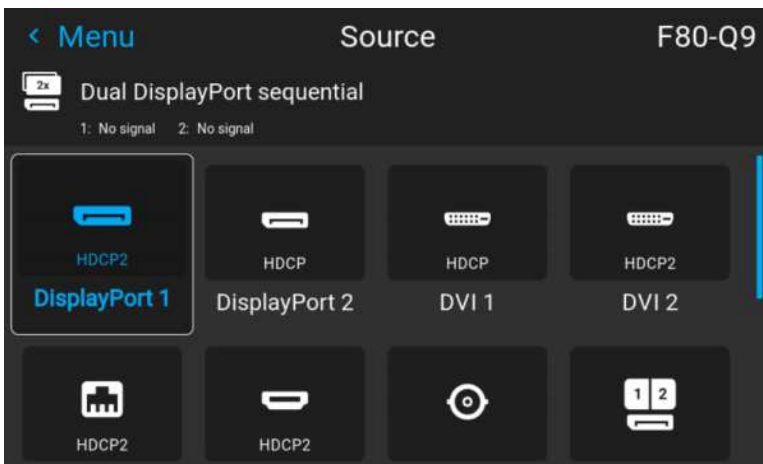

Image 6-2 Example of the input selection menu

3. Select the desired input.

## 6.2 Displaying multiple sources: Stitched layouts

### About stitched layouts

The first time you use a selected single source, the source will be displayed in the projector's native resolution. If the resolution of the source is different to the projector's resolution, the image is stretched or shrunk.

It is however possible to configure and display two source signals to make up one single image in full native resolution. This is called a **Stitched Layout**: the sources are stitched together.

The following table lists which stitched layouts you can use, and in which display mode these layouts can be used.

The table below describes the different Stitch Layouts and scan directions.

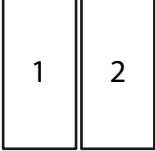
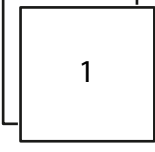
Type of layout	Description	Available connectors	Mode
 : Single	A single source is displayed in full screen	<ul style="list-style-type: none"> <li>• SDI</li> <li>• HDBaseT</li> <li>• DisplayPort (x2)</li> <li>• Dual link DVI-D (x2)</li> <li>• HDMI</li> </ul>	Mono / Active stereo
 : Dual 1 x 2	Two inputs are required. The sources are displayed next to each other.	<ul style="list-style-type: none"> <li>• 2x DisplayPort</li> <li>• 2x dual link DVI-D</li> </ul>	Mono / Active stereo
 : 2 x single	Two inputs are required. The sources are displayed one above the other.	<ul style="list-style-type: none"> <li>• 2 x DisplayPort</li> <li>• 2x dual link DVI-D,</li> </ul>	Passive stereo

### How to select a stitched layout

1. Press **Menu** to activate the menus and select *Source*.

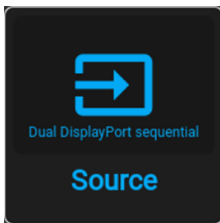

Image 6-3 Select source

2. Press **OK**.

The *Select Source* menu is displayed with the actual available sources filled out, including all available stitched layout options.

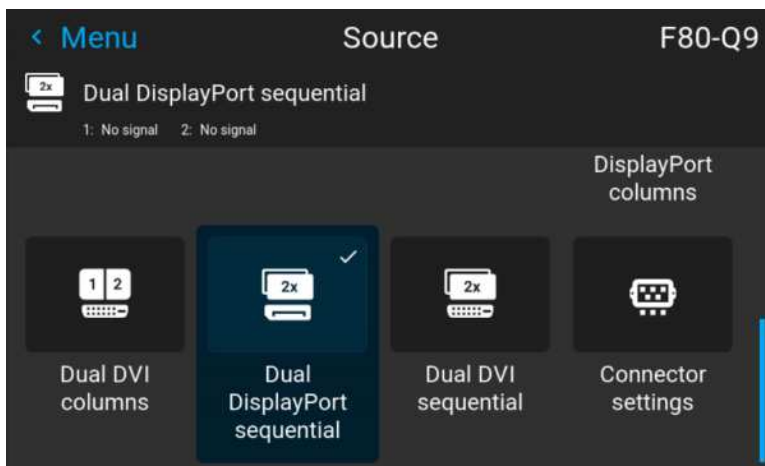

Image 6-4 Input selection menu, the stitched options

3. Select the desired stitched input.

## 6.3 Connector Settings

### About Connector Settings

The Connector Settings menu allows you to change settings for each input connector of the projector.

By default all options for every connector are set to automatic, together with the native Extended Display Identification Data (EDID).

When entering the menu for each input connector, you can change the following:

- Color Space
- Signal Range
- EDID

## How to configure a connector

1. Press **Menu** to activate the menus and select *Source*.

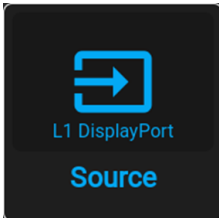

Image 6-5 Main menu, Source

2. Press **OK**.

The *Select Source* menu is displayed with the actual available sources filled out.

3. Scroll down to the bottom of the list of available sources and select *Connector Settings*.

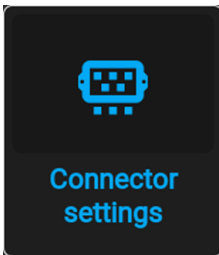

Image 6-6 Source menu, connector settings

The available input connectors are displayed.

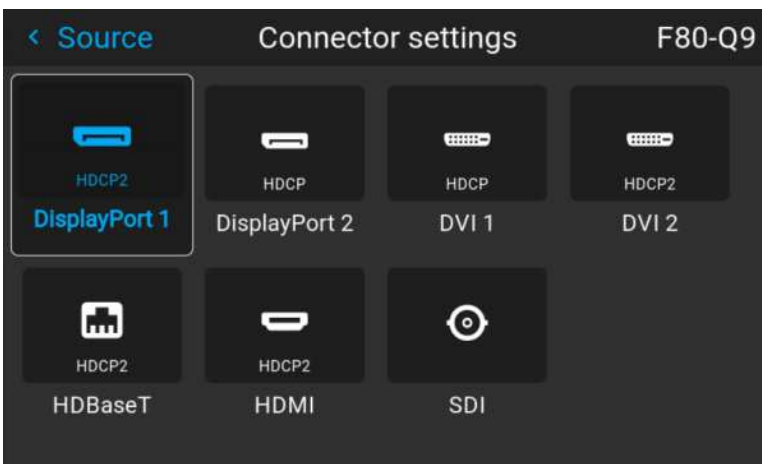

Image 6-7 Example of the Connector settings menu

4. Select the desired connector.

The **Connector Settings** menu for this connector will be displayed.

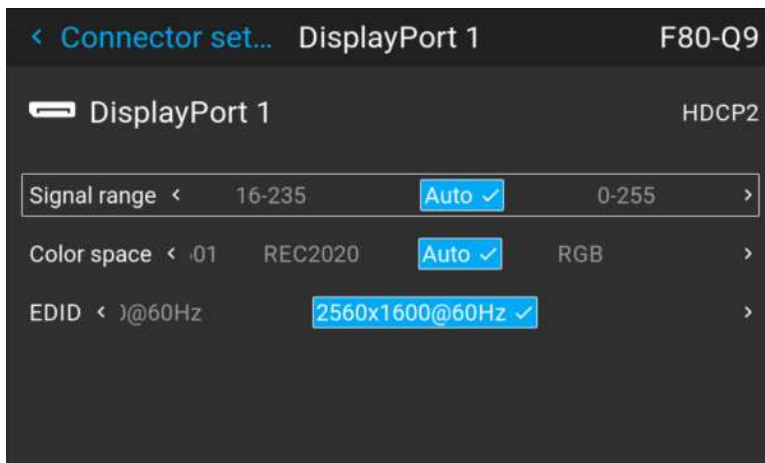



Image 6–8 Example of connector settings for an HDMI connector

5. You can change the following:

- To force a limit on the used signal range, select one of the available *signal ranges*.
- To force a limit on the color space, select one of the available *color spaces*.
- To set a video timing other than the one native for the connector, select one of the options under *EDID*.

 **Note:** You cannot change the EDID for SDI connectors.



# GUI – Image

# 7

7.1	Setting image levels manually.....	56
7.2	Adjusting the sharpness .....	57
7.3	Adjusting the gamma correction.....	58
7.4	Setting the desired Gamma type .....	59
7.5	Digital Shift & Zoom .....	61
7.6	RealColor P7.....	65
7.7	Setting the output resolution .....	67
7.8	BrilliantColor™.....	68
7.9	Displaying HDR content .....	69

## 7.1 Setting image levels manually

### Purpose

**Contrast:** Change the contrast of the complete output signal (main and PiP window together) of the projected image.

**Brightness:** Change the brightness of the complete output signal (main and PiP window together) of the projected image.

**Saturation:** Change the saturation of the complete output signal (main and PiP window together) of the projected image.

### How to set up Contrast

1. In the main menu, select *Image* → *Contrast*.

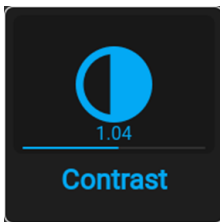

Image 7-1 Image menu — Contrast

2. Use the ◀ or ▶ key to change the contrast enhancement until the desired value is reached (adjustable between 0 and 2).

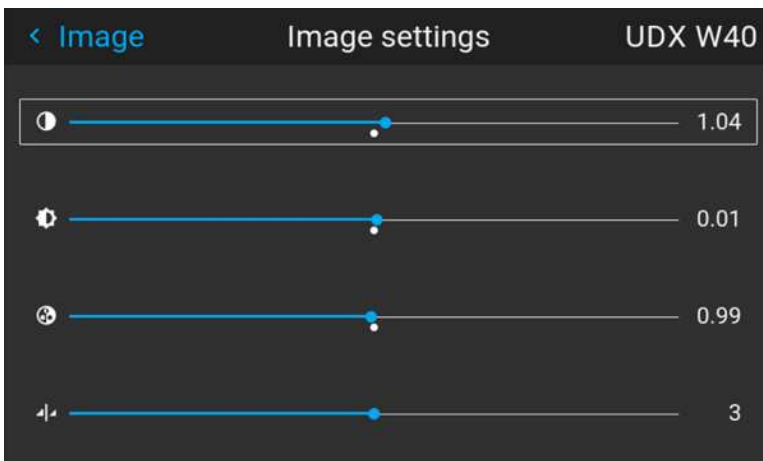

Image 7-2 Example of the image sliders, contrast is the first slider

3. If necessary, use the ▲ or ▼ key to select the other image adjustment options.

### How to set up Brightness Level

1. In the main menu, select *Image* → *Brightness*.

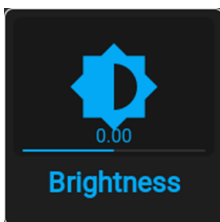

Image 7-3 Image menu — Brightness

2. Use the ◀ or ▶ key to change the brightness until the desired value is reached (adjustable between –1 and 1).



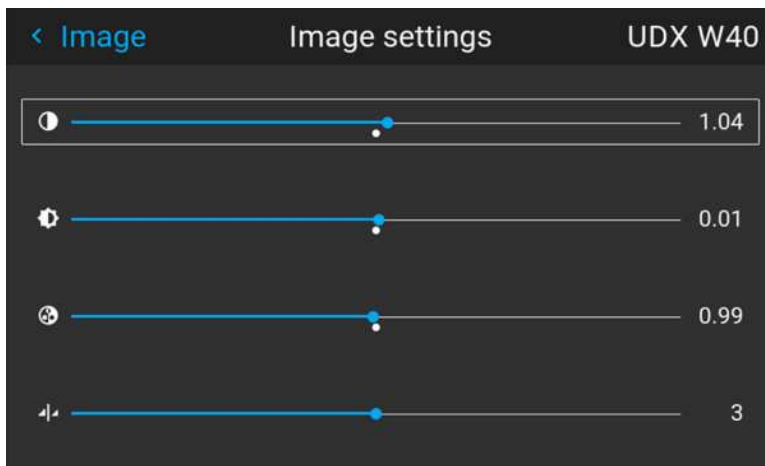

Image 7-4 Example of the image sliders, brightness is the second slider

3. If necessary, use the ▲ or ▼ key to select the other image adjustment options.

### How to set up Saturation Level

1. In the main menu, select *Image* → *Saturation*.

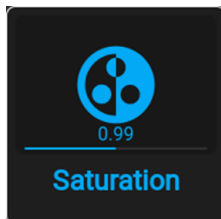

Image 7-5 Image menu — Saturation

2. Use the ◀ or ▶ key to change the saturation until the desired value is reached (adjustable between 0 and 2).

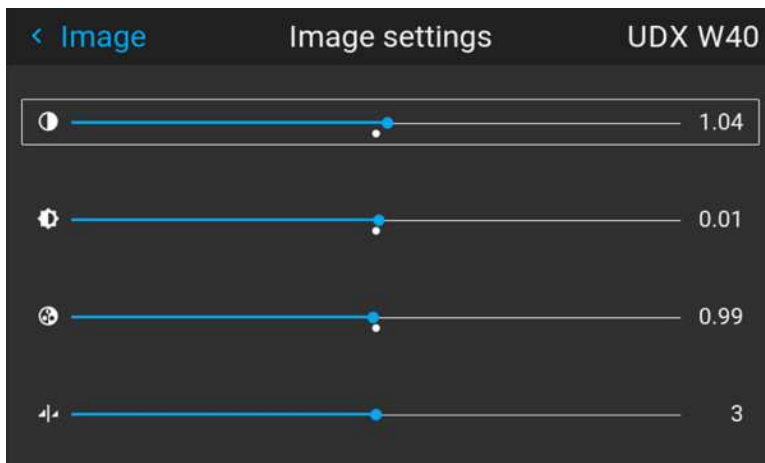

Image 7-6 Example of the image sliders, Saturation is the third slider

3. If necessary, use the ▲ or ▼ key to select the other image adjustment options.

## 7.2 Adjusting the sharpness

### About adjusting the sharpness

The sharpness adjustment amplifies the high frequency components in the picture. This means that by increase the sharpness, the picture will be perceived as sharper, and if decreased, the picture will be perceived as more blurry.

Increasing the sharpness will have the best effect in high contrast images, eg a table with text and borders. In a natural picture, high sharpness can be perceived as noise, as all details in the picture will be amplified. Available range: -2 to 8. Default value: 0

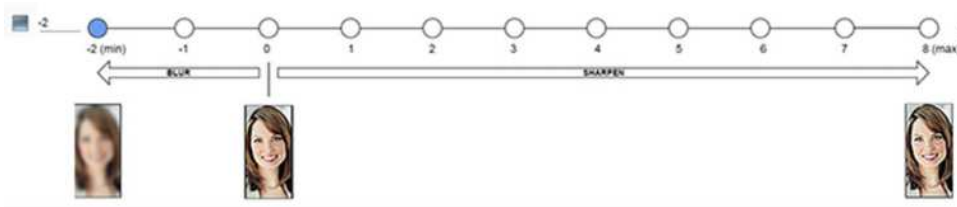

Image 7-7 Effect of sharpness adjust

### How to adjust

1. In the main menu, select *Image* → *Sharpness*.

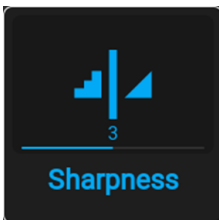

Image 7-8 Image menu – Sharpness

2. Use the ◀ or ▶ key to change the sharpness until the desired value is reached.

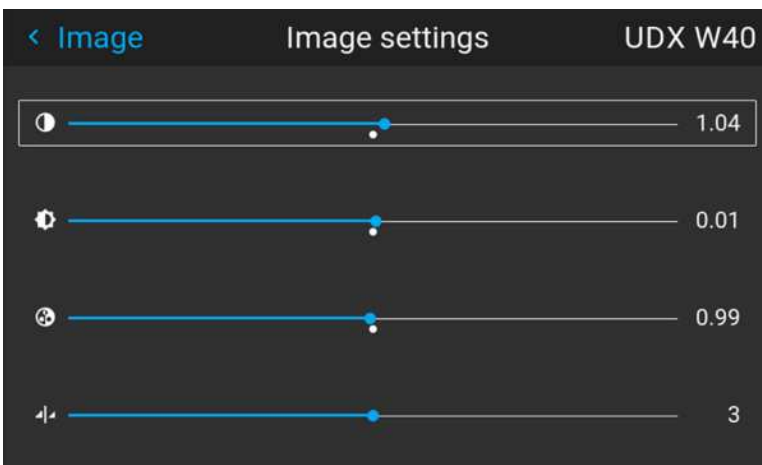

Image 7-9 Example of the image sliders, Sharpness is the bottommost slider

3. If necessary, use the ▲ or ▼ key to select the other image adjustment options.

## 7.3 Adjusting the gamma correction

### About gamma correction

Gamma correction is an image quality enhancement function that offers a richer image by brightening the already darker portions of the image without altering the brightness of the brighter portions (contrast feeling enhanced).

### How to adjust

1. In the main menu, select *Image* → *Gamma*.



Image 7-10 Image menu – Gamma

2. Use the ▼ key to select the slider.
3. Use the ◀ or ▶ key to change the gamma value between 1.0 and 2.8 . The default value is 2,2.
  -  *Tip:* The slider can be adjusted with a precision of 0.1.

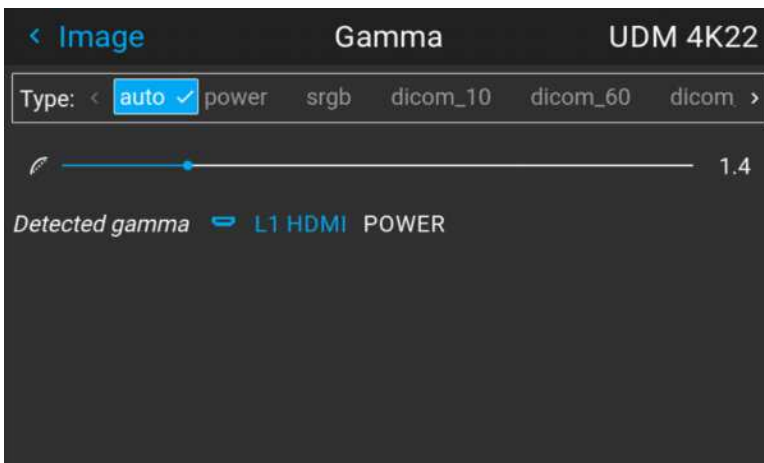

Image 7-11 Example of the gamma menu

## 7.4 Setting the desired Gamma type

### About the alternate gamma types

Next to the standard gamma correction, the projectors can be manipulated in a way to simulate gamma types for other devices or purposes. This includes sRGB (standard Red-Green-Blue), Power gamma and a number of DICOM gamma ranges.

DICOM gamma ranges are usually reserved for medical displays. While this projector is **not** a certified DICOM display, it can simulate certain specific DICOM gammas at a few selected max light outputs. The DICOM gamma assumes that both ambient light and the projector outputs black as 0 cd/m<sup>2</sup>. Then there will be a few predefined gamma curves at the following light outputs:

- DICOM 10: 10 cd/m<sup>2</sup>
- DICOM 60: 60 cd/m<sup>2</sup>
- DICOM 180: 180 cd/m<sup>2</sup>
- DICOM 250: 250 cd/m<sup>2</sup>
- DICOM 300: 300 cd/m<sup>2</sup>
- DICOM 400: 400 cd/m<sup>2</sup>



Take into account that the available DICOM gamma types may be more limited than this list, depend on your used projector type.



The only alternate gamma that can not be selected in this menu is PQ/HDR. Because the color output of HDR is dependant on extra factors such as screen luminance, a separate menu has been made available for this. For more info on PQ and HDR, refer to “[Displaying HDR content](#)”, page 69.

## Exception when using an HDR source

The only alternate color gamma that can not be selected in this menu is PQ/HDR. Because the color output of HDR is dependant on extra factors such as screen luminance, a separate menu has been made available for this (PQ).

If the source signal is HDR encoded an HDR icon will be visible next to the source signal. This is visible both in the Source selection menu, as well as the status menu.

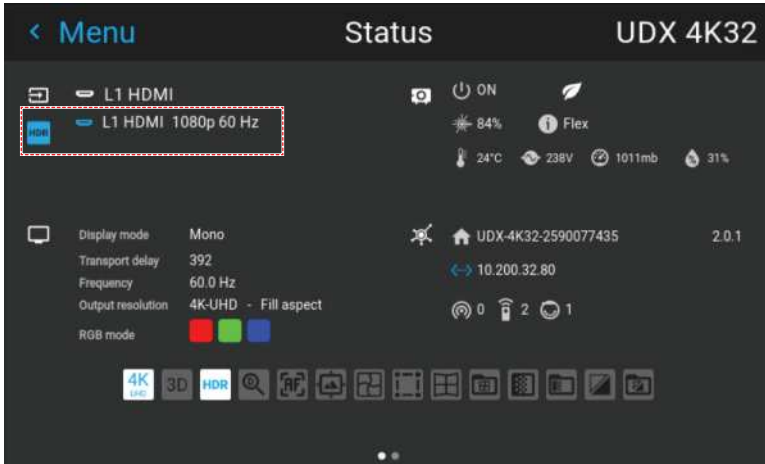

Image 7-12 Example of the HDR icon on the status menu

For more info on PQ and HDR, refer to [“Displaying HDR content”, page 69](#).

## How to adjust the gamma type?

1. In the main menu, select *Image* → *Gamma type*.



Image 7-13 Image menu – Gamma

The Gamma type menu is displayed. If source content is available, the detected gamma of the source will be displayed at the bottom of the menu.

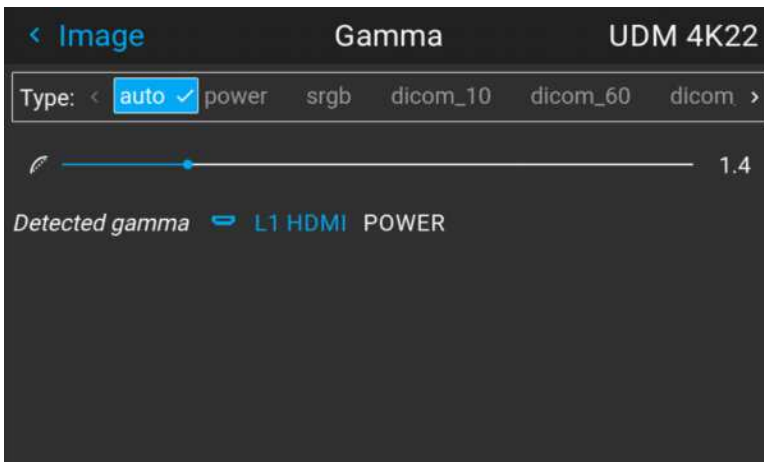

Image 7-14 Example of the gamma menu

2. Use the ◀ or ▶ key to select the desired gamma type and confirm.

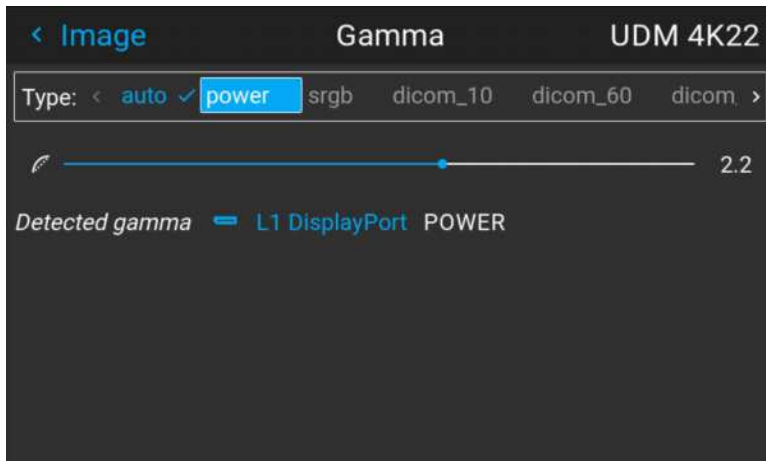

Image 7–15 Example of selecting a gamma type

*Tip:* If not sure what gamma type to select, keep the default value **auto** selected. This automatic mode will determine the used gamma type based on the incoming signal.



**However:** keep in mind when using the automatic mode, your media player needs to be configured correctly as well. While most mainstream media player devices will be configured correctly by default, we cannot guarantee this is the case for every device available on the market. If you notice the projected image seems “off”, it may be necessary to check the configuration of your media player. For more info, check the user guide of your media player device.

## 7.5 Digital Shift & Zoom

### What can be done?

The image can be optically shifted by using the vertical and horizontal lens shift.

If you want to reach a lens shift beyond what is possible with the optical shift, you can also perform a digital lens shift. This digital shift will occur on the DMD, rather than the lens holder. So take into account that this additional shift is minimal and restricted to the limits of the chip used.

For the optical zoom and lens shift, navigate to *Home* → *Installation* → *Lens*.



Lens shift is only possible when the used lens has been fully calibrated. To calibrate the current lens, navigate to *System Settings* → *Maintenance* → *Lens Calibration*.

### The effect of Digital Zoom

This function zooms in the picture digitally. When zooming in, the center of the image will increase in size. This means that the outer part of the picture will be outside the picture frame. When zooming out, the result is that the picture will be smaller than the projector's picture frame. The area outside the rendered picture will then be black.

For an example, see the following photos. The red lines in the figures represent the DMD outline.



Image 7-16 Originally picture, not digitally zoomed



Image 7-17 Picture digitally zoomed in

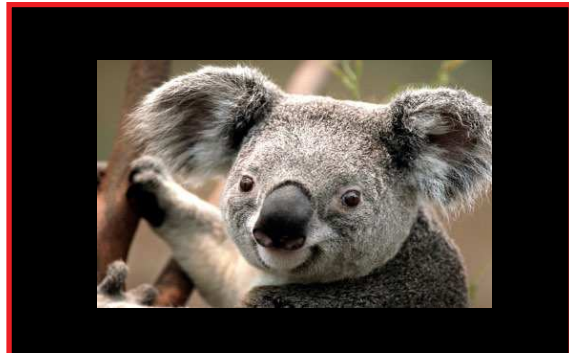

Image 7-18 Picture digitally zoomed out

### The effect of Digital Shift

This function will shift the picture digitally, meaning that the picture will be moved in any direction. As a result, some parts of the picture might be shifted outside the DMD range.

For an example, see the following pictures. The red lines in the figures represent the DMD outline



Image 7–19 Original Picture, not digitally shifted



Image 7–20 Picture shifted horizontally

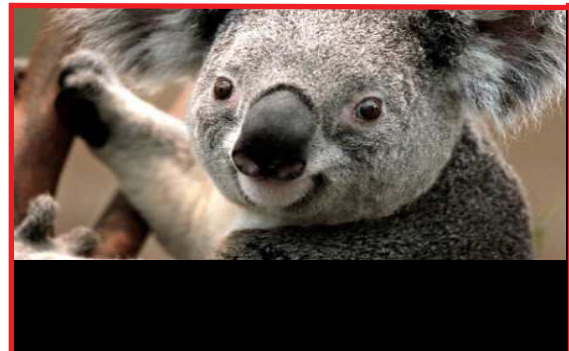

Image 7–21 Picture shifted vertically

## Digital Shift & Zoom

1. In the main menu, select *Image* → *Digital Zoom Shift*.

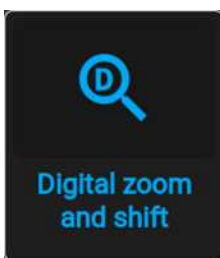

Image 7–22 Image menu, digital zoom and shift

The Digital Zoom Shift menu is displayed.

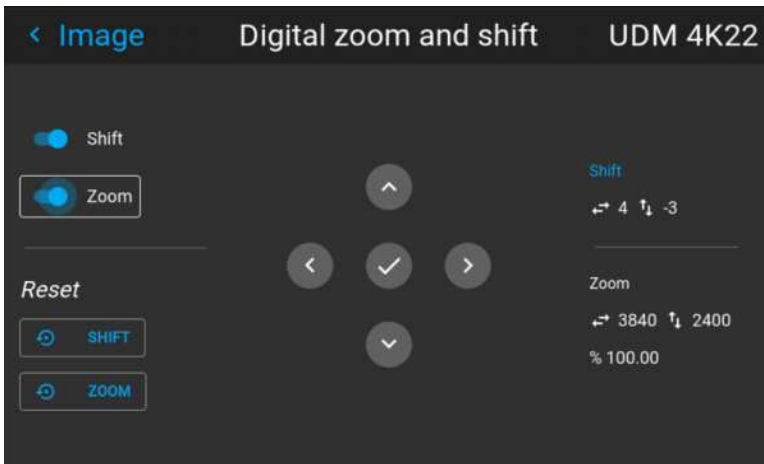

Image 7-23 Example of the digital zoom and shift menu

2. In order to optimize the digital zoom, enable the **Z**oom slider. In order to optimize the digital shift, enable the **S**hift slider.
3. When one or both of the modes are enabled, use the arrow keys to select the mini-keypad in this menu. Use the **enter** key to activate this mini-keypad.

If digital shift is enabled, the keypad will transform into the keypad for digital shift. If only digital zoom is active, it will automatically transform in they keypad for digital zoom.

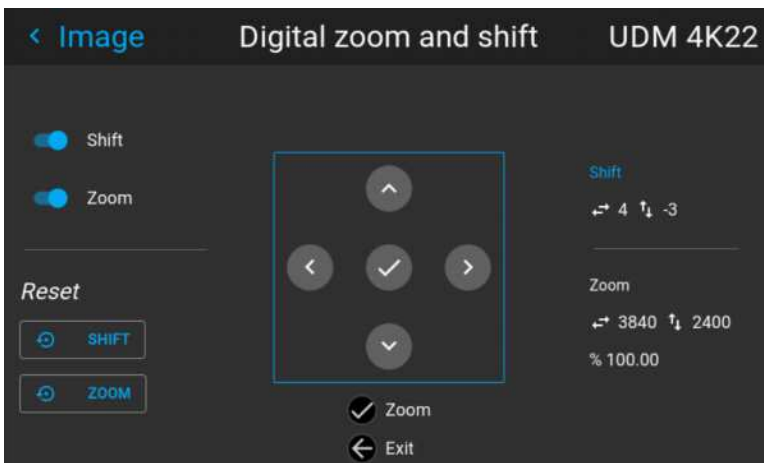

Image 7-24 Example of the enabled digital shift mode

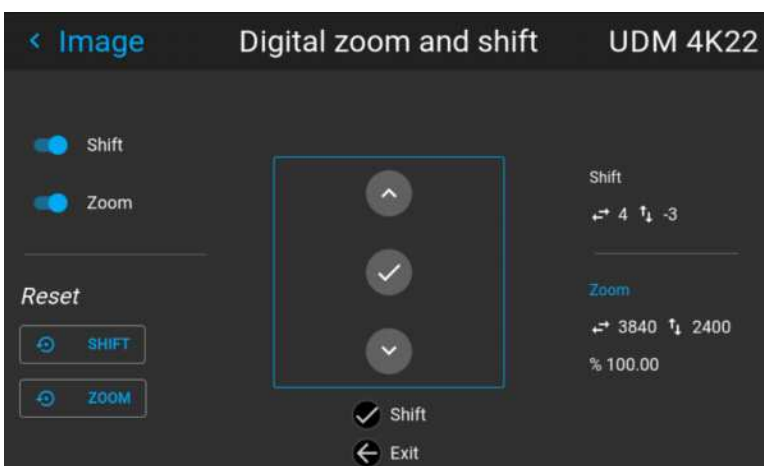

Image 7-25 Example of the enabled digital zoom mode

4. If digital shift is enabled, you can now do the following:
  - Use the ◀ or ▶ key to shift the lens (image) in horizontal direction.



- Use the **▲** or **▼** key to shift the lens (image) in vertical direction.
  - Use the **enter** key to transform the keypad to digital zoom mode (if enabled).
  - Use the **return** key to exit without saving.
5. If digital zoom is enabled, you can now do the following:
- Use the **◀** or **▶** key to zoom the lens in or out.
  - Use the **enter** key to either finish digital shift and zoom.
  - Use the **return** key to exit without saving.

## 7.6 RealColor P7

### Purpose

When blending images from multiple projectors, the perceived color coordinates of each projector can be altered to a desired common level, so that the projected colors are identical over all projectors used.

Alternatively, if you are unfamiliar with how adjusting the Colors to a specific setting, there are also a certain number of presets available, which forces the color output to specific color standards.

The selection of the presets will vary, depending on the projector type and on the peripherals installed.

### How to set custom P7 values

1. In the main menu, select *Image* → *Advanced* → *P7 Realcolor*.

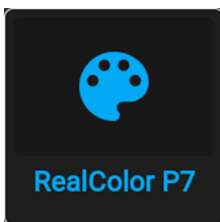



Image 7–26 Advanced settings menu – RealColor P7



The P7 menu is displayed.



Image 7–27 Example of the RealColor P7 menu, here on an HDX4K

2. Select the desired *Mode*. Choose one of the following *custom* options:
  - **Custom RGB**: 3–point color configuration.  
In RGB mode, the C, M and Y coordinates will be calculated automatically based on the R, G and B coordinates.
  - **Custom RGBCMY**: 6–point color configuration (both RGB and CMY).  
In RGBCMY mode, each color can be given a specific coordinate within the measured color triangle.
  - **Custom WHITE**: Configure only the White temperature.

3. Choose how to determine the *Whitepoint*. Choose one of the following:
    - **Coordinates:** Configure the white point via specific coordinates.  
The white point is specified using an x, y coordinate in the CIE 1931 Chart.
    - **Temperature:** Configure the white point via a color temperature slider.  
The white point is specified on a Kelvin scale between 3200K and 13000K tracking along the black body curve.
  4. Define the coordinates for each available color.  
Click on a coordinate value and select the current value. Enter the desired value with the numeric keys.
-  *Note:* You can only pick coordinates within the measured color triangle.

 You can reset all coordinates to the default values (to native) by clicking the Reset icon. 

### How to choose one of the P7 presets

1. In the main menu, select *Image* → *Advanced* → *P7 Realcolor*.

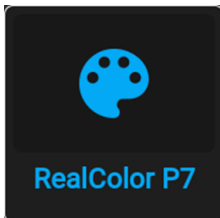

Image 7–28 Advanced settings menu – RealColor P7

The P7 menu is displayed.



Image 7–29 Example of the RealColor P7 menu, here on an HDX4K

2. Choose one of the pre-defined presets:
  - **Native:** Projector native color settings. Default setting
  - **DCI-P3:** Color standard for Cinema.
  - **EBU:** European color standard for broadcasting
  - **SMPTE-C:** American color standard for broadcasting.
  - **Rec. 709:** Color standard for high-definition televisions (HDTV).



Image 7–30 Example of one of the presets, here DCI-P3

**Note:** After choosing one of the presets, you can still alter the values of the coordinates to your own choosing, similarly to how you set custom P7 values.



Use the **Reset** icon to return to the default values of the chosen preset.



## 7.7 Setting the output resolution



Setting the output resolution is limited to F80-4K7, F80-4K9 and F80-4K12 projectors. This settings is not available for F80-Q7, F80-Q9 and F80-Q12 version.

### How to choose the output resolution

1. In the main menu, select *Image* → *Advanced* → *Output resolution*.



Image 7–31 Advanced settings menu, Output resolution



**Tip:** The current active output resolution is indicated at the bottom of the selection button.

The Output resolution menu is displayed.

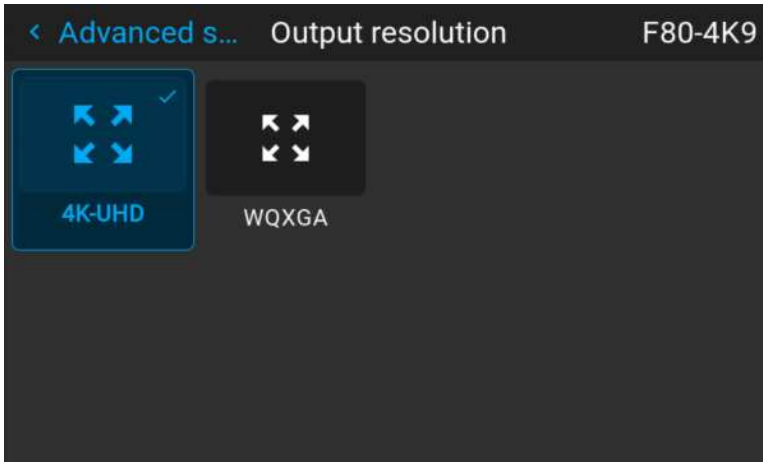

Image 7–32 Example of the available output resolutions

The list of output resolutions varies depending on the projector type. To obtain complete list of output resolutions available for a specific projector, please refer to the concerned projector in “Specifications”, page 145.

## 7.8 BrilliantColor™

### About BrilliantColor™

The BrilliantColor™ mode has an effect on the color rendering.

With BrilliantColor™ mode set to **Off**, only primary colors are generated by the light source. In **Native** and **Video** mode, a secondary color is added (C1). This has the effect of increasing the color intensity, and by that also the perceived light intensity.

### How to select the BrilliantColor™ mode

1. In the main menu, select *Image* → *Advanced* → *Output resolution*.

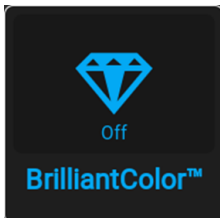

Image 7–33 Advanced settings menu, BrilliantColor™

The BrilliantColor™ menu is displayed.

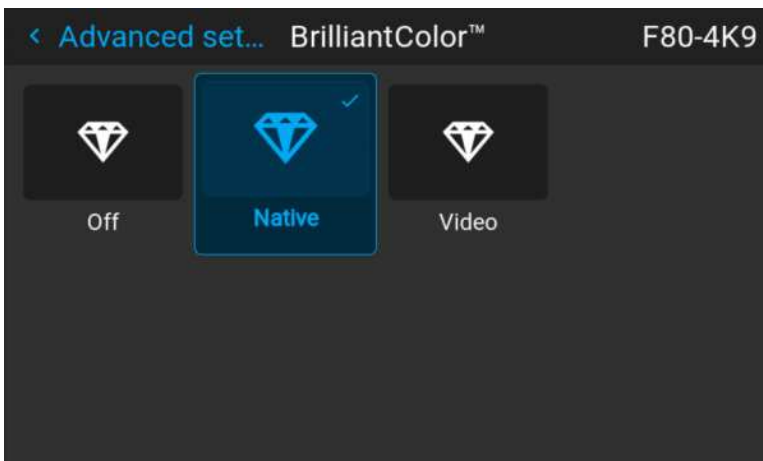

Image 7–34 Example of the BrilliantColor™ menu

2. Select the desired BrilliantColor™ mode.

## 7.9 Displaying HDR content

### About HDR and PQ

Perceptual Quantizer (PQ) is a non-linear electro-optical transfer function (EOTF) that allows for the display of High Dynamic Range (HDR) content with a luminance level of up to 10 000 cd/m<sup>2</sup> and can be used with the Rec. 2020 color space.

### When do I know my content is HDR encoded?

If the source signal is HDR encoded, an HDR icon will be visible next to the source signal. This is visible both in the Source selection menu, as well as the status menu.

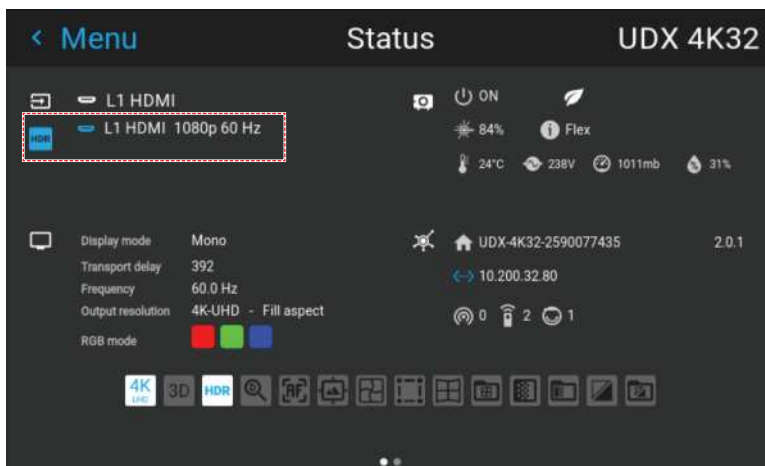

Image 7–35 Example of the HDR icon on the status menu

### How to properly display HDR content?

If your provided HDR content has been mastered with PQ (e.g. HDR10 and Dolby Vision), a few changes can be made in order to project the intended mastering on screen. These changes are necessary because HDR content has been mastered specifically for HDR capable displays that are watched in living rooms. These conditions are different from a non-HDR projector and darker cinema-like environments.

The projected HDR content depends on the following factors:

- **Mastering luminance:** This is content-specific and cannot be changed.
- **Screen luminance:** Every projection screen has a specific luminance (measured in nits or foot-Lambert). Entering this luminance in the projector will adapt the content towards the intended HDR result.
- **HDR Boost:** A variable “booster” that may amplify or downplay the HDR output.

### How to set the HDR-related parameters?

1. Make sure the chosen Gamma Type is set to *AUTO*. For more info, refer to [“Setting the desired Gamma type”](#), page 59.
2. In the main menu, select *Image* → *Advanced* → *HDR*.

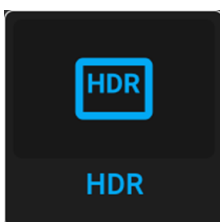

Image 7–36 Advanced settings menu, HDR

The HDR menu is displayed.

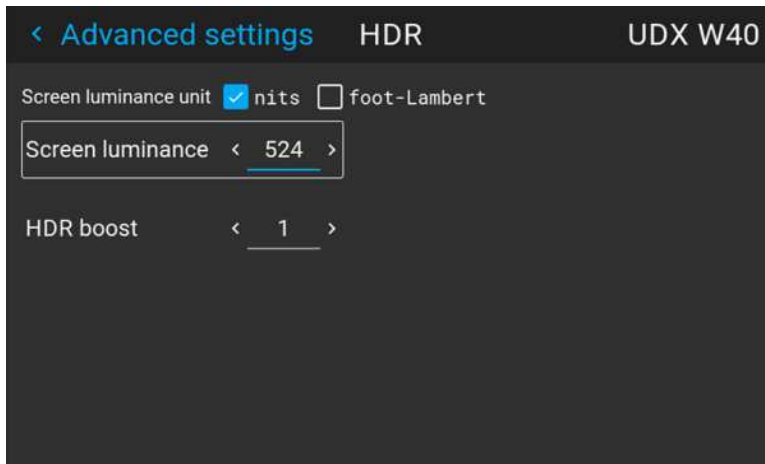

Image 7-37 Example of the HDR menu

3. Select the desired *Screen luminance unit* (nits or foot-Lambert).
4. Enter the *Screen luminance* (which is measured in nits or foot-Lambert).
5. Alter the *HDR boost* if necessary. You can modify this value to somewhere between 0.8 and 1.2.

# GUI – Installation

# 8

8.1	Configuring the lens, optical zoom-focus .....	72
8.2	Configuring the lens, shift .....	72
8.3	Configuring the lens, Shift to center .....	73
8.4	Configuring the lens, tilt sensor .....	74
8.5	Manipulating the rigging frame .....	74
8.6	Manipulating the rigging frame, center position .....	76
8.7	Orientation .....	77
8.8	Scaling modes.....	77
8.9	Warping .....	79
8.10	Blending & masking .....	91
8.11	Illumination .....	100
8.12	3D projection .....	101

## 8.1 Configuring the lens, optical zoom-focus

### What can be done?

If a motorized lens has been mounted onto the projector, you can fine-tune the projected image.

### Zoom - Focus

1. In the main menu, select *Installation* → *Lens* → *Zoom focus*.

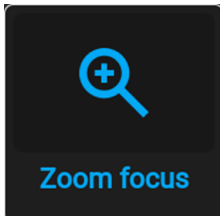

Image 8-1 Lens menu, Zoom & Focus

The Zoom and focus menu is displayed.

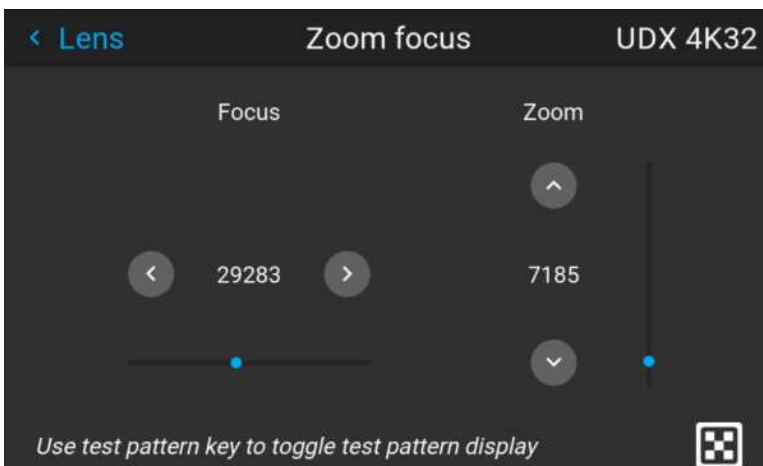

Image 8-2 Example of the zoom and focus adjustment menu

2. Use the ▲ or ▼ key to zoom the lens in or out.  
Use the ◀ or ▶ key to focus the lens to far or near.

## 8.2 Configuring the lens, shift

### What can be done?

The image can be optically shifted by using the vertical and horizontal lens shift.

If you want to reach a lens shift beyond what is possible with the optical shift, you can also perform a digital lens shift. This digital shift will occur on the DMD, rather than the lens holder. So take into account that this additional shift is minimal and restricted to the limits of the chip used.

For the digital zoom and shift, navigate to *Home* → *Image* → *Digital Zoom Shift*. For more info, see “[Digital Shift & Zoom](#)”, page 61.



Optical lens shift is only possible when the used lens has been fully calibrated. To calibrate the lens, navigate to *System Settings* → *Maintenance* → *Lens Calibration*.

### Vertical and Horizontal Shift

1. In the main menu, select *Installation* → *Lens* → *Shift*.



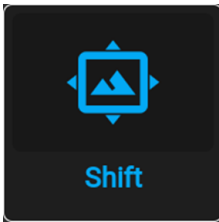

Image 8-3 Lens menu, lens shift

The Lens shift menu is displayed.

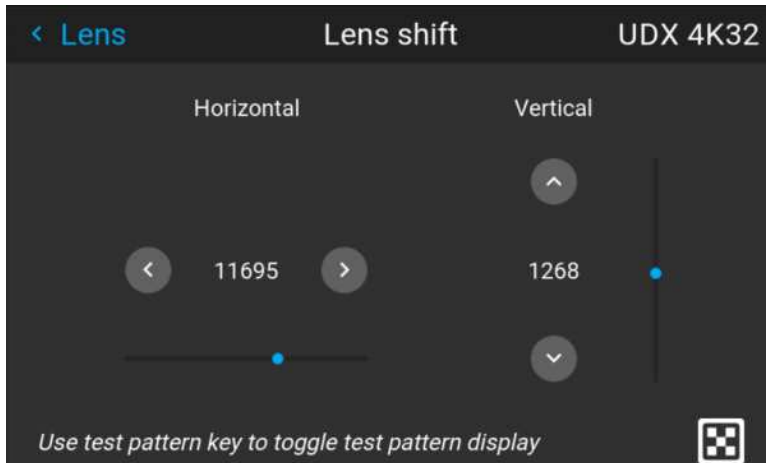

Image 8-4 Example of the lens shift menu

2. Use the ◀ and ▶ keys to shift the lens (image) in horizontal direction.  
Use the ▲ and ▼ keys to shift the lens (image) in vertical direction.

## 8.3 Configuring the lens, Shift to center

### What can be done?

The lens can be forced back to the center position by selecting **Shift to center**.

### How force lens in Mid position

1. To force lens in Mid position, select *Installation* → *Lens* → *Shift to Center*.
2. Confirm by selecting **CONFIRM**.

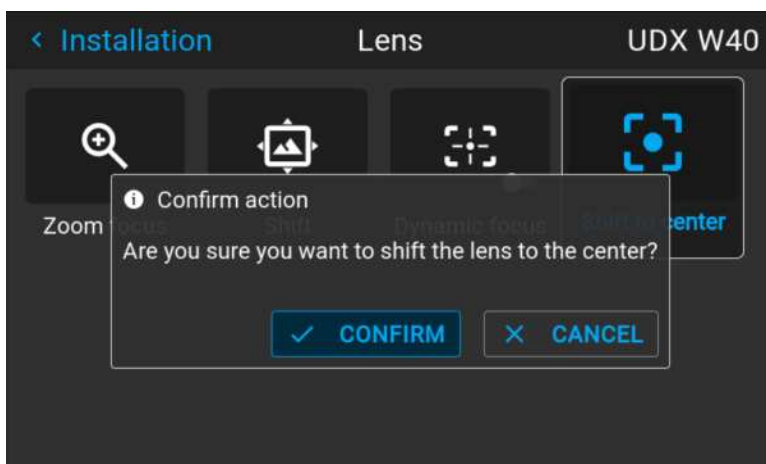

Image 8-5 Example of the Shift to center action

The lens will calibrate itself and return to the center position.

## 8.4 Configuring the lens, tilt sensor

### When to use the tilt sensor menu

The projector has a built-in tilt sensor that detects the angle at which the projector is mounted. If you are in a situation where you need to fine-tune the projector because you want to achieve a picture at a specific angle (e.g. perfectly level, or a perfect fit in a multi-projector setup), you can use the tilt sensor menu as an aid when adjusting the projector feet, rigging frame or other used mounting mechanisms.

### How to read the tilt sensor values

1. In the main menu, select *Installation* → *Lens* → *Tilt sensor*.

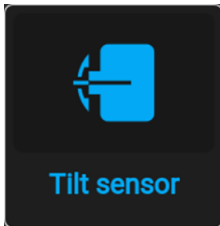

Image 8-6 Lens menu, Tilt sensor

The Tilt sensor menu is displayed.

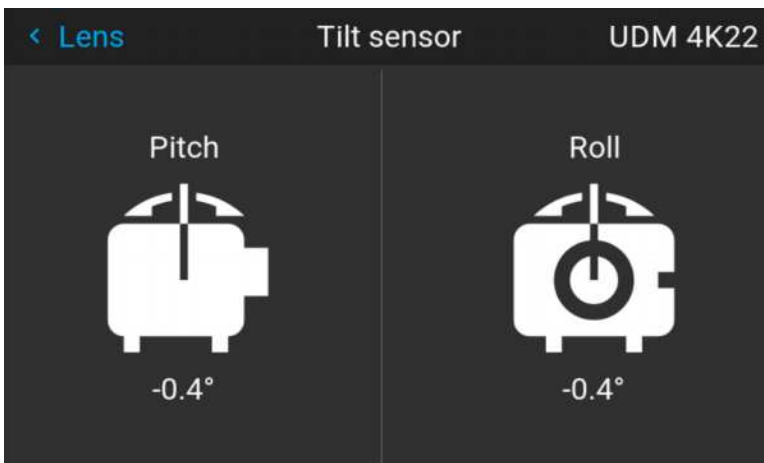

Image 8-7 Example of the tilt sensor menu



If you notice the tilt sensor isn't working correctly (e.g. when compared to a level), you can calibrate the sensor in the settings menu. For more info, see "[Advanced settings – Tilt sensor calibration](#)", page 137.

## 8.5 Manipulating the rigging frame

### When can you manipulate the rigging frame?

You can manipulate the rigging frame in the Pulse menu when projector is mounted in a motorized rigging frame, otherwise this menu is not present.

### How to manipulate the rigging frame?

1. In the main menu, select *Installation* → *Lens* → *Motorized frame*.

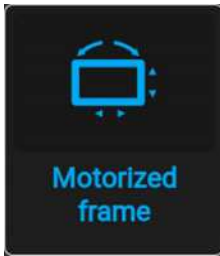

Image 8–8 Lens menu – Motorized frame

The Motorized frame menu is displayed.

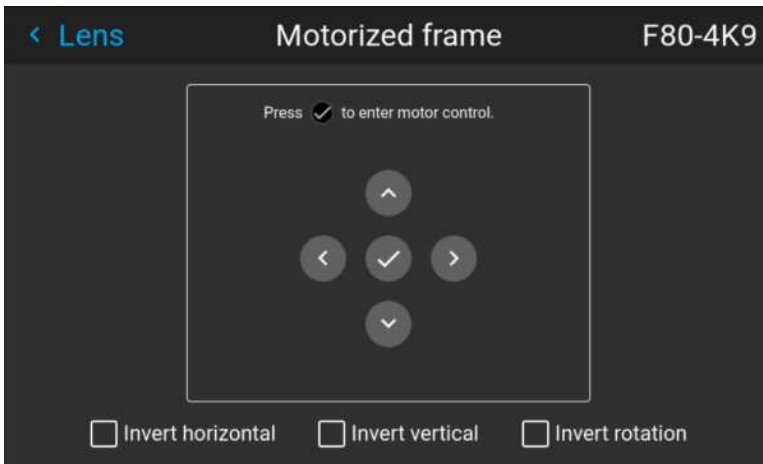

Image 8–9 Example of the Motorized frame menu

2. Press the OK key or button to activate the frame shift motors.

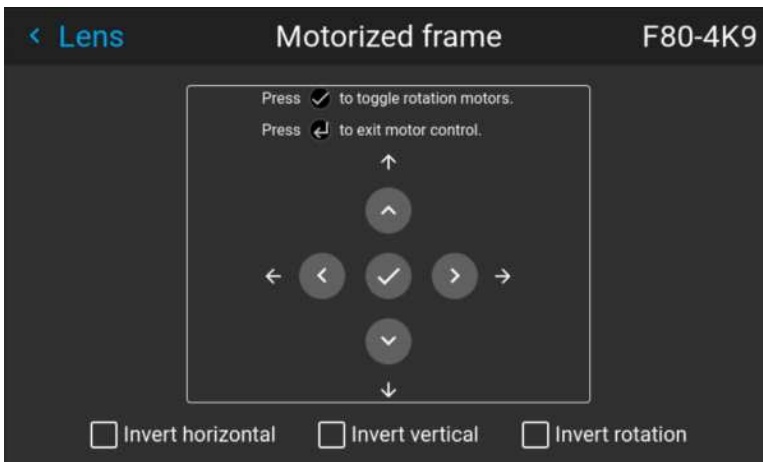

Image 8–10 Example of horizontal and vertical frame shift

3. Use the ▲ or ▼ button to shift the rigging frame (image) in vertical direction.  
Use the ◀ or ▶ button to shift the rigging frame (image) in horizontal direction.

4. Confirm with the OK button.

The frame rotation menu is displayed.

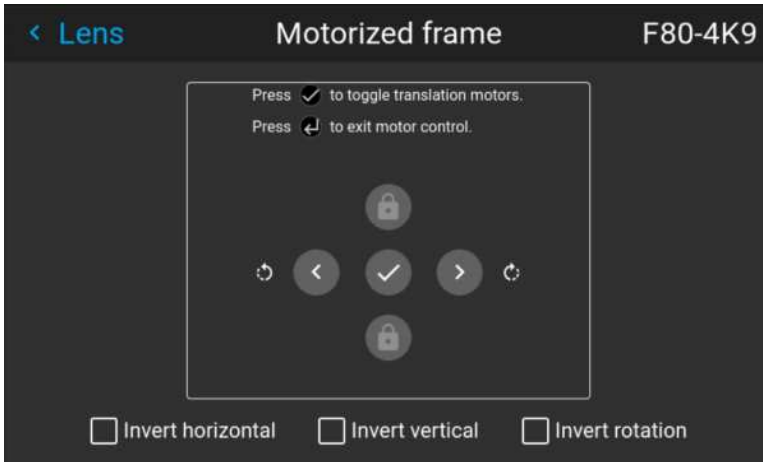

Image 8–11 Example of frame rotation

5. Use the ◀ or ▶ button to rotate the rigging frame (image) either clockwise or counterclockwise.
6. Confirm with the OK button to return to the frame shift menu, or use the Menu back button to return to the Lens menu.

## 8.6 Manipulating the rigging frame, center position

### What can be done?

The motorized frame can be forced back to the center position by selecting **Center motorized frame**.

### How to reset the motorized frame?

1. In the main menu, select *Installation* → *Lens* → *Center motorized frame*.

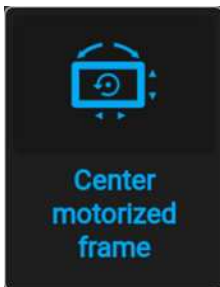

Image 8–12 Lens menu, Center motorized frame

A *confirm action* prompt will be displayed.

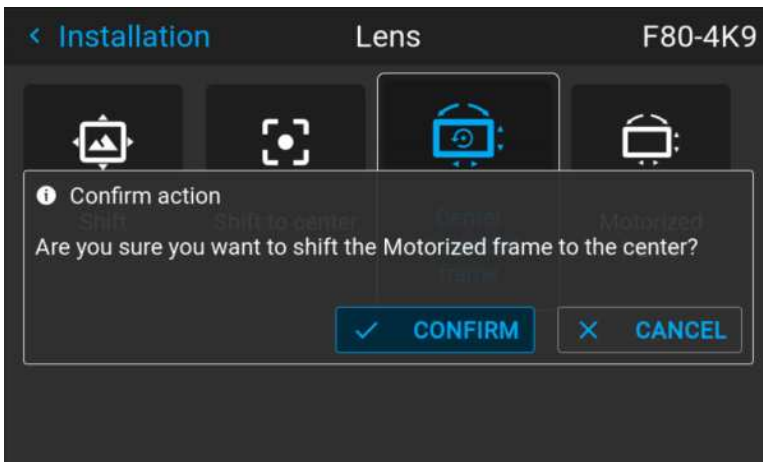

Image 8–13 Example of the Center motorized frame action prompt

2. Confirm to reset the frame to its center position.  
Wait until the frame motors have stopped before doing other actions.

## 8.7 Orientation

### What can be done?

The way of physical installation of the projector can be defined to the projector.

The following installation are possible:

- Desktop front
- Desktop rear
- Ceiling front
- Ceiling rear
- Auto front: The projector detects itself if it is ceiling or table mounted and projects always a readable image.
- Auto rear: The projector detects itself if it is ceiling or table mounted and projects always a readable image.

### How to set the correct orientation

1. In the main menu, select *Installation* → *Orientation*.

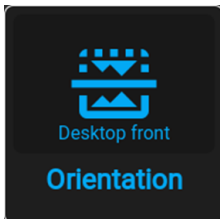

Image 8–14 Installation menu, orientation

The Orientation menu is displayed.

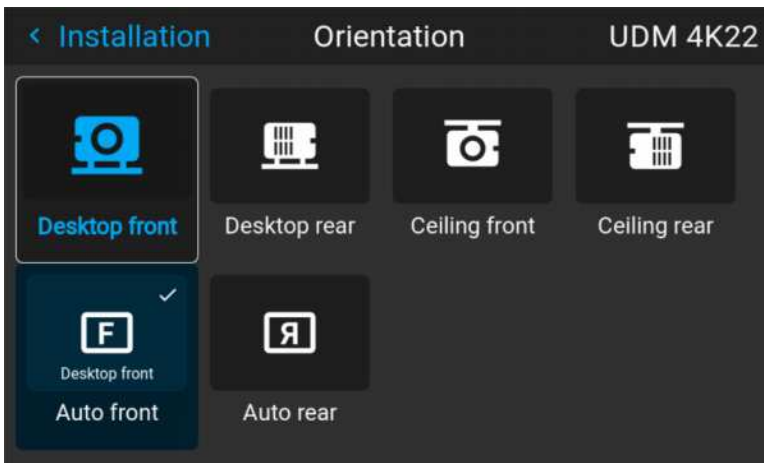

Image 8–15 Example of the orientation menu

2. Use the ◀ or ▶ keys to select the projector orientation mode and press **OK** to activate.

## 8.8 Scaling modes

### About scaling modes

While the default mode of projection is to fill the screen while respecting the aspect ratio (fill aspect), it is also possible to stretch the image in a different way. You can choose from one of the following scaling methods:

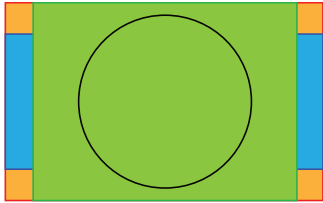
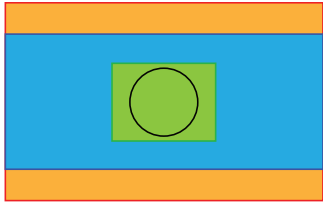
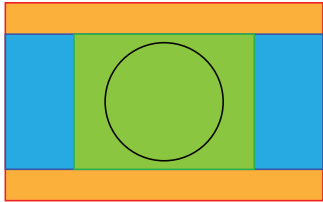
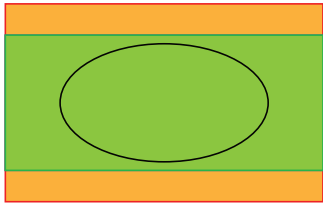
Scaling Mode	Explanation	Example image <sup>1</sup>
Fill aspect	<b>Default scaling mode.</b> Stretches the image to the native resolution of the DMD, while respecting the original aspect ratio.	
1:1	An exact rendering of the source signal, which may be smaller than the native resolution	
Fill screen	Fills the screen to the screen size defined in the Screen Size menu, while respecting the original aspect ratio. For more info on adjusting the Screen Size menu, see <a href="#">“Warping – Screen Size”, page 80</a> .	
Stretch	This mode stretches the image to the screen size defined in the Screen Size menu, while ignoring the original aspect ratio. For more info on adjusting the Screen Size menu, see <a href="#">“Warping – Screen Size”, page 80</a> .	

## Setting a scaling mode

1. In the main menu, select *Installation* → *Scaling*.

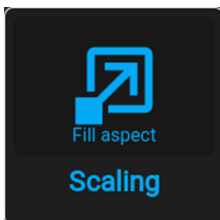

Image 8–16 Installation menu, scaling

The scaling mode menu is displayed.

1. Example using a screen of 2,35:1, an input signal of 4:3 and a projector with a native resolution of 3840 x 2400

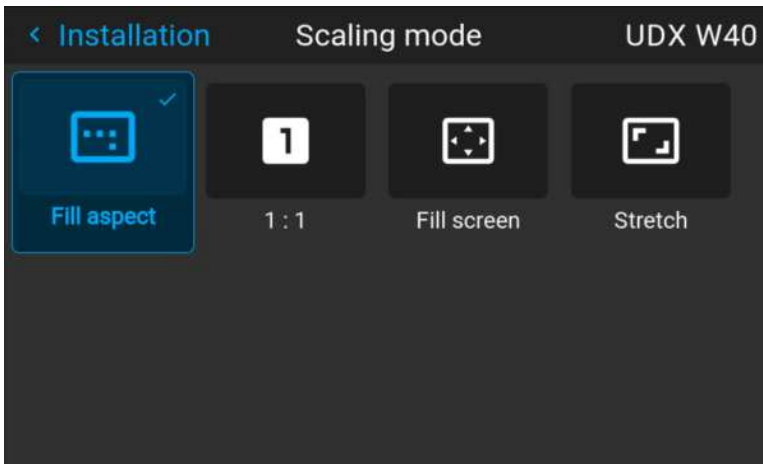

Image 8–17 Example of the scaling mode menu

2. In the Scaling menu, select the desired scaling mode and confirm.

## 8.9 Warping

### About warping

Image warping is the process of digitally manipulating an image to compensate for the distortion of the screen. Consequently, it can also be used to generate an image with irregular shape.

While an image can be transformed in various ways, pure warping doesn't affect the colors.

### 8.9.1 Warping – On/Off

#### About warping on/off

By toggling between on and off the warping functionality can be enabled or disabled.

#### How to toggle

1. In the main menu, select *Installation* → *Warp*.

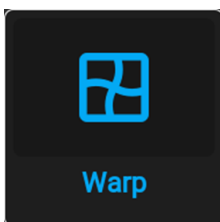

Image 8–18 Installation menu, warp

The Warp menu is displayed.

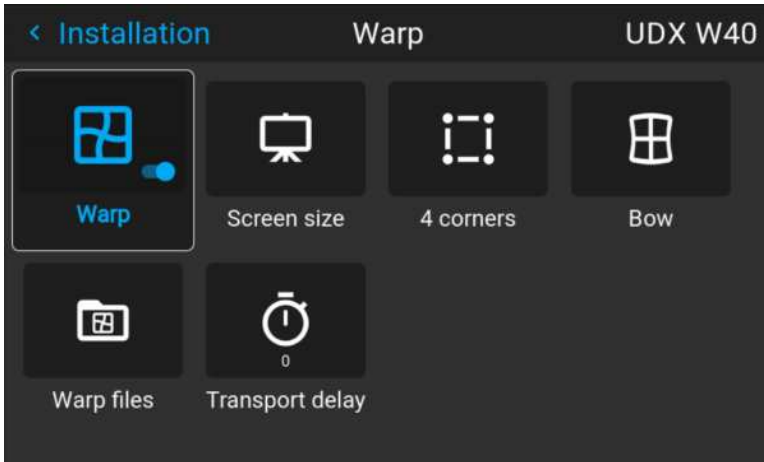

Image 8–19 Example of the Warp menu

2. In the Warp menu, click *Warp* to toggle between *On* and *Off*.

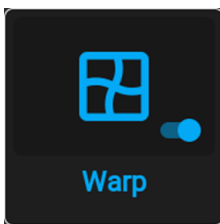

Image 8–20

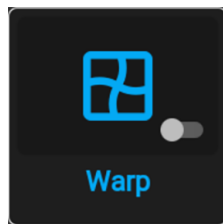

Image 8–21

## 8.9.2 Warping – Screen Size

### About (Warp) Screen Size adjustment

If the used source aspect ratio is different than the projector aspect ratio, e.g. source is 16:9 and projector is 16:10, then black bars will be projected. In the example case a black bar on top and bottom of the image will be projected. The warp area contains not only the image information but also the black bars. If we want to position e.g. the active left top corner exactly on the screen using 4 corner warp, then it is very hard to do that as we are moving the black left top corner and we do not have control over the exact position of image left top corner. By moving the outline of the warp screen size to the active image information, the corner points of the warp area are now exactly on the corner points of the active image information and makes warping much easier.

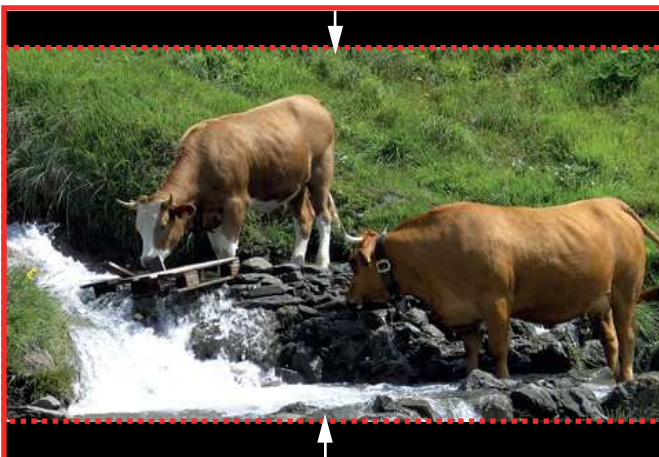

Image 8–22 Warp outline example

### How to adjust the image?

1. In the main menu, select *Installation* → *Warp* → *Screen Size*.



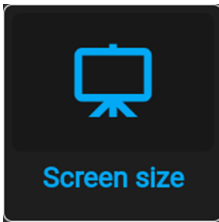

Image 8–23 Warp menu, screen size

The Screen Size menu is displayed.

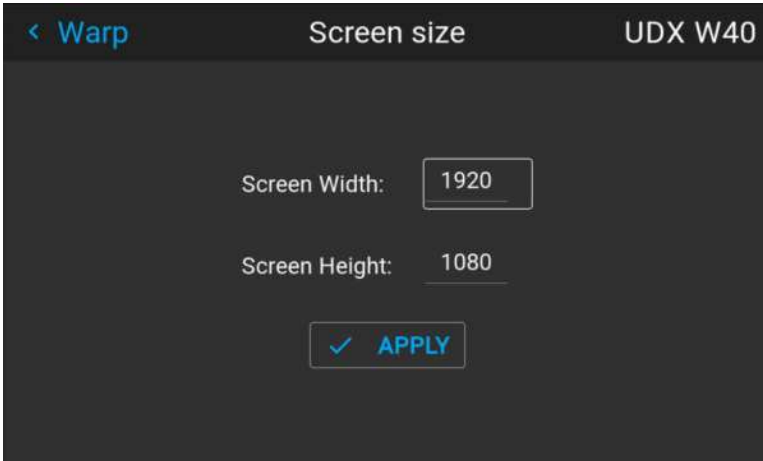

Image 8–24 Example of the screen size menu

2. Select either *Screen width* or *Screen height*.
3. Set the new value to shrink either the width or height of the warp outline so that the outline is equal with the active source.

*Tip:* A red border will be projected along with the current image. The border is a visual tool, showing the result of the adjusted outline.

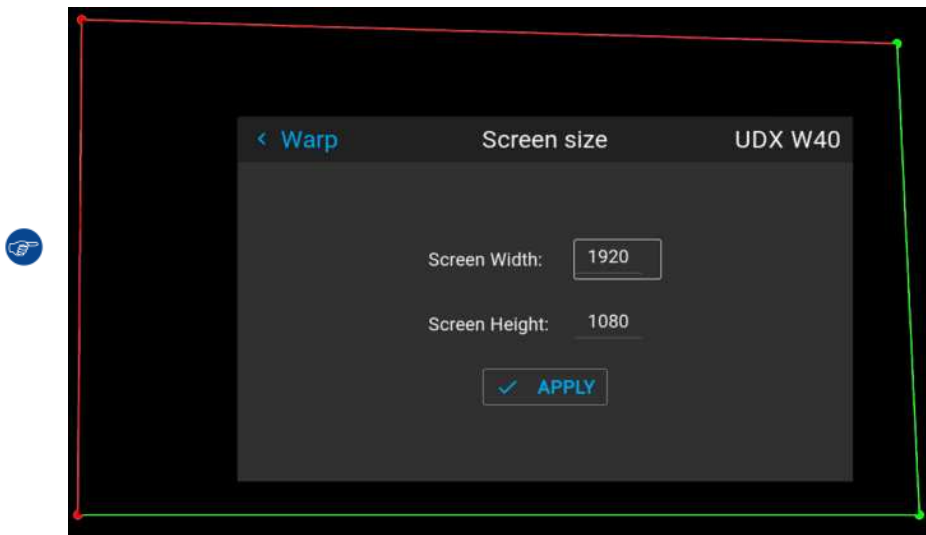

Image 8–25

*Tip:* The value can also be entered by the numeric keys on the remote control. Press \* to delete existing numbers, and enter the new value by the numeric keys.

4. Click **Apply**.

## 8.9.3 Warping – 4 corners adjustment

### About 4 Corners adjustment

4 corner adjustment is typically used when the mechanical installation of the projector prevents it from pointing perpendicularly at the screen. For example, you can overshoot the screen and use 4 corner adjustment to pull your projected image corners back into the screen.

Some examples:



Image 8–26 4 corner adjustment

### How to adjust the image?

1. In the main menu, select *Installation* → *Warp* → *4 Corners*.

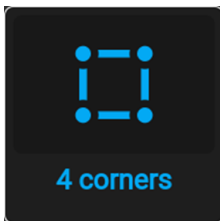

Image 8–27 Warp menu, 4 corners

The 4 corners menu is displayed.

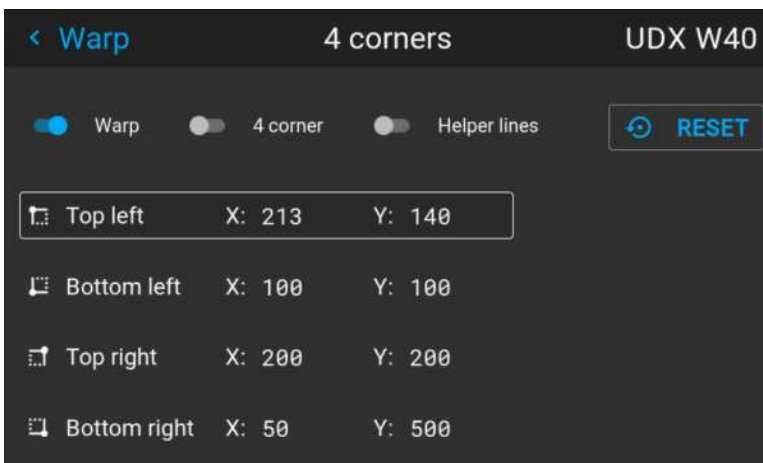

Image 8–28 Example of the 4 corners menu

2. To enable 4 Corners warping, enable the *4 corners* slider.
3. To have a visual representation of what your warp will look like, enable the *Helper lines* slider.

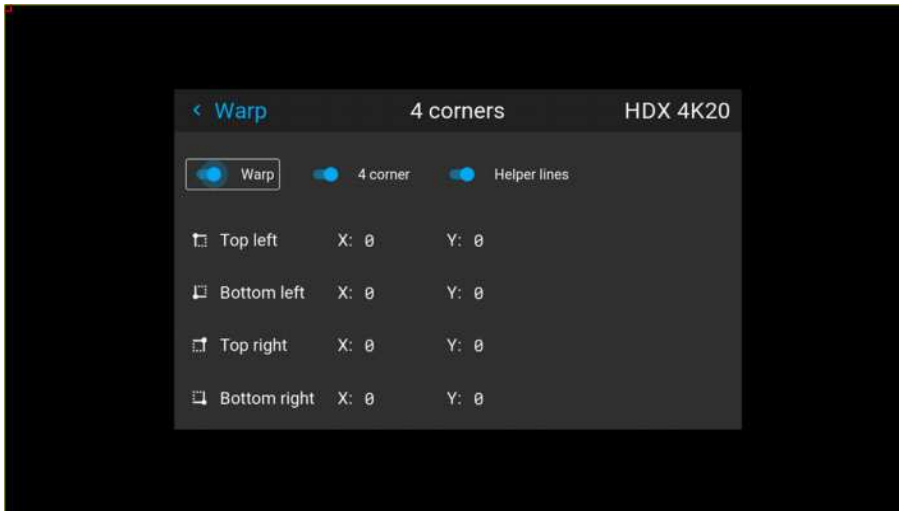

Image 8–29 Example of 4 corners warping menu, with helper lines active on the edges of the screen

4. To set warping on one of the four corners, select one of the four corners and confirm.
5. Set the desired X and Y coordinates for this corner, using the arrow keys, and confirm.

After confirming, the helper lines for that corner will jump to the entered XY coordinate (if helper lines were enabled).

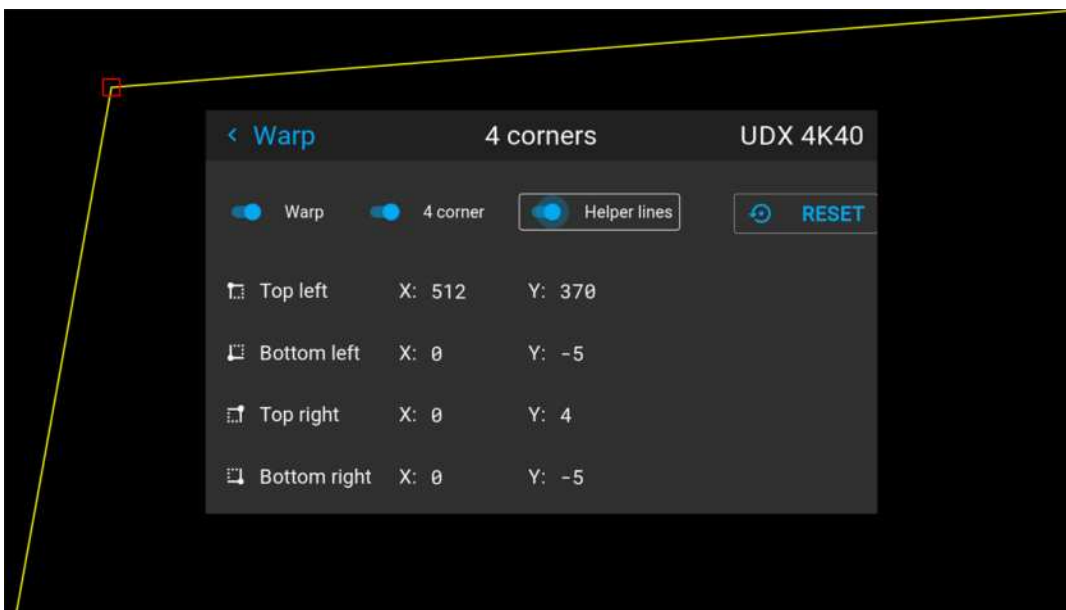

Image 8–30 Example of the 4 corners menu, with 4 corner warping and helper lines enabled

6. Repeat from go to step 4 for each corner, until all corners are warped in the desired position.



To reset the 4 corner adjustments, select *Reset* and press the **OK** button.

## 8.9.4 Warping – Bow

### About bow adjustment

A bow distortion can be adjusted so that a normal image is displayed. Positive adjustments introduce more outside bow distortion. Negative adjustments introduce more inside bow distortion.

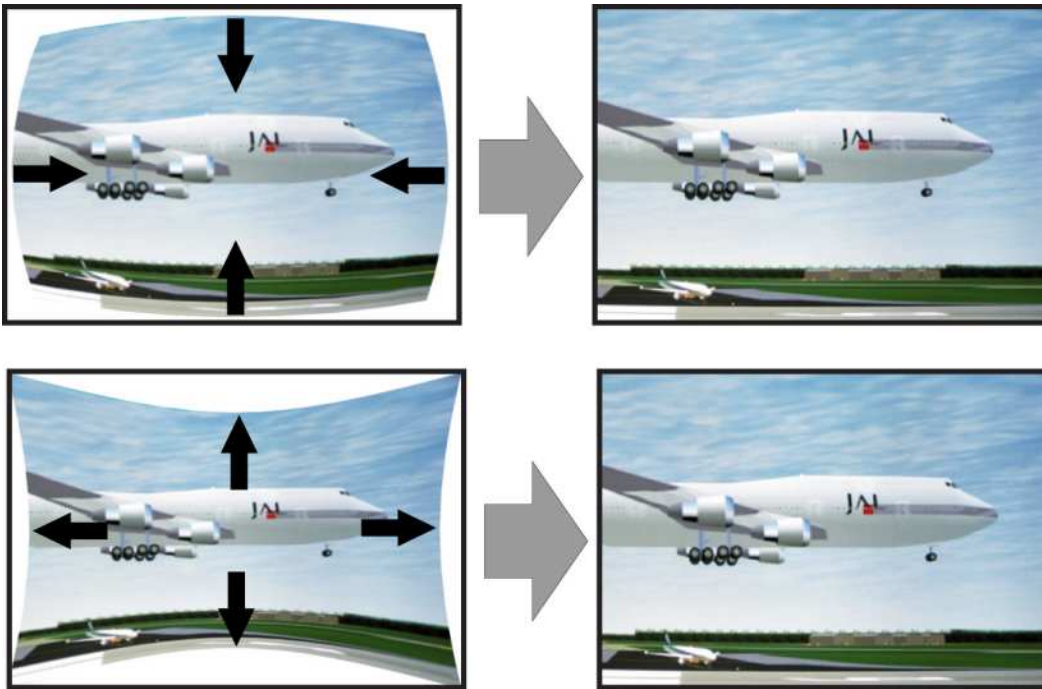

Image 8-31 Bow distortion

### Definition of angle and linearity (length) in the bow warp procedure

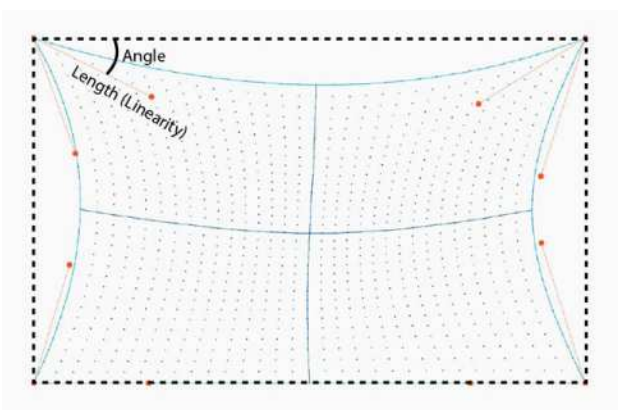

Image 8-32

### Symmetric bow correction

1. In the main menu, select *Installation* → *Warp* → *Bow*.

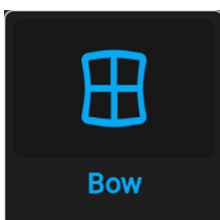

Image 8-33 Warp menu, Bow

The bow menu is displayed.

2. To enable bow correction, make sure the *Bow* slider is enabled (visible by the blue highlight).
3. To perform a symmetric adjustment, make sure the *Symmetric* slider is set to *On* (visible by the blue highlight).

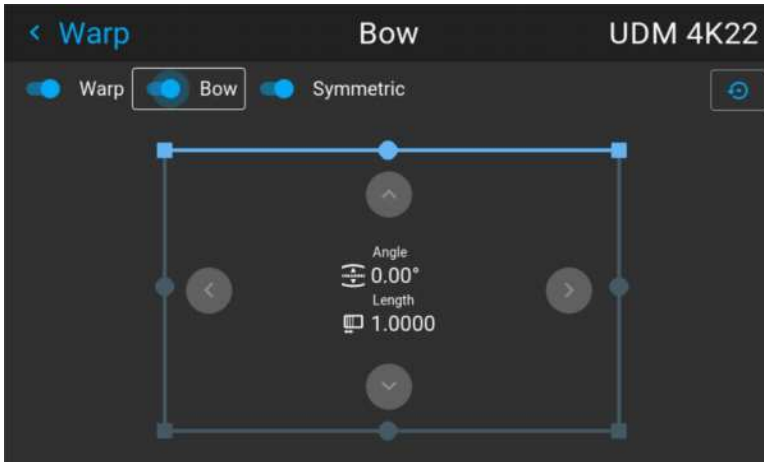

Image 8–34 Both the Bow and Symmetric sliders are set to on

4. Use the arrow keys to select the helping lines that represent the picture and confirm.  
The helping lines that represent the projected picture are now colored blue, while the others are colored white.

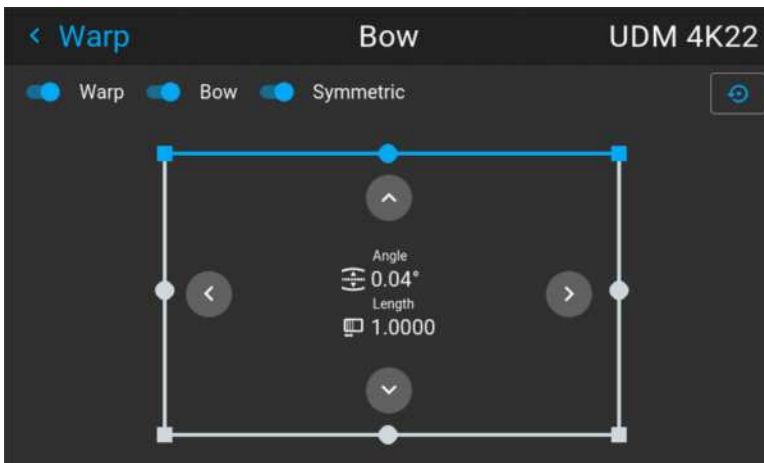

Image 8–35 The upper line is colored blue, the other sides are colored white

5. Use the arrow keys to select the side of the picture that needs a correction and confirm.

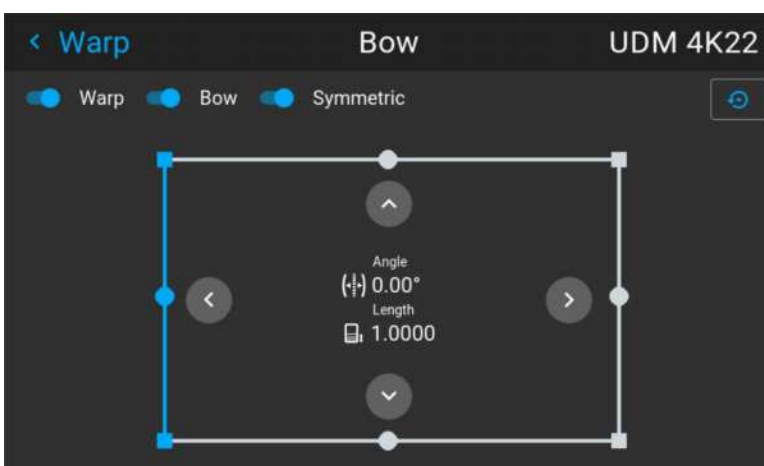



Image 8–36 Symmetric bow correction

6. Use the arrow keys to adjust the angle and linearity (length) of the vectors. Press enter to confirm and switch between angle and length.

 *Tip:* The angle is adjusted by using the up and down arrow keys. The linearity is adjusted by using the left and right arrow keys.

The correction will occur symmetrically on each side of the center of the highlighted side.

7. Repeat this step for all sides of the picture that has to be corrected, until the desired transformation has been achieved.

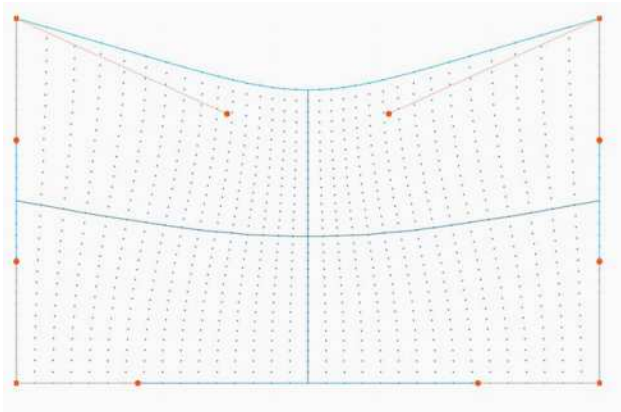

Image 8-37 Example of a symmetric bow correction

### Asymmetric bow correction

1. In the Bow menu, enable the Bow slider and disable the symmetric slider.

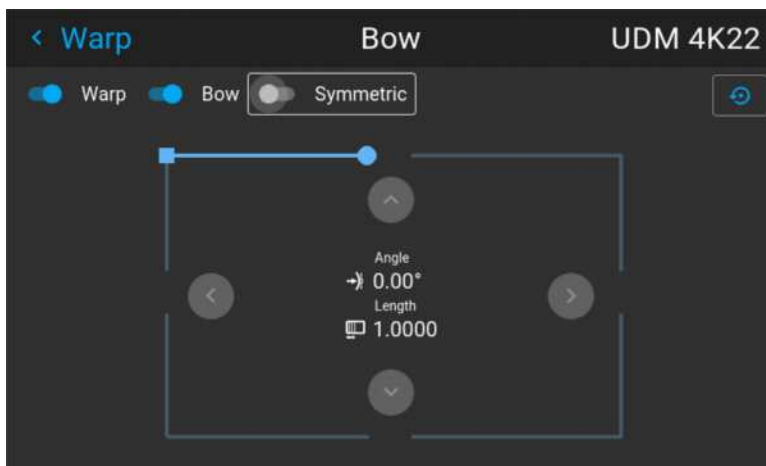

Image 8-38 Example of the bow menu, with the Symmetric slider disabled

There are now two vectors on each side of the picture that can be adjusted individually.

2. Use the arrow keys to select the helping lines that represent the picture and confirm. The helping lines that represent the projected picture are now colored blue, while the others are colored white.

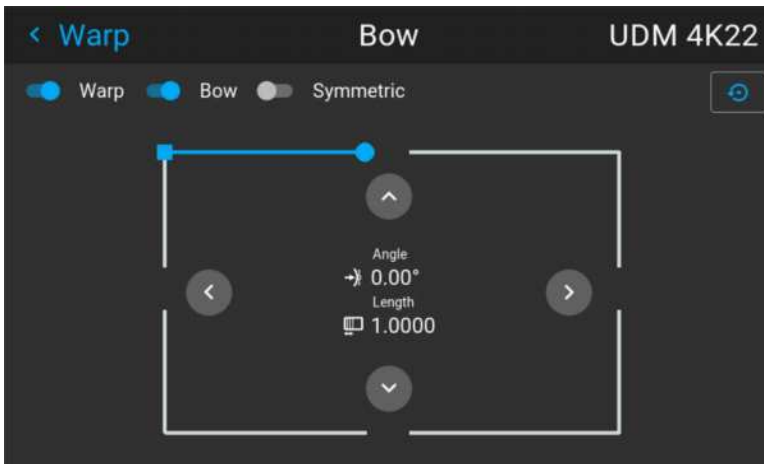

Image 8–39

3. Select the desired slider and confirm.

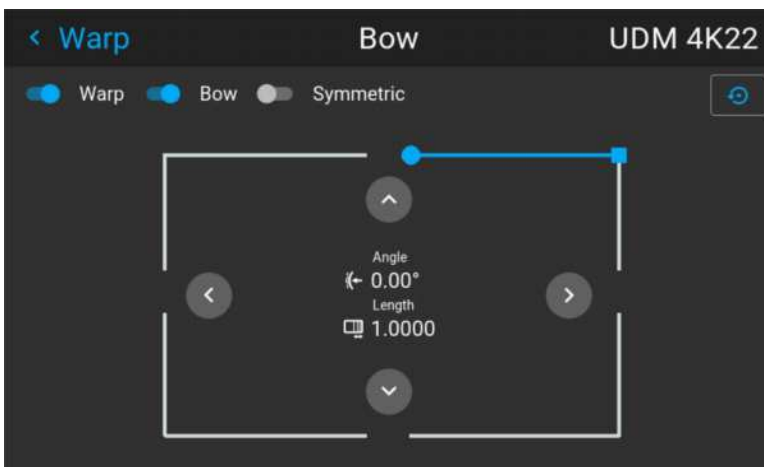



Image 8–40

4. Adjust angle and linearity (length) individually to obtain the correct correction. Press enter to confirm and to switch between angle and length.
  -  *Tip:* Adjust the angle by using the up and down arrow keys. Adjust the linearity by using the left and right arrow keys.
5. Repeat the previous steps for each side of the picture that must be corrected.
6. When completed, a transformation will occur in a way similar to the following example. Observe that the upper side of the picture now has an asymmetric bow correction.

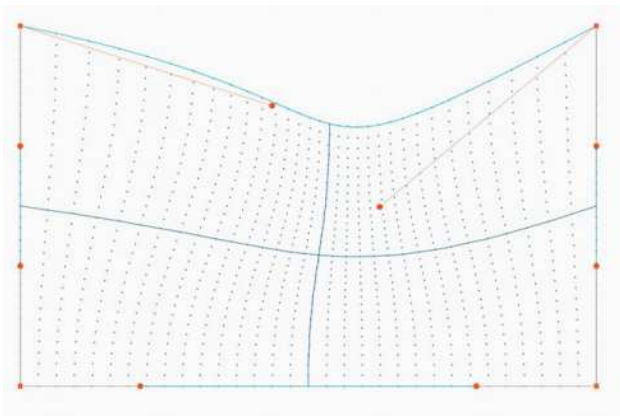

Image 8–41 Example of an asymmetric bow correction



To reset the bow adjustments, select *Reset* and confirm.

## 8.9.5 Warping – Warp files

### About custom Warp Files

Next to setting your specific warp configuration in the GUI, you can also upload or download a custom warp grid in XML format to/from the projector. This is a time-saving option when multiple projectors need an identical Warp configuration.

To upload or download warp files you can use Projector Toolset or Prospector tool to upload/download the warp grid in the format of an XML file. Alternatively, you can contact the “file endpoint” directly via the curl program or some other tool that supports http upload.

For more information on uploading/downloading Warp files using the Projector Toolset, refer to the Projector Toolset user manual.

For more information on uploading/downloading Warp files using curl or other tools that supports HTTP upload, refer to the Pulse API Reference Guide.



When uploading a warp file that is too big, or with warp parameters outside the limits of the projector, some irregularities can occur. It will show up in two ways:

- 1: No warp enabled, picture still unwarped.
- 2: Distortions and artifacts in the edges of the picture.

There will be no error messages or warnings in the display when this occurs. The above mentioned symptoms is the only indication of this case.

### How to activate an uploaded Warp grid?

1. In the main menu, select *Installation* → *Warp*.

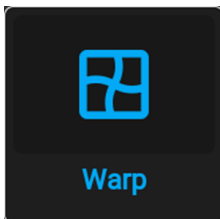

Image 8–42 Installation menu, Warp

2. In the Warp menu, select *Warp files*.

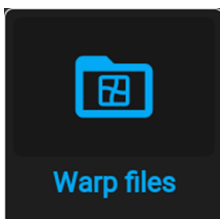

Image 8–43 Warp menu, Warp files

The Warp Files menu is displayed.



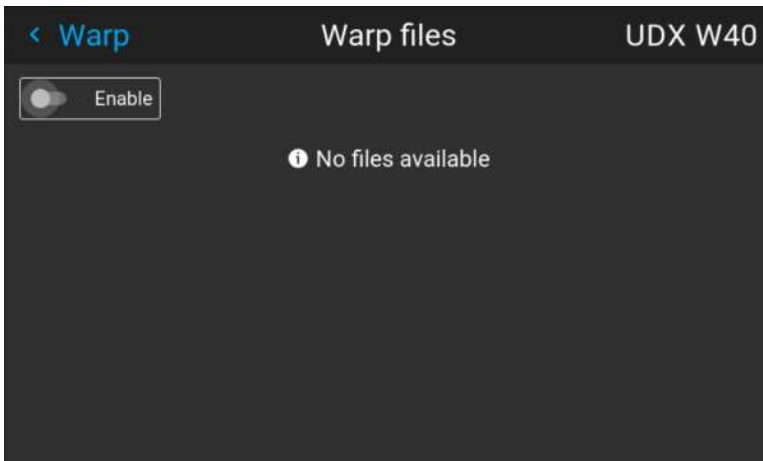

Image 8–44 Example of the Warp files menu

3. Make sure the Enable slider is set to right.
4. Select the desired warp file.

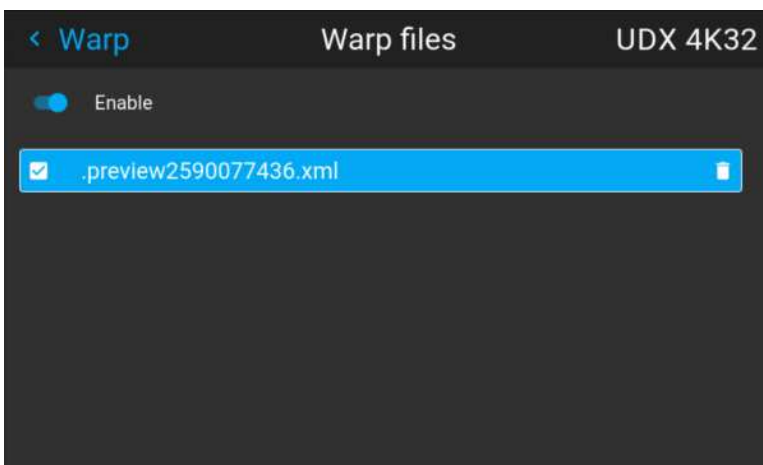

Image 8–45 Example of the Warp files menu

## 8.9.6 Warping – Latency control in a multi projector setup



### Transport latency

The added delay in the image processing chain. The value is the number of lines relative to the output resolution.



### Latency

The total time from the first pixel is coming in on an input source, until the first light representing that pixel is visible on the screen. This includes the transport delay. The value is normally given in milliseconds.

### Functional description

Every projector in a multi-projector setup will have a different latency. This latency depends on the amount of warp and on the frequency of the projected image. In order to have no visible difference in the overall projected image, the user needs to be able to control the latency of each projector.

The latency value can be read out in the status menu for each individual projector.

### How to configure transport delay?

1. Read out and note the latency of each projector in the multi-projector setup. You can find this latency under **Transport delay** in the status menu for each projector.



Image 8–46 Example of the Transport delay in the status menu

2. Identify the projector with the longest delay.
3. For each projector in the setup, select *Installation* → *Warp* in the main menu.

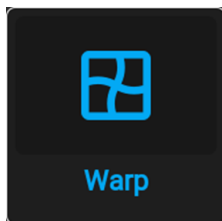

Image 8–47 Installation menu, Warp

4. In the Warp menu, select *Transport Delay*.

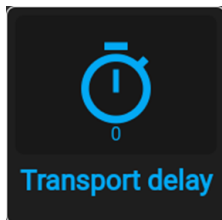

Image 8–48 Warp menu, Transport delay

The Transport menu is displayed.

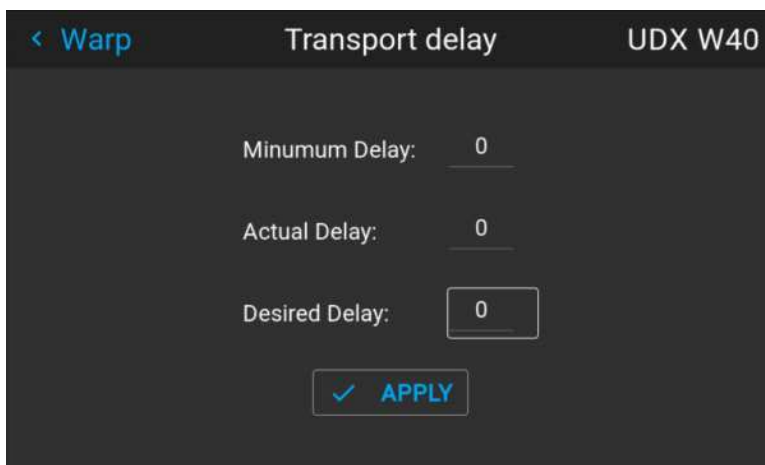

Image 8–49 Example of the Transport delay menu

5. Enter the value either by the arrow keys (one step at a time) or directly by the numeric keys on the remote control.

6. Click “Apply” to confirm the value.
7. Repeat this process for every projector in the setup.

## 8.10 Blending & masking

### About blending

Blending is used in multi channel installation to have a seamless transition between the channels. Image blending gives the appearance of a single view, thus achieving realistic immersion for the majority of wide screen applications.

The principle is that the light intensity in the blend zone from each projector will be adjusted individually, so that the rendering on the screen are perceived as from one projector.

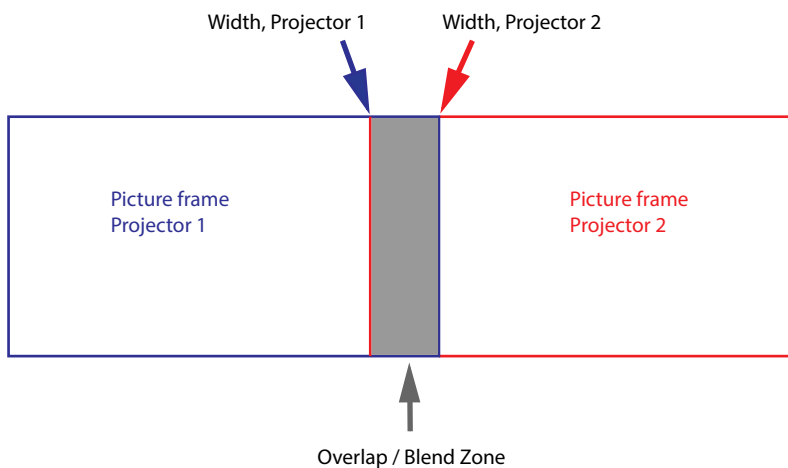

Image 8–50

From the start (mask) position, you can blend zone size per edge (left, top, right, bottom). For each edge there will be a drop-off curve for the blend zone.

### 8.10.1 Basic blend

#### How to set up a basic blend zone?

1. In the main menu, select *Installation* → *Blend and Mask* → *Basic blend*.

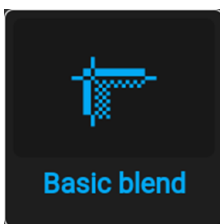

Image 8–51 Blend menu, Basic blend

The Basic blend menu is displayed.

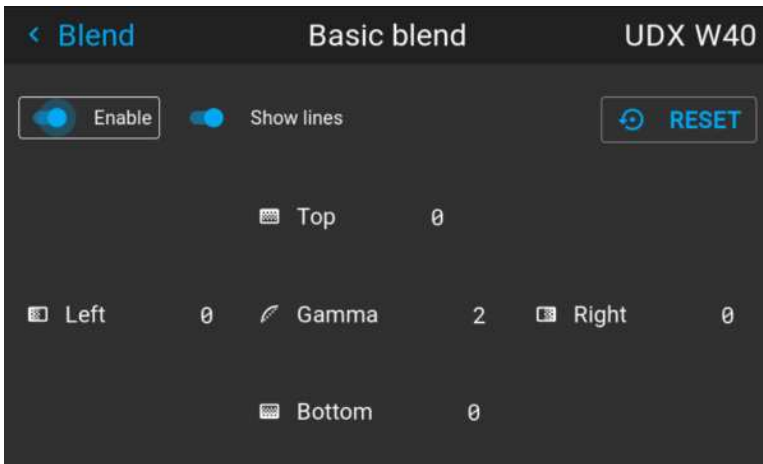

Image 8–52 Example of the basic blend menu

2. To enable blending, put the **Enable** switch to the right. The color of the switch becomes blue when enabled.
3. To project masking lines on the screen, put the **Show lines** switch to the right. The color of the switch becomes blue when enabled.
4. Determine the start position of the blend area height and width to determine the dimension of the blend zone.

When the helping lines are activated, you will get a visual indication of the screen of the installed blending area.

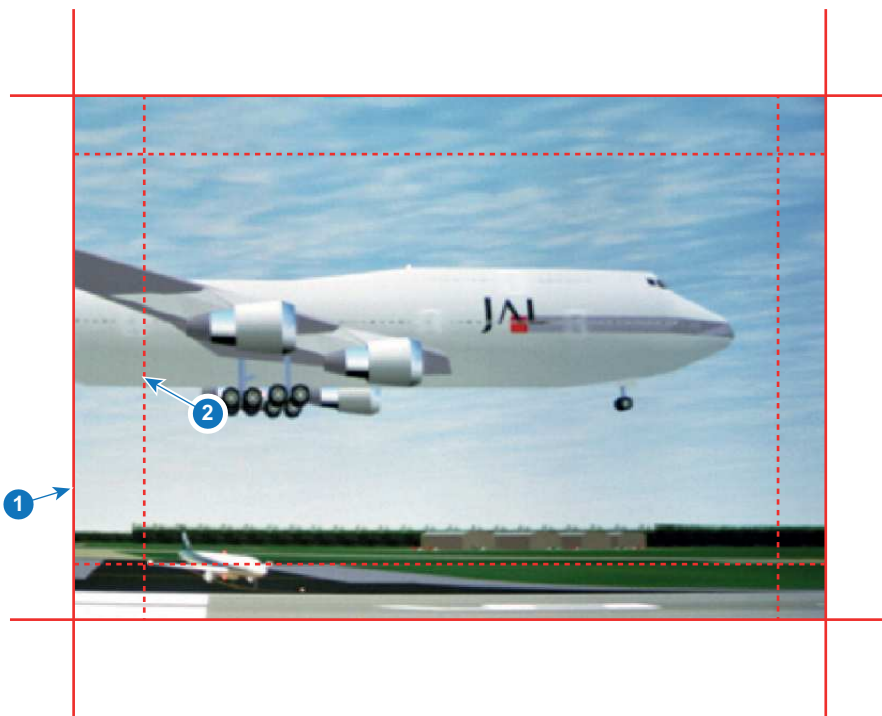

Image 8–53

- 1 Start position (mask)
- 2 Blending width

5. Select one of the four starting positions values with the arrow keys and confirm.
6. Use the arrow keys or remote digits to change the value of the blend zone and confirm.
7. Repeat this process for all other desired sides.
8. Continue by creating the blend mask. For more info, see [“Blend & Blend mask”, page 93](#).



Do not forget to disable the **Show lines** button after you achieved the desired blend zone.

## 8.10.2 Blend & Blend mask

### About masking and blending width or height

Offset is used to clip the image on one or multiple sides (masking). This is used to hide parts of the picture that should not be shown on the screen. For example: if the source is a Windows PC, you can hide the menu bar using this method.

The larger the Mask value, the more the image is masked (by black bar) at the corresponding side. E.g. Top mask of 100 will blank the top 100 lines.

Height or width is used to create a blending zone with a smooth brightness drop off. This is used to compensate for the double brightness in overlap areas. The value is the size of the blended area in pixels.

### How to set up basic blend zones?

1. In the main menu, select *Installation* → *Blend and Mask* → *Blend mask*.

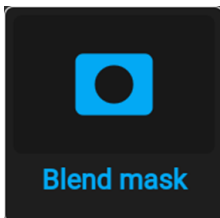

Image 8–54 Blend menu, Blend mask

The Blend mask menu is displayed.

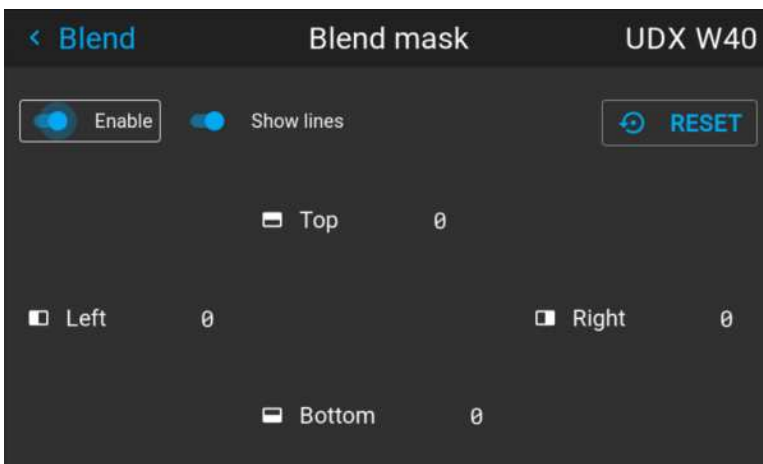

Image 8–55 Example of the blend mask menu

2. To enable the blend mask, put the **Enable** slider to the right. The color of the slider becomes blue when enabled.
3. To project masking lines on the screen, put the **Show lines** slider to the right. The color of the slider becomes blue when enabled.
4. Determine the start position of the mask (1) for the masking height and width, together with the desired size of the mask (2) to determine the width of the masked area.

When the helping lines are activated, you will get a visual indication of the screen of the installed blending area.

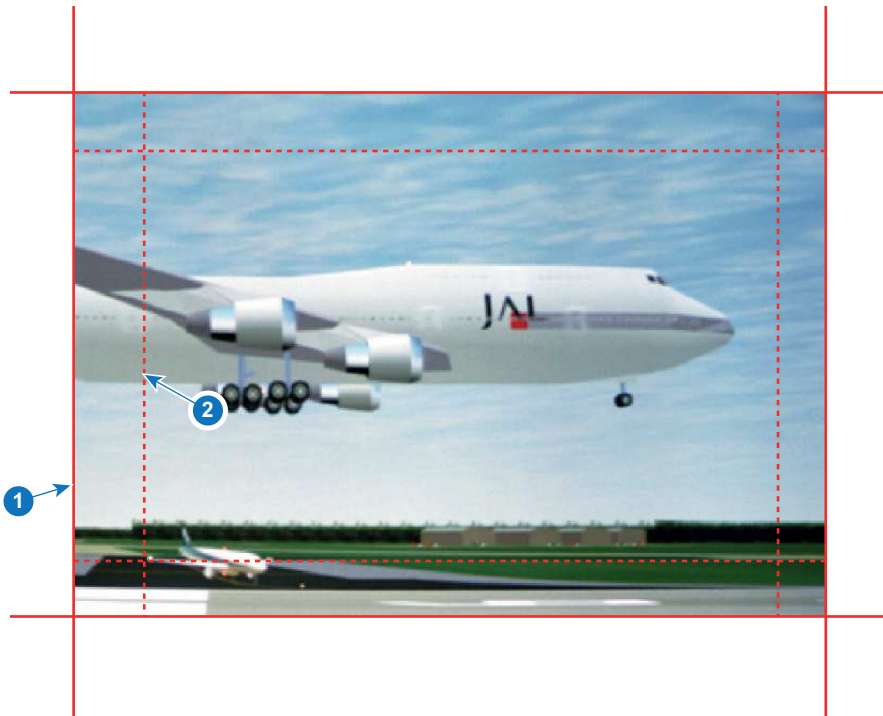

Image 8-56

- 1 Start position (mask)
- 2 Blending width

5. Select one of the four starting positions values with the arrow keys and confirm.
6. Use the arrow keys or remote digits to change the value of the mask and confirm.
7. Repeat this process for all other desired sides.



Do not forget to disable the **Show lines** button after you achieved the desired blend zone.

### Example of the use of blending

When projecting an image with 2 or more projectors, there is always an small overlap that should be corrected by using the blending function.



In order to obtain a satisfying result for the Blend function, the overlap / mask zone are recommended to be at least 10% of the picture width.

The basic principle is that the overlap setup in the source shall correspond with the mask width setup for the projector. That means that if the overlap zone for the source is set to 500 pixels, the width of the mask zone for the projector also must be set to 500 pixels.

First step is to align the image from the projectors as accurate as possible in a mechanical way, meaning without any optical corrections. At the same time, establish an overlap in the pictures between the two screens.

Then adjust the remaining irregularities by using the shift and warp features in the projectors to obtain the last fine tuning of the alignment.

Enable blending and activate Show lines.

First set the mask width for the right edge of the first projector. Enter a width value equal to the overlap area (width1).

Repeat for the left edge of the second projector.

Adjust the offset to cut the image on each side (masking).

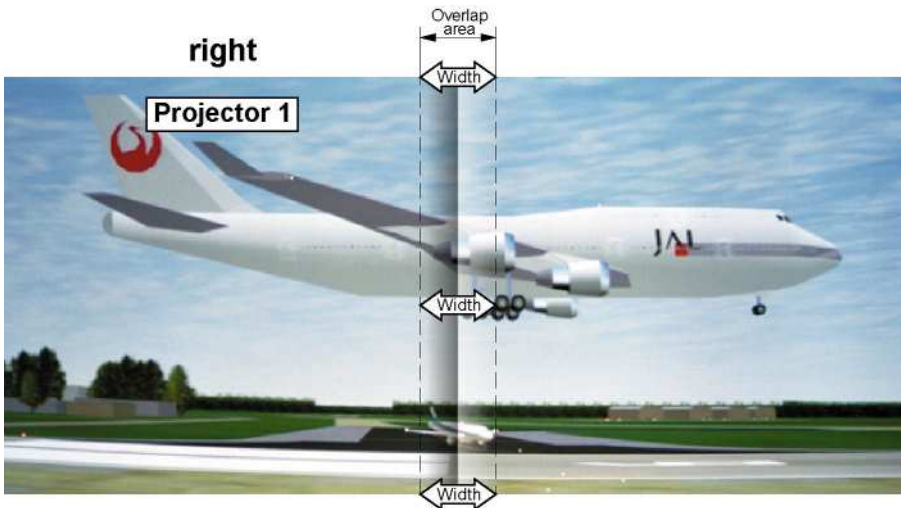

Image 8-57 Set up for projector 1

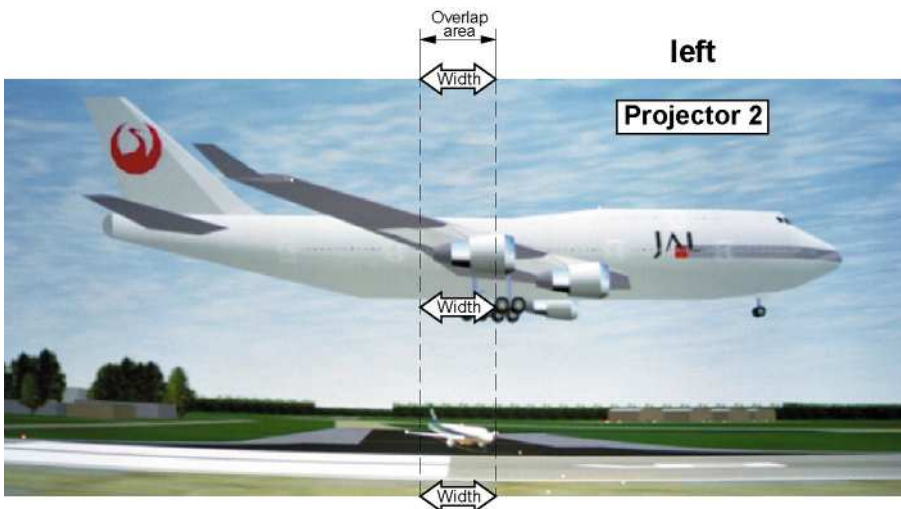

Image 8-58 Set up for projector 2

### 8.10.3 Blend Files

#### About custom Blend Files

Next to setting your specific Blending configuration in the GUI, you can also upload or download a custom Blend configuration file in png, jpg or tiff format to/from the projector. This is a timesaving option when multiple projectors need an identical blending configuration.

To upload or download Blend configuration files you can use Projector Toolset or upload/download the Blend configuration file in the format of an xml file. Alternatively, you can contact the “file endpoint” directly via the curl program or some other tool that supports http upload.

For more information on uploading/downloading Blend files using the Projector Toolset, refer to the Projector Toolset user manual.

For more information on uploading/downloading Blend files using curl or other tools that supports HTTP upload, refer to the Pulse API Reference Guide.

#### How to activate an uploaded Blend configuration file?

1. In the main menu, select *Installation* → *Blend and Mask* → *Blend Files*.

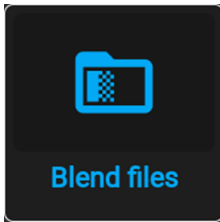

Image 8–59 Blend and mask menu, Blend files

The Blend Files menu is displayed.

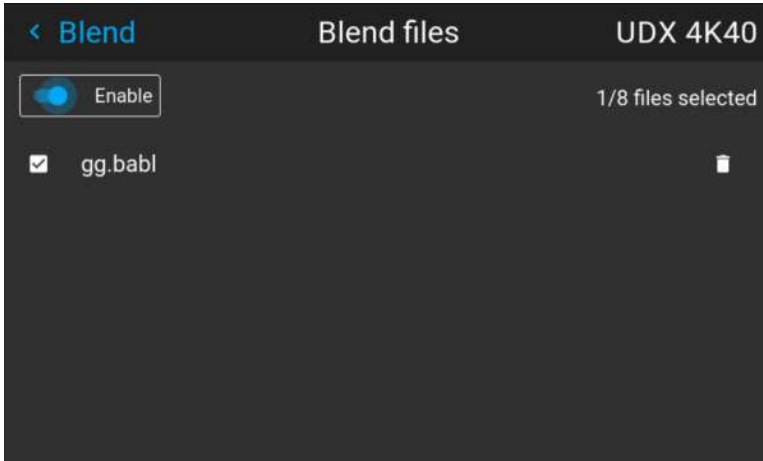

Image 8–60 Example of the blend files menu

2. If any custom Blend files are available, select the desired file.

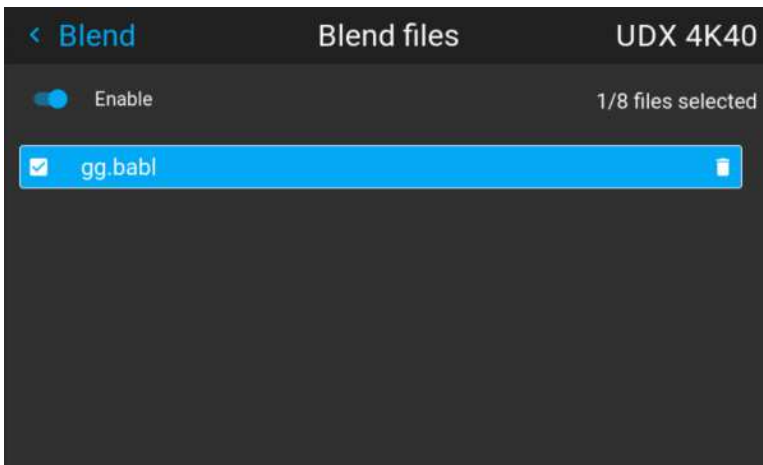

Image 8–61

3. To enable the selected blend file, make sure the **Enable** slider is set to the right. The color of the slider becomes blue when enabled.

## 8.10.4 Basic black level adjustment

### About adjusting the black level

The purpose of the black level adjustment is to align the black levels in the overlapped regions with the black levels in the other regions.

This is needed because the black levels will be brighter in the blend zones, since multiple projectors will project on the same screen area.

The size of the black level area is calculated automatically from the blend zones. This is done by using the start position and size of each edge of the blend and adding an additional size of 8 pixels to reduce the effect known as "sea of mirrors".



You can also specify the offsets manually by turning off the automatic calculation. The black level value is adjusted in a 16-bit resolution from 0 to 65535.

The following figure shows how this occurs in a side by side configuration without any correction of the black level.

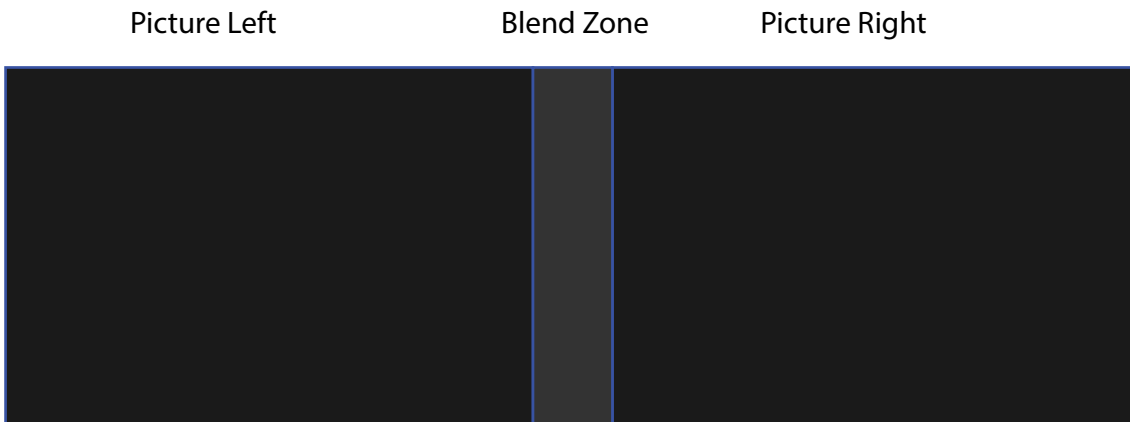

Image 8-62

## How to adjust the black level manually

1. In the main menu, select *Installation* → *Blend and Mask* → *Black Level*.

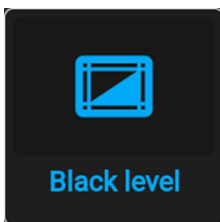

Image 8-63 Blend and Mask menu, Black level

The Basic black level menu is displayed.

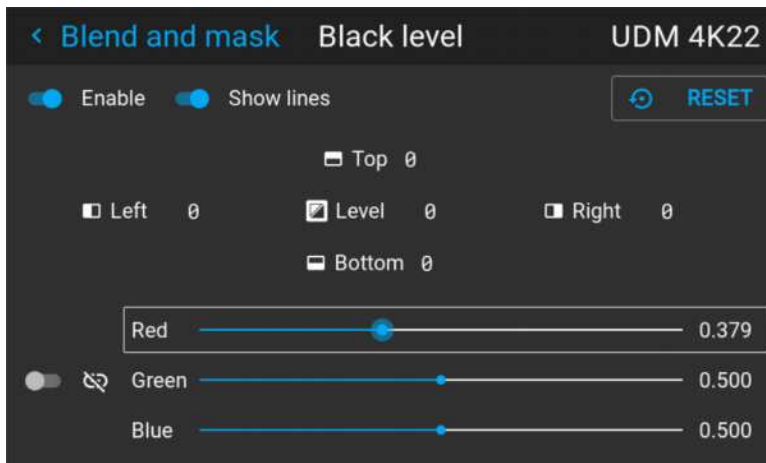

Image 8-64 Example of the default black level menu

2. Enable the **Black level** slider. If you want a visual aid, enable the **Show lines** slider as well.
3. Move the cursor to the side where the overlapped area occurs (*Top*, *Left*, *Right* or *Bottom*) and press enter.
4. Adjust the level with the arrow keys and press enter when the desired black level zone is reached.

or

enter the black level value with the numeric keys in the remote control.

5. Move the cursor to *Level*, press enter and adjust this level until the black level equals the level in the blend zone.

This value can also be entered by the numeric keys on the remote control.

6. Repeat the same procedure for any other projector connected to this projector, but on the opposite side.

 **Note:** Do not forget to disable the **Show lines** button after you achieved the desired blend zone.

## 8.10.5 RGB gain adjustment

### About RGB gain adjustment

The purpose of black level correction is to ensure a uniform black level in multi projector setups. Even when two projectors are of the same type, different projectors will output slightly different colors for black due to minor variations in their optical components. So if the projected image of the projectors overlap, there will be 3 different black levels: one for the zone where only the picture of the left projector (zone 1), one for the Blend zone (zone 2), and one for the zone where there is only the picture of the right projector (zone 3).



Image 8–65

The black levels for zone 1 and zone 3 are typically corrected by defining a black level mask, which is applied to the image of each projector. This system is already in place but the applied mask is monochrome.

Using the Basic Black Level menu, you can already specify the area of the mask and its contents. But by using the RGB Adjustment page, you can specify the multiplication factors (gains) for the Red, Green and Blue colors separately.

### How to perform an RGB adjustment

1. In the main menu, select *Installation* → *Blend and Mask* → *Black Level*.

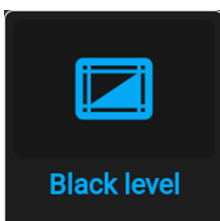

Image 8–66 Blend and Mask menu, Black level

The Basic black level menu is displayed.

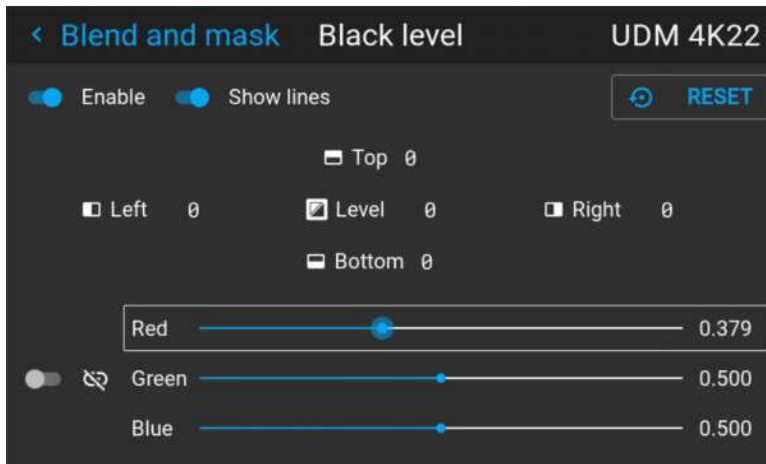

Image 8–67 Example of the default black level menu

2. Select one of the three sliders on the bottom of the menu (Red, Green or Blue).
3. Use the left and right arrow keys to modify the gain of the chosen color.
4. Repeat for every slider until the desired result is achieved on screen.

## 8.10.6 Black Level Files

### About custom Black Level Files

Next to setting your specific Black Level Adjustment in the GUI, you can also upload or download a custom Black Level adjustment file in png, jpeg or tiff format to/from the projector.

To upload or download Black Level adjustment files you can use Projector Toolset or upload/download the Black Level adjustment file in the format of an XML file. Alternatively, you can contact the “file endpoint” directly via the curl program or some other tool that supports http upload.

For more information on uploading/downloading Black Level files using the Projector Toolset, refer to the Projector Toolset user manual.

For more information on uploading/downloading Black Level files using curl or other tools that supports HTTP upload, refer to the Pulse API Reference Guide.

### How to activate an uploaded Black Level adjustment file?

1. In the main menu, select *Installation* → *Blend and Mask* → *Black Level* → *Black Level Files*.

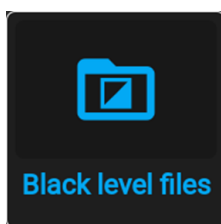

Image 8–68 Blend and mask menu, Black level files

The Black Level Files menu is displayed.

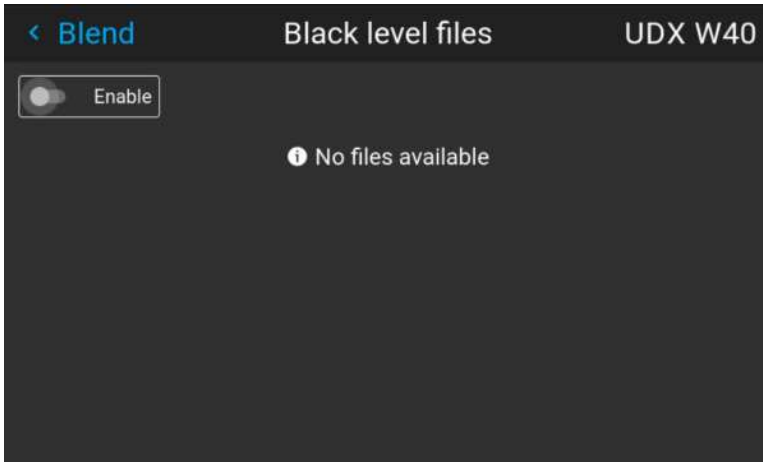

Image 8–69 Example of the black level files menu

2. If any custom Black Level adjustment files are available, select the desired file.

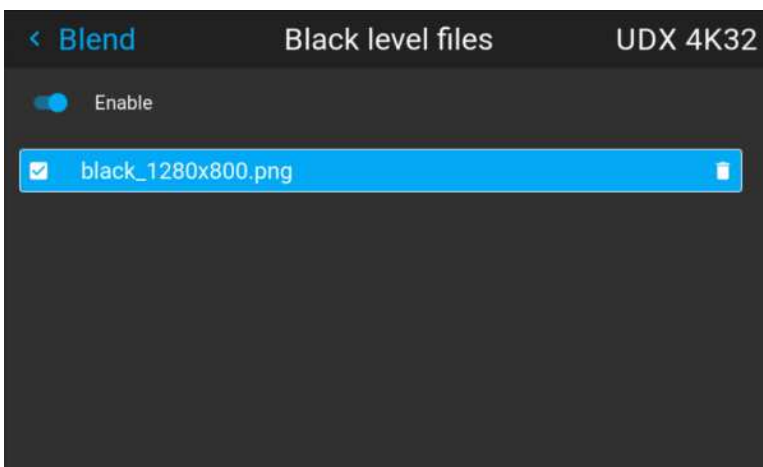

Image 8–70 Example of custom black level files selected

3. Make sure the Enable slider is set to the right to activate the selected black level file

## 8.11 Illumination

### What can be done?

Within a certain percentage, the light output of the light source can be reduced by reducing the power slider.

Alternatively, you can enable CLO mode (Constant light output) for a constant light output over a longer period of time.



You can only change the power output when the shutter is opened.

### About CLO mode

All light sources naturally decrease their intensity over time. In order to prevent a decreasing output in a multi-projector setup, you can activate CLO mode to make sure that the light output remains constant.

CLO mode will ensure that the projector regulates its illumination power to maintain the same level of output light during the lifetime of the light source. This requires that the light source power is not set to 100% from the start, but to a lower value. The lower this value is set, the longer the projector will be able to maintain the output level.

## How to reduce the power

1. In the main menu, select *Installation* → *Illumination*.

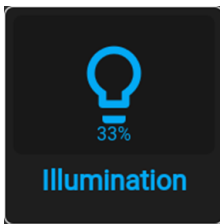

Image 8–71 Installation menu, illumination

The Illumination menu is displayed.

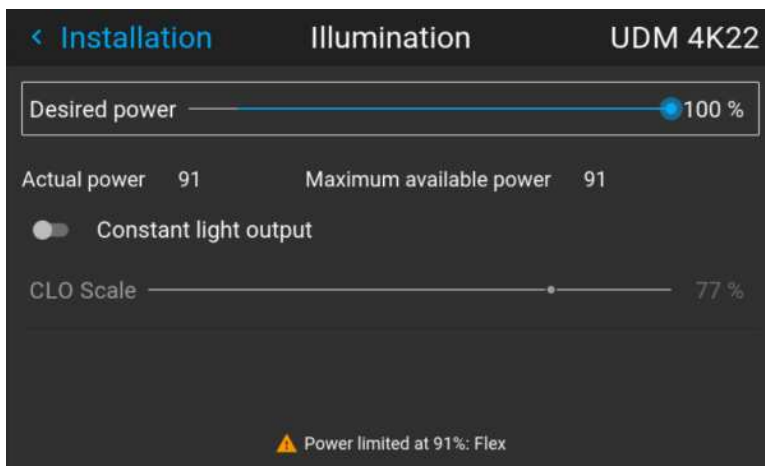

Image 8–72 Example of the Illumination menu

2. Use the Slider to change the power value.
3. Enable the *Constant light output* slider if you want to enable CLO mode.
4. If CLO mode is active, you can use the CLO Scale slider to scale the light output.

## 8.12 3D projection

### 3D setup

The projector is capable of displaying 3D images and movies in active stereoscopic 3D.

Setup of a 3D installation requires an advanced understanding of 3D systems, both for the projector as well as for the system the signal source originates from. In a 3D setup it is crucial that the projected images are perfectly synchronized through the whole signal path, from the signal source to the picture viewed through the 3D goggles.

Regarding setting up the proper signal source, please refer to the user manual or online help for that graphic card. For example: when using NVIDIA Quadro cards, use the NVIDIA Control Panel to manage your 3D settings.

### 8.12.1 Active Stereo & Passive Stereo

#### What is Passive Stereo?

Passive Stereoscopic 3D (also known as “Passive Stereo”) is the standard method of creating the illusion of depth in an image, by means of stereopsis for binocular vision.

To present stereoscopic pictures, two images are projected superimposed onto the same screen through polarizing filters or presented on a display with polarized filters. For Digital Cinema, a silver screen is used so that polarization is preserved. On most passive displays every other row of pixels are polarized for one eye or the other. This method is also known as interlacing.

The viewer wears glasses which contain a pair of opposite polarizing filters. As each filter only passes light which is similarly polarized and blocks the opposite polarized light, each eye only sees one of the images, and the effect is achieved.

### What is Active Stereo?

Field sequential 3D (also known as active 3D or “Active Stereo”) is a technique of displaying stereoscopic 3D images. It works by only presenting the image intended for the left eye while blocking the right eye's view, then presenting the right-eye image while blocking the left eye, and repeating this so rapidly that the interruptions do not interfere with the perceived fusion of the two images into a single 3D image.

This system setup uses liquid crystal shutter glasses (also known as active shutter glasses). Each eye's glass contains a liquid crystal layer which has the property of becoming opaque when voltage is applied, being otherwise transparent. The glasses are controlled by a timing signal that allows the glasses to alternately block one eye, and then the other, in synchronization with the refresh rate of the screen. The timing synchronization to the video equipment may be achieved via a wired signal or via wireless communication, this by using either an infrared or radio frequency (e.g. Bluetooth, DLP link) transmitter.

### Projection method used

This projector can only show active 3D images, used in combination with a 3D emitter and active shutter glasses. While it is allowed to connect passive stereo source signals, the image processing of the projector will convert those signals to an active 3D compatible image.

The options on the projector software allow you to fine-tune the 3D settings accordingly to the specifications of the 3D emitter.



If a 3D emitter is used that radiates IR beams, the IR beams may interfere with the IR communication between projector and the RCU. If such interference occurs, connect the RCU to the projector using the remote cable. It is also advised to turn the IR receivers on the projector off to avoid the 3D emitter interference. To turn off the IR receivers, see [“Remote control, on/off button”](#), page 23.

## 8.12.2 Setup process 3D projection

### How to setup 3D projection?

1. Connect the proper source cables to the projector. For more info, see [“Connection possibilities”](#), page 102.
2. Set up and connect your 3D emitter to the projector. For more info, refer to the user manual of your 3D emitter.
3. Power on the projector completely.
4. Select the correct stitched source Input in the Source menu. See section dedicated to the *Displaying Multiple sources* in the *GUI-Source* chapter.
5. Depending on the chosen 3D emitter and chosen source, correct the 3D setup. For more info, see [“3D Setup”](#), page 103.

### 8.12.3 Connection possibilities



At this moment, the only inputs supporting 3D on the projector input board are the DisplayPort inputs and DVI inputs. More inputs may support 3D in a future release.

### Connecting with the projector connection panel

You can use one of the following methods.

Source	Layout mode	Video Timing / cable	Fixed configuration?	Color depth
Active Stereo (sequential L/R)	Standard layout (1x1 layout)	2560 x 1600 @120 Hz		30 bpp
Passive Stereo (separate L/R)	Standard layout (1x1 layout)	3840 x 2160 @60 Hz	<ul style="list-style-type: none"> <li>• Cable 1: left eye</li> <li>• Cable 2: right eye</li> </ul>	30 bpp
Passive Stereo (dual pipe L/R)	2 Column mode (2x1 layout)	1920 x 2160 @60 Hz	<ul style="list-style-type: none"> <li>• Cable 1: left eye</li> <li>• Cable 2: right eye</li> </ul>	30 bpp

## 8.12.4 3D Setup

### Why change the 3D setup?

While Barco can provide a 3D emitter and active shutter glasses as options to this projector, you are also free to use a 3D emitter and active shutter glasses of your own choice. Since glasses and emitter can have various specifications compared to the ones Barco can provide, the 3D setup menu allows you to configure the output image to the specifications of your glasses and emitter. The following can be configured:

- **Swap Eyes:** You can choose to invert the stereo Sync output signal ( depending on the chosen 3D emitter and glasses).
- **Swap frame pair:** This setting allows you to correct the frame doubling sequence. If the frame rate of the projected moving 3D content doesn't look smooth, this option may help improve this.
- **Dark time:** You can select how much dark time the projected image will have between frames. You can choose one of the options between 1000 µs and 2500 µs.
- **Output mode:** Choose the desired output mode. For more details, see further.
- **Sync Delay:** You can increase or decrease the sync delay. The scale goes from -10 000 µs to +10 000 µs with a step of 100 µs.

### Choosing the desired output mode

The following output modes are available:

- **AutoStereo:** Automatic mode (2D input = 2D output, 3D input = Active Stereo output).
- **Mono:** Forces all source signals to 2D output.
- **ActiveStereo:** Forces all source signals to Active Stereoscopic 3D.

Use the following table as an indicator of what display mode you require.

Source signal	AutoStereo	Mono	ActiveStereo
2D Source	Output is a 2D image	Output is a 2D image	Output is in Active Stereo
Active Stereo source	Output is in Active Stereo	Output is a 2D image	Output is in Active Stereo
Passive Stereo source	Output is in Active Stereo	Output is a 2D image	Output is in Active Stereo



When a different Display Mode is chosen compared to the source signal (e.g. Active Stereo source with Mono output), advanced image processing will make sure you a desirable image will be displayed.



If a 3D emitter is used that radiates infrared beams (IR beams), the IR beams may interfere with the IR communication between projector and the RCU. If such interference occurs, connect the RCU to the projector using the remote cable. It is also advised to turn the IR receivers on the projector off to avoid the 3D emitter interference. To turn off the IR receivers, see [“Remote control, on/off button”](#), page 23.

### How to adjust the projector to the 3D emitter?

1. In the main menu, select *Installation* → *3D Setup*.



Image 8–73 Installation menu, 3D setup

The 3D setup menu is displayed.

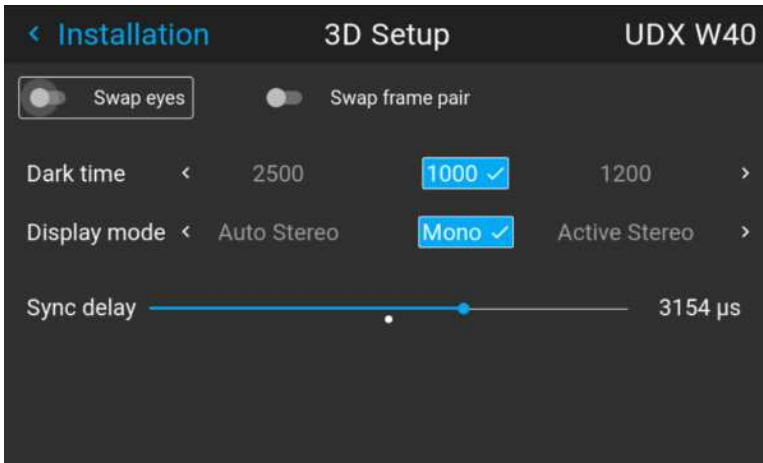

Image 8–74 Example of the 3D setup menu on a UDX

2. If it is necessary to invert the stereo sync output, enable the *Swap eyes* option.
3. If the projected moving 3D content doesn't look smooth enough, enable the *Swap frame pair* option to help improve this.
4. Select the desired the stereo *Dark Time*.
5. Select the desired *Display mode*.
6. Use the slider to set the desired stereo *Sync delay*.



# GUI – Macro's and projector profiles

# 9

9.1	Saving the current projector settings in a profile .....	106
9.2	Assigning a created projector profile to a preset .....	108
9.3	Deleting a projector profile.....	109

## About macro's and projector profiles

Projectors can have different settings, depending on different environments (e.g. playing video games in a bright environment or playing a movie in a dark environment), or using different mediums (e.g. content from an old DVD versus an HDR-coded blu-ray). Using profiles you can now save the projector settings for each situation, making it easier to load these settings back up when entering a frequently recurring setup.

## 9.1 Saving the current projector settings in a profile

### Which settings can be saved to a profile?

Profile setting name	Settings saved
Source	Active source selection & EDID
Image	<ul style="list-style-type: none"> <li>• All basic image settings: contrast, brightness, saturations, sharpness &amp; gamma</li> <li>• Used gamma type</li> <li>• Digital zoom (width / height / factor + enabled/disabled)</li> <li>• Digital shift (x / y + enabled / disabled)</li> <li>• Output resolution</li> </ul>
PQ (HDR)	Screen luminance & HDR boost value
Realcolor P7	Color mode & P7 coordinates
Installation	<ul style="list-style-type: none"> <li>• Lens parameters (lens zoom, focus &amp; shift)</li> <li>• Orientation (mounting &amp; projection)</li> <li>• Scaling mode</li> <li>• Position of motorized frame (if used).</li> <li>• Shutter status (open or closed).</li> </ul>
Warp	<ul style="list-style-type: none"> <li>• Warp status enabled / disabled</li> <li>• Screen size</li> <li>• Warp file selected (if available)</li> <li>• Transport delay</li> </ul> <p><b>Note:</b> Bow and 4 corners warp cannot be saved.</p>
Blend	<ul style="list-style-type: none"> <li>• Blend mask enabled / disabled</li> <li>• All Masks (top / bottom / left / right) and heights (top / bottom / left / right)</li> <li>• Blend files enabled / disabled (if available)</li> <li>• Blend file selected (if available)</li> </ul>
Black level	<ul style="list-style-type: none"> <li>• Black level file enabled / disabled</li> <li>• Black Level file selected (if available)</li> <li>• Basic black level enabled / disabled</li> <li>• Black level settings (top / bottom / left / right)</li> <li>• RGB gain values (Red, Green and Blue values)</li> </ul>
Illumination	<ul style="list-style-type: none"> <li>• Power setting</li> <li>• CLO enabled / disabled</li> <li>• CLO set point</li> </ul>
Display (3D settings)	<ul style="list-style-type: none"> <li>• Display mode used</li> <li>• Swap eyes on / off</li> <li>• Swap frame pair on / off</li> <li>• Dark time and sync delay values</li> </ul>
Cooling <sup>2</sup>	Selected Cooling mode

### How to save the current projector settings?

1. In the main menu, select *Profiles* → *Edit*.

2. Only if external cooler is installed

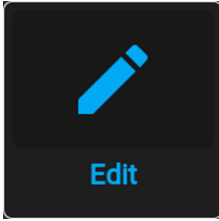

Image 9-1 Profiles menu, edit

The Profile edit menu is displayed.

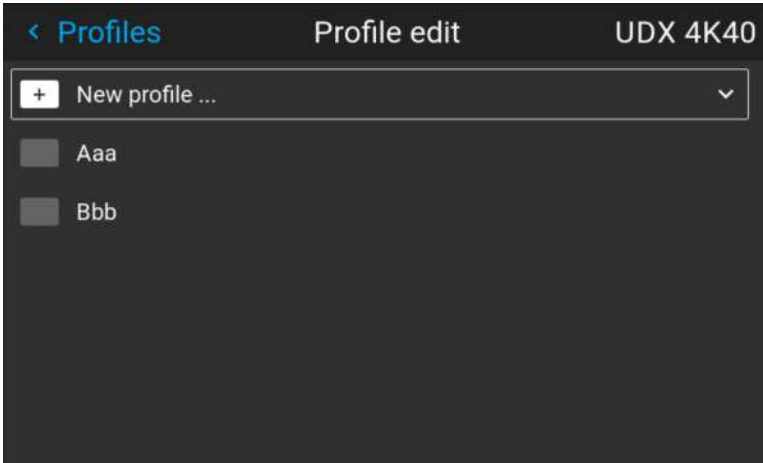

Image 9-2 Profile edit menu

2. Use the arrow keys to select *New Profile...* and confirm.  
The New Profile pane is expanded and fully displayed.

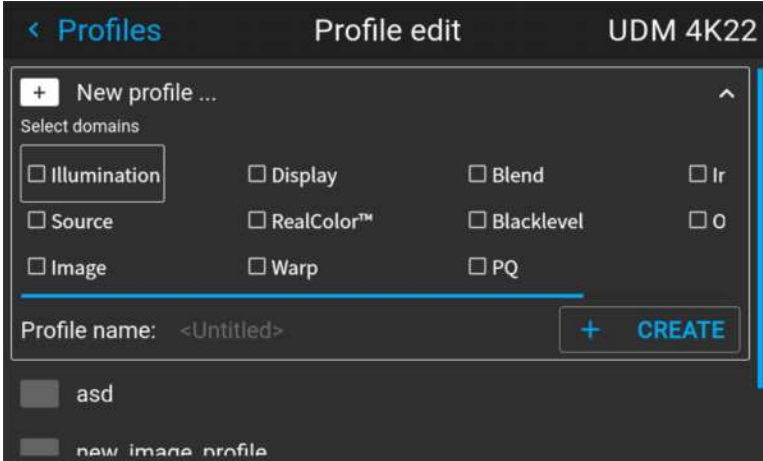

Image 9-3 Example of the new profile pane

3. Use the arrow keys and the okay key to select any of the settings you wish to save in this macro.
4. Select the field next to *Profile Name* and confirm with the Okay key to display a keyboard.
5. Use the keyboard to enter a valid macro name. Confirm with the enter key once completed.
6. Select *CREATE* and confirm to save the current profile settings.

## 9.2 Assigning a created projector profile to a preset



This procedure assumes you have created at least one projector profile. For more info on saving projector settings to a profile, see [“Saving the current projector settings in a profile”, page 106.](#)

### How to assign a projector profile to a preset

1. In the main menu, select *Profiles* → *Edit*.

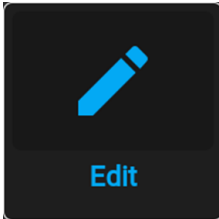

Image 9–4 Profiles menu, edit

The edit menu is displayed.

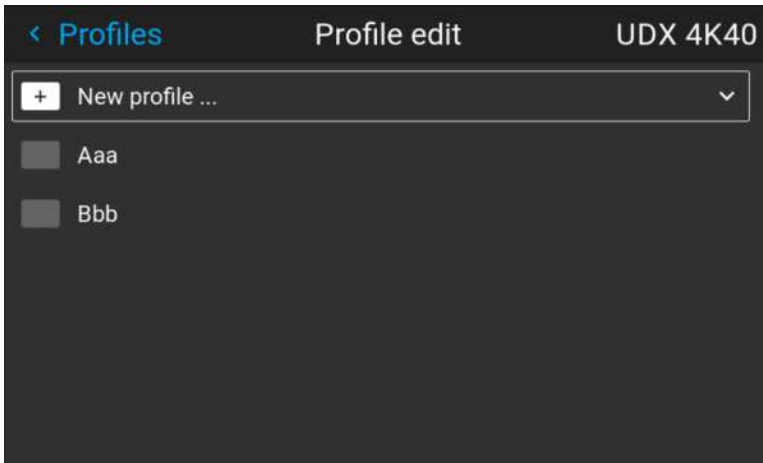

Image 9–5 Profile edit menu

2. Select the desired projector profile from the list and confirm.

The profile pane will expand.

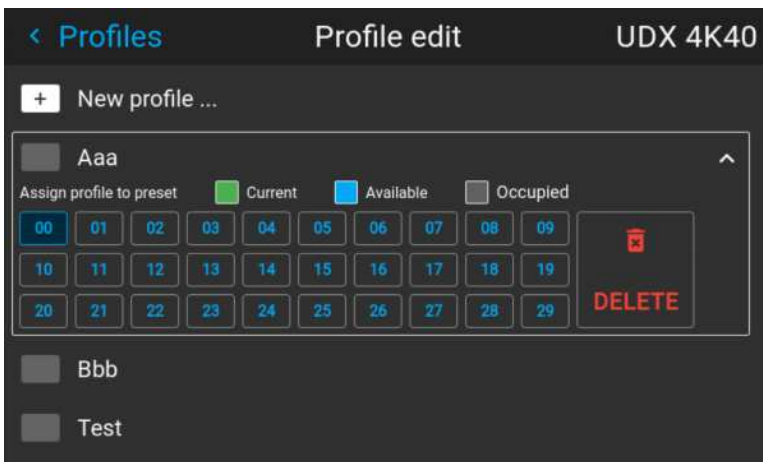

Image 9–6 Example of a projector profile with available preset slots

3. Use the arrow keys to select a preset slot and confirm with the okay key.

The preset slot is now shown next to the profile name.



Image 9-7 Example of projector profiles allocated to preset slots (here slot 00 and 04)

## 9.3 Deleting a projector profile

### How to delete a profile

1. In the main menu, select *Profiles* → *Edit*.

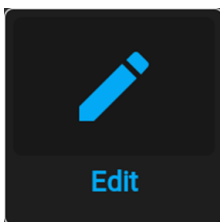

Image 9-8 Profiles menu, edit

The edit menu is displayed.

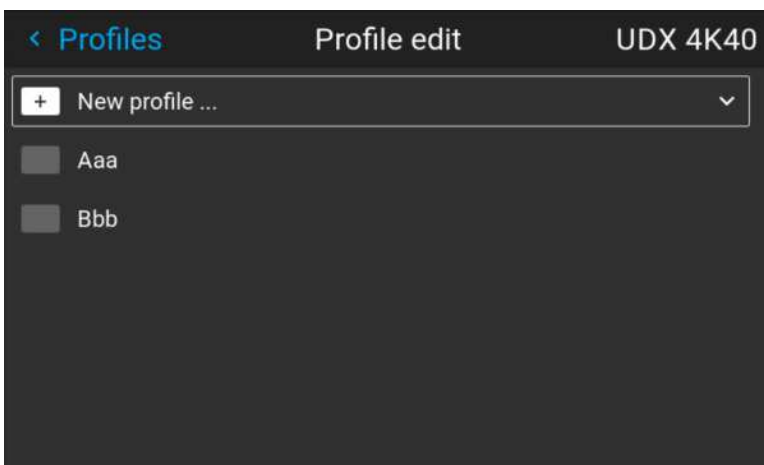

Image 9-9 Profile edit menu

2. Select the undesired projector profile and confirm to expand it.

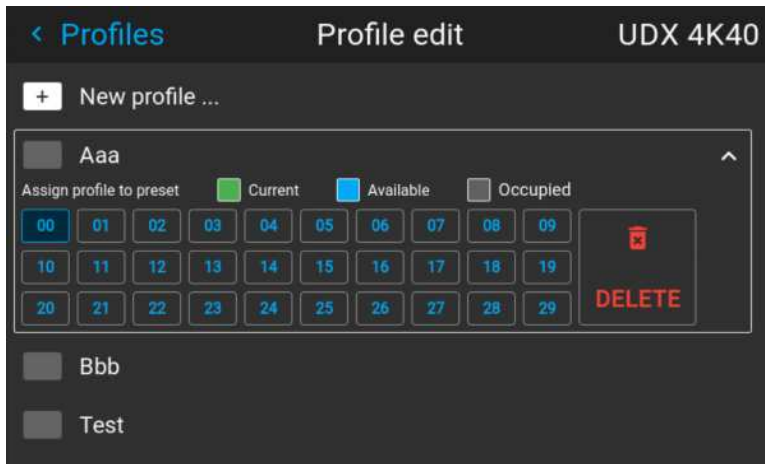

Image 9–10 Example of a projector profile with available preset slots

3. Use the arrow keys to select *Delete* and confirm. confirm the delete action.

# GUI – System Settings

# 10

10.1	Communication .....	112
10.2	IR control .....	114
10.3	Setting a custom projector name.....	117
10.4	DMX .....	118
10.5	Changing the User Interface language .....	119
10.6	Themes .....	120
10.7	Setting the measurement system.....	120
10.8	ECO mode.....	121
10.9	Power settings.....	121
10.10	Lens features .....	122
10.11	Controlling the backlight of the LCD Display.....	123
10.12	Factory reset.....	124
10.13	Lens Calibration .....	126
10.14	Operational mode.....	128
10.15	Advanced Settings.....	129

## 10.1 Communication

### About a network connection

Network connection is required to communicate with the projector via LAN or Internet. The setup could be done manually (set address, subnet mask and default gateway according to network specification), or automatically assign (DHCP).

#### 10.1.1 Introduction to a Network connection

##### DHCP



Dynamic host configuration protocol. DHCP is a communications protocol that lets network administrators manage centrally and automate the assignment of IP addresses in an organization's network. Using the Internet Protocol, each machine that can connect to the Internet needs a unique IP address. When an organization sets up its computer users with a connection to the Internet, an IP address must be assigned to each machine. Without DHCP, the IP address must be entered manually at each computer and, if computers move to another location in another part of the network, a new IP address must be entered. DHCP lets a network administrator supervise and distribute IP addresses from a central point and automatically sends a new IP address when a computer is plugged into a different place in the network.



##### IP

Internet Protocol. The network layer of TCP/IP. Required for communication with the internet.



##### Subnet mask

A number that is used to identify a subnetwork so that IP addresses can be shared on a local area network.



##### Default Gateway

A router that serves as an entry point into and exit point out of a network. For example, a local network (LAN) may need a gateway to connect it to a wide area network (WAN) or to the Internet.



##### MAC address

Media Access Control address. Unique hardware number, used in combination with the IP-address to connect to the network (LAN or WAN).

### What should be set up for an Ethernet address?

Two ways can be used to assign an address:

- use the *Automatic* setting so that an automatic address will be assigned.
- Assign manually an IP address, Net-mask (subnet-mask), (default) gateway address.
  - Set the IP-Address field to the desired value. This must NOT be 0.0.0.0 for static IP-Address assignment. The IP address identifies a projector's location on the network in the same way a street address identifies a house on a city block. Just as a street address must identify a unique residence, an IP address must be globally unique and have a uniform format.
  - Set the Subnet-Mask as appropriate for the local subnet.
  - Set the Default-Gateway to the IP-Address of the local router (MUST be on the local subnet!) on the same network as this projector that is used to forward traffic to destinations beyond the local network. This must not be 0.0.0.0. If there is no router on the projector's local subnet then just set this field to any IP-Address on the subnet.

#### 10.1.2 Wired IP address set up

##### How to automatically set up the IP address

1. In the main menu, select *Settings* → *Communication* → *LAN*.



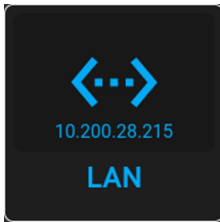

Image 10-1 Communication menu, LAN

The LAN menu is displayed.

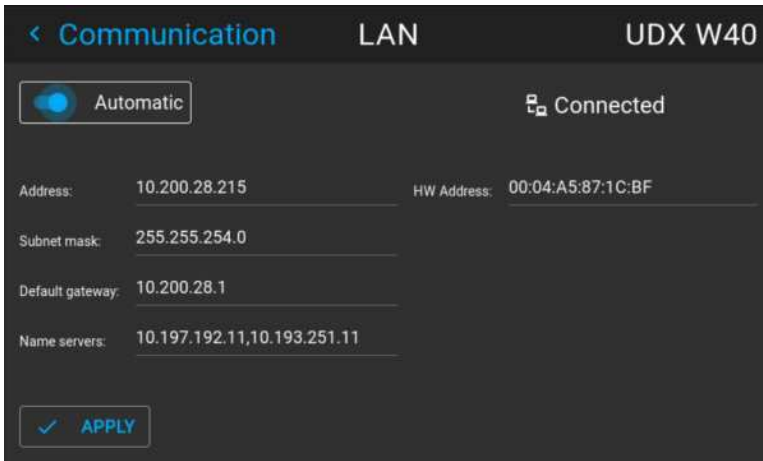

Image 10-2 Example of the LAN menu

2. To enable Automatic, make sure the Automatic slider is set to the right. The color of the slider will be blue. An IP address will be automatically assigned if it can make a connection to the network.. When connected, it is indicated with the connection symbol and the indication *Connected*.
3. Select **APPLY** and confirm.

### How to manually set up the IP address

1. In the main menu, select *Settings* → *Communication* → *LAN*.

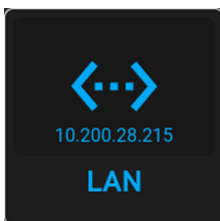

Image 10-3 Communication menu, LAN

The LAN menu is displayed

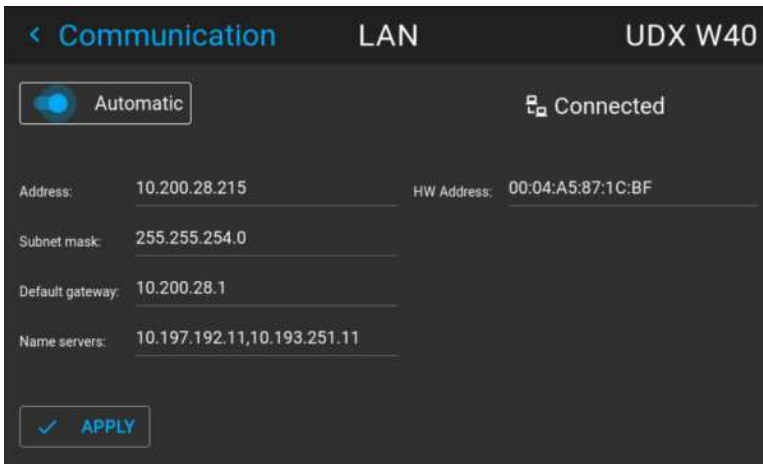

Image 10-4 Example of the LAN menu

2. Disable the Automatic slider. The slider becomes gray.
3. Use the arrow keys to select *Address* and press **OK** button to activate the input box.

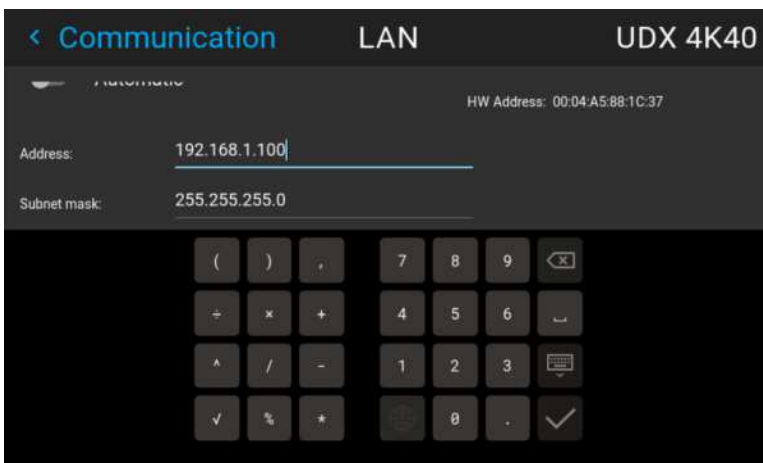



Image 10-5 Example of entering the IP address

4. Use the arrow keys and enter key to enter in the IP address.
  -  *Note:* Digits can be entered with the digit keys on the remote control or the local keypad. When a digit is entered in that way, the next character will be selected automatically.
5. Once filled in, select the ✓ symbol and confirm.
6. Repeat steps 4 and 5 for the Subnet mask and Default Gateway.
7. Select **APPLY** and click **OK** to confirm all changes.

When the connection is established, it is indicated with the connection symbol and the indication *Connected*.

## 10.2 IR control

### 10.2.1 Broadcast address

#### About broadcast address

Broadcast address is a common address that can be set on the projector. That can be “0” or “1”. The default broadcast address is '0'.

Any command coming from an RCU programmed with that common address will be executed.

## How to the broadcast address

1. In the main menu, select *Settings* → *Communication* → *IR Control*.



Image 10-6 Communication menu, IR control

The IR control menu is displayed.

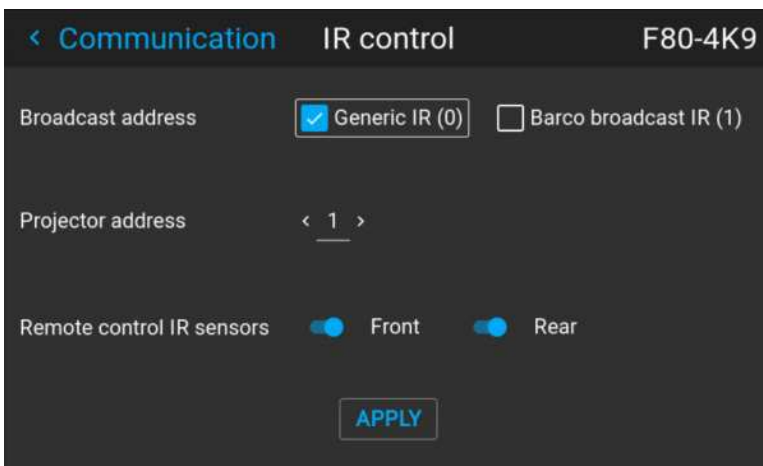

Image 10-7 Example of the IR control menu

2. To change the broadcast address select the radio button of your choice.

The following choices are possible:

- Generic IR (address 0)
- Barco broadcast IR (address 1)

3. Select **APPLY** and click **OK** to apply the changes.

## 10.2.2 Projector address

### About individual projector address

As more than one projector can be installed in a room, each projector should be separately addressable with an RCU or with a computer using serial communication. Therefore each projector has its own address. The factory default individual projector address is '0'.

When the address is set, the projector can be controlled with the RCU. Only addresses between 0 and 31 are supported for the RCU.

Next to an individual projector address, each projector has also a broadcast address for group control.

### How to change

1. In the main menu, select *Settings* → *Communication* → *IR Control*.

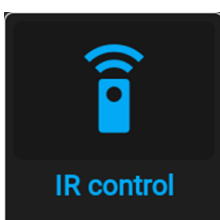

Image 10-8 Communication menu, IR control

The IR control menu is displayed.

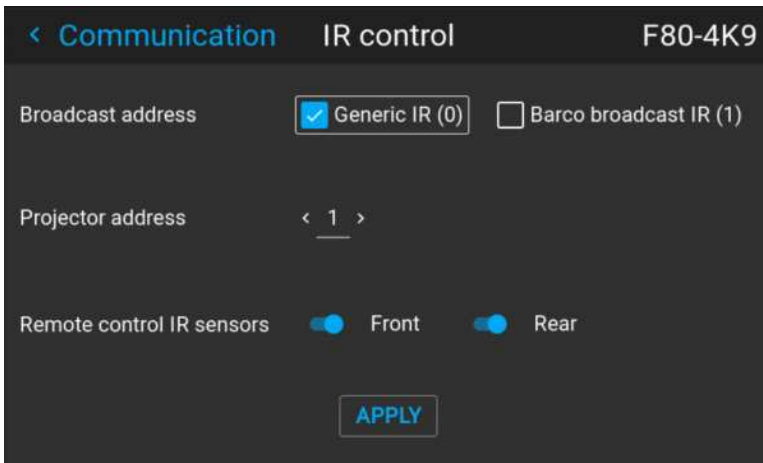

Image 10-9 Example of the IR control menu

2. Select the current projector address and enter a new address.
3. Select **APPLY** and click **OK** to apply the changes.

From now on the projector will only listen to this new address and to its broadcast address.

### 10.2.3 IR sensors

#### What can be done?

Each IR sensor can be individually disabled or enabled.

When all sensors are turned off, the projector will no longer respond to signals from the remote control. To re-enable the sensors, use the menu keypad on the projector.

#### How to disable

1. In the main menu, select *Settings* → *Communication* → *IR Control*.

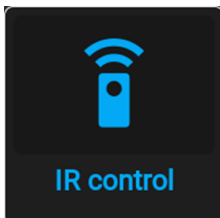

Image 10-10 Communication menu, IR control

The IR control menu is displayed.

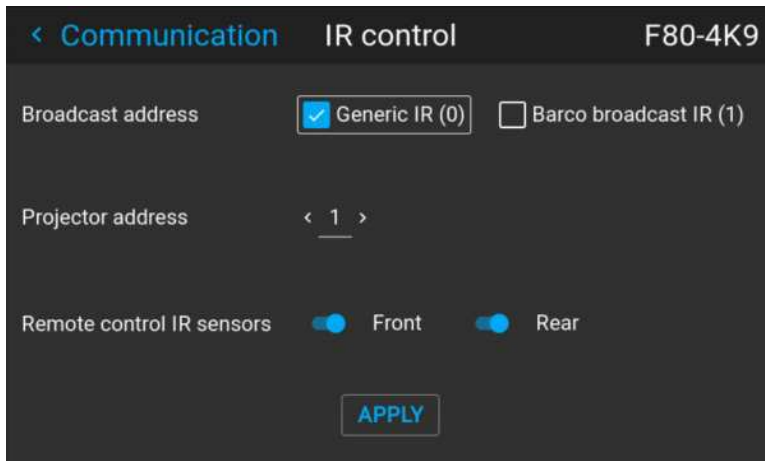

Image 10–11 Example of the IR control menu

2. To disable an IR sensor, select the slider and drag to the left.  
A blue slider means an active IR sensor.  
A gray slider means an inactive IR sensor.
3. Select **APPLY** and click **OK** to apply the changes.

## 10.3 Setting a custom projector name

### What can be done?

The default name of the projector is “Pulse”. However, you can change this name to make it easier to spot in a network with multiple devices or projectors

### How to set a different Host name

1. In the main menu, select *Settings* → *Communication* → *Host name*.

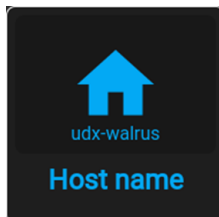

Image 10–12 Settings menu, host name

The Host name menu is displayed.

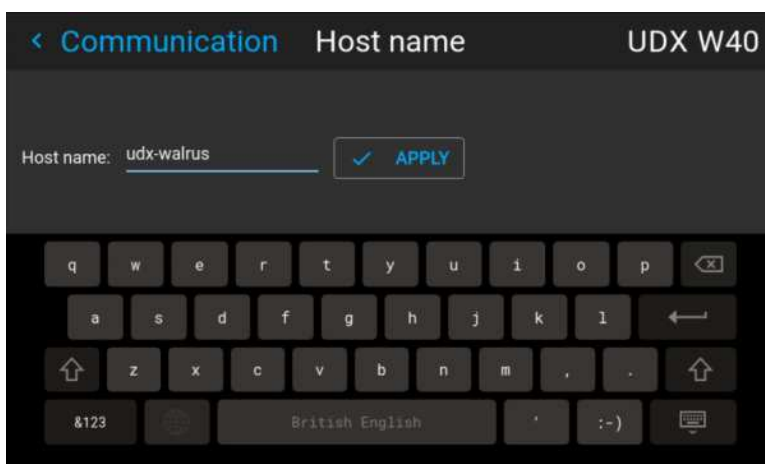

Image 10–13 Example of the host name menu

2. Press confirm to edit the *Host name* field.
3. Use the digital keyboard to change the Hostname to the desired custom name.
4. Press the *OK* key, or press the enter icon to confirm the typed name. Click *Apply to update the host name*.

## 10.4 DMX

### About the ways to control the projector via DMX

DMX signals can be connected to the DMX In port on the communicator interface when using a standard DMX cable equipped with XLR connector. The DMX out can be used to create a chain of DMX devices. One universe can control up to 512 channels.

If you are using a DMX console and other automated lighting products compatible with Art-Net, the Ethernet network can serve as the link for DMX control. All DMX controls can be sent over the Ethernet cable. Multiple universes are possible.

### About the DMX menu

DMX Feature	What can be done?
DMX Address	Before a projector can execute DMX commands, a unique address (named DMX address) should be given to the projector. This address can vary from 1 to 512.
DMX Mode	Two different modes for DMX are available. <ul style="list-style-type: none"> <li>• <b>Basic:</b> A basic configuration where 2 channels are implemented.</li> <li>• <b>Extended:</b> A full configuration, spread over 14 channels.</li> </ul> For the full mapping of each used channel, refer to the DMX chart in the appendices. See “DMX chart”, page 173.
DMX Monitor	If a DMX device is connected, the settings per channel can be displayed via the Monitor button.
Art-Net DMX	DMX can be sent via the Ethernet connector to the projector instead of the classic DMX connector. This function can be enabled or disabled. Art-Net is generally used when more than 512 addresses are used in your setup.
DMX Universe	<b>Note:</b> DMX Universe can only be used when Art-Net DMX is enabled. If Art-Net is enabled, you can specify which DMX universe this projector belongs to.
DMX auto power down	The projector can be forced to shut down after a certain time-out period (in minutes) if no DMX signals are available.
Front XLR connector	If available, the power of the XLR connector on the front side of the projector can be enabled and set to a desired value.

### How to set up DMX?

1. In the main menu, select *System Settings* → *Communication* → *DMX*.

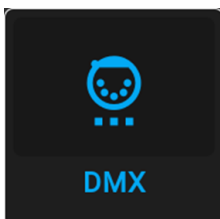

Image 10–14 Communication menu, DMX

The DMX menu is displayed.

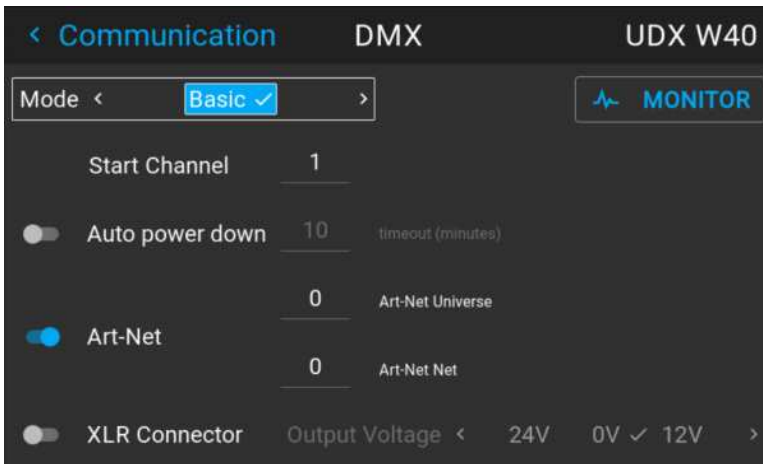

Image 10-15 Example of the DMX menu

2. Choose the desired DMX mode.
3. Choose the desired starting channel.
4. Choose whether or not you want the Auto power-down feature to be enabled. If enabled, determine the time-out.
5. If required, enable Art-Net. If enabled, determine the desired Art-Net Universe and Art-Net channel.
6. If a front XLR connector is available on your projector, you can enable the output voltage on this connector.

## 10.5 Changing the User Interface language

### How to change the language of the user interface

1. In the main menu, select *Settings* → *User interface* → *Language*.



Image 10-16 Interface

The Language menu is displayed.

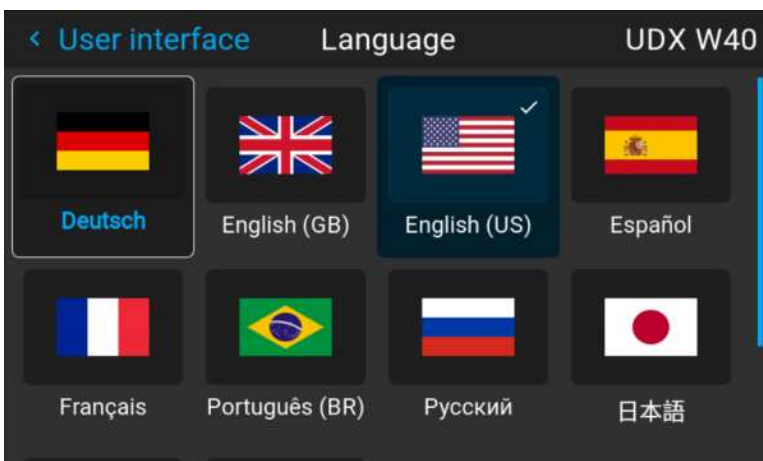

Image 10-17 Example of the Language menu

2. Select the desired language. You can choose between the following:
  - German (DE)
  - English (EN-US)
  - Spanish (ES)
  - French (FR)
  - Japanese (JA)
  - Korean (KO)
  - Portuguese (PT-BR)
  - Russian (RU)
  - Chinese (ZH)

## 10.6 Themes

### About Themes

Themes are used to apply a predefined functionality to the OSD display. There are two options: light or dark (default).



While the default theme is dark, all images in this manual are taken while using the light theme.

### How to select a different interface theme

1. In the main menu, select *Settings* → *User interface* → *Themes*.

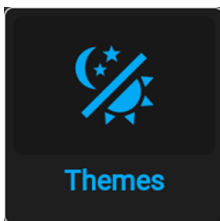

Image 10–18 Settings menu, themes

2. In the themes menu, select the desired *Theme*.  
You can choose one of the following: *Light*, or *Dark*.

## 10.7 Setting the measurement system

### About the measurement systems

You can use this menu to change the default measurement systems. By default the metric system is used. But you can choose between the following:

- Temperature: °C or °F
- Distance: meter, centimeter, feet or inch.

### How to set a different metric system

1. In the main menu, select *Settings* → *User interface* → *Units*.

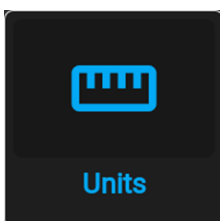

Image 10–19 Settings menu, units



The Units menu is displayed.

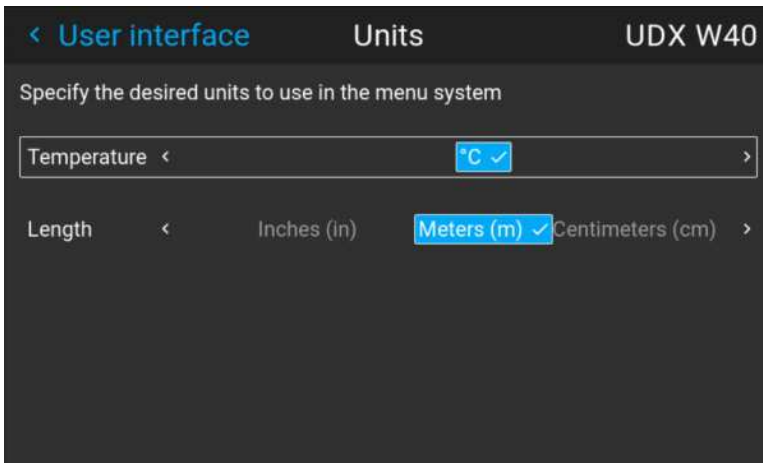

Image 10–20 Example of the Units menu

2. Select the desired *Temperature* unit and *Length* unit and confirm.

## 10.8 ECO mode

### About Standby ECO

When the ECO mode is enabled, the projector will automatically go to **ECO standby** mode after a time-out (default 15 minutes). All electronics (including fans, pumps, ...) go down except for a very small wake-up controller. See section dedicated to the Power Mode transitions for further details.



Until recently, it was not possible to navigate through the on-screen display (OSD) of the projector while in Ready mode. This feature has been implemented from software version 1.7 onward.

### How to enable/disable the ECO mode

1. In the main menu, select *System Settings*.
2. In the System Settings menu, choose to either enable or disable ECO mode by using the *ECO mode* slider. While ECO mode is available, the slider is colored blue.

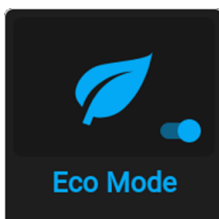

Image 10–21 Settings menu, enable ECO mode

## 10.9 Power settings

### Why change the power saving features?

As a power-saving feature, the projector will automatically go to standby mode after 15 minutes. While in standby mode, it is no longer possible to use the OSD for anything other than a status overview.

If you want to be able to fully access the projector for a longer period of time, or want to reduce the time the projector remains idle, it is best to change the power settings to your own personal preferences.

You can also fully disable these power-saving features all together, ensuring that all power state transitions have to be done manually, or via remote commands (e.g. by using DMX). See [“ECO mode”, page 121](#).

## How to change the power saving features?

1. In the main menu, select *Settings* → *Power settings*.

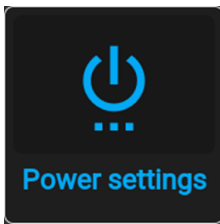

Image 10-22 Settings menu, Power settings

The power settings menu is displayed.

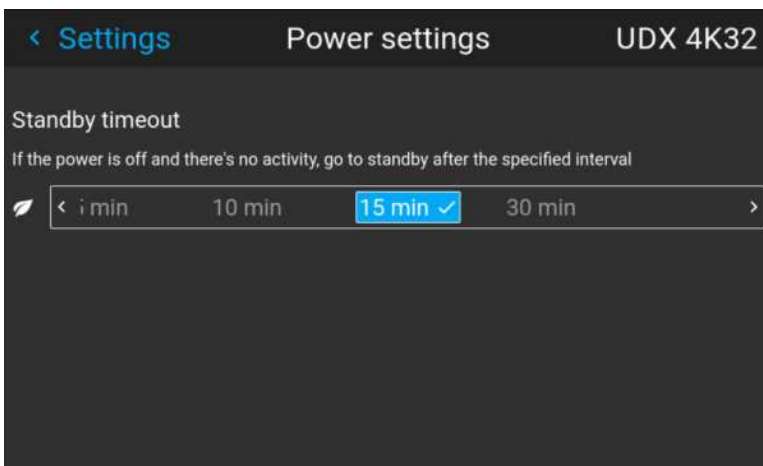

Image 10-23 Example of the power settings menu

2. To change the time the projector goes to stand-by mode, select the desired *Standby time-out*.

## 10.10 Lens features

### What can be done?

Some lens features can be disabled once they are correctly aligned so that a misalignment during a show is not possible.

### How to enable/disable

1. In the main menu, select *System Settings* → *Lens Features*.

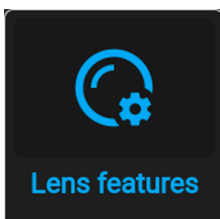

Image 10-24 Settings menu, Lens features

The Lens features menu is displayed.

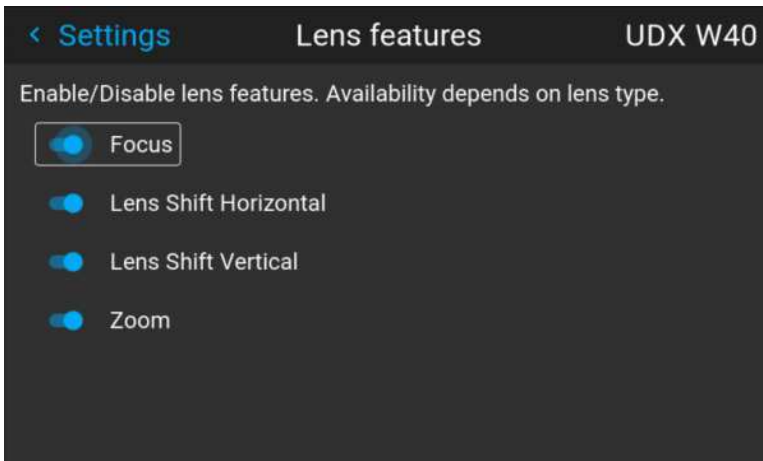

Image 10–25 Example of the lens features menu

Depending on the mounted lens type, different functions may or may not be available such as:

- Focus
- Horizontal lens shift
- Vertical lens shift
- Zoom

2. To enable/disable a feature, click on the slider and drag it to the left to disable the feature or the right to enable the feature.

When enabled, the slider becomes blue; when disabled, the slider is gray.

## 10.11 Controlling the backlight of the LCD Display

### What lighting can be controlled?

You can choose how quickly the backlight of the LCD turns off. You can select one of the default values, or enter a custom value.

### Stealth Mode

Alternatively, you can turn on **Stealth Mode** instead. By activating this mode, the backlight of the LCD, the backlight of all the buttons of the keypad and the indication LEDs for the LAN and HDBaseT inputs will be disabled

**Stealth Mode** is enabled and disabled by pressing the OSD button on the remote control for 3 seconds.

### How to set the backlight

1. In the main menu, *Settings* → *User interface* → *Backlight*.



Image 10–26 Settings menu, backlight

The Backlight menu will be displayed.

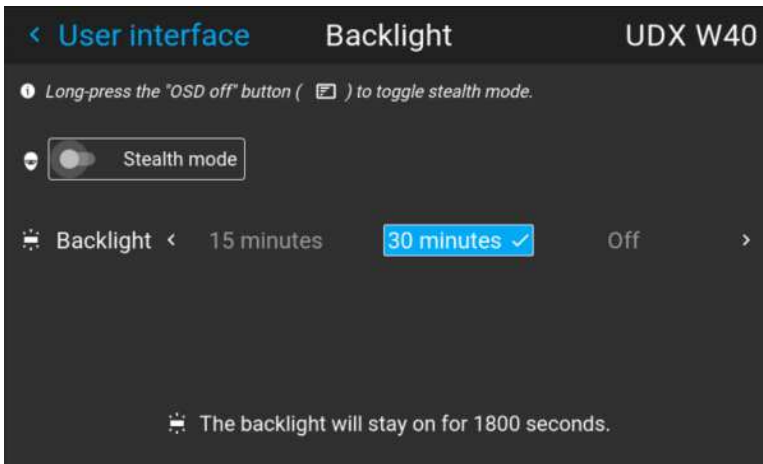

Image 10–27 Example of the backlight menu

2. Choose the desired setting for the backlights. Select one of the predetermined options, or a custom value.

## 10.12 Factory reset

### What can be done?

All settings and values on the projector can be reset to its default values. This can be done for one or more settings separately, or all settings together (factory reset).

### Factory settings

The following settings are the default factory settings:

Option	Setting	Factory setting
DMX	DMX Mode	Basic
	Start Channel	1
GSM		
Illumination	Power	100%
Image blend	Blend/Mask size Black Level	Disabled, all value to zero
	Black Level Files Blend Files	Disabled, all files deleted
Image connectors	Color Space	auto
	Signal Range	auto
Image convergence	Electronic Convergence	All values to zero
Image display	Display mode	AutoStereo
Image features	Contrast	mid value
	Brightness	mid value
	Saturation	mid value
	Sharpness	mid value
	Gamma	mid value
	Cropping	Off

Option	Setting	Factory setting
	Aspect Ratio	16:9
	Scaling	Fill Aspect ratio
Image Orientation	Orientation	Table, Front
Image RealColor P7	P7 Realcolor	all set to native
Image Resolution	Output Resolution (if applicable)	4K UHD
Image Source	Source files	Standard
Image 3D	Sync delay	0 $\mu$ s
	Swap eye	Off
	Dark time	lowest value available
Test patterns	Test Pattern	Off, none selected
Image uniformity		
Image Warp	Screen size	5120x3200 / 2560x1600
	4 corner Bow	Warp disabled, no warp
	Warp files	Disabled, all warp files deleted
Network	Communication	LAN, Automatic settings
Optics	High Contrast	Off
Peripheral	Settings for External Cooler	Cooling mode set to internal.
	Settings for Motorized Frame	All values to mid value
Profiles	Settings for projector profile and macro's	All profiles are deleted
Screen	Screen luminance - Unit	nits
System	Auto off / Eco Mode / Standby Mode (depending on availability)	Enabled
	Ready Time-out	auto
User	User profiles	Only default users remain
User interface	Theme	Dark
	Units – Temperature	°C
	Units – Length	Meters (m)

### How to reset all projector settings

1. In the main menu, select *Settings* → *Maintenance* → *Reset*.

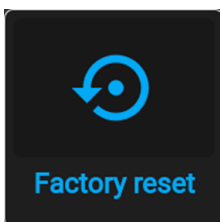

Image 10–28 Settings menu, factory reset

The Reset menu is displayed.

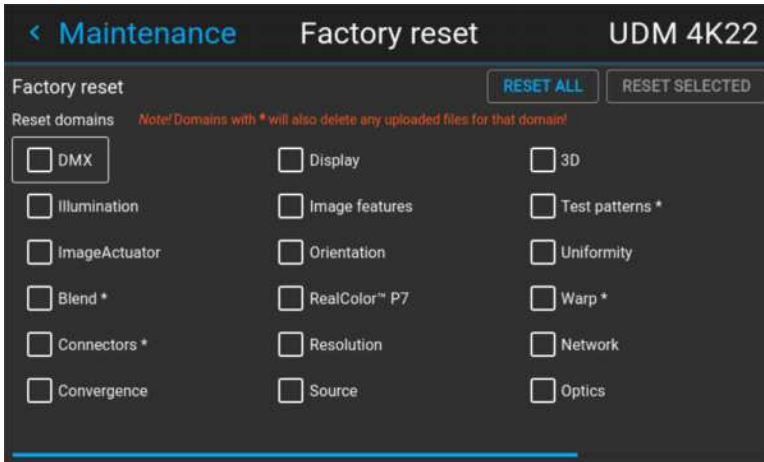

Image 10–29 Example of the reset menu

2. In the Reset menu, select *RESET ALL* and confirm with **OK**.

### How to reset one or more projector settings

1. In the main menu, select *Settings* → *Maintenance* → *Reset*.

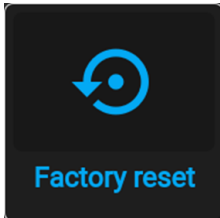

Image 10–30 Settings menu, factory reset

The Reset menu is displayed.

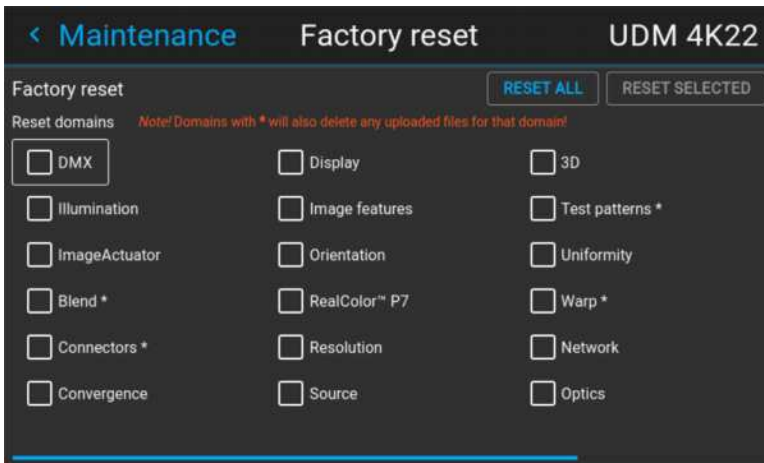

Image 10–31 Example of the reset menu

2. Navigate to the checkbox next to the settings that need to be reset and press **OK**. Multiple selections are possible.
3. Select **RESET SELECTED** and confirm with **OK** to reset all selected settings.

## 10.13 Lens Calibration

### How to calibrate

1. In the main menu, *Settings* → *Maintenance* → *Lens Calibration*.



Image 10–32 Maintenance menu, lens calibration

The Lens Calibration menu is displayed, alongside the status of each

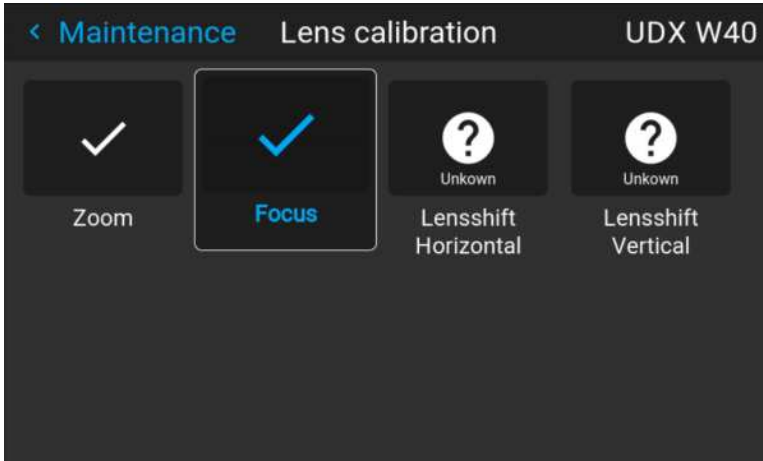

Image 10–33 Example of the lens calibration menu

2. In the Lens Calibration menu, select the desired calibration action and click **OK**.  
 You can select one of the following functions, depending on the type of mounted lens:
  - Horizontal lens shift
  - Vertical lens shift
  - Focus
  - Zoom

The text **Calibrating** will be displayed in the icon of the selected function until the calibration is completed.

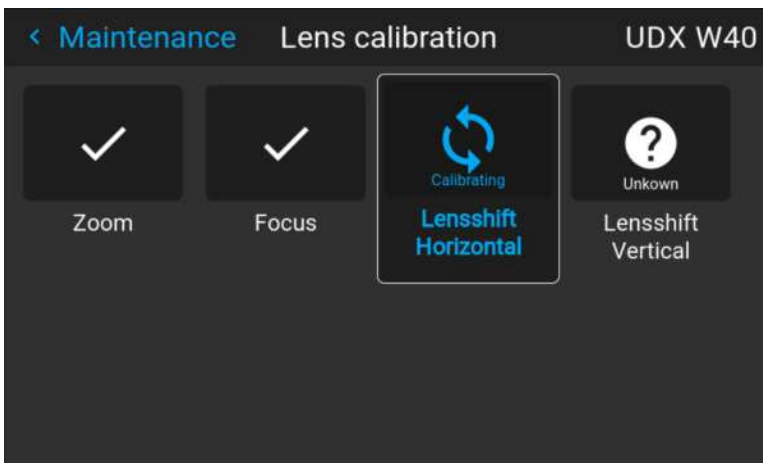

Image 10–34 example of calibration in progress

When an error is detected, the message *Calibration Error* is displayed next to function.

## 10.14 Operational mode

### Overview

The F80 range now offers you a possibility to choose the most relevant user mode for your application. You can select, setup and tweak the mode which you need, while a smart monitoring algorithm in the background keeps on balancing and optimizing between illumination output power, minimal noise level and optimized temperature household.

These are the presets being offered to start from:

1. “*Normal mode*”: This is the standard mode delivering highest possible brightness while ensuring a life time of 20000 hrs and keeping the noise level below 40 dB.
2. “*Silent mode*”: controlling maximal fan speed staying < 35 dB.
3. “*Long Life mode*”: Bringing the lifetime to 40.000hrs by carefully balancing between cooling and output power.
4. “*High brightness mode*”: Offer maximum brightness under all ambient conditions.

### How to change the operational mode of your projector

1. In the main menu, navigate to *System Settings* → Operational mode.

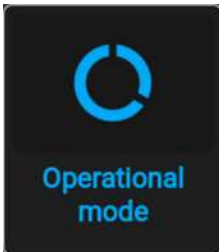

Image 10–35 Maintenance menu, operational mode

The Operational Mode menu is displayed.

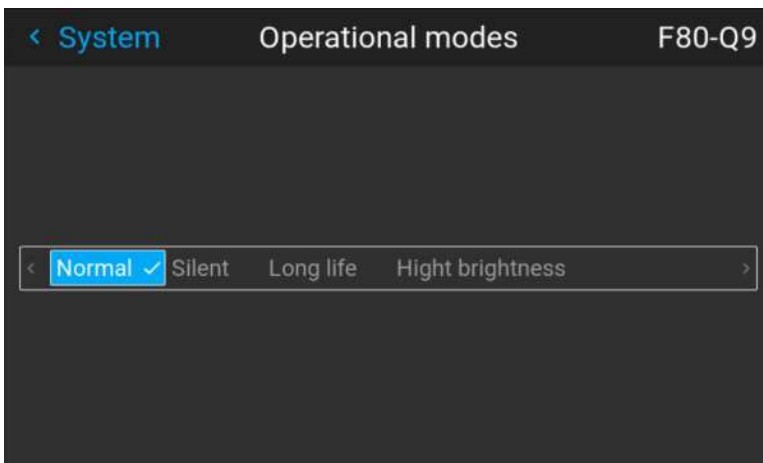

Image 10–36 Example of the Operational modes menu

2. Choose the desired operational mode.  
You may immediately notice a small difference, depending on the chosen operational mode.
3. Navigate to the Illumination menu and update the desired light output, depending on the chosen operational mode.



**Note:** If the Light source cannot sustain the desired power, it will automatically be reduced to a power level that's sustainable for the light source and the chosen cooling power



## 10.15 Advanced Settings

### About the Advanced Settings menu

The Advanced Settings and Remote access menus are hidden by default for the regular user. You can only make these menus visible after entering a *Service code* with the remote control.

If you have a service code, navigate to the *Maintenance* menu. Enter the code with the numeric keys. If entered correctly, the Advanced Settings and Remote access options will become visible. Next to that, a red “shield” icon on top of the Maintenance menu will become visible.



It doesn't matter what else you do or type with the remote. As long as you type in the service code in the correct order, the Advanced Settings option will become visible.

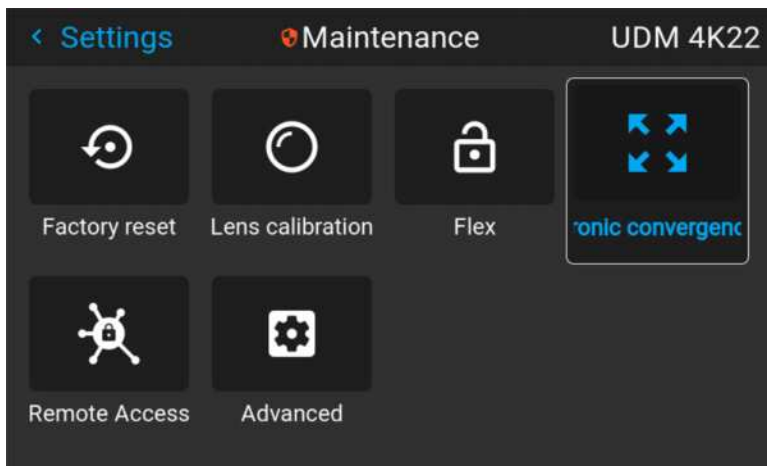

Image 10–37 Example of the Maintenance menu, with the Advanced menu and Remote access menu unlocked



The Advanced Settings and Remote access menu items will remain visible until you leave the Maintenance menu.

### 10.15.1 Remote access – Enable source preview

#### Source preview

Up until Pulse software 2.0.x, you were able to see a preview of the connected source when you remotely accessed the projector. This was a feature you could disable using PToolset.

However, from Pulse 2.1.x onward, this feature is disabled by default and can now be enabled in both PToolset and the Pulse GUI.



Upgrading your projector from a software version 2.0.x or older to 2.1.x or newer will disable *Source preview* by default. Once the software has been successfully upgraded, you can always opt to enable this feature again.

#### How to enable source preview

1. In the main menu, select *Settings* → *Maintenance* and enter the service code to visualize the hidden Remote access menu.

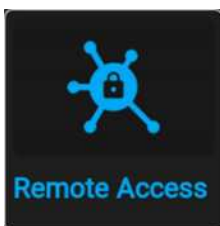

Image 10–38 Maintenance menu, Remote access

The *Remote access* menu is displayed.

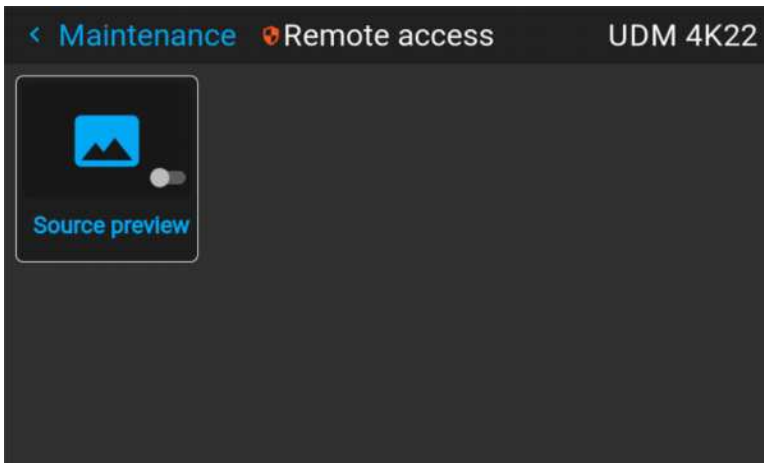

Image 10-39 Example of the Remote access menu

2. Enable the slider to enable the source preview feature.

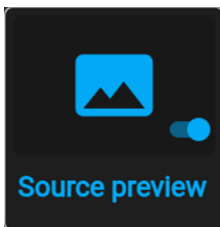

Image 10-40 Remote access menu, Source preview is enabled

## 10.15.2 Remote access – Enable camera preview

### Camera preview

Up until Pulse software 2.0.x, you were able to see the footage of the camera when you remotely accessed the projector. This was a feature you could disable using PToolset.

However, from Pulse 2.1.x onward, this feature is disabled by default and can now be enabled in both PToolset and the Pulse GUI.



Upgrading your projector from a software version 2.0.x or older to 2.1.x or newer will disable *Camera preview* by default. Once the software has been successfully upgraded, you can always opt to enable this feature again.

### How to enable Camera preview

1. In the main menu, select *Settings* → *Maintenance* and enter the service code to visualize the hidden Remote access menu.

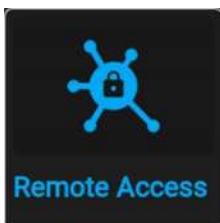

Image 10-41 Maintenance menu, Remote access

The *Remote access* menu is displayed.

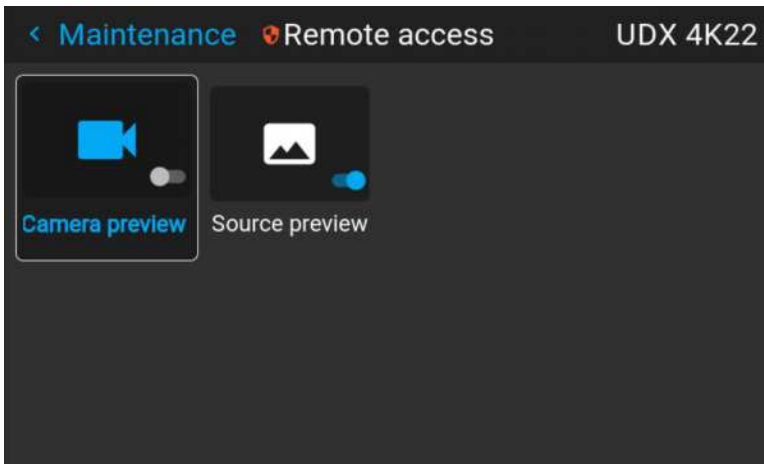

Image 10-42 Example of the Remote access menu

2. Enable the slider to enable the Camera preview feature.

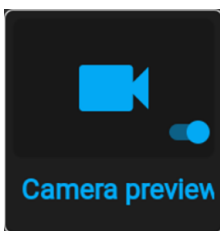

Image 10-43 Remote access menu, Camera preview is enabled

### 10.15.3 Service – Color Wheel

#### About Color Wheel

F80 is equipped with only one color wheel, which is controlled by the software. Using the advanced settings menu, a Slider makes it possible to fine-tune the color wheel for variation.

#### How to fine-tune the color wheel

1. In the main menu, select *Settings* → *Maintenance* → *Advanced*, while using the service code to enter the menu.

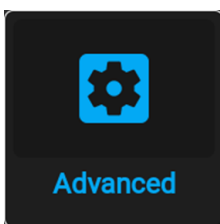

Image 10-44 Maintenance menu, Advanced

2. In the Advanced settings menu, select *Color wheel*.

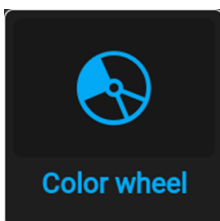

Image 10-45 Advanced Settings, Color wheel

The color wheel menu will be displayed.

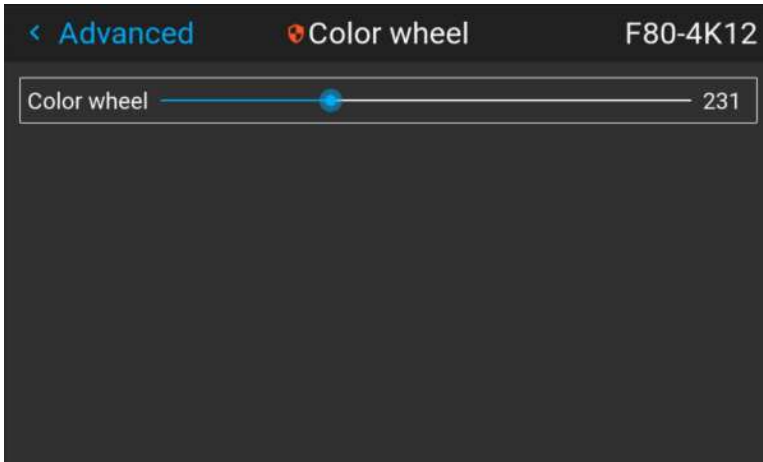

Image 10-46 Example of the Color wheel menu

3. Change the slider to the desired position.

### 10.15.4 Advanced Settings – Color



**CAUTION:** The native colors have been measured and set during factory production. Do not change them, unless parts of the optical path have been replaced due to servicing. If you need to change the native colors on the device, make sure to also perform a **P7 calibration**, using the Projector Toolset and a chroma meter. For more info on P7 calibration, refer to the Projector Toolset Reference guide.

#### How to adjust the P7 native settings

1. In the main menu, navigate to *Settings* → *Maintenance* → *Advanced*, while using the service code to enter the menu.

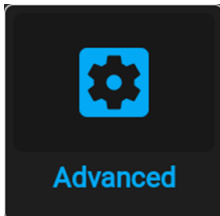

Image 10-47 Maintenance menu, Advanced

2. In the Advanced Settings menu, select *Native RealColor*.

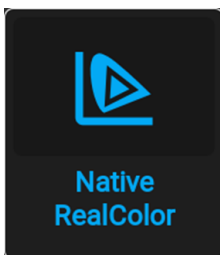

Image 10-48 Advanced Settings, Native Realcolor

The RealColor calibration menu will be displayed.

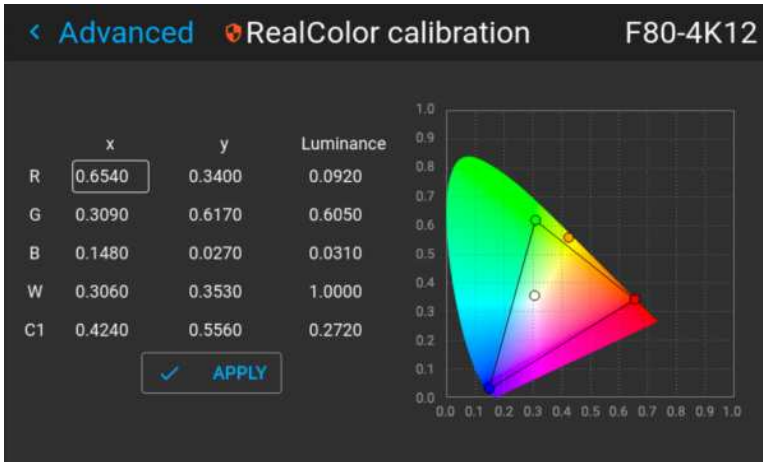

Image 10-49 Example of the RealColor calibration menu

3. Select the desired value to change and confirm.
4. Change the values to the desired position, taking into account the color gamut values.
5. Select **APPLY** and confirm.

### 10.15.5 Advanced Settings – Statistics

#### What can be seen?

The statistics screen displays the general information about the projector, spread over different tab pages.

The following items will be displayed:

- Fan run time
- Long frequency run time
- Pump run time
- System run time
- Total operating time
- Laser on time
- Laser shut time
- System uptime

#### How to display the statistics

1. In the main menu, navigate to *Settings* → *Maintenance* → *Advanced*, while using the service code to enter the menu.

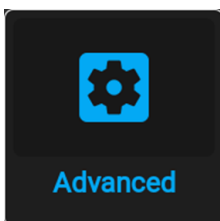

Image 10-50 Maintenance menu, Advanced

2. In the Advanced Settings menu, select *Statistics*.

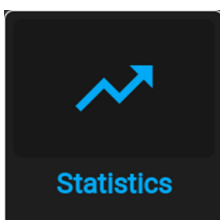

Image 10-51 Advanced settings, Statistics

The Statistics menu will be displayed.

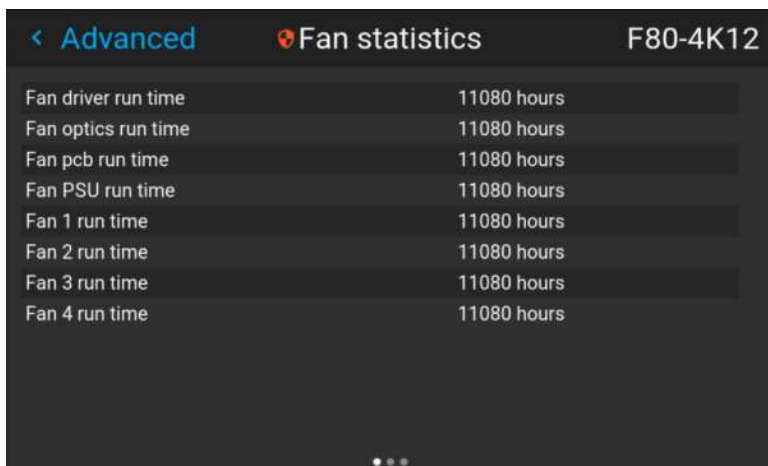

Image 10-52

- Use the left and right keys to shift between *Fan statistics*, *System statistics* and *Light source statistics*.

## 10.15.6 Advanced Settings – Pixel Shift

### About Pixel Shift

The 4k projector variants use an actuator to achieve a 4k resolution. This actuator can be calibrated by using the XPR test pattern and subsequently adjusting parameters in the **Pixel shift** menu until the desired result is achieved. These settings are the following:

- Gain:** The amplitude of the waveform, sent to the actuator. Default value: 0.65
- Resonance:** The frequency of the actuator. When this value is 0, the actuator is off. High frequencies mean much noise. Default value: 227 Hz

### How to fine-tune the actuator

- Use Projector Toolset to project the Cross hatch test pattern. In order to do so, go to the *service menu* → *Run pixel shift*. For more info on how to project the cross hatch test pattern, refer to the Projector Toolset user guide.

The repetitive XPR test pattern (cross hatch) will be displayed.

- Make sure the projector orientation is set to *Desktop front*. For more info, refer to “[Orientation](#)”, page 77.



*Tip:* For the best possible result, it is advised to only use the *desktop front* orientation while performing pixel shift, no matter how the projector is actually mounted.

- In the main menu, navigate to *Settings* → *Maintenance* → *Advanced*, while using the service code to enter the menu.

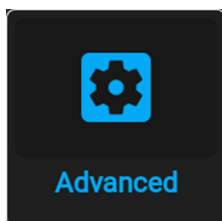

Image 10-53 Maintenance menu, Advanced

- In the Advanced Settings menu, select *Pixel Shift*.

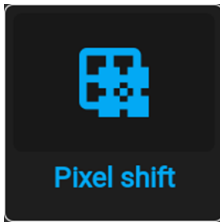

Image 10–54 Advanced settings, Pixel shift

The Pixel Shift menu will be displayed.

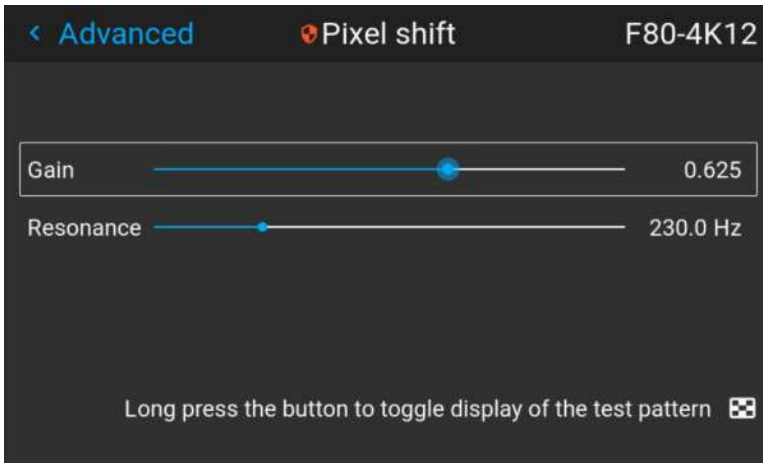

Image 10–55 Example of the pixel shift menu

5. Use the *Gain* and *Resonance* sliders to fine tune the actuator until the center marker hits the **bullseye**. Use Align both following images with the sliders available in this menu.

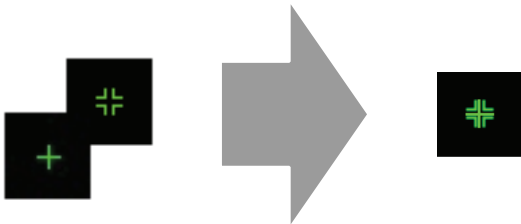

Image 10–56 The alternating XPR test pattern

## 10.15.7 Checking the status of the Laser Banks

### About failing laser banks

The projector is powered by a laser light source, which has multiple laser banks. The light output and color performance is dependant on the number of active laser banks.

If one or more laser banks have failed of a certain type, you will notice a decreased light input and decrease in color performance. But the projector will keep on playing, unless too many banks of a certain color will have failed.



In order to disable a certain laser bank, or calibrate the projector after disabling one or more laser banks, please refer to the Projector Toolset User Manual.

### How to check the status of the Laser Banks

1. In the main menu, navigate to *Settings* → *Maintenance* → *Advanced*, while using the service code to enter the menu.

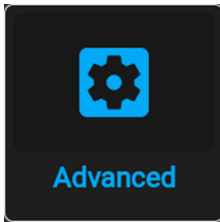

Image 10-57 Maintenance menu, Advanced

2. Enter the service code.
3. In the *Service* menu, select *Laser Banks*.



Image 10-58 Advanced menu, Laser banks

The Laser group statistics menu is displayed.

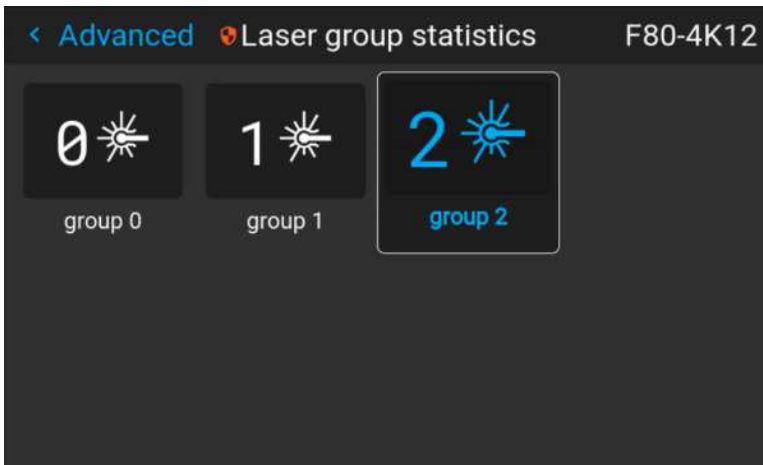

Image 10-59 Example of the Laser group statistics menu

4. Select the desired laser group.
5. In the laser banks group page, you can see which laser banks are part of this specific group. You can also see which laser banks are operational and which have failed.

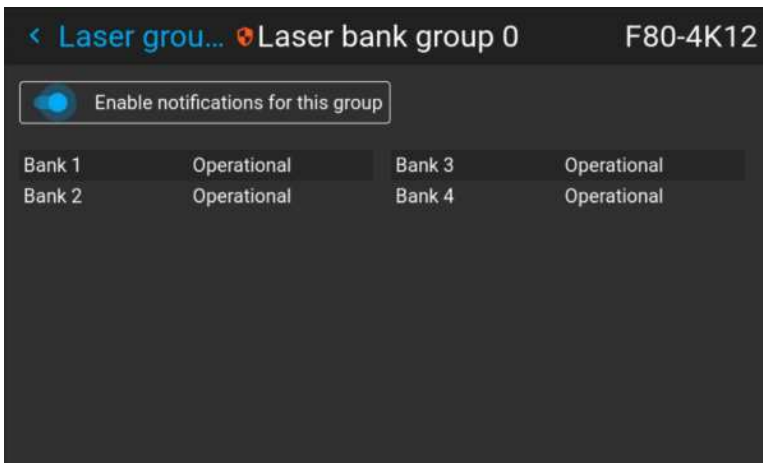

Image 10-60 Example of the laser bank group menu



- If you want notifications to be disabled for a specific group of laser banks, disable the *Enable notifications for this group* slider.

## 10.15.8 Advanced settings – Tilt sensor calibration



**CAUTION:** The calibration procedure resets the values of the tilt sensor to 0 in the current position of the projector. For the optimal working of the tilt sensor it is important to make sure the projector is perfectly level when performing this procedure. If not, the tilt sensor will not function as desired once the calibration has been completed.

### Required tools

Level

### How to calibrate the tilt sensor?

- Place the projector on a flat surface and make sure it is positioned level in all directions. Use a level tool to help ensure this.
- In the main menu, navigate to *Settings* → *Maintenance* → *Advanced*, while using the service code to enter the menu.

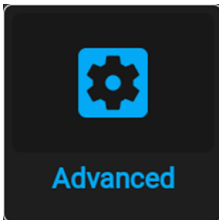

Image 10–61 Maintenance menu, Advanced

- Enter the service code.
- In the *Service* menu, select *Tilt sensor calibration*.



Image 10–62 Advanced menu, Tilt sensor calibration

- Confirm your action.

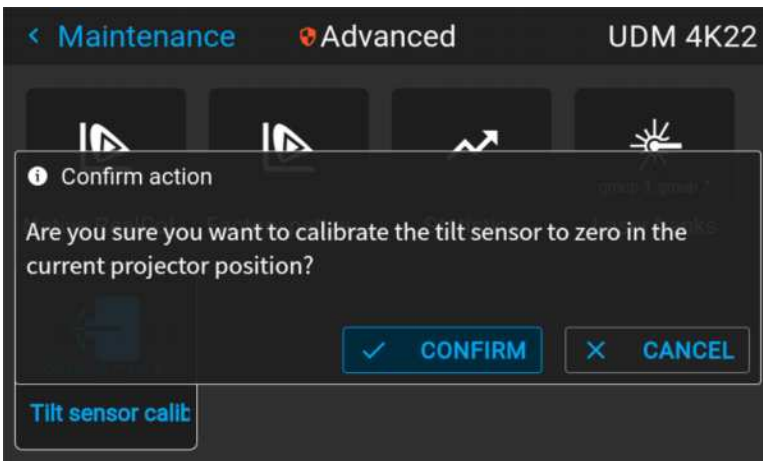

Image 10–63 Example of the Advanced menu with the Tilt sensor menu

The tilt sensor will be set to zero in the current position of the projector.

# GUI – Status menu

# 11

11.1	Status menu overview.....	140
------	---------------------------	-----



No settings can be modified in the status menu. Its only for consulting.

## 11.1 Status menu overview

### How to access the status menu

While in the main menu, press Status.

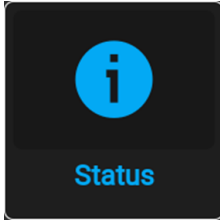

Image 11-1 Main menu, status

The status menu is displayed.



Image 11-2 Example of a status menu

Swipe the screen to switch between the Status and About page.

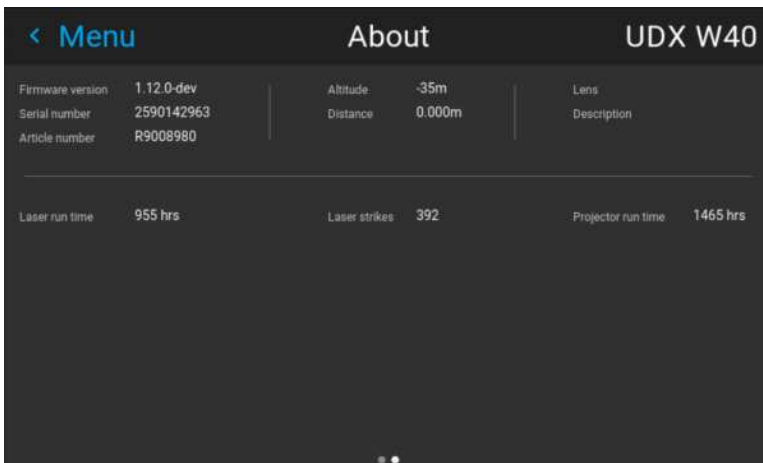

Image 11-3 Example of the About page in the Status menu

### What can be seen on the Status page?

- Connected source and signal details
- Display settings (e.g. Display mode, transport delay, output resolution, etc)
- Projector power and environmental details (e.g. power, temperature, pressure, etc)
- Network status (e.g. host name, IP address, software version)
- Active function icons (e.g. warp, blend, files, etc).

**What can be seen on the About page?**

- Projector information, e.g. firmware version, serial number and projector article number
- Mounted lens: Type and description
- Basic statistics, e.g. light source run time, projector runtime



# Maintenance

# 12

12.1	Cleaning the lens .....	144
12.2	Cleaning the exterior of the projector .....	144
12.3	Filters .....	144

## About this chapter

This chapter contains general maintenance procedures.

## 12.1 Cleaning the lens



To minimize the possibility of damage to optical coatings, or scratches to lens surfaces follow the cleaning procedure as described here precisely.

### Required tools

- Compressed air
- Clean micro fiber lens cleaning cloth (e.g. Toraysee® cloth(s))
- Clean cotton cloth
- Lens cleaner (e.g. ZEISS lens cleaner, Purosol™ or other water based lens cleaner products)

### How to clean the lens?

1. Blow off dust with clean compressed air (or pressurized air cans<sup>3</sup>).
2. Clean with lens cleaner together with a clean lens cleaning cloth to remove the dust and contamination. Use big wipes in one single direction.
  - ⚠ **Warning:** Do not wipe back and forwards across the lens surface as this tends to grind dirt into the coating.
3. Use a dry lens cleaning cloth to remove left liquid or stripes. Polish with small circles.
4. If there are still fingerprints on the surface, wipe them off with lens cleaner together with a clean lens cleaning cloth. Polish again with a dry one.



If smears occur when cleaning lenses, replace the cloth. Smears are the first indication of a dirty cloth.

## 12.2 Cleaning the exterior of the projector

### How to clean the exterior of the projector ?

1. Switch off the projector and unplug the projector from the mains power net.
2. Clean the housing of the projector with a damp cloth. Stubborn stains may be removed with a cloth lightly dampened with a mild detergent solution.

## 12.3 Filters

### General info regarding Air intake and filters.

The F80 is shipped without any filters. The air intake is just protected by a mesh. This mesh has to be vacuum cleaned occasionally when needed. There is no specific interval for this operation.

3. Pressurized air cans are not efficient if there is too much dust on the surface, the pressure is too low



# Specifications

# A

A.1	Specifications of the F80-Q7.....	146
A.2	Specifications of the F80-Q9.....	147
A.3	Specifications of the F80-Q12.....	149
A.4	Specifications of the F80-4K7.....	150
A.5	Specifications of the F80-4K9.....	152
A.6	Specifications of the F80-4K12.....	153
A.7	Dimensions of a F80.....	155
A.8	Technical Regulations.....	156

## A.1 Specifications of the F80-Q7

### Overview

<b>Projector type</b>	Single-chip DLP laser phosphor projector
<b>Resolution</b>	2,716 x 1,600 (WQXGA+ native)
<b>Brightness</b>	7,000 center lumen* 6,600 ansi lumen 7,500 ISO lumen
<b>Contrast ratio</b>	1,200:1 sequential, 10,000:1 dynamic**
<b>Brightness uniformity</b>	> 90%
<b>Aspect ratio</b>	16:10
<b>Lens type</b>	GLD/FLDX/FLD+(lens adapter needed)
<b>Optical lens shift</b>	Vertical up to 125%, depending on lens Horizontal up to 50%, depending on lens Motorized zoom and focus (with lens memory on GLD and FLDX lenses) Motorized lens shift (with position memory on all lenses)
<b>Color correction</b>	P7 RealColor™
<b>CLO (constant light output)</b>	Yes
<b>Light source</b>	Laser phosphor
<b>Light source lifetime</b>	> 20000 h in normal mode, > 12000 h in silent mode, > 40000 h in long life mode, > 12000 h in high brightness mode
<b>Sealed DLP™ core</b>	Yes
<b>Orientation</b>	360° rotation, no restrictions
<b>3D</b>	Active stereoscopic 3D / Passive stereo compatible
<b>Image processing</b>	Embedded warp & blend engine
<b>Keystone correction</b>	Yes
<b>Inputs</b>	12G-SDI, 2x DP 1.2, 2x dual link DVI-D, HDBaseT, HDMI2.0 (HDCP2.2, HDR10), RJ 45 Ethernet, DMX in/out*, RS232 in, 2x USB, 12V out
<b>Input resolutions</b>	Up to 4K UHD @ 60Hz / Up to 2,560 x 1,600 @ 120Hz refresh rates: 24Hz to 120Hz for WQXGA+ (2716x1600) and 24Hz to 60Hz for 4K/ 4KUHD (4096 x 2160/ 3860 x 2400)
<b>Software tools</b>	Projector Toolset
<b>Control</b>	IR, RS232, RJ45, XLR wired
<b>Network connection</b>	10/100 Ethernet, RJ45
<b>Power requirements</b>	100-240V / 50-60Hz
<b>Power consumption</b>	700 W nominal, 850 W maximum
<b>BTU per hour</b>	2,400 BTU/h nominal, 2,900 BTU/h maximum
<b>Standby power</b>	<0.5W

<b>24/7 operation</b>	Yes
<b>Noise level (typical at 25°C/ 77°F)</b>	35 dB(A)
<b>Operating temperature</b>	10°C (50°F)- 40°C (104°F) (up to 1500m altitude) / 10° (50°F) - 35°C (95° F) (up to 3000m altitude)
<b>Storage temperature</b>	-20 to 60 °C
<b>Operating humidity</b>	20 - 80% RH (non-condensed)
<b>Storage humidity</b>	20 - 90% RH (non-condensed)
<b>Dimensions (WxLxH)</b>	480 x 680 x 227 mm / 18.9 x 26.7 x 8.9 in
<b>Weight</b>	25.5 kg / 56.2 lbs
<b>Standard accessories</b>	Power cord, wireless remote control
<b>Certifications</b>	CE, FCC Class A, cNemkoUS, CCC, EAC, KSA, RCM, UkrSEPRO
<b>Warranty</b>	Limited 3 years parts and labor. Extendable up to 5 years
*	* When measured with the GLD 1.43-2.12:1 lens in Wide Angle ** SW upgradable. Please contact an authorized Barco representative for details.

## A.2 Specifications of the F80-Q9

### Overview

<b>Projector type</b>	Single chip DLP laser phosphor projector
<b>Resolution</b>	2,716 x 1,600 (WQXGA+ native)
<b>Brightness</b>	9,000 center lumen* 8,500 ANSI lumen 9,600 ISO lumen
<b>Contrast ratio</b>	1,200:1 sequential, 10,000:1 dynamic **
<b>Brightness uniformity</b>	> 90%
<b>Aspect ratio</b>	16:10
<b>Lens type</b>	GLD/FLDX/FLD+(lens adapter needed)
<b>Optical lens shift</b>	Vertical up to 125%, depending on lens Horizontal up to 50%, depending on lens Motorized zoom and focus (with lens memory on GLD and FLDX lenses) Motorized lens shift (with position memory on all lenses)
<b>Color correction</b>	P7 RealColor™
<b>CLO (constant light output)</b>	Yes
<b>Light source</b>	Laser phosphor
<b>Light source lifetime</b>	> 20000 h in normal mode, > 12000 h in silent mode, > 40000 h in long life mode, > 12000 h in high brightness mode
<b>Sealed DLP™ core</b>	Yes
<b>Orientation</b>	360° rotation, no restrictions

<b>3D</b>	Active stereoscopic 3D / Passive stereo compatible
<b>Image processing</b>	Embedded warp & blend engine
<b>Keystone correction</b>	Yes
<b>Inputs</b>	12G-SDI, 2x DP 1.2, 2x dual link DVI-D, HDBaseT, HDMI2.0 (HDCP2.2, HDR10), RJ 45 Ethernet, DMX in/out*, RS232 in, 2x USB, 12V out
<b>Input resolutions</b>	Up to 4K UHD @ 60Hz / Up to 2,560 x 1,600 @ 120Hz refresh rates: 24Hz to 120Hz for WQXGA+ (2716x1600) and 24Hz to 60Hz for 4K/ 4KUHD (4096 x 2160/ 3860 x 2400)
<b>Software tools</b>	Projector Toolset
<b>Control</b>	IR, RS232, RJ45, XLR wired
<b>Network connection</b>	10/100 Ethernet, RJ45
<b>Power requirements</b>	100-240V / 50-60Hz
<b>Power consumption</b>	950 W nominal, 1,100 W maximum
<b>24/7 operation</b>	Yes
<b>BTU per hour</b>	3,250 BTU/h nominal, 3,800 BTU/h maximum
<b>Standby power</b>	<0.5w
<b>Throw Ratio</b>	0.85 - 1.06 ; 1.06 - 1.43 ; 1.43 - 2.12 ; 2.12 - 3.18 and compatible with FLD/FLD+ series (with adapter)
<b>Noise level (typical at 25°C/ 77°F)</b>	35 dB(A)
<b>Operating temperature</b>	10°C (50°F)- 40°C (104°F) (up to 1500m altitude) / 10° (50°F) - 35°C (95° F) (up to 3000m altitude)
<b>Storage temperature</b>	-20 to 60 °C
<b>Operating humidity</b>	20 - 80% RH (non-condensed)
<b>Storage - transport humidity</b>	20 - 90% RH (non-condensed)
<b>Dimensions (WxLxH)</b>	480 x 680 x 227 mm / 18.9 x 26.7 x 8.9 in
<b>Weight</b>	25.5 kg / 56.2 lbs
<b>Standard accessories</b>	Power cord, wireless remote control
<b>Certifications</b>	CE, FCC Class A, cNemkoUS, CCC, EAC, KSA, RCM, UkrSEPRO
<b>Warranty</b>	Limited 3 years parts and labor. Extendable up to 5 years
*	* When measured with the GLD 1.43-2.12:1 lens in Wide Angle ** SW upgradable. Please contact an authorized Barco representative for details.

## A.3 Specifications of the F80-Q12

### Overview

<b>Projector type</b>	Single-chip DLP laser phosphor projector
<b>Technology</b>	0.67" DMDTM x1
<b>Resolution</b>	2,716 x 1,600 (WQXGA+ native)
<b>Brightness</b>	11,300 center lumens 10,700 ANSI lumens 12,000 ISO lumens
<b>Contrast ratio</b>	1,200:1 sequential, 10,000:1 dynamic**
<b>Brightness uniformity</b>	> 90%
<b>Aspect ratio</b>	17:10 native
<b>Blend</b>	horizontal and vertical edge blending
<b>Lens type</b>	GLD / FLD+ (lens adapter needed) / FLDX (lens adapter needed)
<b>Lens range</b>	GLD-range: 0.8 - 1.0 ; 1.0 - 1.35 ; 1.35 - 2.0 ; 2.0 - 3.0
<b>Screen size</b>	max 20m
<b>Optical lens shift</b>	Vertical up to 125%, depending on lens Horizontal up to 50%, depending on lens Motorized zoom and focus (with lens memory on GLD and FLDX lenses) Motorized lens shift (with position memory on all lenses)
<b>Color correction</b>	P7 RealColor™
<b>Light source</b>	Laser phosphor
<b>Light source lifetime</b>	> 20000 h in normal mode, > 12000 h in silent mode, > 40000 h in long life mode, > 12000 h in high brightness mode
<b>Sealed DLP™ core</b>	Yes - standard
<b>Optical dowser</b>	laser dimming
<b>Orientation</b>	360° rotation, no restrictions
<b>DMX 512</b>	Standard
<b>Image processing</b>	Embedded warp & blend engine direct adjust OSD + Ptoolset
<b>Web browser</b>	integrated
<b>CLO (constant light output)</b>	Yes
<b>3D</b>	Active stereoscopic 3D / Passive stereo compatible max WQXGA @120Hz
<b>Keystone correction</b>	Yes
<b>Inputs</b>	HDMI2.0 (HDCP2.2, HDR10) / 2x DP 1.2 / 12G-SDI /2x dual link DVI-D / HDBaseT / RJ 45 Ethernet / DMX in-out / RS232 in / 2x USB / 12V out
<b>Input resolutions</b>	Up to 4K UHD @ 60Hz / Up to 2,560 x 1,600 @ 120Hz refresh rates: 24Hz to 120Hz for WQXGA+ (2716x1600) and 24Hz to 60Hz for 4K/ 4KUHD (4096 x 2160/ 3860 x 2400)

<b>Software tools</b>	Projector Toolset
<b>Control</b>	IR, RS232, RJ45, XLR wired
<b>24/7 operation</b>	Yes
<b>Network connection</b>	10/100 Ethernet, RJ45
<b>Power requirements</b>	100-240V / 50-60Hz
<b>Power consumption</b>	1050 W nominal, 1200 W maximum
<b>Standby power</b>	< 0.5W
<b>Noise level (typical at 25°C/ 77°F)</b>	35 dB(A) when used in silent mode / 39 dB(A) in normal mode
<b>Operational ambient temperature</b>	0°-35°C / 32°-95°F
<b>Storage temperature</b>	-20 to 60 °C
<b>operation humidity no condens</b>	0%-80%
<b>Storage humidity</b>	20 - 90% RH (non-condensed)
<b>Dissipation BTU</b>	max 4100 BTU/h
<b>Dimensions (WxLxH)</b>	480 x 680 x 227 mm / 18.9 x 26.7 x 8.9 in
<b>Weight</b>	26.8 kg / 59.1 lbs (without lens)
<b>Shipping dimensions (WxLxH)</b>	583 x 784 x 444 mm / 23.0 x 30.9 x 17.5 inch
<b>Shipping weight</b>	38.5 kg / 81.6 lbs
<b>Standard accessories</b>	Power cord, wireless/XLR wired rugged remote control
<b>Certifications</b>	Compliant with UL60950-1 and EN60950-1 complies with FCC rules & regulations, part 15 Class A and CE EN55022 Class A, RoHS
<b>Warranty</b>	3 years*
<b>Notes</b>	* except on light source: 20.000 hrs in normal mode or 3 years ** SW upgradable. Please contact an authorized Barco representative for details.

## A.4 Specifications of the F80-4K7

### Overview

<b>Projector type</b>	Single-chip DLP laser phosphor projector
<b>Resolution</b>	3,840 x 2,400 (4K UHD) / 2,716 x 1,600 (WQXGA+ native)
<b>Brightness</b>	7,000 center lumen* 6,600 ansi lumen 7,500 ISO lumen
<b>Contrast ratio</b>	1,200:1 sequential, 10,000:1 dynamic **
<b>Brightness uniformity</b>	> 90%

<b>Aspect ratio</b>	16:10
<b>Lens type</b>	GLD/FLDX/FLD+(lens adapter needed)
<b>Optical lens shift</b>	Vertical up to 125%, depending on lens Horizontal up to 50%, depending on lens Motorized zoom and focus (with lens memory on GLD and FLDX lenses) Motorized lens shift (with position memory on all lenses)
<b>Color correction</b>	P7 RealColor™
<b>CLO (constant light output)</b>	Yes
<b>Light source</b>	Laser phosphor
<b>Light source lifetime</b>	> 20000 h in normal mode, > 12000 h in silent mode, > 40000 h in long life mode, > 12000 h in high brightness mode
<b>Sealed DLP™ core</b>	Yes
<b>Orientation</b>	360° rotation, no restrictions
<b>3D</b>	Active stereoscopic 3D / Passive stereo compatible
<b>Image processing</b>	Embedded warp & blend engine
<b>Keystone correction</b>	Yes
<b>Inputs</b>	12G-SDI, 2x DP 1.2, 2x dual link DVI-D, HDBaseT, HDMI2.0 (HDCP2.2, HDR10), RJ 45 Ethernet, DMX in/out, RS232 in, 2x USB, 12V out
<b>Input resolutions</b>	Up to 4K UHD @ 60Hz / Up to 2,560 x 1,600 @ 120Hz refresh rates: 24Hz to 120Hz for WQXGA+ (2716x1600) and 24Hz to 60Hz for 4K/4KUHD (4096 x 2160/ 3860 x 2400)
<b>Software tools</b>	Projector Toolset
<b>Control</b>	IR, RS232, RJ45, XLR wired
<b>Network connection</b>	10/100 Ethernet, RJ45
<b>Power requirements</b>	100-240V / 50-60Hz
<b>Power consumption</b>	700 W nominal, 850 W maximum
<b>BTU per hour</b>	2,400 BTU/h nominal, 2,900 BTU/h maximum
<b>Standby power</b>	<0.5W
<b>24/7 operation</b>	Yes
<b>Noise level (typical at 25°C/ 77°F)</b>	35 dB(A)***
<b>Operating temperature</b>	10°C (50°F)- 40°C (104°F) (up to 1500m altitude) / 10° (50°F) - 35°C (95° F) (up to 3000m altitude)
<b>Storage - transport temperature</b>	-20 to 60 °C
<b>Operating humidity</b>	20 - 80% RH (non-condensed)
<b>Storage humidity</b>	20 - 90% RH (non-condensed)
<b>Dimensions (WxLxH)</b>	480 x 680 x 227 mm / 18.9 x 26.7 x 8.9 in
<b>Weight</b>	25.5 kg / 56.2 lbs

<b>Standard accessories</b>	Power cord, wireless remote control
<b>Certifications</b>	CE, FCC Class A, cNemkoUS, CCC, EAC, KSA, RCM, UkrSEPRO
<b>Warranty</b>	Limited 3 years parts and labor. Extendable up to 5 years
*	* When measured with the GLD 1.43-2.12:1 lens in Wide Angle ** SW upgradable. Please contact an authorized Barco representative for details.

## A.5 Specifications of the F80-4K9

### Overview

<b>Projector type</b>	Single chip DLP laser phosphor projector
<b>Resolution</b>	3,840 x 2,400 (4K UHD) / 2,716 x 1,600 (WQXGA+ native)
<b>Brightness</b>	9,000 center lumen* 8,500 ANSI lumen 9,600 ISO lumen
<b>Contrast ratio</b>	1,200:1 sequential, 10,000:1 dynamic**
<b>Brightness uniformity</b>	> 90%
<b>Aspect ratio</b>	16:10
<b>Lens type</b>	GLD/FLDX/FLD+(lens adapter needed)
<b>Optical lens shift</b>	Vertical up to 125%, depending on lens Horizontal up to 50%, depending on lens Motorized zoom and focus (with lens memory on GLD and FLDX lenses) Motorized lens shift (with position memory on all lenses)
<b>Color correction</b>	P7 RealColor™
<b>CLO (constant light output)</b>	Yes
<b>Light source</b>	Laser phosphor
<b>Light source lifetime</b>	> 20000 h in normal mode, > 12000 h in silent mode, > 40000 h in long life mode, > 12000 h in high brightness mode
<b>Sealed DLP™ core</b>	Yes
<b>Orientation</b>	360° rotation, no restrictions
<b>3D</b>	Active stereoscopic 3D / Passive stereo compatible
<b>Image processing</b>	Embedded warp & blend engine
<b>Keystone correction</b>	Yes
<b>Inputs</b>	12G-SDI, 2x DP 1.2, 2x dual link DVI-D, HDBaseT, HDMI2.0 (HDCP2.2, HDR10), RJ 45 Ethernet, DMX in/out*, RS232 in, 2x USB, 12V out
<b>Input resolutions</b>	Up to 4K UHD @ 60Hz / Up to 2,560 x 1,600 @ 120Hz refresh rates: 24Hz to 120Hz for WQXGA+ (2716x1600) and 24Hz to 60Hz for 4K/ 4KUHD (4096 x 2160/ 3860 x 2400)
<b>Software tools</b>	Projector Toolset



<b>Control</b>	IR, RS232, RJ45, XLR wired
<b>Network connection</b>	10/100 Ethernet, RJ45
<b>Power requirements</b>	100-240V / 50-60Hz
<b>24/7 operation</b>	Yes
<b>Power consumption</b>	950 W nominal, 1100 W maximum
<b>BTU per hour</b>	3,250 BTU/h nominal, 3,800 BTU/h maximum
<b>Standby power</b>	<0.5W
<b>Noise level (typical at 25°C/ 77°F)</b>	35 dB(A)
<b>Operating temperature</b>	10°C (50°F)- 40°C (104°F) (up to 1500m altitude) / 10° (50°F) - 35°C (95° F) (up to 3000m altitude)
<b>Storage temperature</b>	-20 to 60 °C
<b>Operating humidity</b>	20-80% RH (non-condensed)
<b>Storage humidity</b>	20-90% RH (non-condensed)
<b>Dimensions (WxLxH)</b>	480 x 680 x 227 mm / 18.9 x 26.7 x 8.9 in
<b>Weight</b>	25.5 kg / 56.2 lbs
<b>Standard accessories</b>	Power cord, wireless remote control
<b>Certifications</b>	CE, FCC Class A, cNemkoUS, CCC, EAC, KSA, RCM, UkrSEPRO
<b>Warranty</b>	Limited 3 years parts and labor. Extendable up to 5 years
*	* When measured with the GLD 1.43-2.12:1 lens in Wide Angle ** SW upgradable. Please contact an authorized Barco representative for details.

## A.6 Specifications of the F80-4K12

### Overview

<b>Projector type</b>	Single-chip DLP laser phosphor projector
<b>Technology</b>	0.67" DMDTM x1
<b>Resolution</b>	3,840 x 2,400 (4K UHD) / 2,716 x 1,600 (WQXGA+ native)
<b>Brightness</b>	11,300 center lumens 10,700 ANSI lumens 12,000 ISO lumens
<b>Contrast ratio</b>	1,200:1 sequential, 10,000:1 dynamic**
<b>Brightness uniformity</b>	> 90%
<b>Aspect ratio</b>	17:10 native
<b>Blend</b>	horizontal and vertical edge blending
<b>Lens type</b>	GLD / FLD+ (lens adapter needed) / FLDX (lens adapter needed)
<b>Lens range</b>	GLD-range: 0.8 - 1.0 ; 1.0 - 1.35 ; 1.35 - 2.0 ; 2.0 - 3.0

<b>Screen size</b>	max 20m
<b>Optical lens shift</b>	Vertical up to 125%, depending on lens Horizontal up to 50%, depending on lens Motorized zoom and focus (with lens memory on GLD and FLDX lenses) Motorized lens shift (with position memory on all lenses)
<b>Color correction</b>	P7 RealColor™
<b>Light source</b>	Laser phosphor
<b>Light source lifetime</b>	> 20000 h in normal mode, > 12000 h in silent mode, > 40000 h in long life mode, > 12000 h in high brightness mode
<b>Sealed DLP™ core</b>	Yes
<b>Optical dowser</b>	Laser dimming
<b>Orientation</b>	360° rotation, no restrictions
<b>DMX 512</b>	Standard
<b>Image processing</b>	Embedded warp & blend engine direct adjust OSD + Ptoolset
<b>CLO (constant light output)</b>	Yes
<b>3D</b>	Active stereoscopic 3D / Passive stereo compatible max WQXGA @120Hz
<b>Keystone correction</b>	Yes
<b>Inputs</b>	HDMI2.0 (HDCP2.2, HDR10) / 2x DP 1.2 / 12G in (and 12G loop through) /2x dual link DVI-D / HDBaseT
<b>Input resolutions</b>	From VGA up to 4K (4096 x 2160) refresh rates: 24Hz to 120Hz for WQXGA+ (2716x1600) and 24Hz to 60Hz for 4K/ 4KUHD (4096 x 2160/ 3860 x 2400)
<b>Software tools</b>	Projector Toolset
<b>Control</b>	TCP-IP / IR / RS-232 / XLR wired
<b>Network connection</b>	10/100 Base-T, RJ-45 connector
<b>Power requirements</b>	100-240V / 50-60Hz
<b>Power consumption</b>	1050 W nominal, 1200 W maximum
<b>Standby power</b>	< 0.5W
<b>Noise level (typical at 25°C/ 77°F)</b>	35 dB(A) when used in silent mode / 39 dB(A) in normal mode
<b>24/7 operation</b>	Yes
<b>Operational ambient temperature</b>	0°-35°C / 32°-95°F
<b>Storage temperature</b>	-20 to 60 °C
<b>Operating humidity</b>	0% - 80% RH (non-condensed)
<b>Storage humidity</b>	20 - 90% RH (non-condensed)
<b>Dissipation BTU</b>	max 4100 BTU/h

<b>Dimensions (WxLxH)</b>	480 x 680 x 227 mm / 18.9 x 26.7 x 8.9 in (without feet)
<b>Weight</b>	26.8 kg / 59.1 lbs (without lens)
<b>Shipping Dimensions</b>	583 x 754 x 444 mm / 23.0" x 30.9" x 17.5"
<b>Shipping weight</b>	38.5 kg / 81.6 lbs
<b>Standard accessories</b>	Power cord, wireless/XLR wired rugged remote control
<b>Certifications</b>	Compliant with UL60950-1 and EN60950-1 complies with FCC rules & regulations, part 15 Class A and CE EN55022 Class A, RoHS
<b>Warranty</b>	3 years*
<b>Notes</b>	*except on light source: 20.000 hrs in normal mode or 3 years ** SW upgradable. Please contact an authorized Barco representative for details.

## A.7 Dimensions of a F80

### Overview

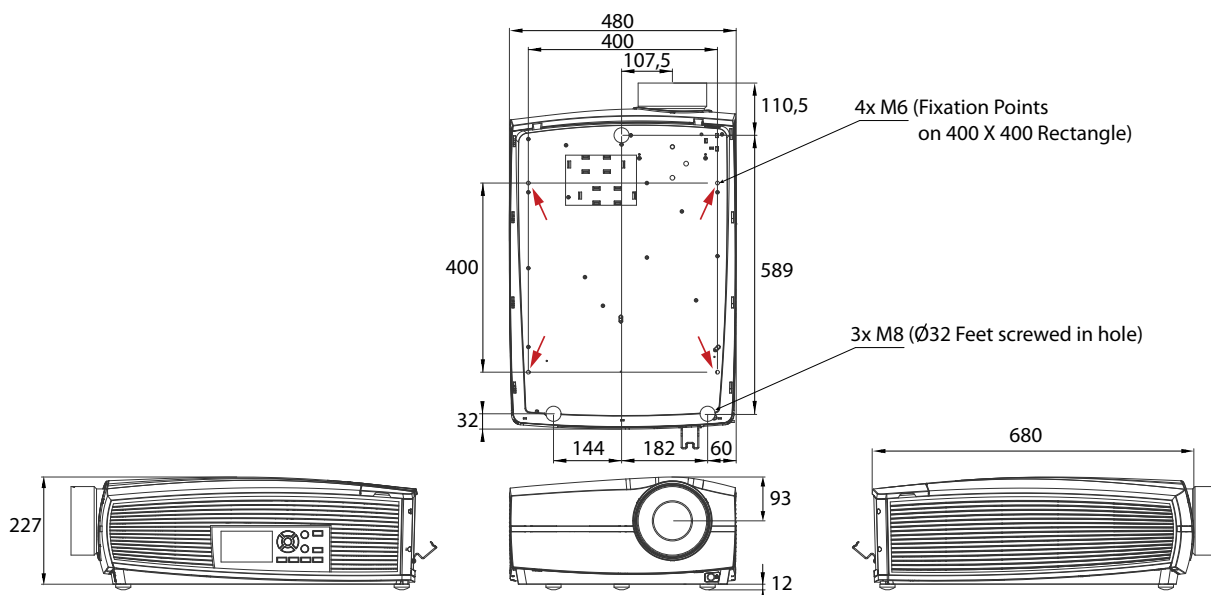

Image A-1 Dimensions, in mm



**CAUTION:** Take care to not exceed the maximum recommended tightening torque on the fixing screws. Use a torque of 4 Nm for the M8 screws and the M6 screws.

## Fixation points

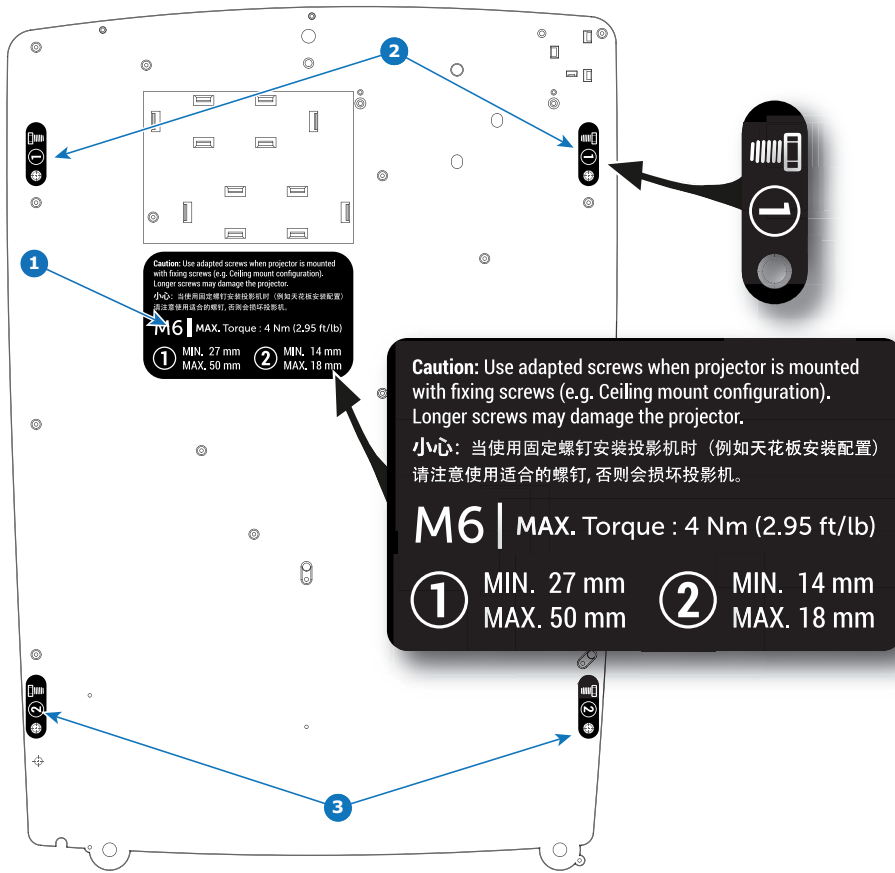

Image A-2

**CAUTION:** Take care to use adapted screws when the projector is mounted with fixing screws (e.g. ceiling mount configuration). Follow the exact mounting instructions as explained on underside the projector. Longer screws may damage internal parts of the projector.

## A.8 Technical Regulations

### Certificates



# Environmental information

# B

B.1	Disposal information .....	158
B.2	China RoHS compliance .....	158
B.3	Taiwan RoHS compliance.....	160
B.4	Turkey RoHS compliance.....	161
B.5	Production address.....	161
B.6	Contact information.....	161
B.7	Product Info (Taiwan).....	162
B.8	Download Product Manual .....	162

## B.1 Disposal information

### Disposal Information

Waste Electrical and Electronic Equipment



This symbol on the product indicates that, under the European Directive 2012/19/EU governing waste from electrical and electronic equipment, this product must not be disposed of with other municipal waste. Please dispose of your waste equipment by handing it over to a designated collection point for the recycling of waste electrical and electronic equipment. To prevent possible harm to the environment or human health from uncontrolled waste disposal, please separate these items from other types of waste and recycle them responsibly to promote the sustainable reuse of material resources.

For more information about recycling of this product, please contact your local city office or your municipal waste disposal service.

For details, please visit the Barco website at: <http://www.barco.com/AboutBarco/weee>

### Disposal of batteries in the product



This product contains batteries covered by the Directive 2006/66/EC which must be collected and disposed of separately from municipal waste.

If the battery contains more than the specified values of lead (Pb), mercury (Hg) or cadmium (Cd), these chemical symbols will appear below the crossed-out wheeled bin symbol.

By participating in separate collection of batteries, you will help to ensure proper disposal and to prevent potential negative effects on the environment and human health.

## B.2 China RoHS compliance

### 中国大陆 RoHS (Information for China ROHS compliance)

根据中国大陆《电器电子产品有害物质限制使用管理办法》（也称为中国大陆RoHS），以下部分列出了Barco产品中可能包含的有毒和/或有害物质的名称和含量。中国大陆RoHS指令包含在中国信息产业部MCV标准：“电子信息产品中有毒物质的限量要求”中。

According to the “Management Methods for the Restriction of the Use of Hazardous Substances in Electrical and Electronic Products” (Also called RoHS of Chinese Mainland), the table below lists the names and contents of toxic and/or hazardous substances that Barco’s product may contain. The RoHS of Chinese Mainland is included in the MCV standard of the Ministry of Information Industry of China, in the section “Limit Requirements of toxic substances in Electronic Information Products”.

零件项目(名称) Component name	有毒有害物质或元素 Hazardous substances and elements					
	铅 (Pb)	汞 (Hg)	镉 (Cd)	六价铬 (Cr6+)	多溴联苯 (PBB)	多溴二苯 醚 (PBDE)
印制电路配件 Printed Circuit Assemblies	X	O	X	O	O	O
外接电(线)缆 External Cables	X	O	O	O	O	O
内部线路 Internal wiring	X	O	O	O	O	O
镜头支架	X	O	O	O	O	O

零件项目(名称) Component name	有毒有害物质或元素 Hazardous substances and elements					
	铅 (Pb)	汞 (Hg)	镉 (Cd)	六价铬 (Cr6+)	多溴联苯 (PBB)	多溴二苯 醚 (PBDE)
Lensholder						
螺帽,螺钉(栓),螺旋(钉),垫圈, 紧固件 Nuts, bolts, screws, washers, Fasteners	X	O	O	O	O	O
激光发生器 Laser	X	O	O	O	O	O
电源供应器 Power Supply Unit	X	O	O	O	O	O
风扇 Fan	X	O	O	O	O	O
附電池遙控器 Remote control	X	O	O	O	O	O
<p>本表格依据SJ/T 11364的规定编制 This table is prepared in accordance with the provisions of SJ/T 11364.</p> <p>O: 表示该有毒有害物质在该部件所有均质材料中的含量均在 GB/T 26572 标准规定的限量要求以下。 O: Indicates that this toxic or hazardous substance contained in all of the homogeneous materials for this part is below the limit requirement in GB/T 26572.</p> <p>X: 表示该有毒有害物质至少在该部件的某一均质材料中的含量超出 GB/T 26572 标准规定的限量要求。 X: Indicates that this toxic or hazardous substance contained in at least one of the homogeneous materials used for this part is above the limit requirement in GB/T 26572.</p>						



在中国大陆销售的相应电子信息产品 (EIP) 都必须遵照中国大陆《电子电气产品有害物质限制使用标识要求》标准贴上环保使用期限 (EFUP) 标签。Barco产品所采用的EFUP标签 (请参阅实例, 徽标内部的编号使用于指定产品) 基于中国大陆的《电子信息产品环保使用期限通则》标准。

All Electronic Information Products (EIP) that are sold within Chinese Mainland must comply with the "Marking for the restriction of the use of hazardous substances in electrical and electronic product" of Chinese Mainland, marked with the Environmental Friendly Use Period (EFUP) logo. The number inside the EFUP logo that Barco uses (please refer to the photo) is based on the "General guidelines of environment-friendly use period of electronic information products" of Chinese Mainland.

## B.3 Taiwan RoHS compliance

### 限用物質含有情況標示聲明書 (Declaration of the Presence Condition of the Restricted Substances Marking)

單元 Unit	限用物質及其化學符號 Restricted substances and its chemical symbols					
	鉛 Lead (Pb)	汞 Mercury (Hg)	鎘 Cadmium (Cd)	六價鉻 Hexavalent chromium (Cr6+)	多溴聯苯 Polybrominated biphenyls (PBB)	多溴二苯醚 Polybrominated diphenyl ethers (PBDE)
印製電路板配件 Printed Circuit Assemblies	—	○	—	○	○	○
外接電 (線) 纜 External Cables	—	○	○	○	○	○
內部線路 Internal wiring	—	○	○	○	○	○
鏡頭支架 Lensholder	—	○	○	○	○	○
螺絲組件 Nuts, bolts, screws, washers, Fasteners	—	○	○	○	○	○
雷射 Laser	—	○	○	○	○	○
電源供應器 Power Supply Unit	—	○	○	○	○	○
風扇 Fan	—	○	○	○	○	○
遙控器 Remote control	—	○	○	○	○	○
<p>備考1. “超出0.1 wt %” 及 “超出0.01 wt %” 係指限用物質之百分比含量超出百分比含量基準值。 Note 1 : “Exceeding 0.1 wt %” and “exceeding 0.01 wt %” indicate that the percentage content of the restricted substance exceeds the reference percentage value of presence condition.</p> <p>備考2. “○” 係指該項限用物質之百分比含量未超出百分比含量基準值。 Note 2 : “○” indicates that the percentage content of the restricted substance does not exceed the percentage of reference value of presence.</p> <p>備考3. “—” 係指該項限用物質為排除項目。 Note 3 : The “—” indicates that the restricted substance corresponds to the exemption.</p>						

備註: 此RoHS表格適用於以下產品型號: GP6,GP7,GP8,GPC

Hint: This RoHS table is suitable for following models: GP6,GP7,GP8,GPC



## B.4 Turkey RoHS compliance

### Turkey RoHS compliance



■ Türkiye Cumhuriyeti: AEEE Yönetmeliğine Uygundur.  
 [Republic of Turkey: In conformity with the WEEE Regulation]

## B.5 Production address

### Factories

**Barco NV (BELGIUM)**  
 President Kennedypark 35 , B-8500 Kortrijk

### Made in information

The made in country is indicated on the product ID label on the product itself.

### Production date

The month and year of production is indicated on the product ID label on the product itself.

## B.6 Contact information

### Barco contact information

**Registered office address:** President Kennedypark 35, 8500 Kortrijk, Belgium

**Contact address:** Beneluxpark 21, 8500 Kortrijk, Belgium

#### Contact address (for Taiwan) :

公司名稱 (Company Name) : 巴可股份有限公司

地址 (Address) : 新北市板橋區新站路16號33樓

傳真 (Fax) : 02-7715 0298

電話 (Tel) : 02-7715 0299

E-mail: [service.taiwan@barco.com](mailto:service.taiwan@barco.com)

### Importers contact information

To find your local importer, contact Barco directly or one of Barco's regional offices via the contact information given on Barco's web site, [www.barco.com](http://www.barco.com).

### Contact information Norway

Barco Fredrikstad as

Habornveien 53, N1630 Gamle Fredrikstad, Norway

Phone: +476930 4550

**Support:** [Support.fre@barco.com](mailto:Support.fre@barco.com)

## B.7 Product Info (Taiwan)

### Product info



product name 產品名稱:

projector 投影機

model 型號: GPC

## B.8 Download Product Manual

### Download Product Manual

Product manuals and documentation are available online at [www.barco.com/td](http://www.barco.com/td).

Registration may be required; follow the instructions given on the website.

**IMPORTANT!** Read Installation Instructions before connecting equipment to the mains power supply.

# Overview video timings for video interfaces

# C

C.1	Overview video timings .....	164
C.2	Overview video timings SDI Inputs .....	165
C.3	Overview video timings HDMI 2.0 inputs .....	166
C.4	Overview video timings DisplayPort 1.2 inputs .....	167
C.5	Overview video timings HDBaseT input .....	169
C.6	Overview video timings DVI Inputs .....	170

## About resolution in this chapter

Resolutions and video timings indicated in the following sections are resolutions accepted in input of the projector, but the output stays limited to the maximum resolution indicated in the specifications of the device.

## C.1 Overview video timings

### List of compatible signals

The following table specifies the video signals that the projector can project. Barco Events projectors supports the signal with “X” in the Compatible signals column.

**Note:** Support for refresh rates 24.00, 30.00, 60.00 Hz automatically includes support of 1/1.001 x those refresh rates.

Resolution	Vertical refresh rate (Hz)	Compatible signal				
		HDMI 2.0 Input	12G SDI	DisplayPort 1.2 Inputs	HDBaseT Input	DVI Inputs
640 x 480	60	X	—	X	X	X
720 x 480	60	X	—	—	X	—
720 x 576	50	X	—	—	X	—
800 x 600	60	X	—	X	X	X
1024 x 768	60	X	—	X	X	X
1280 x 720	24	—	X	—	—	—
1280 x 720	25	—	X	—	—	—
1280 x 720	30	—	X	—	—	—
1280 x 720	50	X	X	X	X	X
1280 x 720	60	X	X	X	X	X
1280 x 800	60	X	—	X	X	X
1280 x 960	60	X	—	X	X	X
1280 x 1024	60	X	—	X	X	X
1400 x 1050	60	X	—	X	X	X
1600 x 1200	60	X	—	X	X	X
1600 x 1200	120	—	—	X	—	—
1920 x 1080	24	X	X	X	X	X
1920 x 1080	25	X	X	—	X	X
1920 x 1080	30	X	X	—	X	X
1920 x 1080	50	X	X	X	X	X
1920 x 1080	60	X	X	X	X	X
1920 x 1080	120	—	—	X	—	—
1920 x 1200	50	X	X	X	X	X
1920 x 1200	60	X	X	X	X	X
1920 x 1200	120	—	—	X	—	—
2048 x 1080	24	X	—	X	X	X
2048 x 1080	25	X	—	X	X	X
2048 x 1080	30	X	—	X	X	X
2048 x 1080	48	X	—	X	X	X
2048 x 1080	50	X	X	X	X	X

Resolution	Vertical refresh rate (Hz)	Compatible signal				
		HDMI 2.0 Input	12G SDI	DisplayPort 1.2 Inputs	HDBaseT Input	DVI Inputs
2048 x 1080	60	X	X	X	X	X
2048 x 1080	120	—	—	X	—	—
2560 x 1600	50	X	—	X	X	X
2560 x 1600	60	X	—	X	X	X
2560 x 1600	120	—	—	X	—	—
3840 x 2160	24	X	—	X	X	X
3840 x 2160	25	X	—	X	X	X
3840 x 2160	30	X	—	X	X	X
3840 x 2160	50	X	X	X	—	—
3840 x 2160	60	X	X	X	—	—
3840 x 2400	24	—	—	—	—	X
3840 x 2400	25	—	—	—	—	X
3840 x 2400	30	—	—	—	—	X
3840 x 2400	50	X	—	X	—	—
3840 x 2400	60	X	—	X	—	—
4096 x 2160	24	X	—	X	X	X
4096 x 2160	25	X	—	X	X	X
4096 x 2160	30	X	—	X	X	X
4096 x 2160	50	X	X	X	—	—
4096 x 2160	60	X	X	X	—	—

## C.2 Overview video timings SDI Inputs

### Overview

The following standard video formats are available for the projector.

Video timing (active pixels x active lines)	Vertical refresh rate (Hz) <sup>4</sup>	Type	Port Type
1280 x 720	24	HD-SDI	Single Link & Quad Link
1280 x 720	25	HD-SDI	Single Link & Quad Link
1280 x 720	30	HD-SDI	Single Link & Quad Link
1280 x 720	50	HD-SDI	Single Link & Quad Link
1280 x 720	60	HD-SDI	Single Link & Quad Link
1920 x 1080	24	HD-SDI	Single Link & Quad Link
1920 x 1080	25	HD-SDI	Single Link & Quad Link

4. Support for refresh rates 24.00, 30.00 and 60.00 Hz automatically includes support of 1/1.001 x those refresh rates.

Video timing (active pixels x active lines)	Vertical refresh rate (Hz) <sup>5</sup>	Type	Port Type
1920 x 1080	30	HD-SDI	Single Link & Quad Link
1920 x 1080	50	3G-SDI	Single Link & Quad Link
1920 x 1080	60	3G-SDI	Single Link & Quad Link
1920 x 1200	50	3G-SDI "BarcoLink"	Single Link & Quad Link
1920 x 1200	59.94	3G-SDI "BarcoLink"	Single Link & Quad Link
1920 x 1200	60	3G-SDI "BarcoLink"	Single Link & Quad Link
2048 x 1080	50	3G-SDI	Single Link & Quad Link
2048 x 1080	60	3G-SDI	Single Link & Quad Link
3840 x 2160	50	12G-SDI <sup>6</sup>	Single Link
3840 x 2160	60	12G-SDI <sup>6</sup>	Single Link
3840 x 2400	50		Single Link
3840 x 2400	59.94		Single Link
3840 x 2400	60		Single Link
4096 x 2160	50	12G-SDI <sup>6</sup>	Single Link
4096 x 2160	60	12G-SDI <sup>6</sup>	Single Link

## C.3 Overview video timings HDMI 2.0 inputs

### Overview

The following standard video formats are available for the projector.

**Note:** support for refresh rates 24.00, 30.00, 60.00 Hz automatically includes support of 1/1.001 x those refresh rates

Video timing (active pixels x active lines)	Vertical refresh rate (Hz)	3D support?
640 x 480	60	
720 x 480	60	
720 x 576	50	
800 x 600	60	
1024 x 768	60	
1280 x 720	50	Frame packing Top – bottom
1280 x 720	60	Frame packing Top – bottom
1280 x 800	60	

5. Support for refresh rates 24.00, 30.00 and 60.00 Hz automatically includes support of 1/1.001 x those refresh rates.

6. 12G SDI board only, and only on Channel A

<b>Video timing (active pixels x active lines)</b>	<b>Vertical refresh rate (Hz)</b>	<b>3D support?</b>
1280 x 960	60	
1280 x 1024	60	
1400 x 1050	60	
1600 x 1200	60	
1920 x 1080	24	Frame packing Top – bottom
1920 x 1080	25	
1920 x 1080	30	
1920 x 1080	50	Side by Side (SbS) progressive
1920 x 1080	60	Side by Side (SbS) progressive
1920 x 1200	50	
1920 x 1200	60	
2048 x 1080	24	
2048 x 1080	25	
2048 x 1080	30	
2048 x 1080	48	
2048 x 1080	50	
2048 x 1080	60	
2560 x 1600	50	
2560 x 1600	60	
3840 x 2160	24	
3840 x 2160	25	
3840 x 2160	30	
3840 x 2160	50	
3840 x 2160	60	
3840 x 2400	50	
3840 x 2400	60	
4096 x 2160	24	
4096 x 2160	25	
4096 x 2160	30	
4096 x 2160	50	
4096 x 2160	60	

## C.4 Overview video timings DisplayPort 1.2 inputs

### Overview

The following standard video formats are available for the projector.

**Note:** support for refresh rates 24.00, 30.00, 60.00 Hz automatically includes support of 1/1.001 x those refresh rates

<b>Video timing (active pixels x active lines)</b>	<b>Vertical refresh rate (Hz)</b>	<b>Available layout modes, other than standard layout (1 x 1 layout)</b>	<b>Support for 3D?</b>
640 x 480	60		
800 x 600	60		
1024x 768	60		
1280 x720	50		
1280 x 720	60		
1280 x 800	60		
1280 x 960	60		
1280 x1024	60		
1280 x 1600	60	2 Column mode (2 x 1 layout)	
1280 x 1600	120	2 Column mode (2 x 1 layout)	Active 3D
1400 x 1050	60		
1600 x 1200	60		
1600 x 1200	120		Active 3D
1920 x 1080	50		
1920 x 1080	60		
1920 x 1080	120		Active 3D
1920 x 1200	50		
1920 x 1200	60		
1920 x 1200	120		Active 3D
1920 x 2160	60	2 Column mode (2 x 1 layout)	
1920 x 2160	120	2 Column mode (2 x 1 layout)	Active 3D
1920 x 2400	60	2 Column mode (2 x 1 layout)	
1920 x 2400	120		Active 3D
2048 x 1080	24		
2048 x 1080	25		
2048 x 1080	30		
2048 x 1080	48		
2048 x 1080	50		
2048 x 1080	60		
2048 x 2160	60	2 Column mode (2 x 1 layout)	



Video timing (active pixels x active lines)	Vertical refresh rate (Hz)	Available layout modes, other than standard layout (1 x 1 layout)	Support for 3D?
2048 x 2160	120	2 Column mode (2 x 1 layout)	Active 3D
2560 x 1080	120		Active 3D
2560 x 1440	120		Active 3D
2560 x 1600	50		
2560 x 1600	60		
2560 x 1600	120		
3840 x 2160	24		
3840 x 2160	25		
3840 x 2160	30		
3840 x 2160	50		
3840 x 2160	60		
3840 x 2400	50		
3840 x 2400	60		
4096 x 2160	24		
4096 x 2160	25		
4096 x 2160	30		
4096 x 2160	50		
4096 x 2160	60		

## C.5 Overview video timings HDBaseT input

### Overview

The following standard video formats are available for the projector.

**Note:** support for refresh rates 24.00, 30.00, 60.00 Hz automatically includes support of 1/1.001 x those refresh rates.

Video timing (active pixels x active lines)	Vertical refresh rate (Hz)	3D Support
640 x 480	60	
720 x 480	60	
720 x 576	50	
800 x 600	60	
1024 x 768	60	
1280 x 720	50	Frame Packing. Top – Bottom
1280 x 720	60	Frame Packing. Top – Bottom
1280 x 800	60	
1280 x 960	60	

<b>Video timing (active pixels x active lines)</b>	<b>Vertical refresh rate (Hz)</b>	<b>3D Support</b>
1280 x 1024	60	
1400 x 1050	60	
1600 x 1200	60	
1920 x 1080	24	Frame Packing. Top – Bottom
1920 x 1080	25	
1920 x 1080	30	
1920 x 1080	50	Side by Side (SbS) progressive
1920 x 1080	60	Side by Side (SbS) progressive
1920 x 1200	50	
1920 x 1200	60	
1920 x 2160	50	
1920 x 2160	60	
2048 x 1080	24	
2048 x 1080	25	
2048 x 1080	30	
2048 x 1080	48	
2048 x 1080	50	
2048 x 1080	60	
2048 x 2160	50	
2048 x 2160	60	
2560 x 1600	50	
2560 x 1600	60	
3840 x 2160	24	
3840 x 2160	25	
3840 x 2160	30	
4096 x 2160	24	
4096 x 2160	25	
4096 x 2160	30	

## C.6 Overview video timings DVI Inputs

### Overview

The following standard video formats are available for the projector.

<b>Video timing (active pixels x active lines)</b>	<b>Vertical refresh rate (Hz)</b>	<b>Available layout modes, other than standard layout (1 x 1 layout)</b>
640 x 480	60	
800 x 600	60	
1024 x 768	60	
1280 x 720	50	
1280 x 720	60	
1280 x 800	60	
1280 x 960	60	
1280 x 1024	60	
1400 x 1050	60	
1600 x 1200	60	
1920 x 1080	24	
1920 x 1080	25	
1920 x 1080	30	
1920 x 1080	50	
1920 x 1080	60	
1920 x 1200	50	
1920 x 1200	60	
1920 x 2160	60	2 - column mode
1920 x 2400	60	2 - column mode
2048 x 1080	24	
2048 x 1080	25	
2048 x 1080	30	
2048 x 1080	48	
2048 x 1080	50	
2048 x 1080	60	
2048 x 2160	60	2 - column mode
2560 x 1600	50	
2560 x 1600	60	
3840 x 2160	24	
3840 x 2160	25	
3840 x 2160	30	
3840 x 2160	30	
3840 x 2400	24	
3840 x 2400	25	
3840 x 2400	30	
4096 x 2160	24	

<b>Video timing (active pixels x active lines)</b>	<b>Vertical refresh rate (Hz)</b>	<b>Available layout modes, other than standard layout (1 x 1 layout)</b>
4096 x 2160	25	
4096 x 2160	30	

**DMX chart**

**D**

## D.1 DMX chart, Basic

### Overview

Channel	Function	Value	Default	Action
1	Shutter + Intensity	0 - 7	255	Close shutter
		8 - 255		Adjust intensity
2	Function select	0 - 7	0	No function
		8 - 15		Activate default macro (full screen) (If held for 1 second)
		16 - 23		Activate macro 2 (If held for 1 second) <sup>7</sup>
		24 - 31		Activate macro 3 (If held for 1 second) <sup>7</sup>
		32 - 39		Activate macro 4 (If held for 1 second) <sup>7</sup>
		40 - 47		Activate macro 5 (If held for 1 second) <sup>7</sup>
		48 - 55		Activate macro 6 (If held for 1 second) <sup>7</sup>
		56 - 63		Activate macro 7 (If held for 1 second) <sup>7</sup>
		64 - 71		Activate macro 8 (If held for 1 second) <sup>7</sup>
		72 - 79		Activate macro 9 (If held for 1 second) <sup>7</sup>
		80 - 87		Activate macro 10 (If held for 1 second) <sup>7</sup>
		88 - 95		Select input 1: HDMI Input (If held for 1 second)
		96 - 103		Select input 2: DisplayPort Input (If held for 1 second)
		104 - 111		Select input 3: SDI Input A (If held for 1 second)
		112 - 119		Select input 4: SDI Input B (If held for 1 second)
		120 - 127		Select input 5: HDBaseT Input 1 (if held for 1 second)
		128 - 135		Select input 6: Dual DisplayPort input (if held for 1 second)
		136 - 143		Select input 7: DVI (if held for 1 second)
		144 - 151		Select input 8: Dual DVI (if held for 1 second)
		152 - 159		Reserved for future functionality
160 - 167	Reserved for future functionality			
168 - 175	Reserved for future functionality			
176 - 183	Reserved for future functionality			
184 - 207	Reserved for future functionality			
208 - 215	Power on / Light source on (If held for 5 seconds)			
216 - 223	Power down / Light source off (if held for 5 seconds)			
224 - 255	Reserved for future functionality			

## D.2 DMX chart, Extended

### Overview

Channel	Function	Value	Default	Actions
1	Shutter + Intensity	0 - 7	255	Close shutter
		8 - 255		Adjust intensity
2	Brightness	0 - 255	128	Adjusts the brightness between 0 and 100% on input.
3	Contrast	0 - 255	128	Adjusts the contrast between 0 and 100% on input
4	Input selection	0 - 7	0	No function

7. Will be available in a future release.

Channel	Function	Value	Default	Actions
		8 - 15		Activate default macro (full screen) (If held for 1 second)
		16 - 23		Activate macro 2 (If held for 1 second) <sup>8</sup>
		24 - 31		Activate macro 3 (If held for 1 second) <sup>8</sup>
		32 - 39		Activate macro 4 (If held for 1 second) <sup>8</sup>
		40 - 47		Activate macro 5 (If held for 1 second) <sup>8</sup>
		48 - 55		Activate macro 6 (If held for 1 second) <sup>8</sup>
		56 - 63		Activate macro 7 (If held for 1 second) <sup>8</sup>
		64 - 71		Activate macro 8 (If held for 1 second) <sup>8</sup>
		72 - 79		Activate macro 9 (If held for 1 second) <sup>8</sup>
		80 - 87		Activate macro 10 (If held for 1 second) <sup>8</sup>
		88 - 95		Select input 1: HDMI Input (If held for 1 second)
		96 - 103		Select input 2: DisplayPort Input (If held for 1 second)
		104 - 111		Select input 3: SDI Input A (If held for 1 second)
		112 - 119		Select input 4: SDI Input B (If held for 1 second)
		120 - 127		Select input 5: HDBaseT Input 1 (if held for 1 second)
		128 - 135		Select input 6: Dual DisplayPort input (if held for 1 second)
		136 - 143		Select input 7: DVI (if held for 1 second)
		144 - 151		Select input 8: Dual DVI (if held for 1 second)
		152 - 159		Reserved for future functionality
		160 - 167		Reserved for future functionality
		168 - 175		Reserved for future functionality
		176 - 183		Reserved for future functionality
		184 - 255		Reserved for future functionality
5	Focus (MSB)	0 - 255	128	Set coarse lens focus adjustment <sup>9</sup>
6	Focus (LSB)	0 - 255	128	Set fine lens focus adjustment <sup>9</sup>
7	Zoom (MSB)	0 - 255	128	Set coarse lens zoom adjustment <sup>9</sup>
8	Zoom (LSB)	0 - 255	128	Set fine lens zoom adjustment <sup>9</sup>
9	Lens shift vertical (MSB)	0 - 255	128	Set coarse lens shift in vertical direction
10	Lens shift vertical (LSB)	0 - 255	128	Set fine lens shift in vertical direction
11	Lens shift horizontal (MSB)	0 - 255	128	Set coarse lens shift in horizontal direction
12	Lens shift horizontal (LSB)	0 - 255	128	Set fine lens shift in horizontal direction
13	Light Source Power <sup>10</sup>	0 - 3	0	Set light source to 100%
		4 - 7		Set light source to 95%
		8 - 11		Set light source to 90%
		12 - 15		Set light source to 85%

8. Will be available in a future release.

9. Only when lens has been calibrated

10. If the Light Source is forced to a output below its minimum value, it will remain at its minimum output value

Channel	Function	Value	Default	Actions
		16 - 20		Set light source to 80%
		21 - 23		Set light source to 75%
		24 - 27		Set light source to 70%
		28 - 31		Set light source to 65%
		32 - 35		Set light source to 60%
		36 - 39		Set light source to 55%
		40 - 43		Set light source to 50%
		44 - 47		Set light source to 45%
		48 - 51		Set light source to 40%
		52 - 55		Set light source to 35%
		56 - 59		Set light source to 30%
		60 - 63		Set light source to 25%
		64 - 67		Set light source to 20%
		68 - 71		Set light source to 15%
		72 - 75		Set light source to 10%
		76 - 79		Reserved for future functionality
		80 - 87		Power on / Light source on (If held for 5 seconds)
		88 - 95		Power down / Light source off (if held for 5 seconds)
96 - 255	Reserved for future functionality			
14	Various	0 - 7	0	Reserved for future functionality
		8 - 15		Calibrate lens zoom & focus (if held for 5 seconds)
		16 - 23		Calibrate lens horizontal and vertical shift (if held for 5 seconds)
		24 - 31		Calibrate lens (zoom, focus and shift)
		32 - 255		Reserved for future functionality





