

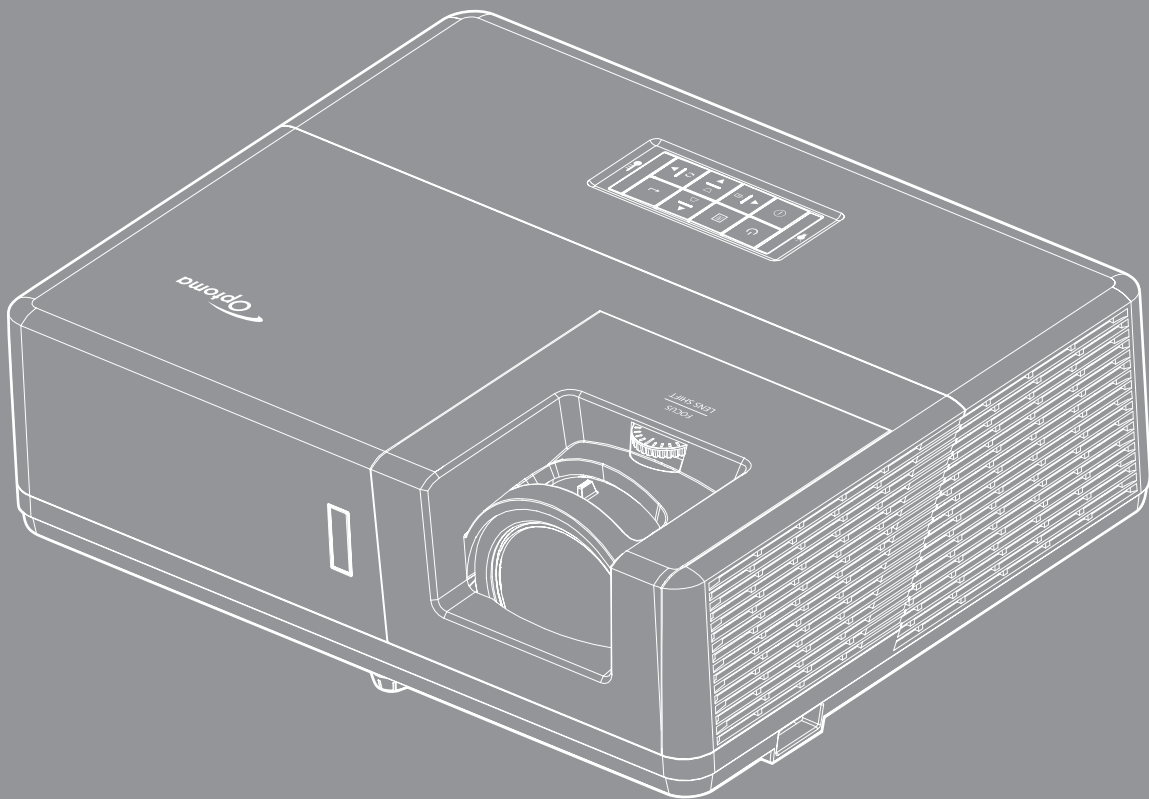

DLP® Projector



User manual



TABLE OF CONTENTS

SAFETY	4
<i>Important Safety Instruction.....</i>	<i>4</i>
<i>Laser Radiation Safety Information</i>	<i>5</i>
<i>Copyright</i>	<i>6</i>
<i>Disclaimer.....</i>	<i>6</i>
<i>Trademark Recognition</i>	<i>6</i>
<i>FCC</i>	<i>6</i>
<i>Declaration of Conformity for EU countries</i>	<i>7</i>
<i>WEEE</i>	<i>7</i>
INTRODUCTION	8
<i>Package Overview.....</i>	<i>8</i>
<i>Standard accessories</i>	<i>8</i>
<i>Optional accessories</i>	<i>8</i>
<i>Product Overview</i>	<i>9</i>
<i>Connections.....</i>	<i>10</i>
<i>Keypad</i>	<i>11</i>
<i>Remote control.....</i>	<i>12</i>
SETUP AND INSTALLATION	13
<i>Installing the projector</i>	<i>13</i>
<i>Connecting sources to the projector.....</i>	<i>16</i>
<i>Adjusting the projector image</i>	<i>17</i>
<i>Remote setup</i>	<i>18</i>
USING THE PROJECTOR.....	20
<i>Powering on / off the projector.....</i>	<i>20</i>
<i>Selecting an input source</i>	<i>21</i>
<i>Menu navigation and features</i>	<i>22</i>
<i>OSD Menu tree.....</i>	<i>23</i>
<i>Display image settings menu.....</i>	<i>32</i>
<i>Display 3D menu</i>	<i>35</i>
<i>Display aspect ratio menu</i>	<i>36</i>
<i>Display edge mask menu</i>	<i>39</i>
<i>Display zoom menu</i>	<i>39</i>
<i>Display image shift menu</i>	<i>39</i>
<i>Display geometric correction menu</i>	<i>39</i>
<i>Audio mute menu</i>	<i>40</i>
<i>Audio volume menu.....</i>	<i>40</i>
<i>Audio audio input menu.....</i>	<i>40</i>
<i>Audio audio / mic input function menu.....</i>	<i>40</i>
<i>Setup projection menu.....</i>	<i>41</i>
<i>Setup screen type menu.....</i>	<i>41</i>

<i>Setup power settings menu</i>	41
<i>Setup security menu</i>	42
<i>Setup HDMI link settings menu</i>	42
<i>Setup test pattern menu</i>	42
<i>Setup remote settings menu</i>	43
<i>Setup projector ID menu</i>	43
<i>Setup 12V trigger menu</i>	43
<i>Setup HDBaseT control menu</i>	43
<i>Setup options menu</i>	44
<i>Setup reset OSD menu</i>	45
<i>Network LAN menu</i>	45
<i>Network control menu</i>	46
<i>Setup network control settings menu</i>	47
<i>Info menu</i>	52
MAINTENANCE	53
<i>Installing and cleaning the dust filter</i>	53
ADDITIONAL INFORMATION	54
<i>Compatible resolutions</i>	54
<i>Image size and projection distance</i>	57
<i>Projector dimensions and ceiling mount installation</i>	59
<i>IR remote codes</i>	60
<i>Troubleshooting</i>	62
<i>Warning indicators</i>	64
<i>Specifications</i>	65
<i>Optoma global offices</i>	66

SAFETY

	The lightning flash with arrow head within an equilateral triangle is intended to alert the user to the presence of uninsulated "dangerous voltage" within the product's enclosure that may be of sufficient magnitude to constitute a risk of electric shock to persons.
	The exclamation point within an equilateral triangle is intended to alert the user to the presence of important operating and maintenance (servicing) instructions in the literature accompanying the appliance.

Please follow all warnings, precautions and maintenance as recommended in this user's guide.

Important Safety Instruction

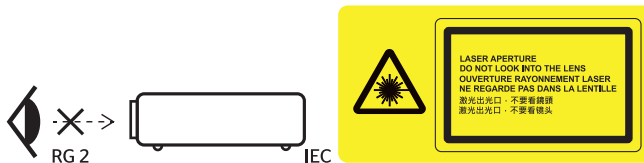

- Do not stare into the beam, RG2.
As with any bright source, do not stare into the direct beam, RG2 IEC 62471-5:2015.
- Do not block any ventilation openings. To ensure reliable operation of the projector and to protect from over heating, it is recommended to install the projector in a location that does not block ventilation. As an example, do not place the projector on a crowded coffee table, sofa, bed, etc. Do not put the projector in an enclosure such as a book case or a cabinet that restricts air flow.
- To reduce the risk of fire and/or electric shock, do not expose the projector to rain or moisture. Do not install near heat sources such as radiators, heaters, stoves or any other apparatus such as amplifiers that emits heat.
- Do not let objects or liquids enter the projector. They may touch dangerous voltage points and short out parts that could result in fire or electric shock.
- Do not use under the following conditions:
 - In extremely hot, cold or humid environments.
 - (i) Ensure that the ambient room temperature is within 5°C ~ 40°C
 - (ii) Relative humidity is 10% ~ 85%
 - In areas susceptible to excessive dust and dirt.
 - Near any appliance generating a strong magnetic field.
 - In direct sunlight.
- Do not use the unit if it has been physically damaged or abused. Physical damage/abuse would be (but not limited to):
 - Unit has been dropped.
 - Power supply cord or plug has been damaged.
 - Liquid has been spilled on to the projector.
 - Projector has been exposed to rain or moisture.
 - Something has fallen in the projector or something is loose inside.
- Do not place the projector on an unstable surface. The projector may fall over resulting in injury or the projector may become damaged.
- Do not block the light coming out of the projector lens when in operation. The light will heat the object and may melt, cause burns or start a fire.
- Please do not open or disassemble the projector as this may cause electric shock.
- Do not attempt to service the unit yourself. Opening or removing covers may expose you to dangerous voltages or other hazards. Please call Optoma before you send the unit for repair.

- See projector enclosure for safety related markings.
- The unit should only be repaired by authorized service personnel.
- Only use attachments/accessories specified by the manufacturer.
- Do not look into straight into the projector lens during operation. The bright light may harm your eyes.
- This projector will detect the life of the light source itself.
- When switching the projector off, please ensure the cooling cycle has been completed before disconnecting power. Allow 90 seconds for the projector to cool down.
- Turn off and unplug the power plug from the AC outlet before cleaning the product.
- Use a soft dry cloth with mild detergent to clean the display housing. Do not use abrasive cleaners, waxes or solvents to clean the unit.
- Disconnect the power plug from AC outlet if the product is not being used for a long period of time.
- Do not setup the projector in places where it might be subjected to vibration or shock.
- Do not touch the lens with bare hands.
- Remove battery/batteries from remote control before storage. If the battery/batteries are left in the remote for long periods, they may leak.
- Do not use or store the projector in places where smoke from oil or cigarettes may be present, as it can adversely affect the quality of the projector performance.
- Please follow the correct projector orientation installation as non standard installation may affect the projector performance.
- Use a power strip and or surge protector. As power outages and brown-outs can KILL devices.

Laser Radiation Safety Information

- This product is classified as CLASS 1 LASER PRODUCT - RISK GROUP 2 of IEC60825-1 : 2014 and also complies with 21 CFR 1040.10 and 1040.11 as a Risk Group 2, LIP (Laser Illuminated Projector) as defined in IEC 62471:2006 except for deviations pursuant to Laser Notice No. 50, dated June 24, 2007.



COMPLIES WITH 21 CFR 1040.10 AND 1040.11 EXCEPT FOR DEVIATIONS PURSUANT TO LASER NOTICE No. 50, DATED JUNE 24, 2007, IEC/EN 60825-1:2007

<p>IEC/EN 60825-1:2007 LASER RADIATION AVOID DIRECT EYE EXPOSURE CLASS 3R LASER PRODUCT WAVE LENGTH: 450-460 nm / Max. PULSE ENERGY: 0.534mJ / PULSE DURATION: 0.98 ms IEC/EN 60825-1:2014 CLASS 1 LASER PRODUCT / RISK GROUP 2 Possibly hazardous optical radiation emitted from this product. Do not stare into the beam, May be harmful to the eyes.</p>	<p>IEC/EN 60825-1:2007 激光辐射。眼睛不要直视3R激光产品波长：450-460 nm/最大脉冲能量：0.534mJ/脉冲时间：0.98ms</p> <p>IEC/EN 60825-1:2014 1类激光产品/风险组2 该产品发出可能对身体有害的光学辐射。 不要直视激光束，可能会对眼睛造成危害。</p>	<p>IEC/EN 60825-1:2007 RAYONNEMENT LASER - ÉVITEZ TOUTE EXPOSITION DIRECTE DES YEUX - PRODUIT LASER DE CLASSE 3R LONGUEUR D'ONDES:450 - 460 nm/ Max. IMPULSION D'ÉNERGIE: 0.534mJ/ DURÉE D'IMPULSION: 0,98 ms IEC/EN 60825-1:2014 PRODUIT LASER DE CLASSE 1 / GROUPE A RISQUE 2 Risques possibles de rayonnements optiques émis par ce produit. Ne pas regarder dans le faisceau. Peut être dangereux pour les yeux.</p>	<p>눈이 3R 동급 레이저 제품 의 레이저 방사선에 직접 노출되지 않도록 하십시오. 파장: 450-460 nm/최대 펄스 에너지: 0.534 mJ/ 펄스 지속시간: 0.98 ms IEC/EN 60825-1:2014 1등급 레이저 제품/위험군 2등급 이 제품에서 유해한 광선이 방출될 수 있습니다. 광선을 똑바로 쳐다보지 마십시오. 그렇 경우 눈에 해를 줄 수 있습니다.</p> <p>レーザー照射目の直撃は眼を傷めるクラス3Rレーザー製品 波長:450～460nm/最大パルスエネルギー:0.534mJ/パルス期間:0.98ms IEC/EN 60825-1:2014 クラス1レーザー製品/リスクグループ2 本品から危険な光学的放射が放射される可能性があります。光線を目に入れないでください。目に有害となる可能性があります。</p>
---	--	---	---



Failure to comply with the following could result in death or serious injury.

- This projector has built-in Class 4 laser module. Disassembly or modification is very dangerous and should never be attempted.
- Any operation or adjustment not specifically instructed by the user's guide creates the risk of hazardous laser radiation exposure.
- Do not open or disassemble the projector as this may cause damage by the exposure of laser radiation.
- Do not stare into beam when the projector is on. The bright light may result in permanent eye damage.
- When turning on the projector, make sure no one within projection range is looking at the lens.
- Without following the control, adjustment or operation procedure may cause damage by the exposure of laser radiation.
- Adequate instructions for assembly, operation, and maintenance, including clear warnings concerning precautions to avoid possible exposure to laser.

Copyright

This publication, including all photographs, illustrations and software, is protected under international copyright laws, with all rights reserved. Neither this manual, nor any of the material contained herein, may be reproduced without written consent of the author.

© Copyright 2019

Disclaimer

The information in this document is subject to change without notice. The manufacturer makes no representations or warranties with respect to the contents hereof and specifically disclaims any implied warranties of merchantability or fitness for any particular purpose. The manufacturer reserves the right to revise this publication and to make changes from time to time in the content hereof without obligation of the manufacturer to notify any person of such revision or changes.

Trademark Recognition

Kensington is a U.S. registered trademark of ACCO Brand Corporation with issued registrations and pending applications in other countries throughout the world.

HDMI, the HDMI Logo, and High-Definition Multimedia Interface are trademarks or registered trademarks of HDMI Licensing LLC in the United States and other countries.

DLP®, DLP Link and the DLP logo are registered trademarks of Texas Instruments and BrilliantColor™ is a trademark of Texas Instruments.

MHL, Mobile High-Definition Link and the MHL Logo are trademarks or registered trademarks of MHL Licensing, LLC.

All other product names used in this manual are the properties of their respective owners and are Acknowledged.

FCC

This device has been tested and found to comply with the limits for a Class B digital device pursuant to Part 15 of the FCC rules. These limits are designed to provide reasonable protection against harmful interference in a residential installation. This device generates, uses and can radiate radio frequency energy and, if not installed and used in accordance with the instructions, may cause harmful interference to radio communications.

However, there is no guarantee that interference will not occur in a particular installation. If this device does cause harmful interference to radio or television reception, which can be determined by turning the device off and on is encouraged to try to correct the interference by one or more of the following measures:

- Reorient or relocate the receiving antenna.
- Increase the separation between the device and receiver.
- Connect the device into an outlet on a circuit different from that to which the receiver is connected.
- Consult the dealer or an experienced radio/television technician for help.

Notice: Shielded cables

All connections to other computing devices must be made using shielded cables to maintain compliance with FCC regulations.

Caution

Changes or modifications not expressly approved by the manufacturer could void the user's authority, which is granted by the Federal Communications Commission, to operate this projector.

Operation Conditions

This device complies with Part 15 of the FCC Rules. Operation is subject to the following two conditions:

1. This device may not cause harmful interference and
2. This device must accept any interference received, including interference that may cause undesired operation.

Notice: Canadian users

This Class B digital apparatus complies with Canadian ICES-003.

Remarque à l'intention des utilisateurs canadiens

Cet appareil numérique de la classe B est conforme à la norme NMB-003 du Canada.

Declaration of Conformity for EU countries

- EMC Directive 2014/30/EU (including amendments)
- Low Voltage Directive 2014/35/EU
- RED 2014/53/EU (if product has RF function)

WEEE



Disposal instructions

Do not throw this electronic device into the trash when discarding. To minimize pollution and ensure utmost protection of the global environment, please recycle it.

INTRODUCTION

Package Overview

Carefully unpack and verify that you have the items listed below under standard accessories. Some of the items under optional accessories may not be available depending on the model, specification and your region of purchase. Please check with your place of purchase. Some accessories may vary from region to region.

The warranty card is only supplied in some specific regions. Please consult your dealer for detailed information.

Standard accessories

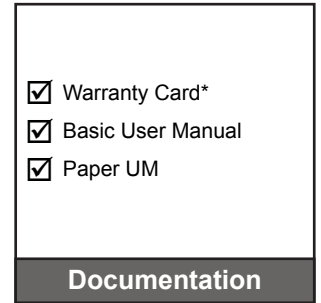
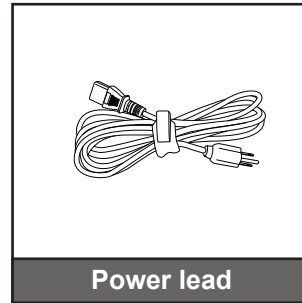
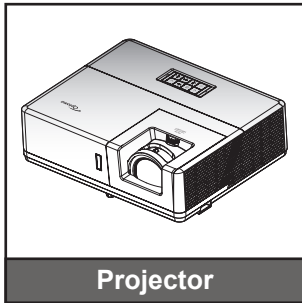

Note:

- *The remote control is shipped with the battery.*
- ** For European warranty Information, please visit www.optoma.com.*

Optional accessories

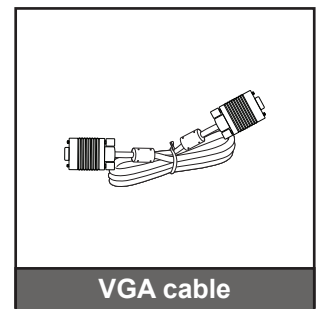
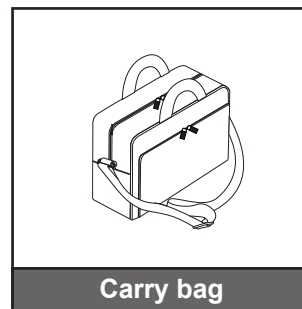
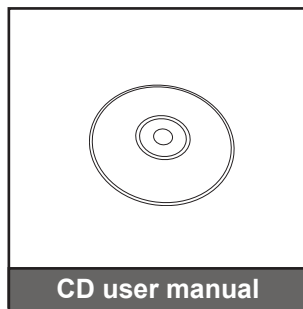
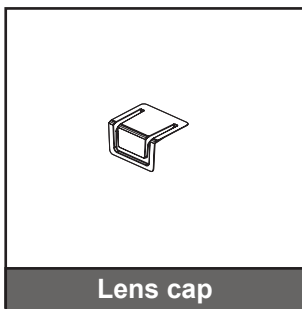

Note:

- *Optional accessories vary depending on model, specification and region.*

INTRODUCTION

Product Overview

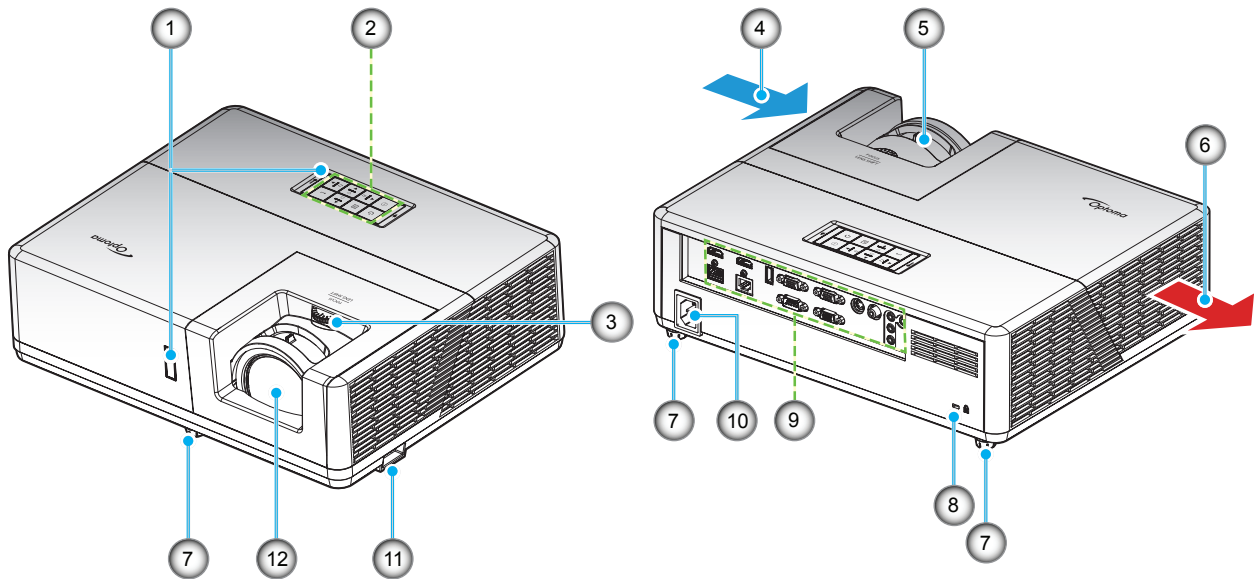

Note:

- Do not block projector intake and exhaust vents.
- When operating the projector in an enclosed space, allow at least 30 cm clearance around the intake and exhaust vents.

No	Item	No	Item
1.	IR Receivers	7.	Tilt-Adjustment Feet
2.	Keypad	8.	Kensington™ Lock Port
3.	Lens Shift Dial	9.	Input / Output
4.	Ventilation (inlet)	10.	Power Socket
5.	Focus Lever	11.	Security Bar
6.	Ventilation (outlet)	12.	Lens

INTRODUCTION

Connections

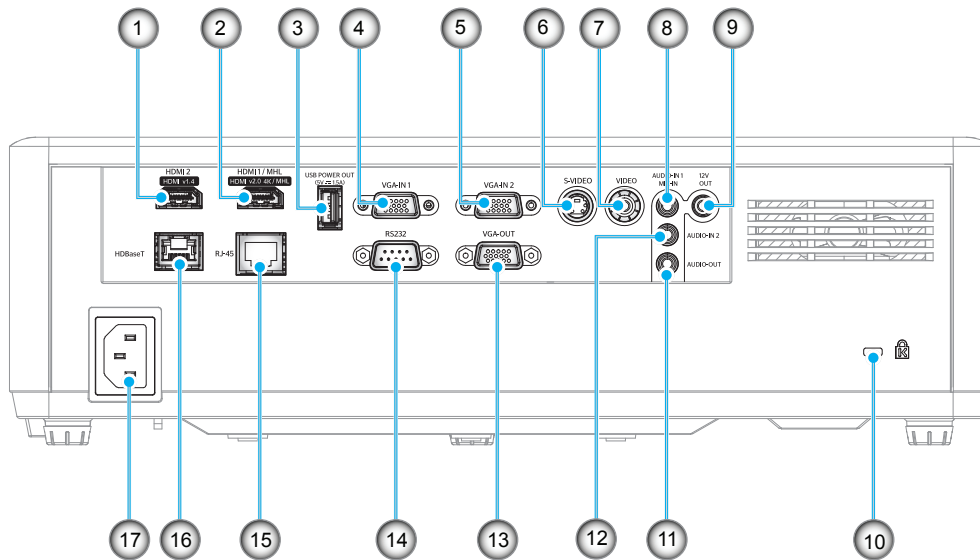

No	Item	No	Item
1.	HDMI 2 Connector	10.	Kensington™ Lock Port
2.	HDMI 1 / MHL Connector	11.	AUDIO-OUT Connector
3.	USB POWER OUT (5V---1.5A) Connector	12.	AUDIO-IN 2 Connector
4.	VGA-IN 1 Connector	13.	VGA-OUT Connector
5.	VGA-IN 2 Connector	14.	RS232
6.	S-VIDEO Connector	15.	RJ-45 Connector
7.	VIDEO Connector	16.	HDBaseT Connector
8.	AUDIO-IN 1 / MIC-IN Connector	17.	Power Socket
9.	12V OUT Connector		

INTRODUCTION

Keypad

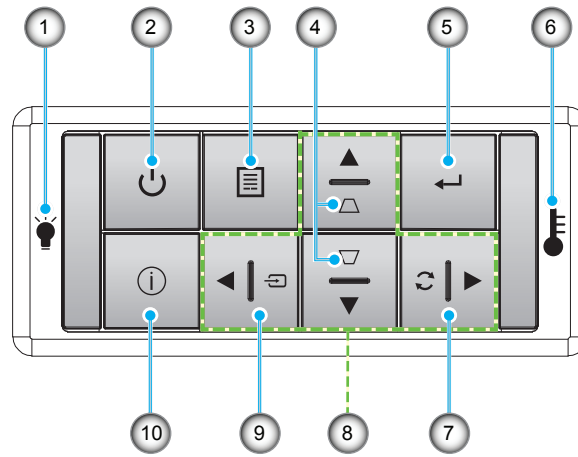

No	Item	No	Item
1.	Lamp LED	6.	Temp LED
2.	Power and Power LED	7.	Re-Sync
3.	Menu	8.	Four Directional Select Keys
4.	Keystone Correction	9.	Source
5.	Enter	10.	Information

INTRODUCTION

Remote control

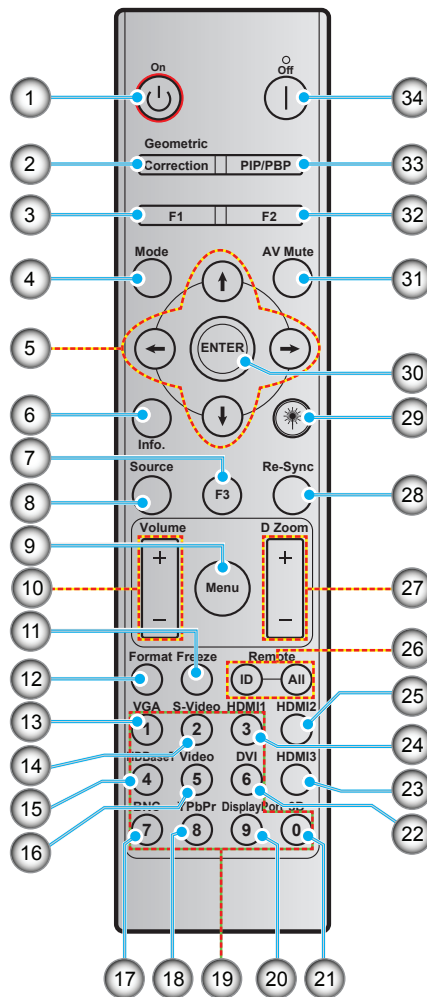

No	Item	No	Item
1.	Power on	18.	YPbPr (not supported)
2.	Geometric Correction	19.	Numeric keypad (0-9)
3.	Function button (F1) (Assignable)	20.	Display port (not supported)
4.	Mode	21.	3D
5.	Four directional select keys	22.	DVI (not supported)
6.	Information	23.	HDMI3 (not supported)
7.	Function button (F3) (Assignable)	24.	HDMI1
8.	Source	25.	HDMI2
9.	Menu	26.	Remote ID / Remote all
10.	Volume - / +	27.	Digital Zoom - / +
11.	Freeze	28.	Re-sync
12.	Format (Aspect Ratio)	29.	Laser (not supported)
13.	VGA	30.	Enter
14.	S-Video	31.	AV Mute
15.	HDBase-T	32.	Function button (F2) (Assignable)
16.	Video	33.	PIP/PBP (not supported)
17.	BNC (not supported)	34.	Power off

Note: Some keys may have no function for models that do not support these features.

SETUP AND INSTALLATION

Installing the projector

Your projector is designed to be installed in one of four possible positions.

Your room layout or personal preference will dictate which installation location you select. Take into consideration the size and position of your screen, the location of a suitable power outlet, as well as the location and distance between the projector and the rest of your equipment.

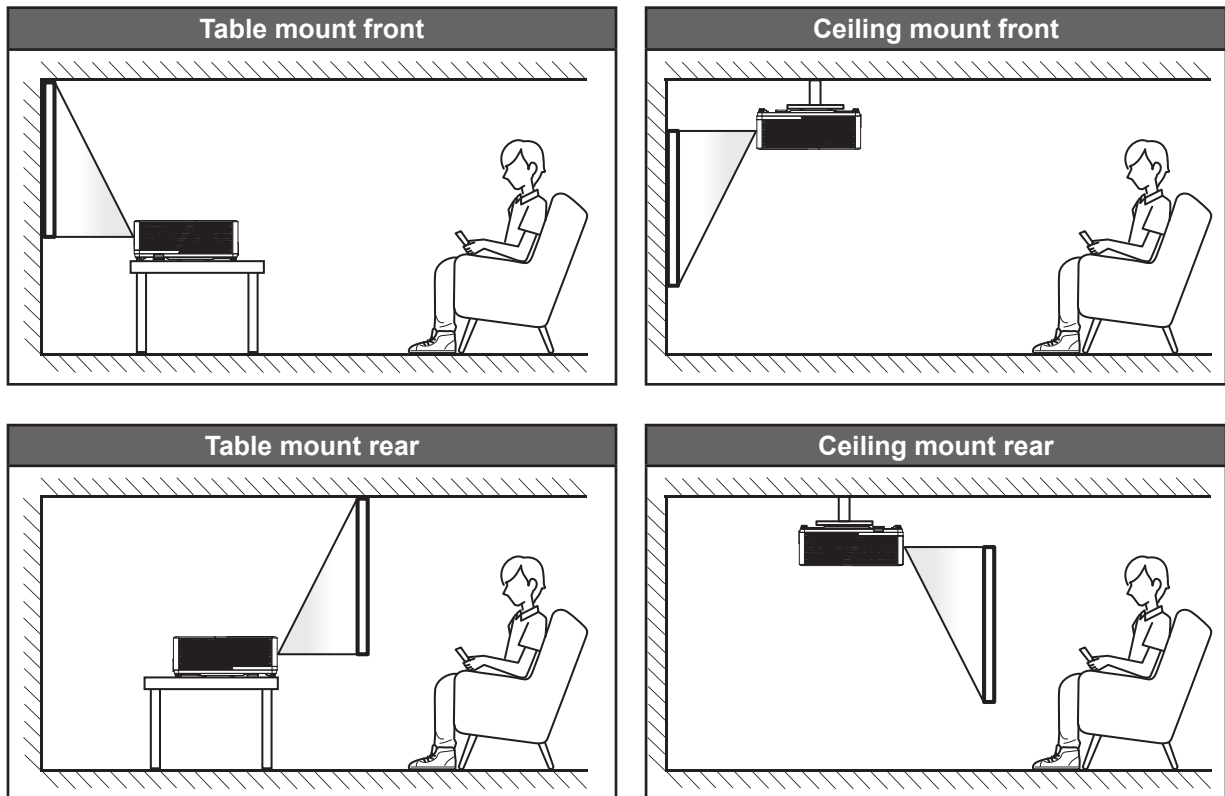

Projector should be placed flat on a surface and 90 degrees / perpendicular to the screen.

- How to determine projector location for a given screen size, please refer to distance table on pages 57-57.
- How to determine screen size for a given distance, please refer to distance table on pages 57-57.

Note: *The further away the projector is placed from the screen the projected image size increases and vertical offset also increases proportionally.*

IMPORTANT!

Do not operate the projector in any orientation other than table top or ceiling mount. The projector should be horizontal and not tilted either forwards/backwards or left/right. Any other orientation will invalidate the warranty and may shorten the lifetime of the projector light source or the projector itself. For none standard installation advise please contact Optoma.

SETUP AND INSTALLATION

Projector installation notice

Note: Projector power will dim to 60% and fan full load.

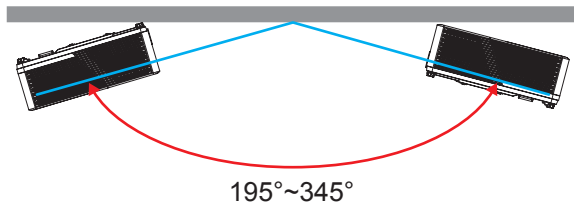

- Portrait mode

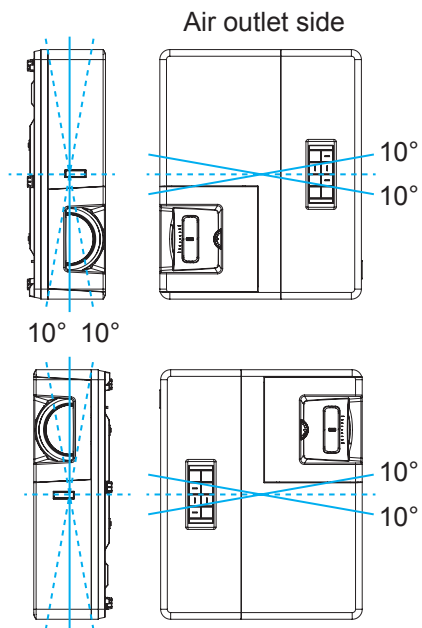

- Allow at least 30 cm clearance around the exhaust vent.

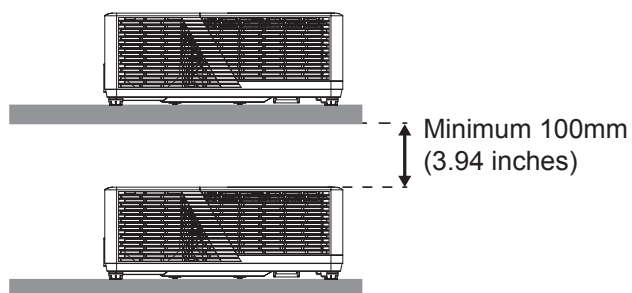
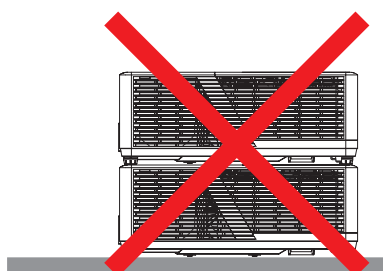
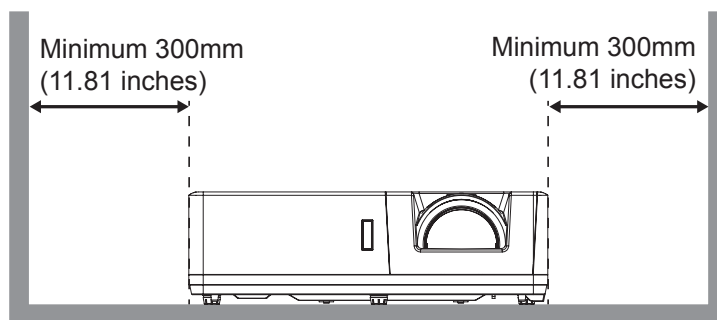
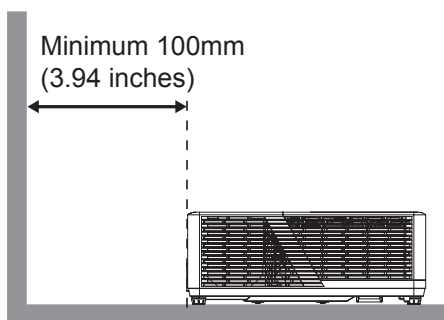

SETUP AND INSTALLATION

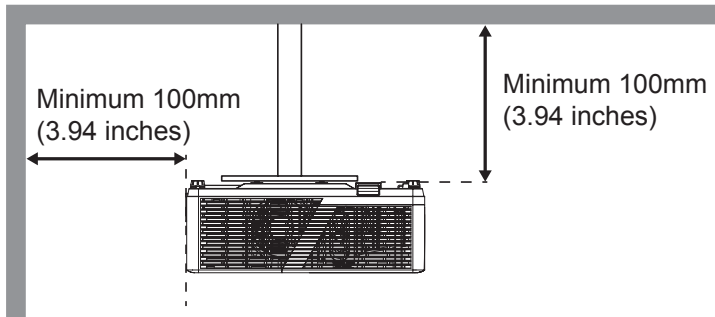

- Ensure that the intake vents do not recycle hot air from the exhaust vent.
- When operating the projector in an enclosed space, ensure that the surrounding air temperature within the enclosure does not exceed operation temperature while the projector is running, and the air intake and exhaust vents are unobstructed.
- All enclosures should pass a certified thermal evaluation to ensure that the projector does not recycle exhaust air, as this may cause the device to shutdown even if the enclosure temperature is within the acceptable operation temperature range.

SETUP AND INSTALLATION

Connecting sources to the projector

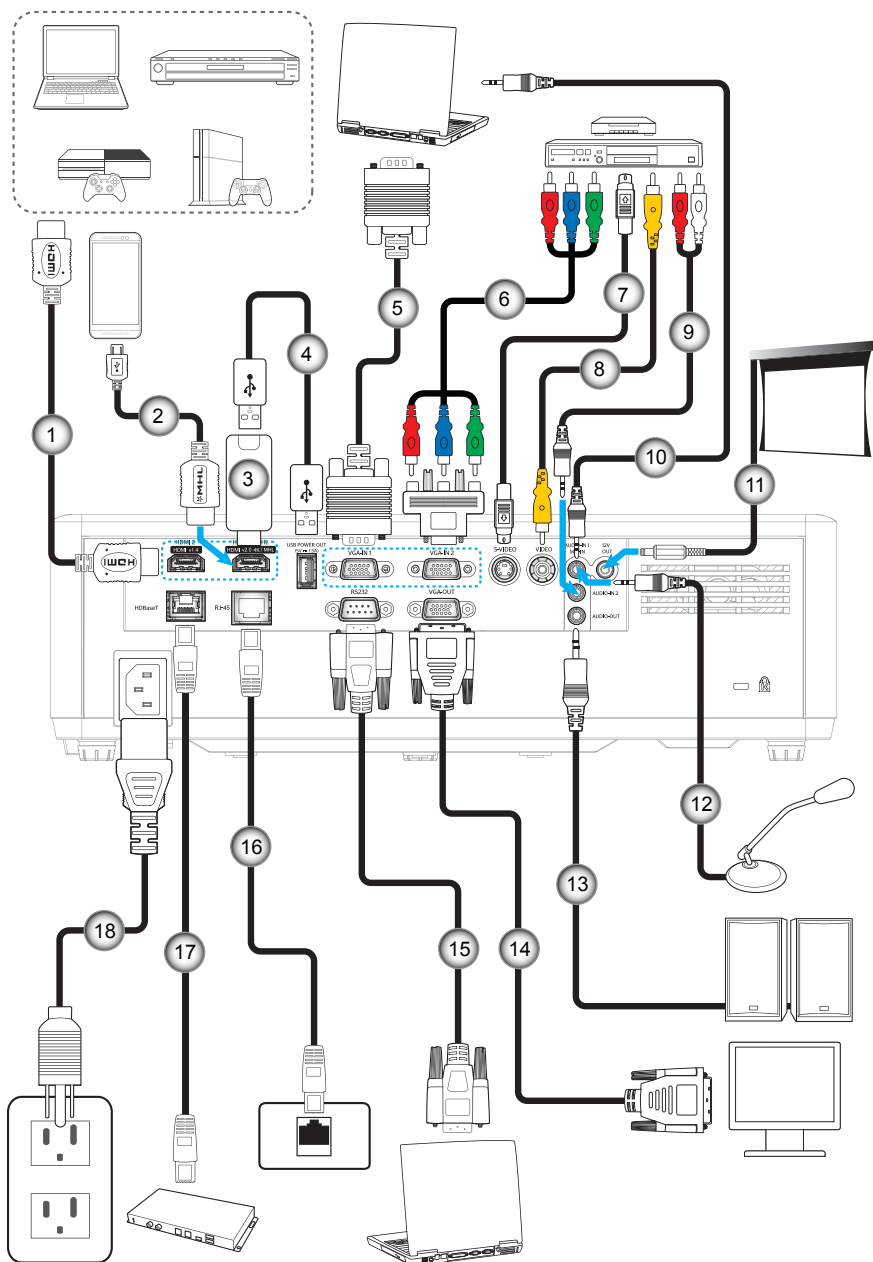

No	Item	No	Item
1.	HDMI Cable	10.	Audio In Cable
2.	MHL Cable	11.	12V DC Jack
3.	HDMI Dongle	12.	Microphone Cable
4.	USB Power Cable	13.	Audio Out Cable
5.	VGA In Cable	14.	VGA Out Cable
6.	RCA Component Cable	15.	RS232 Cable
7.	S-Video Cable	16.	RJ-45 Cable
8.	Video Cable	17.	RJ-45 Cable (Cat5 Cable)
9.	Audio In Cable	18.	Power Cord

SETUP AND INSTALLATION

Adjusting the projector image

Image height

The projector is equipped with elevator feet for adjusting the image height.

1. Locate the adjustable foot you wish to adjust on the underside of the projector.
2. Rotate the adjustable foot clockwise or counterclockwise to raise or lower the projector.

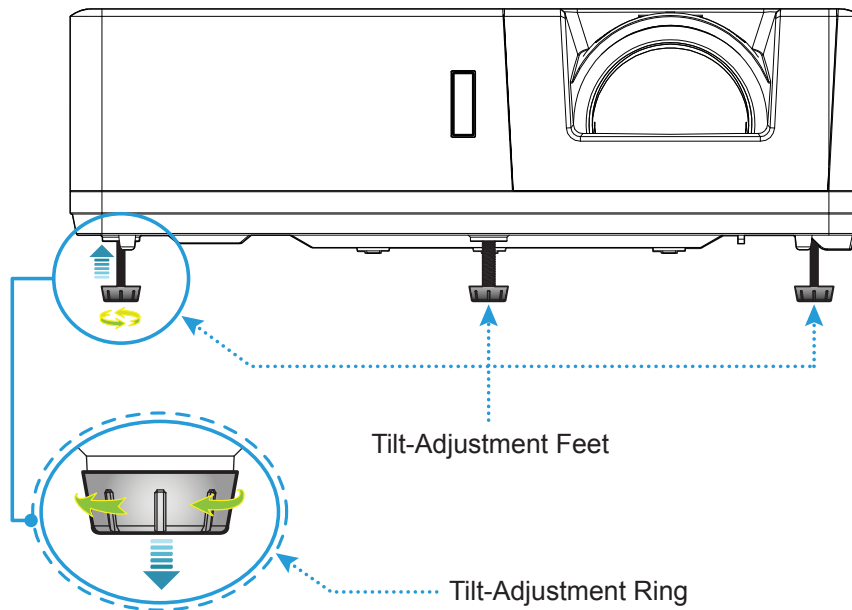

Lens shift and focus

- To adjust the image position, turn the lens shift dial clockwise or counterclockwise to adjust the position of the projected image vertically.
- To adjust the focus, turn the focus lever clockwise or counterclockwise until the image is sharp and legible.

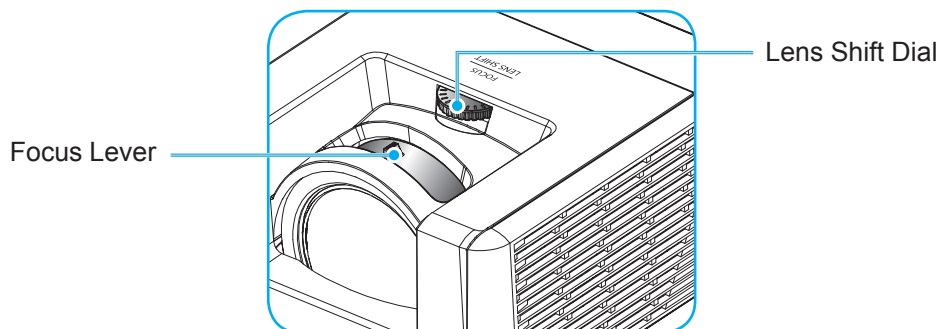

Note: The projector will focus at a distance of:

- 1080P: 0.5m to 5.3m
- WUXGA: 0.5m to 5.2m

SETUP AND INSTALLATION

Remote setup

Installing / replacing the batteries

Two AAA size batteries are supplied for the remote control.

1. Remove the battery cover on the back of the remote control.
2. Insert AAA batteries in the battery compartment as illustrated.
3. Replace back cover on remote control.

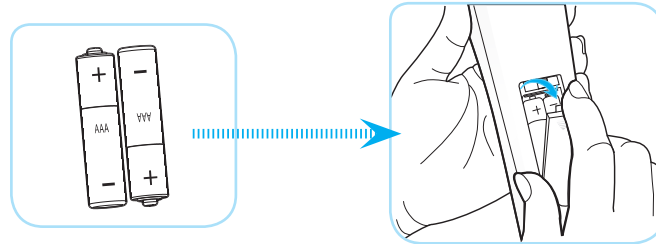

Note: Replace only with the same or equivalent type batteries.

CAUTION

Improper use of batteries can result in chemical leakage or explosion. Be sure to follow the instructions below.

- Do not mix batteries of different types. Different types of batteries have different characteristics.
- Do not mix old and new batteries. Mixing old and new batteries can shorten the life of new batteries or cause chemical leakage in old batteries.
- Remove batteries as soon as they are depleted. Chemicals that leak from batteries that come in contact with skin can cause a rash. If you find any chemical leakage, wipe thoroughly with a cloth.
- The batteries supplied with this product may have a shorter life expectancy due to storage conditions.
- If you will not be using the remote control for an extended period of time, remove the batteries.
- When you dispose of the batteries, you must obey the law in the relative area or country.

SETUP AND INSTALLATION

Effective range

Infra-Red (IR) remote control sensor is located on the top and front sides of the projector. Ensure to hold the remote control at an angle within 30 degrees perpendicular to the projector's IR remote control sensor to function correctly. The distance between the remote control and the sensor should not be longer than 6 meters (19.7 feet) when holding in an angle $\pm 15^\circ$ and not longer than 8 meters (26.2 feet) when aiming the sensor at 0° .

- Make sure that there are no obstacles between the remote control and the IR sensor on the projector that might obstruct the infra-red beam.
- Make sure the IR transmitter of the remote control is not being shined by sunlight or fluorescent lamps directly.
- Please keep the remote controller away from fluorescent lamps for over 2 m or the remote controller might become malfunction.
- If the remote control is close to Inverter-Type fluorescent lamps, it might become ineffective from time to time.
- If the remote control and the projector are within a very short distance, the remote control might become ineffective.
- When you aim at the screen, the effective distance is less than 5 m from the remote control to the screen and reflecting the IR beams back to the projector. However, the effective range might change according to screens.

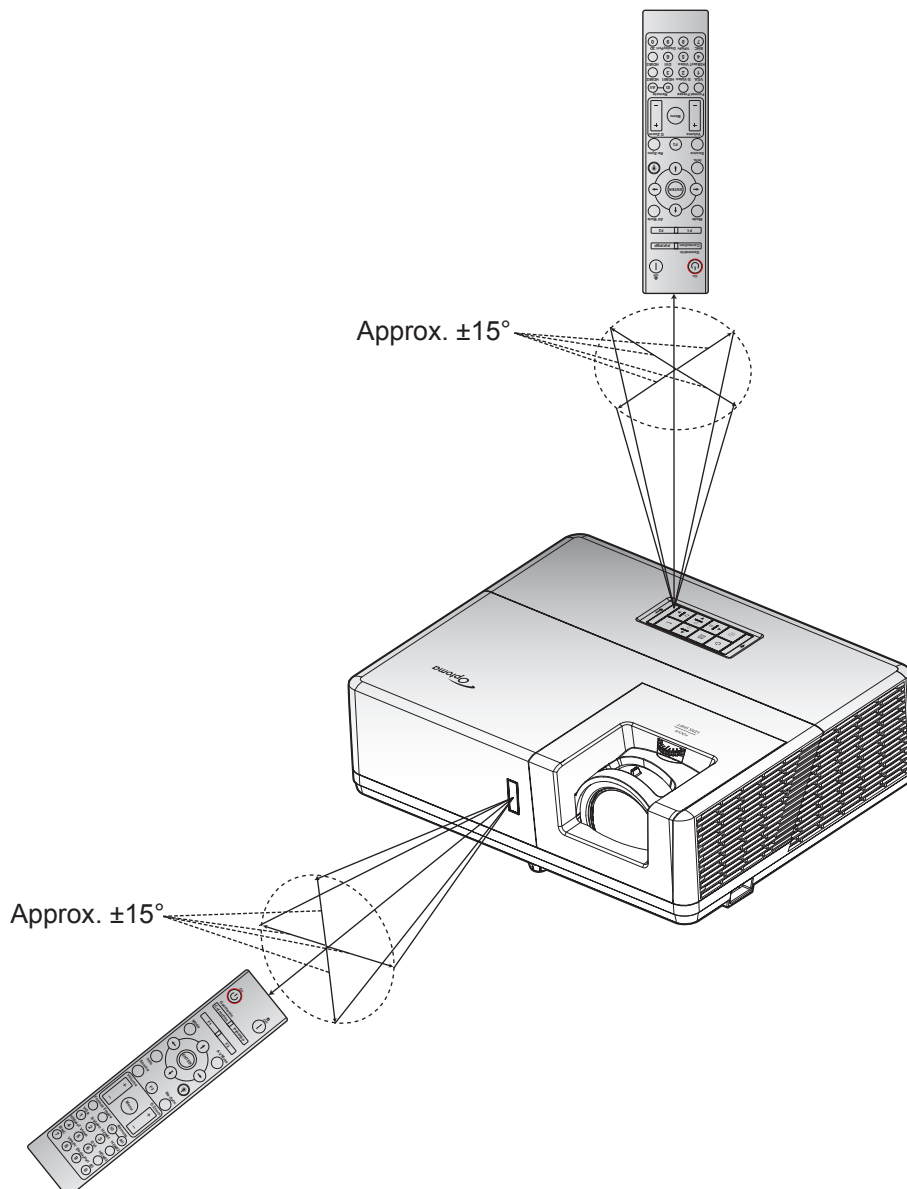

USING THE PROJECTOR

Powering on / off the projector

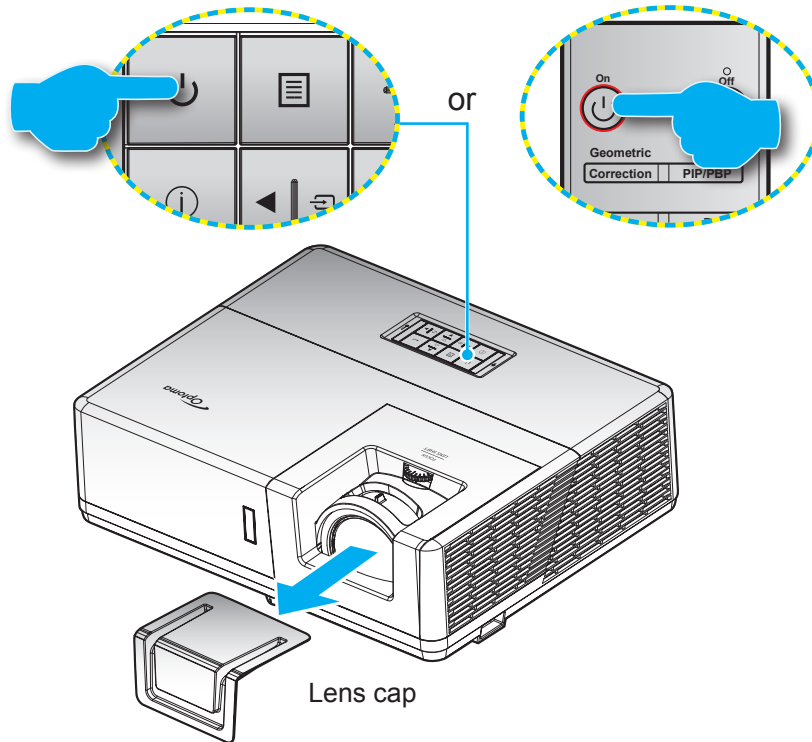



Powering on





1. Remove the lens cap.
2. Securely connect the power lead and signal/source cable. When connected, the Power LED will turn red.
3. Turn on the projector by pressing the  button on the projector keypad or remote control.
4. A start up screen will display in approximately 10 seconds and the Power LED will be flashing blue or flashing green.

Note: The first time the projector is turned on, you will be prompted to select the preferred language, projection orientation, and other settings.

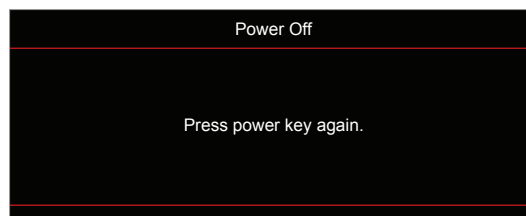
Powering off

1. Turn off the projector by pressing the  button on the projector keypad or the  button on the remote control.
2. The following message will be displayed:



3. Press the  or  button again to confirm, otherwise the message will disappear after 15 seconds. When you press the  or  button for the second time, the projector will shut down.
4. When the Power turns solid red, this indicates the projector has entered standby mode. If you wish to turn the projector back on, you must wait until the cooling cycle has finished and the projector has entered standby mode. When the projector is in standby mode, simply press the  button again to turn on the projector.
5. Disconnect the power lead from the electrical outlet and the projector.

Note: It is not recommended that the projector is turned on immediately, right after a power off procedure.

USING THE PROJECTOR

Selecting an input source

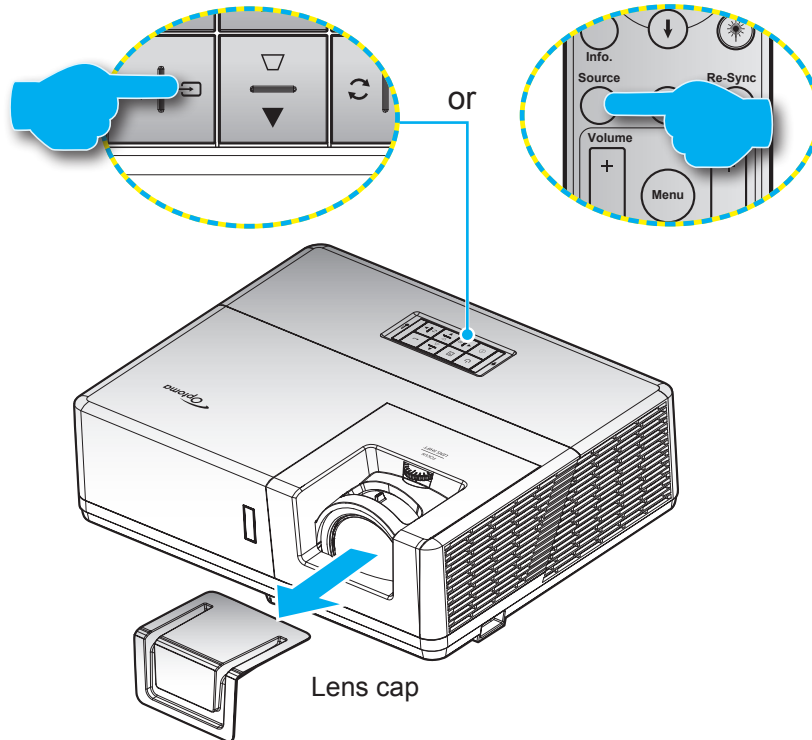

Turn on the connected source that you want to display on the screen, such as computer, notebook, video player, etc. The projector will automatically detect the source. If multiple sources are connected, press the  button on the projector keypad or the **Source** button on the remote control to select the desired input.



USING THE PROJECTOR

Menu navigation and features

The projector has multilingual on-screen display menus that allow you to make image adjustments and change a variety of settings. The projector will automatically detect the source.

1. To open the OSD menu, press the  button on the projector keypad or the **Menu** button on the remote control.
2. When OSD is displayed, use **▲▼** keys to select any item in the main menu. While making a selection on a particular page, press the **←** button on the projector keypad or the **Enter** button on the remote control to enter sub menu.
3. Use **◀▶** keys to select the desired item in the sub menu and then press the **←** or **Enter** button to view further settings. Adjust the settings by using **◀▶** keys.
4. Select the next item to be adjusted in the sub menu and adjust as described above.
5. Press press the **←** or **Enter** button to confirm, and the screen will return to the main menu.
6. To exit, press the  or **Menu** button again. The OSD menu will close and the projector will automatically save the new settings.

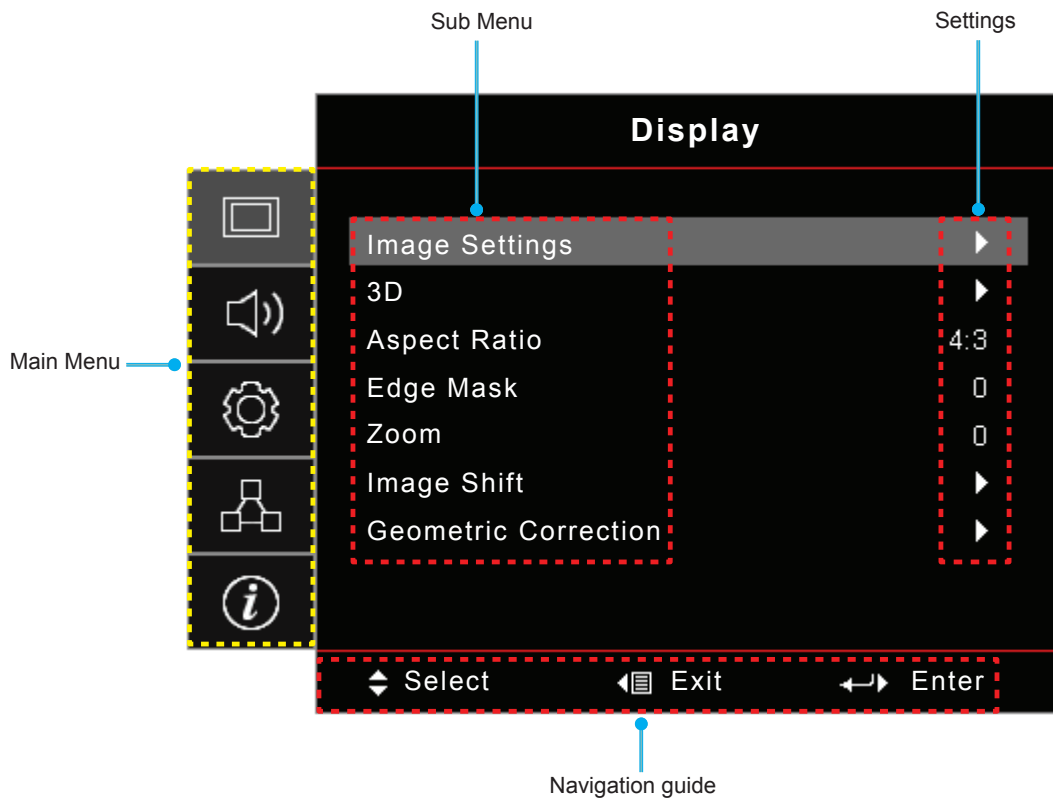

USING THE PROJECTOR



OSD Menu tree

Main Menu	Sub Menu	Sub Menu 2	Sub Menu 3	Sub Menu 4	Values	
Display	Image Settings	Display Mode			Presentation	
					Bright	
					HDR	
					Cinema	
					Game	
					sRGB	
					DICOM SIM.	
					User	
				3D		
			Wall Color			Off [Default]
						Blackboard
						Light Yellow
						Light Green
						Light Blue
						Pink
			Dynamic Range	HDR		Off
						Auto [Default]
				HDR Picture Mode		Bright
						Standard [Default]
						Film
					Detail	
			Brightness			-50 ~ 50
			Contrast			-50 ~ 50
			Sharpness			1 ~ 15
			Color			-50 ~ 50
			Tint			-50 ~ 50
			Gamma		Film	
					Video	
					Graphics	
					Standard(2.2)	
					1.8	
					2.0	
				2.4		
		2.6				
	Color Settings	BrilliantColor™			1 ~ 10	





USING THE PROJECTOR

Main Menu	Sub Menu	Sub Menu 2	Sub Menu 3	Sub Menu 4	Values
Display	Image Settings	Color Settings	Color Temperature		Warm
					Standard
					Cool
					Cold
			Color Matching	Color	Red [Default]
					Green
					Blue
					Cyan
					Yellow
					Magenta
					White(*)
				Hue / R(*)	-50 ~ 50 [Default: 0]
				Saturation / G(*)	-50 ~ 50 [Default: 0]
				Gain / B(*)	-50 ~ 50 [Default: 0]
				Reset	Cancel [Default] Yes
				Exit	
				RGB Gain/Bias	Red Gain
			Green Gain		-50 ~ 50
			Blue Gain		-50 ~ 50
			Red Bias		-50 ~ 50
			Green Bias		-50 ~ 50
			Blue Bias		-50 ~ 50
			Reset		Cancel [Default] Yes
			Exit		
			Color Space [Not HDMI Input]		Auto [Default]
					RGB
					YUV
			Color Space [HDMI Input]		Auto [Default]
					RGB(0~255)
					RGB(16~235)
					YUV
			White Level	0 ~ 31	
			Black Level	-5 ~ 5	
			IRE		0
					7.5
			Signal	Automatic	Off
					On [Default]
				Frequency	-10 ~ 10 (depends on signal) [Default: 0]
			Phase	0~31 (depends on signal) [Default: 0]	

USING THE PROJECTOR

Main Menu	Sub Menu	Sub Menu 2	Sub Menu 3	Sub Menu 4	Values
Display	Image Settings	Signal	H. Position		-5 ~ 5 (depends on signal) [Default: 0]
			V. Position		-5 ~ 5 (depends on signal) [Default: 0]
		Brightness Mode			DynamicBlack
					Power (Power = 100%/ 95%/ 90%/ 85%/ 80%/ 75%/ 70%/ 65%/ 60%/ 55%/ 50%)
		Reset			
	3D	3D Mode			Off
					On [Default]
		3D Tech			DLP-Link [Default]
					3D Sync
		3D → 2D			3D [Default]
					L
				R	
		3D Format			Auto [Default]
					SBS
					Top and Bottom
					Frame Sequential
		3D Sync Invert			On
				Off [Default]	
	Reset			Cancel	
				Yes	
	Aspect Ratio				4:3
					16:9
					16:10
					Note: For WUXGA model only.
					LBX
					Native
				Auto	
		Edge Mask			0 ~ 10 [Default: 0]
		Zoom			-5 ~ 25 [Default: 0]
	Image Shift	H 			-100 ~ 100 [Default: 0]
		V 			-100 ~ 100 [Default: 0]
	Geometric Correction	Four Corners			
H Keystone				-20 ~ 20 [Default: 0]	
V Keystone				-20 ~ 20 [Default: 0]	
Auto Keystone				Off	
Reset				On [Default]	
Audio	Mute			Off [Default]	
				On	
	Volume			0 ~ 10 [Default: 5]	

USING THE PROJECTOR

Main Menu	Sub Menu	Sub Menu 2	Sub Menu 3	Sub Menu 4	Values	
Audio	Audio Input	HDMI1/MHL			Audio 1	
					Audio 2	
					Default [Default]	
		HDMI2			Audio 1	
					Audio 2	
					Default [Default]	
		HDBaseT [Only for HDBaseT model]			Audio 1	
					Audio 2	
				Default [Default]		
		VGA [Only for non-HDBaseT model]			Audio 1	
				Audio 2		
	VGA 1 [Only for HDBaseT model]			Audio 1		
				Audio 2		
	VGA 2 [Only for HDBaseT model]			Audio 1		
			Audio 2			
S-Video [Only for HDBaseT model]			Audio 1			
			Audio 2			
Video			Audio 1			
			Audio 2			
Audio / Mic Input Function				Audio Input [Default]		
				Mic		
Setup	Projection				Front  [Default]	
					Rear 	
					Ceiling-top 	
					Rear-top 	
	Screen Type [Only for WUXGA model]				16:9	
					16:10 [Default]	
	Power Settings	Direct Power On				Off [Default]
						On
		Signal Power On				Off [Default]
						On
		Auto Power Off (min.)				0 ~ 180 (5 min increments) [Default: 20]
		Sleep Timer (min.)				0 ~ 990 (30 min increments) [Default: 0]
			Always On			
	Power Mode (Standby)					Active
						Eco [Default]
	USB Power (Standby)					Off [Default]
					On	



USING THE PROJECTOR

Main Menu	Sub Menu	Sub Menu 2	Sub Menu 3	Sub Menu 4	Values		
Setup	Security	Security			Off		
					On		
		Security Timer	Month				
			Day				
			Hour				
	Change Password				[Default: 1234]		
	HDMI Link Settings	HDMI Link				Off [Default]	
						On	
		Inclusive of TV				No [Default]	
						Yes	
		Power On Link				Mutual [Default]	
						PJ → Device	
						Device → PJ	
		Power Off Link				Off [Default]	
					On		
	Test Pattern					Green Grid	
						Magenta Grid	
						White Grid	
						White	
						Off	
	Remote Settings [depends on remote]	IR Function				On [Default]	
						Off	
		Remote Code				00~99	
		F1					Test Pattern
							Brightness
							Contrast
							Sleep Timer
							Color Matching
							Color Temp
							Gamma
							Projection
		F2					MHL
						Test Pattern	
						Brightness	
						Contrast	
						Sleep Timer	
						Color Matching	
						Color Temp	
					Gamma		
				Projection			
					MHL		

USING THE PROJECTOR

Main Menu	Sub Menu	Sub Menu 2	Sub Menu 3	Sub Menu 4	Values	
Setup	Remote Settings [depends on remote]	F3			Test Pattern	
					Brightness	
					Contrast	
					Sleep Timer	
					Color Matching	
					Color Temp	
					Gamma	
					Projection	
					MHL	
	Projector ID					00 ~ 99
	12V Trigger					On
						Off
	HDBaseT Control	Ethernet				On
						Off [Default]
		RS232				On
						Off [Default]
		HDBaseT Mode				Auto
						HDBaseT [Default]
	Options	Language				English [Default]
						Deutsch
						Français
						Italiano
						Español
						Português
						Polski
						Nederlands
						Svenska
						Norsk/Dansk
						Suomi
						ελληνικά
						繁體中文
						簡體中文
						日本語
						한국어
						Русский
						Magyar
						Čeština
						عربي
						ไทย
						Türkçe
						فارسی
					Tiếng Việt	
			Bahasa Indonesia			
			Română			
			Slovenčina			

USING THE PROJECTOR

Main Menu	Sub Menu	Sub Menu 2	Sub Menu 3	Sub Menu 4	Values	
Setup	Options	Closed Captioning			CC1	
					CC2	
					Off [Default]	
		Menu Settings	Menu Location			Top left 
						Top right 
						Center  [Default]
						Bottom left 
						Bottom right 
			Menu Timer			Off
						5sec
					10sec [Default]	
		Auto Source			Off [Default]	
					On	
		Input Source			HDMI1/MHL	
					HDMI2	
					HDBaseT	
					VGA	
					VGA 1	
					VGA 2	
					S-Video	
					Video	
		Input Name	HDMI1/MHL			Default [Default]
						Custom
			HDMI2			Default [Default]
						Custom
			HDBaseT [Only for HDBaseT model]			Default [Default]
						Custom
			VGA [Only for non-HDBaseT model]			Default [Default]
						Custom
			VGA 1 [Only for HDBaseT model]			Default [Default]
						Custom
			VGA 2 [Only for HDBaseT model]			Default [Default]
						Custom
			S-Video [Only for HDBaseT model]			Default [Default]
						Custom
		Video			Default [Default]	
					Custom	
		High Altitude			Off [Default]	
					On	
		Display Mode Lock			Off [Default]	
					On	

USING THE PROJECTOR

Main Menu	Sub Menu	Sub Menu 2	Sub Menu 3	Sub Menu 4	Values
Setup	Options	Keypad Lock			Off [Default]
					On
		Information Hide			Off [Default]
					On
		Logo			Default [Default]
					Neutral
					User
		Background Color			None [Default for Video/Pro-AV model] Note: "None" means black color background.
					Blue [Default for data model]
					Red
				Green	
				Gray	
	Reset	Reset OSD			Cancel [Default]
					Yes
Reset to Default				Cancel [Default]	
				Yes	
Network	LAN	Network Status			(read only)
		MAC Address			(read only)
		DHCP			Off [Default]
					On
		IP Address			192.168.0.100 [Default]
		Subnet Mask			255.255.255.0 [Default]
		Gateway			192.168.0.254 [Default]
		DNS			192.168.0.51 [Default]
	Reset				
	Control	Crestron			Off
					On [Default] Note: Port 41794
		Extron			Off
					On [Default] Note: Port 2023
		PJ Link			Off
					On [Default] Note: Port 4352
		AMX Device Discovery			Off
					On [Default] Note: Port 9131
		Telnet			Off
				On [Default] Note: Port 23	
HTTP			Off		
			On [Default] Note: Port 80		

USING THE PROJECTOR

Main Menu	Sub Menu	Sub Menu 2	Sub Menu 3	Sub Menu 4	Values	
Info	Regulatory					
	Serial Number					
	Source					
	Resolution				00x00	
	Refresh Rate				0.00Hz	
	Display Mode					
	Remote Code				00 ~ 99	
	Remote Code(Active)				00 ~ 99	
	Power Mode (Standby)					
	Light Source Hours				0 hr	
	Network Status					
	IP Address					
	Projector ID				00 ~ 99	
	Brightness Mode					
	FW Version	System				
		LAN				
MCU						

USING THE PROJECTOR

Display menu

Display image settings menu

Display Mode

There are many factory presets optimized for various types of images.

- **Presentation:** This mode is suitable for showing in front of public in connection to the PC.
- **Bright:** Maximum brightness from PC input.
- **HDR:** Decodes and displays High Dynamic Range (HDR) content for the deepest blacks, brightest whites, and vivid cinematic color using REC.2020 color gamut. This mode will be automatically enabled if HDR is set to ON (and HDR Content is sent to projector – 4K UHD Blu-ray, 1080p/4K UHD HDR Games, 4K UHD Streaming Video). While HDR mode is active, other display modes (Cinema, Reference, etc.) cannot be selected as HDR delivers color that is highly accurate, exceeding the color performance of the other display modes.
- **Cinema:** Provides the best colors for watching movies.
- **Game:** Select this mode to increase the brightness and response time level for enjoying video games.
- **sRGB:** Standardized accurate color.
- **DICOM SIM.:** This mode can project a monochrome medical image such as an X ray radiography, MRI, etc.
- **User:** Memorize user's settings.
- **3D:** To experience the 3D effect, you need to have 3D glasses, make sure your PC/portable device has a 120 Hz signal output quad buffered graphics card and have a 3D Player installed.

Wall Color

Use this function to obtain an optimized screen image according to the wall color. Select between off, blackboard, light yellow, light green, light blue, pink, and gray.

Dynamic Range

Configure the High Dynamic Range (HDR) setting and its effect when displaying video from 4K Blu-ray players and streaming devices.

Note: *HDMI1 and VGA do not support Dynamic Range.*

➤ HDR

- **Off:** Turn off HDR Processing. When set to Off, the projector will NOT decode HDR content.
- **Auto:** Auto detect HDR signal.

➤ HDR Picture Mode

- **Bright:** Choose this mode for brighter more saturated colors.
- **Standard:** Choose this mode for natural looking colors with a balance of warm and cool tones.
- **Film:** Choose this mode for improved detail and image sharpness.
- **Details:** The signal comes from OETF conversion to achieve the best color matching.

Brightness

Adjust the brightness of the image.

Contrast

The contrast controls the degree of difference between the lightest and darkest parts of the picture.

Sharpness

Adjust the sharpness of the image.

USING THE PROJECTOR

Color

Adjust a video image from black and white to fully saturated color.

Tint

Adjust the color balance of red and green.

Gamma

Set up gamma curve type. After the initial setup and fine tuning is completed, utilize the Gamma Adjustment steps to optimize your image output.

- **Film:** For home theater.
- **Video:** For video or TV source.
- **Graphics:** For PC / Photo source.
- **Standard(2.2):** For standardized setting.
- **1.8 / 2.0 / 2.4 / 2.6:** For specific PC / Photo source.

Note:

- *These options are only available if the 3D mode function is disabled, the **Wall Color** setting is not set to **Blackboard**, and the **Display Mode** setting is not set to **DICOM SIM.** or **HDR.***
- *If the **Display Mode** setting is set to **HDR**, user can only select **HDR** for **Gamma** setting.*
- *In 3D mode, user can only select **3D** for **Gamma** setting.*
- *If the **Wall Color** setting is set to **Blackboard**, user can only select **Blackboard** for **Gamma** setting.*
- *If the **Display Mode** setting is set to **DICOM SIM.**, user can only select **DICOM SIM.** for **Gamma** setting.*

Color Settings

Configure the color settings.

- **BrilliantColor™:** This adjustable item utilizes a new color-processing algorithm and enhancements to enable higher brightness while providing true, more vibrant colors in picture.
- **Color Temperature:** Select a color temperature from Warm, Standard, Cool, or Cold.
- **Color Matching:** Select the following options:
 - Color: Adjust the red, green, black, cyan, yellow, magenta, and white level of the image.
 - Hue / R(red)*: Adjust the color balance of red and green.
Note: **If the **Color** setting is set to **White**, you can adjust the red color setting.*
 - Saturation / G(green)*: Adjust a video image from black and white to fully saturated color.
Note: **If the **Color** setting is set to **White**, you can adjust the green color setting.*
 - Gain / B(blue)*: Adjust the image brightness.
Note: **If the **Color** setting is set to **White**, you can adjust the blue color setting.*
 - Reset: Return the factory default settings for color matching.
 - Exit: Exit the “Color Matching” menu.
- **RGB Gain/Bias:** This settings allows to configure the brightness (gain) and contrast (bias) of an image.
 - Reset: Return the factory default settings for RGB gain/bias.
 - Exit: Exit the “RGB Gain/Bias” menu.
- **Color Space (non-HDMI input only):** Select an appropriate color matrix type from the following: AUTO, RGB, or YUV.

USING THE PROJECTOR

- **Color Space (HDMI input only):** select an appropriate color matrix type from the following: Auto, RGB(0-255), RGB(16-235), and YUV.
- **White Level:** Allow user to adjust White Level when inputting Video signals.
Note: *White level can only be adjusted for Video/S-Video input sources.*
- **Black Level:** Allow user to adjust Black Level when inputting Video signals.
Note: *Black level can only be adjusted for Video/S-Video input sources.*
- **IRE:** Allow user to adjust IRE value when inputting Video signals.
Note:
 - *IRE is only available with NTSC video format.*
 - *IRE can only be adjusted for Video/S-Video input sources.*

Signal

Adjust the signal options.

- **Automatic:** Configure automatically the signal (the frequency and phase items are grayed out). If automatic is disabled, the frequency and phase items will appear for tuning and saving the settings.
- **Frequency:** Change the display data frequency to match the frequency of your computer's graphic card. Use this function only if the image appears to flicker vertically.
- **Phase:** Synchronize the signal timing of the display with the graphic card. If the image appears to be unstable or flickers, use this function to correct it.
- **H. Position:** Adjust the horizontal positioning of the image.
- **V. Position:** Adjust the vertical positioning of the image.

Note: *This menu is only available if the input source is RGB/Component.*

Brightness Mode

Adjust the brightness mode settings.

- **DynamicBlack:** Use to automatically adjust the picture brightness in order to give optimum contrast performance.
- **Power:** Choose the power percentage for brightness mode.

Reset

Return the factory default settings for color settings.

USING THE PROJECTOR

Display 3D menu

Note:

- *This projector is a 3D ready projector with DLP-Link 3D solution.*
- *Please make sure your 3D glasses are use for DLP-Link 3D before enjoy your video.*
- *This projector supports frame sequential (page-flip) 3D via HDMI1/HDMI2/VGA ports.*
- *To enable 3D mode, the input frame rate should be set to 60Hz only, lower or higher frame rate is not supported.*
- *To reach the best performance, resolution 1920x1080 is recommended, please be noted that 4K (3840x2160) resolution is not supported in 3D mode.*

3D Mode

Use this option to enable or disable the 3D function.

- **Off:** Select “Off” to turn off 3D mode.
- **On:** Select “On” to turn on 3D mode.

Note: *If the 2D and 3D sources enter PJ at the same time, if the ghosting image appears in the 2D source, make sure to manually turn off the 3D function.*

3D Tech

Set the 3D tech. parameter to “DLP-Link” or “3D Sync”.

3D → 2D

Use this option to specify how the 3D content should appear on the screen.

- **3D:** Display 3D signal.
- **L (Left):** Display the left frame of 3D content.
- **R (Right):** Display the right frame of 3D content.

3D Format

Use this option to select the appropriate 3D format content.

- **Auto:** When a 3D identification signal is detected, the 3D format is selected automatically.
- **SBS:** Display 3D signal in “Side-by-Side” format.
- **Top and Bottom:** Display 3D signal in “Top and Bottom” format.
- **Frame Sequential:** Display 3D signal in “Frame Sequential” format.

3D Sync Invert

Use this option to enable/disable the 3D sync invert function.

Reset

Return the factory default settings for 3D settings.

USING THE PROJECTOR

Display aspect ratio menu

Aspect Ratio

Select the aspect ratio of the displayed image between the following options:

- **4:3:** This format is for 4:3 input sources.
- **16:9:** This format is for 16:9 input sources, like HDTV and DVD enhanced for Wide screen TV.
- **16:10** (for WUXGA model only): This format is for 16:10 input sources, like widescreen laptops.
- **LBX:** This format is for non-16x9, letterbox source and if you use external 16x9 lens to display 2.35:1 aspect ratio in full resolution.
- **Native:** This format displays the original image without any scaling.
- **Auto:** Automatically selects the appropriate display format.

Note:

- *Detailed informations about LBX mode:*
 - *Some Letter-Box Format DVDs are not enhanced for 16x9 TVs. In this situation, the image will not look right when displaying image in 16:9 mode. In this situation, please try to use the 4:3 mode to view the DVD. If the content is not 4:3, there will be black bars around the image in 16:9 display. For this type of content, you can use LBX mode to fill the image on the 16:9 display.*
 - *If you use an external anamorphic lens, this LBX mode also allows you to watch a 2.35:1 content (include Anamorphic DVD and HDTV film source) that supports anamorphic wide is enhanced for 16x9 Display in a wide 2.35:1 image. In this case, there are no black bars. Light source power and vertical resolution are fully utilized.*

1080p scaling table:

16:9 screen	480i/p	576i/p	1080i/p	720p	PC
4x3	Scale to 1440x1080.				
16x9	Scale to 1920x1080.				
LBX	Scale to 1920x1440, then get the central 1920x1080 image to display.				
Native mode	- 1:1 mapping centered. - No scaling will be made; the image is displayed with the resolution based on input source.				
Auto	- If auto format is selected, the screen type will automatically become 16:9 (1920x1080). - If source is 4:3, the screen type will be scaled to 1440 x1080. - If source is 16:9, the screen type will be scaled to 1920x1080. - If source is 16:10, the screen type will be scaled to 1920x1200 and cut 1920x1080 area to display.				

USING THE PROJECTOR

1080p auto mapping rule:

Auto	Input resolution		Auto/Scale	
	H-resolution	V-resolution	1920	1080
4:3	640	480	1440	1080
	800	600	1440	1080
	1024	768	1440	1080
	1280	1024	1440	1080
	1400	1050	1440	1080
	1600	1200	1440	1080
Wide Laptop	1280	720	1920	1080
	1280	768	1800	1080
	1280	800	1728	1080
SDTV	720	576	1350	1080
	720	480	1620	1080
HDTV	1280	720	1920	1080
	1920	1080	1920	1080

WUXGA scaling table for 1920 x 1200 DMD (screen type 16:10):

Note:

- Supported screen type 16:10 (1920 x 1200), 16:9 (1920x1080).
- When screen type is 16:9, the 16x10 format becomes unavailable.
- When screen type is 16:10, the 16x9 format becomes unavailable.
- If you select auto option then the display mode will be also automatically changed.

16 : 10 screen	480i/p	576i/p	1080i/p	720p	PC
4x3	Scale to 1600x1200.				
16x10	Scale to 1920x1200.				
LBX	Scale to 1920x1440, then get the central 1920x1200 image to display.				
Native mode	- 1:1 mapping centered. - No scaling will be made; the image is displayed with the resolution based on input source.				
Auto	- If this format is selected, the screen type will automatically become 16:10 (1920x1200). - If source is 4:3, the screen type will be scaled to 1600x1200. - If source is 16:9, the screen type will be scaled to 1920x1080. - If source is 16:10, the screen type will be scaled to 1920x1200.				

USING THE PROJECTOR

WUXGA auto mapping rule (screen type 16:10):

Auto	Input resolution		Auto/Scale	
	H-resolution	V-resolution	1920	1200
4:3	640	480	1600	1200
	800	600	1600	1200
	1024	768	1600	1200
	1280	1024	1600	1200
	1400	1050	1600	1200
	1600	1200	1600	1200
Wide Laptop	1280	720	1920	1080
	1280	768	1920	1152
	1280	800	1920	1200
SDTV	720	576	1500	1200
	720	480	1800	1200
HDTV	1280	720	1920	1080
	1920	1080	1920	1080

WUXGA scaling table (screen type 16:9):

16 : 9 screen	480i/p	576i/p	1080i/p	720p	PC
4x3	Scale to 1440x1080.				
16x9	Scale to 1920x1080.				
LBX	Scale to 1920x1440, then get the central 1920x1080 image to display.				
Native mode	<ul style="list-style-type: none"> - 1:1 mapping centered. - No scaling will be made; the image is displayed with the resolution based on input source. 				
Auto	<ul style="list-style-type: none"> - If this format is selected, the screen type will automatically become 16:9 (1920x1080). - If source is 4:3, the screen type will be scaled to 1440x1080. - If source is 16:9, the screen type will be scaled to 1920x1080. - If source is 16:10, the screen type will be scaled to 1920x1200 and cut 1920x1080 area to display. 				

USING THE PROJECTOR

WUXGA auto mapping rule (screen type 16:9):

Auto	Input resolution		Auto/Scale	
	H-resolution	V-resolution	1920	1080
4:3	640	480	1440	1080
	800	600	1440	1080
	1024	768	1440	1080
	1280	1024	1440	1080
	1400	1050	1440	1080
	1600	1200	1440	1080
Wide Laptop	1280	720	1920	1080
	1280	768	1800	1080
	1280	800	1728	1080
SDTV	720	576	1350	1080
	720	480	1620	1080
HDTV	1280	720	1920	1080
	1920	1080	1920	1080

Display edge mask menu

Edge Mask

Use this function to remove the video encoding noise on the edge of video source.

Display zoom menu

Zoom

Use to reduce or magnify an image on the projection screen.

Display image shift menu

Image Shift

Adjust the projected image position horizontally (H) or vertically (V).

Display geometric correction menu

Four Corners

Allow the image to be squeezed to fit an area defined by moving each of the four corners' x and y position.

H Keystone

Adjust image distortion horizontally and make a squarer image. Horizontal keystone is used to correct a keystone image shape in which the left and right borders of the image are unequal in length. This is intended for use with horizontally on-axis applications.

V Keystone

Adjust image distortion vertically and make a squarer image. Vertical keystone is used to correct a keystone image shape in which the top and bottom are slanted to one of the sides. This is intended when for use with vertically on-axis applications.

USING THE PROJECTOR

Auto Keystone

Correct keystone digitally to fit the projected image on the area on which you are projecting.

Note:

- *The image size will reduce slightly when adjusting the horizontal and vertical keystone.*
- *When the Auto Keystone is used, the Four Corner Adjustment function will be disabled.*

Reset

Return the factory default settings for geometric correction settings.

Audio menu

Audio mute menu

Mute

Use this option to temporarily turn off the sound.

- **On:** Choose "On" to turn mute on.
- **Off:** Choose "Off" to turn mute off.

Note: "Mute" function affects both internal and external speaker volume.

Audio volume menu

Volume

Adjust the volume level.

Audio audio input menu

Audio Input

Select the audio input port for the video sources as follows:

- **HDMI1/MHL:** Audio 1, Audio 2, or Default.
- **HDMI2:** Audio 1, Audio 2, or Default.
- **HDBaseT:** Audio 1, Audio 2, or Default.
- **VGA:** Audio 1 and Audio 2.
- **VGA 1:** Audio 1 and Audio 2.
- **VGA 2:** Audio 1 and Audio 2.
- **S-Video:** Audio 1 and Audio 2.
- **Video:** Audio 1 and Audio 2.

Note:

- *HDBaseT, VGA 1, VGA 2, and S-Video options are only applicable for HDBaseT model.*
- *VGA option is only applicable for non-HDBaseT model.*

Audio audio / mic input function menu

Audio / Mic Input Function

Configure the audio input source setting.

USING THE PROJECTOR

Setup menu

Setup projection menu

Projection

Select the preferred projection between front, rear, ceiling-top, and rear-top.

Setup screen type menu

Screen Type (for WUXGA model only)

Choose the screen type from 16:9 and 16:10.

Setup power settings menu

Direct Power On

Choose “On” to activate Direct Power mode. The projector will automatically power on when AC power is supplied, without pressing the “Power” key on the projector keypad or on the remote control.

Signal Power On

Choose “On” to activate Signal Power mode. The projector will automatically power on when a signal is detected, without pressing the “Power” key on the projector Keypad or on the remote control.

Auto Power Off (min.)

Sets the countdown timer interval. The countdown timer will start, when there is no signal being sent to the projector. The projector will automatically power off when the countdown has finished (in minutes).

Sleep Timer (min.)

Configure the sleep timer.

- **Sleep Timer (min.):** Sets the countdown timer interval. The countdown timer will start, with or without a signal being sent to the projector. The projector will automatically power off when the countdown has finished (in minutes).
Note: *The Sleep Timer is reset every time when the projector is powered off.*
- **Always On:** Check to set the sleep timer always on.

Power Mode (Standby)

Set the power mode setting.

- **Active:** Choose “Active” to return to normal standby.
- **Eco:** Choose “Eco.” to save power dissipation further < 0.5W.

USB Power (Standby)

Enable or disable the USB power function when the projector is in standby mode.

Note: *The USB is not able to supply power with S-Video or MHL sources.*

USING THE PROJECTOR

Setup security menu

Security

Enable this function to prompt for a password before using the projector.

- **On:** Choose “On” to use security verification when the turning on the projector.
- **Off:** Choose “Off” to be able to switch on the projector without password verification.

Security Timer

Can be select the time (Month/Day/Hour) function to set the number of hours the projector can be used. Once this time has elapsed you will be requested to enter your password again.

Change Password

Use to set or modify the password that is prompted when turning the projector on.

Setup HDMI link settings menu

Note:

- *When you connect HDMI CEC-compatible devices to the projector with HDMI cables, you can control them on the same power on or power off status using the HDMI Link control feature in the projector’s OSD. This lets one device or multiple devices in a group power on or power off via HDMI Link Feature in a typical configuration, your DVD player may be connected to the projector through an amplifier or home theater system.*

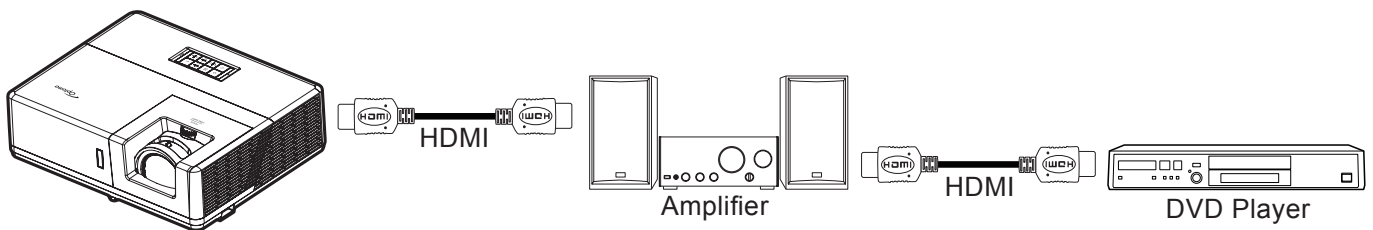

HDMI Link

Enable/disable the HDMI Link function. The inclusive TV, power on link, and power off link options will only available if the setting is set to “On”.

Inclusive of TV

Set to “Yes” if you prefer both TV and projector to be automatically turned off at the same time. To prevent both devices to be turned off at the same time, set the setting to “No”.

Power On Link

CEC power on command.

- **Mutual:** Both projector and CEC device will be turned on simultaneously.
- **PJ → Device:** The CEC device will be turned on only after the projector is switched on.
- **Device → PJ:** The projector will be switched on only after the CEC device is turned on.

Power Off Link

Enable this function to let both HDMI Link and projector to be automatically turned off at the same time.

Setup test pattern menu

Test Pattern

Select the test pattern from green grid, magenta grid, white grid, white, or disable this function (off).

USING THE PROJECTOR

Setup remote settings menu

IR Function

Set the IR function setting.

- **On:** Choose “On”, the projector can be operated by the remote control from the top and front IR receivers.
- **Off:** Choose “Off”, the projector can't be operated by the remote control. By selecting “Off”, you will be able to use the Keypad keys.

Remote Code

Set the remote custom code by pressing the remote ID button for 3 seconds and you will notice the remote indicator (above the Off button) starts blinking. Then, input a number between 00-99 using the keyboard numbered keys. After inserting the number, the remote indicator blinks twice quickly indicating that the remote code has changed.

F1/F2/F3

Assign the default function for F1, F2, or F3 between Test Pattern, Brightness, Contrast, Sleep Timer, Color Matching, Color Temp, Gamma, Projection, or MHL.

Setup projector ID menu

Projector ID

ID definition can be set up by menu (range 0-99), and allow user control an individual projector by using RS232 command.

Setup 12V trigger menu

12V Trigger

Use this function to enable or disable the trigger.

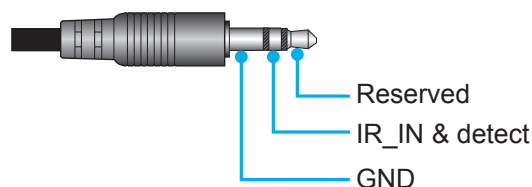

- **Off:** Choose “Off” to disable the trigger.
- **On:** Choose “On” to enable the trigger.

Setup HDBaseT control menu

Ethernet / RS232

The projector can automatically detect the Ethernet or RS232 signal from the HDBaseT transmitter supplied. For an automatic detection, make sure the respective signal is enabled.

HDBaseT Mode

Select the HDBaseT mode.

- **Auto:** The projector will automatically detect the signal from HDBaseT transmitter supplied.
- **HDBaseT:** The projector will activate Direct Power mode.

Note: When HDBaseT control is “ON”, 12V trigger output signal will always be “ON”, even if the projector is on Standby mode.

USING THE PROJECTOR

Setup options menu

Language

Select the multilingual OSD menu between English, German, French, Italian, Spanish, Portuguese, Polish, Dutch, Swedish, Norwegian/Danish, Finnish, Greek, traditional Chinese, simplified Chinese, Japanese, Korean, Russian, Hungarian, Czechoslovak, Arabic, Thai, Turkish, Farsi, Vietnamese, Indonesian, Romanian, and Slovenian.

Closed Captioning

Closed Captioning is a text version of the program sound or other information displayed on the screen. If the input signal contains closed captions, you can turn on the feature and watch the channels. The available options include "Off", "CC1", and "CC2".

Menu Settings

Set the menu location on the screen and configure menu timer settings.

- **Menu Location:** Select the menu location on the display screen.
- **Menu Timer:** Set the duration where the OSD menu stays visible on the screen.

Auto Source

Choose this option to let the projector automatically find an available input source.

Input Source

Select the input source between HDMI1/MHL, HDMI2, HDBaseT, VGA, VGA 1, VGA 2, S-Video and Video.

Note:

- *HDBaseT, VGA 1, VGA 2, and S-Video options are only applicable for HDBaseT model.*
- *VGA option is only applicable for non-HDBaseT model.*

Input Name

Use to rename the input function for easier identification. The available options include HDMI1/MHL, HDMI2, HDBaseT, VGA, VGA 1, VGA 2, S-Video, and Video.

Note:

- *HDBaseT, VGA 1, VGA 2, and S-Video options are only applicable for HDBaseT model.*
- *VGA option is only applicable for non-HDBaseT model.*

High Altitude

When "On" is selected, the fans will spin faster. This feature is useful in high altitude areas where the air is thin.

Display Mode Lock

Choose "On" or "Off" to lock or unlock adjusting display mode settings.

Keypad Lock

When the keypad lock function is "On", the Keypad will be locked. However, the projector can be operated by the remote control. By selecting "Off", you will be able to reuse the Keypad.

Information Hide

Enable this function to hide the information message.

- **Off:** Choose "Off" to show the "searching" message.
- **On:** Choose "On" to hide the info message.

USING THE PROJECTOR

Logo

Use this function to set the desired startup screen. If changes are made, they will take effect the next time the projector is powered on.

- **Default:** The default startup screen.
- **Neutral:** Logo is not displayed on startup screen.
- **User:** Use the stored picture as the startup screen.

Background Color

Use this function to display a blue, red, green, gray color, none, or logo screen when no signal is available.

Note: *If the background color is set to "None", then the background color is black.*

Setup reset OSD menu

Reset OSD

Return the factory default settings for OSD menu settings.

Reset to Default

Return the factory default settings for all settings.

Network menu

Network LAN menu

Network Status

Display the network connection status (read-only).

MAC Address

Display the MAC address (read-only).

DHCP

Use this option to enable or disable the DHCP function.

- **Off:** To assign IP, subnet mask, gateway, and DNS configuration manually.
- **On:** Projector will obtain an IP address automatically from your network.

Note: *Exiting OSD will automatically apply the entered values.*

IP Address

Display the IP address.

Subnet Mask

Display subnet mask number.

Gateway

Display the default gateway of the network connected to the projector.

DNS

Display the DNS number.

USING THE PROJECTOR

How to use web browser to control your projector

1. Turn “On” the DHCP option on projector to allow a DHCP server to automatically assign an IP address.
2. Open the web browser in your PC and type in the projector’s IP address (“Network > LAN > IP Address”).
3. Enter the user name and password, and click “Login”.
The projector’s configuration web interface opens.

Note:

- The default user name and password is “admin”.
- The steps in this section is based on Windows 7 operating system.

Making a direct connection from your computer to the projector*

1. Turn “Off” the DHCP option on the projector.
2. Configure the IP address, Subnet Mask, Gateway, and DNS on projector (“Network > LAN”).
3. Open **Network and Sharing Center** page on your PC, and assign the identical network parameters to your PC as set on projector. Click “OK” to save the parameters.

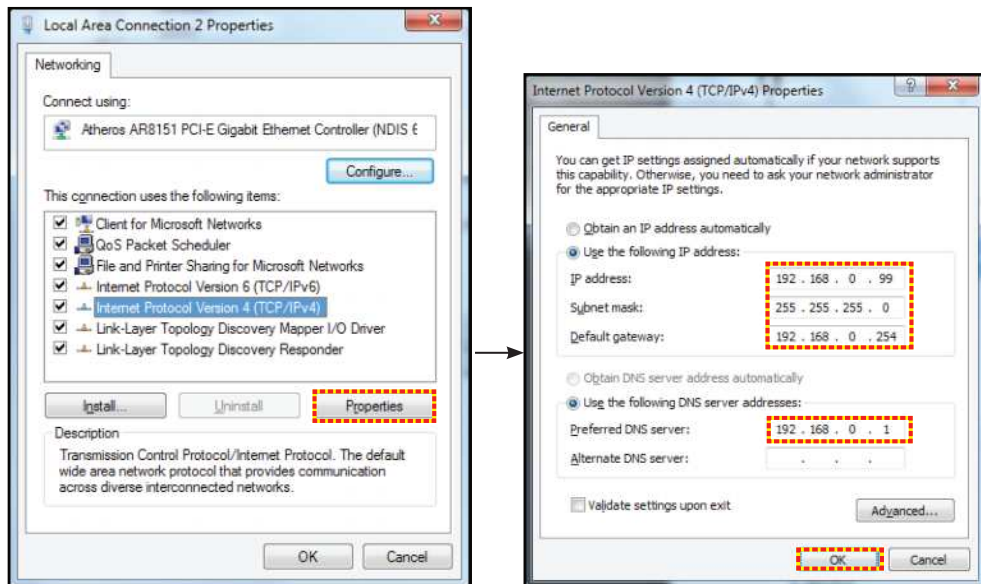

4. Open the web browser on your PC and type in to the URL field the IP address, assigned in step 3. Then press “Enter” key.

Reset

Reset all values for LAN parameters.

Network control menu

Crestron

Use this function to select the network function (port: 41794).

For more information, please visit <http://www.crestron.com> and www.crestron.com/getroomview.

Extron

Use this function to select the network function (port: 2023).

PJ Link

Use this function to select the network function (port: 4352).

AMX Device Discovery

Use this function to select the network function (port: 9131).

USING THE PROJECTOR

Telnet

Use this function to select the network function (port: 23).

HTTP

Use this function to select the network function (port: 80).

Setup network control settings menu

LAN_RJ45 function

For simplicity and ease of operation, the projector provides diverse networking and remote management features. The LAN / RJ45 function of the projector through a network, such as remotely manage: Power On / Off, brightness, and contrast settings. Also, you can view the projector status information, such as: Video- Source, Sound-Mute, etc.

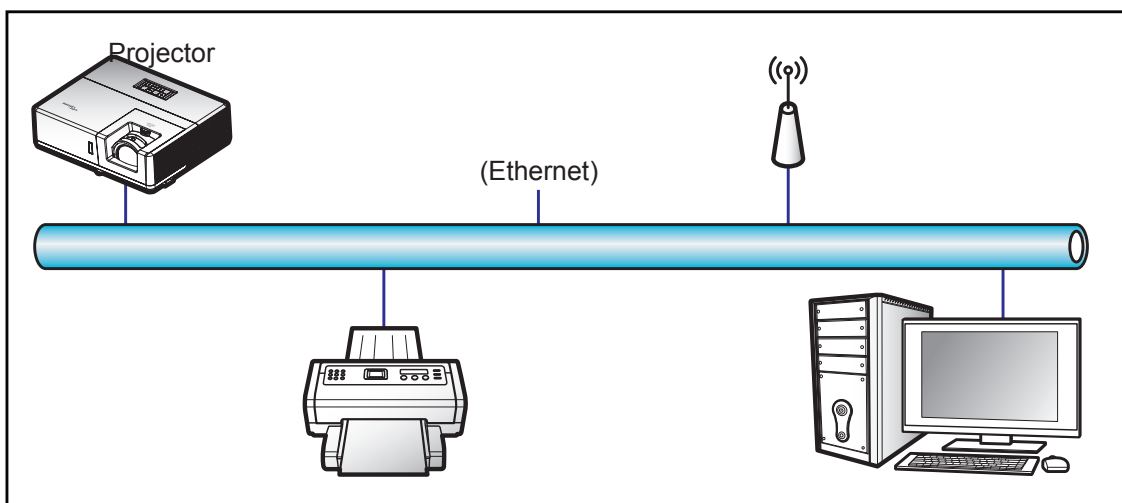

Wired LAN terminal functionalities

This projector can be controlled by using a PC (laptop) or other external device via LAN / RJ45 port and compatible with Crestron / Extron / AMX (Device -Discovery) / PJLink.

- Crestron is a registered trademark of Crestron Electronics, Inc. of the United States.
- Extron is a registered trademark of Extron Electronics, Inc. of the United States.
- AMX is a registered trademark of AMX LLC of the United States.
- PJLink applied for trademark and logo registration in Japan, the United States of America, and other countries by JBMIA.

The projector is supported by the specified commands of the Crestron Electronics controller and related software, for example RoomView®.

<http://www.crestron.com/>

This projector is compliant to support Extron device(s) for reference.

<http://www.extron.com/>

This projector is supported by AMX (Device Discovery).

<http://www.amx.com/>

This projector supports all commands of PJLink Class1 (Version 1.00).

<http://pjlink.jbmia.or.jp/english/>

For more detailed information about the various types of external devices which can be connected to the LAN / RJ45 port and remote control the projector, as well as the supported commands for these external devices, please contact the Support-Service directly.

USING THE PROJECTOR

LAN RJ45

1. Connect an RJ45 cable to RJ45 ports on the projector and the PC (laptop).

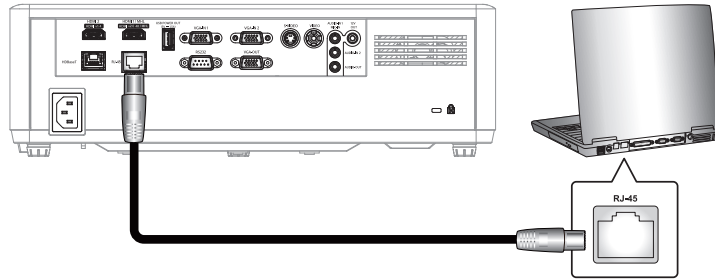

2. On the PC (Laptop), select **Start > Control Panel > Network Connections**.



3. Right-click on the **Local Area Connection**, and select **Property**.

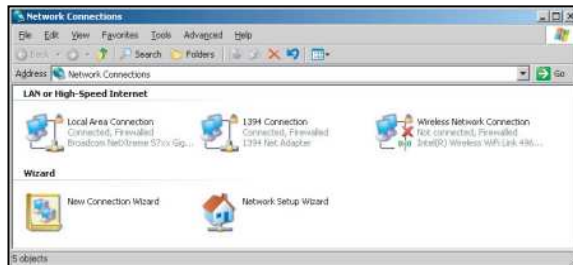

4. In the **Properties** window, select the **General** tab, and select **Internet Protocol (TCP / IP)**.

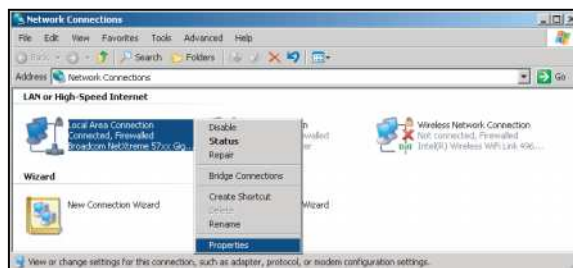

USING THE PROJECTOR

5. Click “Properties”.

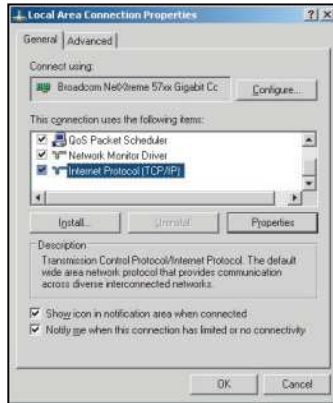

6. Type in the IP address and Subnet mask, then press “OK”.



7. Press the “Menu” button on the projector.
8. Open on projector **Network > LAN**.
9. Enter the following connection parameters:
 - DHCP: Off
 - IP Address: 192.168.0.100
 - Subnet Mask: 255.255.255.0
 - Gateway: 192.168.0.254
 - DNS: 192.168.0.51
10. Press “Enter” to confirm settings.
11. Open a web browser, for example Microsoft Internet Explorer with Adobe Flash Player 9.0 or higher installed.
12. In the Address bar, input the projector’s IP address: 192.168.0.100.



13. Press “Enter”.
The projector is setup for remote management. The LAN / RJ45 function displays as follows:

USING THE PROJECTOR

Information page

Model: Optoma | Tool | Info | Contact IT Help

Optoma

Projector Information		Projector Status	
Projector Name	Optoma	Power Status	Power On
Location		Source	HDMI
Firmware Version	B01	Display Mode	Cinema
MAC Address	00:60:E9:16:56:17	Projection	Front
Resolution	1080p 60Hz	Brightness Mode	Bright
Lamp Hours	0	Error Status	No Error
Assigned to	Optoma Projector		

exit

CRESTRON connected | Expansion Options

Main page

Model: Optoma | Tool | Info | Contact IT Help

Optoma

Power | Vol - | Mute | Vol +

Sources List

Menu | Re-Sync

Enter

AV mute | Source

Freeze | Contrast | Brightness | Sharpness

CRESTRON connected | Expansion Options

Tool page

Model: Optoma | Tool | Info | Contact IT Help

Optoma

Crestron Control	Projector	User Password
IP Address: 192.168.0.199	Projector Name: Optoma	<input type="checkbox"/> Enabled
IP ID: 7	Location:	New Password:
Part: 41794	Assigned to: Optoma Projector	Confirm:
Send	Send	Send
	DHCP: <input type="checkbox"/> Enabled	Admin Password
	IP Address: 192.168.0.100	<input type="checkbox"/> Enabled
	Subnet Mask: 255.255.255.0	New Password:
	Default Gateway: 192.168.0.254	Confirm:
	DNS Server: 192.168.0.51	Send
	Send	

exit

CRESTRON connected | Expansion Options

Contact IT helpdesk

Title

Send

USING THE PROJECTOR

RS232 by Telnet Function

There is alternative RS232 command control way, in projector so called “RS232 by TELNET” for LAN / RJ45 interface.

Quick Start-Guide for “RS232 by Telnet”

- Check and get the IP address on OSD of the projector.
- Make sure that the PC / laptop can access the web-page of the projector.
- Make sure that “Windows Firewall” setting is set disabled in case of “TELNET” function filtering out by PC / laptop.



1. Select **Start > All Programs.> Accessories > Command Prompt.**

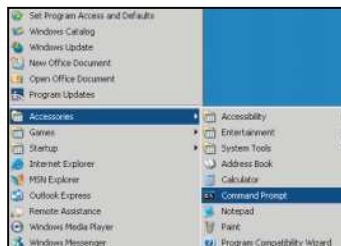

2. Input the command format as follows:
 - telnet ttt.xxx.yyy.zzz 23 (“Enter” key pressed)
 - (ttt.xxx.yyy.zzz: IP-Address of the projector)
3. If Telnet-Connection ready, and user can have RS232 command input, then “Enter” key pressed, the RS232 command will be workable.

Specification for “RS232 by TELNET”:

1. Telnet: TCP.
2. Telnet port: 23 (for more detail, kindly please get contact with the service agent or team).
3. Telnet utility: Windows “TELNET.exe” (console mode).
4. Disconnection for RS232-by-Telnet control normally: Close
5. Windows Telnet utility directly after TELNET connection ready.
 - Limitation 1 for Telnet-Control: there is less than 50 bytes for successive network payload for Telnet-Control application.
 - Limitation 2 for Telnet-Control: there is less than 26 bytes for one complete RS232 command for Telnet-Control.
 - Limitation 3 for Telnet-Control: Minimum delay for next RS232 command must be more than 200 (ms).

USING THE PROJECTOR

Info menu

Info menu

View the projector information as listed below:

- Regulatory
- Serial Number
- Source
- Resolution
- Refresh Rate
- Display Mode
- Remote Code
- Remote Code(Active)
- Power Mode (Standby)
- Light Source Hours
- Network Status
- IP Address
- Projector ID
- Brightness Mode
- FW Version

MAINTENANCE

Installing and cleaning the dust filter

Installing the dust filter

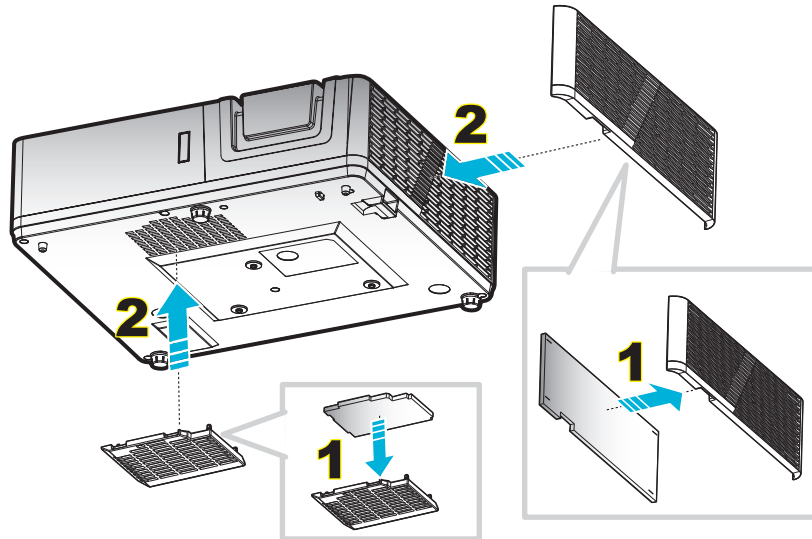

Note: Dust filters are only required/supplied in the selected regions with excessive dust.

Cleaning the dust filter

We recommend you to clean the dust filter every three months. Clean it more often if the projector is used in a dusty environment.

Procedure:

1. Switch off the power to the projector by pressing the "⏻" button on the projector keypad or the "ⓘ" button on the remote control.
2. Disconnect the power cord.
3. Pull the dust filter compartment downwards to remove it out from the bottom of the projector. **1**
4. Carefully remove the air filter. Then clean or replace the dust filter. **2**
5. To install the dust filter, reverse the previous steps.

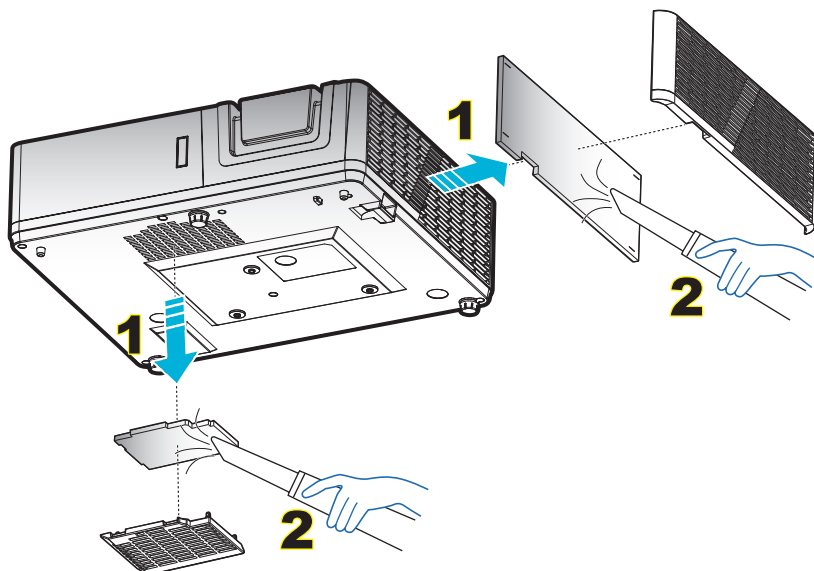

ADDITIONAL INFORMATION

Compatible resolutions

Digital (HDMI 1.4)

Native resolution: 1920 x 1080 @ 60Hz (ZH606TST); 1920 x 1200 @ 60Hz (ZU606TST)

B0 / Established Timing	B0 / Standard Timing	B0 / Detail Timing:	B1 / Video Mode	B1 / Detail Timing:
720 x 400 @ 70Hz	1080P/WUXGA:	Native timing: 1080P:	640 x 480p @ 60Hz 4:3	1366 x 768 @ 60Hz
640 x 480 @ 60Hz	1280 x 720 @ 60Hz	1920 x 1080 @ 60Hz	720 x 480p @ 60Hz 4:3	1920 x 1080p @ 60Hz
640 x 480 @ 67Hz	1280 x 800 @ 60Hz	Native timing: WUXGA:	1280 x 720p @ 60Hz 16:9	1920 x 1080 @ 120Hz
640 x 480 @ 72Hz	1280 x 1024 @ 60Hz	1920 x 1200 @ 60Hz	1920 x 1080i @ 60Hz 16:9	1920 x 1200 @ 60Hz (RB) (ZH606TST)
640 x 480 @ 75Hz	1024 x 768 @ 120Hz		720 x 480i @ 60Hz 16:9	
800 x 600 @ 56Hz	640 x 480 @ 120Hz		1920 x 1080p @ 60Hz 16:9	
800 x 600 @ 60Hz	800 x 600 @ 120Hz		720 x 576p @ 50Hz 4:3	
800 x 600 @ 72Hz	1280 x 800 @ 120Hz		1280 x 720p @ 50Hz 16:9	
800 x 600 @ 75Hz			1920 x 1080i @ 50Hz 16:9	
832 x 624 @ 75Hz			720 x 576i @ 50Hz 16:9	
1024 x 768 @ 60Hz			1920 x 1080p @ 50Hz 16:9	
1024 x 768 @ 70Hz			1920 x 1080p @ 24Hz 16:9	
1024 x 768 @ 75Hz			720 x 480p @ 60Hz 16:9	
1280 x 1024 @ 75Hz			720 x 576p @ 50Hz 16:9	
1152 x 870 @ 75Hz			3840 x 2160 @ 24Hz	
			3840 x 2160 @ 25Hz	
			3840 x 2160 @ 30Hz	
			4096 x 2160 @ 24Hz	

Digital (HDMI 2.0)

Native resolution: 1920 x 1080 @ 60Hz (ZH606TST); 1920 x 1200 @ 60Hz (ZU606TST)

B0 / Established Timing	B0 / Standard Timing	B0 / Detail Timing:	B1 / Video Mode	B1 / Detail Timing:
720 x 400 @ 70Hz	800 x 600 @ 120Hz	Native timing: 1080P:	640 x 480p @ 60Hz 4:3	1366 x 768 @ 60Hz
640 x 480 @ 60Hz	1024 x 768 @ 120Hz	1920 x 1080 @ 60Hz	720 x 480i @ 60Hz 16:9	1920 x 1080 @ 120Hz
640 x 480 @ 67Hz	1280 x 800 @ 60Hz	Native timing: WUXGA:	720 x 480p @ 60Hz 4:3	
640 x 480 @ 72Hz	1280 x 1024 @ 60Hz	1920 x 1200 @ 60Hz	720 x 480p @ 60Hz 16:9	
640 x 480 @ 75Hz	1280 x 720 @ 60Hz		720 x 576i @ 50Hz 16:9	
800 x 600 @ 56Hz	640 x 480 @ 120Hz		720 x 576p @ 50Hz 4:3	
800 x 600 @ 60Hz	1280 x 800 @ 120Hz		720 x 576p @ 50Hz 16:9	
800 x 600 @ 72Hz			1280 x 720p @ 60Hz 16:9	
800 x 600 @ 75Hz			1280 x 720p @ 50Hz 16:9	
832 x 624 @ 75Hz			1920 x 1080i @ 60Hz 16:9	
1024 x 768 @ 60Hz			1920 x 1080i @ 50Hz 16:9	
1024 x 768 @ 70Hz			1920 x 1080p @ 60Hz 16:9	
1024 x 768 @ 75Hz			1920 x 1080p @ 50Hz 16:9	
1280 x 1024 @ 75Hz			1920 x 1080p @ 24Hz 16:9	
1152 x 870 @ 75Hz			3840 x 2160 @ 24Hz 16:9	
			3840 x 2160 @ 25Hz 16:9	
			3840 x 2160 @ 30Hz 16:9	
			4096 x 2160 @ 24Hz 256:135	

B0 / Established Timing	B0 / Standard Timing	B0 / Detail Timing:	B1 / Video Mode	B1 / Detail Timing:
			3840 x 2160 @ 50Hz 16:9	
			3840 x 2160 @ 60Hz 16:9	
			4096 x 2160 @ 50Hz 256:135	
			4096 x 2160 @ 60Hz 256:135	
			4096 x 2160 @ 25Hz 256:135	
			4096 x 2160 @ 30Hz 256:135	

Analog

Native resolution: 1920 x 1080 @ 60Hz (ZH606TST); 1920 x 1200 @ 60Hz (ZU606TST)

B0 / Established Timing	B0 / Standard Timing	B0 / Detail Timing	B1 / Detail Timing
720 x 400 @ 70Hz	1080P/WUXGA:	Native timing: 1080P:	1366 x 768 @ 60Hz
640 x 480 @ 60Hz	1280 x 720 @ 60Hz	1920 x 1080 @ 60Hz	1280 x 800 @ 120Hz (RB)
640 x 480 @ 67Hz	1280 x 800 @ 60Hz	Native timing: WUXGA:	1920 x 1200 @ 60Hz (RB) (ZH606TST)
640 x 480 @ 72Hz	1280 x 1024 @ 60Hz	1920 x 1200 @ 60Hz	
640 x 480 @ 75Hz	1024 x 768 @ 120Hz		
800 x 600 @ 56Hz	640 x 480 @ 120Hz		
800 x 600 @ 60Hz	800 x 600 @ 120Hz		
800 x 600 @ 72Hz			
800 x 600 @ 75Hz			
832 x 624 @ 75Hz			
1024 x 768 @ 60Hz			
1024 x 768 @ 70Hz			
1024 x 768 @ 75Hz			
1280 x 1024 @ 75Hz			
1152 x 870 @ 75Hz			

True 3D video compatibility

Input resolutions	HDMI 1.4a 3D Input	Input timing			
			1280 x 720P @ 50Hz	Top-and-Bottom	
			1280 x 720P @ 60Hz	Top-and-Bottom	
			1280 x 720P @ 50Hz	Frame packing	
			1280 x 720P @ 60Hz	Frame packing	
			1920 x 1080i @ 50Hz	Side-by-Side(Half)	
			1920 x 1080i @ 60Hz	Side-by-Side(Half)	
			1920 x 1080P @ 24Hz	Top-and-Bottom	
		1920 x 1080P @ 24Hz	Frame packing		
		1920 x 1080i @ 50Hz	Side-by-Side(Half)	SBS mode is on	
		1920 x 1080i @ 60Hz			
		1280 x 720P @ 50Hz			
		1280 x 720P @ 60Hz	Top-and-Bottom	TAB mode is on	
		1920 x 1080i @ 50Hz			
		1920 x 1080i @ 60Hz			
		1280 x 720P @ 50Hz			
	1280 x 720P @ 60Hz				
	480i	HQFS	3D format is Frame sequential		

ADDITIONAL INFORMATION

Note:

- *If 3D input is 1080p@24Hz, the DMD should replay with integral multiple with 3D mode.*
- *Support NVIDIA 3DTV Play if there is no patent fee from Optoma.*
- *1080i@25Hz and 720p@50Hz will run in 100Hz, other 3D timing will run in 120Hz, and 1080P@24Hz will run in 144Hz.*

ADDITIONAL INFORMATION

Image size and projection distance

1080p

Desired Image Size						Projection Distance (C)	
Diagonal		Width		Height		Wide	
m	inch	m	inch	m	inch	m	feet
0.91	36	0.80	31.38	0.45	17.65	0.6	2.07
1.02	40	0.89	34.86	0.50	19.61	0.7	2.30
1.27	50	1.11	43.58	0.62	24.51	0.9	2.87
1.52	60	1.33	52.29	0.75	29.42	1.0	3.44
1.78	70	1.55	61.01	0.87	34.32	1.2	4.02
2.03	80	1.77	69.73	1.00	39.22	1.4	4.59
2.29	90	1.99	78.44	1.12	44.12	1.6	5.16
2.54	100	2.21	87.16	1.25	49.03	1.7	5.74
3.05	120	2.66	104.59	1.49	58.83	2.1	6.89
3.81	150	3.32	130.74	1.87	73.54	2.6	8.61
4.57	180	3.98	156.88	2.24	88.25	3.1	10.33
5.08	200	4.43	174.32	2.49	98.05	3.5	11.48
6.35	250	5.53	217.89	3.11	122.57	4.4	14.34
7.62	300	6.64	261.47	3.74	147.08	5.2	17.21

Lens Shift Range					
PJ lens Center to top of image				Image Shift Range	
Vertical + (Max) (A)	Vertical - (Min) (B)	Vertical Shift Range	Vertical range at any Horizontal position	Horizontal +	Horizontal -
cm	cm			(Right)	(Left)
56.9	47.5	9.4	N/A	0	0
63.3	52.8	10.5	N/A	0	0
79.1	66.0	13.1	N/A	0	0
94.9	79.2	15.7	N/A	0	0
110.7	92.4	18.3	N/A	0	0
126.5	105.6	20.9	N/A	0	0
142.3	118.8	23.5	N/A	0	0
158.1	132.0	26.2	N/A	0	0
189.8	158.4	31.4	N/A	0	0
237.2	198.0	39.2	N/A	0	0
284.7	237.6	47.1	N/A	0	0
316.3	264.0	52.3	N/A	0	0
395.4	330.0	65.4	N/A	0	0
474.4	396.0	78.5	N/A	0	0

WUXGA

Desired Image Size						Projection Distance (C)	
Diagonal		Width		Height		Wide	
m	inch	m	inch	m	inch	m	feet
0.91	36	0.78	30.53	0.48	19.08	0.6	2.01
1.02	40	0.86	33.92	0.54	21.20	0.7	2.23
1.27	50	1.08	42.40	0.67	26.50	0.9	2.79

ADDITIONAL INFORMATION

Desired Image Size						Projection Distance (C)	
Diagonal		Width		Height		Wide	
m	inch	m	inch	m	inch	m	feet
1.52	60	1.29	50.88	0.81	31.80	1.0	3.35
1.78	70	1.51	59.36	0.94	37.10	1.2	3.91
2.03	80	1.72	67.84	1.08	42.40	1.4	4.47
2.29	90	1.94	76.32	1.21	47.70	1.5	5.02
2.54	100	2.15	84.80	1.35	53.00	1.7	5.58
3.05	120	2.58	101.76	1.62	63.60	2.0	6.70
3.81	150	3.23	127.20	2.02	79.50	2.6	8.37
4.57	180	3.88	152.64	2.42	95.40	3.1	10.05
5.08	200	4.31	169.60	2.69	106.00	3.4	11.17
6.35	250	5.38	212.00	3.37	132.50	4.3	13.96
7.62	300	6.46	254.40	4.04	159.00	5.1	16.75

Lens Shift Range					
PJ lens Center to top of image				Image Shift Range	
Vertical + (Max) (A)	Vertical - (Min) (B)	Vertical Shift Range	Vertical range at any Horizontal position	Horizontal + (Right)	Horizontal - (Left)
cm	cm			cm	cm
58.2	48.5	9.7	N/A	0	0
64.6	53.8	10.8	N/A	0	0
80.8	67.3	13.5	N/A	0	0
96.9	80.8	16.2	N/A	0	0
113.1	94.2	18.8	N/A	0	0
129.2	107.7	21.5	N/A	0	0
145.4	121.2	24.2	N/A	0	0
161.5	134.6	26.9	N/A	0	0
193.9	161.5	32.3	N/A	0	0
242.3	201.9	40.4	N/A	0	0
290.8	242.3	48.5	N/A	0	0
323.1	269.2	53.8	N/A	0	0
403.9	336.5	67.3	N/A	0	0
484.6	403.9	80.8	N/A	0	0

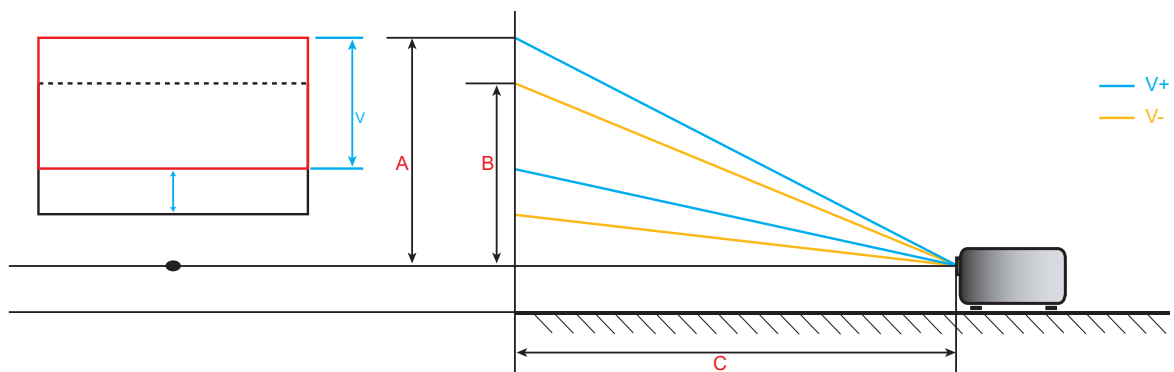

ADDITIONAL INFORMATION

Projector dimensions and ceiling mount installation

1. To prevent damage to your projector, please use the Optoma ceiling mount.
2. If you wish to use a third party ceiling mount kit, please ensure the screws used to attach a mount to the projector meet the following specifications:
 - Screw type: M4*5
 - Minimum screw length: 5mm

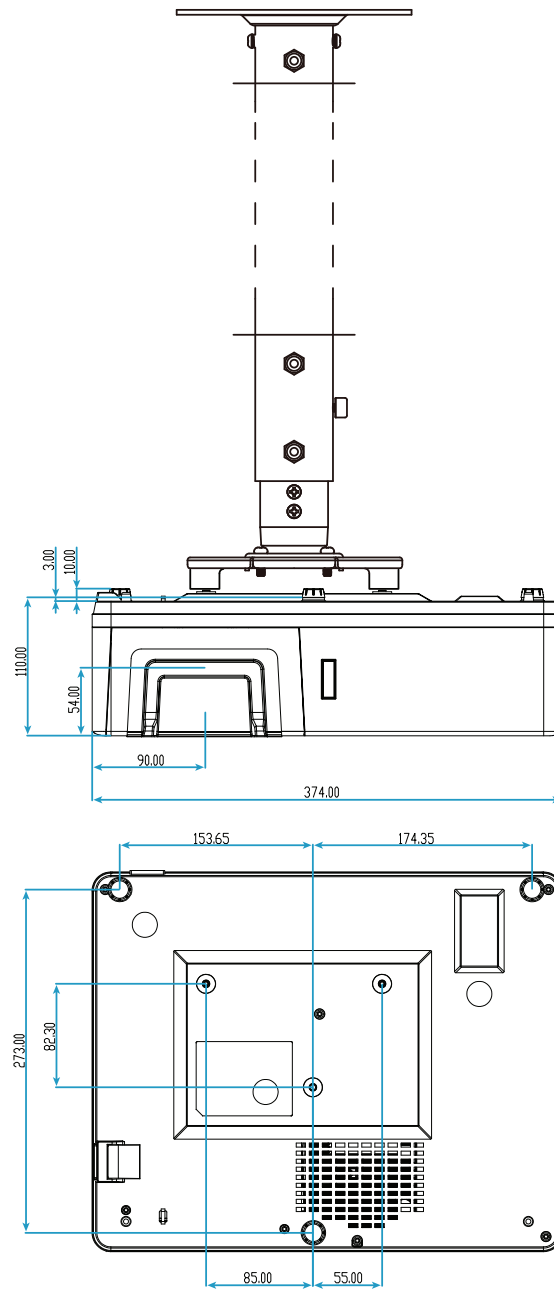

Unit: mm

Note: Please note that damage resulting from incorrect installation will void the warranty.

ADDITIONAL INFORMATION



Warning:

- If you buy a ceiling mount from another company, please be sure to use the correct screw size. Screw size will vary depending on the thickness of the mounting plate.
- Be sure to keep at least 10 cm gap between the ceiling and the bottom of the projector.
- Avoid installing the projector near a heat source.

IR remote codes



Key	Printing-key definition	Key code				Repeat
		BYTE1	BYTE2	BYTE3	BYTE4	
		customer 0	customer 1	data 0	data 1	
Power On (⏻)	On	32	CD	02	#BYTE3	F2
Power Off (⏻)	Off	32	CD	2E	#BYTE3	F2
Geometric Correction	Geometric Correction	32	CD	96	#BYTE3	F2
PIP/PBP	PIP/PBP	32	CD	78	#BYTE3	F2
F1	F1	32	CD	26	#BYTE3	F2
F2	F2	32	CD	27	#BYTE3	F2
Mode	Mode	32	CD	95	#BYTE3	F2

ADDITIONAL INFORMATION







Key	Printing-key definition	Key code				Repeat
		BYTE1	BYTE2	BYTE3	BYTE4	
		customer 0	customer 1	data 0	data 1	
Four directional select keys (↑/↓/←/→)	Up arrow	32	CD	C6	#BYTE3	F2
	Down arrow	32	CD	C7	#BYTE3	F2
	Left arrow	32	CD	C8	#BYTE3	F2
	Right arrow	32	CD	C9	#BYTE3	F2
Enter	Enter	32	CD	C5	#BYTE3	F2
AV Mute	AV Mute	32	CD	03	#BYTE3	F2
Information	Info.	32	CD	25	#BYTE3	F2
Laser ✱	Laser	N/A	N/A	N/A	N/A	N/A
Source	Source	32	CD	18	#BYTE3	F2
F3	F3	32	CD	66	#BYTE3	F2
Re-Sync	Re-Sync	32	CD	04	#BYTE3	F2
Volume	Volume +	32	CD	09	#BYTE3	F2
	Volume -	32	CD	0C	#BYTE3	F2
D Zoom	D Zoom +	32	CD	08	#BYTE3	F2
	D Zoom -	32	CD	0B	#BYTE3	F2
Menu	Menu	32	CD	88	#BYTE3	F2
Format	Format	32	CD	15	#BYTE3	F2
Freeze	Freeze	32	CD	06	#BYTE3	F2
Remote	Remote ID	3201~ 3299		N/A		
	Remote All	32CD		N/A		
VGA / 1	1/VGA	32	CD	8E	#BYTE3	F2
S-Video / 2	2/S-Video	32	CD	1D	#BYTE3	F2
HDMI1 / 3	3/HDMI1	32	CD	16	#BYTE3	F2
HDMI2	HDMI2	32	CD	9B	#BYTE3	F2
HDBaseT / 4	4/HDBaseT	32	CD	70	#BYTE3	F2
Video / 5	5/Video	32	CD	1C	#BYTE3	F2
DVI / 6	6/DVI	32	CD	19	#BYTE3	F2
HDMI3	HDMI3	32	CD	98	#BYTE3	F2
BNC / 7	7/BNC	32	CD	1A	#BYTE3	F2
YPbPr / 8	8/YPbPr	32	CD	17	#BYTE3	F2
Display Port / 9	9/DisplayPort	32	CD	9F	#BYTE3	F2
3D / 0	0/3D	32	CD	89	#BYTE3	F2

ADDITIONAL INFORMATION

Troubleshooting

If you experience a problem with your projector, please refer to the following information. If a problem persists, please contact your local reseller or service center.

Image problems

-  *No image appears on-screen*
- Ensure all the cables and power connections are correctly and securely connected as described in the "Installation" section.
 - Ensure the pins of connectors are not crooked or broken.
 - Ensure that the "Mute" feature is not turned on.
-  *Image is out of focus*
- Turn the focus ring clockwise or counterclockwise until the image is sharp and legible. (Please see page 17).
 - Make sure the projection screen is between the required distance from the projector. (Please refer to pages 57-57).
-  *The image is stretched when displaying 16:9 DVD title*
- When you play anamorphic DVD or 16:9 DVD, the projector will show the best image in 16: 9 format on projector side.
 - If you play the LBX format DVD title, please change the format as LBX in projector OSD.
 - If you play 4:3 format DVD title, please change the format as 4:3 in projector OSD.
 - Please setup the display format as 16:9 (wide) aspect ratio type on your DVD player.
-  *Image is too small or too large*
- Move the projector closer to or further from the screen.
 - Press "Menu" on the projector panel, go to "Display → Aspect Ratio". Try the different settings.
-  *Image has slanted sides:*
- If possible, reposition the projector so that it is centered on the screen and below the bottom of the screen.
-  *Image is reversed*
- Select "Setup → Projection" from the OSD and adjust the projection direction.

ADDITIONAL INFORMATION

Other problems



The projector stops responding to all controls

- If possible, turn off the projector, then unplug the power cord and wait at least 20 seconds before reconnecting power.

Remote control problems



If the remote control does not work

- Check the operating angle of the remote control is pointed within $\pm 15^\circ$ to the IR receiver on the projector.
- Make sure there are not any obstructions between the remote control and the projector. Move to within 6 m (19.7 ft) of the projector.
- Make sure batteries are inserted correctly.
- Replace batteries if they are exhausted.

ADDITIONAL INFORMATION

Warning indicators

When the warning indicators (see below) light up or flash, the projector will automatically shutdown:

- “Lamp” LED indicator is lit red and if “Power” indicator flashes red.
- “Temp” LED indicator is lit red and if “Power” indicator flashes red. This indicates the projector has overheated. Under normal conditions, the project can be switched back on.
- “Temp” LED indicator flashes red and if “Power” indicator flashes red.

Unplug the power cord from the projector, wait for 30 seconds and try again. If the warning indicator light up or flash, please contact your nearest service center for assistance.

LED lightning messages

Message	Power LED		Temp LED	Lamp LED
	(Red)	(Blue) or (Green)	(Red)	(Red)
Standby state (Input power cord)	Steady light			
Power on (Warming)		Flashing (0.5 sec off / 0.5 sec on)		
Power on and Lamp lighting		Steady light		
Power off	Steady light			
Error (Lamp failure)	Flashing			Steady light
Error (Fan failure)	Flashing		Flashing	
Error (Over temp.)	Flashing		Steady light	

- Power off:

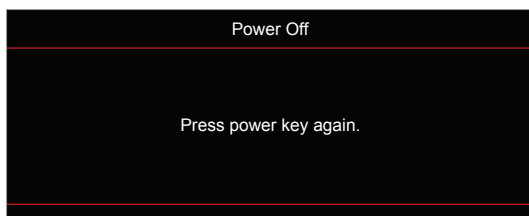

- Temperature warning:

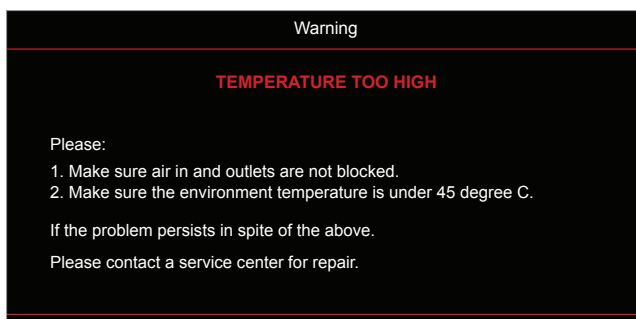

ADDITIONAL INFORMATION

Specifications

Optical	Description
Maximum resolution	WUXGA
Native resolution	<ul style="list-style-type: none"> 1080p WUXGA
Lens	Manual focus
Image size (diagonal)	<ul style="list-style-type: none"> 1080p: 28.59"~303" WUXGA: 29.38"~305.6"
Projection distance	<ul style="list-style-type: none"> 1080p: 0.5m~5.3m WUXGA: 0.5m~5.2m

Electrical	Description
Inputs	<ul style="list-style-type: none"> HDMI 1.4a HDMI 2.0b / MHL 2.2 VGA-IN 1 / VGA-IN 2 VIDEO (RCA connector (Y)) AUDIO-IN 2 3.5mm Audio-IN 1 3.5mm, with Microphone USB Type-A for power USB 5V/1.5A S-VIDEO
Outputs	<ul style="list-style-type: none"> VGA-OUT Audio-OUT 3.5mm 12V OUT Trigger
Control	<ul style="list-style-type: none"> USB Type A for mouse RS232 RJ-45 (support web control) RJ-45 for HDBaseT
Color reproduction	1073.4 Million color
Scan rate	<ul style="list-style-type: none"> Horizontal scan rate: 15.375~91.146 KHz Vertical scan rate: 24~85 Hz (120Hz for 3D feature projector)
Built-in speaker	Yes, 10W x2
Power requirement	100 - 240V ±10%, AC 50/60Hz
Input current	4.6A

Mechanical	Description
Installation orientation	Front, Rear, Ceiling, Rear-top, Portrait
Dimensions	<ul style="list-style-type: none"> 374.0mm (W) x 302mm (D) x 107mm (H) (without feet) 374.0mm (W) x 302mm (D) x 117mm (H) (with feet)
Weight	5.5 ±0.5kg
Environmental conditions	Operating in 5~40°C , 10% to 85% humidity (non-condensing)

Note: All specifications are subject to change without notice.



ADDITIONAL INFORMATION

Optoma global offices

For service or support, please contact your local office.



USA

47697 Westinghouse Drive,
Fremont, CA 94539, USA
www.optomausa.com

 888-289-6786
 510-897-8601
 services@optoma.com



Canada

47697 Westinghouse Drive,
Fremont, CA 94539, USA
www.optomausa.com

 888-289-6786
 510-897-8601
 services@optoma.com

Latin America

47697 Westinghouse Drive,
Fremont, CA 94539, USA
www.optomausa.com

 888-289-6786
 510-897-8601
 services@optoma.com



Europe

Unit 1, Network 41, Bourne End Mills
Hemel Hempstead, Herts,
HP1 2UJ, United Kingdom
www.optoma.eu
Service Tel : +44 (0)1923 691865

 +44 (0) 1923 691 800
 +44 (0) 1923 691 888
 service@tsc-europe.com



Benelux BV

Randstad 22-123
1316 BW Almere
The Netherlands
www.optoma.nl

 +31 (0) 36 820 0252
 +31 (0) 36 548 9052



France

Bâtiment E
81-83 avenue Edouard Vaillant
92100 Boulogne Billancourt, France

 +33 1 41 46 12 20
 +33 1 41 46 94 35
 savoptoma@optoma.fr



Spain

C/ José Hierro,36 Of. 1C
28522 Rivas VaciaMadrid,
Spain

 +34 91 499 06 06
 +34 91 670 08 32



Deutschland

Wiesenstrasse 21 W
D40549 Düsseldorf,
Germany

 +49 (0) 211 506 6670
 +49 (0) 211 506 66799
 info@optoma.de

Scandinavia



Lerpeveien 25
3040 Drammen
Norway

 +47 32 98 89 90
 +47 32 98 89 99
 info@optoma.no

PO.BOX 9515
3038 Drammen
Norway

Korea

WOOMI TECH.CO.,LTD.
4F, Minu Bldg.33-14, Kangnam-Ku,
Seoul,135-815, KOREA
korea.optoma.com

 +82+2+34430004
 +82+2+34430005



Japan

東京都足立区綾瀬3-25-18
株式会社オーエス
コンタクトセンター:0120-380-495

 info@os-worldwide.com
www.os-worldwide.com



Taiwan

12F., No.213, Sec. 3, Beixin Rd.,
Xindian Dist., New Taipei City 231,
Taiwan, R.O.C.
www.optoma.com.tw

 +886-2-8911-8600
 +886-2-8911-6550
 services@optoma.com.tw
asia.optoma.com



Hong Kong

Unit A, 27/F Dragon Centre,
79 Wing Hong Street,
Cheung Sha Wan,
Kowloon, Hong Kong

 +852-2396-8968
 +852-2370-1222
www.optoma.com.hk

China

5F, No. 1205, Kaixuan Rd.,
Changning District
Shanghai, 200052, China

 +86-21-62947376
 +86-21-62947375
www.optoma.com.cn



P/N:36.7FJ01G001-A